



Questo manuale d'istruzione è fornito da trovaprezzi.it. Scopri tutte le offerte per [HyperX Pulsefire Dart](#) o cerca il tuo prodotto tra le [migliori offerte di Mouse, Tastiere, altro Input](#)



Questo manuale d'istruzione è fornito da trovaprezzi.it. Scopri tutte le offerte per [HyperX Pulsefire Dart](#) o cerca il tuo prodotto tra le [migliori offerte di Mouse, Tastiere, altro Input](#)

User Manual



HyperX Pulsefire Dart™

Find the language and latest documentation for your HyperX Pulsefire Dart here.

HyperX Pulsefire Dart Installation Guide

-  For instructions in English
-  Para instrucciones en Español
-  Für Anleitungen in Deutsch
-  Pour des instructions en Français
-  Per le istruzioni in Italiano
-  Por as instruções em Português
-  Instrukcje w języku Polskim
-  Для инструкции на Русском
-  Turkce talimatlar icin
-  日本語マニュアル用
-  한국어 안내
-  คำแนะนำภาษาไทย
-  Để xem hướng dẫn bằng tiếng Việt
- Simplified Chinese 简体中文说明书
- Traditional Chinese 繁體中文說明



HyperX Pulsefire Dart[™]



Part Number

HX-MC006B

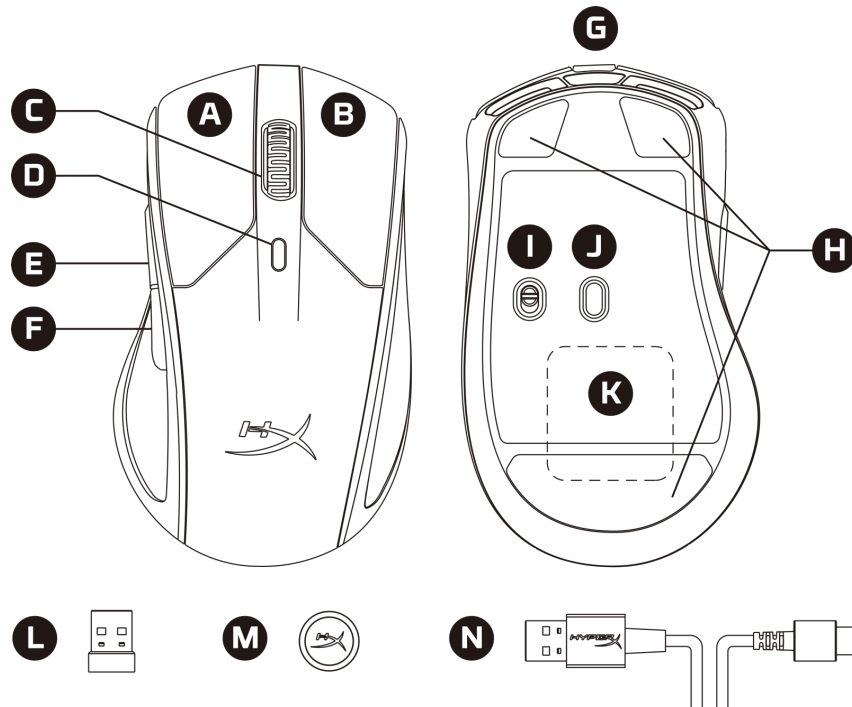

TABLE OF CONTENTS

Overview	3
Specifications	4
Installation	5
Wireless Mode	5
Wired Mode	5
Charging	6
Wireless Charging	6
Wired Charging	6
Function Keys	7
HyperX NGENUITY Software	7
Using with Console	7
Factory Reset	7



Overview



- A. Left click button
- B. Right click button
- C. Mouse wheel
- D. DPI button
- E. Forward click button
- F. Backward click button
- G. USB-C port
- H. Mouse skates
- I. Power switch
- J. Optical gaming sensor
- K. Built-in wireless charging receiver module
- L. USB receiver
- M. USB cable adapter
- N. USB-C to USB-A extension cable



Specifications

Ergonomic: Ergonomic

Sensor: Pixart PMW3389

Resolution: Up to 16000 DPI

Speed: 450ips

Acceleration: 50G

Buttons: 6

Left / Right buttons switches: Omron

Left / Right buttons durability: 50 million clicks

Light effects: Per-LED RGB lighting¹

Onboard memory: 1 profile

Connection type: 2.4GHz wireless / wired

Battery life²: 90 hours – LED off / 50 hours – Default LED lighting

Charging type: Wireless Qi charging³ / wired

Polling rate: 1000Hz

Cable type: Detachable charging/data cable

Weight (without cable): 112g

Weight (with cable): 130g

Dimensions (L x W x H): 124.8mm x 73.9mm x 43.6mm

Cable length: 1.8m

¹Per-LED RGB lighting customizable with HyperX NGENUITY Software.

²Battery life varies based on usage and computing conditions.

³Qi wireless charger sold separately.



Installation

Wireless Mode

Connect your USB receiver to USB cable adapter, and USB-C to USB-A extension cable to a PC USB port. For optimal placement, please keep the USB receiver within 20 cm of the mouse.

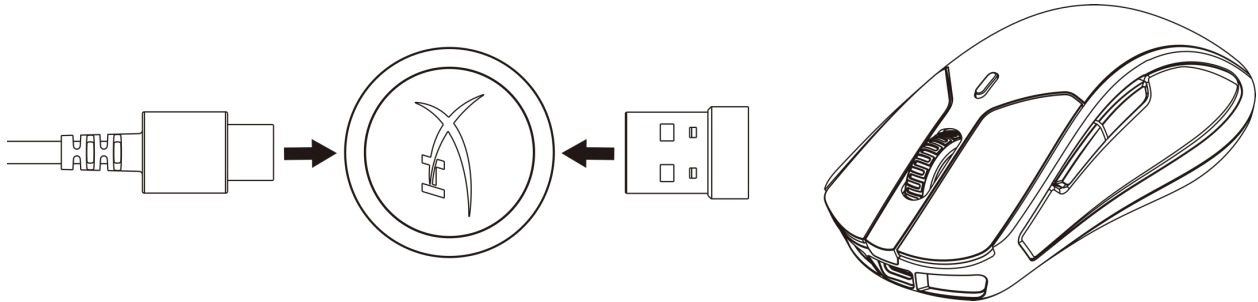

Wired Mode

Connect your USB-C to USB-A extension cable to your mouse and to a PC USB port.

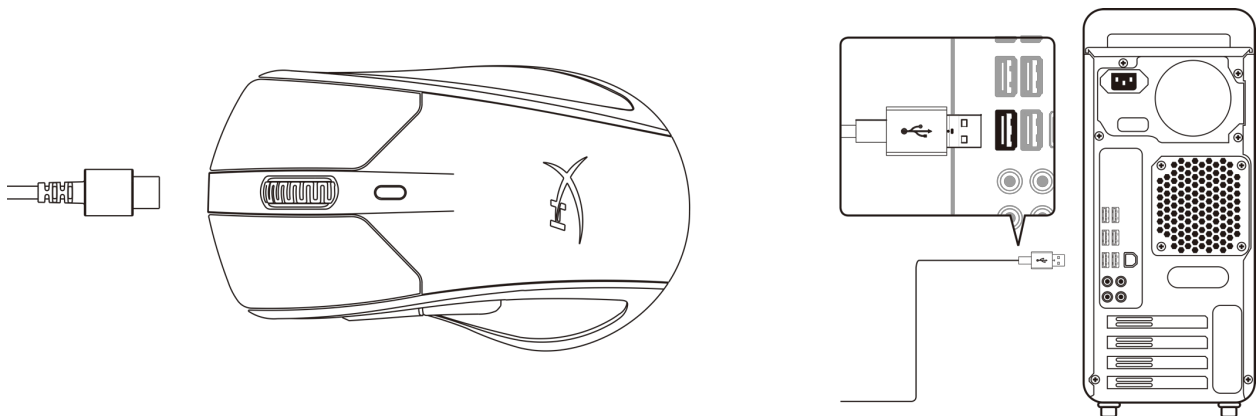



Charging

Wireless Charging

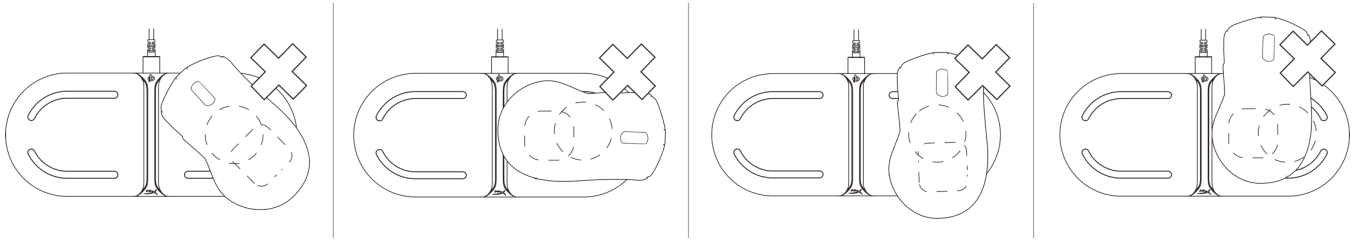
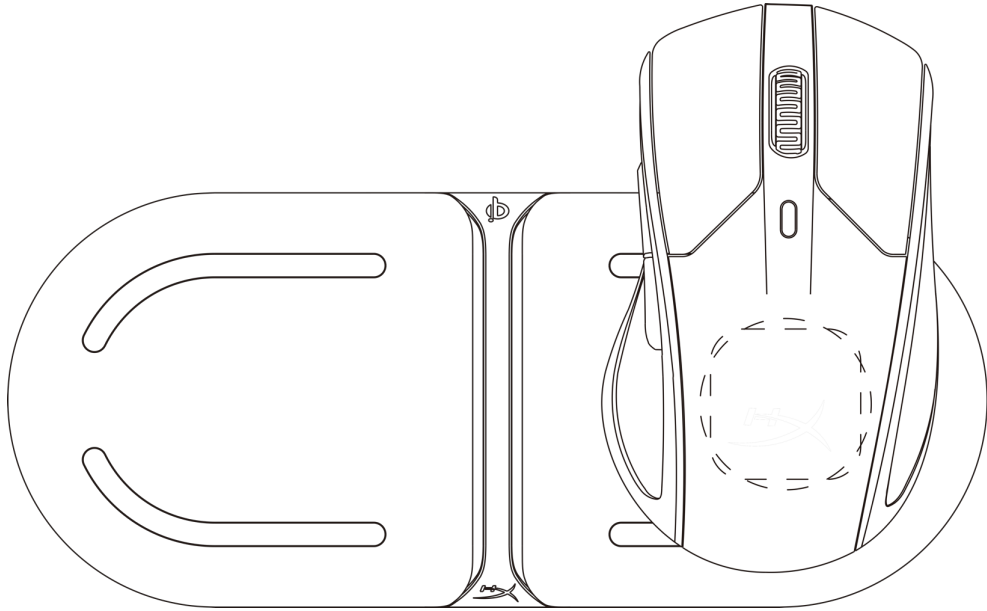

*Charging base not included

Wired Charging

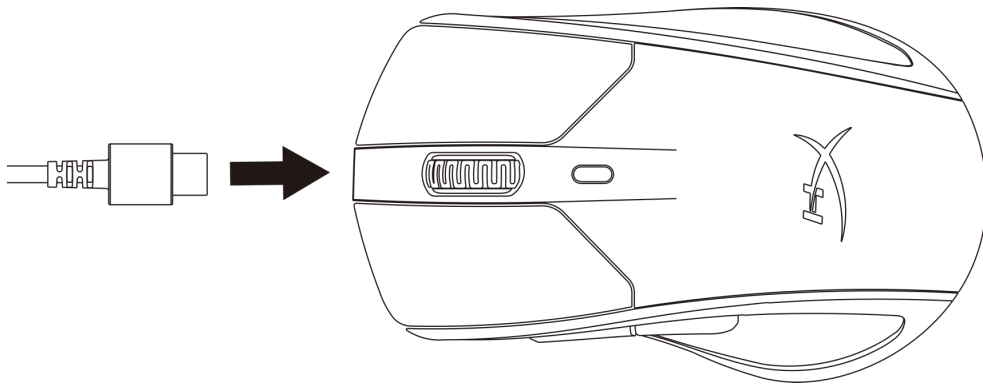



Function Keys

Function Keys	Secondary Feature
DPI button	Change between DPI presets. Default values are: <ul style="list-style-type: none">- 800 DPI (blue).- 1600 DPI (yellow).- 3200 DPI (green).

HyperX NGENUITY Software

To customize lighting, DPI, and macro settings, download the HyperX NGENUITY Software here: hyperxgaming.com/ngenuity.

Using with Console

Connect to PS4 or Xbox One using the included USB cable or dongle attachment.

Factory Reset

If you are experiencing any issue with the mouse, you can perform a factory reset. Onboard memory will be cleared, and all settings will revert back to default.

Function Keys	Secondary Feature
Hold DPI button + mouse wheel button down for 5 seconds	Perform a factory reset on the mouse.

Questions or Setup Issues?

Contact the HyperX support team at: hyperxgaming.com/support/



HyperX Pulsefire Dart[™]



Número de referencia

HX-MC006B



ÍNDICE

Visión general	3
Especificaciones	4
Instalación.....	5
Modo inalámbrico	5
Modo con cable.....	5
Carga	6
Carga inalámbrica.....	6
Carga con cable	6
Teclas de función	7
Software HyperX NGENUITY	7
Uso con consola.....	7
Restablecimiento a condiciones de fábrica	7



Visión general

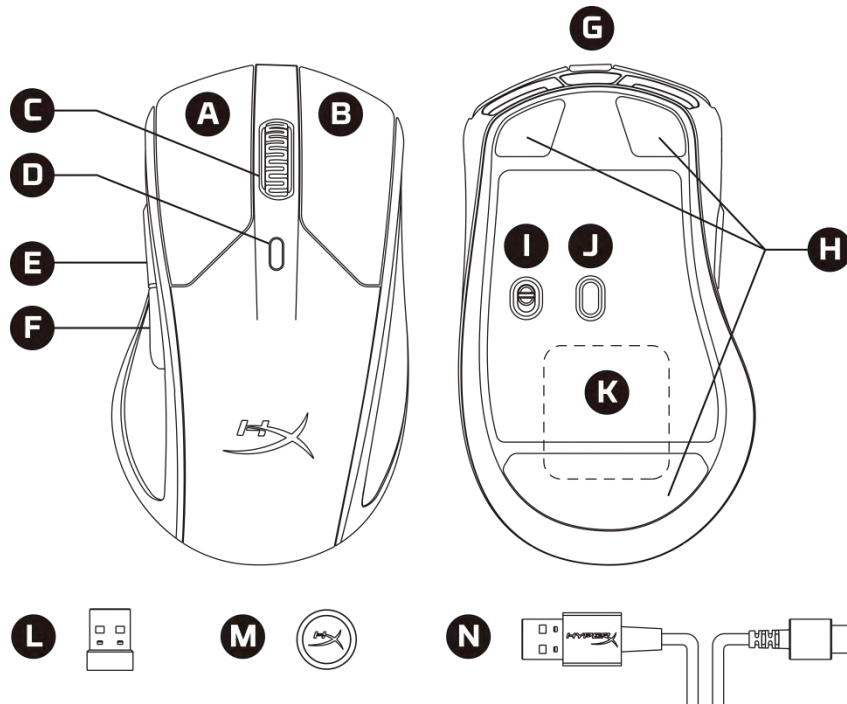

- A. Botón de clic izquierdo
- B. Botón de clic derecho
- C. Rueda del ratón
- D. Botón de PPP
- E. Botón de clic de avance
- F. Botón de clic de retroceso
- G. Puerto USB-C
- H. Partes traseras del ratón
- I. Interruptor de encendido
- J. Sensor óptico para juegos
- K. Módulo receptor de carga inalámbrica integrado
- L. Receptor USB
- M. Adaptador de cable USB
- N. Cable de extensión USB-C a USB-A



Especificaciones

Ergonómico: Ergonómico

Sensor: Pixart PMW3389

Resolución: Hasta 16 000 ppp

Velocidad: 450 ips

Aceleración: 50 G

Botones: 6

Teclas de los botones izquierdo/derecho: Omron

Durabilidad de los botones izquierdo/derecho: 50 millones de clics

Efectos de luz: Iluminación RGB por LED¹

Memoria integrada: 1 perfil

Tipo de conexión: inalámbrica de 2,4 GHz/con cable

Duración de la batería²: 90 horas – LED apagado / 50 horas – Iluminación LED predeterminada

Tipo de carga: Carga inalámbrica Qi³/con cable

Velocidad de sondeo: 1.000 Hz

Tipo de cable: Cable de datos/carga extraíble

Peso (sin cable): 112 g

Peso (con cable): 130 g

Dimensiones (L x An x Al): 124,8 mm x 73,9 mm x 43,6 mm

Longitud del cable: 1,8 m

¹Iluminación RGB por LED personalizable con el software HyperX NGENUITY.

²La duración de la batería depende del uso y de las condiciones informáticas.

³El cargador inalámbrico Qi se vende por separado.



Instalación

Modo inalámbrico

Conecta el receptor USB al adaptador de cable USB, y el cable de extensión USB-C a USB-A a un puerto USB del PC. Se recomienda colocar el receptor USB a menos de 20 cm del ratón.

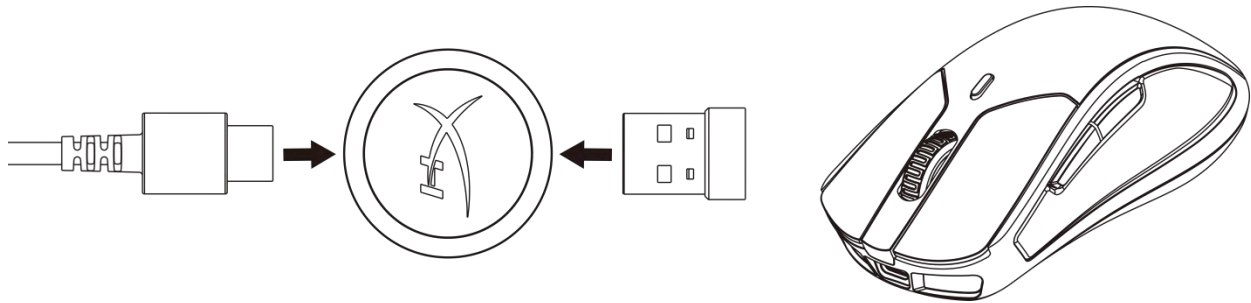

Modo con cable

Conecta el cable de extensión USB-C a USB-A al ratón y a un puerto USB del PC.

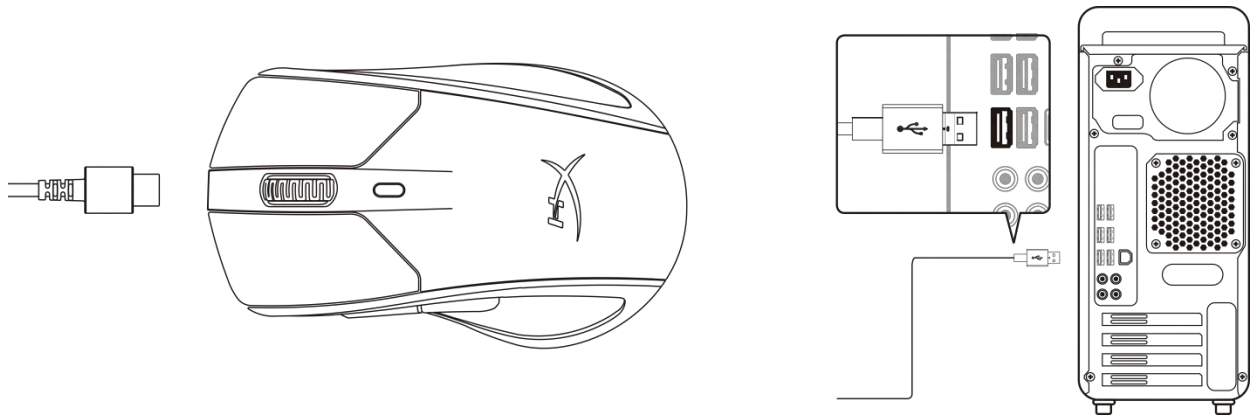



Carga

Carga inalámbrica

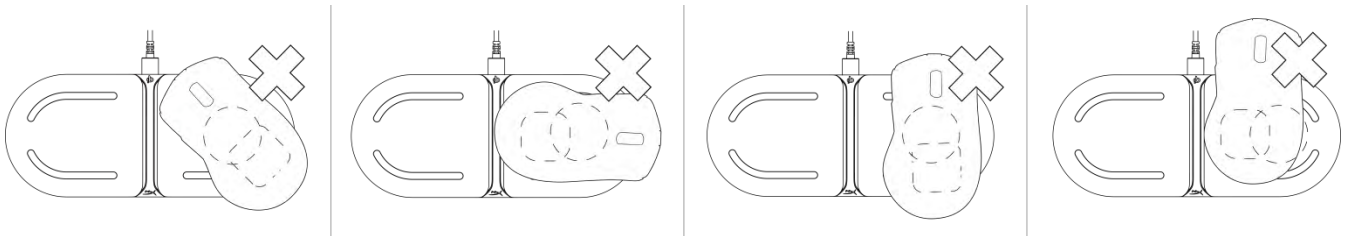
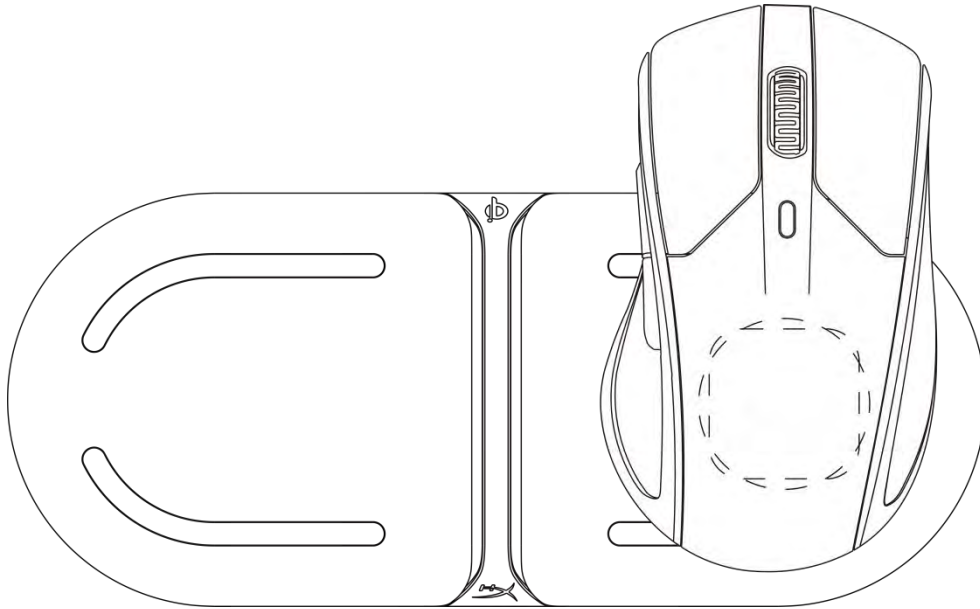

*Base de carga no incluida

Carga con cable

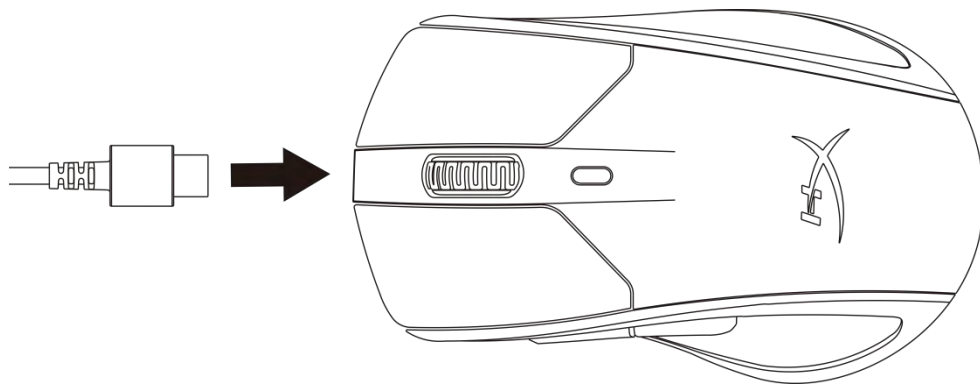



Teclas de función

Teclas de función	Función secundaria
Botón de PPP	Cambia entre los preajustes de PPP. Los valores predeterminados son: <ul style="list-style-type: none">- 800 DPI (azul).- 1600 PPP (amarillo).- 3200 PPP (verde).

Software HyperX NGENUITY

Para personalizar la iluminación, los PPP y la configuración de la macro, descarga el software HyperX NGENUITY aquí: hyperxgaming.com/ngenuity.

Uso con consola

Conéctalo a la PS4 o Xbox One con la conexión de dongle o el cable USB incluido.

Restablecimiento a condiciones de fábrica

Si tienes algún problema con el ratón, puedes restablecer la configuración de fábrica. Se borrará la memoria integrada y todos los ajustes volverán a los valores predeterminados.

Teclas de función	Función secundaria
Mantén pulsado el botón de PPP + el botón de la rueda del ratón durante 5 segundos	Realiza un restablecimiento de la configuración de fábrica del ratón.

¿Alguna pregunta o problema de configuración?

Ponte en contacto con el equipo de soporte de HyperX en: hyperxgaming.com/support/



HyperX Pulsefire Dart[™]



Artikelnummer

HX-MC006B



INHALT

Übersicht	3
Spezifikationen	4
Installation.....	5
Kabelloser Betrieb.....	5
Kabelgebundener Betrieb.....	5
Wird geladen	6
Kabelloses Laden	6
Kabelgebundenes Laden	6
Funktionstasten.....	7
HyperX NGENUITY Software	7
Nutzung mit Konsole.....	7
Zurücksetzen auf Werkseinstellungen	7



Übersicht

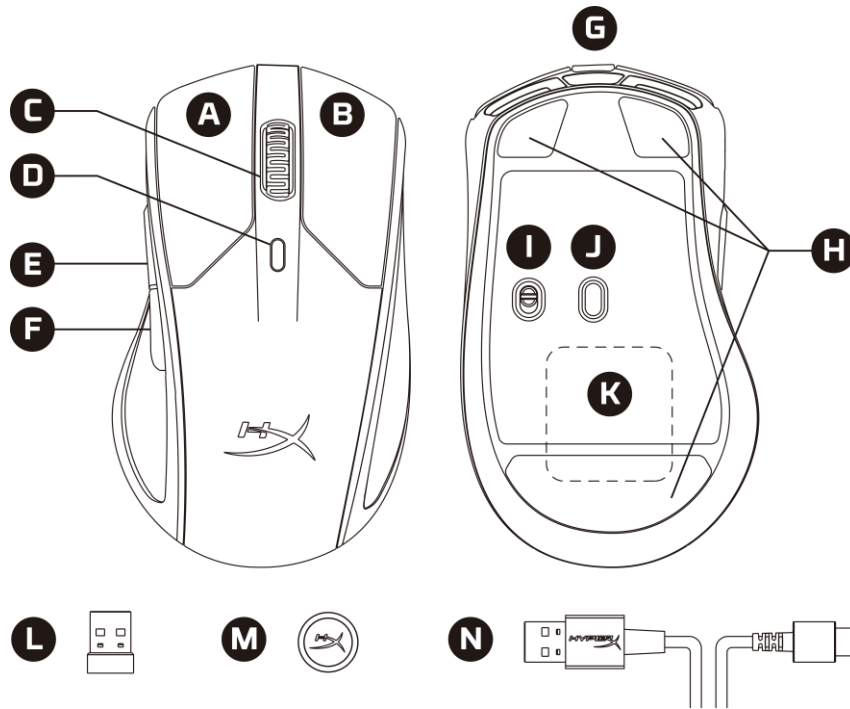

- A. Linke Maustaste
- B. Rechte Maustaste
- C. Musrad
- D. DPI-Taste
- E. Vorwärtstaste
- F. Rückwärtstaste
- G. USB-C-Anschluss
- H. Mausfüße
- I. Ein/Aus-Schalter
- J. Optischer Gaming-Sensor
- K. Integriertes kabelloses Empfänger-Lade-Modul
- L. USB-Empfänger
- M. USB-Kabeladapter
- N. USB-C-zu-USB-A-Verlängerungskabel



Spezifikationen

Ergonomie: Ergonomisch

Sensor: Pixart PMW3389

Auflösung: Bis zu 16.000 DPI

Geschwindigkeit 450ips

Beschleunigung: 50G

Tasten: 6

Links-/Rechts-Tasten mit Switches: Omron

Links-/Rechts-Tastenhaltbarkeit: 50 Millionen Klicks

Lichteffekte:RGB-Beleuchtung pro Einzel-LED¹

Interner Speicher: 1 Profil

Anschlussyp: 2,4GHz kabellos / kabelgebunden

Batterielaufzeit²: 90 Stunden – LED aus / 50 Stunden – Standard-LED-Beleuchtung

Ladetyp:Kabelloses Qi-Laden³ / kabelgebunden

Abfragerate: 1.000Hz

Kabeltyp: Abnehmbares Lade-/Datenkabel

Gewicht (ohne Kabel): 112g

Gewicht (mit Kabel): 130g

Abmessungen (L x B x H): 124,8mm x 73,9mm x 43,6mm

Kabellänge: 1,8m

¹RGB-Beleuchtung pro Einzel-LED, anpassbar mit HyperX NGENUITY Software

²Die Batterielaufzeit ist abhängig von Nutzung und Rechenbedingungen.

³Kabelloses Qi-Ladegerät ist separat erhältlich.



Installation

Kabelloser Betrieb

Verbinde den USB-Empfänger mit dem USB-Kabeladapter und das USB-C-zu-USB-A-Verlängerungskabel mit einem PC-USB-Anschluss. Optimalerweise sollte sich der USB-Empfänger in einem Radius von 20 cm von der Maus befinden.

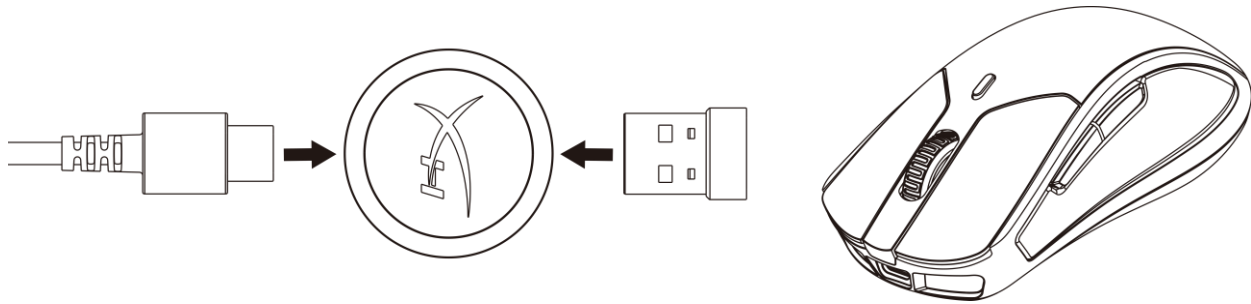

Kabelgebundener Betrieb

Verbinde das USB-C-zu-USB-A-Verlängerungskabel mit der Maus und einem PC-USB-Anschluss.

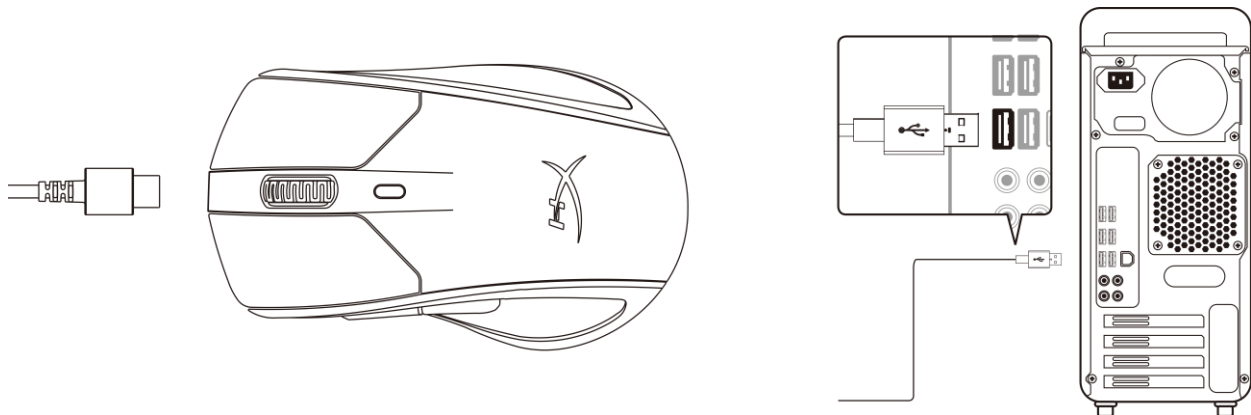



Wird geladen

Kabelloses Laden

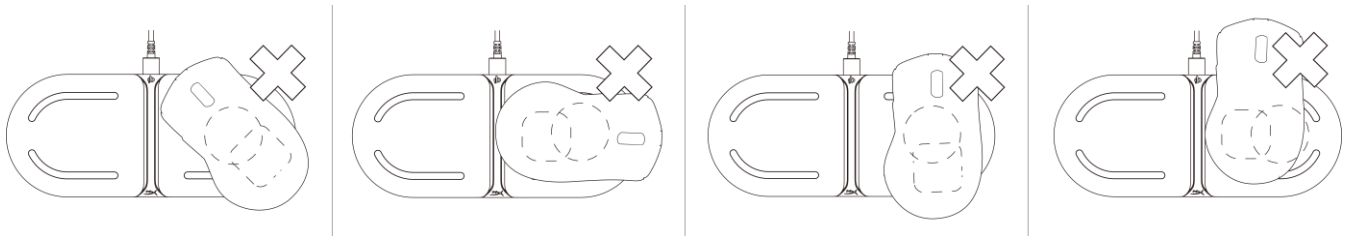
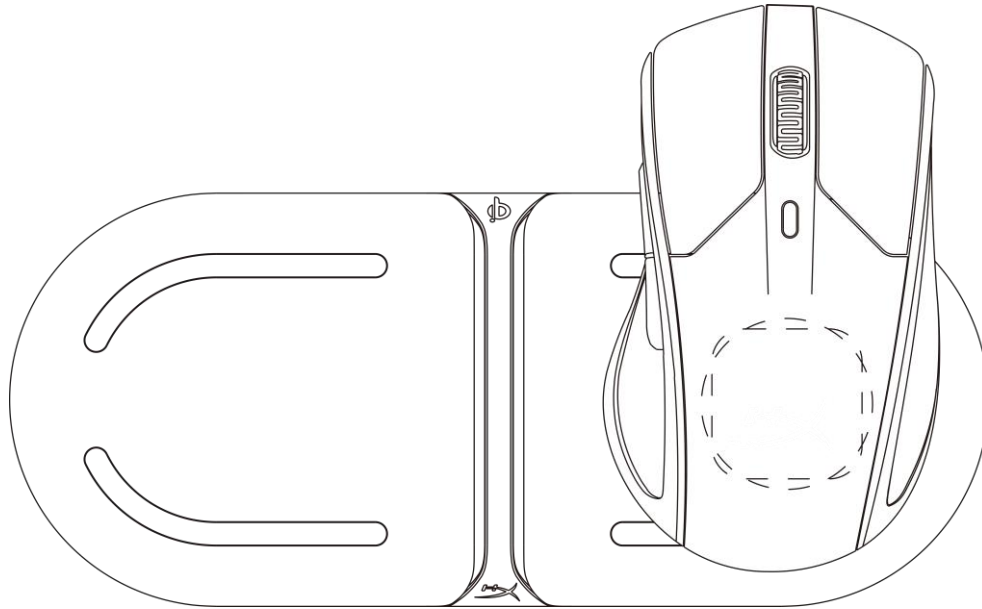

*Kabelloses Ladepad nicht im Lieferumfang enthalten

Kabelgebundenes Laden

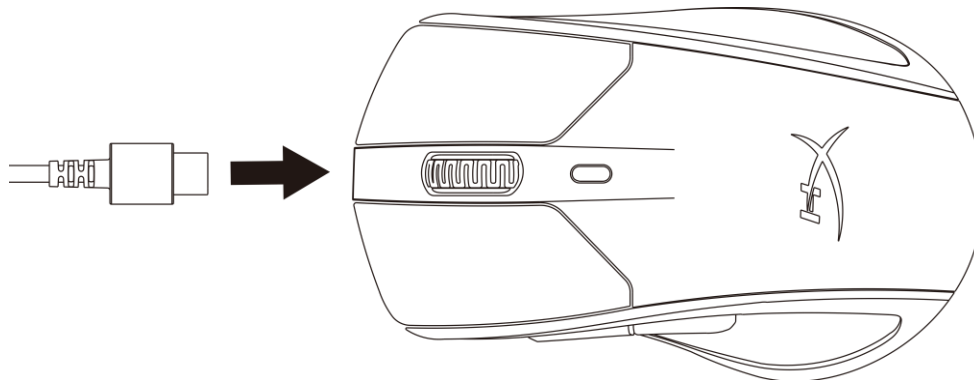



Funktionstasten

Funktionstasten	Zweitfunktion
DPI-Taste	Wechsel zwischen DPI-Voreinstellungen. Standardwerte sind: <ul style="list-style-type: none">- 800 DPI (Blau).- 1600 DPI (Gelb).- 3200 DPI (Grün).

HyperX NGENUITY Software

Um Beleuchtung, DPI und die Macro-Einstellungen anzupassen, lade hier die HyperX NGENUITY Software herunter: hyperxgaming.com/ngenuity.

Nutzung mit Konsole

Verbinde sie mit einer PS4 oder Xbox One über das im Lieferumfang enthaltene USB-Kabel oder einen Dongle.

Zurücksetzen auf Werkseinstellungen

Wenn du Probleme mit der Maus hast, kannst du sie auf die Werkeinstellungen zurücksetzen. Der interne Speicher wird gelöscht und alle Einstellungen auf den Standard zurückgesetzt.

Funktionstasten	Zweitfunktion
DPI-Taste + Mauseklick 5 Sekunden gedrückt halten	Die Maus auf die Werkseinstellungen zurücksetzen.

Fragen oder Probleme bei der Einrichtung?

Wende dich an das HyperX Support-Team unter: hyperxgaming.com/support/



HyperX Pulsefire Dart[™]



Référence produit

HX-MC006B

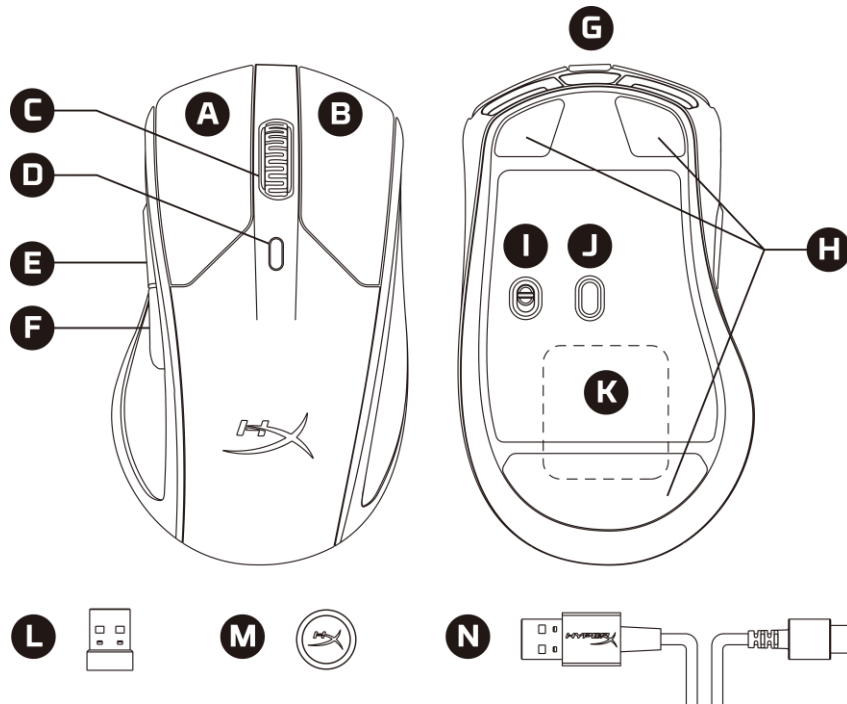

TABLE DES MATIÈRES

Présentation	3
Spécifications	4
Installation.....	5
Mode sans fil	5
Mode filaire.....	5
Chargement de la batterie.....	6
Chargement sans fil	6
Chargement filaire	6
Touches de fonction.....	7
Logiciel HyperX NGENUITY	7
Utilisation avec une Console	7
Réinitialisation d'usine.....	7



Présentation



- A. Bouton gauche
- B. Bouton droit
- C. Roulette
- D. Bouton PPP
- E. Bouton Avance
- F. Bouton Recul
- G. Port USB-C
- H. Patins de souris
- I. Commutateur d'alimentation
- J. Capteur de jeu optique
- K. Module de réception de charge sans fil intégré
- L. Récepteur USB
- M. Adaptateur pour câble USB
- N. Câble d'extension USB-C vers USB-A



Spécifications

Ergonomique : Ergonomique

Capteur : Pixart PMW3389

Résolution : 16 000PPP maximum

Vitesse : 450ips

Accélération : 50G

Boutons 6

Interrupteurs des boutons gauche/ droit : Omron

Durabilité des boutons gauche/ droit : 50 millions de clics

Effets lumineux : Effets lumineux RGB par LED personnalisables¹

Mémoire embarquée : 1 profil

Type de connexion : Sans fil 2,4GHz / filaire

Autonomie de la batterie² : 90 heures– LED éteints / 50 heures– Éclairage LED par défaut

Type de charge : Charge sans fils Qi³ / filaire

Taux de transfert : 1000Hz

Type de câble : Câble de charge/de données amovible

Poids (sans le câble) : 112g

Poids (avec le câble) : 130g

Dimensions (L x l x H) : 124,8mm x 73,9mm x 43,6mm

Longueur du câble : 1,8m

¹ Éclairage RGB par LED personnalisable avec le logiciel HyperX NGENUITY.

²L'autonomie varie selon l'utilisation et les opérations de calcul.

³Chargeur sans fil Qi vendu séparément.



Installation

Mode sans fil

Branchez le récepteur USB sur l'adaptateur de câble USB et le câble d'extension USB-C vers USB-A sur un port USB d'ordinateur. Pour bénéficier d'une précision optimale, le récepteur USB doit être à moins de 20cm de la souris.

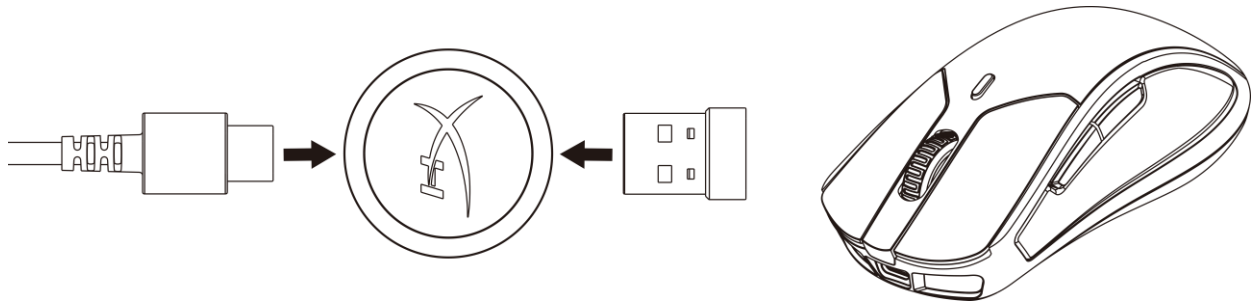

Mode filaire

Branchez le câble d'extension USB-C vers USB-A sur la souris et sur le port USB de l'ordinateur

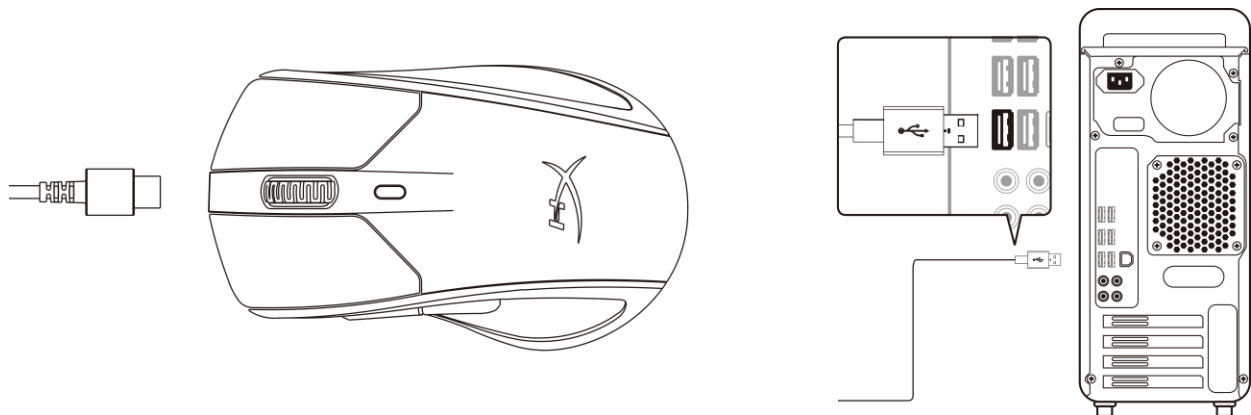



Chargement de la batterie

Chargement sans fil

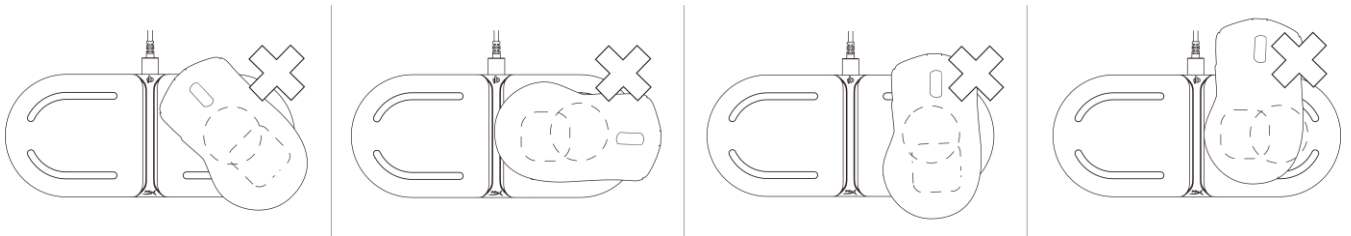
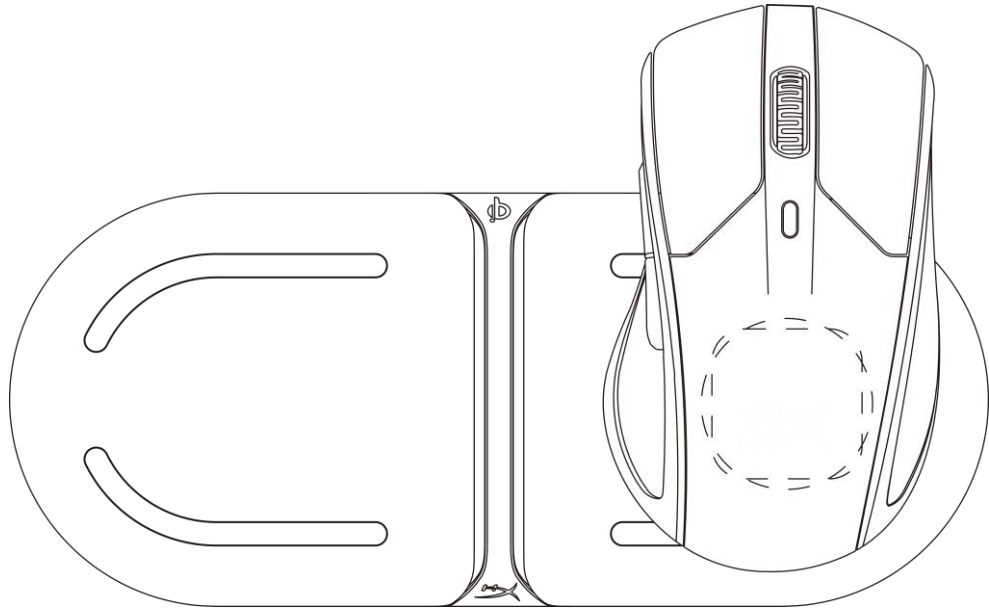

*Socle de charge non inclus

Chargement filaire

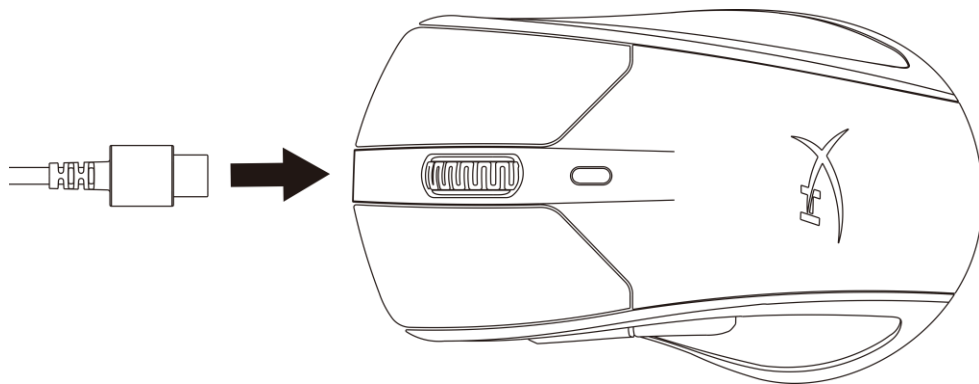



Touches de fonction

Touches de fonction	Fonction secondaire
Bouton PPP	Modification des préréglages PPP Les valeurs par défaut sont les suivantes : <ul style="list-style-type: none">- 800 PPP (bleu).- 1600 PPP (jaune).- 3200 PPP (vert).

Logiciel HyperX NGENUITY

Pour personnaliser les effets lumineux, les valeurs PPP et les macros, téléchargez le logiciel HyperX NGENUITY ici hyperxgaming.com/ngenuity.

Utilisation avec une Console

Établissez la connexion avec une PS4 ou Xbox à l'aide du câble USB ou du dongle inclus.

Réinitialisation d'usine

Si la souris pose des problèmes, vous pouvez réaliser une réinitialisation d'usine. La mémoire embarquée sera effacée et tous les paramètres reprendront leur valeur par défaut.

Touches de fonction	Fonction secondaire
Maintenez le bouton PPP + bouton de roulette pendant 5 secondes	Réalisez une réinitialisation d'usine de la souris

Questions ou problèmes de configuration ?

Contactez l'équipe d'assistance HyperX à l'adresse : hyperxgaming.com/support/



HyperX Pulsefire Dart[™]



Numero di parte

HX-MC006B



INDICE

Descrizione generale del prodotto	3
Specifiche tecniche	4
Installazione	5
Modalità wireless	5
Modalità cablata.....	5
In ricarica.....	6
Ricarica Wireless	6
Ricarica con cavo	6
Tasti funzione	7
Software HyperX NGENUITY	7
Utilizzo con console	7
Ripristino impostazioni di fabbrica	7



Descrizione generale del prodotto

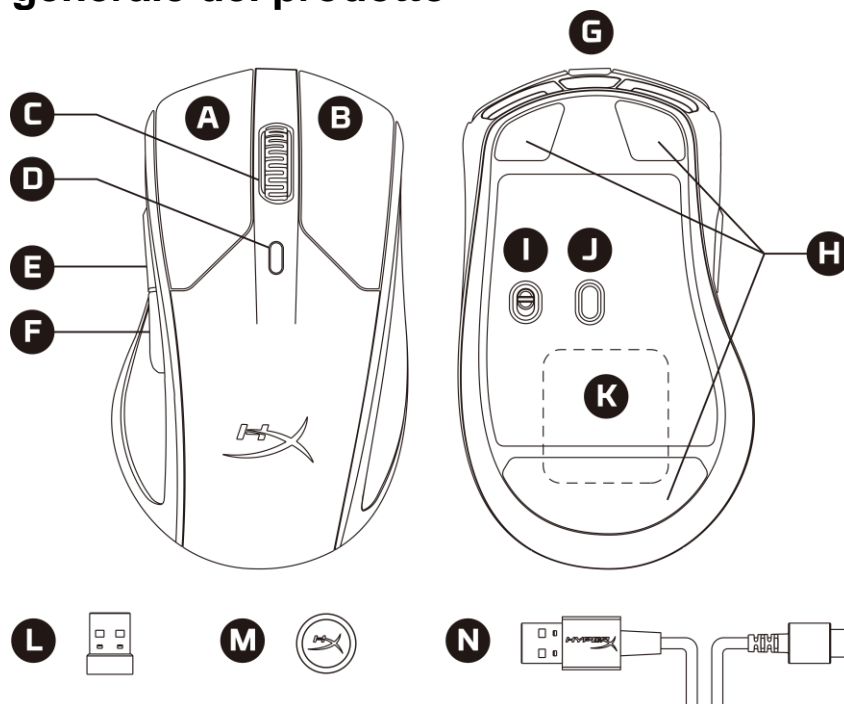

- A. Tasto clic sinistro
- B. Tasto clic destro
- C. Rotellina del mouse
- D. Pulsante DPI
- E. Tasto clic avanti
- F. Tasto clic dietro
- G. Porta USB-C
- H. Pattini del mouse
- I. Interruttore di accensione
- J. Sensore ottico per il gaming
- K. Modulo ricevitore di ricarica wireless integrato
- L. Ricevitore USB
- M. Adattatore cavo USB
- N. Prolunga con adattatore da USB-C a USB-A



Specifiche tecniche

Ergonomia: ergonomico

Sensore: Pixart PMW3389

Risoluzione: fino a 16000 DPI

Velocità: 450ips

Accelerazione: 50G

Pulsanti: 6

Switch dei pulsanti sinistro e destro: Omron

Resistenza dei pulsanti sinistro e destro: 50 milioni di clic

Effetti luminosi: illuminazione RGB configurabile a livello LED¹

Memoria integrata: 1 profilo

Tipo di connessione: cablata o wireless da 2.4 GHz

Durata batteria²: 90 ore – Illuminazione LED disattivata / 50 ore – Illuminazione LED predefinita

Tipo di ricarica: wireless Qi³ / tramite cavo

Frequenza di polling: 1.000 Hz

Tipo di cavo: cavo scollegabile per ricarica/dati

Peso (senza cavo): 112 g

Peso (con cavo): 130 g

Dimensioni (L x P x A): 124,8 mm x 73,9 mm x 43,6 mm

Lunghezza cavo: 1,8 m

¹Illuminazione RGB personalizzabile per singolo LED tramite software NGENUITY di HyperX.

²L'autonomia della batteria varia in base all'utilizzo e alle condizioni di elaborazione.

³Caricabatteria Qi wireless venduto separatamente.



Installazione

Modalità wireless

Collegare il ricevitore USB all'adattatore per cavo USB; quindi, collegare la prolunga con adattatore da USB-C a USB-A a una porta USB del PC. Per garantire un posizionamento ideale, mantenere una distanza di 20 cm tra il ricevitore USB e il mouse.

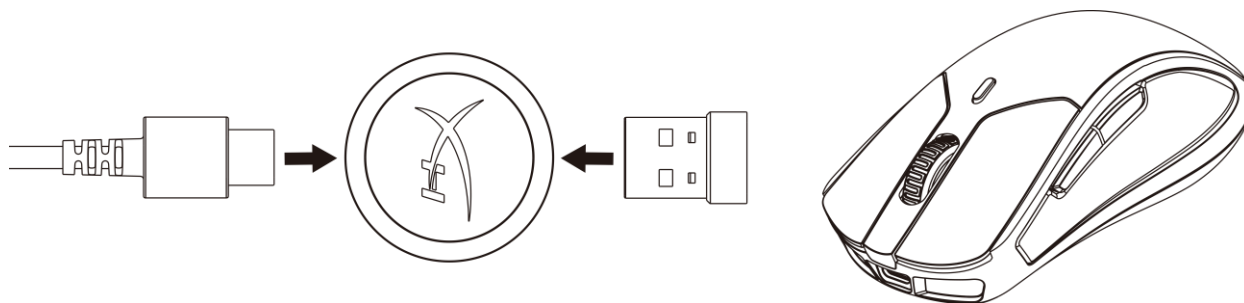

Modalità cablata

Collegare le estremità della prolunga con adattatore da USB-C a USB-A al mouse e a una porta USB del PC, rispettivamente.

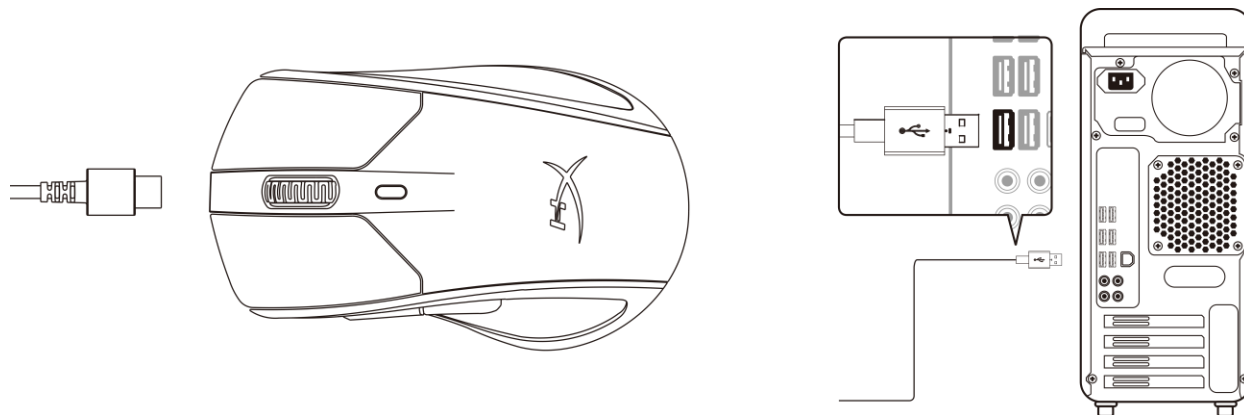



In ricarica

Ricarica Wireless

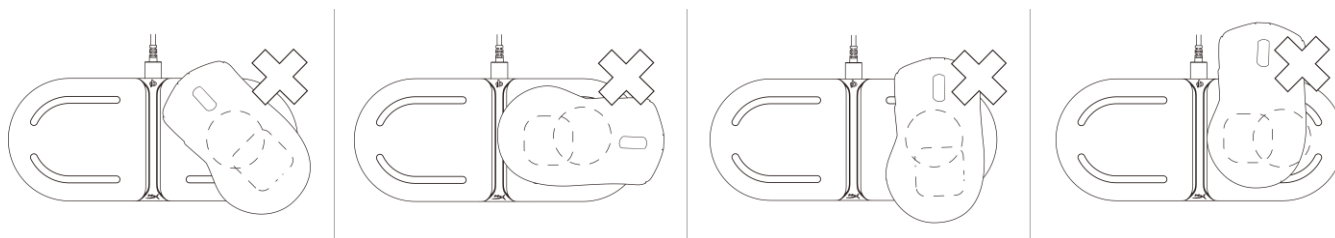
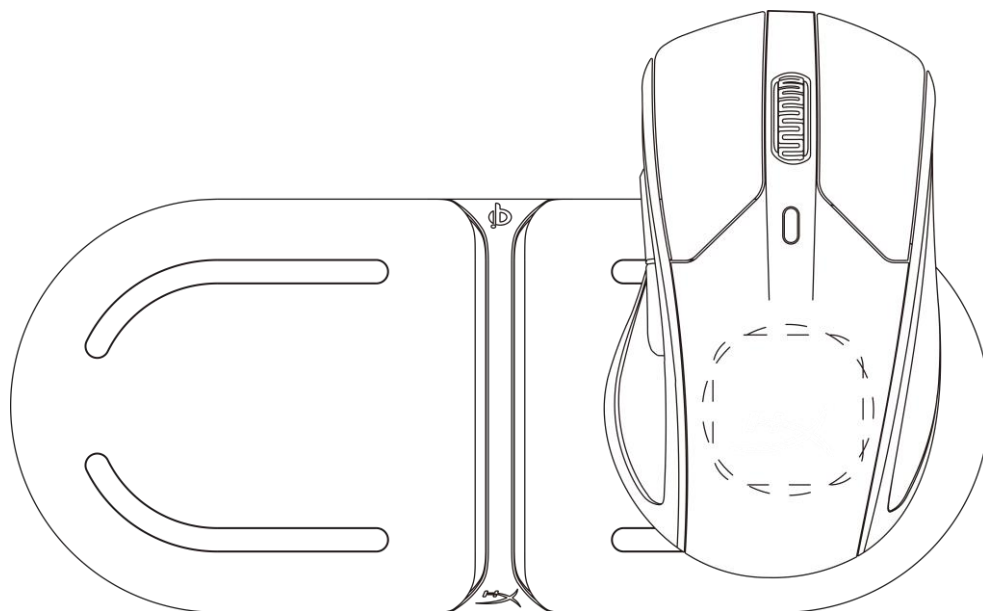

*La base di ricarica wireless non è inclusa

Ricarica con cavo

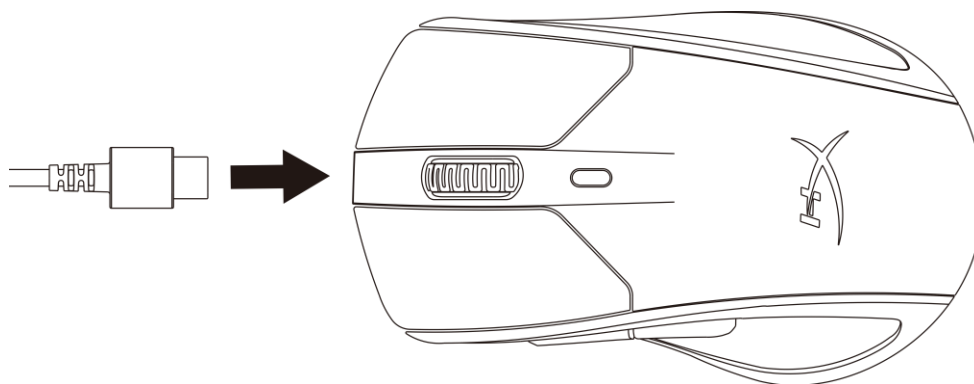



Tasti funzione

Tasti funzione	Funzionalità secondaria
Pulsante DPI	Alterna i profili DPI predefiniti. I valori di default sono: <ul style="list-style-type: none"> - 800 DPI (blu). - 1600 DPI (giallo). - 3200 DPI (verde).

Software HyperX NGENUITY

Per personalizzare illuminazione, DPI e impostazioni macro scaricare il software HyperX NGENUITY al seguente indirizzo: hyperxgaming.com/ngenuity.

Utilizzo con console

Collegare a una console PS4 o Xbox One tramite l'adattatore o il cavo USB incluso.

Ripristino impostazioni di fabbrica

Nel caso si verificano problemi nell'utilizzo del mouse, è possibile ripristinare le impostazioni di fabbrica. Questa operazione svuota completamente la memoria integrata e riporta tutte le impostazioni alla configurazione predefinita.

Tasti funzione	Funzionalità secondaria
Tenere premuti per 5 secondi il pulsante DPI insieme al pulsante della rotellina del mouse	Consente di ripristinare il mouse con le impostazioni di fabbrica.

Avete altre domande o dubbi sulla configurazione?

Contattare il team di supporto HyperX all'indirizzo: hyperxgaming.com/support/



HyperX Pulsefire Dart™



Código do Produto

HX-MC006B



ÍNDICE

Visão geral	3
Especificações.....	4
Instalação	5
Modo sem fio.....	5
Modo com fio	5
Carregando	6
Carregamento sem fio.....	6
Carregamento com fio	6
Teclas de função	7
Software HyperX NGENUITY	7
Usando com Console.....	7
Redefinir para as configurações de fábrica	7



Visão geral

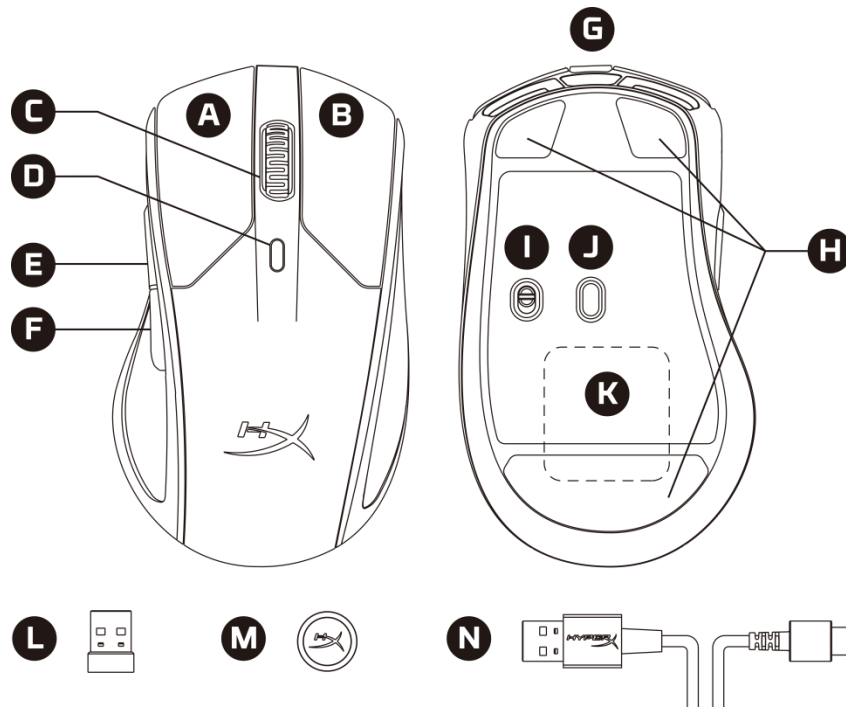

- A. Botão esquerdo
- B. Botão direito
- C. Roda do mouse
- D. Botão DPI
- E. Botão avançar
- F. Botão voltar
- G. Porta USB Tipo C
- H. Skates do mouse
- I. Chave lig/desl
- J. Sensor óptico para jogos
- K. Módulo do receptor de carregamento sem fio integrado
- L. Receptor USB
- M. Adaptador de cabo USB
- N. USB Tipo C para cabo de extensão USB Tipo A



Especificações

Ergonômico: Ergonômico

Sensor: Pixart PMW3389

Resolução: Até 16000 DPI

Velocidade: 450ips

Aceleração: 50G

Botões: 6

Chaves dos botões Esquerdo / Direito: Omron

Durabilidade dos botões Esquerdo / Direito: 50 milhões de cliques

Efeitos de luz: Iluminação RGB por LED¹

Memória integrada: 1 perfil

Tipo de conexão: 2,4GHz sem fio/com fio

Duração da bateria²: 90 horas – LED desl / 50 horas – Iluminação LED padrão

Tipo de carregamento: Carregamento Qi sem fio³ / com fio

Polling rate (taxa de captação): 1.000Hz

Tipo de cabo: Cabo removível de carregamento/dados

Peso (sem cabo): 112 g

Peso (com cabo): 130 g

Dimensões (L x A x P): 124,8 x 73,9 x 43,6 mm

Comprimento do cabo: 1,8 m

¹Iluminação RGB personalizável por LED com o software HyperX NGENUITY.

²A vida da bateria varia com base no uso e condições de computação.

³Carregador Qi sem fio vendido separadamente.



Instalação

Modo sem fio

Conecte seu receptor USB ao adaptador de cabo USB e o USB Tipo C ao cabo de extensão USB tipo A a uma porta USB do PC. Para perfeita colocação, mantenha o receptor USB a 20 cm do mouse.

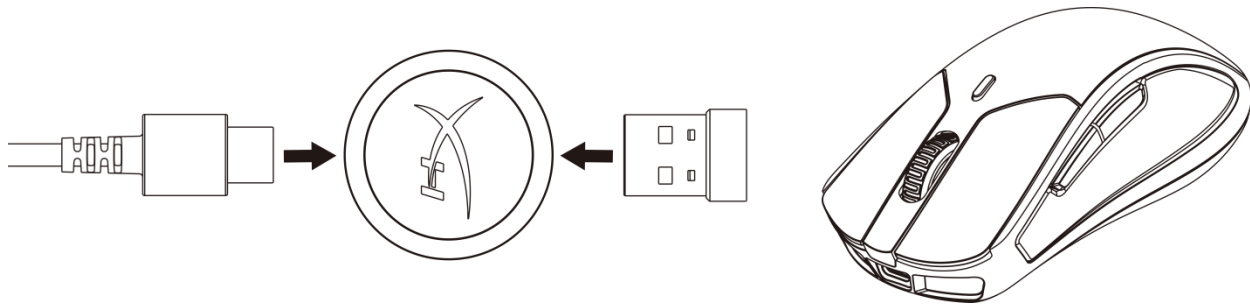

Modo com fio

Conecte seu USB Tipo C ao cabo de extensão USB Tipo A ao seu mouse e a uma porta USB do PC.

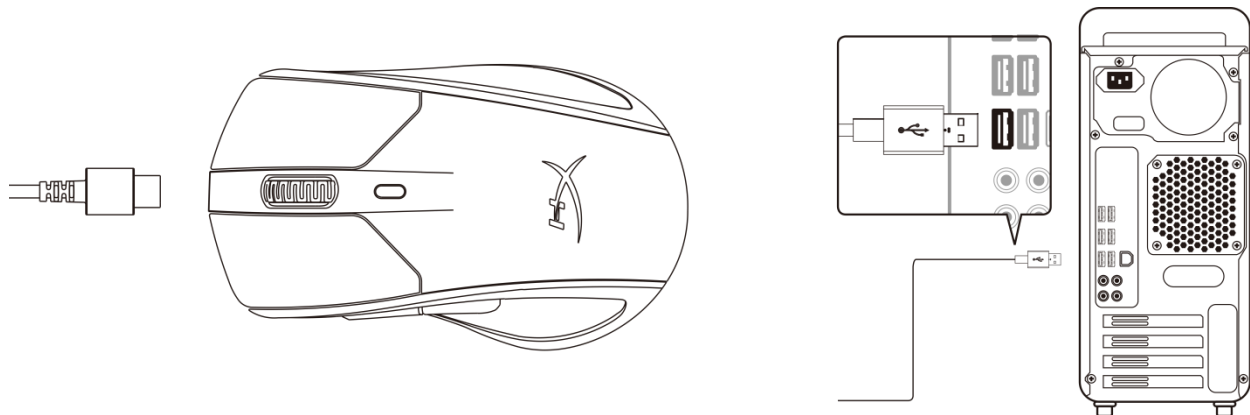



Carregando

Carregamento sem fio

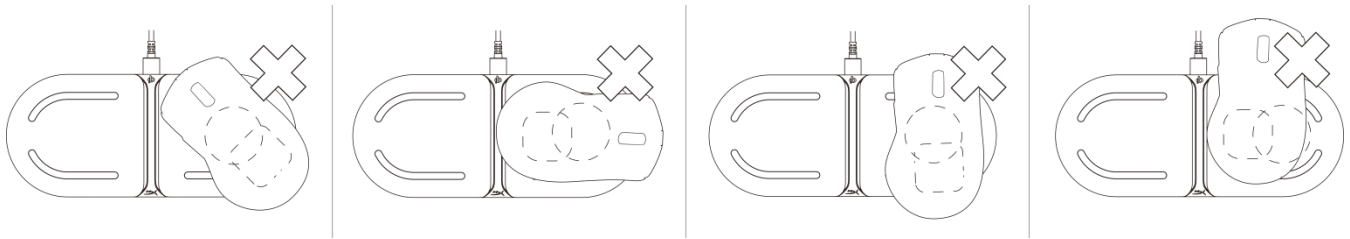
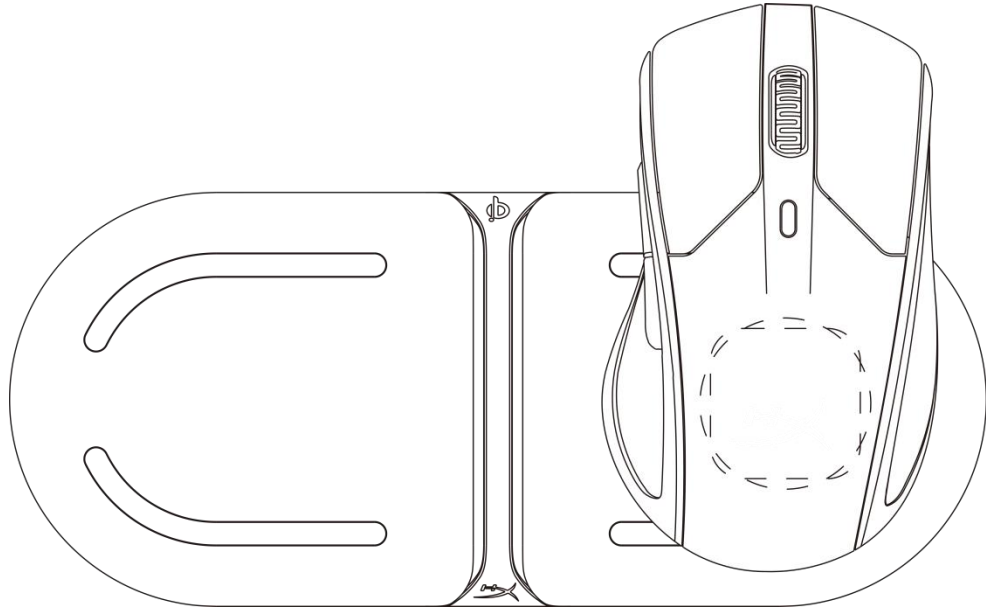

*Base de carregamento não incluída

Carregamento com fio

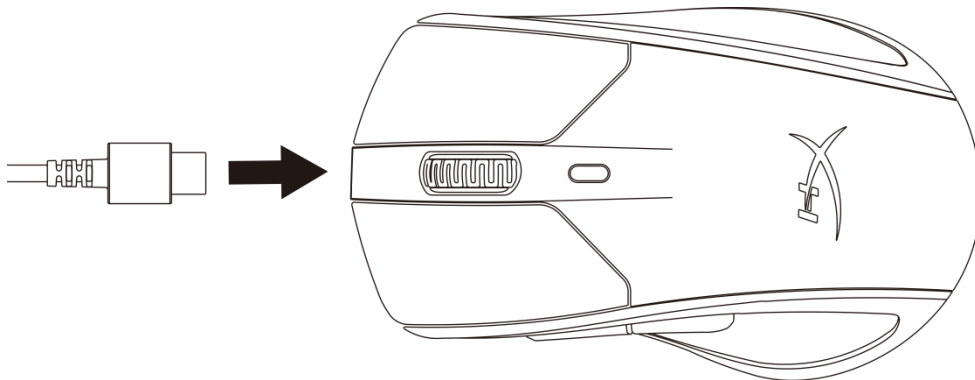



Teclas de função

Teclas de função	Recurso secundário
Botão DPI	Altere entre DPIs predefinidos. Os valores padrão são: <ul style="list-style-type: none">- 800 DPI (azul).- 1600 DPI (amarelo).- 3200 DPI (verde).

Software HyperX NGENUITY

Para personalizar as configurações de iluminação, DPI e macro, faça o download do software HyperX NGENUITY aqui: hyperxgaming.com/ngenuity.

Usando com Console

Conecte ao PS4 ou Xbox One utilizando o cabo USB incluído ou o dongle anexo.

Redefinir para as configurações de fábrica

Se está enfrentando algum problema com o mouse, você pode retornar às configurações de fábrica. A memória integrada será apagada e todas as configurações voltarão ao padrão de fábrica.

Teclas de função	Recurso secundário
Mantenha pressionado o botão DPI + a roda do mouse abaixada por 5 segundos	Retorne o mouse às configurações de fábrica.

Dúvidas ou Problemas na Instalação?

Entre em contato com a equipe de suporte HyperX em: hyperxgaming.com/support/



HyperX Pulsefire Dart[™]



Numer katalogowy

HX-MC006B



SPIS TREŚCI

Prezentacja.....	3
Dane techniczne	4
Instalacja	5
Tryb bezprzewodowy	5
Tryb przewodowy	5
Ładowanie	6
Ładowanie bezprzewodowe	6
Ładowanie przewodowe	6
Klawisze funkcji.....	7
Oprogramowanie HyperX NGENUITY	7
Użytkowanie z konsolami	7
Przywracanie ustawień fabrycznych	7



Prezentacja

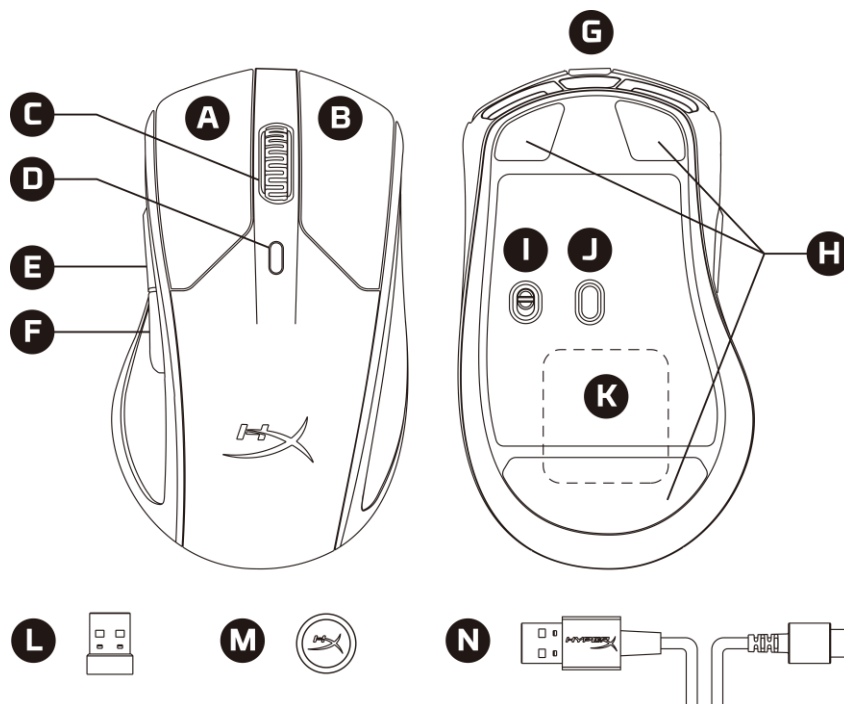

- A. Lewy przycisk
- B. Prawy przycisk
- C. Kółko
- D. Przycisk regulacji DPI
- E. Przycisk Dalej
- F. Przycisk Wstecz
- G. Port USB-C
- H. Ślizgacze
- I. Przełącznik zasilania
- J. Optyczny czujnik gamingowy
- K. Wbudowany odbiornik ładowarki bezprzewodowej
- L. Odbiornik USB
- M. Adapter przewodu USB
- N. Przedłużacz przewodu USB-C do USB-A



Dane techniczne

Ergonomia: Mysz ergonomiczna

Czujnik: Pixart PMW3389

Rozdzielczość: Do 16000 DPI

Szybkość: 450 cali/s

Przyspieszenie: 50G

Przyciski: 6

Przełączniki prawego i lewego przycisku: Omron

Trwałość prawego i lewego przycisku: 50 mln kliknięć

Efekty świetlne: Diody LED RGB¹

Wbudowana pamięć: 1 profil

Rodzaj złącza: Połączenie bezprzewodowe 2,4GHz / połączenie przewodowe

Czas pracy baterii²: 90 godzin z wyłączonym podświetleniem LED / 50 godzin z domyślnym podświetleniem LED

Sposób ładowania: Ładowanie bezprzewodowe Qi³ / Ładowanie przewodowe

Próbkowanie: 1000Hz

Typ przewodu: Odłączany przewód danych/ładowania

Waga (bez przewodu): 112g

Waga (z przewodem): 130g

Wymiary (dł. x szer. x wys.): 124,8mm x 73,9mm x 43,6mm

Długość przewodu: 1,8m

¹Personalizacja podświetlenia RGB każdej diody LED możliwa za pomocą oprogramowania HyperX NGENUITY.

²Czas pracy przy zasilaniu z baterii zależy od sposobu eksploatacji i środowiska komputera.

³Ładowarka bezprzewodowa Qi do nabycia osobno.



Instalacja

Tryb bezprzewodowy

Podłącz odbiornik USB do adaptera przewodu USB, a przedłużacz przewodu USB-C do USB-A podłącz do portu USB w komputerze. Optymalnie umieszczony odbiornik powinien znajdować się nie dalej niż 20cm od myszy.

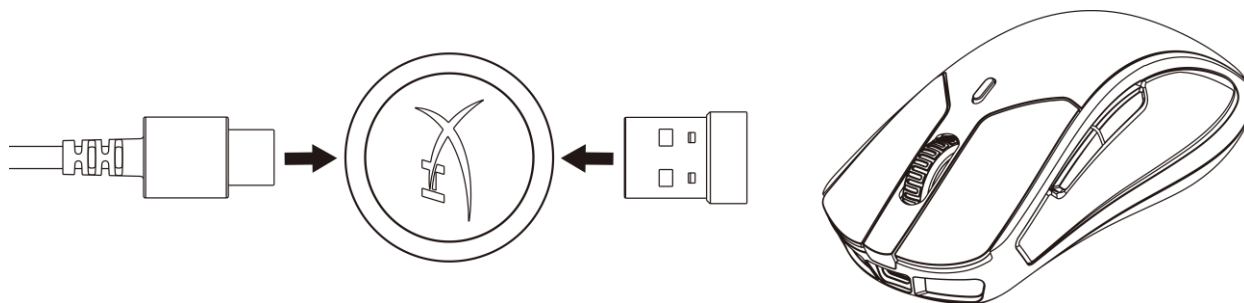

Tryb przewodowy

Podłącz przedłużacz przewodu USB-C do USB-A do myszy i do portu USB w komputerze.

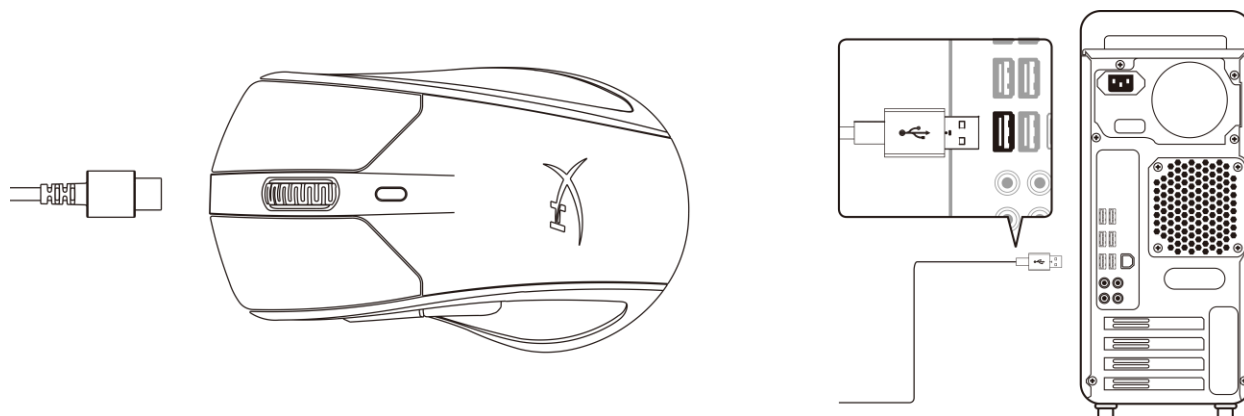



Ładowanie

Ładowanie bezprzewodowe

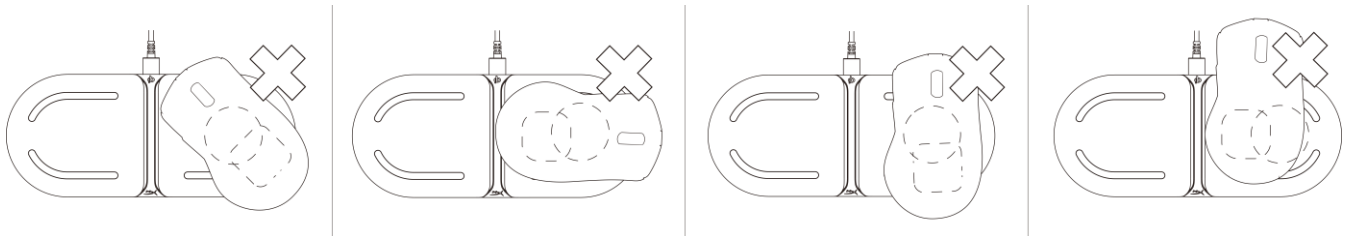
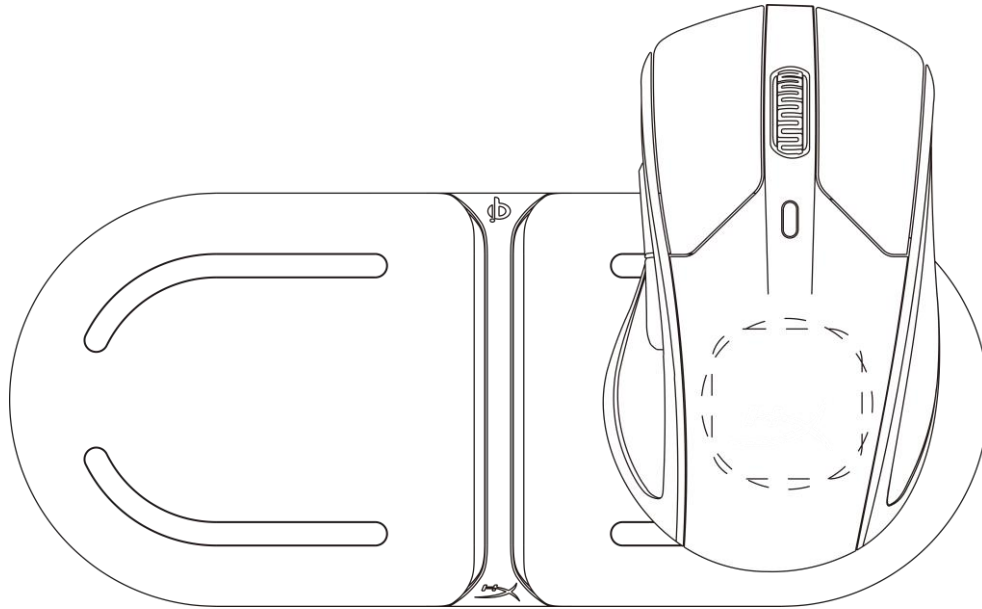

*Ładowarki do nabycia osobno

Ładowanie przewodowe

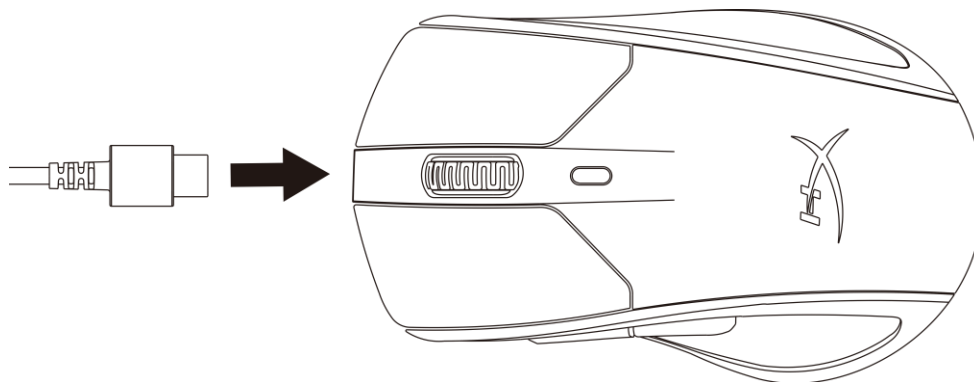



Klawisze funkcji

Klawisze funkcji	Funkcja dodatkowa
Przycisk regulacji DPI	Wybór trybu DPI. Domyślne wartości: <ul style="list-style-type: none"> - 800 DPI (niebieski). - 1600 DPI (żółty). - 3200 DPI (zielony).

Oprogramowanie HyperX NGENUITY

Pobierz oprogramowanie HyperX NGENUITY do personalizacji podświetlenia, rozdzielczości DPI i ustawień makr: hyperxgaming.com/ngenuity.

Użytkowanie z konsolami

Podłącz mysz do konsoli PS4 lub Xbox One dołączonym przewodem USB lub przejściówką.

Przywracanie ustawień fabrycznych

W razie napotkania jakichkolwiek problemów w działaniu myszy można ją zresetować do ustawień fabrycznych. Spowoduje to wyczyszczenie wbudowanej pamięci myszy i przywrócenie fabrycznych ustawień wszystkich opcji.

Klawisze funkcji	Funkcja dodatkowa
Przytrzymanie przycisku DPI + przycisku kółka myszy przez 5 sekund	Przywrócenie fabrycznych ustawień myszy.

Pytania? Problemy z konfiguracją?

Skontaktuj się z działem pomocy technicznej HyperX na stronie: hyperxgaming.com/support/



HyperX Pulsefire Dart[™]



Номер артикула

HX-MC006B



СОДЕРЖАНИЕ

Обзор	3
Технические характеристики	4
Установка	5
Беспроводной режим.....	5
Проводной режим	5
Зарядка	6
Беспроводная зарядка	6
Проводная зарядка.....	6
Функциональные клавиши	7
Программное обеспечение HyperX NGENUITY	7
Использование с консолью	7
Восстановление заводских настроек	7



Обзор

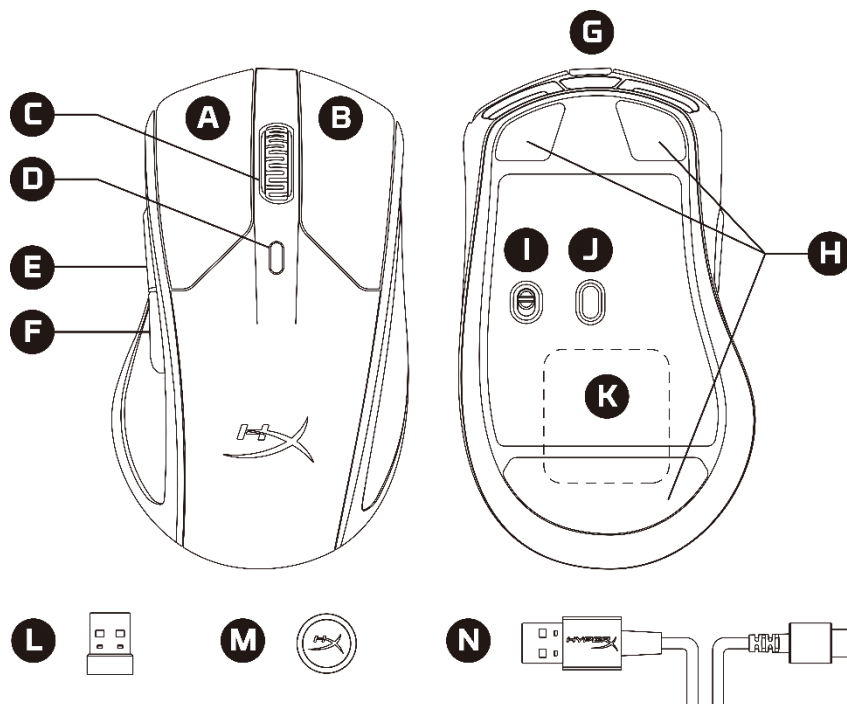

- A. Левая кнопка мыши
- B. Правая кнопка мыши
- C. Колёсико мыши
- D. Кнопка настройки разрешения DPI (числа точек на дюйм)
- E. Кнопка для нажатия вперед
- F. Кнопка для нажатия назад
- G. Порт USB-C
- H. Накладки скольжения мыши
- I. Переключатель электропитания
- J. Игровой оптический датчик
- K. Встроенный приемный модуль для беспроводной зарядки
- L. Приемник USB
- M. Адаптер для кабеля USB
- N. Удлинительный кабель для подключения USB-C к USB-A



Технические характеристики

Эргономичность: эргономичная

Сенсор: Pixart PMW3389

Разрешение: до 16000DPI (точек на дюйм)

Скорость: 450 дюймов в секунду

Ускорение: 50G

Кнопки: 6

Переключатели кнопок «Влево»/«Вправо»: Omron

Срок службы кнопок «Влево»/«Вправо»: 50 млн нажатий

Световые эффекты: RGB-подсветка с индивидуальной настройкой каждого светодиода¹

Встроенная память: 1 профиль

Тип подключения: беспроводное 2,4ГГц / проводное

Время работы от батареи²: 90 часов — при выключенных светодиодах / 50 часов — с заданной по умолчанию светодиодной подсветкой

Тип зарядки: беспроводная зарядка Qi³ / проводная

Частота опроса: 1000Гц

Тип кабеля: отсоединяемый кабель для зарядки / передачи данных

Вес (без кабеля): 112г

Вес (с кабелем): 130г

Размеры (Д x Ш x В): 124,8мм x 73,9мм x 43,6мм

Длина кабеля: 1,8м

¹Индивидуальная настройка каждого светодиода RGB-подсветки с помощью ПО HyperX NGENUITY.

²Время работы от батареи зависит от условий использования и выполняемых вычислительных задач.

³Беспроводное зарядное устройство Qi продается отдельно.



Установка

Беспроводной режим

Подсоедините приемник USB к адаптеру кабеля USB, а удлинительный кабель для подключения USB-C к USB-A — к порту USB ПК. В целях обеспечения оптимального расположения поместите приемник USB в пределах 20см от мыши.

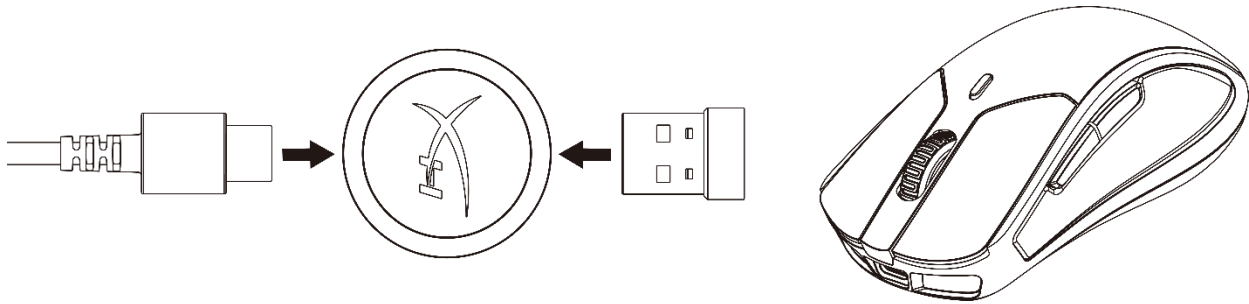

Проводной режим

Подсоедините удлинительный кабель для подключения USB-C к USB-A к мыши и к порту USB ПК.

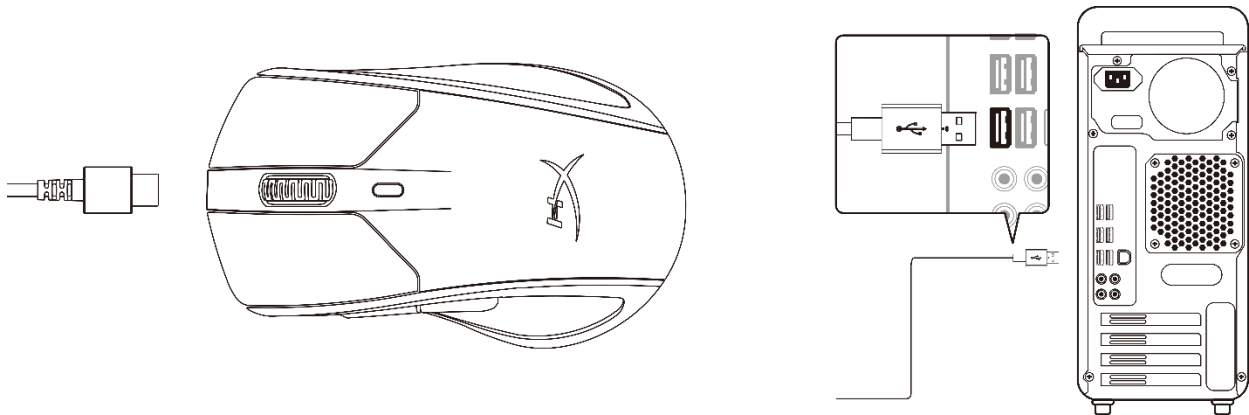



Зарядка

Беспроводная зарядка

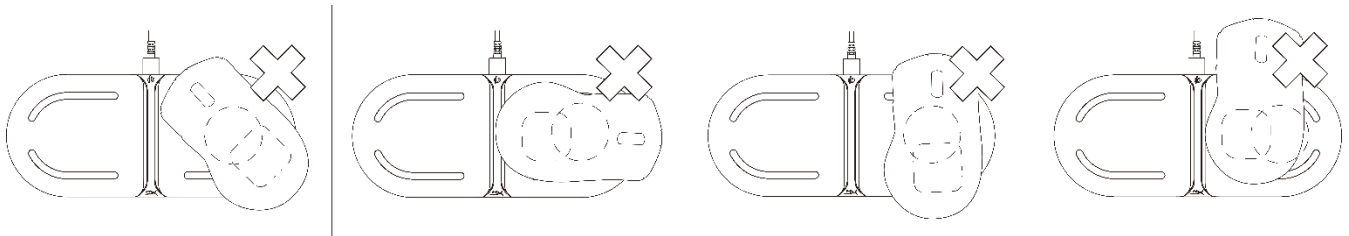
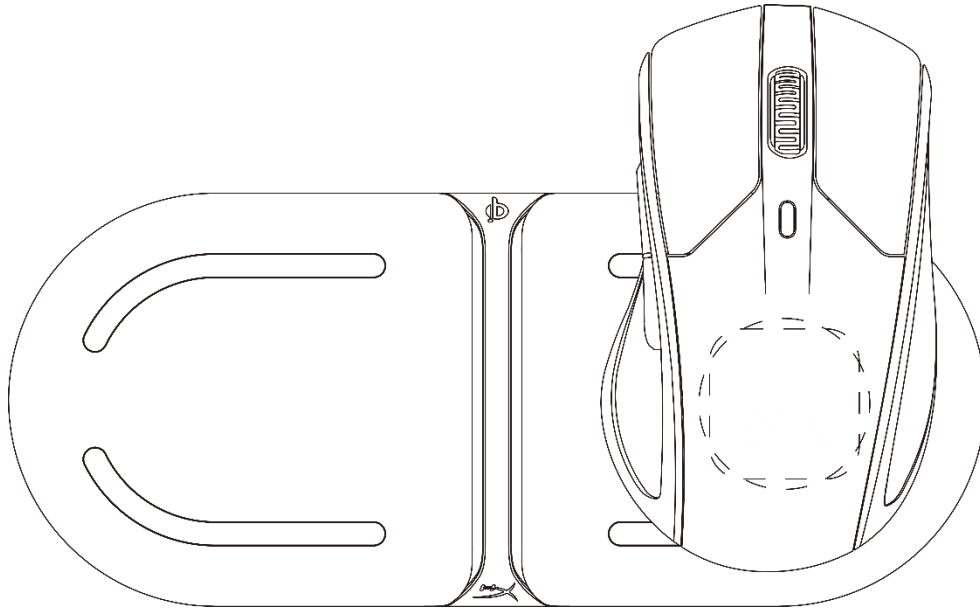

*Зарядная платформа не входит в комплект поставки.

Проводная зарядка

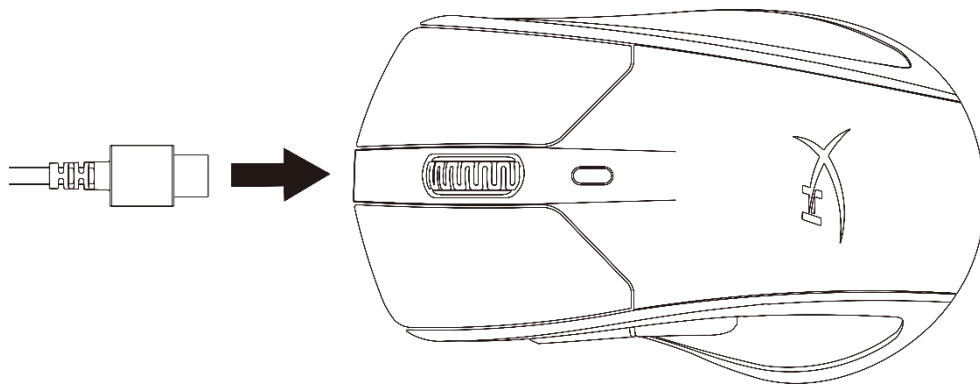



Функциональные клавиши

Функциональные клавиши	Дополнительная функция
Кнопка настройки разрешения DPI (числа точек на дюйм)	Переключение предустановок DPI. Значения по умолчанию: <ul style="list-style-type: none">- 800 DPI (синий).- 1600 DPI (желтый).- 3200 DPI (зеленый).

Программное обеспечение HyperX NGENUITY

Для индивидуальной настройки подсветки, разрешения DPI и макросов скачайте ПО HyperX NGenuity здесь: hyperxgaming.com/ngenuity.

Использование с консолью

Подключите мышь к консоли PS4 или Xbox One с помощью прилагаемого в комплекте USB-кабеля или донглового адаптера.

Восстановление заводских настроек

При возникновении каких-либо проблем с мышью можно выполнить восстановление заводских настроек. Встроенная память будет очищена, и будут восстановлены заданные по умолчанию значения всех настроек.

Функциональные клавиши	Дополнительная функция
Нажатие кнопки разрешения DPI + колесика мыши на 5 секунд	Выполнение восстановления заводских настроек мыши.

Вопросы или проблемы с настройкой?

Свяжитесь с командой технической поддержки HyperX по адресу: hyperxgaming.com/support/



HyperX Pulsefire Dart[™]



Parça Numarası

HX-MC006B



İÇİNDEKILER

Genel görünüm	3
Teknik özellikler	4
Kurulum.....	5
Kablosuz Mod	5
Kablolu Mod	5
Şarj etme	6
Kablosuz Şarj.....	6
Kablolu Şarj.....	6
Fonksiyon Tuşları	7
HyperX NGENUITY Yazılımı	7
Konsol ile kullanım	7
Fabrika Ayarlarına Sıfırlama	7



Genel görünüm

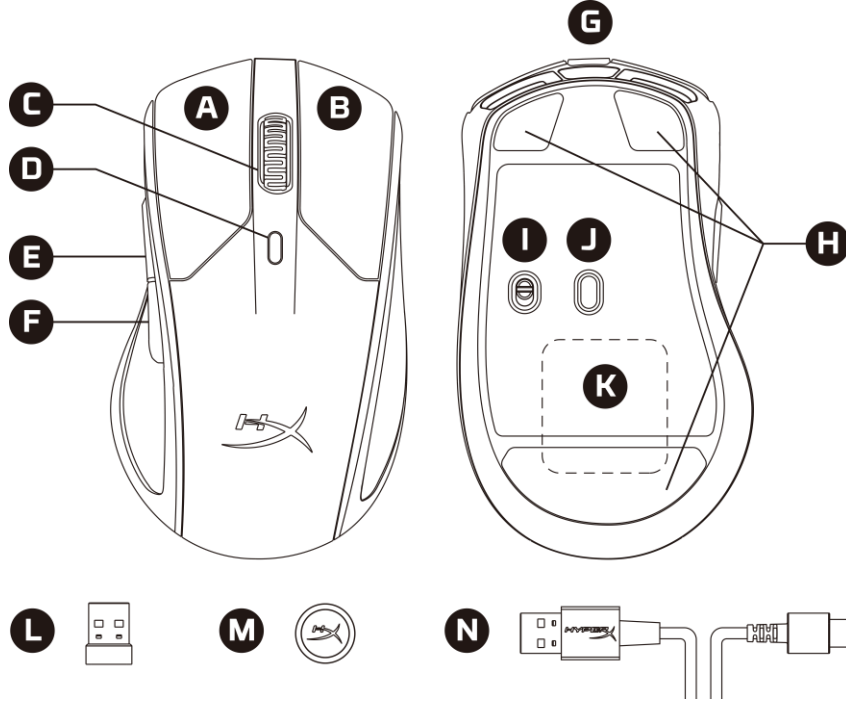

- A. Sol tıklama düğmesi
- B. Sağ tıklama düğmesi
- C. Mouse tekerleği
- D. DPI düğmesi
- E. İleri tıklama düğmesi
- F. Geri tıklama düğmesi
- G. USB-C bağlantı noktası
- H. Mouse kızakları
- I. Güç düğmesi
- J. Optik oyun sensörü
- K. Yerleşik kablosuz şarj alıcı modülü
- L. USB alıcı
- M. USB kablo adaptörü
- N. USB-C - USB-A uzatma kablosu



Teknik özellikler

Ergonomik özellikler: Ergonomik

Sensör: Pixart PMW3389

Çözünürlük: 16.000 DPI'ya kadar

Hız: 450 ips

Hızlanma: 50 G

Düğme sayısı: 6

Sol / Sağ düğme anahtarları: Omron

Sol / Sağ düğme dayanıklılığı: 50 milyon tıklama

Işık efektleri: LED RGB aydınlatma başına¹

Yerleşik bellek: 1 profil

Bağlantı tipi: 2.4 GHz kablosuz / kablolu

Pil ömrü²: 90 saat – LED kapalı / 50 saat – Varsayılan LED aydınlatma

Şarj tipi: Kablosuz Qi şarj³ / kablolu

Sorgulama hızı: 1000 Hz

Kablo tipi: Çıkarılabilir şarj/veri kablosu

Ağırlık (kablo olmadan): 112 g

Ağırlık (kablo ile birlikte): 130 g

Boyutlar (U x G x Y): 124,8 mm x 73,9 mm x 43,6 mm

Kablo uzunluğu: 1,8 m

¹LED RGB aydınlatma özelliği, HyperX NGENUITY Yazılımı ile kişiselleştirilebilir.

²Pil ömrü, kullanıma ve bilgi-işlem koşullarına göre değişir.

³Qi kablosuz şarj cihazı ayrı satılır.



Kurulum

Kablosuz Mod

USB alıcınızı USB kablo adaptörüne; USB-C - USB-A uzatma kablosunu ise PC'nin USB bağlantı noktasına bağlayın. En ideal yerleşim düzeni için lütfen USB alıcınızı, mouse'un 20 cm uzağında tutun.

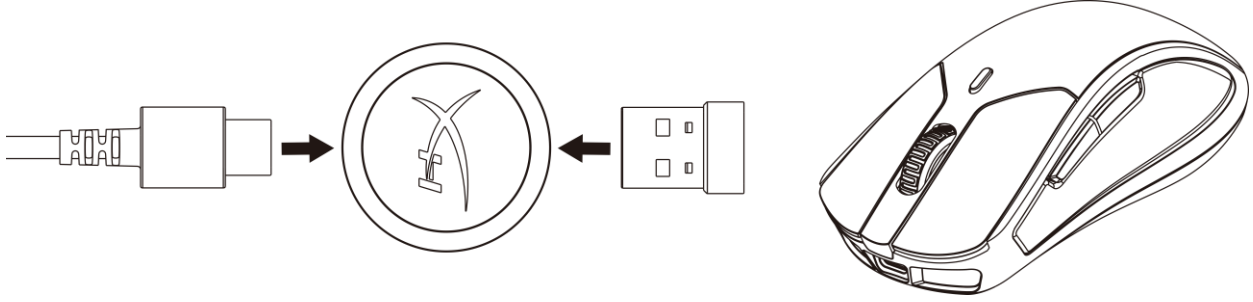

Kablolu Mod

USB-C - USB-A uzatma kablonuzu mouse'unuza ve PC'nin USB bağlantı noktasına bağlayın.

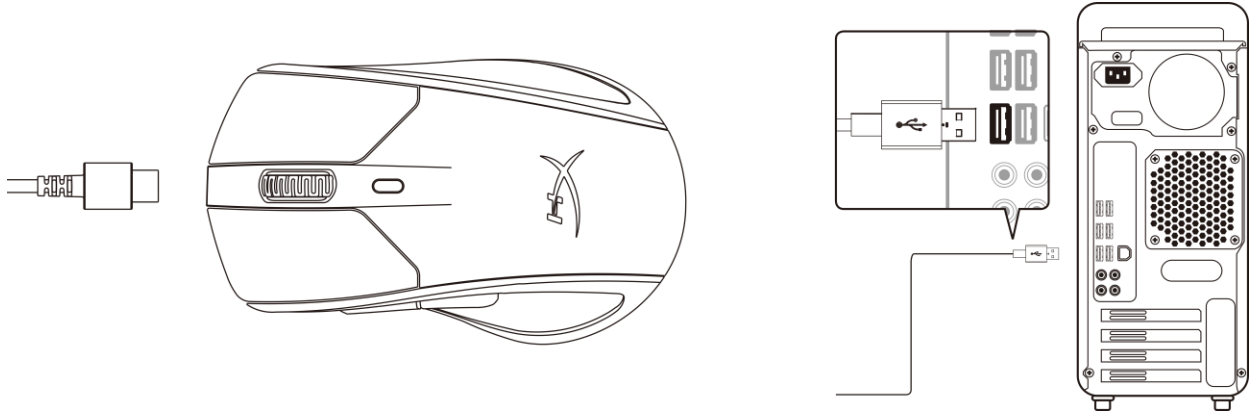



Şarj etme

Kablosuz Şarj

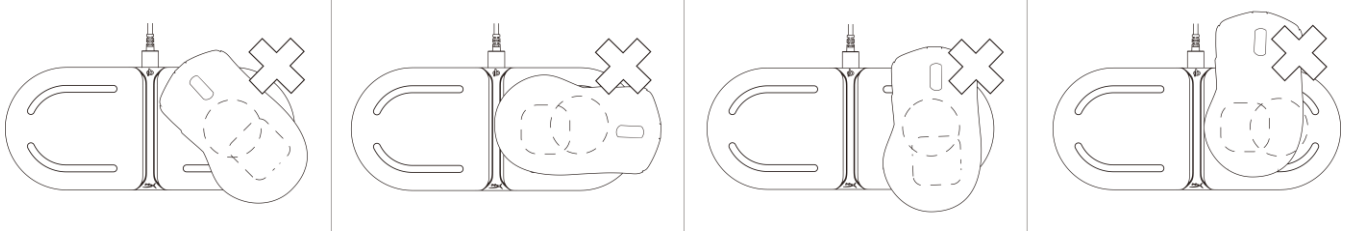
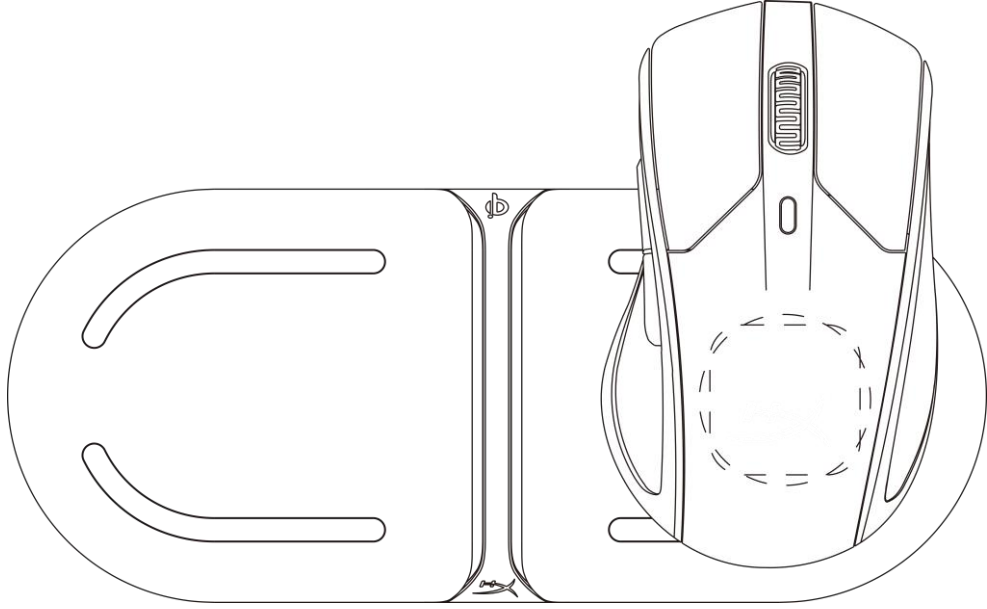

*Şarj platformu dahil değildir

Kablolu Şarj

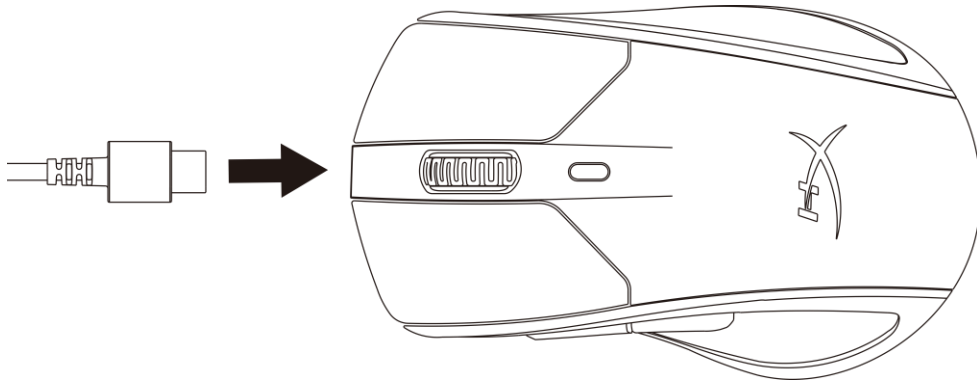



Fonksiyon Tuşları

Fonksiyon Tuşları	İkincil Özellik
DPI düğmesi	DPI önayarlarını değiştirir. Varsayılan değerler: <ul style="list-style-type: none">- 800 DPI (mavi).- 1600 DPI (sarı).- 3200 DPI (yeşil).

HyperX NGENUITY Yazılımı

Aydınlatma özelliklerini, DPI önayarlarını ve makro ayarlarını kişiselleştirmenizi sağlayan HyperX NGENUITY Yazılımını buradan indirebilirsiniz: hyperxgaming.com/ngenuity.

Konsol ile kullanım

Kutudan çıkan USB kabloyu veya dongle'ı kullanarak PS4 veya Xbox One'a bağlayın.

Fabrika Ayarlarına Sıfırlama

Mouse'la ilgili herhangi bir sorun yaşıyorsanız, fabrika ayarlarına sıfırlama işlemi gerçekleştirebilirsiniz. Bu durumda yerleşik bellek silinir ve tüm ayarlar varsayılanına döner.

Fonksiyon Tuşları	İkincil Özellik
DPI düğmesi + mouse tekerleği düğmesini 5 saniye basılı tutma	Mouse'u fabrika ayarlarına sıfırlama.

Sorunuz mu var? Kurulum sorunları mı yaşıyorsunuz?

HyperX destek ekibi ile irtibata geçin: hyperxgaming.com/support/



HyperX Pulsefire Dart[™]



製品番号

HX-MC006B



目次

概要	3
仕様	4
取付け方法.....	5
ワイヤレスモード.....	5
有線モード	5
充電中.....	6
ワイヤレス充電中	6
有線充電	6
ファンクションキー	7
HyperX NGENUITY ソフトウェア	7
ゲーム機との使用.....	7
工場出荷時の状態にリセット.....	7



概要

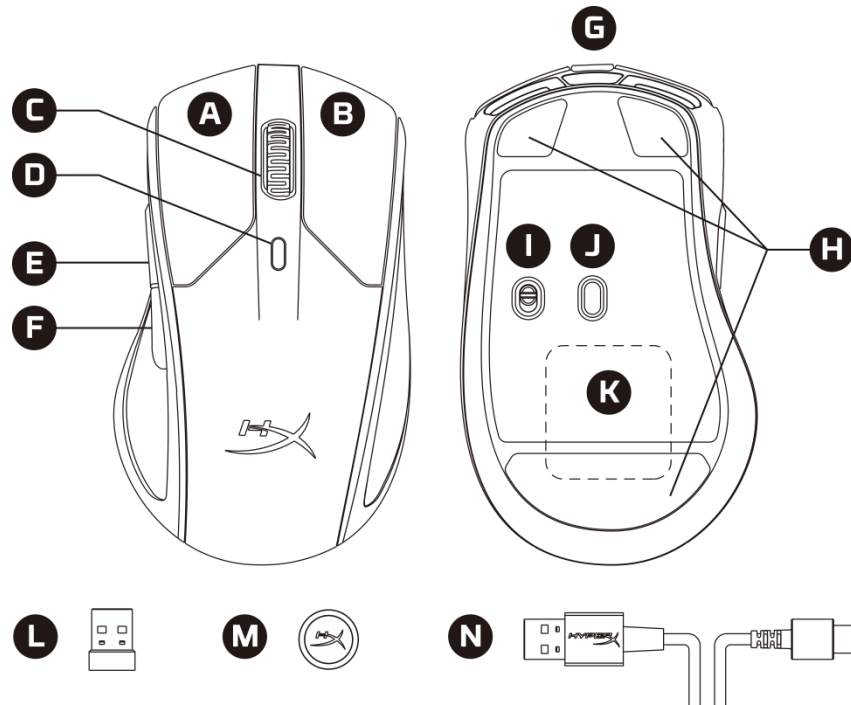

- A. 左クリックボタン
- B. 右クリックボタン
- C. マウスホイール
- D. DPI ボタン
- E. 進むボタン
- F. 戻るボタン
- G. USB-C ポート
- H. マウスソール
- I. 電源スイッチ
- J. 光学式ゲーミングセンサー
- K. 内蔵ワイヤレス充電レシーバーモジュール
- L. USB レシーバー
- M. USB ケーブルアダプター
- N. USB-C - USB-A 延長ケーブル



仕様

エルゴノミックエルゴノミック

センサー: Pixart PMW3389

解像度: 最大 16000DPI

速度: 450ips

加速度: 50G

ボタン: 6

左右ボタンのスイッチ: オムロン製

左右ボタンの耐久性: 5000 万クリック

照明効果: LED ごとの RGB ライティング¹

オンボードメモリ: プロファイル x1

接続タイプ: 2.4GHz ワイヤレス/有線

バッテリーの駆動時間²: 90 時間 - LED オフ / 50 時間 - デフォルト LED ライティング

充電方式: ワイヤレス Qi 充電³ / 有線

ポーリングレート: 1000Hz

ケーブル種類: 取り外し可能な充電/データケーブル

重量(ケーブルを含まず): 112g

重量(ケーブルを含む): 130g

寸法(長さ x 幅 x 高さ): 124.8mm x 73.9mm x 43.6mm

ケーブルの長さ: 1.8m

¹HyperX NGENUITY ソフトウェアを使用して各 LED の RGB ライティングを個別にカスタマイズできます。

²バッテリーの稼働時間は使用状況やコンピューターの条件によって変わります。

³Qi ワイヤレス充電器は別売です。



取付け方法

ワイヤレスモード

USB レシーバーを USB ケーブルアダプターに、USB-C - USB-A 延長ケーブルを PC の USB ポートに接続します。最適な性能を得るために、USB レシーバーをマウスから 20cm 以内に保ってください。

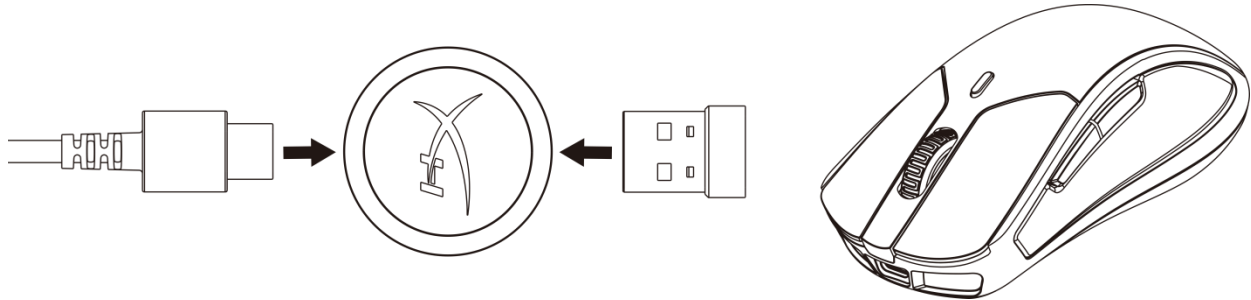

有線モード

USB-C - USB-A 延長ケーブルをマウスと PC の USB ポートに接続します。

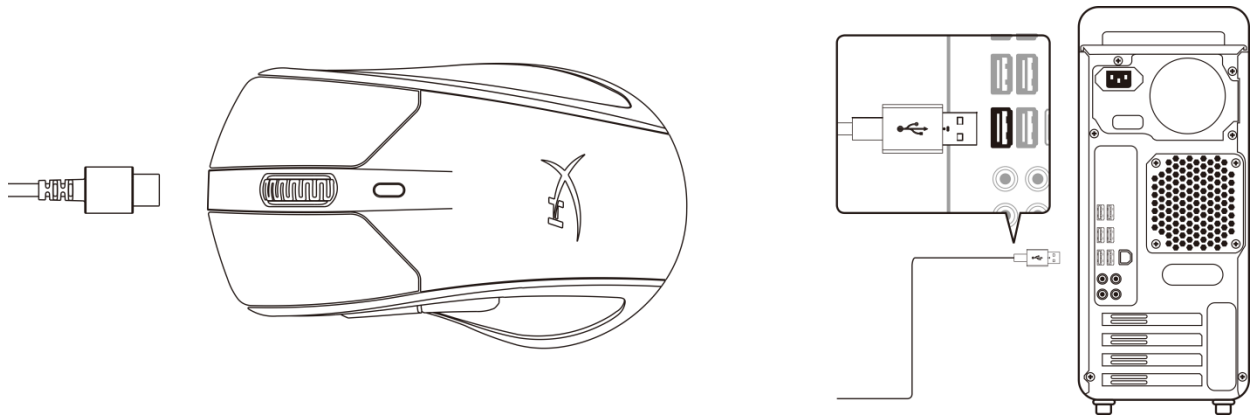



充電中

ワイヤレス充電中

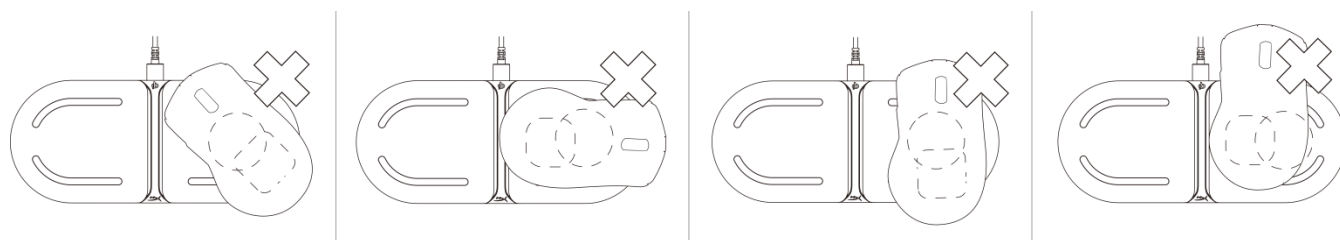
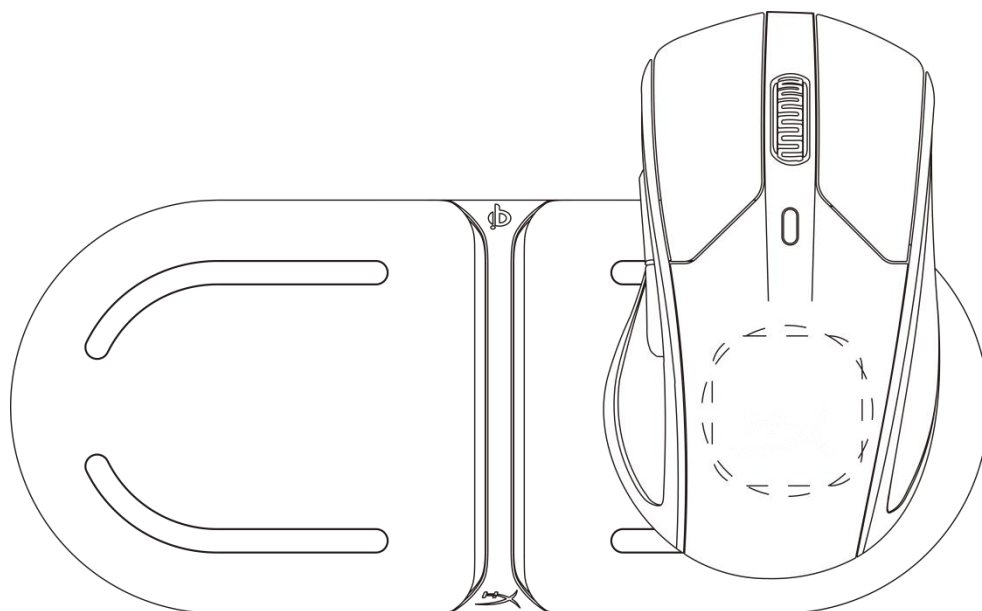

*充電ベースは含まれません

有線充電

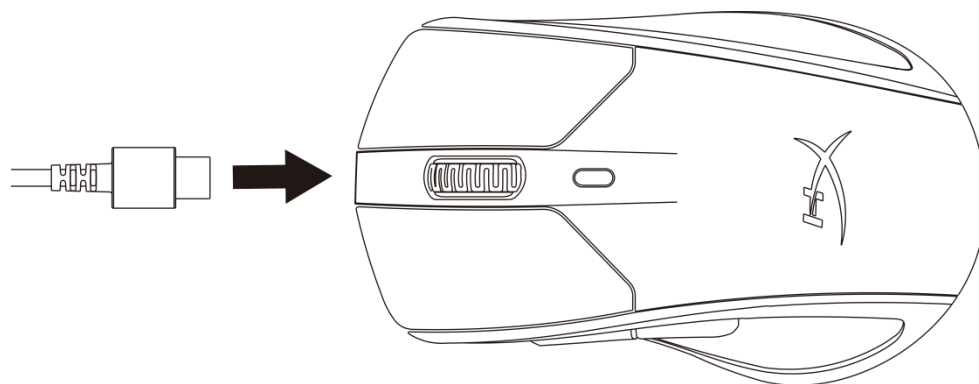



ファンクションキー

ファンクションキー	二次機能
DPI ボタン	DPI プリセット値の変更: デフォルト値: <ul style="list-style-type: none"> - 800 DPI (青)。 - 1600 DPI (黄)。 - 3200 DPI (緑)。

HyperX NGENUITY ソフトウェア

ライティング、DPI、マクロ設定をカスタマイズするには、hyperxgaming.com/ngenuity で HyperX NGENUITY ソフトウェアをダウンロードしてください。

ゲーム機との使用

付属の USB ケーブルまたは dongle アタッチメントを使用して、PS4 または Xbox One に接続します。

工場出荷時の状態にリセット

マウスに問題が生じた場合、工場出荷状態に戻すことができます。オンボードメモリがクリアされ、すべての設定が元に戻ります。

ファンクションキー	二次機能
DPI ボタン + マウスホイールを 5 秒間長押しする	マウスが工場出荷時の状態に戻ります。

ご質問、またはセットアップに問題がありますか？

HyperX サポートチーム (hyperxgaming.com/support/) までお問い合わせください。



HyperX Pulsefire Dart[™]



부품 번호

HX-MC006B



목차

개요	3
규격	4
설치	5
무선 모드.....	5
유선 모드.....	5
충전	6
무선 충전.....	6
유선 충전.....	6
기능 키.....	7
HyperX NGENUITY 소프트웨어	7
콘솔 사용	7
공장 기본값 재설정	7



개요

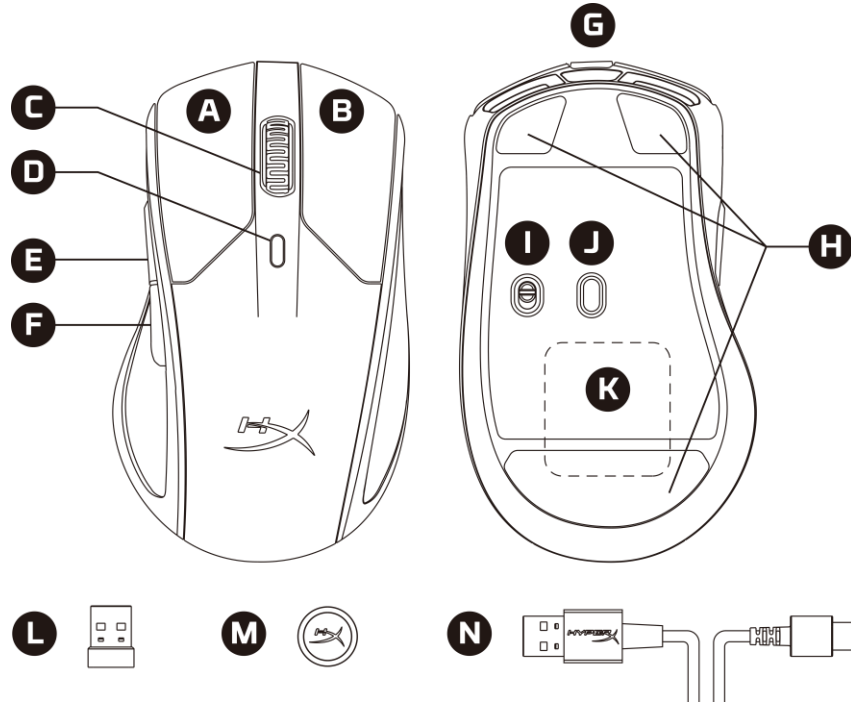

- A. 왼쪽 클릭 버튼
- B. 오른쪽 클릭 버튼
- C. 마우스 휠
- D. DPI 버튼
- E. 앞으로 가기 클릭 버튼
- F. 뒤로 가기 클릭 버튼
- G. USB-C 포트
- H. 마우스 스케이트
- I. 전원 스위치
- J. 게임용 광센서
- K. 내장 무선 충전 리시버 모듈
- L. USB 리시버
- M. USB 케이블 어댑터
- N. USB-C 형에서 USB-A 형 연장 케이블



규격

인체공학 적용: 인체공학적 디자인

센서: Pixart PMW3389

해상도: 최대 16,000 DPI

속도: 450ips

가속: 50G

버튼: 6

좌 / 우 버튼 스위치: Omron

좌 / 우 버튼의 내구성: 클릭 5 천만 회

조명 효과: LED 별 RGB 조명¹

온보드 메모리: 1 개의 프로파일

연결 유형: 2.4GHz 무선/유선

배터리 수명²: 90 시간 – LED 꺼짐 / 50 시간 - 기본 LED 조명

충전 유형: 무선 Qi 충전³ / 유선

폴링 속도: 1,000Hz

케이블 유형: 분리형 충전/데이터 케이블

무게(케이블 제외): 112g

무게(케이블 포함): 130g

크기(길이 x 너비 x 높이): 124.8mm x 73.9mm x 43.6mm

케이블 길이: 1.8m

¹HyperX NGENUITY 소프트웨어로 LED 별 RGB 조명을 사용자 정의할 수 있습니다.

²배터리 수명은 사용량과 컴퓨팅 환경에 따라 달라질 수 있습니다.

³Qi 무선 충전기는 별도로 판매합니다.



설치

무선 모드

USB 리시버를 USB 케이블 어댑터에 연결하고, USB-C 형에서 USB-A 형 연장 케이블을 PC USB 포트에 연결합니다. 최적의 배치를 위해 USB 리시버가 마우스에서 20cm 이내에 위치하도록 하십시오.

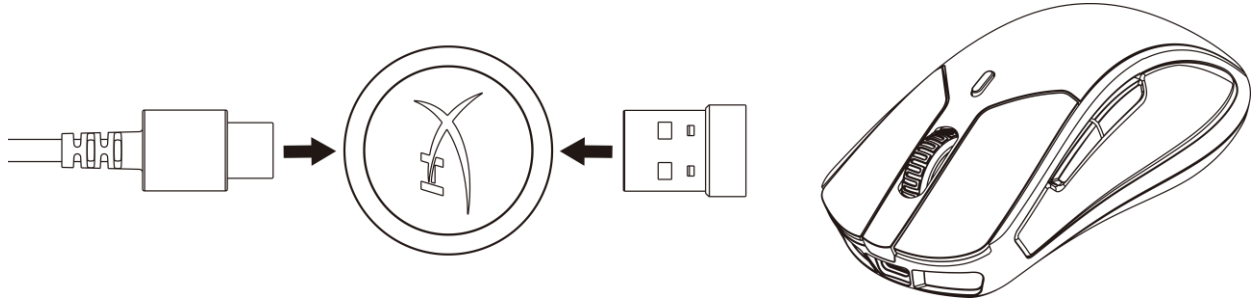

유선 모드

USB-C 형에서 USB-A 형 연장 케이블을 마우스 및 PC USB 포트에 연결합니다.

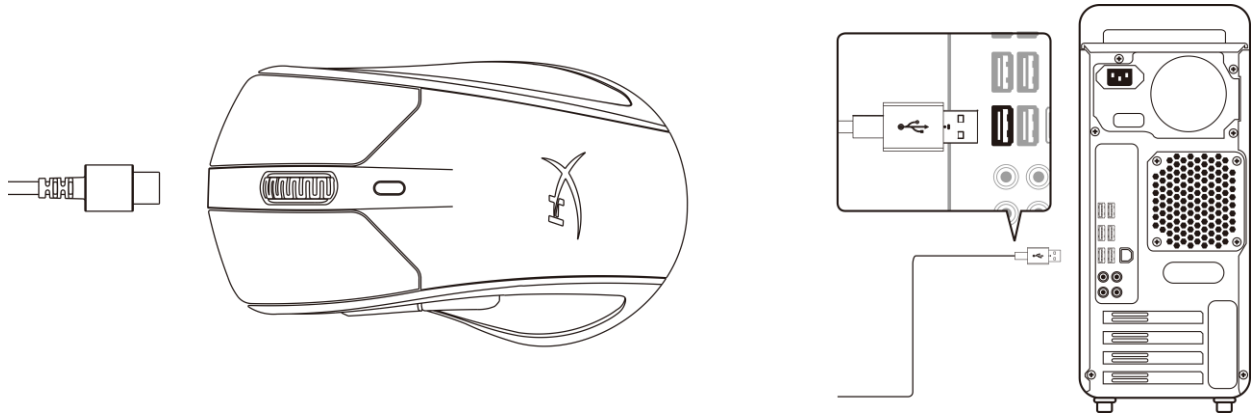



충전

무선 충전

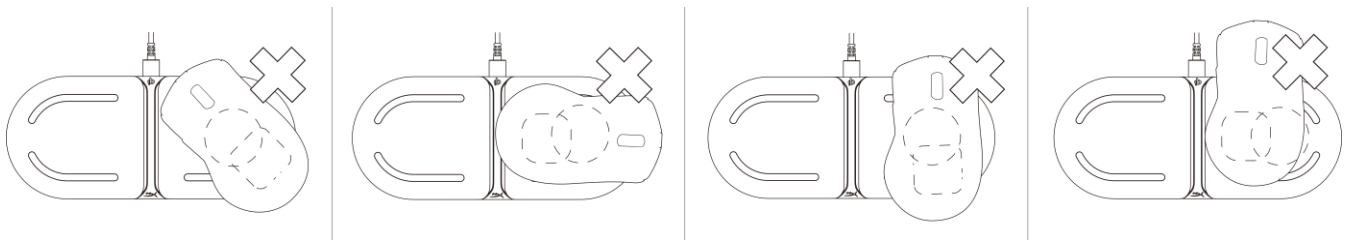
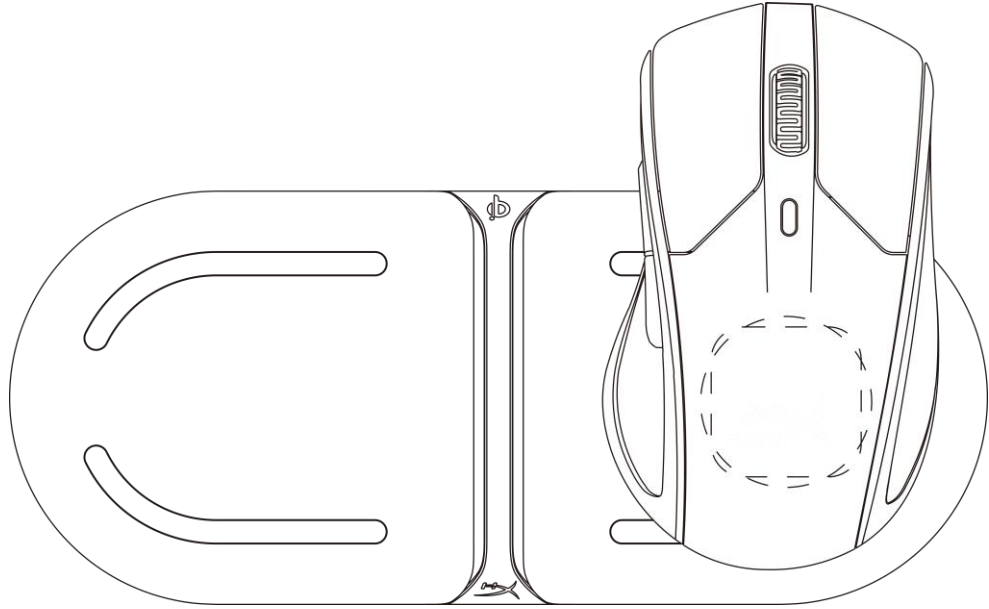

*충전 받침대 별매

유선 충전

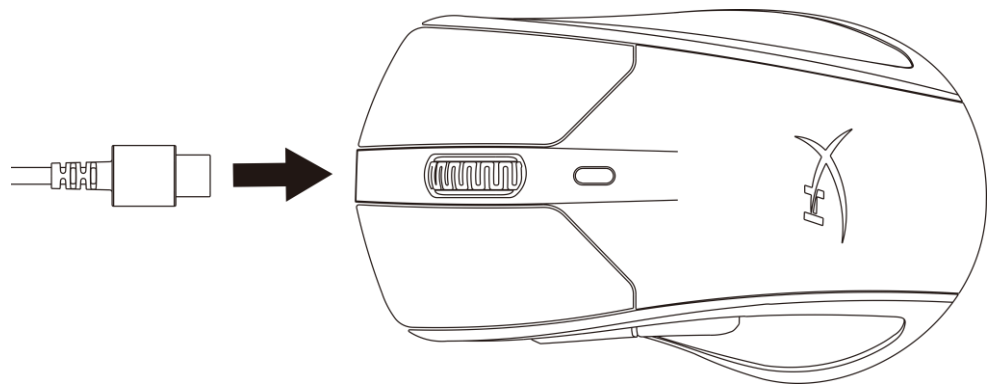



기능 키

기능 키	제 2 기능
DPI 버튼	DPI 기본 설정 간 전환합니다. 기본값은 다음과 같습니다. <ul style="list-style-type: none"> - 800 DPI(파란색). - 1,600 DPI(노란색). - 3,200 DPI(초록색).

HyperX NGENUITY 소프트웨어

조명, DPI 및 매크로 설정을 사용자 정의하려면 여기에서 HyperX NGENUITY 소프트웨어를 다운로드하십시오. hyperxgaming.com/ngenuity.

콘솔 사용

포함된 USB 케이블 또는 동글 부착장치를 사용하여 PS4 또는 Xbox One 에 연결합니다.

공장 기본값 재설정

마우스에 문제가 있는 경우 공장 기본값 재설정을 실행할 수 있습니다. 온보드 메모리가 지워지고, 모든 설정이 기본값으로 되돌아 갑니다.

기능 키	제 2 기능
5 초 동안 DPI 버튼 + 마우스 휠 버튼 누름	마우스에서 공장 기본값 설정을 수행합니다.

질문 또는 설치 문제가 있으십니까?

다음 주소로 HyperX 지원 팀에 연락하세요. hyperxgaming.com/support/



HyperX Pulsefire Dart[™]



เลขชิ้นส่วน

HX-MC006B



สารบัญ

ภาพรวม	3
รายละเอียดทางเทคนิค	4
การติดตั้ง	5
โหมดไร้สาย	5
โหมดต่อสาย	5
การชาร์จ.....	6
ระบบชาร์จไร้สาย	6
ระบบชาร์จต่อสาย	6
ปุ่มฟังก์ชัน	7
ซอฟต์แวร์ HyperX NGenuity	7
การใช้งานกับเครื่องเล่นเกม	7
รีเซ็ตเป็นค่าจากโรงงาน	7



ภาพรวม

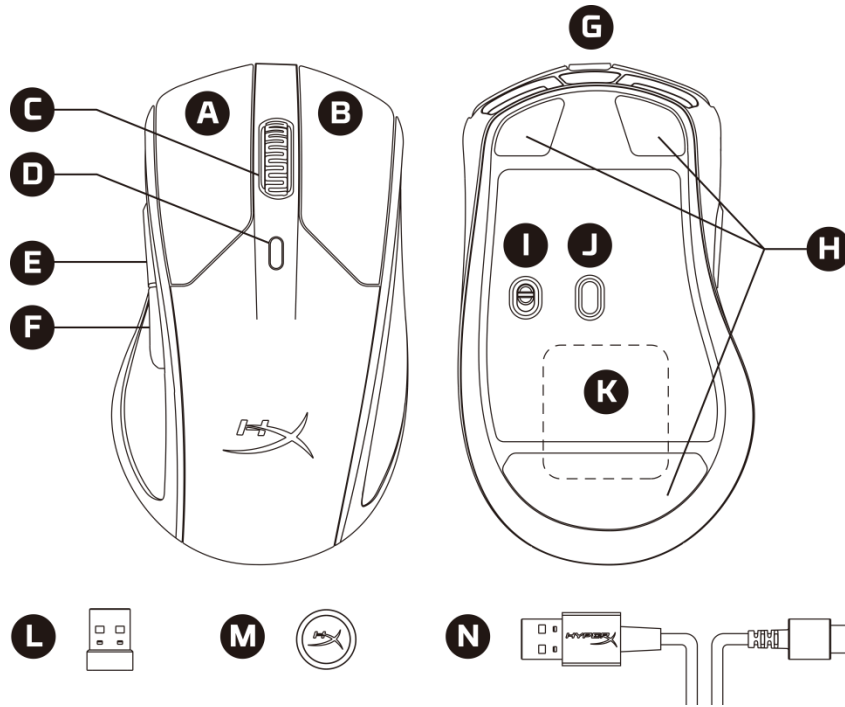

- A. ปุ่มคลิกด้านซ้าย
- B. ปุ่มคลิกด้านขวา
- C. ล้อเลื่อนเมาส์
- D. ปุ่ม DPI
- E. ปุ่มคลิกเดิหน้า
- F. ปุ่มคลิกถอยหลัง
- G. พอร์ต USB-C
- H. แผ่นเลื่อนเมาส์
- I. สวิตช์เปิดปิด
- J. เซ็นเซอร์เล่นเกมออฟติค
- K. โมดูลรับสัญญาณชาร์จไร้สายในตัว
- L. ตัวรับสัญญาณ USB
- M. หัวต่อสาย USB
- N. สายพ่วง USB-C to USB-A



รายละเอียดทางเทคนิค

โครงสร้างการใช้งาน: รองรับการใช้งานของผู้ใช้ได้อย่างเหมาะสม

เซ็นเซอร์: Pixart PMW3389

ความละเอียด: สูงสุด 16000 DPI

ความเร็ว: 450ips

การเร่งการประมวลผล: 50G

ปุ่มสั่งการ: 6

สวิตช์ปุ่มสั่งการซ้ายและขวา: Omron

ความทนทานของปุ่มสั่งการซ้ายและขวา: กดใช้งานได้ 50 ล้านครั้ง

เอฟเฟกต์แสง: ต่อไฟ LED RGB¹

หน่วยความจำออนบอร์ด: 1 โพรไฟล์การทำงาน

ประเภทการเชื่อมต่อ: 2.4GHz ไร้สาย / ต่อสาย

เวลาใช้งานแบตเตอรี่²: 90 ชั่วโมง – LED ดับ / 50 ชั่วโมง – ค่าไฟ LED เริ่มต้น

ประเภทการชาร์จ: ระบบชาร์จไร้สาย Qi³ / ต่อสาย

อัตราการโพลล์: 1000Hz

ประเภทสายสัญญาณ: สายชาร์จ/สัญญาณถอดแยกได้

น้ำหนัก (ไม่มีสาย): 112 ก.

น้ำหนัก (มีสาย): 130 ก.

ขนาด (L x W x H): 124.8 x 73.9 x 43.6 มม.

ความยาวสาย: 1.8 ม.

¹ปรับแต่ง LED RGB ได้จากซอฟต์แวร์ HyperX NGENUITY

²เวลาใช้งานแบตเตอรี่พิจารณาจากการใช้งานและการประมวลผล

³ที่ชาร์จไร้สาย Qi จำหน่ายแยกต่างหาก



การติดตั้ง

โหมดไร้สาย

ต่อตัวรับสัญญาณ USB เข้ากับหัวต่อสาย USB และสายพ่วง USB-C to USB-A เข้าที่พอร์ต USB ของ PC เพื่อให้การติดตั้งสมบูรณ์ที่สุด กรุณาให้ตัวรับสัญญาณ USB ภายใต้อาณัติ 20 ซม. จากเมาส์

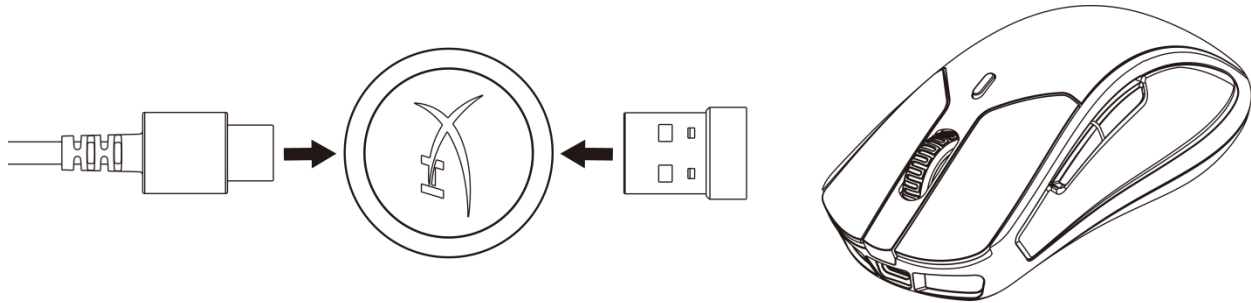

โหมดต่อสาย

ต่อสายพ่วง USB-C to USB-A ของคุณเข้ากับเมาส์ และที่พอร์ต USB ของ PC

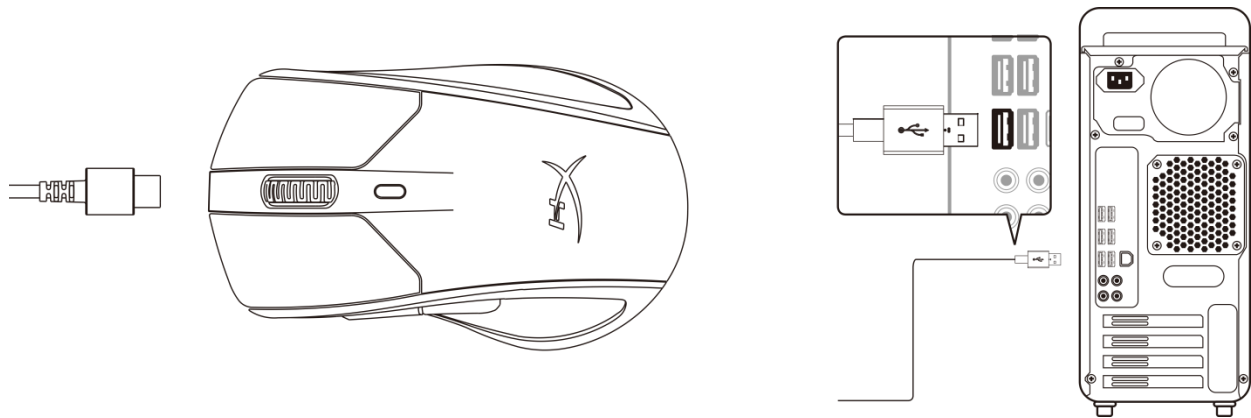



การชาร์จ ระบบชาร์จไร้สาย

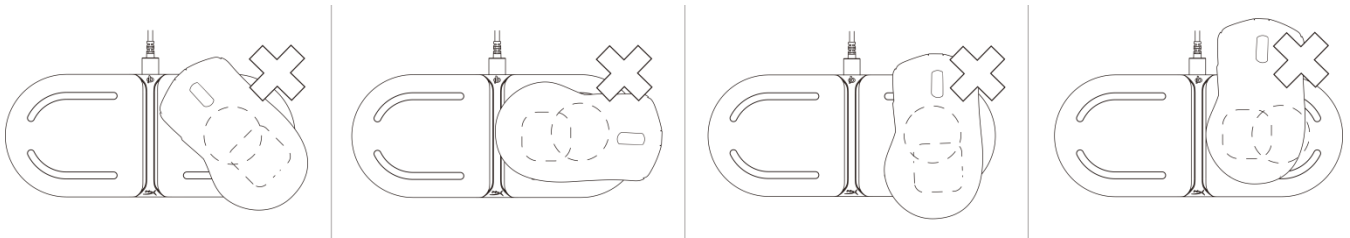
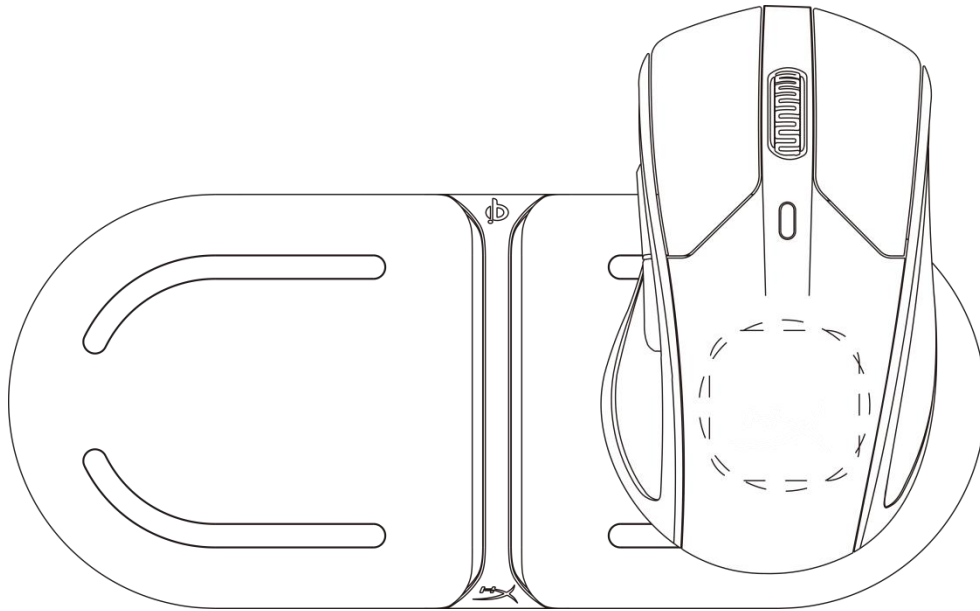

*ไม่รวมฐานชาร์จ

ระบบชาร์จต่อสาย

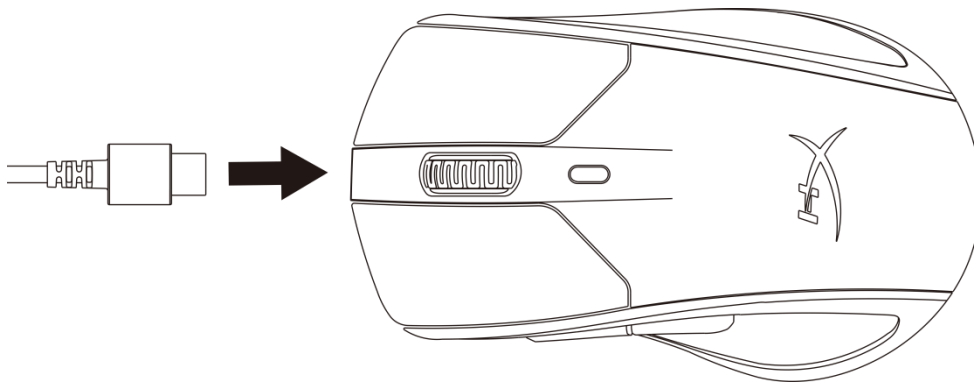



ปุ่มฟังก์ชัน

ปุ่มฟังก์ชัน	คุณสมบัติเด่นเพิ่มเติม
ปุ่ม DPI	ปรับระหว่างค่า DPI สำเร็จต่าง ๆ ที่มี ค่าเริ่มต้นคือ: <ul style="list-style-type: none"> - 800 DPI (น้ำเงิน) - 1600 DPI (เหลือง) - 3200 DPI (เขียว)

ซอฟต์แวร์ HyperX NGenuity

ปรับไฟส่องสว่าง ค่า DPI สำเร็จและค่ามาโครโดยดาวน์โหลดซอฟต์แวร์ HyperX NGenuity ที่นี่: hyperxgaming.com/ngenuity.

การใช้งานกับเครื่องเล่นเกม

ต่อเข้ากับ PS4 หรือ Xbox One โดยใช้สาย USB หรือชุดต่อดองเกิลที่จัดมาให้

รีเซ็ตเป็นค่าจากโรงงาน

หากคุณพบปัญหาใด ๆ กับเมาส์ สามารถทำการรีเซ็ตเป็นค่าจากโรงงาน หน่วยความจำในตัวจะถูกล้างข้อมูล ค่าทั้งหมดจะย้อนกลับเป็นค่าเริ่มต้น

ปุ่มฟังก์ชัน	คุณสมบัติเด่นเพิ่มเติม
กดปุ่ม DPI + ปุ่มล้อเลื่อนของเมาส์ค้างไว้ 5 วินาที	ทำการรีเซ็ตเป็นค่าจากโรงงานจากเมาส์

มีข้อสงสัยหรือปัญหาในการติดตั้งหรือไม่

ติดต่อทีมงานให้บริการของ HyperX ได้ที่: hyperxgaming.com/support/



HyperX Pulsefire Dart[™]



Mã sản phẩm

HX-MC006B



MỤC LỤC

Tổng quan	3
Thông số kỹ thuật.....	4
Lắp đặt.....	5
Chế độ không dây.....	5
Chế độ có dây	5
Sạc	6
Sạc không dây	6
Sạc có dây	6
Các phím chức năng	7
Phần mềm HyperX NGENUITY	7
Sử dụng với máy chơi game	7
Đặt lại mặc định	7



Tổng quan

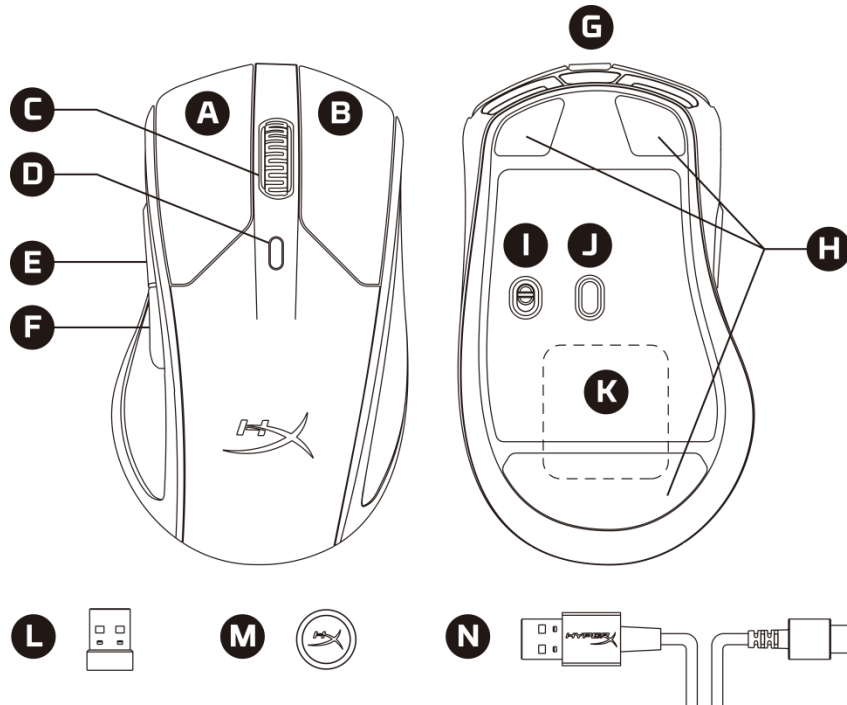

- A. Nút nhấn trái
- B. Nút nhấn phải
- C. Nút cuộn chuột
- D. Nút DPI
- E. Nút nhấn tới
- F. Nút nhấn lui
- G. Cổng USB-C
- H. Đế chuột
- I. Công tắc nguồn
- J. Cảm biến game quang học
- K. Mô-đun đầu nhận sạc không dây tích hợp sẵn
- L. Đầu nhận USB
- M. Bộ chuyển đổi cáp USB
- N. Cáp mở rộng USB-C sang USB-A



Thông số kỹ thuật

Thiết kế công thái học: Thiết kế công thái học

Cảm biến: Pixart PMW3389

Độ phân giải: Lên tới 16.000 DPI

Tốc độ: 450ips

Gia tốc: 50G

Nút: 6

Nút trái / phải: Omron

Độ bền của nút trái / phải: 50 triệu lần bấm

Hiệu ứng ánh sáng: Chiếu sáng RGB theo từng LED¹

Bộ nhớ riêng: 1 cấu hình

Loại kết nối: Không dây 2,4 GHz / có dây

Thời lượng pin²: 90 giờ – LED tắt / 50 giờ – Ánh sáng LED mặc định

Loại sạc: Sạc không dây Qi³ / có dây

Tốc độ lấy tín hiệu: 1.000 Hz

Loại cáp: Cáp sạc/dữ liệu có thể tháo rời

Trọng lượng (không có cáp): 112 g

Trọng lượng (có cáp): 130 g

Kích thước (D x R x C): 124,8 mm x 73,9 mm x 43,6 mm

Chiều dài dây cáp: 1,8 m

¹Ánh sáng RGB chỉnh được cho từng LED bằng phần mềm HyperX NGENUITY.

²Thời lượng pin khác nhau dựa trên điều kiện sử dụng và tính toán.

³Bộ sạc không dây Qi được bán riêng.



Lắp đặt

Chế độ không dây

Kết nối đầu nhận USB với bộ chuyển đổi cáp USB, và cáp mở rộng USB-C sang USB-A với cổng USB trên PC. Để sắp đặt tối ưu, vui lòng giữ đầu USB cách chuột trong vòng 20cm.

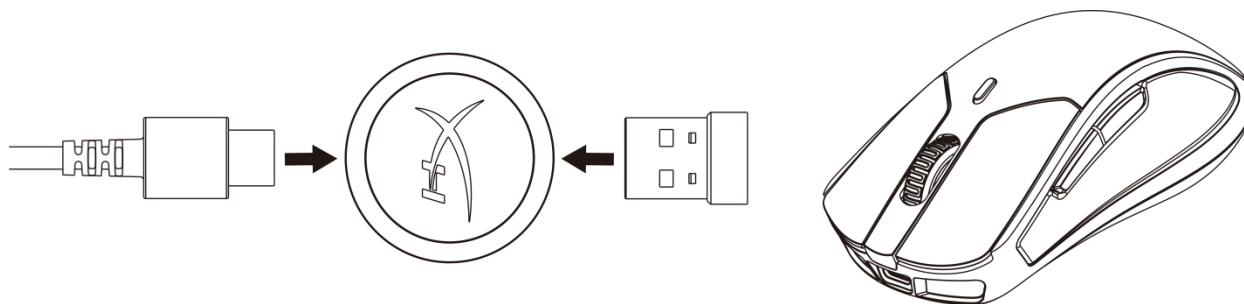

Chế độ có dây

Kết nối cáp mở rộng USB-C sang USB-A với chuột của bạn và với cổng USB của PC.

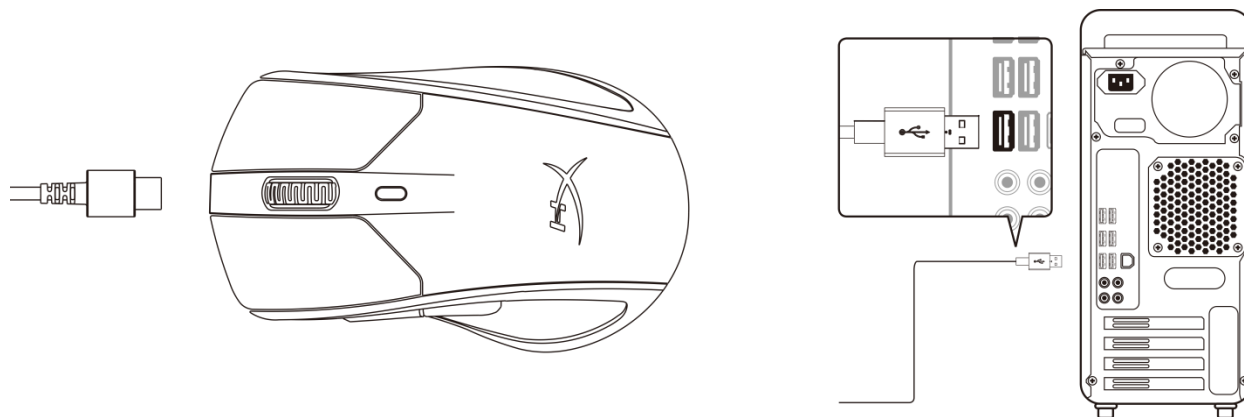



Sạc

Sạc không dây

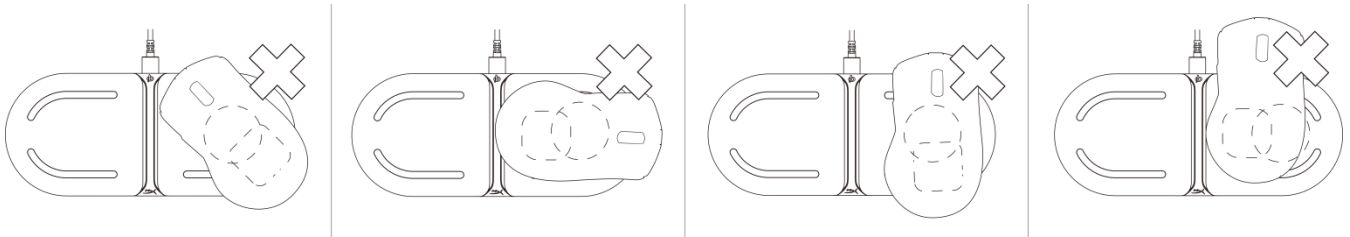
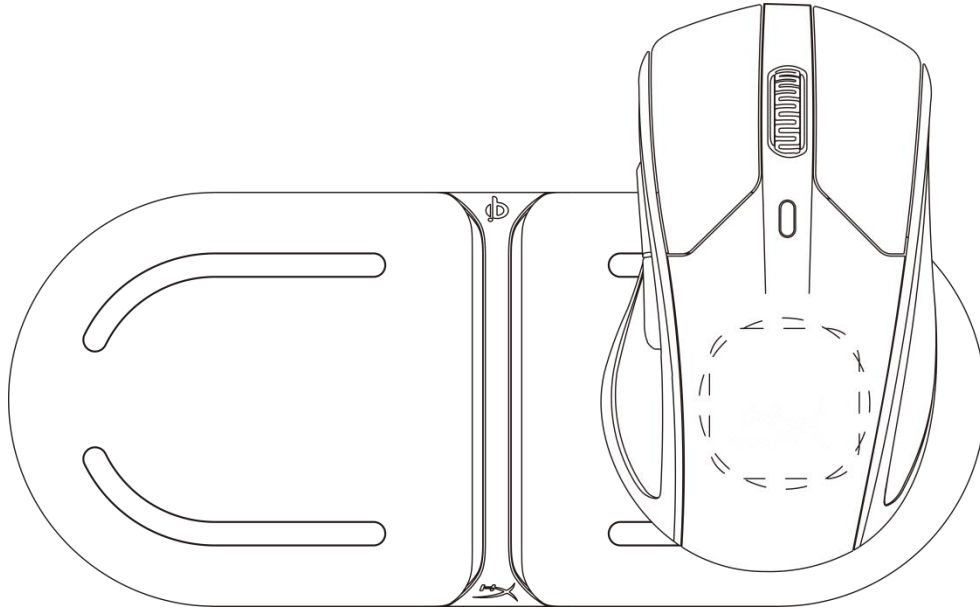

*Không bao gồm đế sạc

Sạc có dây

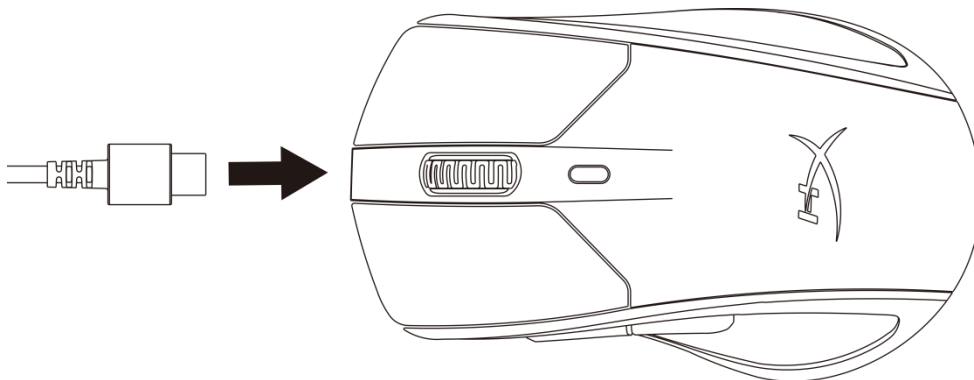



Các phím chức năng

Các phím chức năng	Tính năng phụ
Nút DPI	Thay đổi giữa các cấu hình DPI đặt sẵn. Các giá trị mặc định là: <ul style="list-style-type: none">- 800 DPI (xanh lam).- 1.600 DPI (vàng).- 3.200 DPI (xanh lục).

Phần mềm HyperX NGENUITY

Để tùy biến ánh sáng, DPI và cài đặt macro, hãy tải xuống phần mềm HyperX NGENUITY tại đây: hyperxgaming.com/ngenuity.

Sử dụng với máy chơi game

Kết nối với PS4 hoặc Xbox One sử dụng cáp USB đi kèm hoặc gắn dongle.

Đặt lại mặc định

Nếu gặp bất kỳ sự cố nào với chuột, bạn có thể đặt về thiết lập ban đầu. Bộ nhớ riêng sẽ bị xóa và tất cả các cài đặt sẽ khôi phục về mặc định.

Các phím chức năng	Tính năng phụ
Giữ nút DPI + nút cuộn chuột xuống trong 5 giây	Thực hiện đặt lại mặc định trên chuột.

Có câu hỏi hay gặp vấn đề về cài đặt?

Liên hệ nhóm hỗ trợ HyperX tại: hyperxgaming.com/support/



HyperX Pulsefire Dart™



产品型号

HX-MC006B



目录

概述	3
规格	4
安装	5
无线模式	5
有线模式	5
正在充电	6
无线充电	6
有线充电	6
功能键.....	7
HyperX NGENUITY 软件	7
与控制台一起使用.....	7
出厂重置.....	7



概述

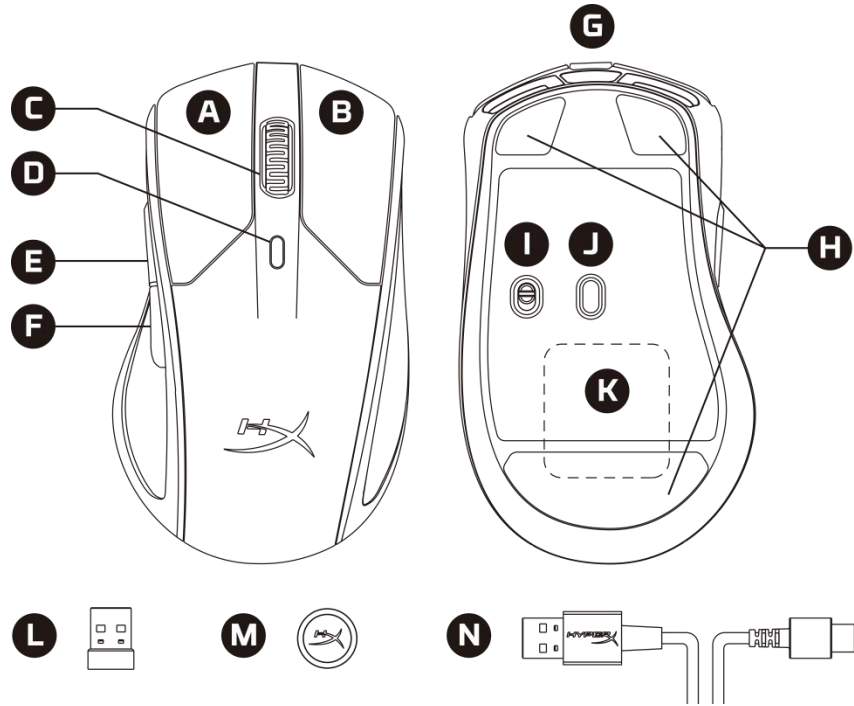

- A. 左键单击按钮
- B. 右键单击按钮
- C. 鼠标滚轮
- D. DPI 按钮
- E. 前进单击按钮
- F. 后退单击按钮
- G. USB-C 端口
- H. 鼠标脚贴
- I. 电源开关
- J. 光学游戏传感器
- K. 内置无线充电接收器模块
- L. USB 接收器
- M. USB 线缆适配器
- N. USB-C 到 USB-A 延长线



规格

人体工学：人体工学

传感器：Pixart PMW3389

分辨率：最高 16000 DPI

速度：450ips

加速度：50G

按钮：6

左/右按钮开关：Omron

左/右按钮耐用性：5000 万次单击

灯光效果：每个 LED 的 RGB 灯光¹

板载内存：1 个配置文件

连接类型：2.4GHz 无线/有线

电池寿命²：90 小时 – LED 关闭/ 50 小时 – 默认 LED 灯光

充电类型：无线 Qi 充电³/有线

轮询率：1000Hz

线缆类型：可拆卸的充电/数据线

重量（不含线缆）：112g

重量（含线缆）：130g

尺寸（L x W x H）：124.8 毫米 x 73.9 毫米 x 43.6 毫米

线缆长度：1.8 米

¹ 利用 HyperX NGENUITY 软件为每个 LED 定制 RGB 灯效。

² 电池寿命会因使用情况和计算条件而异。

³ Qi 无线充电器单独出售。



安装

无线模式

将您的 USB 接收器连接到 USB 线缆适配器，并将 USB-C 到 USB-A 延长线连接到 PC USB 端口。为实现优化配置，请将 USB 接收器放在距离鼠标 20 厘米的范围之内。

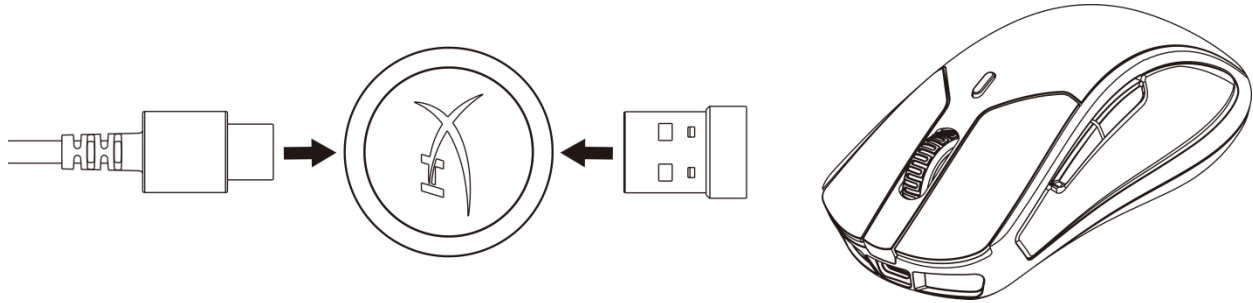

有线模式

将 USB-C 到 USB-A 延长线连接到鼠标和 PC USB 端口。

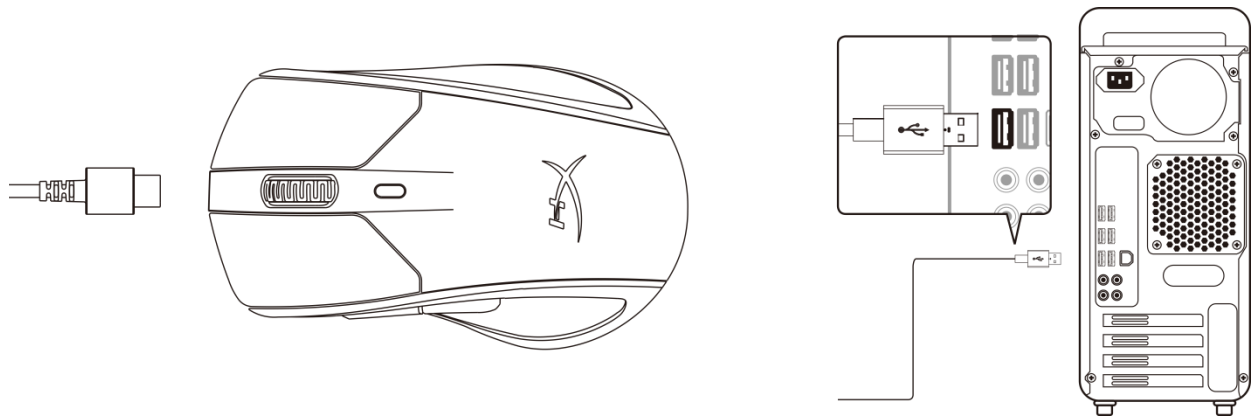



正在充电

无线充电

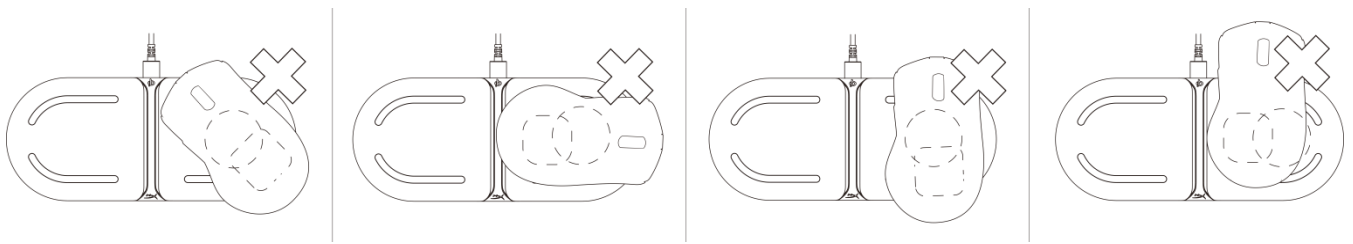
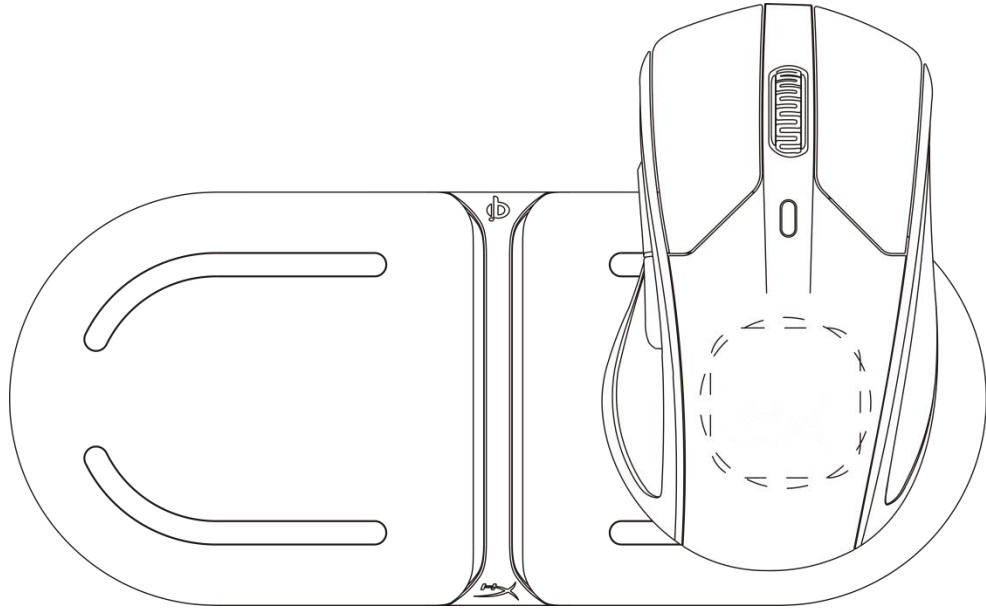

*不含充电底座

有线充电

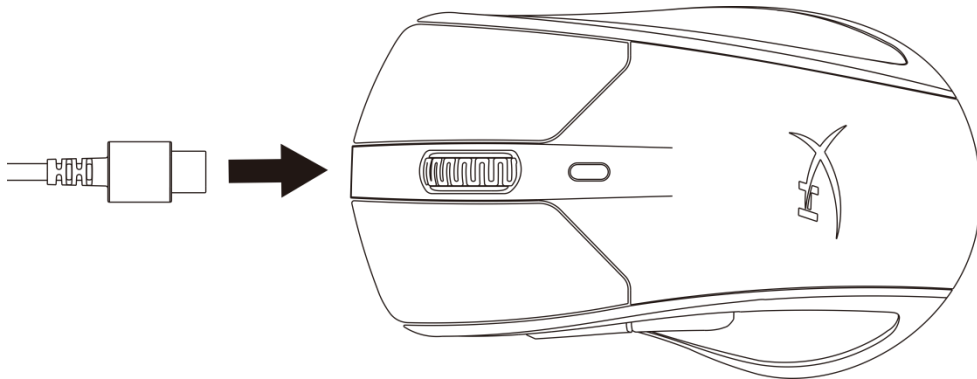



功能键

功能键	次要功能
DPI 按钮	更改 DPI 预先设置。默认值为： <ul style="list-style-type: none">- 800 DPI（蓝色）。- 1600 DPI（黄色）。- 3200 DPI（黄色）。

HyperX NGENUITY 软件

要定制灯光、DPI 和宏设置，请在此处下载 HyperX NGENUITY 软件：hyperxgaming.com/ngenuity。

与控制台一起使用

时用随附的 USB 线缆或加密狗附件连接至 PS4 或 Xbox One。

出厂重置

如果遇到任何鼠标问题，可以执行恢复出厂设置。板载内存会被清除，所有设置都会恢复成默认设置。

功能键	次要功能
按住 DPI 按钮 + 鼠标滚轮按钮 5 秒钟	对鼠标执行出厂重置。

存有疑问或遇到设置问题？

请联系 HyperX 支持团队：hyperxgaming.com/support/



HyperX Pulsefire Dart[™]



產品型號

HX-MC006B



目錄

概覽	3
產品規格	4
安裝	5
無線模式	5
有線模式	5
充電中.....	6
無線充電	6
有線充電	6
功能鍵.....	7
HyperX NGENUITY 軟體	7
使用於主機.....	7
還原原廠設定	7



概覽

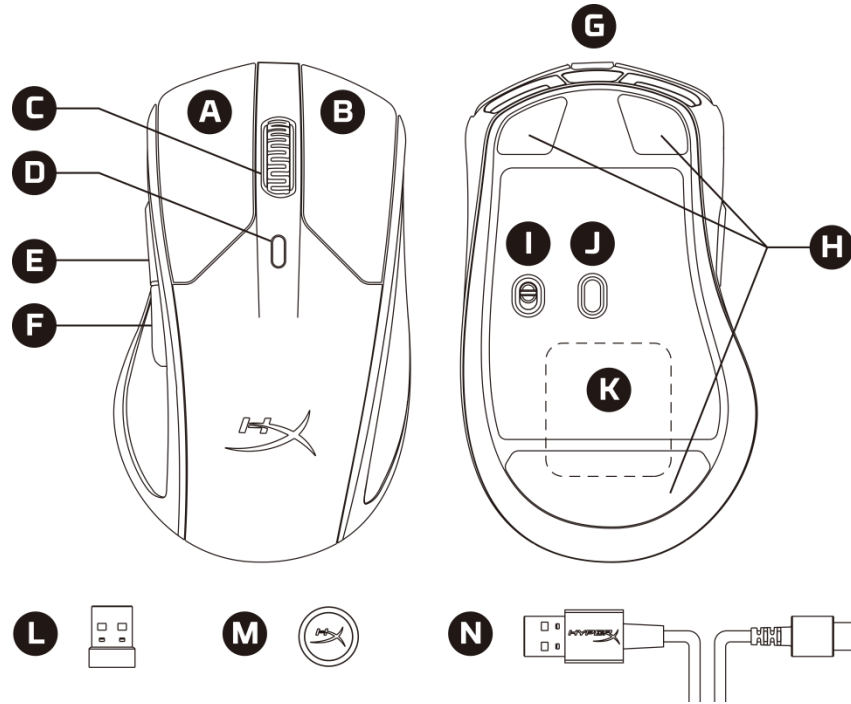

- A. 左鍵
- B. 右鍵
- C. 滑鼠滾輪
- D. DPI 鍵
- E. 前進鍵
- F. 後退鍵
- G. USB-C port 連接埠
- H. 鼠腳
- I. 電源開關
- J. 光學電競感測器
- K. 內建無線充電接收模組
- L. USB 接收器
- M. USB 線連接埠
- N. USB-C 轉 USB-A 延長線



產品規格

人體工學：人體工學

感測器：Pixart PMW3389

解析度：高達 16000 DPI

速度：450ips

加速度：50G

按鍵：6

左/右鍵微動開關：Omron

左/右鍵耐用性：5000 萬次點擊

燈效：個別 LED RGB 燈效¹

內建記憶體：1 組設定檔

接頭類型：2.4GHz 無線 / 有線

電池續航力²：90 小時 – LED 關閉 / 50 小時 – 預設 LED 燈效

充電類型：無線 Qi 充電³ / 有線

回報率：1000Hz

連接線類型：可拆式充電/傳輸線

重量（不含線）：112g

重量（含線）：130g

尺寸（長 x 寬 x 高）：124.8mm x 73.9mm x 43.6mm

線長：1.8m

¹ 個別 LED RGB 可透過 HyperX NGENUITY 軟體自訂燈效。

² 電池續航力依使用狀況而有所不同。

³ Qi 無線充電板需另購。



安裝

無線模式

將您的 USB 接收器連接至 USB 線轉接器，並且將 USB-C 轉 USB-A 延長線連接至電腦的 USB 連接埠。為了最好的使用體驗，請確保 USB 接收器與滑鼠距離在 20 公分範圍內。

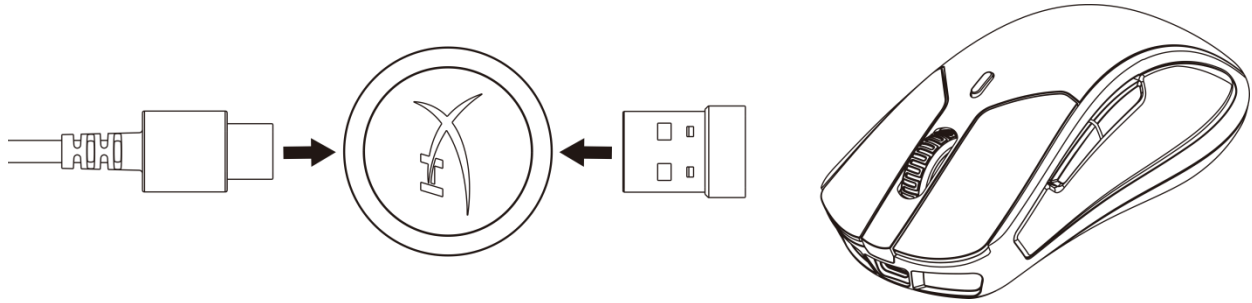

有線模式

將您的 USB-C 轉 USB-A 延長線連接至滑鼠，並連接到電腦的 USB 連接埠。

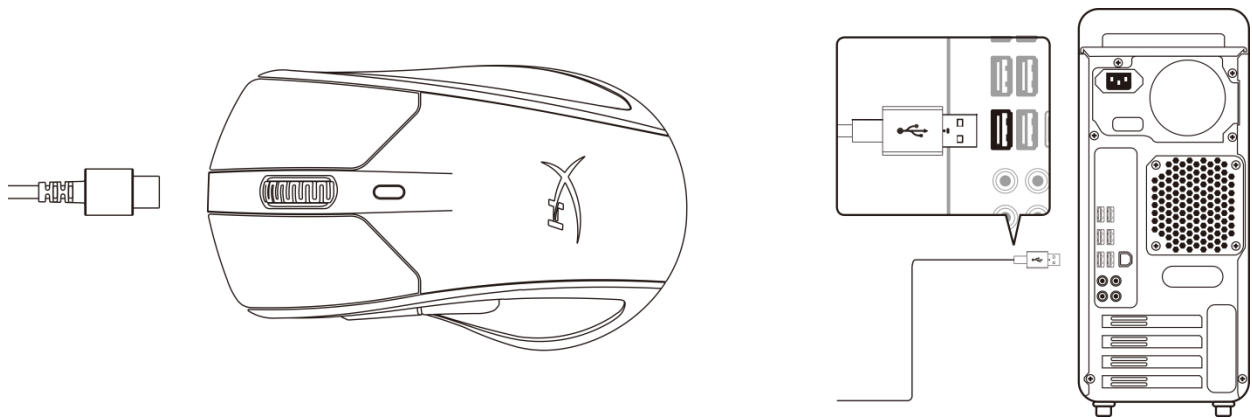



充電中

無線充電

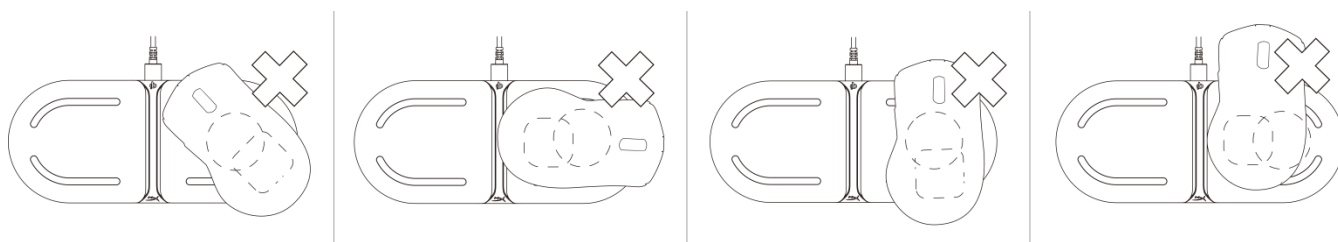
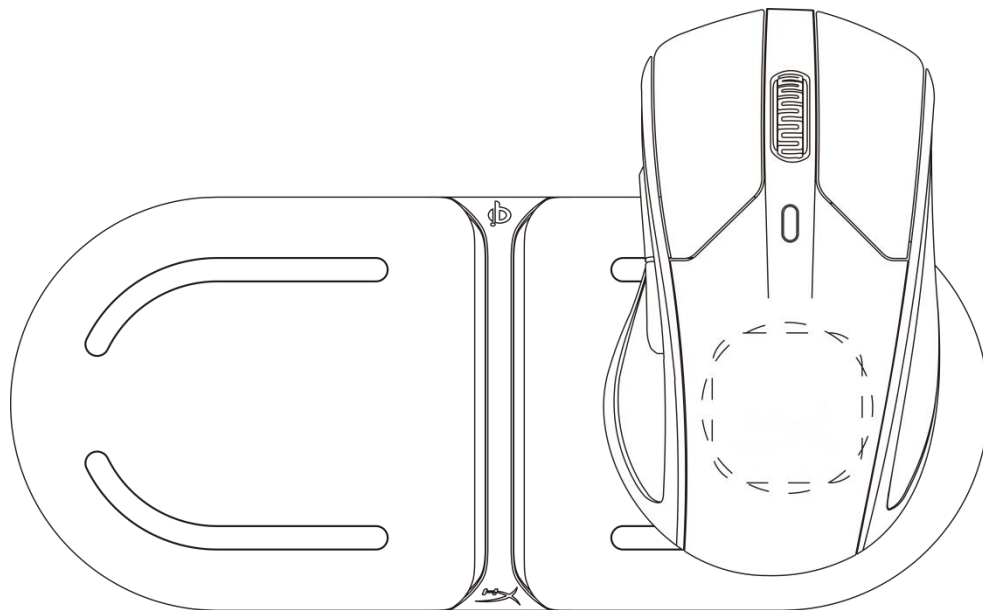

*充電座需另購

有線充電

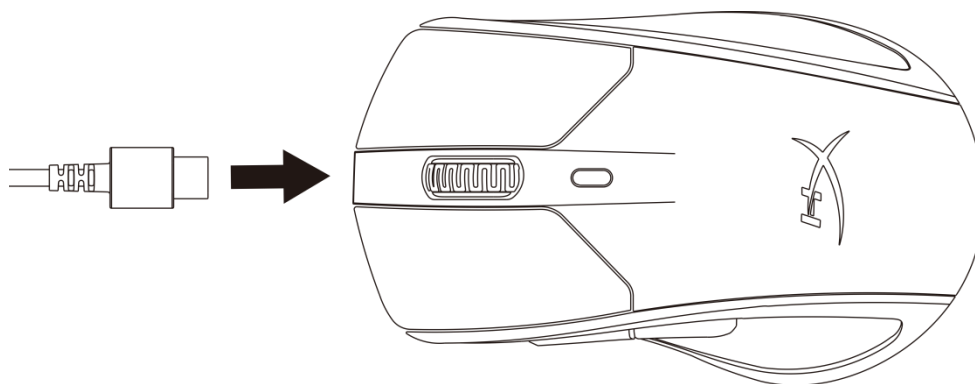



功能鍵

功能鍵	輔助功能
DPI 鍵	切換 DPI 預設值。預設值為： <ul style="list-style-type: none"> - 800 DPI (藍色)。 - 1600 DPI (黃色)。 - 3200 DPI (綠色)。

HyperX NGENUITY 軟體

若要自訂燈光效果、DPI 和巨集設定，請於以下連結下載 HyperX NGENUITY 軟體：
hyperxgaming.com/ngenuity。

使用於主機

使用隨附的 USB 線或附加轉接器連接至 PS4 或 Xbox One。

還原原廠設定

如果您在使用滑鼠時遇到任何問題，可以嘗試將滑鼠還原為原廠設定。裝置的內建記憶資料將會被清除，所有設定會還原至原廠設定。

功能鍵	輔助功能
長按 DPI 鍵 + 滑鼠滾輪 5 秒	將滑鼠還原原廠設定。

是否有問題或設定困難？

請聯絡 HyperX 支援小組：hyperxgaming.com/support/