



Questo manuale d'istruzione è fornito da trovaprezzi.it. Scopri tutte le offerte per [IP-Com CPE9](#) o cerca il tuo prodotto tra le [migliori offerte di Altri dispositivi di rete](#)



Questo manuale d'istruzione è fornito da trovaprezzi.it. Scopri tutte le offerte per [IP-Com CPE9](#) o cerca il tuo prodotto tra le [migliori offerte di Wireless e Bluetooth](#)

[www.ip-com.com.cn](http://www.ip-com.com.cn)

# User Guide

Outdoor Point to Point CPE

**IP-COM**  
World Wide Wireless

## Copyright Statement

©2018 IP-COM Networks Co., Ltd. All rights reserved.

**IP-COM** is the registered trademark of IP-COM Networks Co., Ltd. Other brand and product names mentioned herein are trademarks or registered trademarks of their respective holders. Copyright of the whole product as integration, including its accessories and software, belongs to IP-COM Networks Co., Ltd. No part of this publication can be reproduced, transmitted, transcribed, stored in a retrieval system, or translated into any language in any form or by any means without the prior written permission of IP-COM Networks Co., Ltd.

## Disclaimer

Pictures, images and product specifications herein are for references only. To improve internal design, operational function, and/or reliability, IP-COM reserves the right to make changes to the products described in this document without obligation to notify any person or organization of such revisions or changes. IP-COM does not assume any liability that may occur due to the use or application of the product or circuit layout(s) described herein. Every effort has been made in the preparation of this document to ensure accuracy of the contents, but all statements, information and recommendations in this document do not constitute the warranty of any kind, express or implied.

## Preface

Thank you for choosing IP-COM! Please read this user guide before you start



This user guide applies to CPE3 and CPE9. In the following content, we take the figures and web UI of CPE9 as examples.

## Conventions

The typographical elements that may be found in this document are defined as follows.

| Item                | Presentation | Example  |
|---------------------|--------------|--|
| Cascading menus     | >            | <b>System &gt; Live Users</b>                          |
| Parameter and value | Bold         | Set <b>User Name</b> to <b>Tom</b> .                   |
| Variable            | Italic       | Format: <i>XX:XX:XX:XX:XX:XX</i>                       |
| UI control          | Bold         | On the <b>Policy</b> page, click the <b>OK</b> button. |

The symbols that may be found in this document are defined as follows.

| Symbol  | Meaning  |
|---|--|
|  | This format is used to highlight information of importance or special interest. Ignoring this type of note may result in ineffective configurations, loss of data or damage to device. |
|  | This format is used to highlight a procedure that will save time or resources.   |

## Acronyms and Abbreviations

| Acronym or Abbreviation | Full Spelling                       |
|-------------------------|-------------------------------------|
| AP                      | Access Point                        |
| ARP                     | Address Resolution Protocol         |
| AES                     | Advanced Encryption Standard        |
| CPE                     | Customer Premises Equipment         |
| CCQ                     | Client Connection Quality           |
| DHCP                    | Dynamic Host Configuration Protocol |
| DNS                     | Domain Name System                  |
| DDNS                    | Dynamic Domain Name Server          |
| GMT                     | Greenwich Mean Time                 |
| IP                      | Internet Protocol                   |

| <b>Acronym or Abbreviation</b> | <b>Full Spelling</b>                       |
|--------------------------------|--|
| ICMP                           | Internet Control Message Protocol          |
| TKIP                           | Temporal Key Integrity Protocol            |
| LAN                            | Local Area Network                         |
| MAC                            | Media Access Control                       |
| PoE                            | Power Over Ethernet                        |
| P2MP                           | Point-to-MultiPoint                        |
| PVID                           | Port-based VLAN ID                         |
| RADIUS                         | Remote Authentication Dial In User Service |
| SSID                           | Service Set Identifier                     |
| TCP                            | Transmission Control Protocol              |
| UDP                            | User Datagram Protocol                     |
| VLAN                           | Virtual Local Area Network                 |
| WAN                            | Wide Area Network                          |
| WLAN                           | Wireless Local Area Networks               |
| WEP                            | Wired Equivalent Privacy                   |
| WPA-PSK                        | WPA-Preshared Key                          |
| WPA                            | Wi-Fi Protected Access                     |
| WMM                            | Wi-Fi multi-media                          |

## Additional Information

For more information, search this product model on our website at <http://www.ip-com.com.cn>.

## Technical Support

If you need more help, contact us by any of the following means. We will be glad to assist you as soon as possible.



+86-755-27653089



[info@ip-com.com.cn](mailto:info@ip-com.com.cn)



<http://www.ip-com.com.cn>

---

# Contents

|          |  |           |
|----------|--|-----------|
| <b>1</b> | <b>Introduction.....</b>                         | <b>1</b>  |
|          | 1.1 Overview.....                                | 1         |
|          | 1.2 Getting to Know Your Device.....             | 1         |
| <b>2</b> | <b>Application Scenario.....</b>                 | <b>7</b>  |
|          | 2.1 ISP Hotspot Connection-WISP Mode.....        | 7         |
|          | 2.2 CCTV Surveillance.....                       | 13        |
| <b>3</b> | <b>Web UI.....</b>                               | <b>21</b> |
|          | 3.1 Login.....                                   | 21        |
|          | 3.2 Logout.....                                  | 23        |
|          | 3.3 Web UI Layout.....                           | 23        |
|          | 3.4 Common Buttons.....                          | 24        |
| <b>4</b> | <b>Quick Setup.....</b>                          | <b>25</b> |
|          | 4.1 AP Mode.....                                 | 25        |
|          | 4.2 Client Mode.....                             | 28        |
|          | 4.3 Universal Repeater Mode (Only for CPE9)..... | 32        |
|          | 4.4 WISP Mode.....                               | 36        |
|          | 4.5 Repeater Mode (Only for CPE9).....           | 41        |
|          | 4.6 P2MP Mode (Only for CPE9).....               | 51        |
|          | 4.7 Router Mode (Only for CPE9).....             | 59        |
| <b>5</b> | <b>Status.....</b>                               | <b>62</b> |
|          | 5.1 System Status.....                           | 62        |
|          | 5.2 Wireless Status.....                         | 64        |
|          | 5.3 Statistics.....                              | 65        |
| <b>6</b> | <b>Network.....</b>                              | <b>70</b> |
|          | 6.1 LAN Setup.....                               | 70        |
|          | 6.2 MAC Clone.....                               | 74        |
|          | 6.3 DHCP Server.....                             | 76        |
|          | 6.4 DHCP Client.....                             | 78        |
|          | 6.5 VLAN Settings.....                           | 79        |
| <b>7</b> | <b>Wireless.....</b>                             | <b>83</b> |
|          | 7.1 Basic.....                                   | 83        |
|          | 7.2 Advanced.....                                | 110       |
|          | 7.3 Access Control.....                          | 112       |

|          |   |            |
|----------|---|------------|
| <b>8</b> | <b>Advanced .....</b>                       | <b>116</b> |
|          | 8.1 LAN Rate .....                          | 116        |
|          | 8.2 Diagnose .....                          | 118        |
|          | 8.3 Bandwidth Control (Only for CPE9) ..... | 125        |
|          | 8.4 Port Forwarding (Only for CPE9).....    | 128        |
|          | 8.5 MAC Filter (Only for CPE9) .....        | 132        |
|          | 8.6 Network Service .....                   | 136        |
| <b>9</b> | <b>Tools .....</b>                          | <b>152</b> |
|          | 9.1 Date & Time .....                       | 152        |
|          | 9.2 Maintenance .....                       | 154        |
|          | 9.3 Account.....                            | 160        |
|          | 9.4 System Log .....                        | 162        |
|          | <b>Appendix .....</b>                       | <b>163</b> |
|          | A.1 FAQ.....                                | 163        |
|          | A.2 Default Parameters.....                 | 165        |

# 1 Introduction

## 1.1 Overview

The IP-COM outdoor point to point CPE is dedicated for WISP solutions and video surveillance in elevators, tower cranes, apartments, factories, orchards, and scenic areas. Featured the built-in high-gain antennas, and the refined exterior design, the device can be installed onto walls or poles, and offers strong and stable WiFi signals. The industry grade waterproof and dustproof housing allows it to work properly even in harsh environments. With auto-bridging technology, two CPEs can connect to each other automatically to make setup a breeze.

## 1.2 Getting to Know Your Device

### 1.2.1 Appearance of CPE3

#### LED Indicators

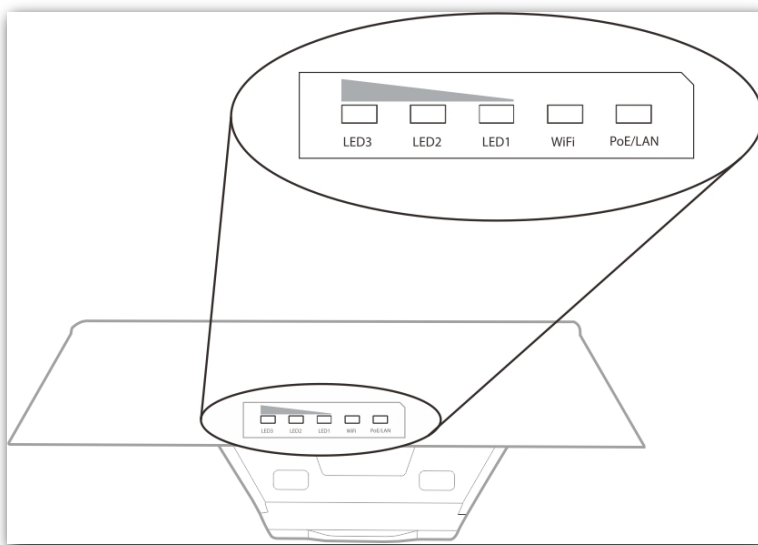

CPE3

| LED Indicator                             | Status   | Description  |
|---|----------|--|
| PoE/LAN                                   | Solid on | The device is being powered properly, and no data is being transmitted.  |
|   | Blinking | Data is being transmitted over the port.   |
|   | Off      | The device is not powered on.  |
| WiFi                                      | Solid on | The wireless function is enabled, but no data is being transmitted.  |
|   | Blinking | Data is being transmitted in a wireless manner.  |
|   | Off      | The wireless function is disabled.   |
| LED1, LED2, LED3<br>(Signal Strength LED) |          | Bridged successfully, and the device works in AP mode.<br>LED1, LED2 and LED3 are solid on: Perfect Signal   |
|   | Solid on | LED1 and LED2 are sold on, and LED3 is off: Good signal<br>LED1 is solid on, and LED2 and LED3 are off: Weak signal. Please adjust the direction or location of the two devices. |
|   | Blinking | Bridged successfully, and the device works in Client mode.   |
|   | Off      | The device does not bridge to another peer AP.   |

## Button and Ports

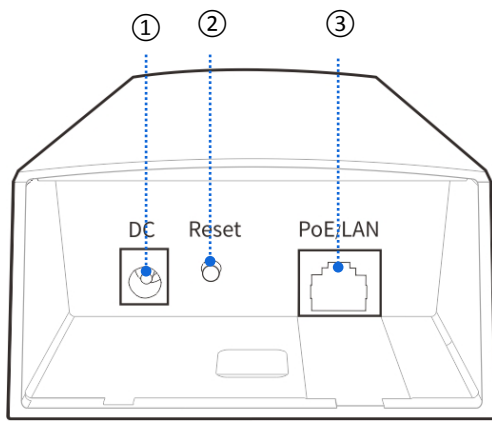

CPE3

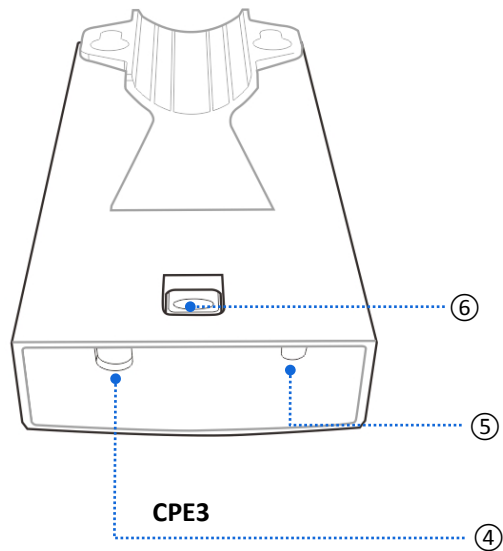

CPE3

| ID | Port/Button | Description  |
|----|-------------|--|
| ①  | DC          | Power Jack<br>Connect the included power adapter to this jack to supply power to the device.   |
| ②  | Reset       | Reset Button<br>After the device is powered on for 1 minute, hold down this button for about 7 |

| ID | Port/Button | Description  |
|----|-------------|--|
|    |             | seconds. When all the LED indicators on the device light up, the device is restored factory settings.  |
| ③  | PoE/LAN     | It is used to supply power or transmit data.<br>To power on the device using PoE, connect this port to the PoE port of the included PoE injector.<br>If the device is powered on using a DC power adapter, this port can be connected to a switch. |
| ④  | /           | Ethernet cable inlet.  |
| ⑤  | /           | Power cord inlet.  |
| ⑥  | /           | It is used to remove the cover.  |

## Label

The label on the back panel of the device presents the login IP address, username and password and other information of the device.

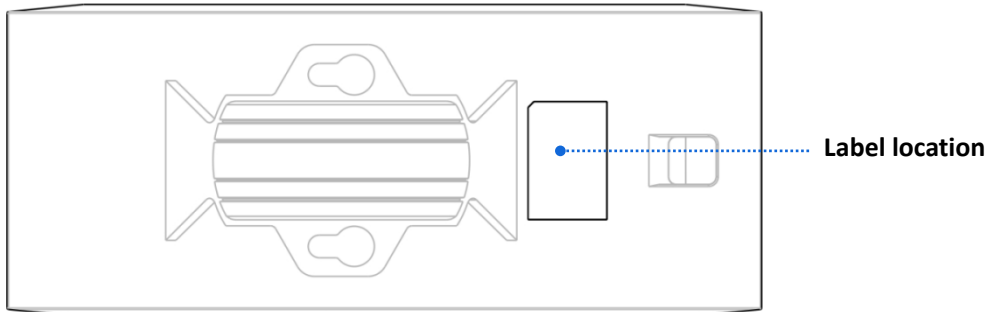

Product label

## 1.2.2 Appearance of CPE9

### LED Indicators

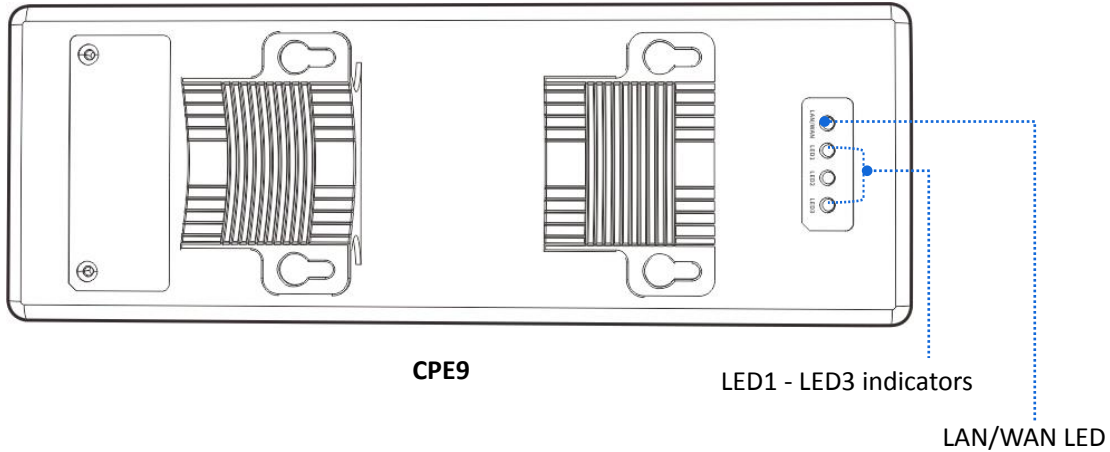

| LED Indicator                             | Status   | Description  |
|---|----------|--|
| LAN/WAN                                   | Solid on | The device is being powered properly, and no data is being transmitted.  |
|   | Blinking | Data is being transmitted over the port.   |
|   | Off      | The device is not powered on.  |
| LED1, LED2, LED3<br>(Signal Strength LED) | Solid on | <p>The device has wireless clients connected to it and may work in AP, Repeater, or Router mode. If you performed auto bridging, the device is already set to AP mode.</p> <p>LED1, LED2 and LED3 are solid on: Perfect Signal</p> <p>LED1 and LED2 are sold on, and LED3 is off: Good signal</p> <p>LED1 is solid on, and LED2 and LED3 are off: Weak signal. Please adjust the direction or location of the two devices.</p> |
|   | Blinking | The device is working in Client, Universal Repeater or WISP mode, and connected to a remote AP. If the device is automatically connected to the other one, it is set to Client mode.   |
|   | Off      | The device is not connected to a wireless client or a remote AP.   |
|   |          |  |

## Button and Ports

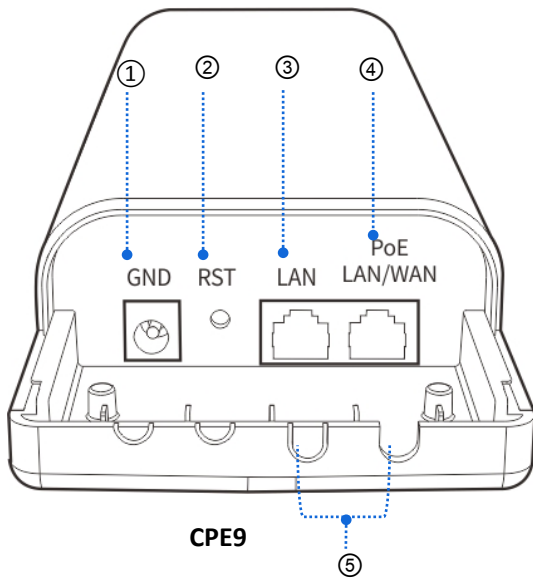

| ID | Port/Button | Description  |
|----|-------------|--|
| ①  | GND         | Grounding jack<br>Use the included grounding screw and cable to connect the device's grounding jack to a grounding terminal of building to avoid ESD and lightning damage to the device.             |
| ②  | RST         | Reset Button<br>After the device is powered on for 1 minute, hold down this button for about 8 seconds. When all the LED indicators on the device light up, the device is restored factory settings. |
| ③  | LAN         | 10/100 Mbps automatic negotiation RJ45 port.<br>Used to connect to a switch, computer, or other wired devices.   |
| ④  | PoE LAN/WAN | It is used to supply power or transmit data.<br>If the device works in Router mode, it is a WAN port. Otherwise, it is a LAN port.<br>Use the included PoE injector to supply power to the device.   |
| ⑤  | /           | Ethernet cable inlet.  |

## Label

The label on the back panel of the device presents the login IP address, username and password and other information of the device.

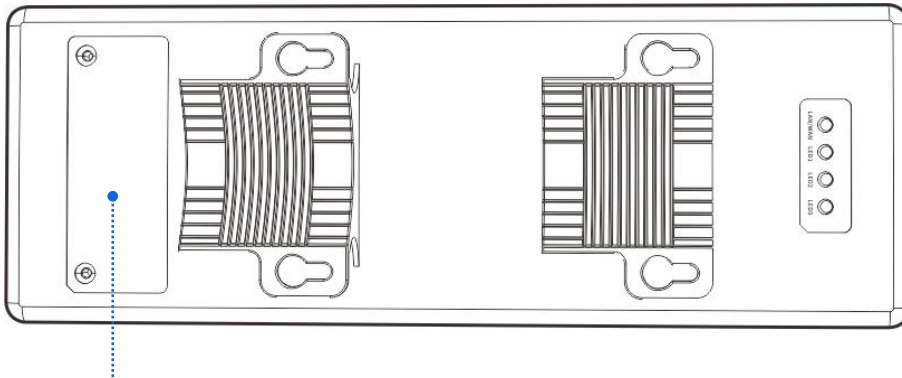

Label location

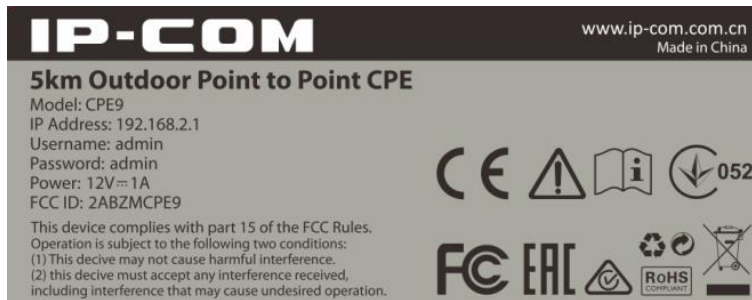

Product label

# 2 Application Scenario

## 2.1 ISP Hotspot Connection-WISP Mode

An apartment needs to bridge an ISP hotspot for internet access.

### 2.1.1 Solution

IP-COM CPE can address this requirement.

CPE9 is used as an example to illustrate the installation procedure. The installation procedure of **CPE3** is similar.

### 2.1.2 Setting up the CPE

1. Connect the computer to the CPE.
  - (1) Uncover the housing of the CPE.
  - (2) Use an Ethernet cable to connect the **PoE/LAN/WAN** port of the device to the **PoE** port of the PoE injector.
  - (3) Use the included power adapter to connect the PoE injector to a power socket. The **LAN/WAN** LED indicator of the CEP lights up.
  - (4) Use an Ethernet cable to connect your computer to the **LAN** port of the PoE injector.

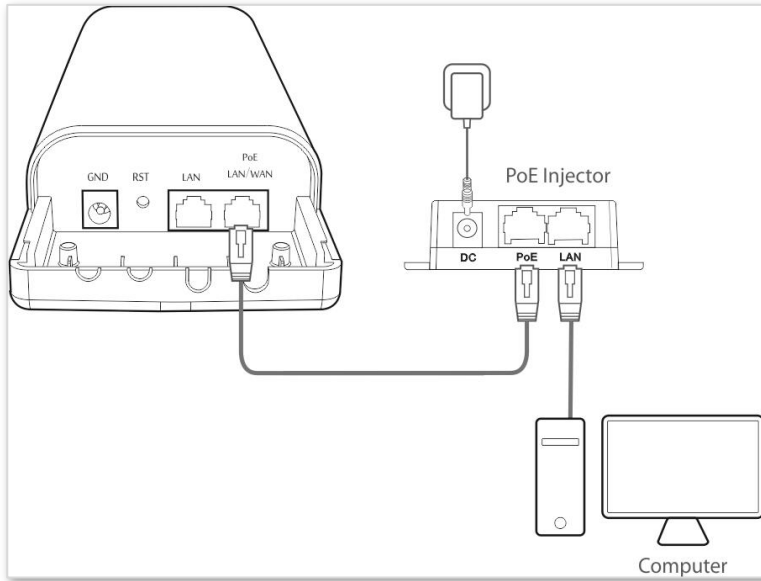

2. Set the CPE to **WISP** mode.

- (1) Start a web browser on your computer, and visit **192.168.2.1**. Enter your user name and password (default: **admin/admin**), and click **Login**.

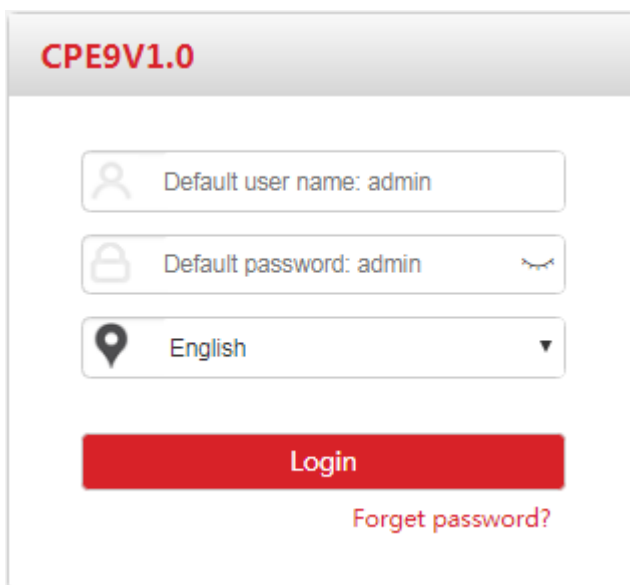

If this page does not appear, please refer to [Q1 in FAQ](#).

---

(2) Select **WISP**, and click **Next**.

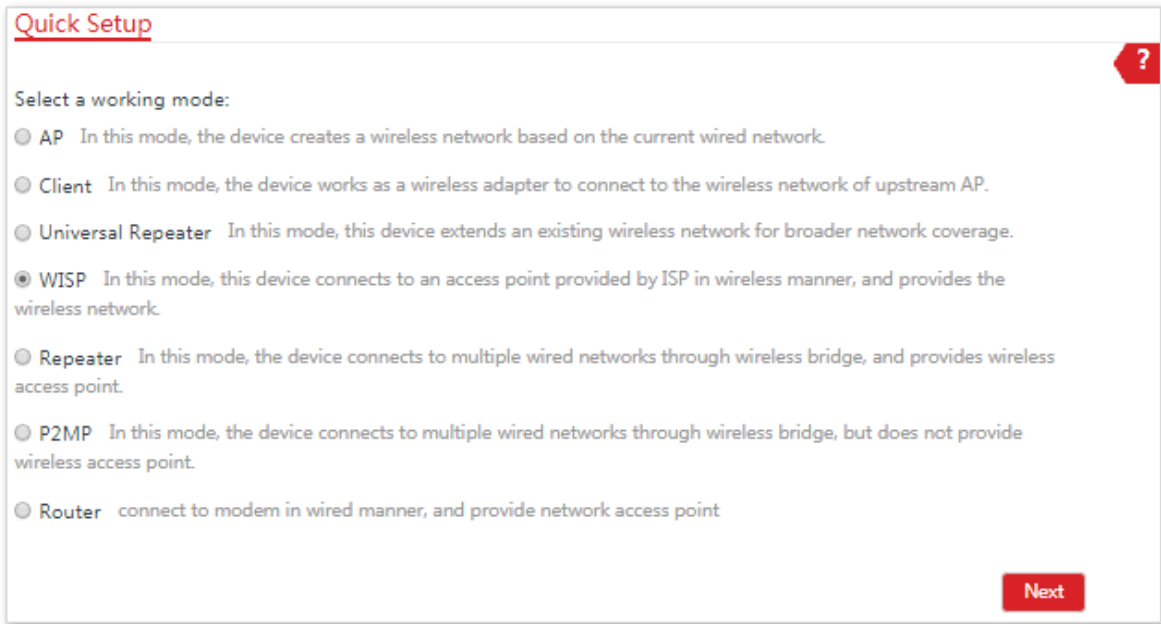

(3) Select the SSID of your ISP (Internet Service Provider) hotspot, which is **IP-COM\_123456** in this example, and click **Next**.

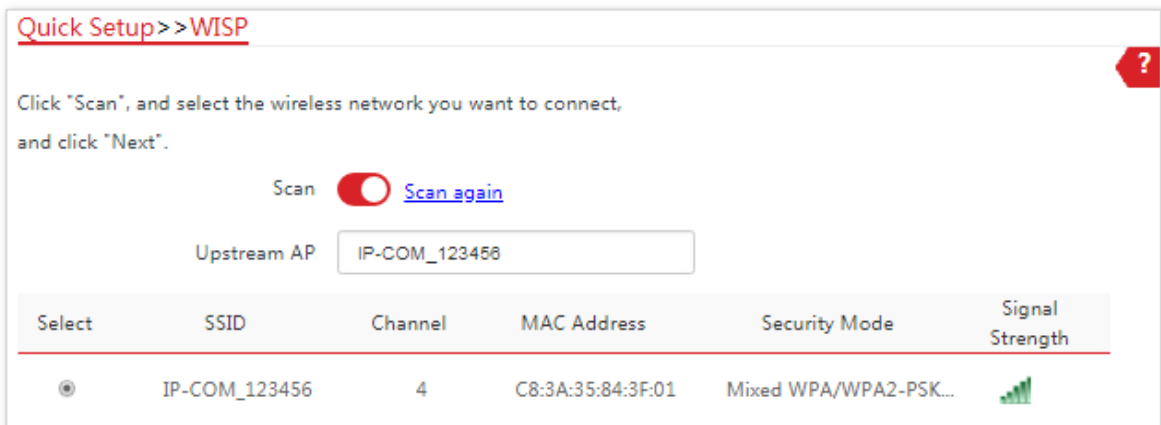

- (4) Enter the WiFi password of your ISP hotspot in the **Key** text box, and click **Next**.

**Quick Setup >> WISP** ?

Ensure that the device uses the same channel, encryption, and encryption algorithm as those of upstream AP.  
Then enter the remote AP's WiFi password, and click "Next" to continue.

Upstream AP IP-COM\_123456

Upstream AP MAC Address C8:3A:35:84:3F:01

Channel 4(2427) ▼

Security Mode Mixed WPA/WPA2-PSK ▼

Encryption Algorithm  AES  TKIP  TKIP&AES

Key .....

Previous Next

- (5) Select the Internet Connection Type of your ISP hotspot, which is **PPPoE** in this example. Enter the PPPoE user name and password provided by your ISP, and click **Next**.

**Quick Setup >> WISP** ?

Please select an internet connection type, and enter the internet parameters provided by your ISP.  
and click "Next".

Internet Connection Type  DHCP (Dynamic IP)  Static IP Address  PPPoE

PPPoE User Name

PPPoE Password

Previous Next

- (6) Customize the SSID and key, and click **Next**.

**Quick Setup >> WISP** ?

You can set up your wireless network name and wireless password here.  
Note down your wireless password.

SSID(WiFi Name)

Channel

Security Mode

Encryption Algorithm  AES  TKIP  TKIP&AES

Key

- (7) Set an IP address belonging to different network segment as that of your ISP hotspot. For example, if the IP address of your ISP hotspot is 192.168.2.1, you can set this device's IP address to 192.168.X.1 (X ranges from 0 to 254 excluding 2). Then click **Next**.

**Quick Setup >> WISP** ?

Specify the device with an IP address whose network segment is different from that of IP address of ISP access point or upstream AP.

IP Address

Subnet Mask

- (8) Click **Save**, and wait until the device reboots to activate the settings.

**Quick Setup >> WISP** ?

The device is set to WISP, click "Save" to apply the settings.

---End

When LED1, LED2, and LED3 of the device are blinking, the device is connected to your ISP hotspot successfully.

## 2.1.3 Installing the CPE

1. Place the device at an elevated position in the open air.

2. Uncover the housings of the device, and connect the **PoE/LAN/WAN** port of the device to the WAN port of your wireless router. The **LAN/WAN** LED indicator lights up.
3. Adjust the device's direction or location on the selected pole until the LED1, LED2 and LED3 of the device light up.
4. Use the plastic straps to attach the device to the pole.

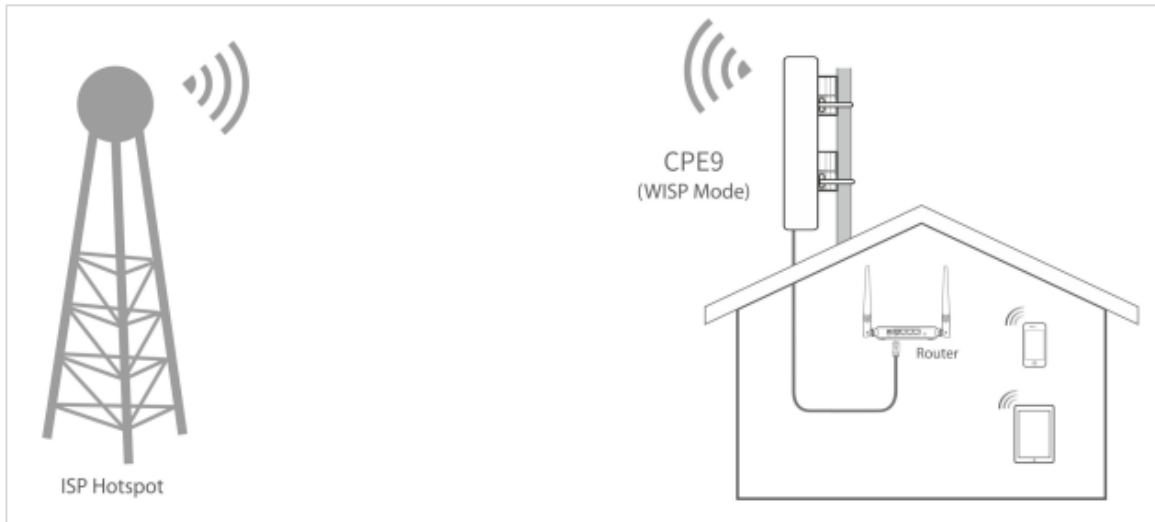

---End

## 2.2 CCTV Surveillance

To ensure the safety of employees and property, a video surveillance system needs to be installed in a building site.

### 2.2.1 Solution

IP-COM CPE can address this requirement.

CPE9 is used as an example to illustrate the installation procedure. The installation procedure of **CPE3** is similar.

### 2.2.2 Setting up the CPEs



At least two CPEs are required for bridging.

---

#### Method 1: Automatic Bridging (Recommended)

1. Place the two CPEs next to each other, see the following figure.

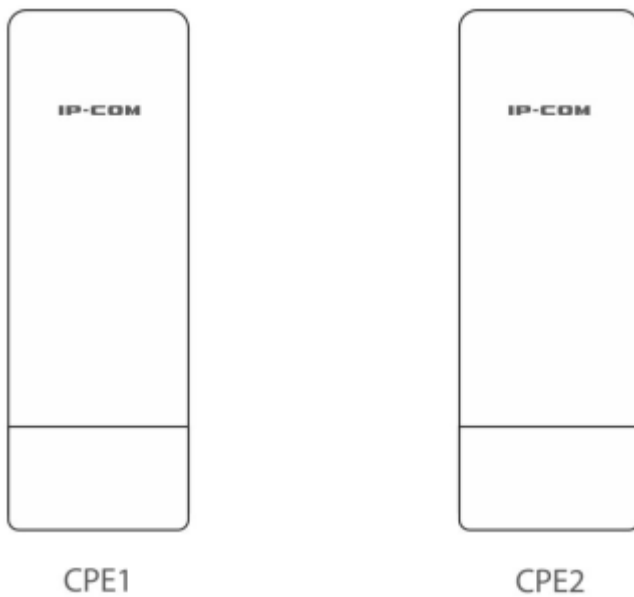

2. Remove the housing of each CPE, and use the included PoE injectors to power them on.

Wait until the **LAN/WAN** LED indicators of the CPEs light up.

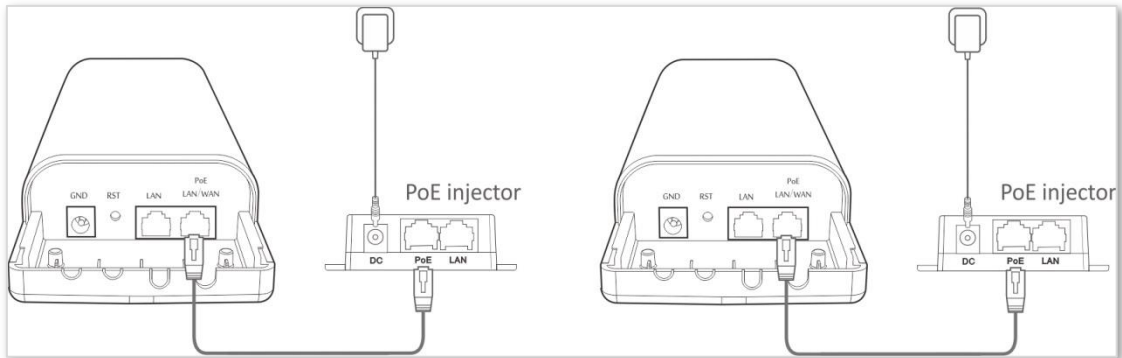

3. Wait for the two CPEs to negotiate and connect to each other automatically. The following LED indicator status indicates successful connection of the two CPEs.

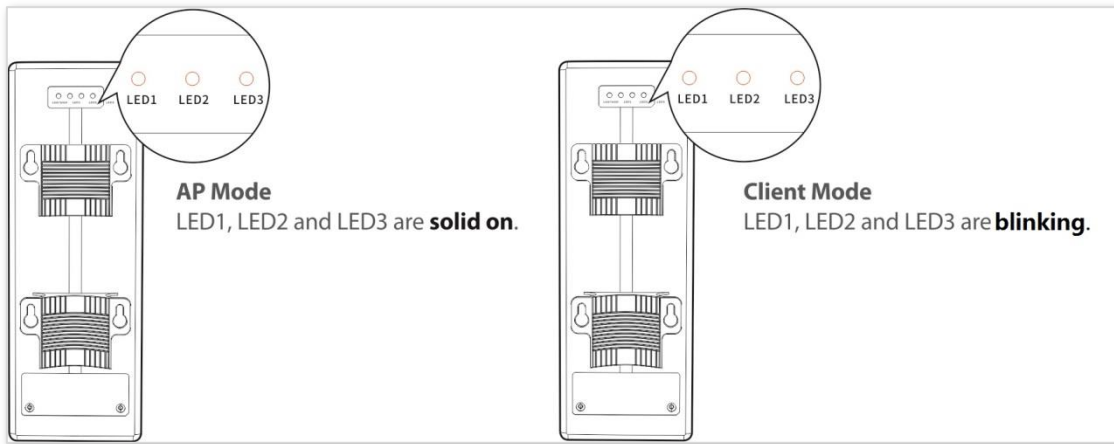

 Note

- Automatic Bridging is only applicable when the CPEs are in factory settings, and the bridging process lasts less than 1 minute after the CPEs are powered on.
- Automatic Bridging is only applicable to peer-to-peer bridging. If there are three or more powered CPEs nearby, automatic bridge fails. So if you want to perform peer-to-multi peer bridging, please refer to [Method 2: Set up the CPEs Using Web UI](#).
- If the bridging succeeds, the DHCP servers of the two CPEs are disabled, and the IP address of the CPE working in Client mode changes to 192.168.2.2.

---End

## Method 2 Set up the CPEs Using Web UI

1. Place the two CPEs next to each other.

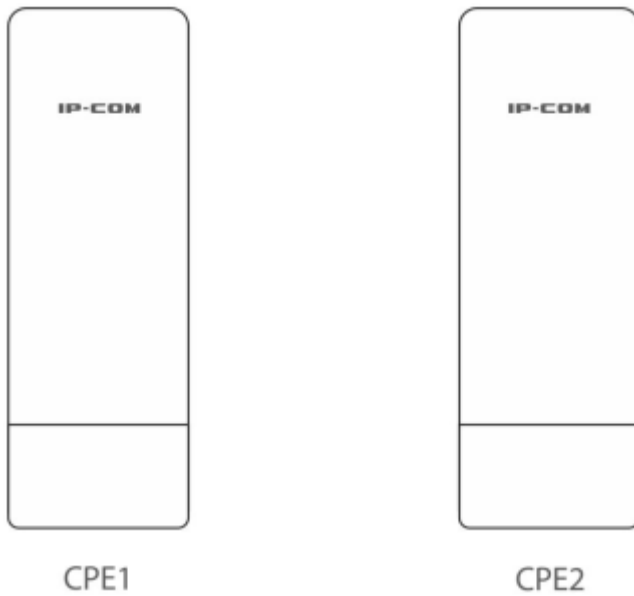

2. Connect the computer to **CPE1**.

- (1) Uncover the housing of CPE1.
- (2) Use an Ethernet cable to connect the PoE LAN/WAN port of CPE1 to the PoE port of the PoE injector.
- (3) Use the included power adapter to connect the PoE injector to a power socket. The **LAN/WAN** LED indicator of the **CPE1** lights up.
- (4) Use an Ethernet cable to connect your computer to the **LAN** port of the PoE injector.

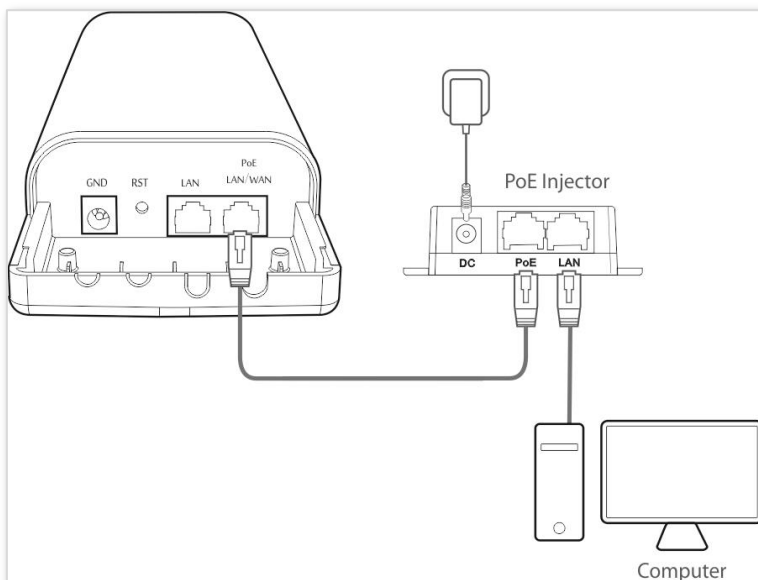

3. Set CPE1 to AP Mode.

- (1) Start a web browser on the computer, and visit **192.168.2.1**. Enter your user name and password (default: **admin/admin**), and click **Login**.

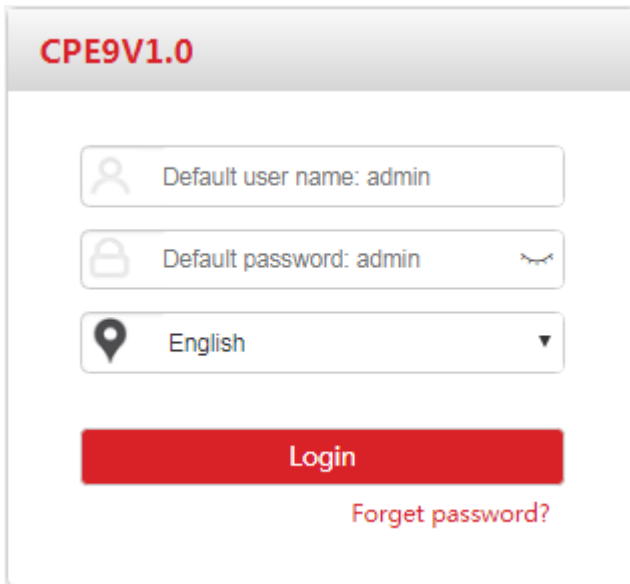

**CPE9V1.0**

Default user name: admin

Default password: admin

English

Login

Forget password?



If this page does not appear, please refer to [Q1 in FAQ](#).

---

4. Select **AP**, and click **Next**.

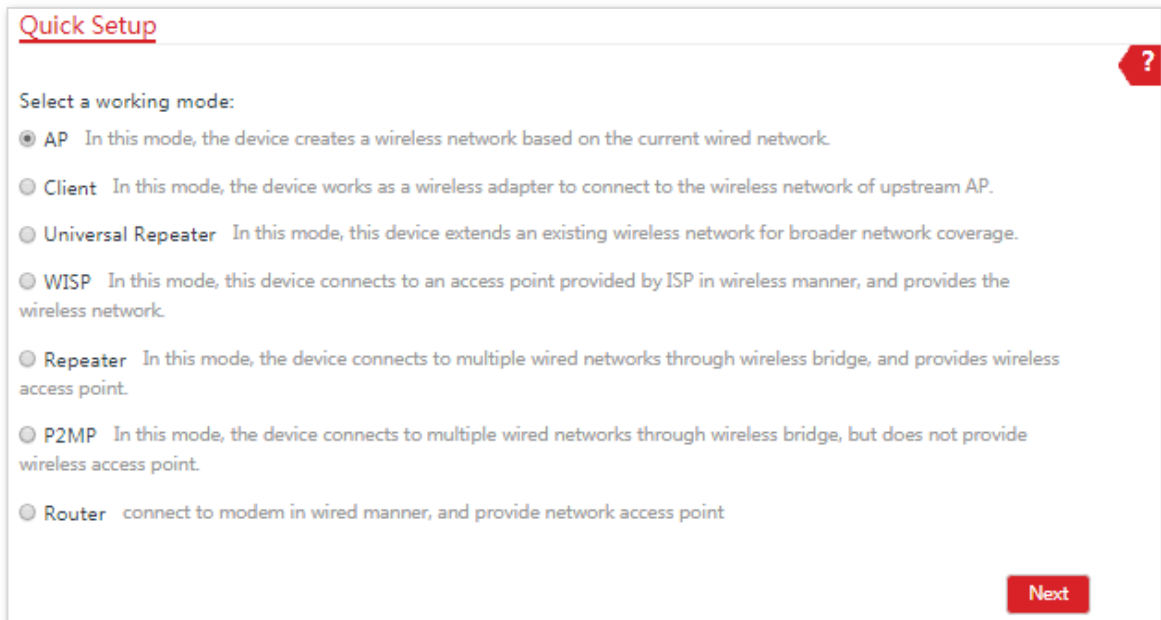

**Quick Setup**

Select a working mode:

- AP** In this mode, the device creates a wireless network based on the current wired network.
- Client** In this mode, the device works as a wireless adapter to connect to the wireless network of upstream AP.
- Universal Repeater** In this mode, this device extends an existing wireless network for broader network coverage.
- WISP** In this mode, this device connects to an access point provided by ISP in wireless manner, and provides the wireless network.
- Repeater** In this mode, the device connects to multiple wired networks through wireless bridge, and provides wireless access point.
- P2MP** In this mode, the device connects to multiple wired networks through wireless bridge, but does not provide wireless access point.
- Router** connect to modem in wired manner, and provide network access point

Next

- (1) Set an **SSID**, which is **IP-COM\_123456** in this example, **Security Mode** (WPA2-PSK is recommended), and **Key**, and click **Next**.

**Quick Setup >> AP**

You can set up your wireless network name and wireless password here.  
Note down your wireless password.

SSID: IP-COM\_123456

Channel: Auto

Security Mode: WPA2-PSK

Encryption Algorithm:  AES  TKIP  TKIP&AES

Key: .....

Previous Next

- (2) Click **Save**, and wait until the CPE reboots automatically to activate the settings.

**Quick Setup >> AP**

The device is set to AP, click "Save" to apply the settings.

Previous Save

## 5. Set CPE2 to Client Mode.

- (1) Perform the procedure in [Step 2 Connect the computer to CPE1](#) to connect the computer to **CPE2**.
- (2) Start a web browser on your computer, and visit **192.168.2.1**. Enter the login user name and password (default: **admin/admin**), and click **Login**.

**CPE9V1.0**

Default user name: admin

Default password: admin

English

Login

Forget password?



If this page doesn't appear, please refer to [Q1 in FAQ](#).

- (3) Select **Client**, and click **Next**.

**Quick Setup** ?

Select a working mode:

- AP** In this mode, the device creates a wireless network based on the current wired network.
- Client** In this mode, the device works as a wireless adapter to connect to the wireless network of upstream AP.
- Universal Repeater** In this mode, this device extends an existing wireless network for broader network coverage.
- WISP** In this mode, this device connects to an access point provided by ISP in wireless manner, and provides the wireless network.
- Repeater** In this mode, the device connects to multiple wired networks through wireless bridge, and provides wireless access point.
- P2MP** In this mode, the device connects to multiple wired networks through wireless bridge, but does not provide wireless access point.
- Router** connect to modem in wired manner, and provide network access point

**Next**

- (4) Select the SSID of **CPE1** you set, which is **IP-COM\_123456** in this example, and click **Next**.

**Quick Setup >> Client** ?

Click "Scan", and select the wireless network you want to connect, and click "Next".

Scan  [Scan again](#)

Upstream AP

Transparent Bridge

| Select                           | SSID          | Channel | MAC Address       | Security Mode         | Signal Strength |
|----------------------------------|---------------|---------|-------------------|-----------------------|-----------------|
| <input checked="" type="radio"/> | IP-COM_123456 | 3       | C8:3A:35:84:3F:01 | Mixed WPA/WPA2-PSK... |                 |



If there is no wireless network is scanned, choose **Wireless > Basic**, and ensure that the wireless function is enabled. Then try again.

- (5) Enter the WiFi password you set for **CPE1** in the **Key** text box, and click **Next**.

**Quick Setup >> Client**

Ensure that the device uses the same channel, encryption, and encryption algorithm as those of upstream AP.  
Then enter the remote AP's WiFi password, and click "Next" to continue.

Upstream AP IP-COM\_123456

Upstream AP MAC Address C8:3A:35:84:3F:01

Channel 3(2422)

Security Mode Mixed WPA/WPA2-PSK

Encryption Algorithm  AES  TKIP  TKIP&AES

Key .....

Previous Next

- (6) Set the **IP address** to an unused IP address belonging to the same network segment as that of **CPE1**. For example, if the IP address of CPE1 is 192.168.2.1, you can set this CPE's IP address to 192.168.2.X (X ranges from 2 to 254). Then click **Next**.

**Quick Setup >> Client**

Set the IP address to an unused IP address belonging to the network segment of upstream AP.

IP Address 192.168.2.100

Subnet Mask 255.255.255.0

Default Gateway 192.168.2.254

Primary DNS Server 8.8.8.8

Secondary DNS Server 8.8.4.4

Previous Next

- (7) Click **Save**, and wait until the CPE reboots to activate the settings.

**Quick Setup >> Client**

The device is set to Client, click "Save" to apply the settings.

Previous Save

---End

When LED1, LED2, and LED3 of CPE1 are solid on, and LED1, LED2, and LED3 of CPE2 are blinking, the bridging succeeds.



You can check the SSID and key of the CPE1 or CPE2 by choosing **Wireless > Basic** after logging in to the web UI.

## 2.2.3 Installing the CPEs

The CPE (transmitter in AP mode) with LED1, LED2 and LED3 solid on should be connected to the switch connecting to a network video recorder (NVR). See **Figure 1** below.

The CPE (receiver in Client mode) with LED1, LED2 and LED3 blinking should be connected to the switch connecting to a monitoring IP camera. See **Figure 2** below.

Detailed procedures are as follows:

1. Place the transmitter in the open air at the point where the NVR is located. Place the receiver in the open air at the point where the IP camera is located.
2. Uncover the housings of the two CPEs, and connect the **PoE/LAN/WAN** ports of the CPEs to PoE injectors respectively. The **LAN/WAN** LED indicators light up.
3. Adjust the two CPEs' direction or location until the LED1, LED2 and LED3 of the two CPEs light up.
4. Use the plastic straps to attach the two CPEs to the poles respectively.

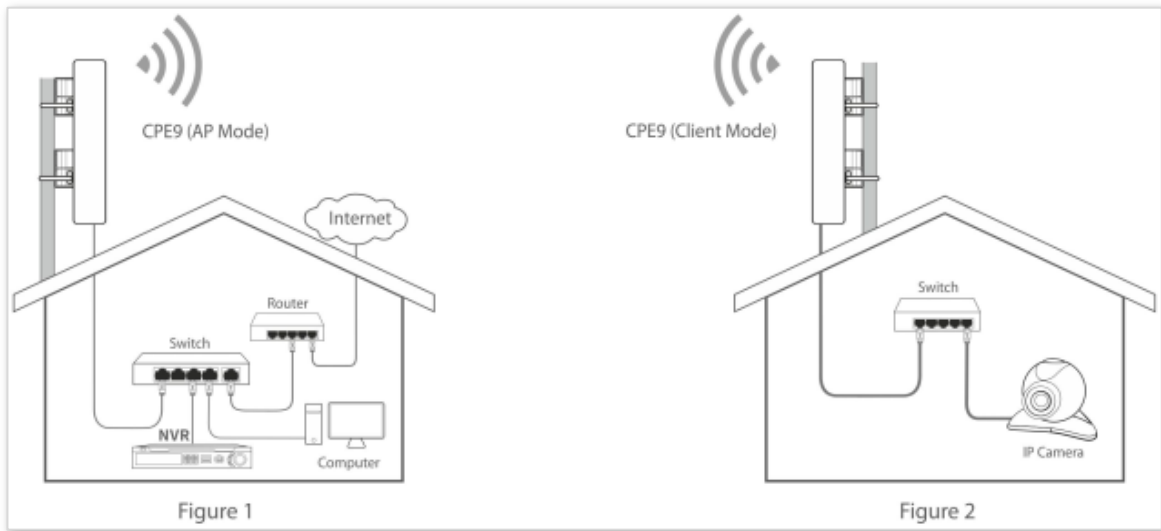

---End

# 3 Web UI

## 3.1 Login

1. Connect the computer to the device.
  - (1) Uncover the housing of the device.
  - (2) Use an Ethernet cable to connect the **PoE/LAN/WAN** port of the device to the **PoE** port of the PoE injector.
  - (3) Use the included power adapter to connect the PoE injector to a power socket. The **LAN/WAN** LED indicator of the device lights up.
  - (4) Use an Ethernet cable to connect your computer to the **LAN** port of the PoE injector.

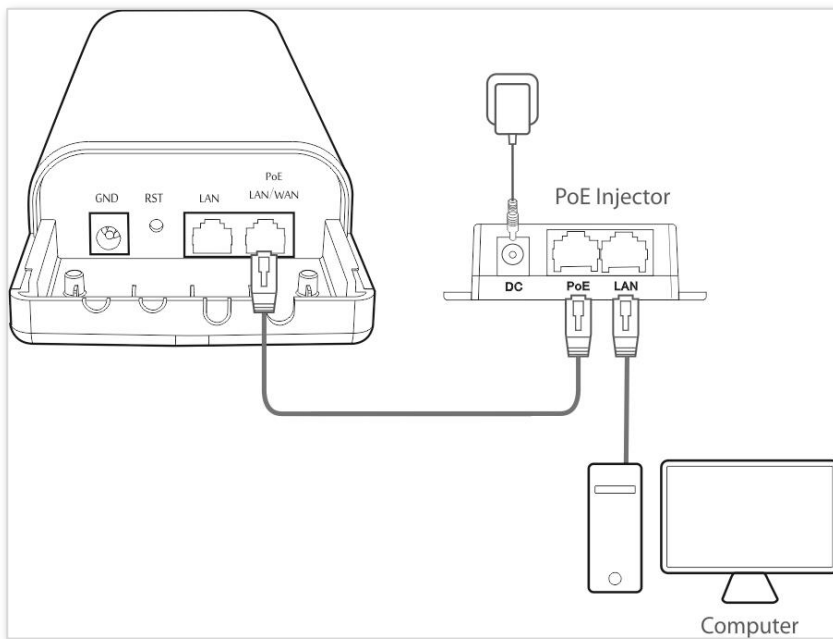

2. Start a web browser on your computer, and visit **192.168.2.1**. Enter your user name and password (default: **admin**), and click **Login**.

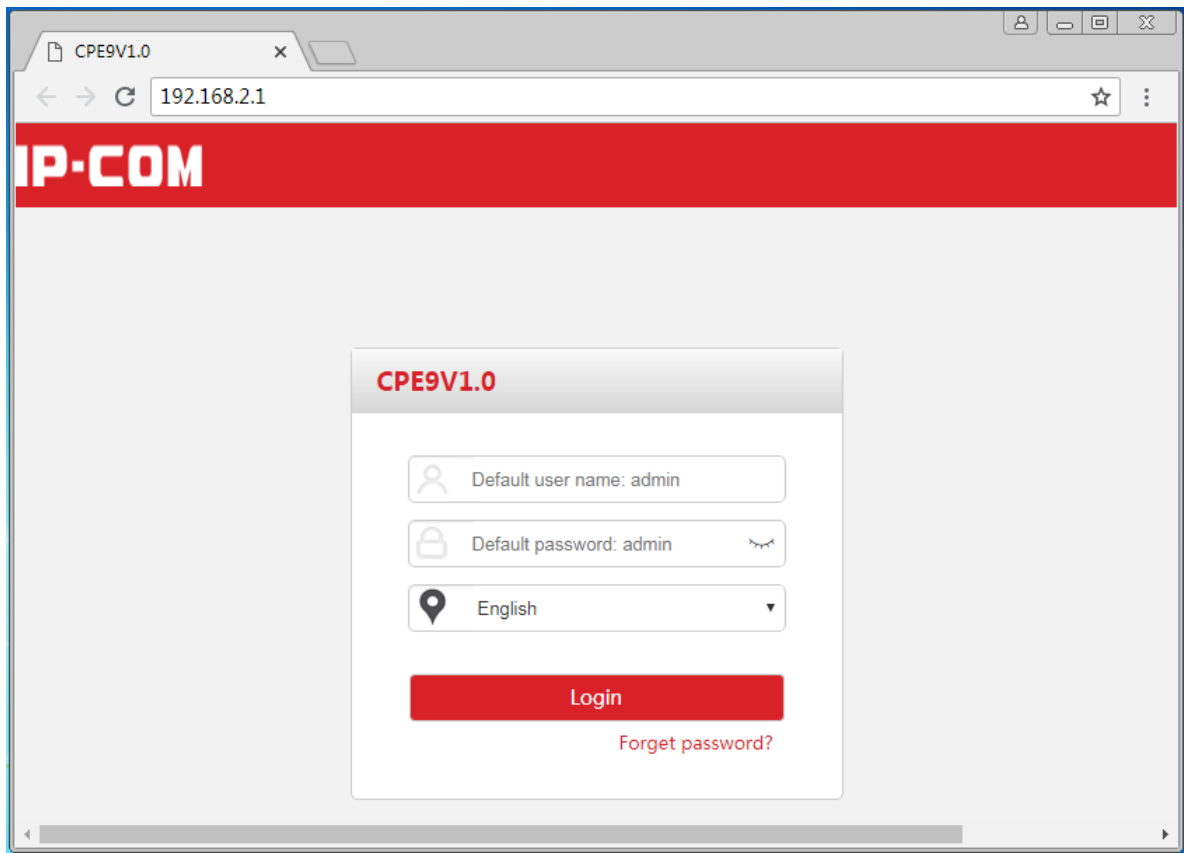

If this page does not appear, please refer to [Q1 in FAQ](#).

---

Then the following page appears.

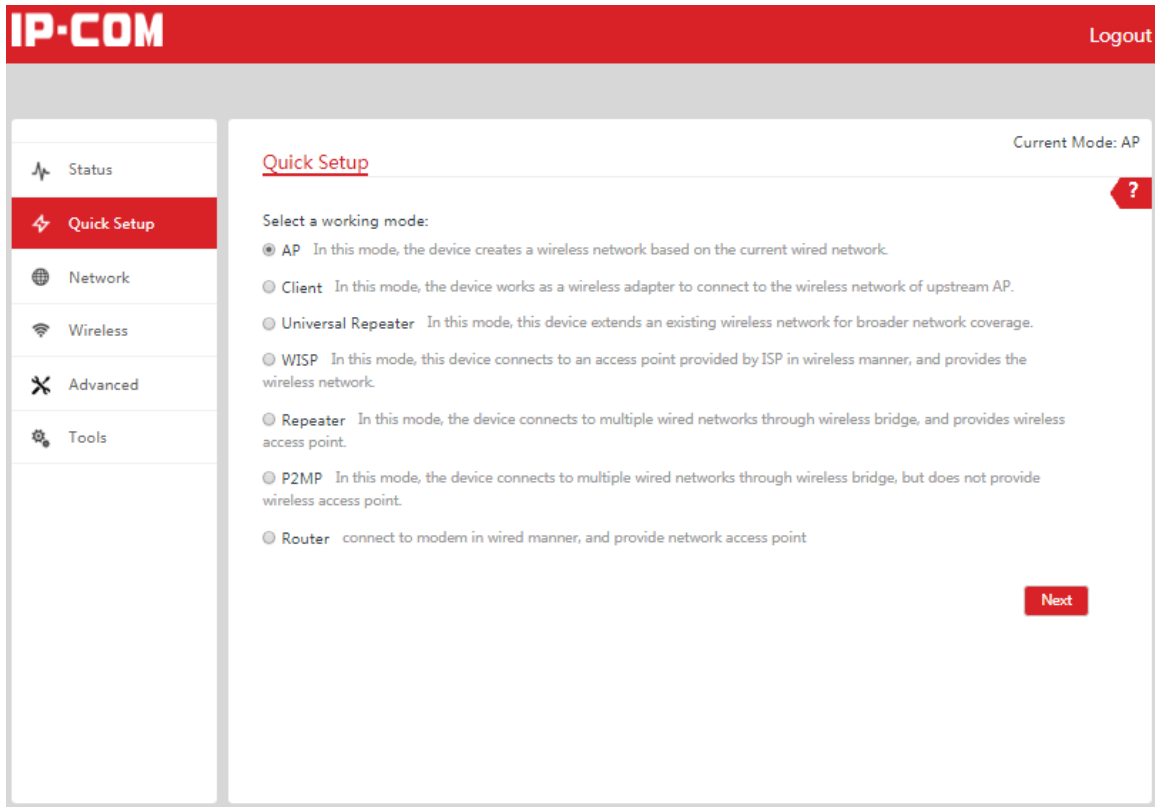

## 3.2 Logout

You can click **Logout** on the upper-right corner of the web UI to logout. When you close the web browser, the system logs you out as well.

If you log in to the web UI of the CPE and perform no operation within the login timeout interval (default: 5 minutes), the CPE logs you out.

## 3.3 Web UI Layout

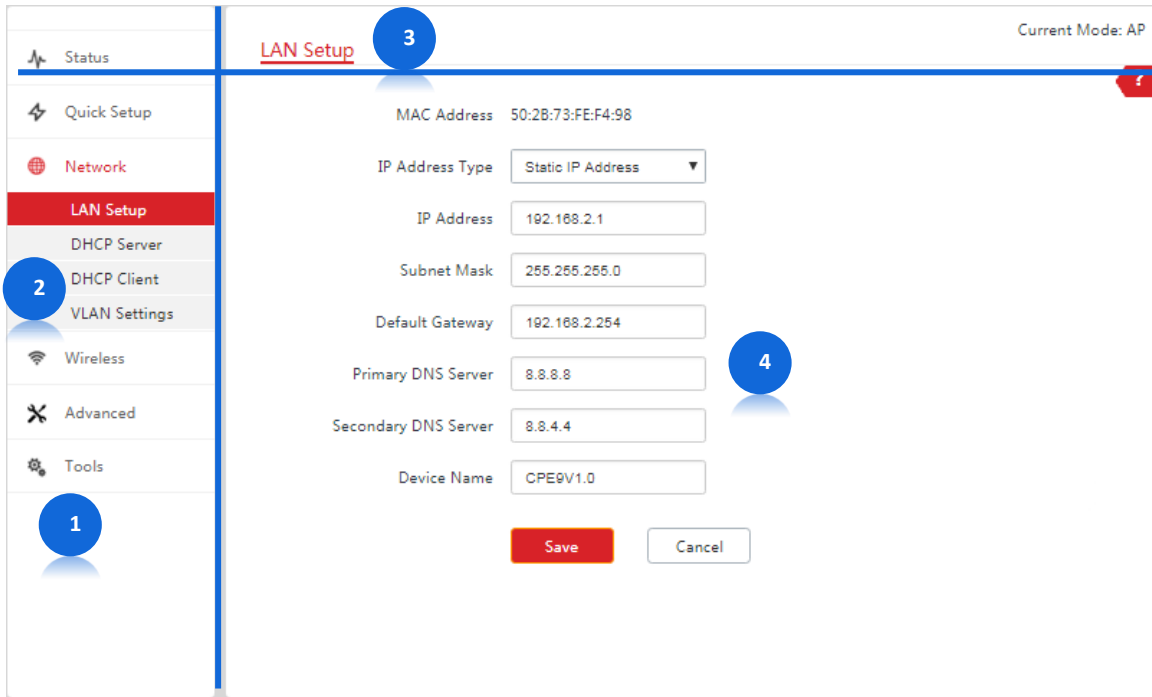

The web UI of the CPE is composed of 4 parts, including the level-1 navigation tree, level-2 navigation tree, tab page area, and configuration area. See the following figure.



| No. | Name                    | Description  |
|-----|-------------------------|--|
| 1   | Level-1 navigation tree |  |
| 2   | Level-2 navigation tree | The navigation bars and tab pages display the function menu of the CPE. When you select a function in navigation bar, the configuration of the function appears in the configuration area. |
| 3   | Tab page area           |  |
| 4   | Configuration area      | It enables you to view and modify configuration.   |

## 3.4 Common Buttons

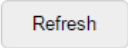
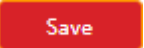
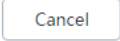
The following table describes the common buttons available on the web UI of the CPE.

| Common Buttons  | Description   |
|---|---|
|  | It is used to update the content of the current page.   |
|  | It is used to save the configuration on the current page and enable the configuration to take effect.     |
|  | It is used to go back to the original configuration without saving the configuration on the current page. |
|  | It is used to view help information corresponding to the settings on the current page.                    |

# 4 Quick Setup

This module enables you to quickly configure the CPE to deploy your wireless network.

CPE3 supports [AP](#), [Client](#), and [WISP](#) modes. CPE9 supports [AP](#), [Client](#), [Universal Repeater](#), [WISP](#), [Repeater](#), [P2MP](#), and [Router](#) modes.

## 4.1 AP Mode

### 4.1.1 Overview

AP mode is the default mode of the CPE. In this mode, this CPE is connected to the internet in wired manner, and provides a WiFi network.

The CPE in AP mode can work with the CPE in Client or Universal Repeater mode. The following takes two CPEs either working in AP mode or Client mode to illustrate.

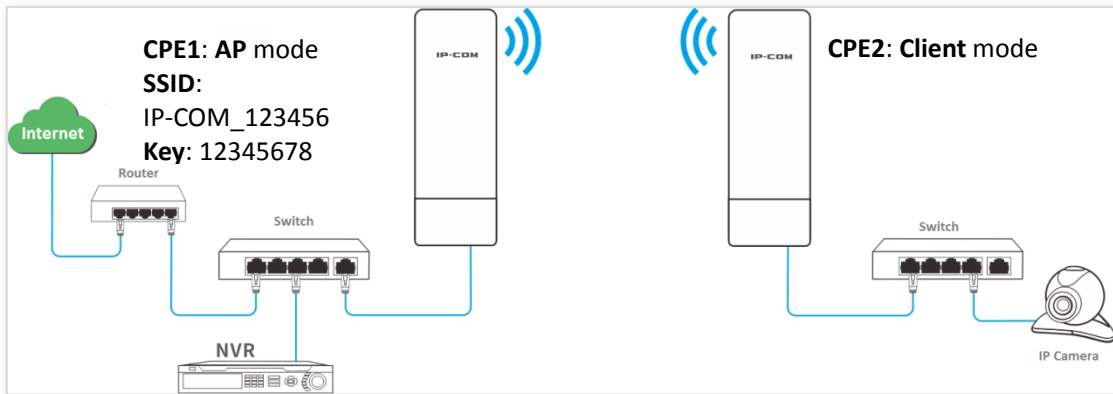

### 4.1.2 Setting up the AP Mode

**Configuration Procedure:**

1. Log in to the web UI of the CPE and choose **Quick Setup** to enter the configuration page.\

2. Select **AP** mode and click **Next**.

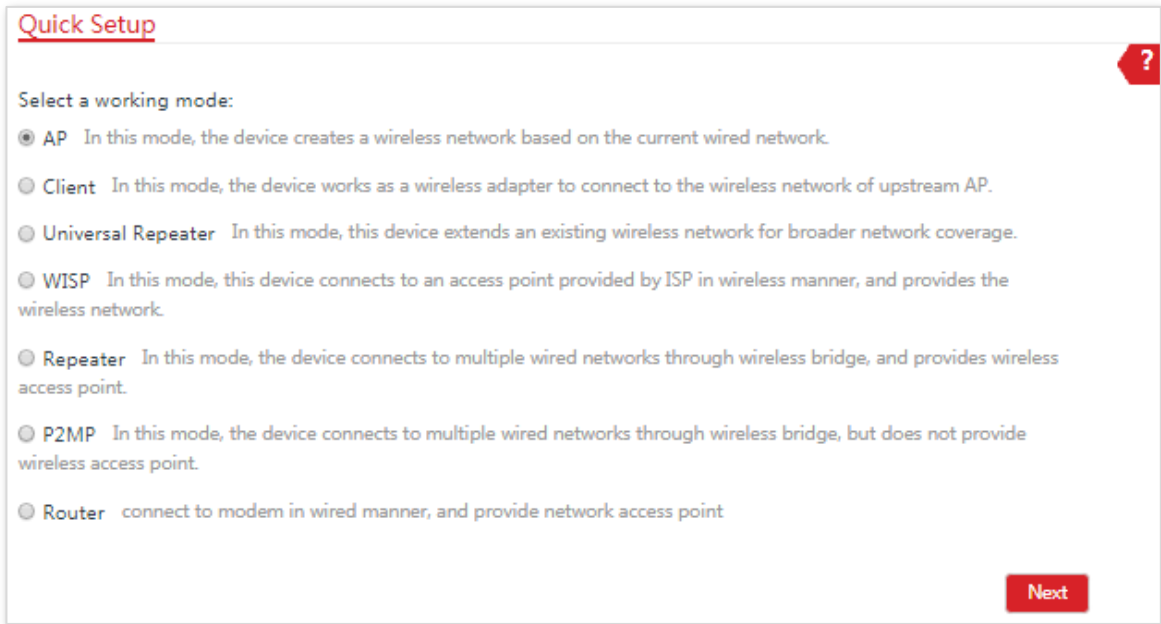

**Quick Setup**

Select a working mode:

- AP** In this mode, the device creates a wireless network based on the current wired network.
- Client** In this mode, the device works as a wireless adapter to connect to the wireless network of upstream AP.
- Universal Repeater** In this mode, this device extends an existing wireless network for broader network coverage.
- WISP** In this mode, this device connects to an access point provided by ISP in wireless manner, and provides the wireless network.
- Repeater** In this mode, the device connects to multiple wired networks through wireless bridge, and provides wireless access point.
- P2MP** In this mode, the device connects to multiple wired networks through wireless bridge, but does not provide wireless access point.
- Router** connect to modem in wired manner, and provide network access point

**Next**

3. Set an SSID, which is **IP-COM\_123456** in this example, **Security Mode** (WPA2-PSK is recommended), and **Key**, and click **Next**.

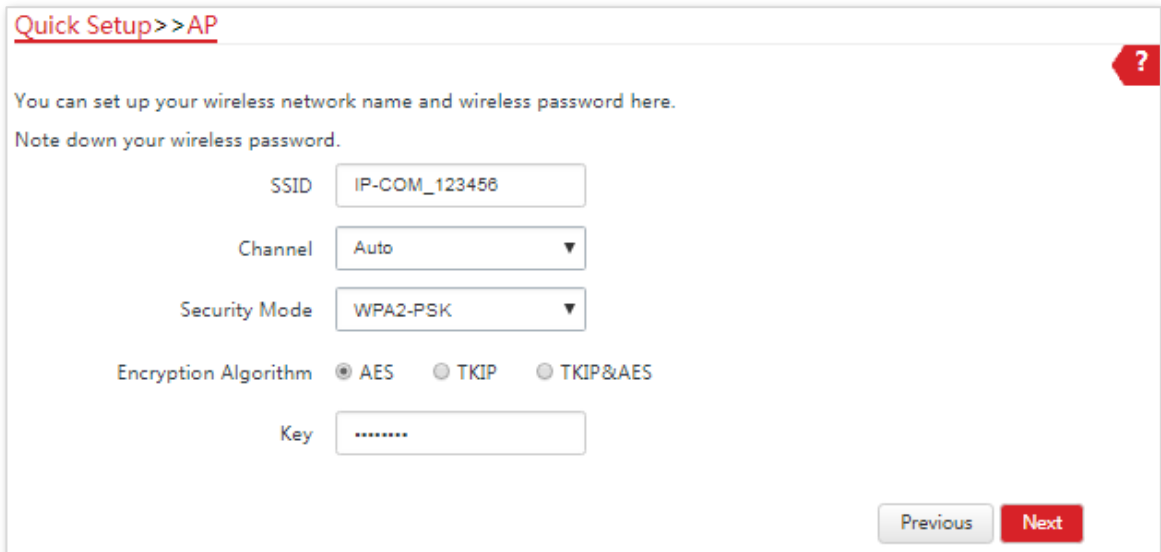

**Quick Setup >> AP**

You can set up your wireless network name and wireless password here.  
Note down your wireless password.

SSID:

Channel:

Security Mode:

Encryption Algorithm:  AES  TKIP  TKIP&AES

Key:

**Previous** **Next**

4. Click **Save**, and wait until the device reboots automatically to activate the settings.

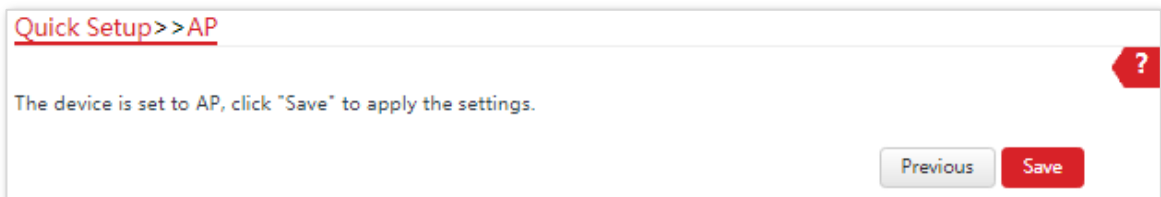

**Quick Setup >> AP**

The device is set to AP, click "Save" to apply the settings.

**Previous** **Save**

---End

## Parameters Description

| Name          | Description   |
|---------------|---|
| Working Modes | <p>It specifies the working mode of the CPE.</p> <ul style="list-style-type: none"><li>– <b>AP</b> mode: in this mode, the device creates a wireless network based on the current wired network.</li><li>– <b>Client</b> mode: in this mode, the device works as a wireless adapter to connect to the wireless network of upstream AP, and does not provide wireless access point.</li><li>– <b>Universal Repeater</b> mode: in this mode, this device expands your WiFi network for broader network coverage.</li></ul> <p>Advantage of Universal Repeater compared with Repeater mode: This mode does not require that the upstream AP supports WDS function.</p> <ul style="list-style-type: none"><li>– <b>WISP</b> mode: connect to an access point provided by ISP in wireless manner.</li><li>– <b>Repeater</b> mode: the CPE connects 2 or more (this device supports 4 at most) wired networks with a wireless link, and can be connected with both wired and wireless clients. To use the Repeater function of this device, the peer AP is required to support WDS function, and use the same radio band as that of this device.</li><li>– <b>P2MP</b> mode: this device connects 2 or more (this device supports 4 at most) wired networks with a wireless link, but cannot be connected with wireless clients. P2MP mode is used to achieve communication between multiple offices of an enterprise in a city.</li><li>– <b>Router</b> mode: in this mode, the <b>PoE LAN/WAN</b> port works as the WAN port and is used to connect to a modem for internet access.</li></ul> |
| SSID          | It specifies the wireless network name of the CPE.  |
| Channel       | <p>It specifies the operating channel of the CPE.</p> <p><b>Auto:</b> It indicates that the CPE automatically adjusts its operating channel according to the ambient environment.</p>   |
| Security Mode | <p>It specifies the security mode of the wireless network, including: <a href="#">None</a>, <a href="#">WPA-PSK</a>, <a href="#">WPA2-PSK</a>, and <a href="#">Mixed WPA/WPA2-PSK</a>.</p> <p>Clicking the hyperlink navigates you to the elaborated description of the corresponding security mode.</p>  |

## 4.2 Client Mode

### 4.2.1 Overview

In Client mode, this CPE works as a wireless adapter to connect to the wireless network of upstream AP, and does not provide wireless access point.

The CPE in Client mode should work with the CPE in AP mode. See the following network topology:

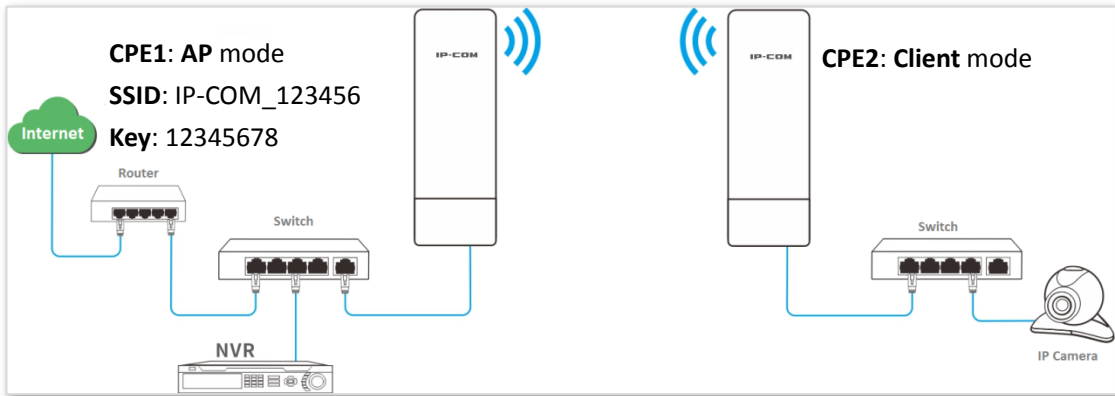

### 4.2.2 Setting up the Client Mode

#### Configuration Procedure:

Log in to the web UI of CPE2 and choose **Quick Setup** to enter the configuration page.

1. Select **Client**, and click **Next**.

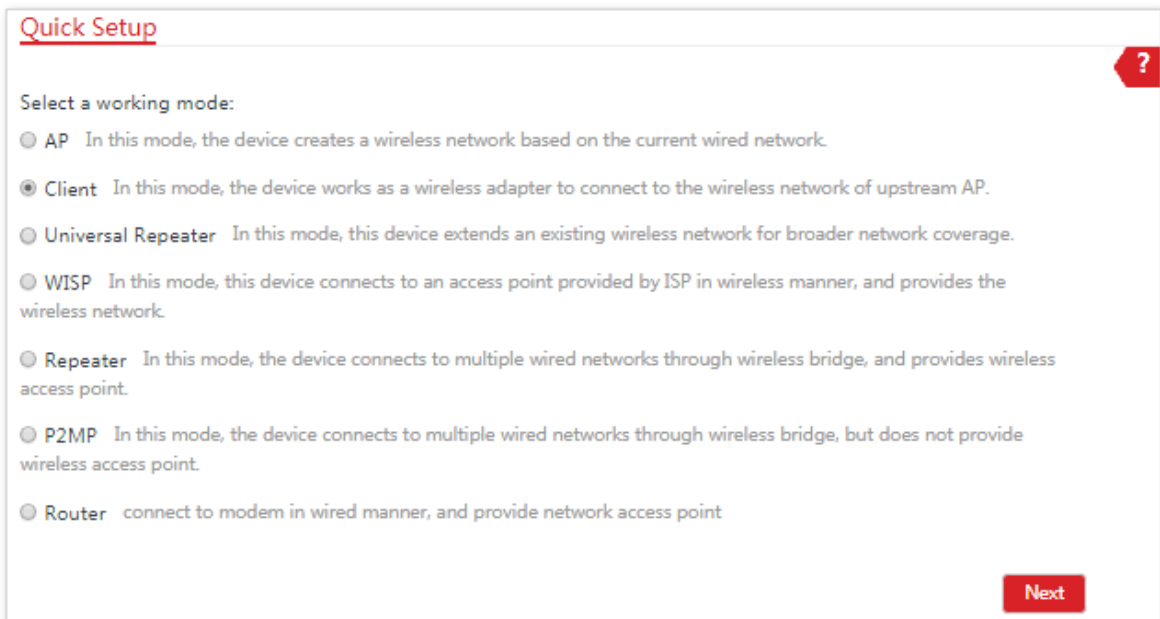

2. Select the SSID of the CPE1, which is **IP-COM\_123456** in this example, and click **Next**.

**Quick Setup >> Client** ?

Click "Scan", and select the wireless network you want to connect, and click "Next".

Scan  [Scan again](#)

Upstream AP

Transparent Bridge

| Select                           | SSID          | Channel | MAC Address       | Security Mode         | Signal Strength   |
|----------------------------------|---------------|---------|-------------------|-----------------------|---|
| <input checked="" type="radio"/> | IP-COM_123456 | 3       | C8:3A:35:84:3F:01 | Mixed WPA/WPA2-PSK... |  |



Tip

If you cannot scan the SSID of the CPE1 from the list, choose **Wireless > Basic** and enable the wireless function. Then try again.

---

3. Enter the WiFi password you set on CPE1 in the **Key** text box, and click **Next**.

Quick Setup >> Client

Ensure that the device uses the same channel, encryption, and encryption algorithm as those of upstream AP. Then enter the remote AP's WiFi password, and click "Next" to continue.

Upstream AP IP-COM\_123456

Upstream AP MAC Address C8:3A:35:84:3F:01

Channel 3(2422)

Security Mode Mixed WPA/WPA2-PSK

Encryption Algorithm  AES  TKIP  TKIP&AES

Key .....

Previous Next

4. Set the IP address to an unused IP address belonging to the same network segment as that of CPE1. For example, if the IP address of CPE1 is 192.168.2.1, you can set this device's IP address to 192.168.2.X (X ranges from 2 to 254). Then click **Next**.

Quick Setup >> Client

Set the IP address to an unused IP address belonging to the network segment of upstream AP.

IP Address 192.168.2.100

Subnet Mask 255.255.255.0

Default Gateway 192.168.2.254

Primary DNS Server 8.8.8.8

Secondary DNS Server 8.8.4.4

Previous Next

5. Click **Save**, and wait until the device reboots to activate the settings.

Quick Setup >> Client

The device is set to Client, click "Save" to apply the settings.

Previous Save

---End

When LED1, LED2, and LED3 of CPE1 are solid on, and LED1, LED2, and LED3 of CPE2 are blinking, the bridging succeeds.



You can check the SSID and key of CPE2 by choosing **Wireless > Basic** after logging in to the web UI.

### Parameters Description

| Name               | Description  |
|--------------------|--|
| Working Modes      | <p>It specifies the working mode of the CPE.</p> <ul style="list-style-type: none"><li>– <b>AP mode:</b> in this mode, the device creates a wireless network based on the current wired network.</li><li>– <b>Client mode:</b> in this mode, the device works as a wireless adapter to connect to the wireless network of upstream AP, and does not provide wireless access point.</li><li>– <b>Universal Repeater mode:</b> in this mode, this device expands your WiFi network for broader network coverage.</li></ul> <p>Advantage of Universal Repeater compared with Repeater mode: This mode does not require that the upstream AP supports WDS function.</p> <ul style="list-style-type: none"><li>– <b>WISP mode:</b> connect to an access point provided by ISP in wireless manner.</li><li>– <b>Repeater mode:</b> the CPE connects 2 or more (this device supports 4 at most) wired networks with a wireless link, and can be connected with both wired and wireless clients. To use the Repeater function of this device, the peer AP is required to support WDS function, and use the same radio band as that of this device.</li><li>– <b>P2MP mode:</b> this device connects 2 or more (this device supports 4 at most) wired networks with a wireless link, but cannot be connected with wireless clients. P2MP mode is used to achieve communication between multiple offices of an enterprise in a city.</li><li>– <b>Router mode:</b> in this mode, the PoE LAN/WAN port works as the WAN port and is used to connect to a modem for internet access.</li></ul> |
| Transparent Bridge | With the function enabled, IP cameras can be discovered by the NVR.  |
| Upstream AP        | It specifies the wireless network name (SSID) of the upstream AP.  |
| Channel            | It specifies the operating channel of the WiFi network to be bridged. It will be automatically populated when you select an SSID to bridge.  |
| Security Mode      | It specifies the security mode of the WiFi network to be bridged. It will be automatically populated when you select an SSID to bridge. If the WiFi network to be bridged has a WiFi password, you need to enter the password manually.  |

## 4.3 Universal Repeater Mode (Only for CPE9)

### 4.3.1 Overview

In Universal Repeater mode, this CPE expands your WiFi network for broader network coverage. Advantage of Universal Repeater compared with Repeater mode: This mode does not require that the upstream AP supports WDS function.

See the following network topology:

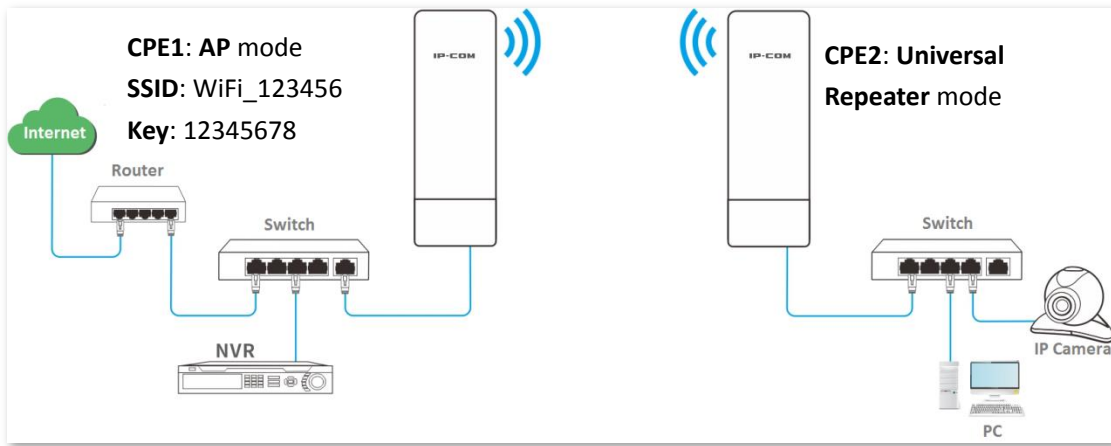

### 4.3.2 Setting up the Universal Repeater Mode

**Configuration Procedure:**

1. Log in to the web UI of the CPE2 and choose **Quick Setup** to enter the configuration page.

2. Select Universal Repeater, and click Next.

**Quick Setup** ?

Select a working mode:

- AP** In this mode, the device creates a wireless network based on the current wired network.
- Client** In this mode, the device works as a wireless adapter to connect to the wireless network of upstream AP.
- Universal Repeater** In this mode, this device extends an existing wireless network for broader network coverage.
- WISP** In this mode, this device connects to an access point provided by ISP in wireless manner, and provides the wireless network.
- Repeater** In this mode, the device connects to multiple wired networks through wireless bridge, and provides wireless access point.
- P2MP** In this mode, the device connects to multiple wired networks through wireless bridge, but does not provide wireless access point.
- Router** connect to modem in wired manner, and provide network access point

**Next**

3. Select the SSID of CPE1 (the upstream AP), which is **IP-COM\_123456** in this example, and click **Next**.

**Quick Setup >> Universal Repeater** ?

Click "Scan", and select the wireless network you want to connect, and click "Next".

Scan  [Scan again](#)

Upstream AP

Transparent Bridge

| Select                           | SSID          | Channel | MAC Address       | Security Mode         | Signal Strength   |
|----------------------------------|---------------|---------|-------------------|-----------------------|---|
| <input checked="" type="radio"/> | IP-COM_123456 | 10      | C8:3A:35:84:3F:01 | Mixed WPA/WPA2-PSK... |  |

4. Enter the WiFi password of CPE1 in the **Key** text box, and click **Next**.

Quick Setup >> Universal Repeater

Ensure that the device uses the same channel, encryption, and encryption algorithm as those of upstream AP.  
Then enter the remote AP's WiFi password, and click "Next" to continue.

Upstream AP IP-COM\_123456

Upstream AP MAC Address C8:3A:35:84:3F:01

Channel 10(2457)

Security Mode Mixed WPA/WPA2-PSK

Encryption Algorithm  AES  TKIP  TKIP&AES

Key .....

Previous Next

5. Set the IP address to an unused IP address belonging to the same network segment as that of CPE1 (the upstream AP). For example, if the IP address of CPE1 is 192.168.2.1, you can set this device's IP address to 192.168.2.X (X ranges from 2 to 254). Then click **Next**.

Quick Setup >> Universal Repeater

Set the IP address to an unused IP address belonging to the network segment of upstream AP.

IP Address 192.168.2.100

Subnet Mask 255.255.255.0

Default Gateway 192.168.2.254

Primary DNS Server 8.8.8.8

Secondary DNS Server 8.8.4.4

Previous Next

6. Click **Save**, and wait until the device reboots to activate the settings.

Quick Setup >> Universal Repeater

The device is set to Universal Repeater, click "Save" to apply the settings.

Previous Save

---End



You can check the SSID and key of CPE2 by choosing **Wireless > Basic** after logging in to the web UI.

### Parameters Description

| Name               | Description  |
|--------------------|--|
| Working Modes      | <p>It specifies the working mode of the CPE.</p> <ul style="list-style-type: none"><li>– <b>AP mode:</b> in this mode, the device creates a wireless network based on the current wired network.</li><li>– <b>Client mode:</b> in this mode, the device works as a wireless adapter to connect to the wireless network of upstream AP, and does not provide wireless access point.</li><li>– <b>Universal Repeater mode:</b> in this mode, this device expands your WiFi network for broader network coverage.</li></ul> <p>Advantage of Universal Repeater compared with Repeater mode: This mode does not require that the upstream AP supports WDS function.</p> <ul style="list-style-type: none"><li>– <b>WISP mode:</b> connect to an access point provided by ISP in wireless manner.</li><li>– <b>Repeater mode:</b> the CPE connects 2 or more (this device supports 4 at most) wired networks with a wireless link, and can be connected with both wired and wireless clients. To use the Repeater function of this device, the peer AP is required to support WDS function, and use the same radio band as that of this device.</li><li>– <b>P2MP mode:</b> this device connects 2 or more (this device supports 4 at most) wired networks with a wireless link, but cannot be connected with wireless clients. P2MP mode is used to achieve communication between multiple offices of an enterprise in a city.</li><li>– <b>Router mode:</b> in this mode, the PoE LAN/WAN port works as the WAN port and is used to connect to a modem for internet access.</li></ul> |
| Transparent Bridge | With the function enabled, IP cameras can be discovered by the NVR.  |
| Upstream AP        | It specifies the wireless network name (SSID) of the upstream AP.  |
| Channel            | It specifies the operating channel of the WiFi network to be bridged. It will be automatically populated when you select an SSID to bridge.  |
| Security Mode      | It specifies the security mode of the WiFi network to be bridged. It will be automatically populated when you select an SSID to bridge. If the WiFi network to be bridged has a WiFi password, you need to enter the password manually.  |

## 4.4 WISP Mode

### 4.4.1 Overview

In WISP mode, this CPE can connect to an access point provided by ISP in wireless manner, and allowed the wireless devices to connect to the internet.

See the following network topology:

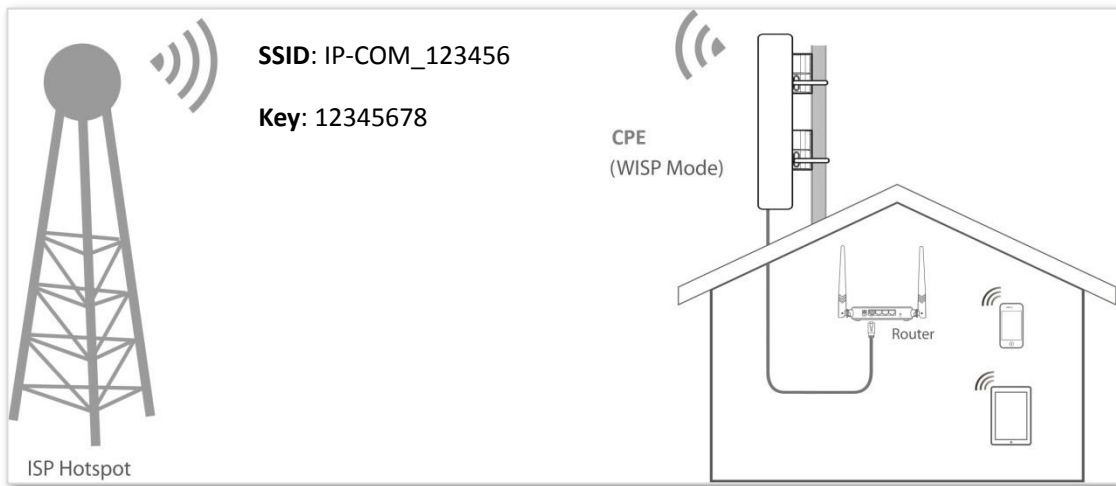

### 4.4.2 Setting up the WISP Mode

**Configuration Procedure:**

1. Log in to the web UI of this CPE and choose **Quick Setup** to enter the configuration page.

2. Select **WISP**, and click **Next**.

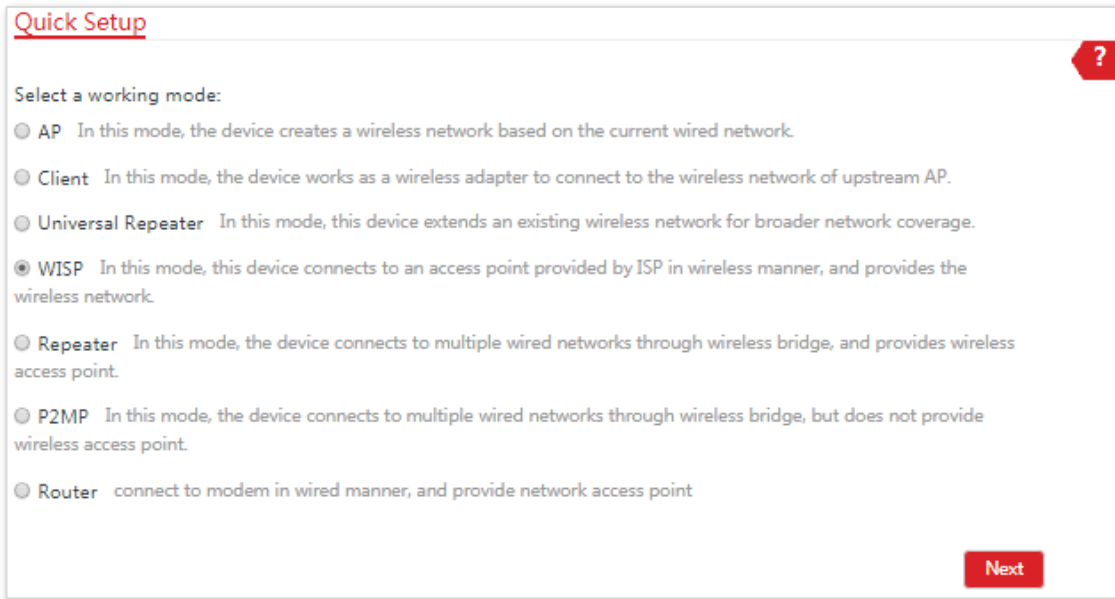

3. Select the SSID of your ISP (Internet Service Provider) hotspot, which is **IP-COM\_123456** in this example, and click **Next**.

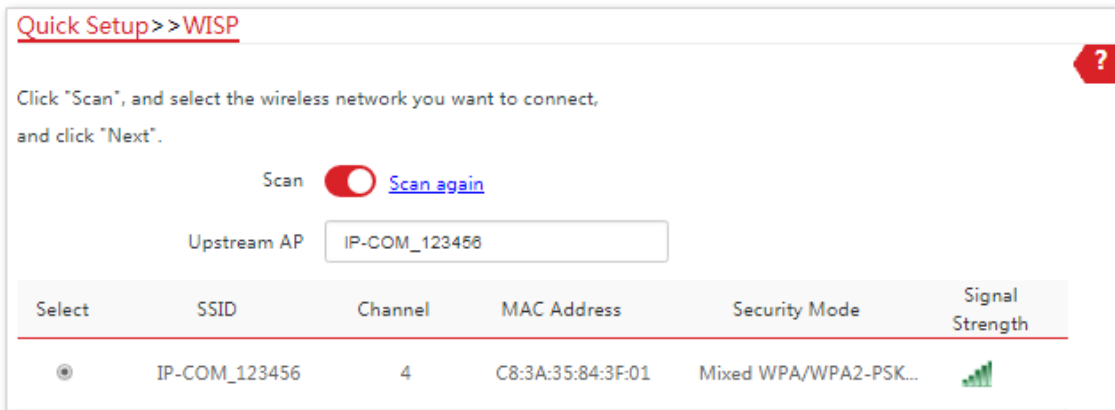

4. Enter the WiFi password of your ISP (Internet Service Provider) hotspot in the **Key** text box, and click **Next**.

Quick Setup >> WISP ?

Ensure that the device uses the same channel, encryption, and encryption algorithm as those of upstream AP. Then enter the remote AP's WiFi password, and click "Next" to continue.

Upstream AP IP-COM\_123456

Upstream AP MAC Address C8:3A:35:84:3F:01

Channel 4(2427)

Security Mode Mixed WPA/WPA2-PSK

Encryption Algorithm  AES  TKIP  TKIP&AES

Key .....

Previous Next

5. Select the **Internet Connection Type** of your ISP hotspot, which is **PPPoE** in this example. Enter the PPPoE user name and password provided by your ISP, and click **Next**.

Quick Setup >> WISP ?

Please select an internet connection type, and enter the internet parameters provided by your ISP. and click "Next".

Internet Connection Type  DHCP (Dynamic IP)  Static IP Address  PPPoE

PPPoE User Name

PPPoE Password

Previous Next

6. Customize the SSID and key, and click **Next**.

Quick Setup >> WISP

You can set up your wireless network name and wireless password here.  
Note down your wireless password.

SSID(WiFi Name)

Channel

Security Mode

Encryption Algorithm  AES  TKIP  TKIP&AES

Key

Previous Next

7. Set an IP address belonging to different network segment as that of your ISP hotspot. For example, if the IP address of your ISP hotspot is 192.168.2.1, you can set this device's IP address to 192.168.X.1 (X ranges from 0 to 254 excluding 2). Then click **Next**.
8. Click **Save**, and wait until the device reboots to activate the settings.

Quick Setup >> WISP

Specify the device with an IP address whose network segment is different from that of IP address of ISP access point or upstream AP.

IP Address

Subnet Mask

Previous Next

---End

When LED1, LED2, and LED3 of the CPE are blinking, the device is connected to your ISP hotspot successfully.



You can check the SSID and key of the CPE by choosing **Wireless > Basic** after logging in to the web UI.

## Parameters Description

| Name                     | Description  |
|--------------------------|--|
|                          | <p>It specifies the working mode of the CPE.</p> <ul style="list-style-type: none"><li>– <b>AP mode:</b> in this mode, the device creates a wireless network based on the current wired network.</li><li>– <b>Client mode:</b> in this mode, the device works as a wireless adapter to connect to the wireless network of upstream AP, and does not provide wireless access point.</li><li>– <b>Universal Repeater mode:</b> in this mode, this device expands your WiFi network for broader network coverage.</li></ul> <p>Advantage of Universal Repeater compared with Repeater mode: This mode does not require that the upstream AP supports WDS function.</p>  |
| Working Modes            | <ul style="list-style-type: none"><li>– <b>WISP mode:</b> connect to an access point provided by ISP in wireless manner.</li><li>– <b>Repeater mode:</b> the CPE connects 2 or more (this device supports 4 at most) wired networks with a wireless link, and can be connected with both wired and wireless clients. To use the Repeater function of this device, the peer AP is required to support WDS function, and use the same radio band as that of this device.</li><li>– <b>P2MP mode:</b> this device connects 2 or more (this device supports 4 at most) wired networks with a wireless link, but cannot be connected with wireless clients. P2MP mode is used to achieve communication between multiple offices of an enterprise in a city.</li><li>– <b>Router mode:</b> in this mode, the PoE LAN/WAN port works as the WAN port and is used to connect to a modem for internet access.</li></ul> |
| Upstream AP              | It specifies the wireless network name (SSID) of the upstream AP.  |
| Channel                  | It specifies the operating channel of the WiFi network to be bridged. It will be automatically populated when you select an SSID to bridge.  |
| Security Mode            | It specifies the security mode of the WiFi network to be bridged. It will be automatically populated when you select an SSID to bridge. If the WiFi network to be bridged has a WiFi password, you need to enter the password manually.  |
| Internet Connection Type | <ul style="list-style-type: none"><li>– <b>DHCP (Dynamic IP):</b> The CPE obtains IP address and other parameters from the DHCP server of upstream device for internet access.</li><li>– <b>Static IP Address:</b> The CPE access the internet by setting the IP address, subnet mask, default gateway and DNS server IP addresses manually.</li><li>– <b>PPPoE:</b> The CPE access the internet using the PPPoE user name and password provided by the ISP.</li></ul>   |

## 4.5 Repeater Mode (Only for CPE9)

### 4.5.1 Overview

In Repeater mode, the CPE connects 2 or more (this device supports 4 at most) wired networks with a wireless link, and can be connected with both wired and wireless clients. To use this function, the peer AP is required to support WDS function. Repeater mode is used to achieve communication between multiple offices of an enterprise in a city.

The CPE in Repeater mode can work with the CPE in Repeater or P2MP mode. It supports one to four bridging at most.

### 4.5.2 Setting up the Repeater Mode

#### One to One Bridging

Assume that CPE1 and CPE2 both work in Repeater mode and the wireless parameters of CPE2 are as follows:

- **SSID:** IP-COM\_123456
- **Security mode:** WEP
- **Authentication type:** Shared
- **Key1 to key4:** 1234

See the following network topology:

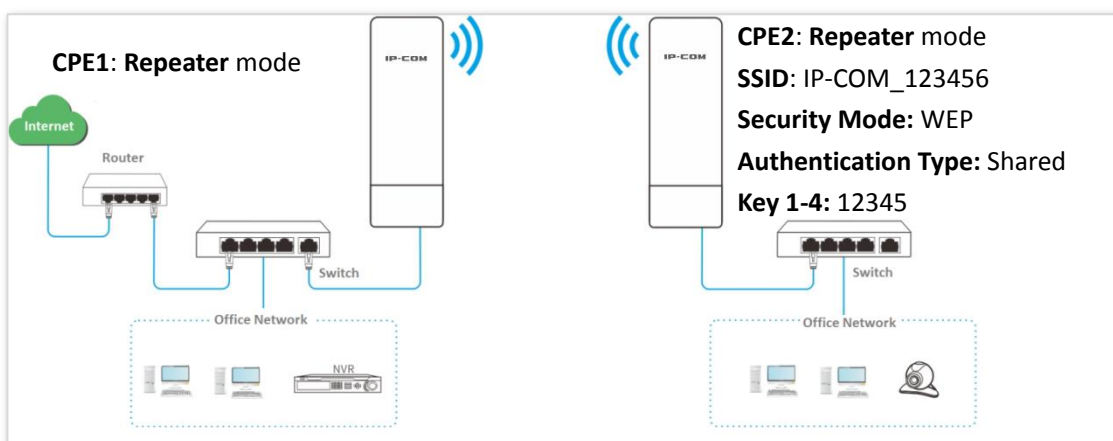

#### Configuration Procedure:

1. Set CPE1 to the Repeater mode.
  - (1) Log in to the web UI of CPE1 and choose **Quick Setup** to enter the configuration page.

- (2) Select the SSID of CPE2, which is **IP-COM\_123456** in this example, and click **Next**.

**Quick Setup** ?

Select a working mode:

- AP** In this mode, the device creates a wireless network based on the current wired network.
- Client** In this mode, the device works as a wireless adapter to connect to the wireless network of upstream AP.
- Universal Repeater** In this mode, this device extends an existing wireless network for broader network coverage.
- WISP** In this mode, this device connects to an access point provided by ISP in wireless manner, and provides the wireless network.
- Repeater** In this mode, the device connects to multiple wired networks through wireless bridge, and provides wireless access point.
- P2MP** In this mode, the device connects to multiple wired networks through wireless bridge, but does not provide wireless access point.
- Router** connect to modem in wired manner, and provide network access point

**Next**

- (3) Select the SSID of CPE2 from the list and click **Next**.

**Quick Setup >> Repeater** ?

Click "Scan", and select the wireless network you want to connect, and click "Next".

Scan  [Scan again](#)

Peer AP1

Peer AP2

Peer AP3

Peer AP4

| Select                              | SSID          | Channel | MAC Address       | Security Mode | Signal Strength |
|-------------------------------------|---------------|---------|-------------------|---------------|-----------------|
| <input checked="" type="checkbox"/> | IP-COM_123456 | 9       | 50:2B:73:FE:F6:69 | WEP           |                 |



Only the WiFi networks which are not encrypted or encrypted using the WEP mode can be found on the list.

- (4) Set the **Authentication Type** and **Default Key** to the same as those of CPE2, enter the key 1, key2, key 3 and key4, and click **Next**.

Quick Setup >> Repeater ?

Ensure that the device uses the same channel, encryption, and encryption algorithm as those of peer AP.  
Enter the key of peer AP1, and click "Next".

Peer AP1 IP-COM\_123456

MAC Address of Peer AP1 50:2B:73:FE:F6:69

Channel

Security Mode

Authentication Type

Default Key

Key 1

Key 2

Key 3

Key 4

- (5) Set the IP address to an unused IP address belonging to the same network segment as that of CPE2. For example, if the IP address of CPE2 is 192.168.2.1, you can set this device's IP address to 192.168.2.X (X ranges from 2 to 254). Then click **Next**.

Quick Setup >> Repeater ?

Set the IP address to an unused IP address belonging to the network segment of peer AP.

IP Address

Subnet Mask

Default Gateway

Primary DNS Server

Secondary DNS Server

- (6) Click **Save**, and wait until the device reboots to activate the settings.

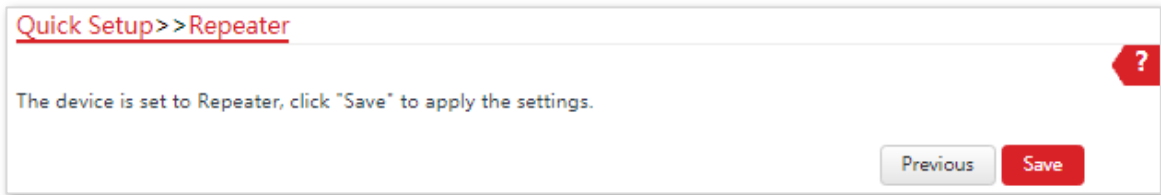

2. Perform the procedure in [step 1](#) above to set **CPE2** to the **Repeater** mode.

---End



You can check the SSID and key of the CPE by choosing **Wireless > Basic** after logging in to the web UI.

### Parameters Description

| Name          | Description  |
|---------------|--|
| Working Modes | <p>It specifies the working mode of the CPE.</p> <ul style="list-style-type: none"><li>– <b>AP mode:</b> in this mode, the device creates a wireless network based on the current wired network.</li><li>– <b>Client mode:</b> in this mode, the device works as a wireless adapter to connect to the wireless network of upstream AP, and does not provide wireless access point.</li><li>– <b>Universal Repeater mode:</b> in this mode, this device expands your WiFi network for broader network coverage.</li></ul> <p>Advantage of Universal Repeater compared with Repeater mode: This mode does not require that the upstream AP supports WDS function.</p> <ul style="list-style-type: none"><li>– <b>WISP mode:</b> connect to an access point provided by ISP in wireless manner.</li><li>– <b>Repeater mode:</b> the CPE connects 2 or more (this device supports 4 at most) wired networks with a wireless link, and can be connected with both wired and wireless clients. To use the Repeater function of this device, the peer AP is required to support WDS function, and use the same radio band as that of this device.</li><li>– <b>P2MP mode:</b> this device connects 2 or more (this device supports 4 at most) wired networks with a wireless link, but cannot be connected with wireless clients. P2MP mode is used to achieve communication between multiple offices of an enterprise in a city.</li><li>– <b>Router mode:</b> in this mode, the PoE LAN/WAN port works as the WAN port and is used to connect to a modem for internet access.</li></ul> |
| Peer AP       | It specifies the wireless network name (SSID) of the peer AP.  |
| Channel       | It specifies the operating channel of the WiFi network to be bridged. It will be automatically populated when you select an SSID to bridge.  |
| Security Mode | <p>It specifies the security mode of the WiFi network to be bridged. It will be automatically populated when you select an SSID to bridge.</p> <p> The Repeater mode only supports WEP and None security modes.</p>   |

## One to Four Bridging

See the following network topology:

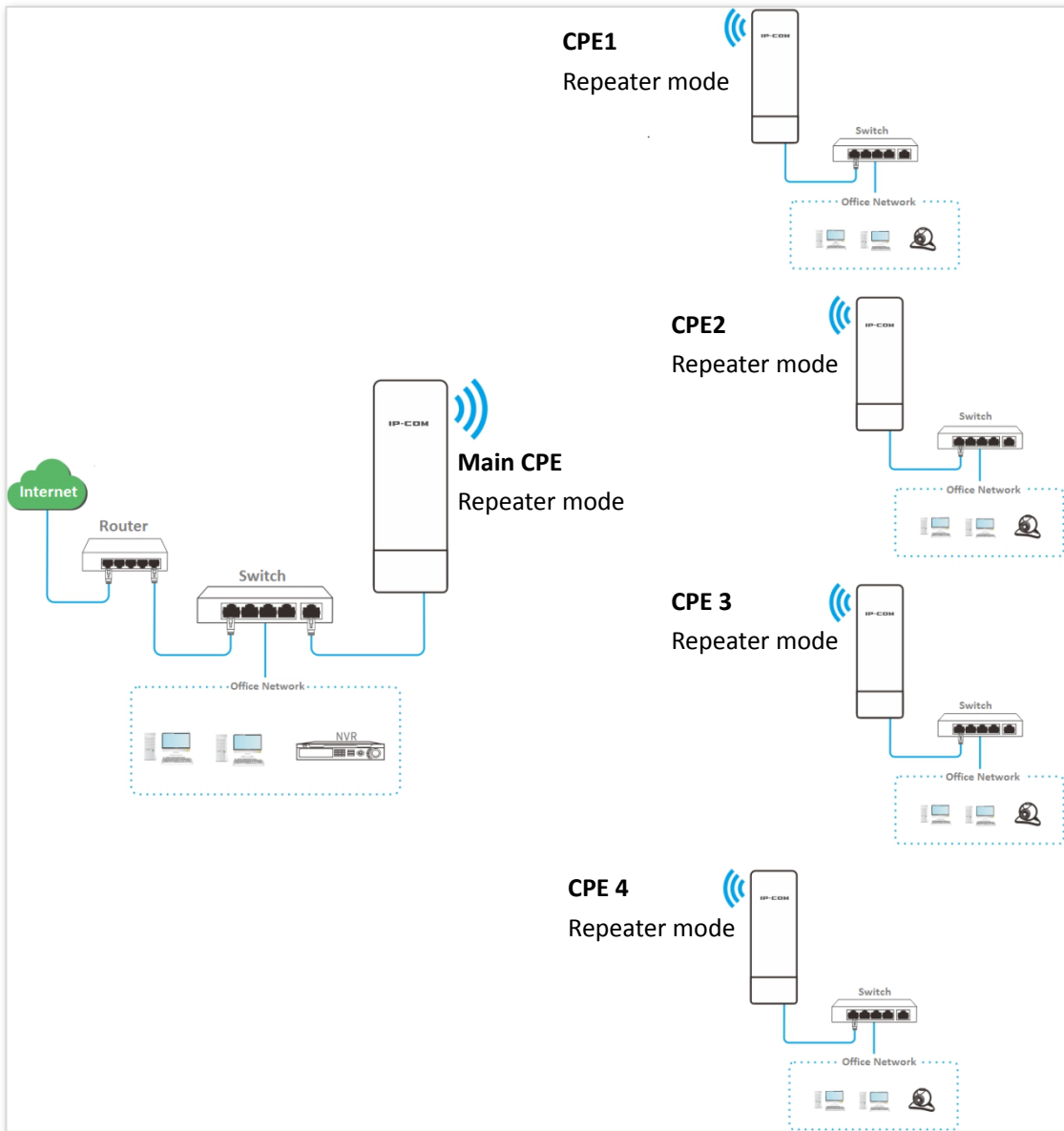

Assume that the related parameters of the main CPE is shown as follows:

- **IP address:** 192.168.2.1
- **SSID:** IP-COM\_1
- **Channel:** 11
- **Security mode:** None

### Configuration procedure:

1. Set CPE1 to **Repeater** mode to bridge the main CPE.
  - (1) Log in to the web UI of CPE1, and choose **Wireless > Basic** to enter the configuration page.
  - (2) Customize an SSID, which is **IP-COM\_2** in this example.
  - (3) Set the **Channel** to the same as that of the main CPE, which is **11** in this example.

- (4) Set the **Security Mode** to the same as that of the main CPE, which is **None** in this example.
- (5) Click **Save** to apply the settings.

**Basic** ?

Enable Wireless

Country/Region

SSID

Broadcast SSID  Enable  Disable

Network Mode

Channel

Transmit Power   
1dBm 29dBm

Channel Bandwidth

Extension Channel

Transmit Rate

Security Mode

Isolate Client  Enable  Disable

Max. Number of Clients  (Range: 1 to 128)

(6) Choose **Quick Setup**, select **Repeater** mode, and click **Next**.

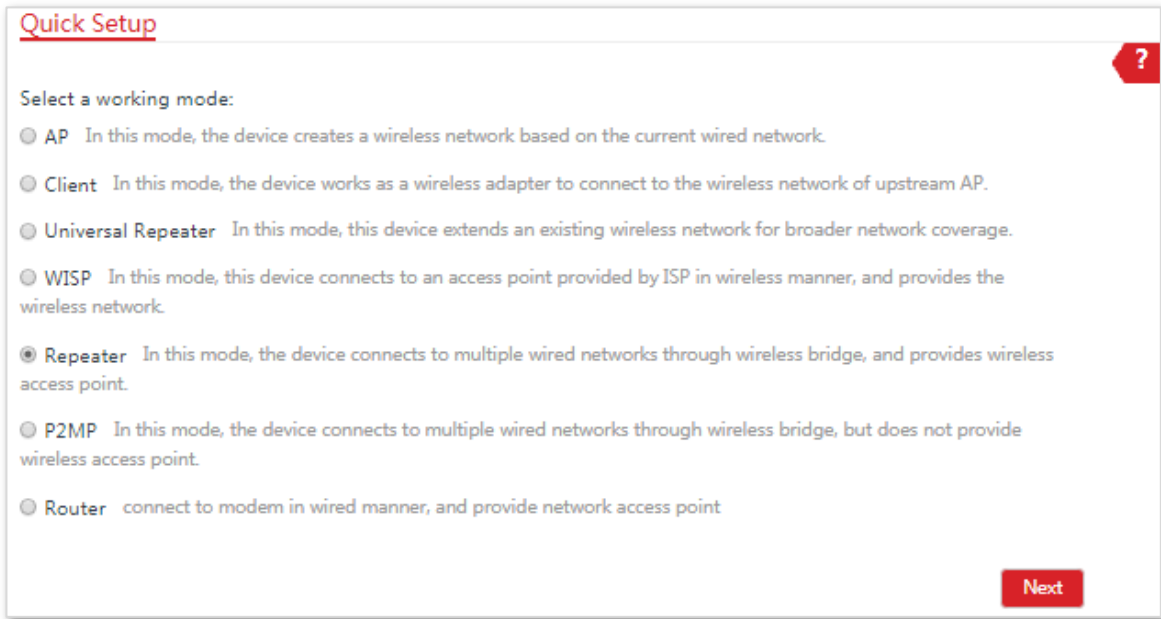

**Quick Setup** ?

Select a working mode:

- AP** In this mode, the device creates a wireless network based on the current wired network.
- Client** In this mode, the device works as a wireless adapter to connect to the wireless network of upstream AP.
- Universal Repeater** In this mode, this device extends an existing wireless network for broader network coverage.
- WISP** In this mode, this device connects to an access point provided by ISP in wireless manner, and provides the wireless network.
- Repeater** In this mode, the device connects to multiple wired networks through wireless bridge, and provides wireless access point.
- P2MP** In this mode, the device connects to multiple wired networks through wireless bridge, but does not provide wireless access point.
- Router** connect to modem in wired manner, and provide network access point

**Next**

(7) Select the SSID of the main CPE from the list, which is **IP-COM\_1** in this example, and click **Next**.



If you cannot scan the SSID of the main CPE from the list, choose **Wireless > Basic** and enable the wireless function. Then try again.

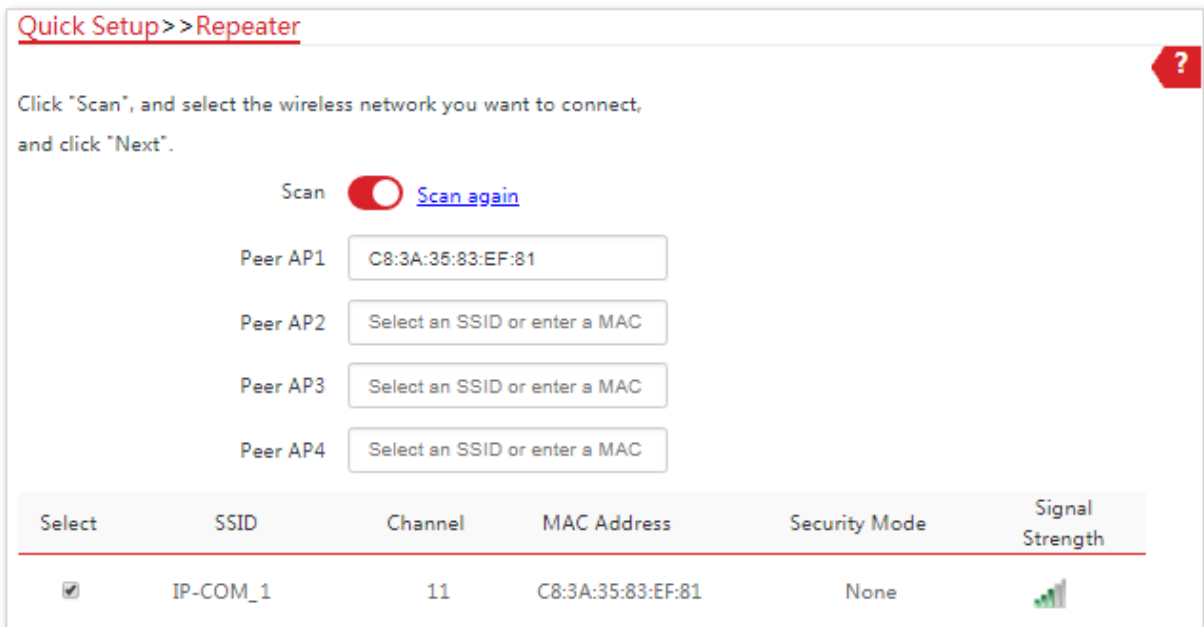

**Quick Setup >> Repeater** ?

Click "Scan", and select the wireless network you want to connect, and click "Next".

Scan  [Scan again](#)

Peer AP1

Peer AP2

Peer AP3

Peer AP4

| Select                              | SSID     | Channel | MAC Address       | Security Mode | Signal Strength   |
|-------------------------------------|----------|---------|-------------------|---------------|---|
| <input checked="" type="checkbox"/> | IP-COM_1 | 11      | C8:3A:35:83:EF:81 | None          |  |

- (8) Click **Next** directly on the following page.

**Quick Setup >> Repeater**

Ensure that the device uses the same channel, encryption, and encryption algorithm as those of peer AP.  
Enter the key of peer AP1, and click "Next".

Peer AP1 IP-COM\_1

MAC Address of Peer AP1 C8:3A:35:83:EF:81

Channel 11(2462)

Security Mode None

Previous Next

- (9) Set the IP address to an unused IP address belonging to the same network segment as that of the main CPE. For example, if the IP address of the main CPE is **192.168.2.1**, you can set this device's IP address to 192.168.2.X (X ranges from 2 to 254). Then click **Next**.

**Quick Setup >> Repeater**

Set the IP address to an unused IP address belonging to the network segment of peer AP.

IP Address 192.168.2.100

Subnet Mask 255.255.255.0

Default Gateway 192.168.2.254

Primary DNS Server 8.8.8.8

Secondary DNS Server 8.8.4.4

Previous Next

- (10) Click **Save**, and wait until the device reboots to activate the settings.

**Quick Setup >> Repeater**

The device is set to Repeater, click "Save" to apply the settings.

Previous Save

2. Perform [Step 1](#) above to set **CPE2**, **CPE3** and **CPE4** to **Repeater** mode respectively.
3. Set the main CPE to **Repeater** mode to bridge CPE1, CPE2, CPE3 and CPE4.
  - (1) Log in to the web UI of the main CPE, and choose **Quick Setup** to enter the configuration page.
  - (2) Select **Repeater** mode, and click **Next**.
  - (3) Select SSIDs of CPE1, CPE2, CPE3 and CPE4 respectively, and click **Next**.
  - (4) Click **Next** at the bottom of the following page.

**Quick Setup >> Repeater** ?

Click "Scan", and select the wireless network you want to connect, and click "Next".

Scan  [Scan again](#)

Peer AP1

Peer AP2

Peer AP3

Peer AP4

| Select                              | SSID     | Channel | MAC Address       | Security Mode | Signal Strength |
|-------------------------------------|----------|---------|-------------------|---------------|-----------------|
| <input checked="" type="checkbox"/> | IP-COM_2 | 11      | 66:09:80:6C:B4:A8 | None          |                 |
| <input checked="" type="checkbox"/> | IP-COM_3 | 11      | 00:90:4C:88:88:89 | None          |                 |
| <input checked="" type="checkbox"/> | IP-COM_4 | 11      | C8:3A:35:83:F0:78 | None          |                 |
| <input checked="" type="checkbox"/> | IP-COM_5 | 11      | 1A:69:DA:96:CB:4E | None          |                 |

(5) Click **Next** on the following page.

**Quick Setup >> Repeater** ?

Ensure that the device uses the same channel, encryption, and encryption algorithm as those of peer AP.  
Enter the key of peer AP1, and click "Next".

Peer AP1 IP-COM\_2

MAC Address of Peer AP1 66:09:80:6C:B4:A8

Channel

Security Mode

- (6) Click **Save**, and wait until the device reboots to activate the settings.

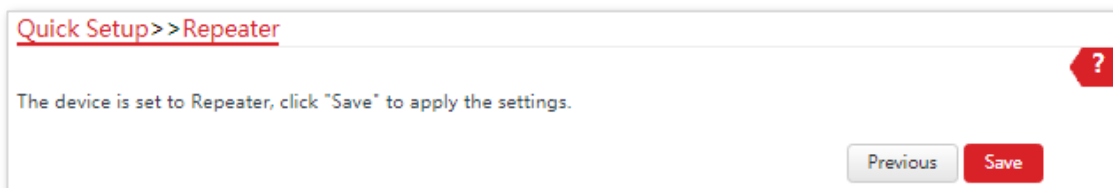

---End

## 4.6 P2MP Mode (Only for CPE9)

### 4.6.1 Overview

In P2MP mode, this device connects 2 or more (this device supports 4 at most) wired networks with a wireless link, but cannot be connected with wireless clients. P2MP mode is used to achieve communication between multiple offices of an enterprise in a city.

The CPE in P2MP mode can work with the CPE in Repeater or P2MP mode. It supports one to four bridging at most.

### 4.6.2 Setting up P2MP Mode

The configuration procedure of P2MP mode is similar to that of Repeater mode. The following example shows that the main CPE in P2MP mode bridges to four CPEs in Repeater mode.

See the following network topology:

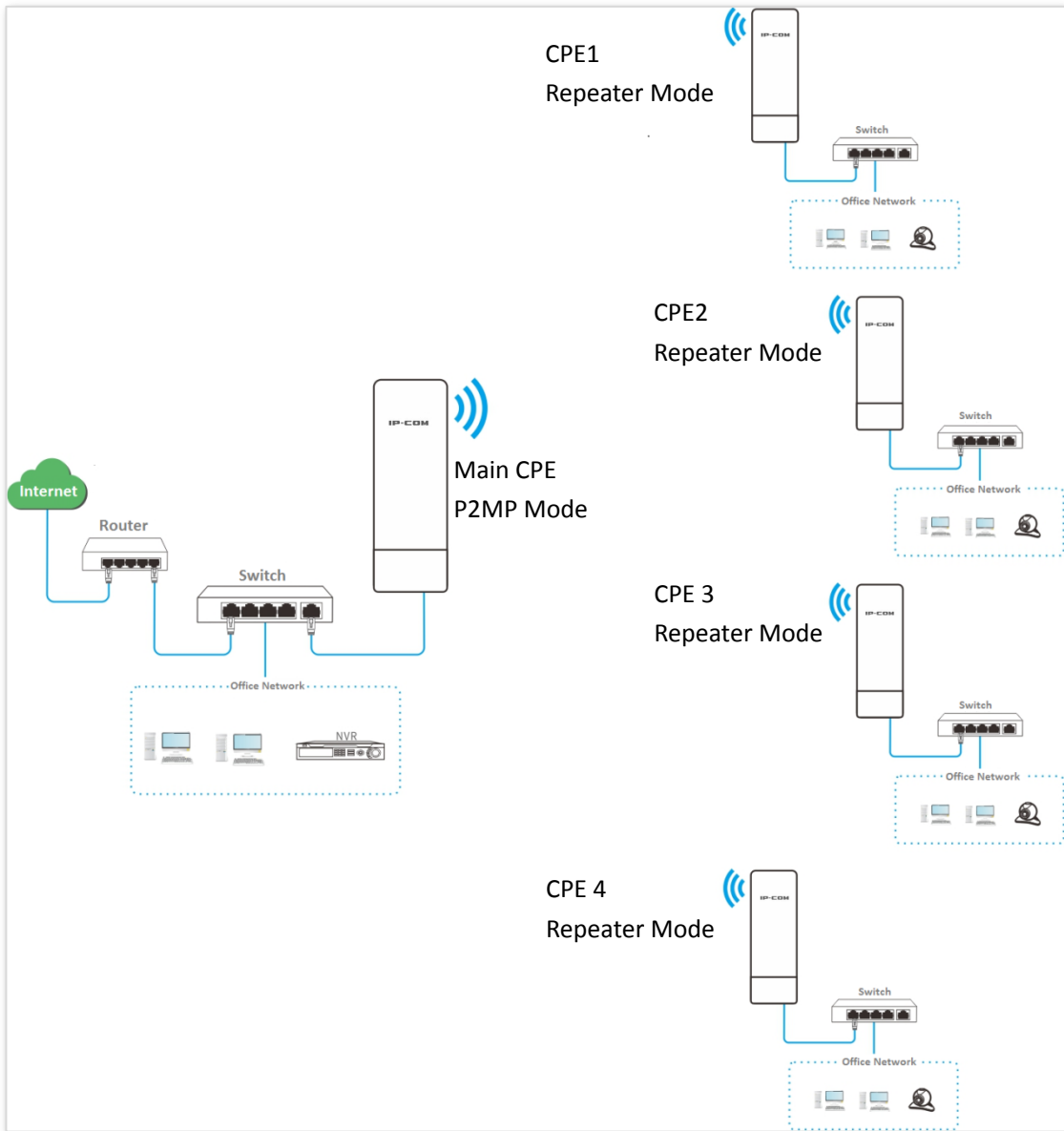

Assume that the related parameters of the main CPE is shown as follows:

- **IP Address:** 192.168.2.1
- **SSID:** IP-COM\_1
- **Channel:** 11
- **Security Mode:** None

**Configuration Procedure:**

1. Set the CPE1 to **Repeater** mode to bridge the main CPE.
  - (1) Log in to the web UI of CPE1, and choose **Wireless > Basic** to enter the configuration page.
  - (2) Customize the **SSID**, which is **IP-COM\_2** in this example.
  - (3) Set the **Channel** to the same as that of the main CPE, which is **11** in this example.
  - (4) Set the **Security mode** to the same as that of the main CPE, which is **None** in this example.

- (5) Click **Save** to apply the settings.

The screenshot shows the 'Basic' configuration page for an outdoor point-to-point CPE. The page is titled 'Basic' in the top left corner. A red question mark icon is in the top right corner. The settings are as follows:

- Enable Wireless:
- Country/Region: China
- SSID: IP-COM\_2 (highlighted with a blue dashed box)
- Broadcast SSID:  Enable  Disable
- Network Mode: 11b/g/n
- Channel: 11(2482) (highlighted with a blue dashed box)
- Transmit Power: 1dBm to 29dBm (slider)
- Channel Bandwidth: Auto
- Extension Channel: 7(2442)
- Transmit Rate: Auto
- Security Mode: None (highlighted with a blue dashed box)

- (6) Choose **Quick Setup**, select **Repeater** mode, and click **Next**.

- (7) Select the SSID of the main CPE, which is **IP-COM\_1** in this example, and click **Next**.



If you cannot scan the SSID of the main CPE from the list, choose **Wireless > Basic** and enable the wireless function. Then try again.

**Quick Setup >> Repeater**

Click "Scan", and select the wireless network you want to connect, and click "Next".

Scan  [Scan again](#)

Peer AP1

Peer AP2

Peer AP3

Peer AP4

| Select                              | SSID     | Channel | MAC Address       | Security Mode | Signal Strength |
|-------------------------------------|----------|---------|-------------------|---------------|-----------------|
| <input checked="" type="checkbox"/> | IP-COM_1 | 11      | C8:3A:35:83:EF:81 | None          |                 |

- (8) Click **Next** on the following page.

**Quick Setup >> Repeater**

Ensure that the device uses the same channel, encryption, and encryption algorithm as those of peer AP.  
Enter the key of peer AP1, and click "Next".

Peer AP1 IP-COM\_1

MAC Address of Peer AP1 C8:3A:35:83:EF:81

Channel

Security Mode

- (9) Set the IP address to an unused IP address belonging to the same network segment as that of the main CPE. For example, if the IP address of the main CPE is **192.168.2.1**, you can set this device's IP address to 192.168.2.X (X ranges from 2 to 254). Then click **Next**.

Quick Setup >> Repeater

Set the IP address to an unused IP address belonging to the network segment of peer AP.

|                      |               |
|----------------------|---------------|
| IP Address           | 192.168.2.100 |
| Subnet Mask          | 255.255.255.0 |
| Default Gateway      | 192.168.2.254 |
| Primary DNS Server   | 8.8.8.8       |
| Secondary DNS Server | 8.8.4.4       |

Previous Next

- (10) Click **Save**, and wait until the device reboots to activate the settings.

Quick Setup >> Repeater

The device is set to Repeater, click "Save" to apply the settings.

Previous Save

2. Perform [Step 1](#) above to set **CPE2**, **CPE3**, and **CPE4** to **Repeater** modes respectively.
3. Set the main CPE to P2MP mode to bridge CPE1, CPE2, CPE3 and CPE4.
  - (1) Log in to the web UI of the main CPE, and choose **Quick Setup** to enter the configuration page.

- (2) Select the SSIDs of CPE1, CPE2, CPE3 and CPE4 respectively, and click **Next**.

Quick Setup>>P2MP ?

Click "Scan", and select the wireless network you want to connect, and click "Next".





Scan  [Scan again](#)

Peer AP1

Peer AP2

Peer AP3

Peer AP4

| Select                              | SSID     | Channel | MAC Address       | Security Mode | Signal Strength  |
|-------------------------------------|----------|---------|-------------------|---------------|--|
| <input checked="" type="checkbox"/> | IP-COM_2 | 11      | 66:09:80:6C:B4:A8 | None          |   |
| <input checked="" type="checkbox"/> | IP-COM_3 | 11      | 00:90:4C:88:88:89 | None          |   |
| <input checked="" type="checkbox"/> | IP-COM_4 | 11      | C8:3A:35:83:F0:78 | None          |   |
| <input checked="" type="checkbox"/> | IP-COM_5 | 11      | 1A:69:DA:96:CB:4E | None          |  |

- (3) Click **Next** on the following page.

Quick Setup>>P2MP ?

Ensure that the device uses the same channel, encryption, and encryption algorithm as those of peer AP.  
Enter the key of peer AP1, and click "Next".

Peer AP1 IP-COM\_2

MAC Address of Peer AP1 66:09:80:6C:B4:A8

Channel

Security Mode

- (4) Click **Next** on the following page.

Quick Setup>>P2MP ?

Set the IP address to an unused IP address belonging to the network segment of peer AP.

|                      |  |
|----------------------|--|
| IP Address           | <input type="text" value="192.168.2.1"/>   |
| Subnet Mask          | <input type="text" value="255.255.255.0"/> |
| Default Gateway      | <input type="text" value="192.168.2.254"/> |
| Primary DNS Server   | <input type="text" value="8.8.8.8"/>       |
| Secondary DNS Server | <input type="text" value="8.8.4.4"/>       |

- (5) Click **Save**, and wait until the device reboots to activate the settings.

Quick Setup>>P2MP ?

The device is set to P2MP, click "Save" to apply the settings.

---End

## Parameters Description

| Name          | Description  |
|---------------|--|
|               | <p>It specifies the working mode of the CPE.</p> <ul style="list-style-type: none"><li>– <b>AP mode:</b> in this mode, the device creates a wireless network based on the current wired network.</li><li>– <b>Client mode:</b> in this mode, the device works as a wireless adapter to connect to the wireless network of upstream AP, and does not provide wireless access point.</li><li>– <b>Universal Repeater mode:</b> in this mode, this device expands your WiFi network for broader network coverage.</li></ul> <p>Advantage of Universal Repeater compared with Repeater mode: This mode does not require that the upstream AP supports WDS function.</p>  |
| Working Modes | <ul style="list-style-type: none"><li>– <b>WISP mode:</b> connect to an access point provided by ISP in wireless manner.</li><li>– <b>Repeater mode:</b> the CPE connects 2 or more (this device supports 4 at most) wired networks with a wireless link, and can be connected with both wired and wireless clients. To use the Repeater function of this device, the peer AP is required to support WDS function, and use the same radio band as that of this device.</li><li>– <b>P2MP mode:</b> this device connects 2 or more (this device supports 4 at most) wired networks with a wireless link, but cannot be connected with wireless clients. P2MP mode is used to achieve communication between multiple offices of an enterprise in a city.</li><li>– <b>Router mode:</b> in this mode, the PoE LAN/WAN port works as the WAN port and is used to connect to a modem for internet access.</li></ul> |
| Peer AP       | It specifies the wireless network name (SSID) of the peer AP.  |
| Channel       | It specifies the operating channel of the WiFi network to be bridged. It will be automatically populated when you select an SSID to bridge.  |
|               | It specifies the security mode of the WiFi network to be bridged. It will be automatically populated when you select an SSID to bridge.  |
| Security Mode |  <p>The P2MP mode only supports WEP and None security modes.</p>  |

## 4.7 Router Mode (Only for CPE9)

### 4.7.1 Overview

If this device works in Router mode, the PoE LAN/WAN port works as WAN port and is used to connect to a modem for internet access.

See the following network topology:

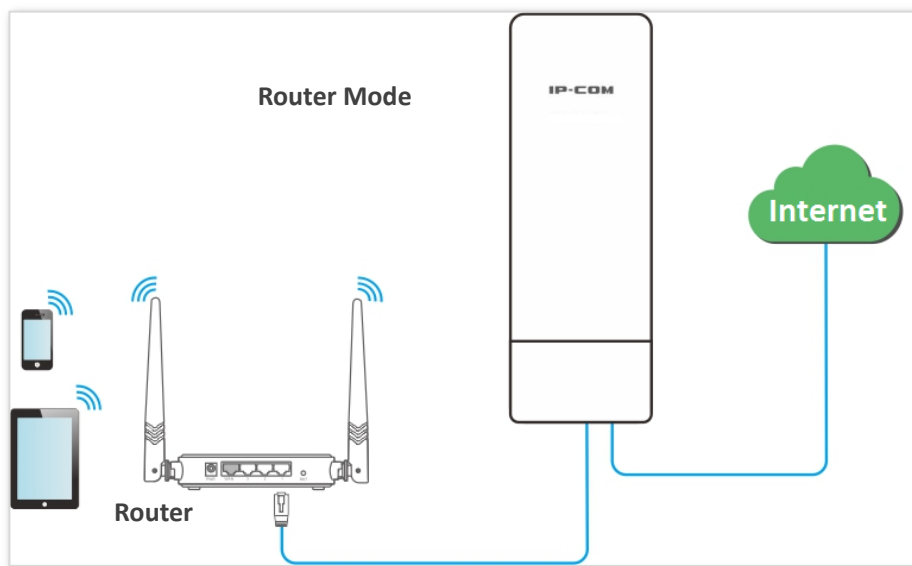

### 4.7.2 Setting up the Router Mode

**Configuration Procedure:**

1. Log in to the web UI of the CPE, and choose **Quick Setup** to enter the configuration page.
2. Select **Router** mode, and click **Next**.
3. Select your internet connection type, and set the related parameters. Take PPPoE as an example here.
  - (1) Select **PPPoE**.
  - (2) Enter the PPPoE user name and password provided by your internet service provider, which are both **admin** in this example.

- (3) Click **Next**.

Quick Setup>>Router

Please select an internet connection type, and enter the internet parameters provided by your ISP. and click "Next".

Internet Connection Type  DHCP (Dynamic IP)  Static IP Address  PPPoE

PPPoE User Name

PPPoE Password

- 4. Set wireless parameters of the CPE.
  - (1) Customize a SSID, which is **IP-COM\_123456** in this example.
  - (2) Select a security mode, which is **WPA2-PSK** in this example.
  - (3) Set a **Key** for the wireless network, and click **Next**.

Quick Setup>>Router

You can set up your wireless network name and wireless password here. Note down your wireless password.

SSID

Channel

Security Mode

Encryption Algorithm  AES  TKIP  TKIP&AES

Key

- 5. Click **Save**, and wait until the device reboots to activate the settings.

Quick Setup>>Router

The device is set to Router, click "Save" to apply the settings.

---End

## Parameters Description

| Name                     | Description  |
|--------------------------|--|
|                          | <p>It specifies the working mode of the CPE.</p> <ul style="list-style-type: none"><li>– <b>AP mode:</b> in this mode, the device creates a wireless network based on the current wired network.</li><li>– <b>Client mode:</b> in this mode, the device works as a wireless adapter to connect to the wireless network of upstream AP, and does not provide wireless access point.</li><li>– <b>Universal Repeater mode:</b> in this mode, this device expands your WiFi network for broader network coverage.</li></ul> <p>Advantage of Universal Repeater compared with Repeater mode: This mode does not require that the upstream AP supports WDS function.</p>  |
| Working Modes            | <ul style="list-style-type: none"><li>– <b>WISP mode:</b> connect to an access point provided by ISP in wireless manner.</li><li>– <b>Repeater mode:</b> the CPE connects 2 or more (this device supports 4 at most) wired networks with a wireless link, and can be connected with both wired and wireless clients. To use the Repeater function of this device, the peer AP is required to support WDS function, and use the same radio band as that of this device.</li><li>– <b>P2MP mode:</b> this device connects 2 or more (this device supports 4 at most) wired networks with a wireless link, but cannot be connected with wireless clients. P2MP mode is used to achieve communication between multiple offices of an enterprise in a city.</li><li>– <b>Router mode:</b> in this mode, the PoE LAN/WAN port works as the WAN port and is used to connect to a modem for internet access.</li></ul> |
| Internet Connection Type | <p>The CPE in Router mode supports three internet connection types:</p> <ul style="list-style-type: none"><li>– <b>DHCP (Dynamic IP):</b> The CPE obtains the IP address and other parameters from the DHCP server of upstream device for internet access.</li><li>– <b>Static IP Address:</b> The CPE accesses the internet using the IP address, subnet mask, default gateway and DNS server IP addresses you manually entered.</li><li>– <b>PPPoE:</b> The CPE accesses the internet using the PPPoE user name and password provided by the ISP.</li></ul>  |
| SSID                     | <p>It specifies the wireless network name of the CPE.</p>  |
| Channel                  | <p>It specifies the operating channel of the WiFi network to be bridged. It will be automatically populated when you select an SSID to bridge.</p>   |
| Security Mode            | <p>It specifies the security mode of the WiFi network of the CPE. It includes <a href="#">None</a>, <a href="#">WPA-PSK</a>, <a href="#">WPA2-PSK</a>, and <a href="#">Mixed WPA/WPA2-PSK</a>.</p> <p>Clicking the hyperlink navigates you to the elaborated description of the corresponding security mode.</p>   |

# 5 Status

This module allows you to view the information of system and wireless network.

## 5.1 System Status

Log in to the web UI of the CPE, and choose **Status**. You can view the system status here.

If the CPE is set to AP mode, Client mode, Universal Repeater mode, Repeater mode or P2MP mode, the system status is shown as follows:



| System Status    |                     |                   |                    |
|------------------|---------------------|-------------------|--------------------|
| Device Name      | CPE9V1.0            | LAN MAC Address   | 50:2B:73:FE:F4:98  |
| Uptime           | 1 h56 m47 s         | WLAN MAC Address  | 50:2B:73:FE:F4:99  |
| System Time      | 2018-08-08 18:13:33 | PoE LAN/LAN Speed | 100 Mbps Full-d... |
| Firmware Version | V1.0.0.2(2233)      | LAN IP Address    | 192.168.2.1        |
| Hardware Version | V1.0                |                   |                    |

### Parameters Description

| Name             | Description   |
|------------------|---|
| Device Name      | It specifies the name of this device. If this device is not the only one of its kind in the network, this name helps you identify the device. You can change the name of this device on the <b>Network &gt; LAN Setup</b> page. |
| Uptime           | It specifies time during which this device is operating.  |
| System Time      | It specifies the current system time of this device.  |
| Firmware Version | It specifies the system software version number of this device.   |
| Hardware Version | It specifies the hardware version of this device.   |
| LAN MAC Address  | It specifies the MAC address of LAN port of this device. When connecting to another device using an Ethernet cable, the CPE uses this MAC address to communicate with the device.   |
| WLAN MAC Address | It specifies the MAC address of the wireless network of this device.  |

| Name              | Description   |
|-------------------|---|
| PoE LAN/LAN Speed | It specifies the connection status of PoE LAN/WAN and LAN ports. It includes connection rate and duplex mode.   |
| LAN IP Address    | It specifies the IP address (also named management IP address) of this device. By default, it is 192.168.2.1. You can access the web UI of this device using this IP address. |

If the CPE is set to WISP or Router mode, the system status is shown as follows:

| System Status     |                     |                      |                    |
|-------------------|---------------------|----------------------|--------------------|
| Device Name       | CPE9V1.0            | LAN MAC Address      | 50:2B:73:FE:F4:98  |
| Uptime            | 5 m28 s             | WLAN MAC Address     | 50:2B:73:FE:F4:99  |
| System Time       | 2018-08-10 08:55:56 | PoE LAN/LAN Speed    | 100 Mbps Full-d... |
| Firmware Version  | V1.0.0.2(2233)      | LAN IP Address       | 192.168.2.1        |
| Hardware Version  | V1.0                | WAN IP Address       | 192.168.0.102      |
| Connection Status | Connected           | Primary DNS Server   | 192.168.0.1        |
| Connection Type   | DHCP (Dynamic IP)   | Secondary DNS Server | 0.0.0.0            |
| Default Gateway   | 192.168.0.1         |                      |                    |

### Parameters Description

| Name                 | Description  |
|----------------------|--|
| Connection Status    | It specifies the connection status of WAN port of this device in WISP or Router mode.      |
| Connection Type      | It specifies the internet connection type of this device in WISP or Router mode.           |
| WAN IP Address       | It specifies the IP address of WAN port of this device in WISP or Router mode.             |
| Default Gateway      | It specifies the default gateway address of this device in WISP or Router mode.            |
| Primary DNS Server   | It specifies the IP address of primary DNS server of this device in WISP or Router mode.   |
| Secondary DNS Server | It specifies the IP address of secondary DNS server of this device in WISP or Router mode. |

## 5.2 Wireless Status

Log in to the web UI of the CPE, and choose **Status**. You can view wireless status here, including working mode, SSID, security mode, and so on.

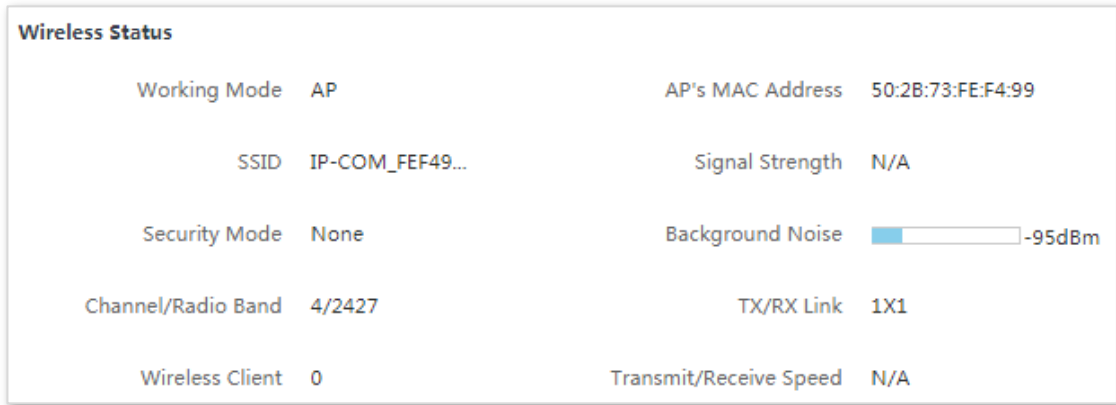

### Parameters Description

| Name                   | Description   |
|------------------------|---|
| Working Mode           | It specifies the working mode the device operates.  |
| SSID                   | It specifies the wireless network name of this device.  |
| Security Mode          | It specifies the security mode of the wireless network of this device.  |
| Channel/Radio Band     | It specifies the channel and radio band used by this device to transmit radio signals.  |
| Wireless Client        | It specifies the number of wireless clients connected to this device.   |
| AP's MAC Address       | It displays "No Peer AP" if the device works in AP or Router mode. And in other modes, it displays the MAC address of peer AP to which this device bridged.   |
| Signal Strength        | It displays the signal strength of the first device connected to the wireless network of the device when it works in AP or Router mode. It displays the received signal strength from peer AP when the device works in Client, Universal Repeater, WISP, Repeater or P2MP mode.   |
| Background Noise       | It specifies the strength of radio interference signals in the ambient environment that interfere with the channel of this device. Larger absolute value indicates less interference.   |
| TX/TR Link             | It specifies the number of spatial streams the device is transmitting or receiving.   |
| Transmit/Receive Speed | It specifies the wireless transmitting/receiving rate. <ul style="list-style-type: none"><li>- In AP or Router mode: it displays the transmitting/receiving rate of the first device connected to the wireless network of this device.</li><li>- In Client, Universal Repeater, WISP, Repeater, or P2MP mode: it displays transmitting/receiving rate of this device.</li></ul> |

## 5.3 Statistics

Log in to the web UI of the CPE, and choose **Status**. You can view statistics information here, including throughput, wireless client, interface and so on.

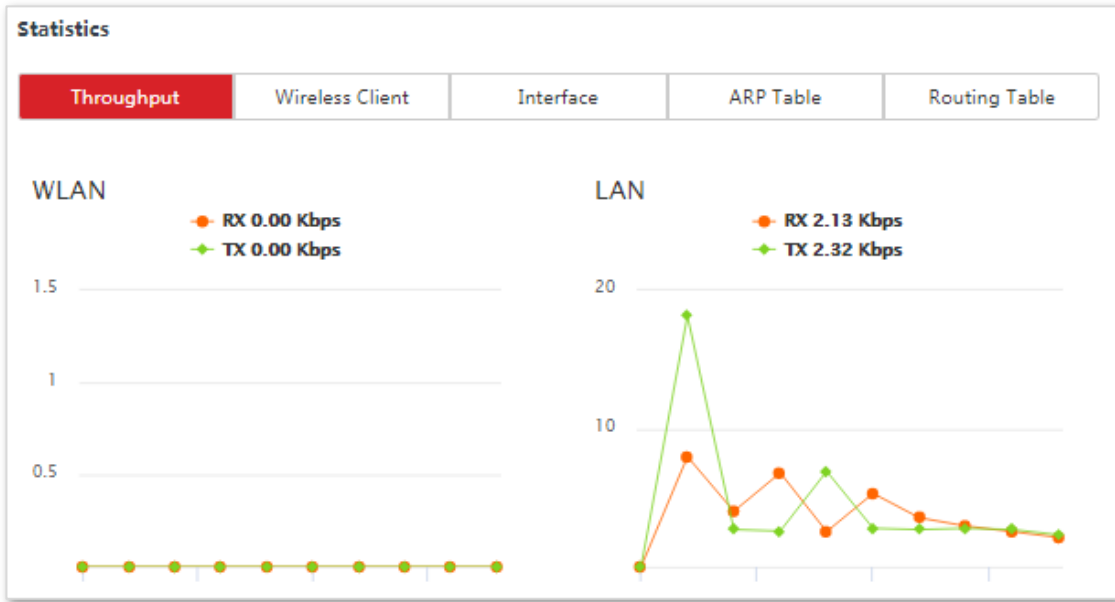

### 5.3.1 Throughput

It displays the throughput of WLAN and LAN ports here.

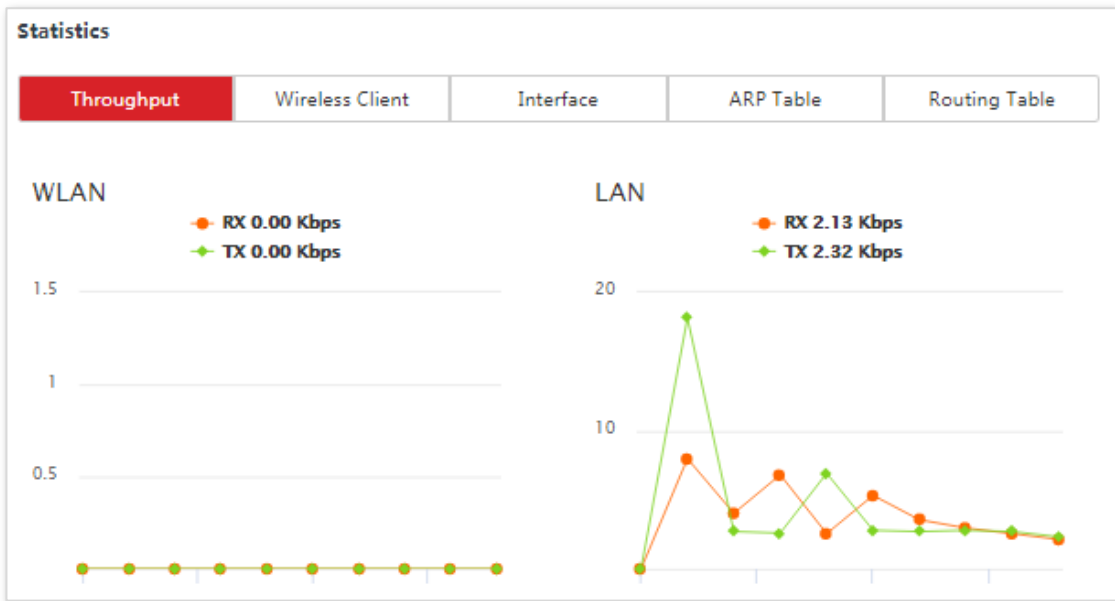

## 5.3.2 Wireless Client

It displays the information of wireless clients when the CPE works in AP, Repeater, P2MP, or Router mode.

| Statistics    |                   |              |                  |               |                     |
|---------------|-------------------|--------------|------------------|---------------|---------------------|
| Throughput    | Wireless Client   | Interface    | ARP Table        | Routing Table |                     |
| IP Address    | MAC Address       | Signal/Noise | Transmit/Receive | CCQ           | Connection Duration |
| 192.168.2.177 | 8C:0D:76:E8:43:15 | -65/-92dBm   | 0/26Mbps         | 94%           | 23 s                |

### Parameters Description

| Name                | Description  |
|---------------------|--|
| IP Address          | It specifies the IP address of the corresponding wireless client.  |
| MAC Address         | It specifies the MAC address of the corresponding wireless client.   |
| Signal/Noise        | It specifies the WiFi signal strength and electromagnet interference signal strength of the corresponding wireless client. |
| Transmit/Receive    | It specifies the transmitting and receiving rate of the corresponding client.  |
| CCQ                 | It specifies the connection quality of the corresponding client. Higher percentage indicates better connection quality.    |
| Connection Duration | It specifies the time that has elapsed since the wireless client is connected to the wireless network of the CPE.          |

### 5.3.3 Upstream AP

This function is available only when the CPE works in Client, Universal Repeater, or WISP mode.

| Statistics |                    |              |                  |               |                     |
|------------|--------------------|--------------|------------------|---------------|---------------------|
| Throughput | <b>Upstream AP</b> | Interface    | ARP Table        | Routing Table |                     |
| IP Address | MAC Address        | Signal/Noise | Transmit/Receive | CCQ           | Connection Duration |
| 0.0.0.0    | C8:3A:35:84:3F:01  | -42/-95dBm   | 0/1Mbps          | 100%          | 2 s                 |

#### Parameters Description

| Name                | Description  |
|---------------------|--|
| IP Address          | It specifies the IP address of the upstream device.  |
| MAC Address         | It specifies the MAC address of the upstream device.   |
| Signal/Noise        | It specifies the WiFi signal strength and electromagnet interference signal strength of the upstream device.       |
| Transmit/Receive    | It specifies the transmitting and receiving rate of the upstream device.   |
| CCQ                 | It specifies the connection quality of the upstream device. Higher percentage indicates better connection quality. |
| Connection Duration | It specifies the time that has elapsed since this CPE bridges to the upstream device.                              |

### 5.3.4 Interface

It displays the IP address, MAC address and traffic information of the interfaces of the CPE.

| Statistics |                 |                   |                  |               |                     |                |
|------------|-----------------|-------------------|------------------|---------------|---------------------|----------------|
| Throughput | Wireless Client | <b>Interface</b>  | ARP Table        | Routing Table |                     |                |
| Interface  | IP Address      | MAC Address       | Received Packets | Receive Error | Transmitted Packets | Transmit Error |
| LAN        | 0.0.0.0         | 50:2B:73:FE:F4:98 | 0                | 0             | 0                   | 0              |
| Bridge     | 192.168.2.1     | 50:2B:73:FE:F4:98 | 928              | 0             | 708                 | 0              |
| WLAN       | 0.0.0.0         | 50:2B:73:FE:F4:99 | 122              | 0             | 284                 | 0              |

### Parameters Description

| Name                | Description   |
|---------------------|---|
| Interface           | It displays the wired interface, bridge interface, and WLAN interface of the CPE.       |
| IP Address          | It displays the IP addresses of wired interface, bridge interface, and WLAN interface.  |
| MAC Address         | It displays the MAC addresses of wired interface, bridge interface, and WLAN interface. |
| Received Packets    | It displays the received and transmitted packets of the interface.                      |
| Transmitted Packets |   |
| Receive Error       | It displays the received and transmitted error packets of the interface.                |
| Transmit Error      |   |

## 5.3.5 ARP Table

It specifies the current ARP table of the CPE.

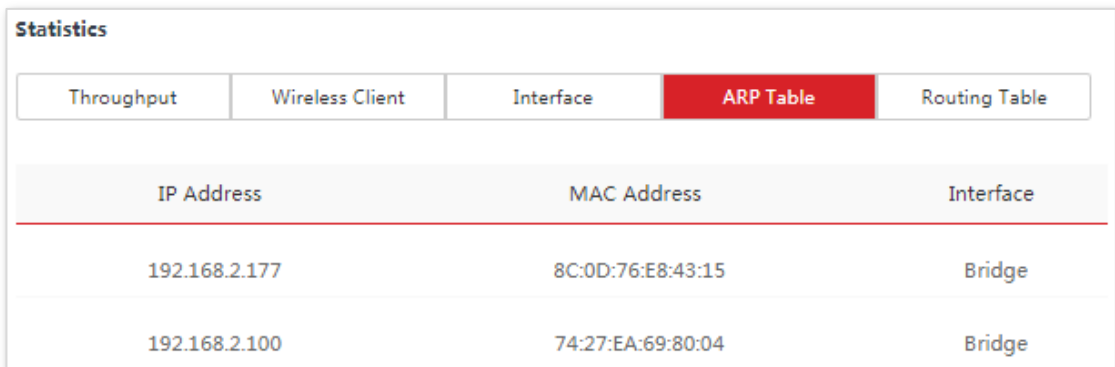

The screenshot shows a 'Statistics' window with several tabs: 'Throughput', 'Wireless Client', 'Interface', 'ARP Table' (which is selected and highlighted in red), and 'Routing Table'. Below the tabs is a table with three columns: 'IP Address', 'MAC Address', and 'Interface'. The table contains two rows of data.

| IP Address    | MAC Address       | Interface |
|---------------|-------------------|-----------|
| 192.168.2.177 | 8C:0D:76:E8:43:15 | Bridge    |
| 192.168.2.100 | 74:27:EA:69:80:04 | Bridge    |

### Parameters Description

| Name        | Description   |
|-------------|---|
| IP Address  | It specifies the IP address of the host in the APR table.     |
| MAC Address | It specifies the MAC address corresponding to the IP address. |
| Interface   | It specifies the interface used to communicate with the host. |

## 5.3.6 Routing Table

It specifies the destination networks that the CPE can access.

| Statistics          |                 |               |           |               |
|---------------------|-----------------|---------------|-----------|---------------|
| Throughput          | Wireless Client | Interface     | ARP Table | Routing Table |
| Destination Network | Subnet Mask     | Next Hop      | Interface |               |
| 0.0.0.0             | 0.0.0.0         | 192.168.2.254 | Bridge    |               |
| 192.168.2.0         | 255.255.255.0   | 0.0.0.0       | Bridge    |               |

### Parameters Description

| Name                | Description  |
|---------------------|--|
| Destination Network | It specifies the IP address of the destination network.  |
| Subnet Mask         | It specifies the subnet mask of the destination network.   |
| Next Hop            | It specifies the IP address of entrance of the next hop route when the packets egress from the interface of the CPE. |
| Interface           | It specifies the interface that the packets egress.  |

# 6 Network

## 6.1 LAN Setup

### 6.1.1 Overview

Log in to the web UI of the CPE, and choose **Network > LAN Setup** to enter the page.

This page enables you to view the MAC address of the LAN port, and set up the device name, and type of obtaining an IP address and related parameters.

LAN Setup

MAC Address 50:2B:73:FE:F4:98

IP Address Type Static IP Address

IP Address 192.168.2.1

Subnet Mask 255.255.255.0

Default Gateway 192.168.2.254

Primary DNS Server 8.8.8.8

Secondary DNS Server 8.8.4.4

Device Name CPE9V1.0

Save Cancel

#### Parameters Description

| Name            | Description   |
|-----------------|---|
| MAC Address     | It specifies the MAC address of LAN port.<br>The default SSID of the CPE is <b>IP-COM_XXXXXX</b> , and XXXXXX is the last six characters of this MAC address.                             |
| IP Address Type | It specifies the type of obtaining an IP address. The default is <b>Static IP Address</b> .<br>Static IP Address: Specify the IP address, subnet mask, default gateway, and DNS server IP |

| Name                 | Description  |
|----------------------|--|
|                      | addresses manually.  |
| IP Address           | <p>DHCP (Dynamic IP Address): The CPE obtains an IP address, subnet mask, default gateway and DNS server IP address from the DHCP server in the network.</p> <p> <b>Tip</b></p> <p>If the IP Address Type is set to DHCP (Dynamic IP Address), you need to check the CPE's IP address on the clients list of the DHCP server in the network, and use this IP address to log in.</p> |
| Subnet Mask          | It specifies the subnet mask of the CPE's IP address. The default is <b>255.255.255.0</b> .  |
| Default Gateway      | <p>It specifies the default gateway of the CPE.</p> <p>You can set it to the IP address of the egress router to enable the CPE to access the internet.</p>   |
| Primary DNS Server   | <p>It specifies the primary DNS server IP address of the CPE.</p> <p>If the egress router has the DNS agency function, it can be set to the LAN IP address the egress router. Otherwise, specify a DNS server IP address manually.</p>   |
| Secondary DNS Server | <p>It specifies the secondary DNS server IP address of the CPE.</p> <p>If there are two DNS server IP addresses, enter one in this box.</p>  |
| Device Name          | <p>It specifies the name of the CPE. The default name indicates the CPE's model and version.</p> <p>You are recommended to change the name of the CPE to indicate the location of the CPE, so that you can easily identify the CPE when there are multiple CPEs in the network.</p>  |

## 6.1.2 Changing the LAN IP Address

### Manually Setting the IP Address

In this mode, you must manually set the IP address, subnet mask, gateway IP address, and DNS server IP addresses of the CPE. Therefore, this mode is recommended if you need to deploy only a few CPEs.

#### Configuration Procedure:

1. Choose **Network > LAN Setup** to enter the configuration page.
2. Set **IP Address Type** to **Static IP Address**.
3. Set **IP Address**, **Subnet Mask**, **Default Gateway**, and **Primary DNS Server**. If another DNS server is available, set **Secondary DNS Server** to the IP address of the additional DNS server.

4. Click **Save**.

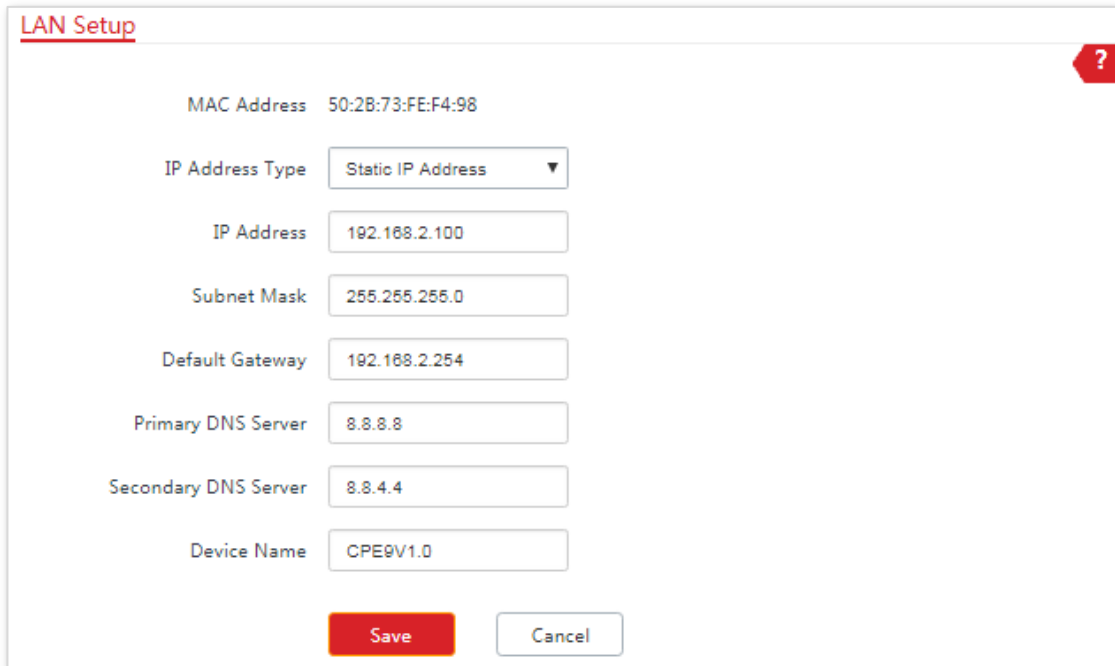

The screenshot shows a 'LAN Setup' configuration window. At the top left, the title 'LAN Setup' is underlined in red. At the top right, there is a red question mark icon. The window contains the following fields and values:

|                      |                   |
|----------------------|-------------------|
| MAC Address          | 50:28:73:FE:F4:98 |
| IP Address Type      | Static IP Address |
| IP Address           | 192.168.2.100     |
| Subnet Mask          | 255.255.255.0     |
| Default Gateway      | 192.168.2.254     |
| Primary DNS Server   | 8.8.8.8           |
| Secondary DNS Server | 8.8.4.4           |
| Device Name          | CPE0V1.0          |

At the bottom of the window, there are two buttons: a red 'Save' button and a white 'Cancel' button with a grey border.

5. Click **OK** on the pop-up window.

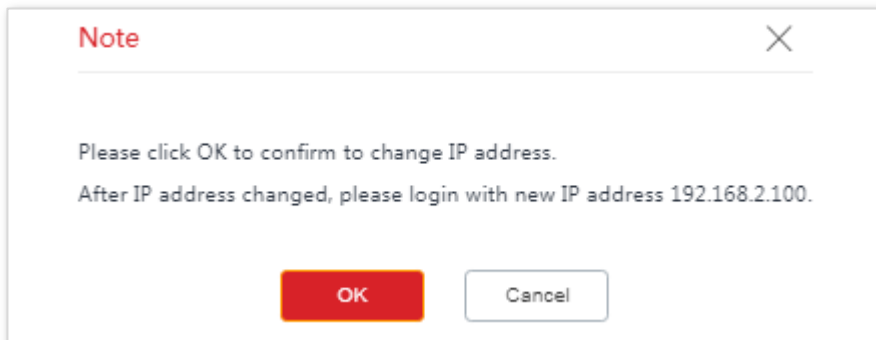

The screenshot shows a 'Note' pop-up window with a red title bar and a close button (X) in the top right corner. The text inside the window reads:

Please click OK to confirm to change IP address.  
After IP address changed, please login with new IP address 192.168.2.100.

At the bottom of the window, there are two buttons: a red 'OK' button and a white 'Cancel' button with a grey border.

---End

After the configuration, if the new and original IP addresses belong to the same network segment, you can log in to the web UI of the CPE by accessing the new IP address. Otherwise, assign your computer an IP address that belongs to the same network segment as the new IP address of the CPE before login.

## Automatically Obtaining an IP Address

This mode enables the CPE to automatically obtain an IP address, a subnet mask, a gateway IP address, DNS server IP addresses from a DHCP server on your LAN. If a large number of CPEs are deployed, you can adopt this mode to prevent IP address conflicts and effectively reduce your workload.

### Configuration Procedure:

1. Choose **Network > LAN Setup** to enter the configuration page.
2. Set IP Address Type to DHCP (Dynamic IP Address).
3. Click **Save**.

LAN Setup

MAC Address 50:2B:73:FE:F4:98

IP Address Type DHCP (Dynamic IP Adc ▼)

IP Address 192.168.2.100

Subnet Mask 255.255.255.0

Default Gateway 192.168.2.254

Primary DNS Server 8.8.8.8

Secondary DNS Server 8.8.4.4

Device Name CPE9V1.0

Save Cancel

---End

After the configuration, if you want to re-log in to the web UI of the CPE, check the client list of the DHCP server for the IP address assigned to the CPE, ensure that the IP address of the management computer and the IP address of the CPE belong to the same network segment, and access the IP address of the CPE.

## 6.2 MAC Clone

This function is available only when the CPE works in WISP or Router mode.

### 6.2.1 Overview

If the device cannot access the internet after configuring internet settings, your ISP may have bound your account with the MAC address of your computer that was used to verify internet connectivity after you subscribed to the internet service. Therefore, only the computer can access the internet with the account.

In this case, you can try either of the following methods to address the issue.

#### Method 1

1. Connect the computer to the device.
2. Log in to the device's web UI.
3. Choose **Network** > **MAC Clone** to enter the configuration page.
4. Click **Clone Local MAC Address**.
5. Click **Save**.



---End

## Method 2

Connect another device (such as a smart phone or tablet) to the device

1. Log in to the device's web UI.
2. Choose **Network > MAC Clone**.
3. Enter the MAC address of the computer that can access the internet in the **MAC Address** boxes.
4. Click **Save**.

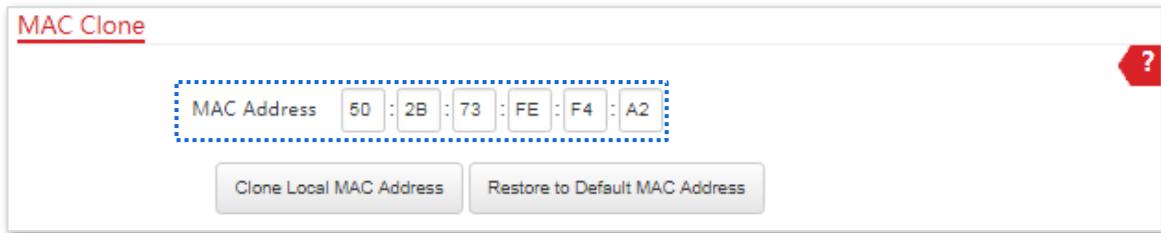

MAC Clone

MAC Address 50 : 2B : 73 : FE : F4 : A2

Clone Local MAC Address Restore to Default MAC Address

---End



If you want to restore the MAC address to factory settings, choose **Network > MAC Clone**, click **Restore to Default MAC Address**, and click **Save**.

---

## 6.3 DHCP Server

### 6.3.1 Overview

The CPE provides a DHCP server function to assign IP addresses to clients on the LAN. By default, the DHCP server function is disabled.



Tip

If the new and original IP addresses of the LAN port belong to different network segment, the system changes the IP address pool of the DHCP server function of the CPE so that the IP address pool and the new IP address of the LAN port belong to the same network segment.

### 6.3.2 Configuring the DHCP Server

1. Choose **Network > DHCP Server** to enter the configuration page.
2. Enable the **DHCP server**.
3. Set the parameters. Generally, you need to set only **Gateway Address** and **Primary DNS Server**.
4. Click **Save**.

**DHCP Server**

\* DHCP Server

Start IP Address

End IP Address

Subnet Mask

\* Gateway Address

\* Primary DNS Server

Secondary DNS Server

Lease Time



**Save**

---End



If another DHCP server is available on your LAN, ensure that the IP address pool of the CPE does not overlap the IP address pool of that DHCP server. Otherwise, IP address conflicts may occur.

### Parameters Description

| Name                 | Description   |
|----------------------|---|
| DHCP Server          | It specifies whether to enable the DHCP server function of the CPE. By default, it is disabled.   |
| Start IP             | It specifies the start IP address of the IP address pool of the DHCP server. The default value is <b>192.168.2.100</b> .  |
| End IP               | It specifies the end IP address of the IP address pool of the DHCP server. The default value is <b>192.168.2.200</b> .  |
|                      |  <p>The start and end IP addresses must belong to the same network segment as the IP address of the LAN port of the CPE.</p>   |
| Lease Time           | <p>It specifies the validity period of an IP address assigned by the DHCP server to a client.</p> <p>When half of the lease time has elapsed, the client sends a DHCP Request to the DHCP server to renew the lease time. If the request succeeds, the lease time is extended according to the request. Otherwise, the client sends the request again when 7/8 of the lease time has elapsed. If the request succeeds, the lease time is extended according to the request. Otherwise, the client must request an IP address from the DHCP server after the lease time expires.</p> <p>It is recommended that you retain the default value 1 day.</p> |
| Subnet Mask          | It specifies the subnet mask assigned by the DHCP server to clients. The default value is <b>255.255.255.0</b> .  |
| Gateway Address      | It specifies the default IP address gateway assigned by the DHCP server to clients. Generally, it is the IP address of the LAN port of a router on the LAN. The default value is <b>192.168.2.254</b> .   |
|                      |  <p>A client can access a server or host not in the local network segment only through a gateway.</p>  |
| Primary DNS Server   | It specifies the primary DNS server IP address assigned by the DHCP server to clients. The default value is <b>8.8.8.8</b> .  |
|                      |  <p>To enable clients to access the internet, set this parameter to a correct DNS server IP address or DNS proxy IP address.</p>   |
| Secondary DNS Server | It specifies the secondary DNS server IP address assigned by the DHCP server to clients. This parameter is optional.  |

## 6.4 DHCP Client

If the CPE functions as a DHCP server, you can view the DHCP client list to understand the details about the clients that obtain IP addresses from the DHCP server. The details include host names, IP addresses, MAC addresses, and lease times.

To access the page, choose **Network > DHCP Client**.

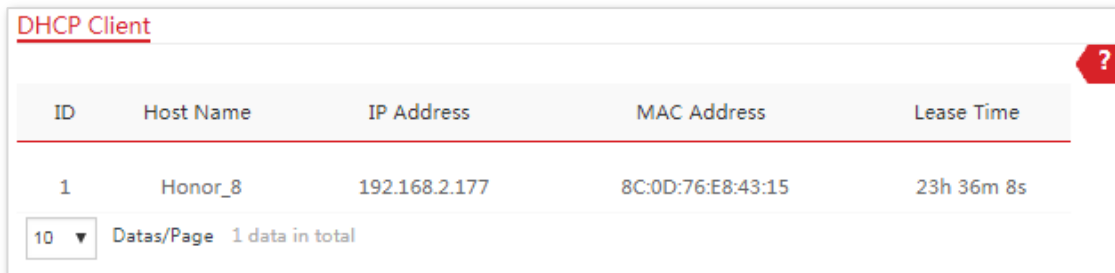

The screenshot shows a web interface titled "DHCP Client" with a red question mark icon in the top right corner. Below the title is a table with the following columns: ID, Host Name, IP Address, MAC Address, and Lease Time. The table contains one row of data. Below the table is a pagination bar showing "10" items per page and "1 data in total".

| ID | Host Name | IP Address    | MAC Address       | Lease Time |
|----|-----------|---------------|-------------------|------------|
| 1  | Honor_8   | 192.168.2.177 | 8C:0D:76:E8:43:15 | 23h 36m 8s |

10 Datas/Page 1 data in total

## 6.5 VLAN Settings

### 6.5.1 Overview

The CPE supports the IEEE 802.1Q VLAN function, so that it can be used in networks with QVLAN. By default, the function is disabled.

### 6.5.2 Setting up VLAN

1. Choose **Network > VLAN Settings** to enter the configuration page.
2. Enable the function.
3. Set the parameters as needed.
4. Click **Save**.

VLAN Settings ?

VLAN Settings

PVID  (Range: 1 to 4094)

Management VLAN  (Range: 1 to 4094)

WLAN VLAN ID  (Range: 1 to 4094)

LAN VLAN ID  (Range: 1 to 4094)

---End

#### Parameters Description

| Name            | Description   |
|-----------------|---|
| VLAN Settings   | It specifies whether to enable the VLAN function of this device. By default, it is disabled. After the VLAN function is enabled, the PoE LAN/WAN port is used as trunk port.  |
| PVID            | It specifies the ID of the default native VLAN of the trunk port. The default ID is <b>1</b> . After the VLAN function is enabled, the PoE LAN/WAN port is used as trunk port.  |
| Management VLAN | It specifies the ID of the management VLAN of this device. The default ID is <b>1</b> . After changing the management VLAN, you can manage this device only after connecting your computer to the new management VLAN.                |
| WLAN VLAN ID    | It allows you to set a VLAN ID for the wireless network of this device. By default, it is set to <b>1000</b> . After the VLAN function is enabled, the WLAN interface functions as an access port, whose PVID is the same as VLAN ID. |

| Name        | Description  |
|-------------|--|
| LAN VLAN ID | <p>It allows you to set a VLAN ID for the LAN port (wired network) of this device. By default, it is set to 1.</p> <p>After the VLAN function is enabled, the WLAN interface functions as an access port, whose PVID is the same as VLAN ID.</p> |

After the IEEE 802.1Q VLAN settings take effect, packet with tag will be forwards to the ports of the corresponding VLAN according to the VID of the packet, and packet without tag will be forwards to the ports of the corresponding VLAN according to the PVID of the port.

The following form shows the details about how different link type ports address received packets:

| Link Type of the Port | Type of Received Packets   |  | Transmitted Packets  |
|-----------------------|--|--|--|
|                       | Packet with Tag  | Packet without Tag   |  |
| Access                |  |  | Strip the tag in the packet and then forward it                          |
| Trunk                 | Forward the data to the ports of the corresponding VLAN based on the VID in the tag. | Forward the data to the ports of the corresponding VLAN based on the PVID of ports | VID = PVID of the port, strip the tag in the packet and then forward it  |
|                       |  |  | VID ≠ PVID of the port, retain the tag in the packet and then forward it |

### 6.5.3 Examples of Configuring VLAN Settings

#### Networking Requirement

The CPEs connected to the same switch should belong to different VLANs.

**Assumption:**

CPE1 belongs to VLAN10, and CPE2 belongs to VLAN20.

## Network Topology

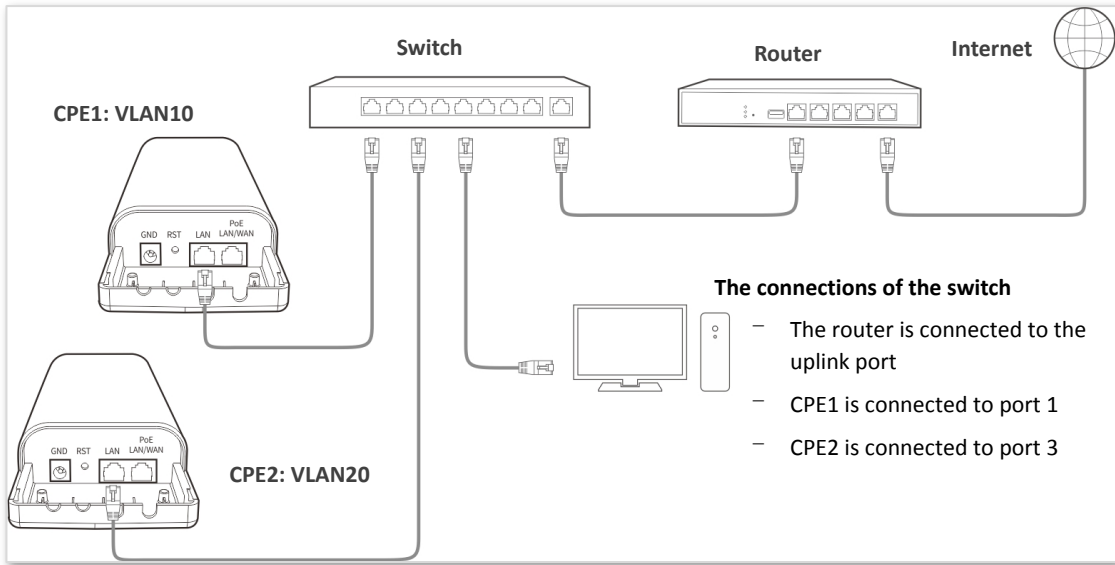

## Configuration Procedure

1. Set up CPE1.
  - (1) Log in to the web UI of CPE1, and choose **Network > VLAN Settings**.
  - (2) Enable the function.
  - (3) Set **Management VLAN** to **1**.
  - (4) Set **WLAN VLAN ID** to **10**.
  - (5) Set **LAN VLAN ID** to **10**.
  - (6) Click **Save**.

The screenshot shows the 'VLAN Settings' web interface. At the top, 'VLAN Settings' is toggled on. Below are four input fields, each with a '(Range: 1 to 4094)' note:

- PVID: 1
- Management VLAN: 1
- WLAN VLAN ID: 10
- LAN VLAN ID: 10

At the bottom, there are 'Save' and 'Cancel' buttons.

- (7) Click **OK** on the pop-up window, and wait until the CPE1 completes reboot.
2. Set up CPE2 according to the steps in [step 1](#).
3. Set up the switch.

The following form shows the configuration on the switch:

| Ports of the Switch                 | VLAN ID (Allow the packets belonging to the following VLANs to access) | Type of Port | PVID |
|-------------------------------------|--|--------------|------|
| Uplink port (Connected to a router) | 1,10,20  | Trunk        | 1    |
| Port 1 (Connected to CPE1)          | 1,10   | Trunk        | 1    |
| Port 3 (Connected to CPE2)          | 1,20   | Trunk        | 1    |

Keep the default settings for the parameters which are not mentioned here. Refer to the user guide of the switch for details.

The following form shows the configuration on the router:

| Port of the router is connected to | VLAN ID (Allow the packets belonging to the following VLANs to access) | Type of Port | PVID |
|------------------------------------|--|--------------|------|
| The switch                         | 10, 20   | Trunk        | 1    |

Refer to the user guide of the router for details.

---End

## Verification

If the router enables two DHCP servers which belong to VLAN10 and VLAN20 respectively, the first device connected to the CPE obtains an IP address and related parameters from the DHCP server belonging to VLAN10, and the second device obtains these parameters from the DHCP server belonging to VLAN20.

# 7 Wireless

## 7.1 Basic

### 7.1.1 Overview

This module enables you to set basic wireless settings of the CPE, including SSID-related parameters, network mode, channel, transmit power and so on.

#### Broadcast SSID

When the CPE broadcasts an SSID, nearby wireless clients can detect the SSID. When this parameter is set to **Disable**, the CPE does not broadcast the SSID and nearby wireless clients cannot detect the SSID. In this case, you need to enter the SSID manually on your wireless client if you want to connect to the wireless network corresponding to the SSID. This to some extent enhances the security of the wireless network.

It is worth noting that after **Broadcast SSID** is set to **Disable**, a hacker can still connect to the corresponding wireless network if he/she manages to obtain the SSID by other means.

#### Isolate Client

This parameter implements a function similar to the VLAN function for wired networks. It isolates the wireless clients connected to the same wireless network corresponding to an SSID, so that the wireless clients can access only the wired network connected to the CPE. Applying this function to hotspot setup at public places such as hotels and airports helps increase network security.

#### Max. Number of Clients

This parameter specifies the maximum number of clients that can connect to the wireless network corresponding to an SSID. If the number is reached, the wireless network rejects new connection requests from clients. This limit helps balance load among CPEs.

#### Security Mode

A wireless network uses radio, which is open to the public, as its data transmission medium. If the wireless

network is not protected by necessary measures, any client can connect to the network to use the resources of the network or access unprotected data over the network. To ensure communication security, transmission links of wireless networks must be encrypted for protection.

The CPE supports various security modes for network encryption, including None, WEP, WPA-PSK, WPA2-PSK, Mixed WPA/WPA2-PSK, WPA, and WPA2.

## **None**

It indicates that any wireless client can connect to the wireless network. This option is not recommended because it affects network security.

## **WEP**

It uses a static key to encrypt all exchanged data, and ensures that a wireless LAN has the same level of security as a wired LAN. Data encrypted based on WEP can be easily cracked. In addition, WEP supports a maximum wireless network throughput of only 54 Mbps. Therefore, this security mode is not recommended.

## **WPA-PSK, WPA2-PSK, and Mixed WPA/WPA2-PSK**

They belong to pre-shared key or personal key modes, where Mixed WPA/WPA2-PSK supports both WPA-PSK and WPA2-PSK.

WPA-PSK, WPA2-PSK, and Mixed WPA/WPA2-PSK adopt a pre-shared key for authentication, while the AP generates another key for data encryption. This prevents the vulnerability caused by static WEP keys, and makes the three security modes suitable for ensuring security of home wireless networks. Nevertheless, because the initial pre-shared key for authentication is manually set and all clients use the same key to connect to the same AP, the key may be disclosed unexpectedly. This makes the security modes not suitable for scenarios where high security is required.

## **WPA and WPA2**

To address the key management weakness of WPA-PSK and WPA2-PSK, the WiFi Alliance puts forward WPA and WPA2, which use 802.1x to authenticate clients and generate data encryption-oriented root keys. WPA and WPA2 use the root keys to replace the pre-shared keys that set manually, but adopt the same encryption process as WPA-PSK and WPA2-PSK.

WPA and WPA2 uses 802.1x to authenticate clients and the login information of a client is managed by the client. This effectively reduces the probability of information leakage. In addition, each time a client connects to an AP that adopts the WPA or WPA2 security mode, the RADIUS server generates a data encryption key and assigns it to the client. This makes it difficult for attackers to obtain the key. These features of WPA and WPA2 help significantly increase network security, making WPA and WPA2 the preferred security modes of wireless networks that require high security.

## 7.1.2 Changing the Basic Settings

To change the basic settings of an SSID, perform the following procedure:

1. Choose Wireless > Basic.
2. Change the parameters as required. Generally, you only need to enable the wireless function, and change **SSID**, **Channel** and **Security Mode** settings.
3. Click **Save**.

**Basic**

Enable Wireless

Country/Region

\* SSID

Broadcast SSID  Enable  Disable

Network Mode

\* Channel

Transmit Power

Channel Bandwidth

Extension Channel

Transmit Rate

\* Security Mode

Encryption Algorithm  AES  TKIP  TKIP&AES

Key

Key Update Interval  s (Range: 60 to 99999, 0 indicates that no key update is performed.)

Isolate Client  Enable  Disable

Max. Number of Clients  (Range: 1 to 128)

---End

## Parameters Description

| Name                 | Description   |
|----------------------|---|
| Enable Wireless      | It specifies whether to enable the wireless function. By default, it is enabled.  |
| Country/Region       | It specifies country or region where this device is located. You can select the country or region to ensure that this device complies with the channel regulations of the country or region.  |
| SSID                 | It specifies the wireless network name.   |
| Broadcast SSID       | It specifies whether to broadcast the SSID. <ul style="list-style-type: none"><li>– <b>Enable</b> indicates that the SSID is broadcast and nearby wireless devices can find the SSID.</li><li>– <b>Disable</b> indicates that the SSID is not broadcast and nearby wireless devices cannot find the SSID.</li></ul>   |
| Network Mode         | It specifies the network mode of this device. The available options include 11b/g, 11b, 11g, and 11 b/g/n. <ul style="list-style-type: none"><li>– <b>11b/g</b>: It indicates that clients compliant with the 802.11b or 802.11g protocol can connect to the CPE.</li><li>– <b>11g</b>: It indicates that clients working at 2.4 GHz and compliant with 802.11g can connect to the CPE.</li><li>– <b>11n</b>: It indicates that clients working at 2.4 GHz and compliant with 802.11n can connect to the CPE.</li><li>– <b>11b/g/n</b>: It indicates that all clients working at 2.4 GHz and compliant with the 802.11b, 802.11g, or 802.11n protocol can connect to the CPE.</li></ul> |
| Channel              | It specifies channel in which this device operates. <b>Auto</b> indicates that this device automatically changes to a channel rarely used in the ambient environment to prevent interference.   |
| Transmit Power       | It specifies the transmit power of this device.<br>Higher number indicates wider WiFi coverage. Setting a proper transmit power helps improve the performance and security of the wireless network.   |
| Channel Bandwidth    | It specifies the bandwidth of the operating channel of a wireless network. Change the default setting only when necessary. <ul style="list-style-type: none"><li>– <b>20</b>: It indicates that the channel bandwidth of a CPE is 20 MHz.</li><li>– <b>40</b>: It indicates that the channel bandwidth of a CPE is 40 MHz.</li><li>– <b>Auto</b>: It specifies that a CPE can switch its channel bandwidth between 20 MHz and 40 MHz based on the ambient environment.</li></ul>  |
| Extension Channel    | It is used to determine the operating frequency band of this device when it uses the 40 MHz channel bandwidth in 11n mode.  |
| Transmit Rate        | It specifies wireless transmission rate of the device.<br>If the channel bandwidth is set to 40 MHz, the maximum transmission rate is MCS7 (135 Mbps).<br>If the channel bandwidth is set to 20 MHz, this device uses lower transmission rate. And the maximum transmission rate is MCS7 (65 Mbps).   |
| Security Mode        | It specifies security mode of the wireless network of this device. The available modes include None, WEP, WPA-PSK, WPA2-PSK, Mixed WPA/WPA2-PSK, WPA and WPA2.  |
| Encryption Algorithm | It specifies the encryption algorithm corresponding to the selected security mode. If Security Mode is set to WPA-PSK, this parameter has the AES and TKIP values. If Security Mode is set to WPA2-PSK or Mixed WPA/WPA2-PSK, this parameter has the AES, TKIP, and TKIP&AES values. <ul style="list-style-type: none"><li>– <b>AES</b>: It indicates the Advanced Encryption Standard.</li><li>– <b>TKIP</b>: It indicates the Temporal Key Integrity Protocol. If TKIP is used, the maximum wireless throughput of the AP is limited to 54 Mbps.</li></ul>  |

| Name                   | Description  |
|------------------------|--|
|                        | <ul style="list-style-type: none"><li>- <b>TKIP&amp;AES:</b> It indicates that both TKIP and AES encryption algorithms are supported. Wireless clients can connect to the wireless network corresponding to the selected SSID using TKIP or AES.</li></ul>   |
| Key                    | It specifies a pre-shared WPA key. It consists of 8 to 63 ASCII characters or 8 to 64 hexadecimal characters.  |
| Key Update Interval    | It specifies interval at which a WPA key is updated. A shorter interval leads to higher security. The value 0 indicates that no key update is performed.   |
| Isolate Client         | <ul style="list-style-type: none"><li>- <b>Enable:</b> It indicates that the wireless clients connected to the CPE with the selected SSID cannot communicate with each other. This improves wireless network security.</li><li>- <b>Disable:</b> It indicates that the wireless clients connected to the CPE with the selected SSID can communicate with each other. By default, it is disabled.</li></ul> |
| Max. Number of Clients | It specifies the maximum number of wireless clients that can be connected to the wireless network with the SSID.<br>After this upper limit is reached, the CPE rejects new requests from clients for connecting to the wireless network.   |

## None

It indicates that any wireless client can connect to the wireless network. This option is not recommended because it affects network security.

## WEP

The screenshot shows a configuration window for WEP security. It includes the following fields:

- Security Mode: WEP (dropdown)
- Authentication Type: Open (dropdown)
- Default Key: Key 1 (dropdown)
- Key 1: 12345 (text input), ASCII (dropdown)
- Key 2: 12345 (text input), ASCII (dropdown)
- Key 3: 12345 (text input), ASCII (dropdown)
- Key 4: 12345 (text input), ASCII (dropdown)

### Parameters Description

| Name                | Description  |
|---------------------|--|
| Authentication Type | <p>It specifies the authentication type for the WEP security mode. The options include Open and Shared. The options share the same encryption process.</p> <ul style="list-style-type: none"> <li>– <b>Open:</b> It specifies that authentication is not required and data exchanged is encrypted using WEP. In this case, a wireless client can connect to the wireless network corresponding to the selected SSID without being authenticated, and the data exchanged between the client and the network is encrypted in WEP security mode.</li> <li>– <b>Shared:</b> It specifies that a shared key is used for authentication and data exchanged is encrypted using WEP. In this case, a wireless client must use a preset WEP key to connect to the wireless network corresponding to the selected SSID. The wireless client can be connected to the wireless network only if they use the same WEP key.</li> </ul> |
| Default Key         | <p>It specifies the WEP key for the Open or Shared encryption type.</p> <p>For example, if Default Key is set to Security Key 2, a wireless client can connect to the wireless network corresponding to the selected SSID only with the password specified by Security Key 2.</p>  |
| Key 1/2/3/4         | Enter WEP key. You can enter four keys, but only the key specified in the Default Key takes effect.  |
| ASCII               | <p>It indicates that a key selected for the Open or Shared authentication type contains hexadecimal characters.</p> <p>5 or 13 ASCII characters are allowed in the key.</p>  |
| Hex                 | <p>It indicates that a key selected for the Open or Shared authentication type contains hexadecimal characters.</p> <p>10 or 26 hexadecimal characters (range: 0-9, a-f, and A-F) are allowed in the key.</p>  |

## WPA-PSK, WPA2-PSK, and Mixed WPA/WPA2-PSK

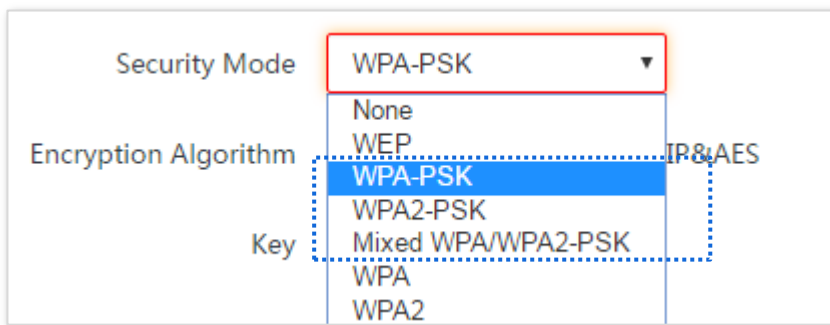

### Parameters Description

| Name          | Description   |
|---------------|---|
| Security Mode | <p>It indicates the personal or pre-shared key security mode, including WPA-PSK, WPA2-PSK, and Mixed WPA/WPA2-PSK.</p> <ul style="list-style-type: none"> <li>– <b>WPA-PSK:</b> It indicates that the wireless network corresponding to the selected SSID is encrypted using WPA-PSK.</li> <li>– <b>WPA2-PSK:</b> It indicates that the wireless network corresponding to the selected SSID is encrypted using WPA2-PSK.</li> <li>– <b>Mixed WPA/WPA2-PSK:</b> It indicates that wireless clients can connect to the wireless network corresponding to the selected SSID using either WPA-PSK or WPA2-PSK.</li> </ul> |

| Name                 | Description  |
|----------------------|--|
| Encryption Algorithm | <p>It specifies the encryption algorithm corresponding to the selected security mode. If Security Mode is set to WPA-PSK, this parameter has the AES and TKIP values. If Security Mode is set to WPA2-PSK or Mixed WPA/WPA2-PSK, this parameter has the AES, TKIP, and TKIP&amp;AES values.</p> <ul style="list-style-type: none"> <li>– <b>AES</b>: It indicates the Advanced Encryption Standard.</li> <li>– <b>TKIP</b>: It indicates the Temporal Key Integrity Protocol. If TKIP is used, the maximum wireless throughput of the AP is limited to 54 Mbps.</li> <li>– <b>TKIP&amp;AES</b>: It indicates that both TKIP and AES encryption algorithms are supported. Wireless clients can connect to the wireless network corresponding to the selected SSID using TKIP or AES.</li> </ul> |
| Key                  | <p>It specifies a pre-shared WPA key. A WPA key can contain 8 to 63 ASCII characters or 8 to 64 hexadecimal characters.</p>  |
| Key Update Interval  | <p>It specifies the automatic update interval of a WPA key for data encryption. A shorter interval results in higher data security.</p> <p>The value 0 indicates that a WAP key is not updated.</p>  |

## WPA and WPA2

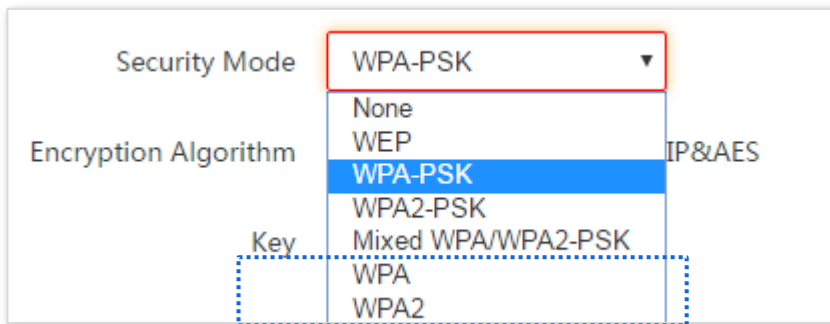

### Parameters Description

| Name                 | Description  |
|----------------------|--|
| Security Mode        | <p>The <b>WPA</b> and <b>WPA2</b> options are available for network protection with a RADIUS server.</p> <ul style="list-style-type: none"> <li>– <b>WPA</b>: It indicates that the wireless network corresponding to the selected SSID is encrypted using WPA.</li> <li>– <b>WPA2</b>: It indicates that the wireless network corresponding to the selected SSID is encrypted using WPA.</li> </ul>   |
| RADIUS Server        | <p>It specifies the IP address of the RADIUS server for client authentication.</p>   |
| RADIUS Port          | <p>It specifies the port number of the RADIUS server for client authentication.</p>  |
| RADIUS Password      | <p>It specifies the shared password of the RADIUS server.</p>  |
| Encryption Algorithm | <p>It specifies the encryption algorithm corresponding to the selected security mode. The available options include <b>AES</b>, <b>TKIP</b>, and <b>TKIP&amp;AES</b>.</p> <ul style="list-style-type: none"> <li>– <b>AES</b>: It indicates the Advanced Encryption Standard.</li> <li>– <b>TKIP</b>: It indicates the Temporal Key Integrity Protocol.</li> <li>– <b>TKIP&amp;AES</b>: It indicates that both TKIP and AES encryption algorithms are supported. Wireless clients can connect to the wireless network corresponding to the selected SSID using TKIP or AES.</li> </ul> |

| Name                | Description  |
|---------------------|--|
| Key Update Interval | It specifies the automatic update interval of a WPA key for data encryption. A shorter interval results in higher data security.<br>The value 0 indicates that a WAP key is not updated. |

## 7.1.3 Examples of Configuring Basic Settings

### Setting up a Non-encrypted Wireless Network

#### Networking Requirement

A residential community uses the CPEs to deploy its network for video surveillance. It requires that the SSID is FREE and there is no WiFi password.

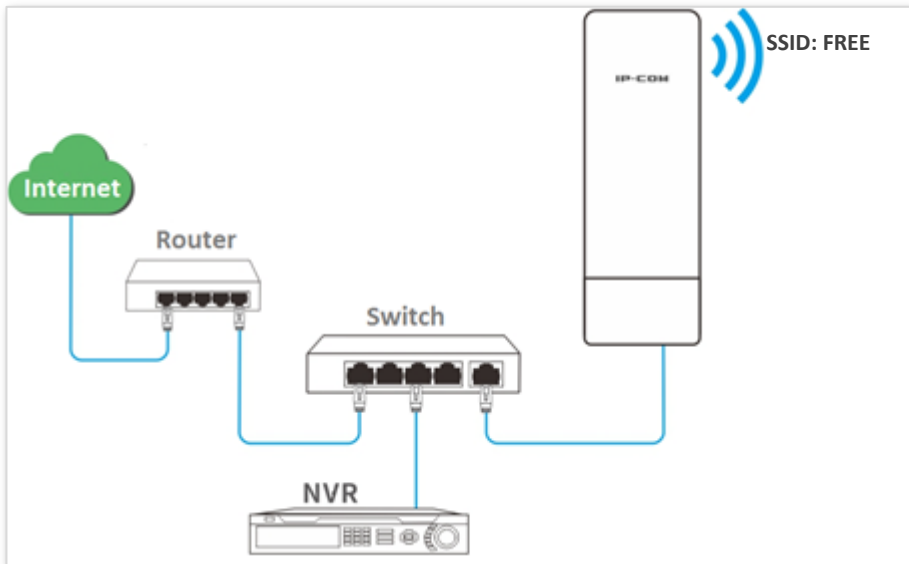

#### Configuration Procedure

Assume that the second SSID of the AP, the WPA2-PSK security mode, and AES encryption algorithm are used.

1. Choose Wireless > Basic.
2. Enable the wireless function.
3. Change the value of the **SSID** text box to **FREE**.
4. Set **Security Mode** to **None**.
5. Click **Save**.

**Basic** ?

\* Enable Wireless

Country/Region

\* SSID

Broadcast SSID  Enable  Disable

Network Mode

Channel

Transmit Power

Channel Bandwidth

Extension Channel

Transmit Rate

\* Security Mode

Isolate Client  Enable  Disable

Max. Number of Clients  (Range: 1 to 128)

\*

---End

## Verification

Verify that wireless devices can connect to the FREE wireless network without a password.

## Setting up a Wireless Network Encrypted Using WPA2-PSK

### Networking requirement

A factory's surveillance network with a certain level of security must be set up through a simple procedure. In this case, WPA2-PSK mode is recommended. See the following figure.

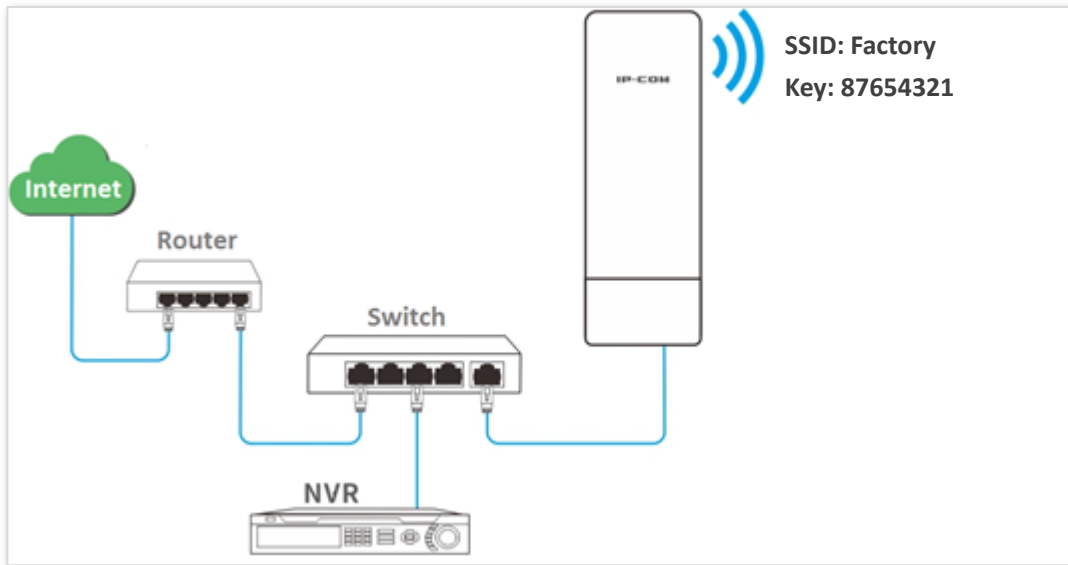

### Configuration procedure

Assume that the second SSID of the AP, the WPA2-PSK security mode, and AES encryption algorithm are used.

1. Choose Wireless > Basic.
2. Enable the wireless function.
3. Change the value of the SSID text box to **Factory**.
4. Set Security Mode to WPA2-PSK and Encryption Algorithm to AES.
5. Set Key to 87654321.
6. Click **Save**.

**Basic** ?

\* Enable Wireless

Country/Region

\* SSID

Broadcast SSID  Enable  Disable

Network Mode

Channel

Transmit Power  1dBm 29dBm

Channel Bandwidth

Extension Channel

Transmit Rate

\* Security Mode

\* Encryption Algorithm  AES  TKIP  TKIP&AES

\* Key

Key Update Interval  s (Range: 60 to 99999, 0 indicates that no key update is performed.)

Isolate Client  Enable  Disable

Max. Number of Clients  (Range: 1 to 128)

\*

---End

## Verification

Verify that wireless devices can connect to the wireless network named **Factory** with the password **87654321**.

## Setting up a Wireless Network Encrypted Using WPA or WPA2

### Networking requirement

A highly secure wireless network is required and a RADIUS server is available. In this case, WPA or WPA2 pre-shared key mode is recommended. See the following figure.

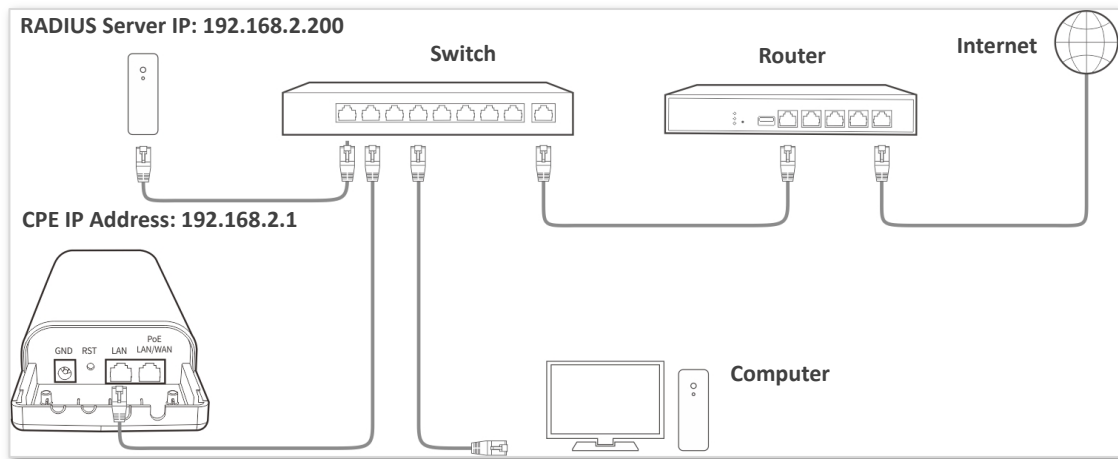

### Configuration procedure

#### Configure the CPE

Assume that the IP address of the RADIUS server is 192.168.0.200, the Key is 12345678, and the port number for authentication is 1812.

Assume that the second SSID of the AP is used.

1. Choose Wireless > Basic.
2. Enable the wireless function.
3. Change the value of the SSID text box to **hotspot**.
4. Set Security Mode to WPA2.
5. Set RADIUS Server, RADIUS Port, and RADIUS Password to 192.168.0.200, 1812, and 12345678 respectively.
6. Set Encryption Algorithm to AES.
7. Click **Save**.

**Basic** ?

\* Enable Wireless

Country/Region

\* SSID

Broadcast SSID  Enable  Disable

Network Mode

Channel

Transmit Power  1dBm 29dBm

Channel Bandwidth

Extension Channel

Transmit Rate

\* Security Mode

\* RADIUS Server

\* RADIUS Port

\* Encryption Algorithm  AES  TKIP  TKIP&AES

\* RADIUS Password

Key Update Interval  s (Range: 60 to 99999, 0 indicates that no key update is performed.)

Isolate Client  Enable  Disable

Max. Number of Clients  (Range: 1 to 128)

\*

---End

### Configure the RADIUS server



Windows 2003 is used as an example to describe how to configure the RADIUS server.

1. Configure a RADIUS client.

- (1) In the **Computer Management** dialog box, double-click **Internet Authentication Service**, right-click **RADIUS Clients**, and choose **New RADIUS Client**.

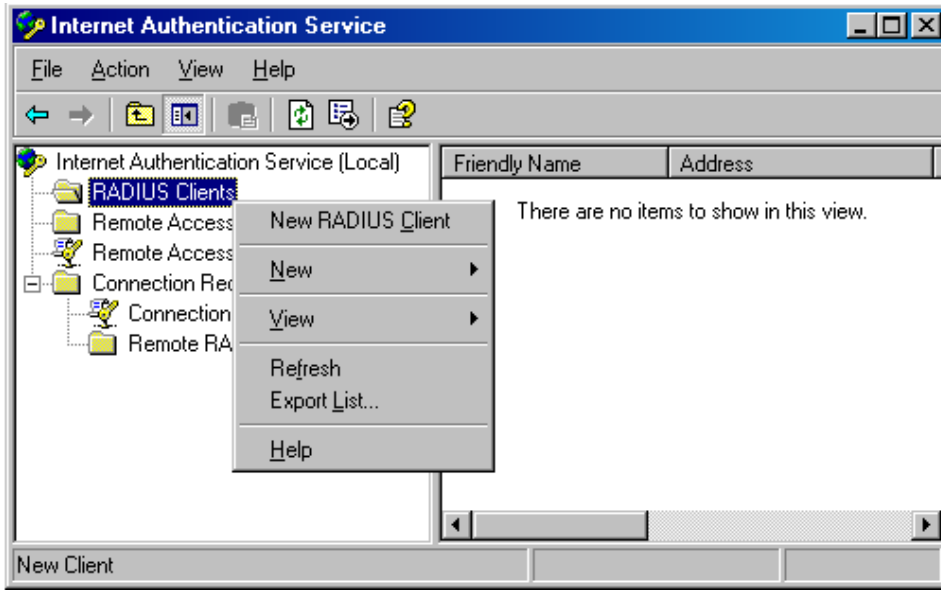

- (2) Enter a RADIUS client name (which can be the name of the AP) and the IP address of the CPE, and click **Next**.

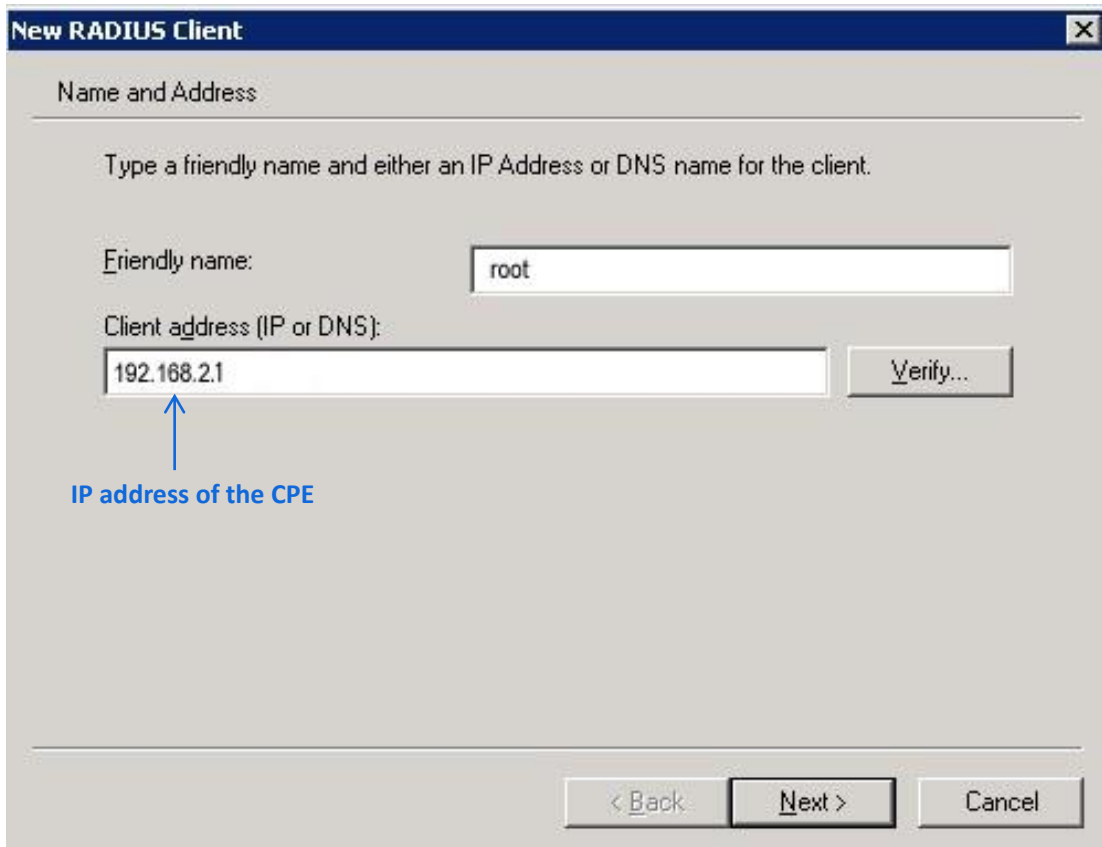

- (3) Enter **12345678** in the **Shared secret** and **Confirm shared secret** text boxes, and click **Finish**.

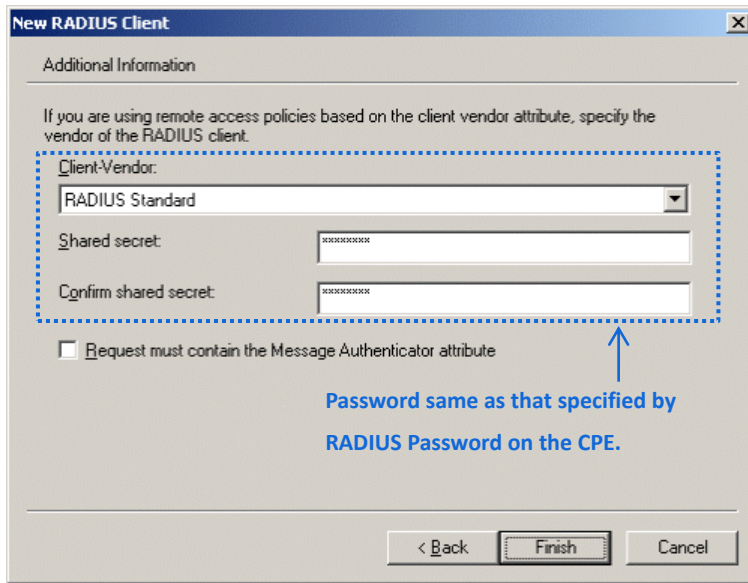

2. Configure a remote access policy.

- (1) Right-click **Remote Access Policies** and choose **New Remote Access Policy**.

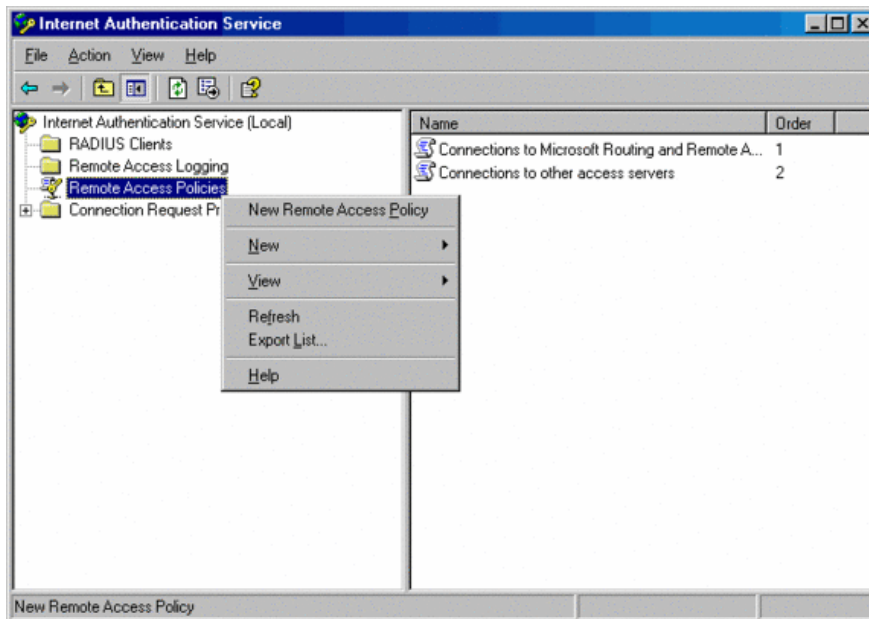

- (2) In the **New Remote Access Policy Wizard** dialog box that appears, click **Next**.

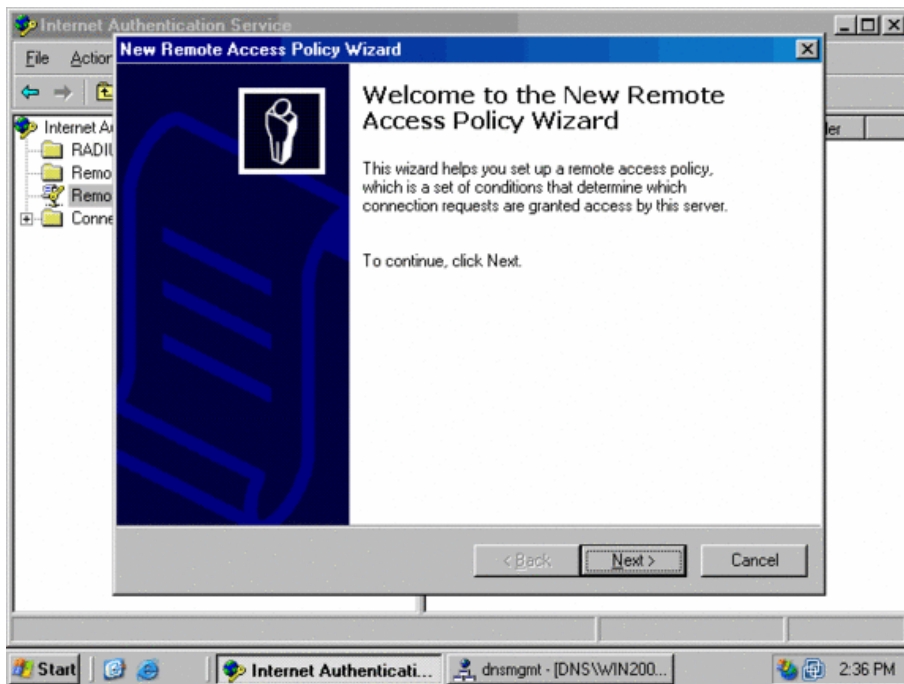

- (3) Enter a policy name and click **Next**.

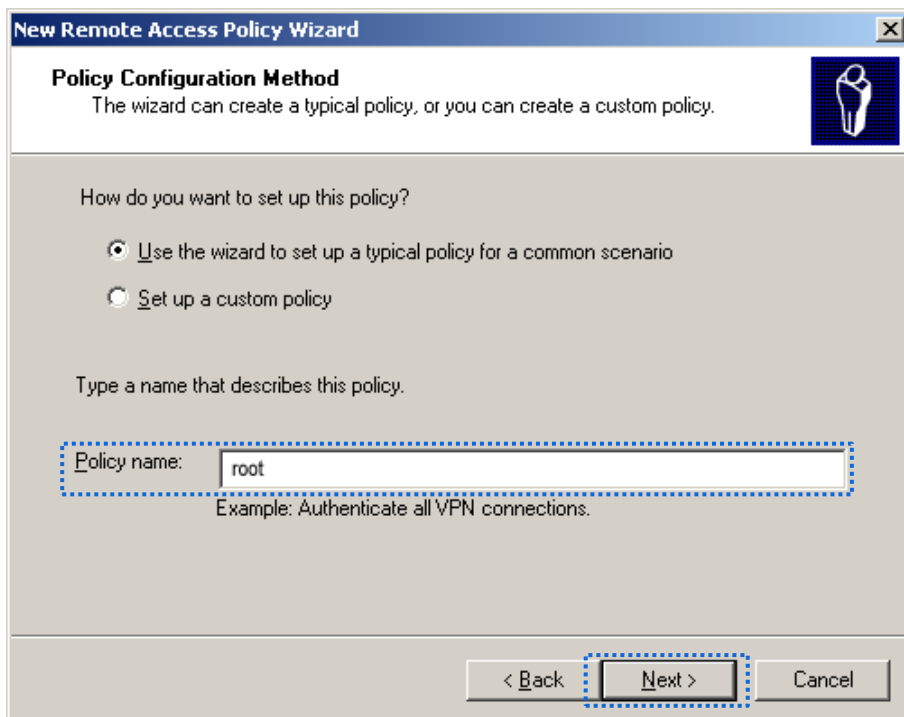

(4) Select **Ethernet** and click **Next**.

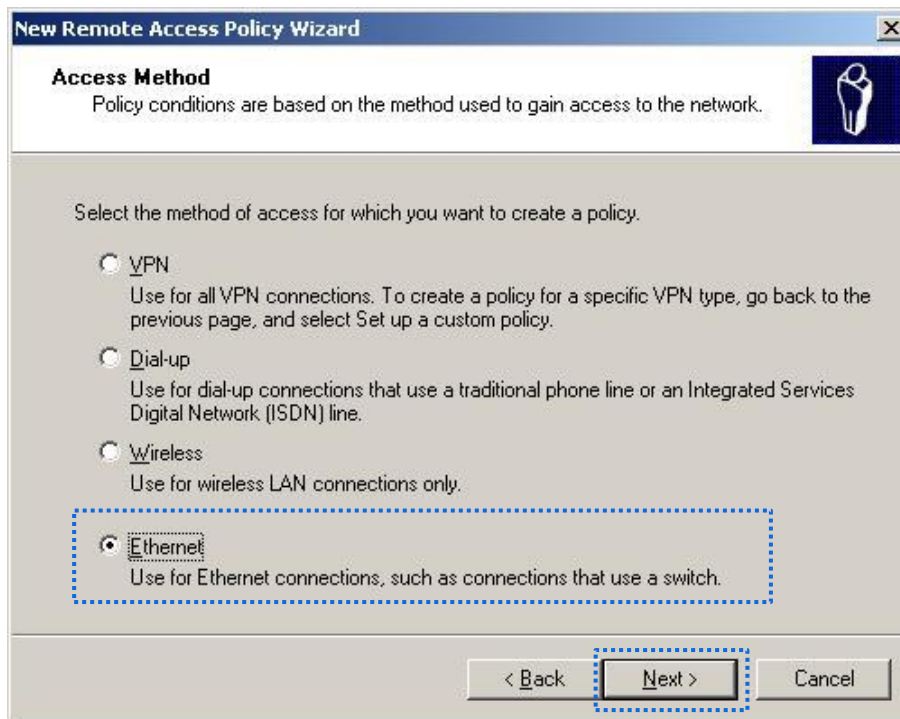

(5) Select **Group** and click **Add**.

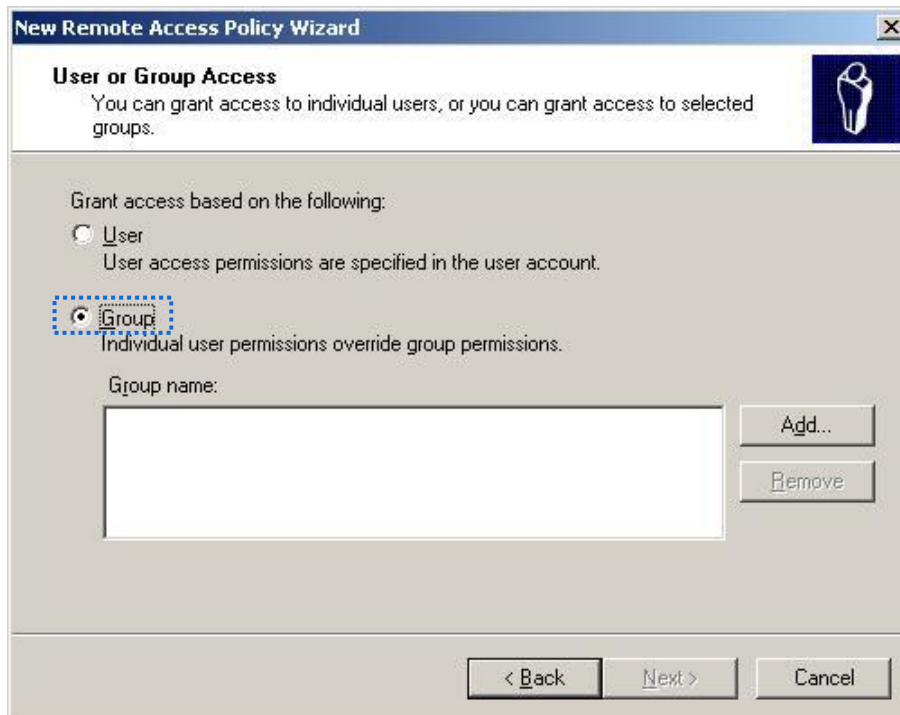

- (6) Enter **802.1x** in the **Enter the object names to select** text box, click **Check Names**, and click **OK**.

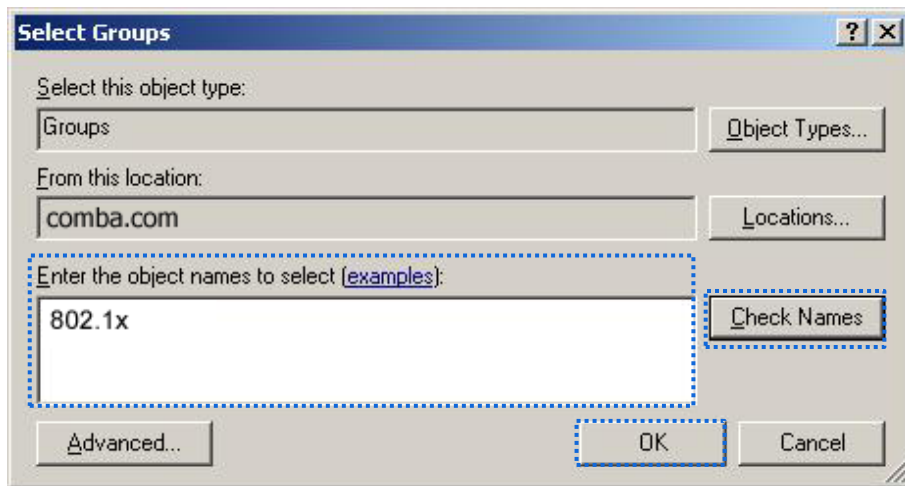

- (7) Select **Protected EAP (PEAP)** and click **Next**.

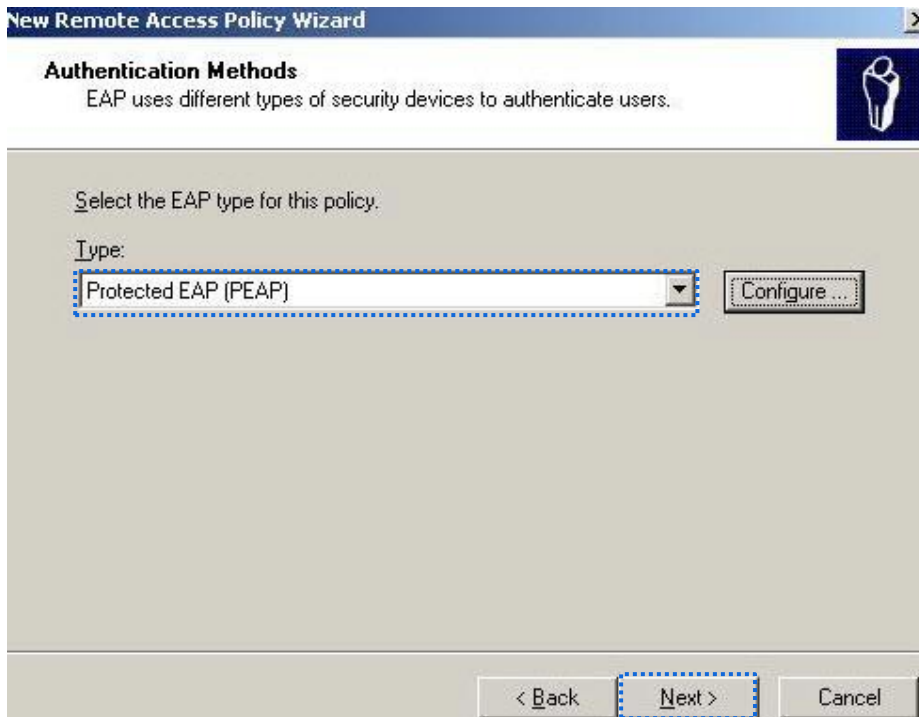

- (8) Click **Finish**. The remote access policy is created.

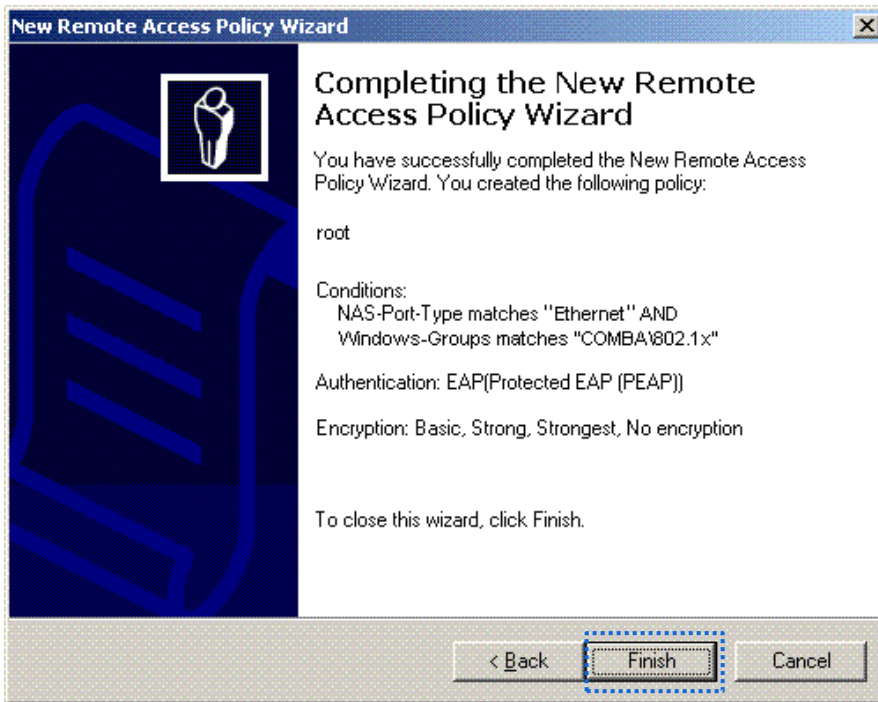

- (9) Right-click **root** and choose **Properties**. Select **Grant remote access permission**, select **NAS-Port-Type matches "Ethernet" AND**, and click **Edit**.

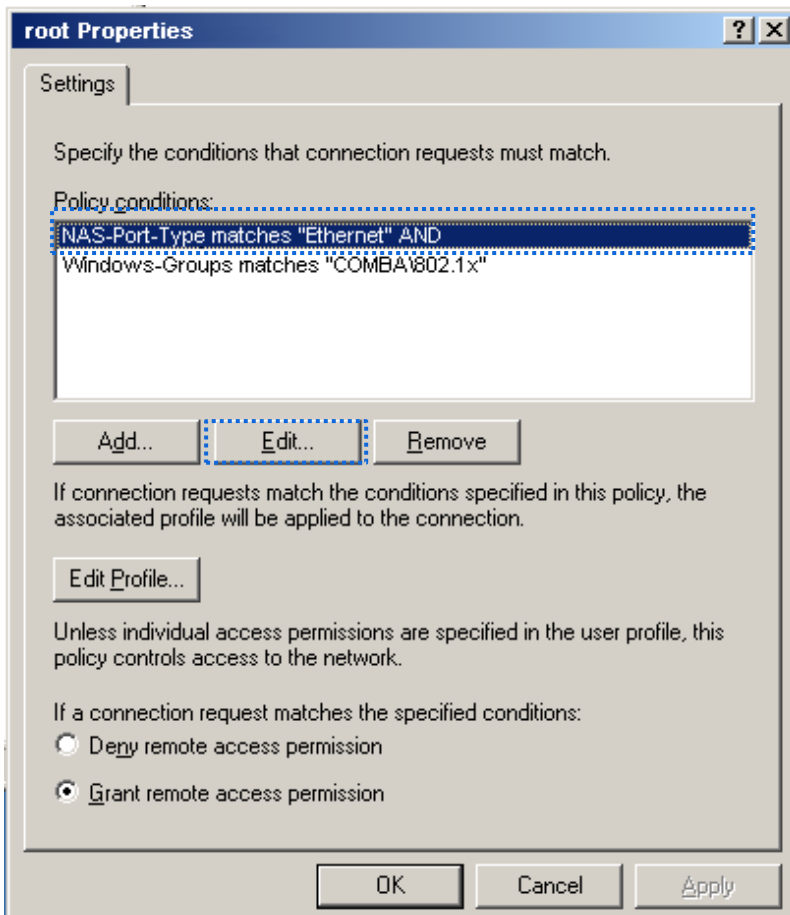

(10) Select **Wireless – Other**, click **Add**, and click **OK**.

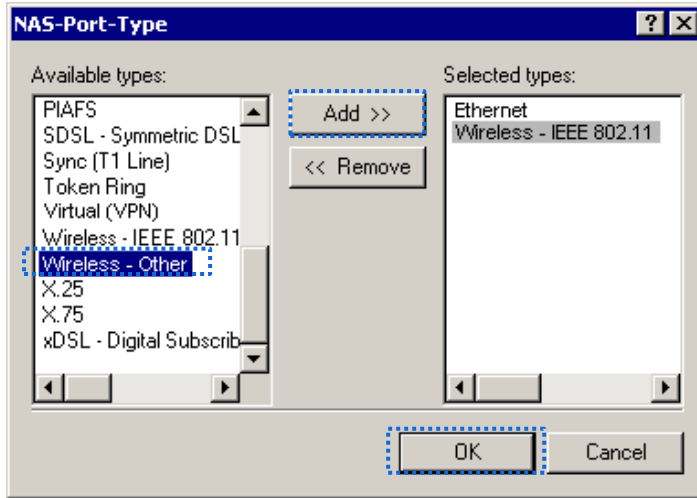

(11) Click **Edit Profile**, click the **Authentication** tab, configure settings as shown in the following figure, and click **OK**.

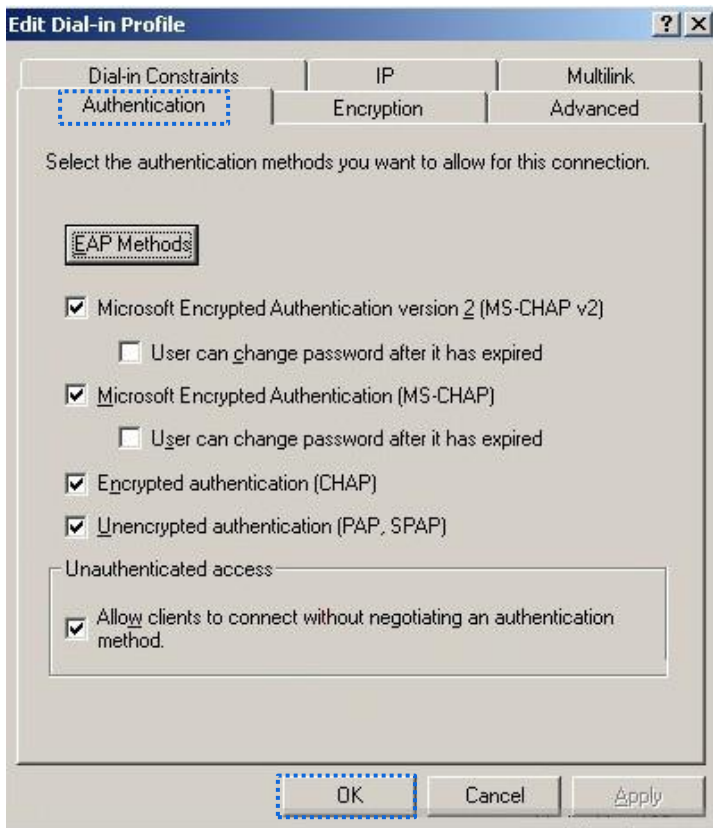

(12) When a message appears, click **No**.

### 3. Configure user information.

Create a user and add the user to group **802.1x**.

---End

## Configure your wireless device



Windows 7 is taken as an example to describe the procedure.

1. Choose **Start > Control Panel**, click **Network and Internet**, click **Network and Sharing Center**, and click **Manage wireless networks**.

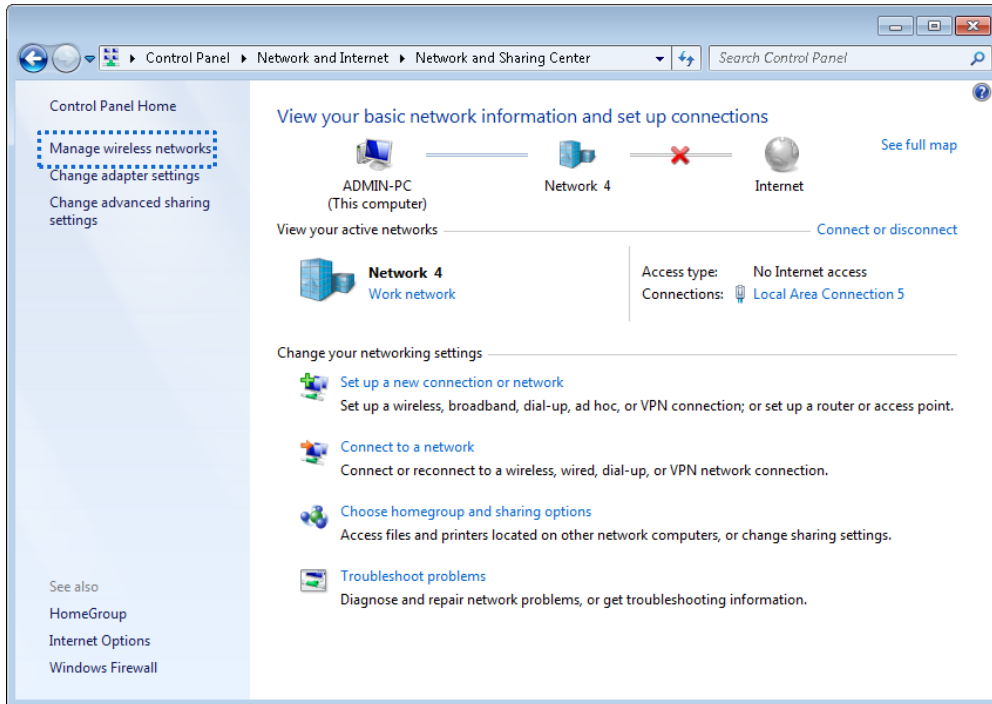

2. Click **Add**.

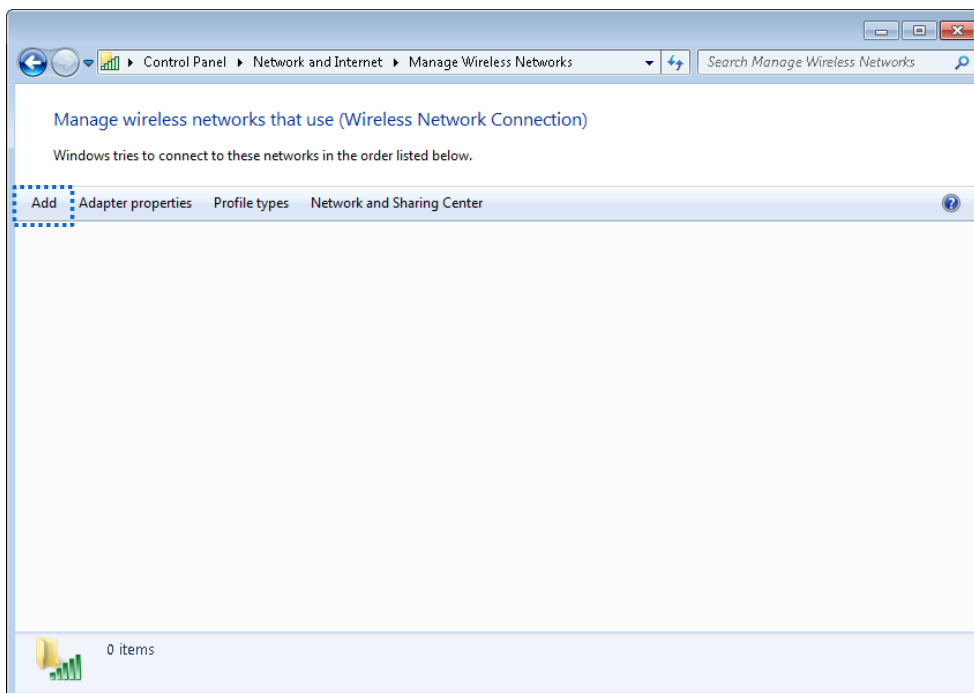

3. Click **Manually create a network profile**.

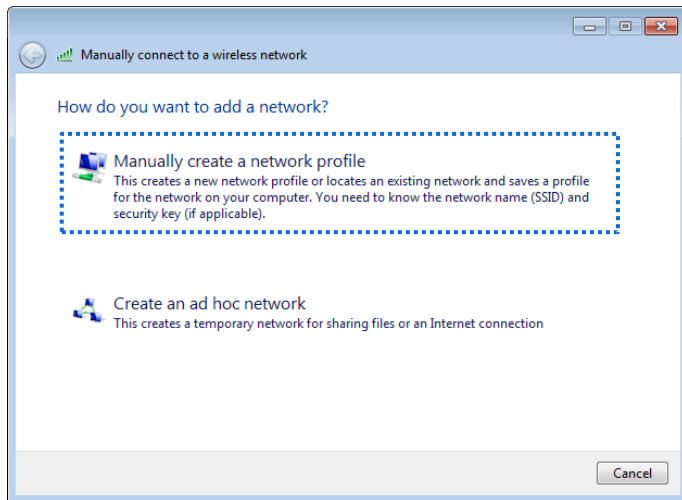

4. Enter wireless network information, select **Connect even if the network is not broadcasting**, and click **Next**.

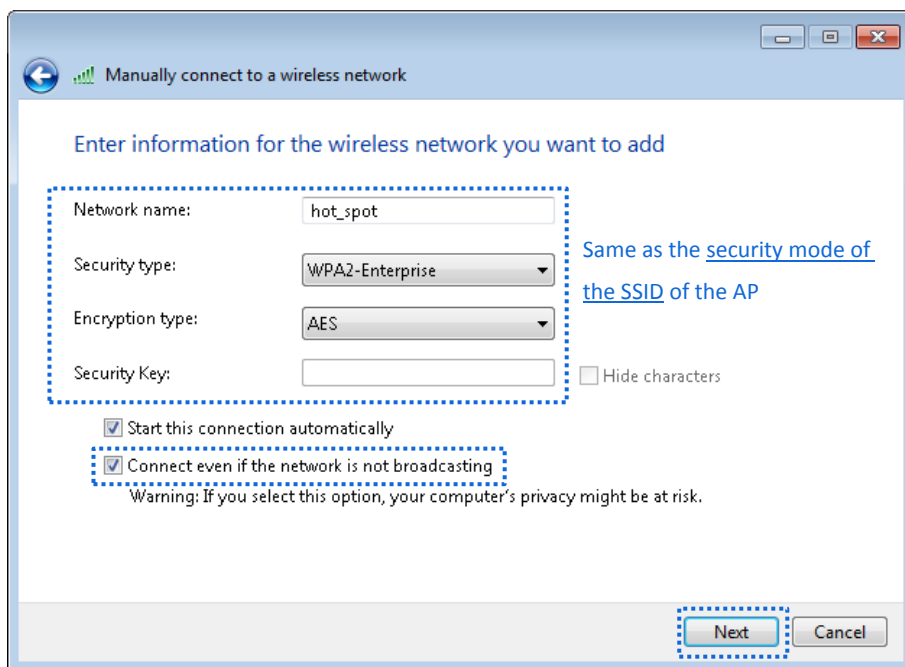

5. Click **Change connection settings**.

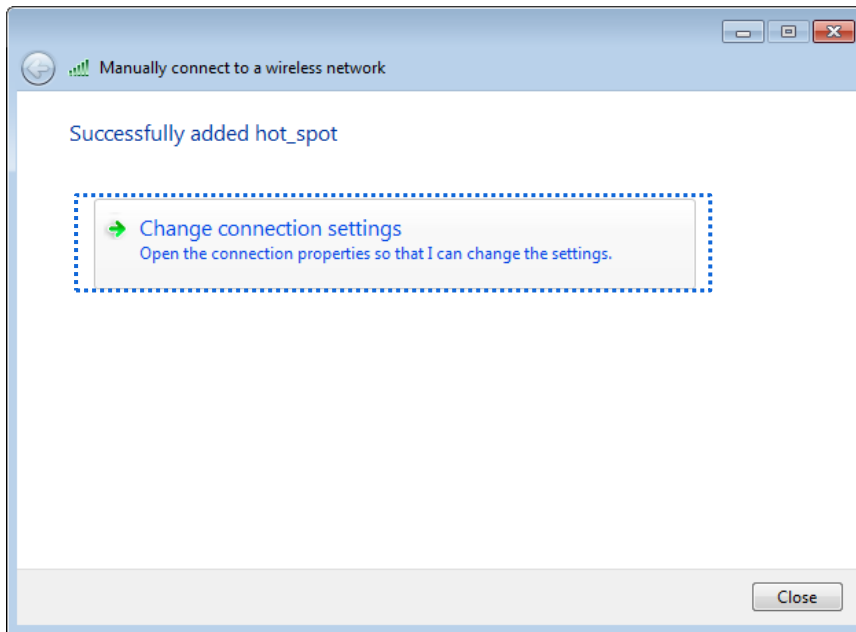

6. Click the **Security** tab, select **Microsoft: Protected EAP (PEAP)**, and click **Settings**.

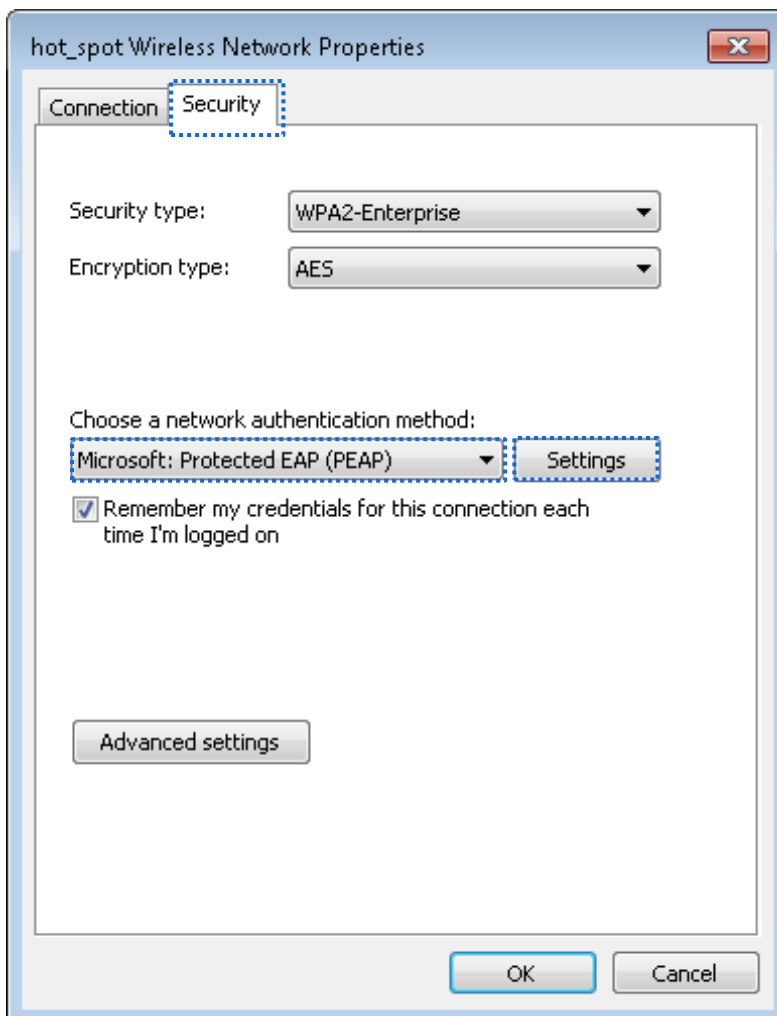

7. Deselect **Validate server certificate** and click **Configure**.

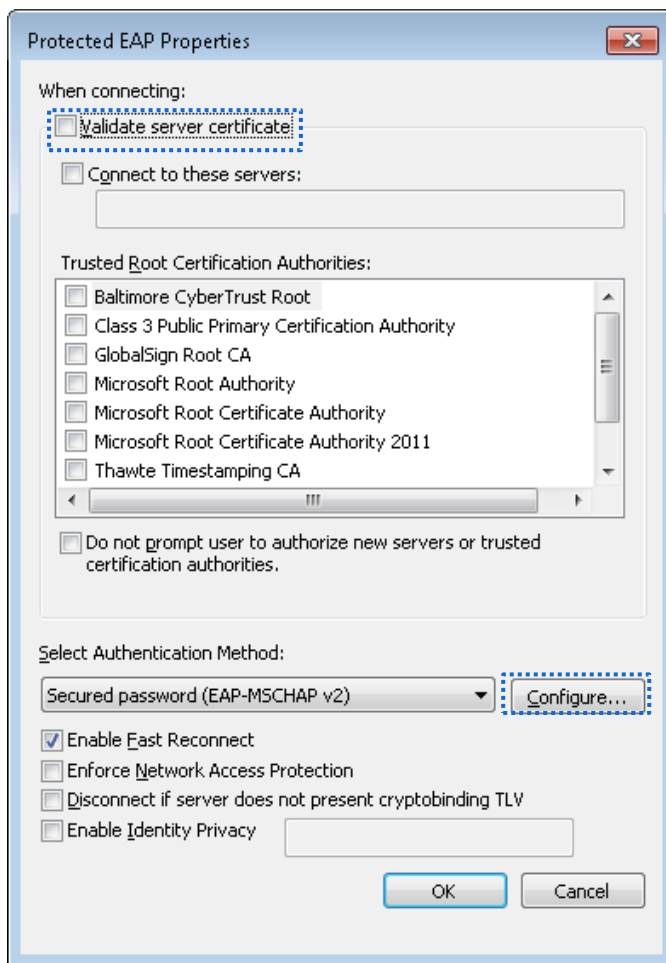

8. Deselect **Automatically use my Windows logon name and password (and domain if any)** and click **OK**.

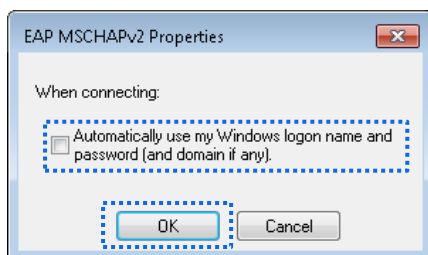

9. Click **Advanced settings**.

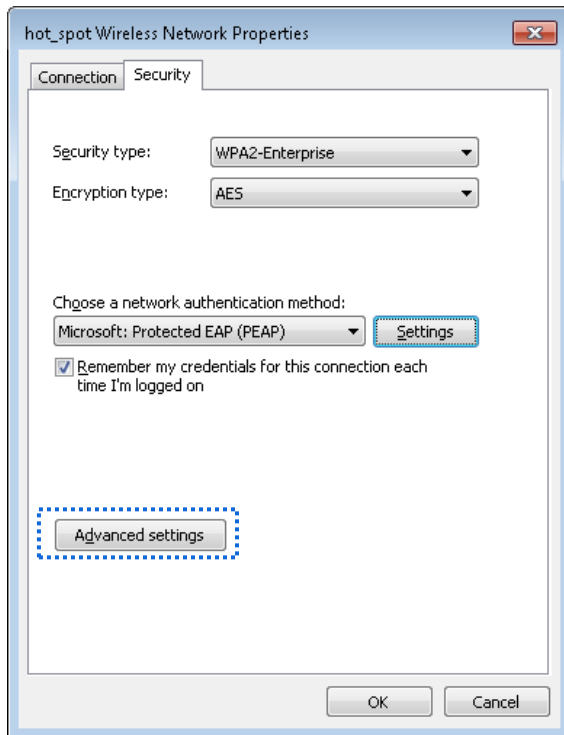

10. Select **User or computer authentication** and click **OK**.

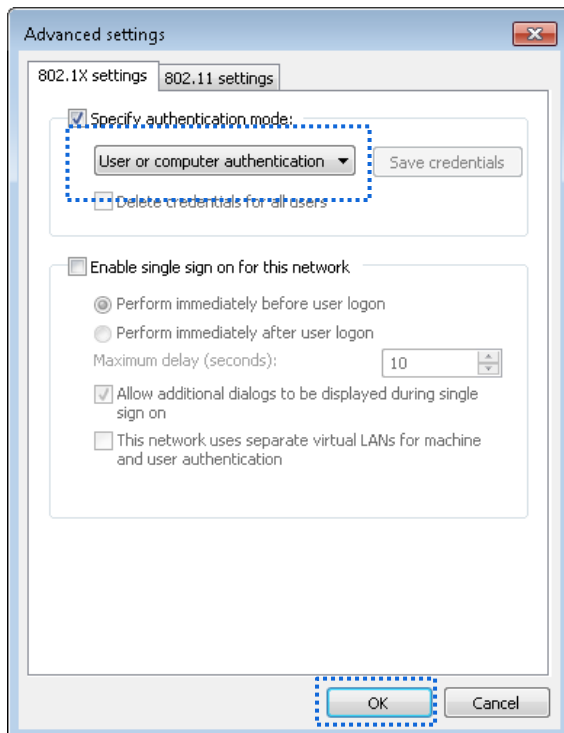

11. Click **Close**.

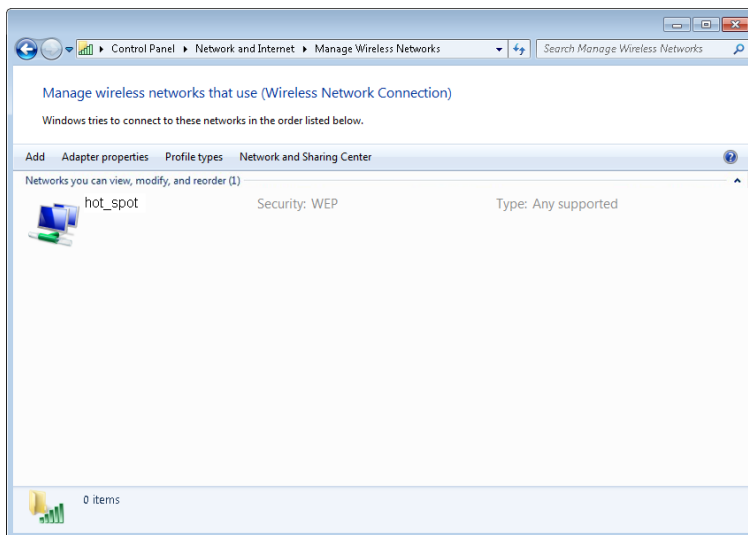
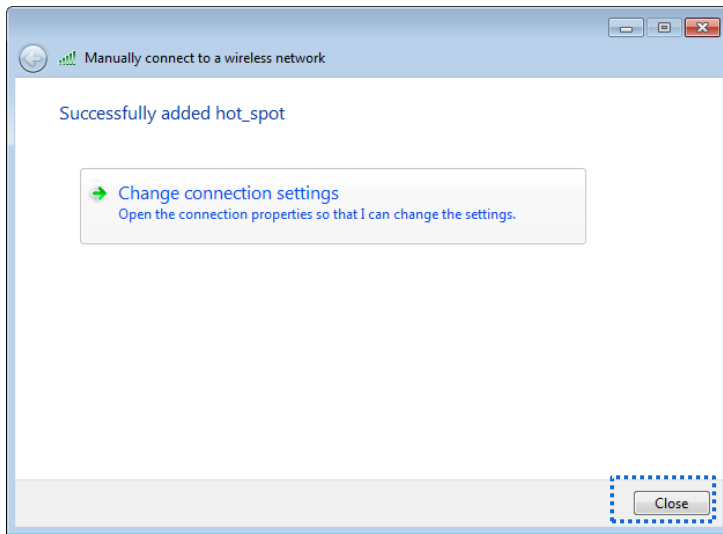

12. Click the network icon in the lower-right corner of the desktop and choose the wireless network of the CPE such as **hotspot** in this example.

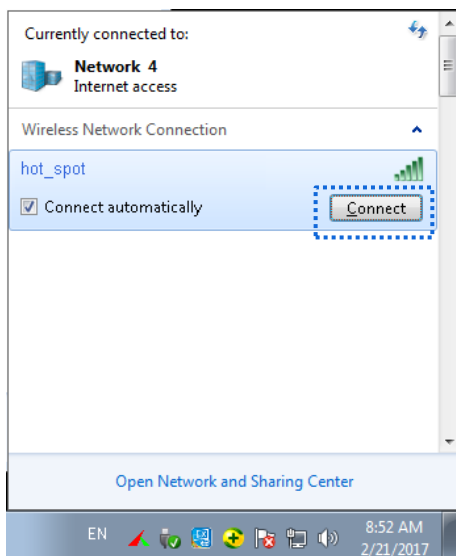

13. In the Windows Security dialog box that appears, enter the [user name and password](#) set on the RADIUS server and click **OK**.

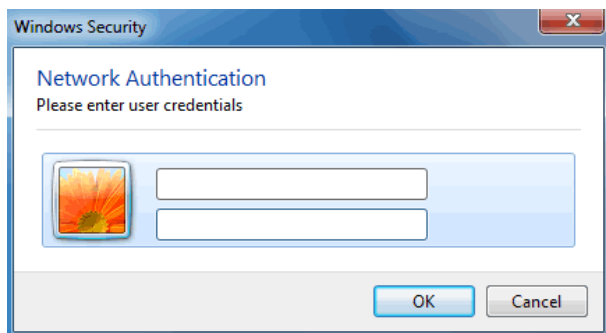

## Verification

Wireless devices can connect to the wireless network **hotspot**.

## 7.2 Advanced

### 7.2.1 Overview

This module enables you to adjust the wireless performance. You are recommended to configure it under the guide of a professional.

### Changing Advanced Settings

---



It is recommended that you change the settings only under the instruction of professional personnel, so as to prevent decreasing the wireless performance of the CPE.

---

1. Choose Wireless > Advanced.
2. Change the parameter settings as required.
3. Click **Save**.

**Advanced** ?

WMM  Enable  Disable

APSD  Enable  Disable

Minimum RSSI Threshold  Enable  Disable

Preamble  Short Preamble  Long Preamble

Signal Transmission  Coverage-oriented  Capacity-oriented

Signal Reception Level  ▼

Transmission Distance  km (Range: 0.1 to 20, default: 3)

Beacon Interval  ms (Range: 40 to 999, default: 100)

Fragment Threshold  (Range: 256 to 2346, default: 2346)

RTS Threshold  (Range: 1 to 2347, default: 2347)

DTIM Interval  (Range: 1 to 255, default: 1)

Signal LED1 Threshold  dBm (Range: -99 to 0, default: -90)

Signal LED2 Threshold  dBm (Range: -99 to 0, default: -80)

Signal LED3 Threshold  dBm (Range: -99 to 0, default: -70)

---End

### Parameters Description

| Name                   | Description  |
|------------------------|--|
| WMM                    | WMM is a wireless QoS protocol ensuring that packets with higher priorities are transmitted earlier. This ensures better QoS of voice and video applications over wireless networks. You are recommended to enable it.   |
| APSD                   | Automatic Power Save Delivery. If it is enabled, the power consumption of this device is reduced after a specified period during which no traffic is transmitted or received. By default, it is disabled.  |
| Minimum RSSI Threshold | It specifies the minimum strength of received signals acceptable to this device. If the strength of the signals transmitted by a wireless device is weaker than this threshold, the wireless device cannot connect to this device. If there are multiple CPEs in a network, setting a proper value helps wireless devices connect to WiFi network with better WiFi signal.                       |
| Preamble               | It specifies a group of bits located at the beginning of a packet to enable a receiver of the packet to perform synchronization and prepare for receiving data. By default, the Long Preamble option is selected for compatibility with old network adapters installed on wireless clients. To achieve better synchronization performance of networks, you can select the Short Preamble option. |
| Signal Transmission    | It specifies the wall penetrating capability of the CPE.<br>Coverage-oriented: With less interference nearby, this mode enables the CPE to cover wider   |

| Name                      | Description  |
|---------------------------|--|
|                           | area.<br>Capacity-oriented: With strong interference nearby, this mode improves the CPE's anti-interference capability.  |
| Signal Reception Level    | It is used to adjust the signal reception level. A higher level leads to better signal reception capability, but lower throughput.   |
| Transmission Distance     | It specifies the wireless transmission distance of this device. You can set it based on the actual installation distance.  |
| Beacon Interval           | It specifies the interval at which this device sends Beacon frames. Beacon frames are sent at the interval to announce the existence of a wireless network. Generally, a smaller interval allows wireless clients to connect to this device sooner, while a larger interval allows the wireless network to transmit data quicker.  |
| Fragment Threshold        | It specifies the threshold of a fragment. The unit is byte. Fragmenting is a process that divides a frame into several fragments, which are transmitted and acknowledged separately. If the size of a frame exceeds this threshold, the frame is fragmented. In case of a high error rate, you can reduce the threshold to enable this device to resend only the fragments that have not been sent successfully, so as to increase the frame throughput. In an environment with little interference, you can increase the threshold to reduce the number of frames, so as to increase the frame throughput. Frame length threshold for triggering the RTS/CTS mechanism. If a frame exceeds this threshold, the RTS/CTS mechanism is triggered to reduce conflicts. The unit is byte. Set the RTS threshold based on the actual situation. An excessively small value increases the RTS frame transmission frequency and bandwidth requirement. A higher RTS frame transmission frequency enables a wireless network to recover from conflicts quicker. For a wireless network with high user density, you can reduce this threshold for reducing conflicts. The RTS mechanism requires some network bandwidth. Therefore, it is triggered only when frames exceed this threshold. |
| RTS Threshold             | It specifies the frame length threshold for triggering the RTS/CTS mechanism. If a frame exceeds this threshold, the RTS/CTS mechanism is triggered to reduce conflicts. The unit is byte. Set the RTS threshold based on the actual situation. An excessively small value increases the RTS frame transmission frequency and bandwidth requirement. A higher RTS frame transmission frequency enables a wireless network to recover from conflicts quicker. For a wireless network with high user density, you can reduce this threshold for reducing conflicts. The RTS mechanism requires some network bandwidth. Therefore, it is triggered only when frames exceed this threshold.  |
| DTIM Interval             | It specifies the countdown before this device transmits broadcast and multicast frames in its cache. The unit is Beacon interval. For example, if DTIM Interval is set to 1, this device transmits all cached frames at one Beacon interval.   |
| Signal LED1/2/3 Threshold | It is used to edit the threshold value determining whether WiFi signal LEDs light up. Corresponding LED will be triggered to light up when the received WiFi signal strength reaches the threshold.  |

## 7.3 Access Control

### 7.3.1 Overview

It specifies, based on MAC address filter rules, the wireless devices that can or cannot access the wireless networks of the CPE. The CPE supports the following MAC address filter rules:

- **Disallow:** It indicates that only the wireless devices with the specified MAC addresses cannot access the wireless networks of the CPE.
- **Allow:** It indicates that only the wireless devices with the specified MAC addresses can access the wireless networks of the CPE.

## 7.3.2 Configuring Access Control

### Configuration Procedure

1. Choose Wireless > Access Control.
2. Enable the **Access Control** function.
3. Select a MAC address filter mode, **Disallow** or **Allow**.
4. Enter the MAC addresses to control in the access control list and click **Add**.



If the wireless devices to be controlled are connected to the CPE, directly click **Add online devices** to add them to the access control list quickly.

5. Click **Save**.

Access Control

SSID IP-COM\_123456

Access Control

Mode  Disallow  Allow

MAC Address  :  :  :  :  :

| SN | MAC Address       | Status                                     | Operation |
|----|-------------------|--|-----------|
| 1  | 12:12:12:12:12:12 | <input checked="" type="checkbox"/> Enable |           |

[Access Control List](#)

---End

### Parameters Description

| Name           | Description  |
|----------------|--|
| SSID           | It specifies the SSID that requires wireless client access control.  |
| Access Control | It specifies whether to enable the Access Control function.  |
| Mode           | It specifies the mode for filtering MAC addresses. <ul style="list-style-type: none"><li>– <b>Allow</b>: It indicates that only the wireless clients on the access control list can connect to the WiFi network of the CPE.</li><li>– <b>Disallow</b>: It indicates that only the wireless clients on the access control list cannot connect to the WiFi network of the CPE.</li></ul> |

## 7.3.3 Example of Configuring Access Control

### Networking Requirement

A wireless network whose SSID is IP-COM\_123456 has been set up in a residential community. Only several users are allowed to connect to the wireless network.

The Access Control function of the CPE is recommended. Assume that the users have three wireless devices whose MAC addresses are C8:3A:35:00:00:01, C8:3A:35:00:00:02, and C8:3A:35:00:00:03.

### Configuration Procedure:

1. Choose Wireless > Access Control.
2. Enable the **Access Control** function.
3. Set the **Mode** to **Allow**.
4. Enter the MAC address, which is C8:3A:35:00:00:01 is this example, and click **Add**.
5. Perform step 4 to add the other two MAC addresses.
6. Click **Save**.

**Access Control** ?

SSID IP-COM\_123456

Access Control

Mode  Disallow  Allow

---

MAC Address  :  :  :  :  :

| SN | MAC Address       | Status                                     | Operation                             |
|----|-------------------|--|---------------------------------------|
| 1  | C8:3A:35:00:00:01 | <input checked="" type="checkbox"/> Enable | <input type="button" value="Delete"/> |
| 2  | C8:3A:35:00:00:02 | <input checked="" type="checkbox"/> Enable | <input type="button" value="Delete"/> |

---End

## Verification

Only above-mentioned wireless devices can connect to the WiFi network of the CPE.

# 8 Advanced

## 8.1 LAN Rate

### 8.1.1 Overview

Choose **Advanced** > **LAN Rate** to enter the page.

This module enables you to change LAN speed and duplex mode settings.

When you change the settings, ensure that the LAN speed and duplex mode of the port of the CPE is the same as that of the corresponding peer device. By default, the LAN speed settings of the two ports are both **Auto Negotiation**.

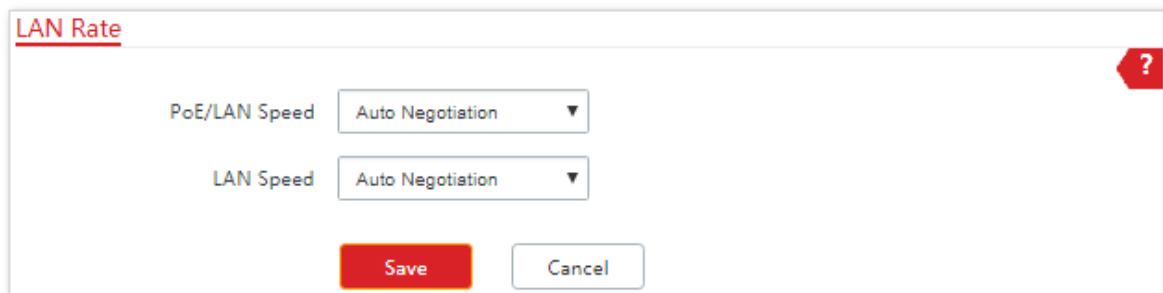

The screenshot shows a configuration window titled "LAN Rate" in red text. In the top right corner, there is a red question mark icon. The window contains two settings, each with a label and a dropdown menu:

- PoE/LAN Speed**: The dropdown menu is set to "Auto Negotiation".
- LAN Speed**: The dropdown menu is set to "Auto Negotiation".

At the bottom of the window, there are two buttons: a red "Save" button and a white "Cancel" button with a grey border.

## 8.1.2 Changing the LAN Speed and Duplex Mode

### Configuration Procedure

1. Choose **Advanced** > **LAN Rate**.
2. Select a LAN speed and duplex mode for each LAN port.
3. Click **Save**.

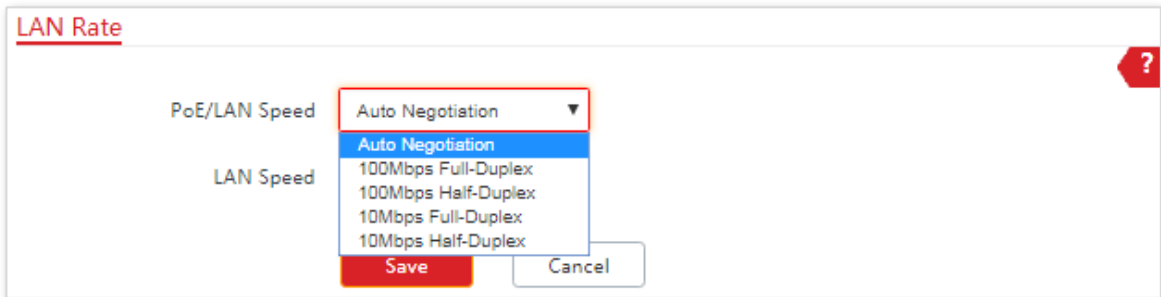

---End

### Verification

Choose **Status** and check the changes in **System Status** part.

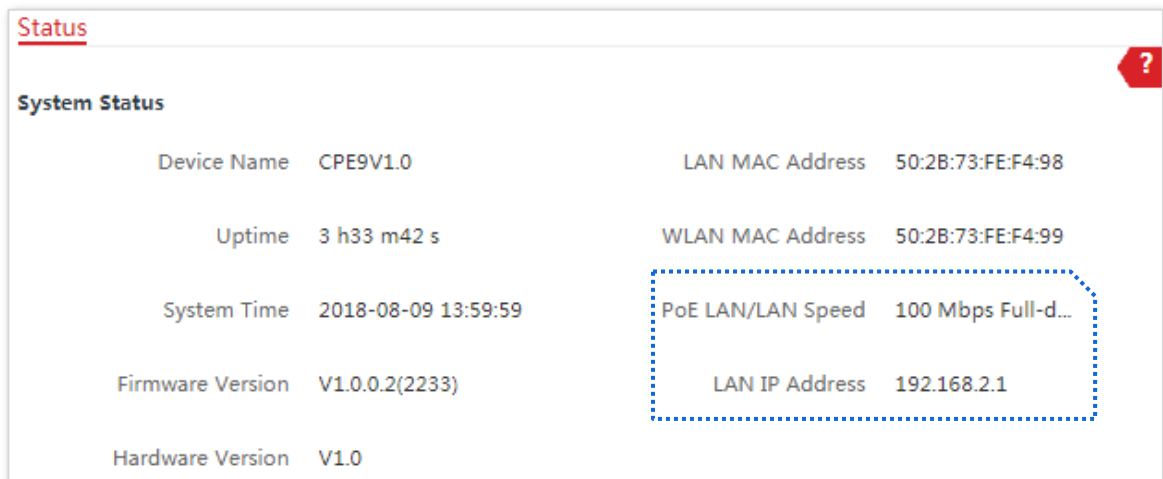

## 8.2 Diagnose

### 8.2.1 Overview

Choose **Advanced** > **Diagnose** to enter the page.

If the network connection fails, you can use the diagnosis tools included with the CPE to locate the faulty node.

### 8.2.2 Site Survey

It is used to scan WiFi signals nearby for analysis with SSIDs, MAC addresses, channels and signal strength marked.



Assume that you want to know the WiFi networks nearby.

### Configuration Procedure

1. Choose **Advanced** > **Diagnose**.
  2. Select **Site Survey** in the **Diagnose** list.
- End

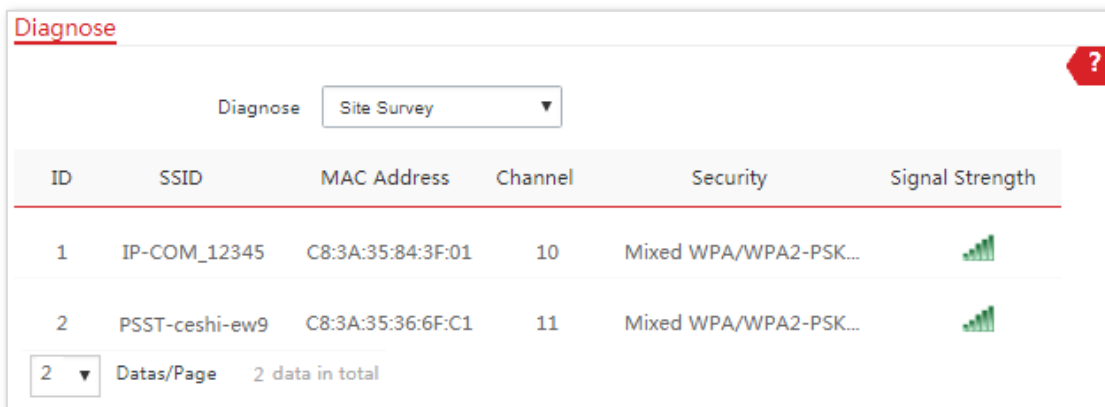
The diagnosis result will be displayed in a few seconds in the list below the **Diagnose** box. See the following figure:



| ID | SSID           | MAC Address       | Channel | Security              | Signal Strength   |
|----|----------------|-------------------|---------|-----------------------|---|
| 1  | IP-COM_12345   | C8:3A:35:84:3F:01 | 10      | Mixed WPA/WPA2-PSK... |  |
| 2  | PSST-ceshi-ew9 | C8:3A:35:36:6F:C1 | 11      | Mixed WPA/WPA2-PSK... |  |

2 Datas/Page 2 data in total

According to the diagnosis result, you can select a less interference channel (used by few devices) for the wireless network of the CPE to improve the transmission efficiency.

## 8.2.3 Ping

You can use ping to detect the connectivity and quality of network connection.

Assume that you want to know whether the CPE can access google.

### Configuration Procedure

1. Choose **Advanced** > **Diagnose**.
2. Select **Ping** in the Diagnose list.
3. Set **IP Address** to **Manual**.
4. Enter an IP address or a domain name, which is **www.google.com** in this example.
5. Enter a number of packets transmitted by ping.
6. Enter the size of packet transmitted by ping.
7. Click **Start**.

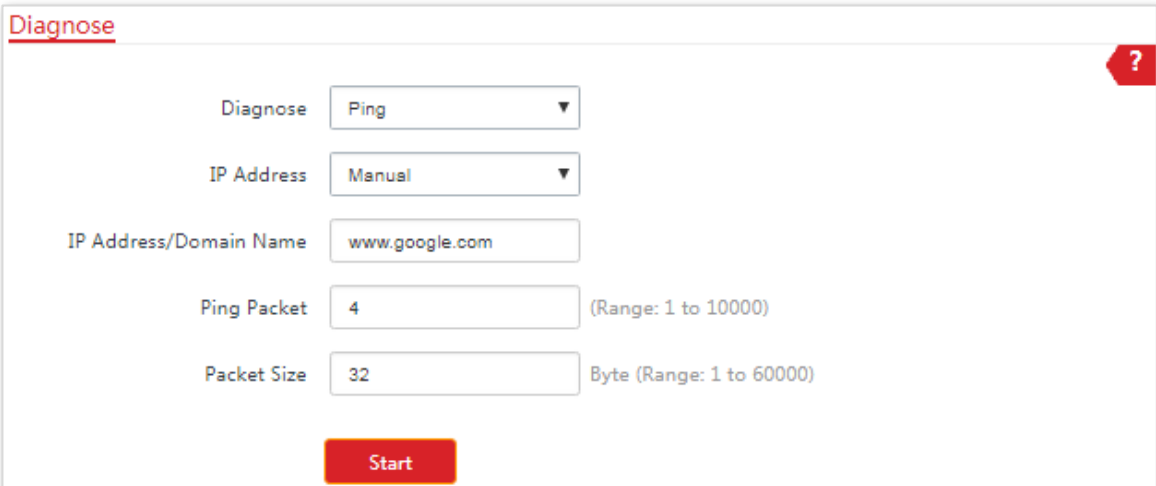

The screenshot shows a web interface titled "Diagnose" with a red question mark icon in the top right corner. The interface contains the following fields and controls:

- Diagnose:** A dropdown menu with "Ping" selected.
- IP Address:** A dropdown menu with "Manual" selected.
- IP Address/Domain Name:** A text input field containing "www.google.com".
- Ping Packet:** A text input field containing "4", with a range of "(Range: 1 to 10000)" to its right.
- Packet Size:** A text input field containing "32", with a range of "Byte (Range: 1 to 60000)" to its right.
- Start:** A red button located at the bottom center of the form.

---End

The diagnosis result will be displayed in a few seconds in the list below **Start** button. See the following figure:

The screenshot shows a web interface for network diagnosis. At the top left is the title 'Diagnose' in red. In the top right corner, there is a red button with a white question mark. Below the title, there are several configuration fields: 'Diagnose' is set to 'Ping', 'IP Address' is set to 'Manual', 'IP Address/Domain Name' is 'www.google.com', 'Ping Packet' is '4' (with a range of 1 to 10000), and 'Packet Size' is '32' (with a range of 1 to 60000). A red 'Start' button is centered below these fields. Below the configuration is a table with three columns: 'IP Address', 'Time', and 'TTL'. The table contains four rows, all with 'www.google.com' in the first column, 'Timeout' in the second, and '--' in the third. Below the table, there is a pagination control showing '10' items per page and '4 data in total'. A summary bar at the bottom of the table area displays '0 of 4 packets received, 100.00% loss100.00%'. At the very bottom, there are three statistics: 'Min. 0 ms', 'Average 0.00 ms', and 'Max. 0 ms'.

| IP Address     | Time    | TTL |
|----------------|---------|-----|
| www.google.com | Timeout | --  |
| www.google.com | Timeout | --  |
| www.google.com | Timeout | --  |
| www.google.com | Timeout | --  |

10 Datas/Page 4 data in total

0 of 4 packets received, 100.00% loss100.00%

Min. 0 ms      Average 0.00 ms      Max. 0 ms

## 8.2.4 Traceroute

You can use the Traceroute tool to detect the routes that the packets pass by from the device to destination host.

Assume that you want to detect the routes that the packets pass by from the CPE to **cn.bing.com**.

### Configuration Procedure

1. Choose **Advanced** > **Diagnose**.
2. Select **Traceroute** in the Diagnose list.
3. Enter an IP address or a domain name, which is **cn.bing.com** in this example.
4. Click **Start**.

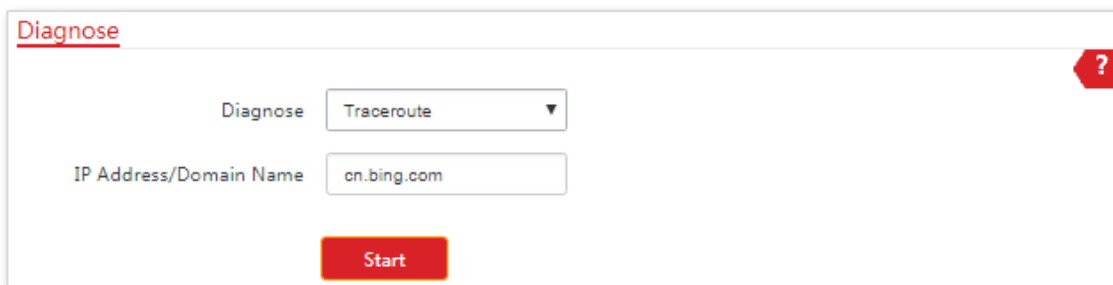

The screenshot shows the 'Diagnose' section of a web interface. At the top left, the word 'Diagnose' is underlined in red. On the right side, there is a red hexagonal button with a white question mark. Below this, there is a 'Diagnose' label followed by a dropdown menu currently set to 'Traceroute'. Underneath, there is an 'IP Address/Domain Name' label followed by a text input field containing 'cn.bing.com'. At the bottom center, there is a red 'Start' button.

---End

The diagnosis result will be displayed in a few seconds in the list below **Start** button. See the following figure:

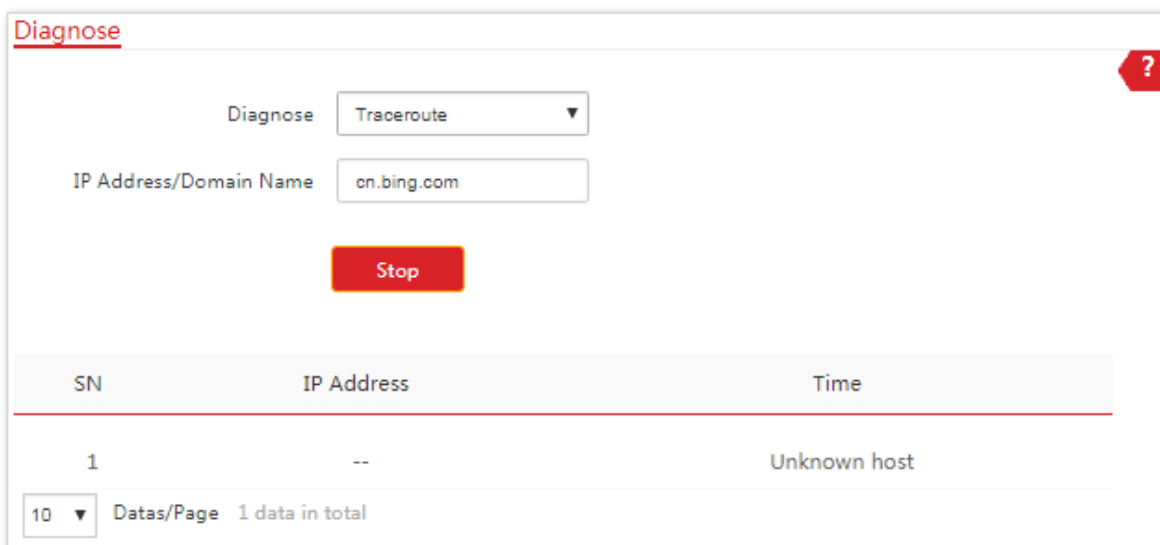

The screenshot shows the 'Diagnose' section of a web interface after the traceroute has been executed. The 'Diagnose' label and dropdown menu (set to 'Traceroute') are still present. The 'IP Address/Domain Name' field still contains 'cn.bing.com'. Below this, there is a red 'Stop' button. A table with the following structure is displayed below the 'Stop' button:

| SN | IP Address | Time         |
|----|------------|--------------|
| 1  | --         | Unknown host |

At the bottom left, there is a dropdown menu set to '10' and the text 'Datas/Page 1 data in total'.

## 8.2.5 Speed Test

It is used to test the throughput between two IP-COM CPE in the same network. The test requires one of the two devices to be set as a server and the other as a client. The client launches the test request to the server and the server responds to it. The test result displays on the Speed Test page of the client.

Choose **Advanced > Diagnose** to enter the page.

Set Diagnose to **Speed Test**.

Diagnose Speed Test

| ↑ AVG RX | ↓ AVG TX | ↕ AVG Total |
|----------|----------|-------------|
| 0 Mbps   | 0 Mbps   | 0 Mbps      |

Client  Server

IP Address of Peer AP Manual

IP Address

HTTP Port

User Name

Password

Test Group  (Range: 1 to 20)

Direction Bidirectional

Time  s (Range: 1 to 60)

**Start**

### Parameters Description

| Name                  | Description   |
|-----------------------|---|
| IP Address of Peer AP | It specifies the LAN IP address of peer CPE. You can enter one manually.  |
| IP Address            | If the <b>IP Address of Peer AP</b> is set to <b>Manual</b> , you need to enter the LAN IP address of peer CPE in the box manually. |
| HTTP Port             | It specifies the port number of HTTP service. Default: <b>80</b> . You are recommended to keep the default value.                   |
| User Name             | It specifies the user name of web UI of peer CPE.   |
| Password              | It specifies the password of web UI of peer CPE.  |

| Name          | Description   |
|---------------|---|
| Test Group    | It specifies the number of test connection launched by the client. Range: 1 to 20.  |
| Direction     | It specifies the test speed direction. <ul style="list-style-type: none"><li>– <b>RX</b> (Receive): only test the speed that the peer device transmits data to this device.</li><li>– <b>TX</b> (Transit): only test the speed that this device transmits data to peer device.</li><li>– <b>Bidirectional</b>: test the speed that this device transmits data to peer device and the peer device transmits data to this device.</li></ul> |
| Time          | It specifies the period of speed test.  |
| Test Progress | It specifies the process of speed test.   |
| Test Result   | It displays the test result. <ul style="list-style-type: none"><li>– <b>AVG RX</b>: It specifies the average of received speed.</li><li>– <b>AVG TX</b>: It specifies the average of transmitted speed.</li><li>– <b>AVG Total</b>: It specifies the average of the total connection speed.</li></ul>   |

## Examples of Configuring the Speed Test

Assume that CPE1 works in AP mode, and CPE2 works in Client mode and bridges to the WiFi network of CPE1. Then test the wireless speed between them.

### Configuration Procedure

1. Log in to the web UI of CPE2.
2. Choose **Advanced > Diagnose**.
3. Set **Diagnose** to **Speed Test**.
4. Set **IP Address of Peer AP** to **Manual**.
5. Enter the IP address of CPE1 to the **IP Address** box, which is **192.168.2.1** in this example.
6. Enter the login user name and password of the web UI of CPE1 in the **User name** and **Password** boxes, which are both **admin** in this example.
7. Set **Direction** to **Bidirectional**.
8. Click **Start**.

**Diagnose** ?

\* Diagnose

| ↑ AVG RX | ↓ AVG TX | ↕ AVG Total |
|----------|----------|-------------|
| 0 Mbps   | 0 Mbps   | 0 Mbps      |

Client  Server

\* IP Address of Peer AP

\* IP Address

HTTP Port

\* User Name

\* Password

Test Group  (Range: 1 to 20)

\* Direction

Time  s (Range: 1 to 60)

\*

---End

The test result will be displayed in a few seconds in the list below the **Diagnose** box. See the following figure:

**Diagnose** ?

Diagnose

| ↑ AVG RX   | ↓ AVG TX  | ↕ AVG Total |
|------------|-----------|-------------|
| 44.57 Mbps | 48.9 Mbps | 53.47 Mbps  |

## 8.3 Bandwidth Control (Only for CPE9)

This function is available only when the CPE works in **WISP** or **Router** mode.

### 8.3.1 Overview

If multiple devices access the internet through the CPE, bandwidth control is recommended, so that high-speed file download by a device does not reduce the internet access speed of the other devices.

Choose **Advanced > Bandwidth Control** to enter the page.

**Bandwidth Control** ?

Remark

IP Address Range 192.168.2.  ~ 192.168.2.

Max. Upload Rate  Mbps ▼

Max. Download Rate  Mbps ▼

**Add**

| ID | Remark | IP Address Range | Max. Upload Rate | Max. Download Rate | Status | Action |
|----|--------|------------------|------------------|--------------------|--------|--------|
|----|--------|------------------|------------------|--------------------|--------|--------|

### Configuring Bandwidth Control

1. Choose **Advanced > Bandwidth Control**.
2. Set up the related parameters.
3. Click **Add**.

### Bandwidth Control

Remark

IP Address Range  ~

Max. Upload Rate  Mbps

Max. Download Rate  Mbps

| ID | Remark | IP Address Range | Max. Upload Rate | Max. Download Rate | Status | Action |
|----|--------|------------------|------------------|--------------------|--------|--------|
|----|--------|------------------|------------------|--------------------|--------|--------|

---End

#### Parameters Description

| Name               | Description   |
|--------------------|---|
| Remark             | It specifies the additional information of the bandwidth control rule.  |
| IP Address Range   | It specifies the IP addresses or range of devices that this rule applies to.                                      |
| Max. Upload Rate   | It specifies the maximum upload/download rate of the each device whose IP address is within the IP Address Range. |
| Max. Download Rate |   |
| Status             | It specifies the current status of the rule. You can enable or disable it as required.                            |
| Action             | Click  to delete the rule.     |

## 8.3.2 Examples of Configuring Bandwidth Control

### Networking Requirement

The CPE is used in a company to deploy its network, and the device is set to Router mode. To ensure that every device can access the internet smoothly, you want to specify a maximum upload/download for each device.

**Assumption:** The maximum upload rate of each device connected to the WiFi network of the CPE is **1 Mbps**, and download rate is **2 Mbps**. And the IP address range of the devices connected to the WiFi network is **192.168.2.100** to **192.168.2.200**.

## Configuration Procedure

1. Choose **Advanced** > **Bandwidth Control**.
2. Enter a remark, such as **Devices of Office1**.
3. Specify an IP address range, which are **100** and **200** in this example.
4. Specify the maximum upload rate and download rate respectively, which are **1** and **2** in this example.
5. Click **Add**.

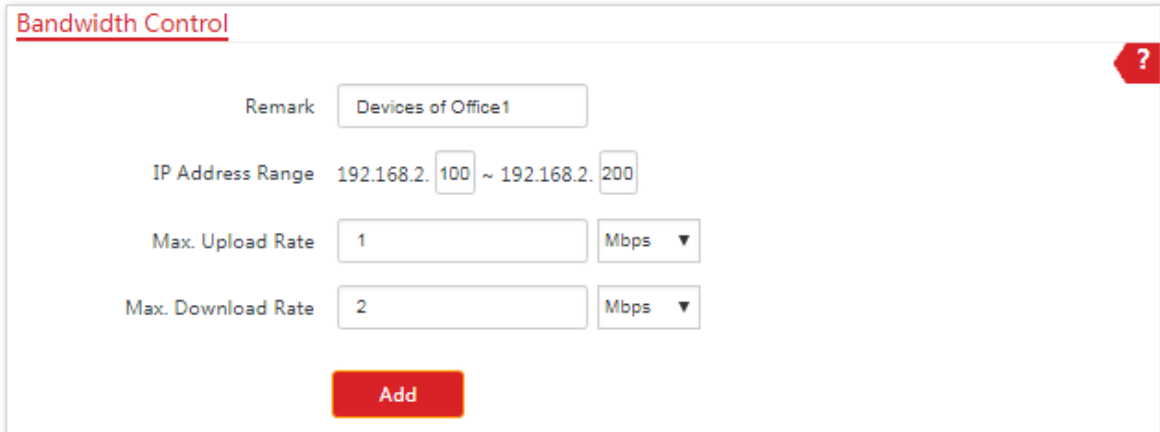

The screenshot shows a web interface for configuring bandwidth control. The title is "Bandwidth Control" with a red question mark icon in the top right corner. The form contains the following fields:

- Remark:
- IP Address Range:  ~
- Max. Upload Rate:  Mbps (dropdown)
- Max. Download Rate:  Mbps (dropdown)

At the bottom of the form is a red "Add" button.

---End

If the rule is added successfully, it is displayed in the list below the **Add** button. See the following figure:

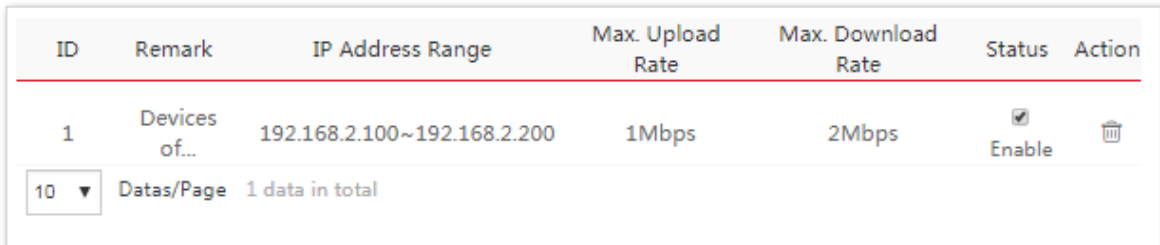

| ID | Remark        | IP Address Range            | Max. Upload Rate | Max. Download Rate | Status  | Action |
|----|---------------|-----------------------------|------------------|--------------------|---|--------|
| 1  | Devices of... | 192.168.2.100~192.168.2.200 | 1Mbps            | 2Mbps              | <input checked="" type="checkbox"/><br>Enable |        |

10 ▼ Datas/Page 1 data in total

## Verification

A device whose IP address is within the range of 192.168.2.100 to 192.168.2.200, its maximum upload rate is 1 Mbps and its maximum download rate is 2 Mbps.

## 8.4 Port Forwarding (Only for CPE9)

This function is available only when the CPE works in **WISP** or **Router** mode.

### 8.4.1 Overview

If computers are connected to the router to form a LAN and access the internet through the router, internet users cannot access the hosts on the LAN. Therefore, the servers, such as web servers, email servers, and FTP servers, on the LAN are inaccessible to internet users. To enable internet users to access a LAN server, enable the port forwarding function of the router, and map one service port to the IP address of the LAN server. This enables the router to forward the requests arriving at the port from the internet to the LAN server, and avoid the attacks from the WAN.

Choose **Advanced > Port Forwarding** to enter the page.

Port Forwarding

Internal IP Address

Internal Port

External Port

Protocol

Application

**Add**

| ID | Internal IP Address | Internal Port | External Port | Protocol | Application | Status | Action |
|----|---------------------|---------------|---------------|----------|-------------|--------|--------|
|----|---------------------|---------------|---------------|----------|-------------|--------|--------|

### 8.4.2 Configuring Port Forwarding

#### Configuration Procedure

1. Choose **Advanced > Port Forwarding**.
2. Set the related parameters.
3. Click **Add**.

### Port Forwarding

Internal IP Address

Internal Port

External Port

Protocol

Application

| ID | Internal IP Address | Internal Port | External Port | Protocol | Application | Status | Action |
|----|---------------------|---------------|---------------|----------|-------------|--------|--------|
|----|---------------------|---------------|---------------|----------|-------------|--------|--------|

---End

#### Parameters Description

| Name                | Description   |
|---------------------|---|
| Internal IP Address | It specifies the IP address of the host which establishes a server in LAN.                                    |
| Internal Port       | It specifies the service port of the server in LAN. A single port is supported.                               |
| External Port       | It specifies the ports enabled for WAN users by this device.  |
| Protocol            | It specifies the protocol type of the selected applications. Select TCP&UDP when you are not sure.            |
| Application         | It specifies the application services established in LAN.   |
| Action              | Click  to delete the rule. |

## 8.4.3 Example of Configuring Port Forwarding

### Networking Requirement

The CPE is used in a company to deploy its network, and the CPE is set to Router mode.

**Requirement:** The employees of the company who are on business can visit the resources on the web server in LAN over the internet.

You are recommended to use port forwarding function to solve the problem.

**Assumption:**

- IP Address of the web server: 192.168.2.100

- Service port (internal port) of the web server in LAN:80
- External port that this device enables for internet devices: 80
- WAN IP Address of the CPE: 202.105.11.22

## Network Topology

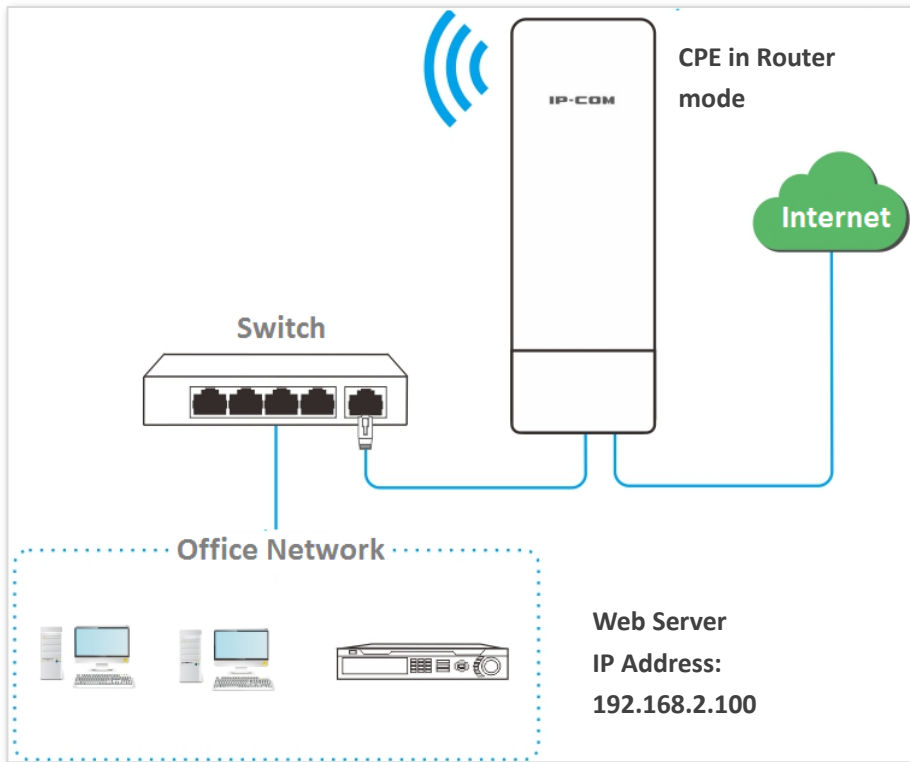

## Configuration Procedure

1. Log in to the web UI of the CPE which works in **Router** mode.
2. Choose **Advanced > Port Forwarding**.
3. Enter the IP address of the web server in the **Internal IP Address** box, which is **192.168.2.100** in this example.
4. Enter **80** and **80** on the **Internal Port** and **External Port** boxes respectively.
5. Select **TCP&UDP** from the dropdown list of **Protocol**.
6. Select **HTTP** from the dropdown list of **Application**.
7. Click **Add**.

**Port Forwarding** ?

Internal IP Address:

Internal Port:

External Port:

Protocol:

Application:

**Add**

---End

If the rule is added successfully, it is displayed in the list below the **Add** button. See the following figure:

| ID | Internal IP Address | Internal Port | External Port | Protocol | Application | Status                                     | Action |
|----|---------------------|---------------|---------------|----------|-------------|--|--------|
| 1  | 192.168.2.100       | 80            | 80            | TCP&UDP  | Telnet      | <input checked="" type="checkbox"/> Enable |        |

10 Datas/Page 1 data in total

## Verification

Enter **Protocol name://WAN port IP address:External port** in the address bar of a web browser on a computer over the internet to access the resources on the web server. In this example, enter **http://202.105.11.22**.



If internet users still cannot visit the web server in LAN after the configuration, try the following solutions:

- Ensure that the WAN IP address of the CPE is a public IP address, and the internal port you entered is correct.
- Security software, antivirus software, and the built-in OS firewall of the computer may cause port forwarding function failures. Disable them and try again.
- Manually set an IP address and related parameters for the web server to avoid the service disconnection caused by the dynamic IP address.

## 8.5 MAC Filter (Only for CPE9)

This function is available only when the CPE works in **WISP** or **Router** mode.

### 8.5.1 Overview

The MAC Filter function enables you to allow or disallow the devices, such as computers, laptops, tablets, and smart phones, to access the internet via the CPE based on their MAC addresses.

Choose **Advanced** > **MAC Filter** to enter the page.

The function is disabled by default.

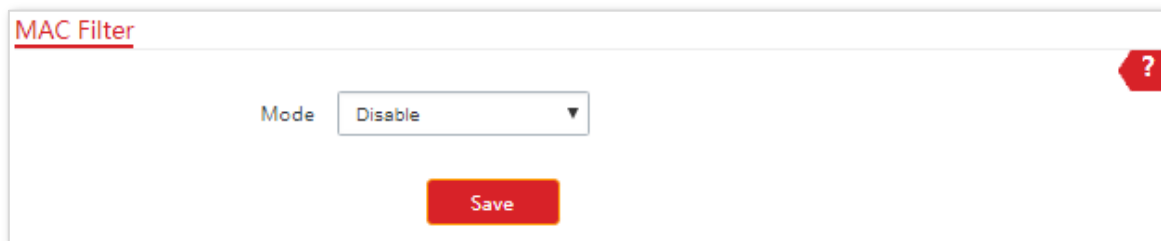

### 8.5.2 Configuring MAC Filter

#### Configuration Procedure

1. Choose **Advanced** > **MAC Filter**.
2. Select a MAC filter mode, Disallow or Allow.
3. Enter a remark for the rule, such as somebody's device.
4. Specify a period at which the rule takes effect.
5. Tick the dates on which the rule takes effect.
6. Click **Add**.

### MAC Filter ?

Mode Disallow ▼

Remark Disallow  
Allow  
Disable

MAC Address

Time 00 ▼ : 00 ▼ ~ 00 ▼ : 00 ▼

Date  Mon.  Tue.  Wed.  Thur.  
 Fri.  Sat.  Sun.  Every Day

Add

| ID | Remark | MAC Address | Time | Mode | Status | Action |
|----|--------|-------------|------|------|--------|--------|
|----|--------|-------------|------|------|--------|--------|

---End

### Parameters Description

| Name        | Description   |
|-------------|---|
| Mode        | <p>It specifies the mode of MAC filter rule.</p> <ul style="list-style-type: none"> <li>– <b>Disable:</b> Disable the MAC Filter function.</li> <li>– <b>Allow:</b> Allow the devices with the MAC addresses in the list to access the internet via this device, and disallow the other devices to access the internet via this device.</li> </ul> <p>Disallow: Disallow the devices with the MAC addresses in the list to access the internet via this device, and allow the other devices to access the internet via this device.</p> |
| Remark      | It specifies the additional information of the rule.  |
| MAC Address | It specifies the MAC address of the device to which the rule applies.   |
| Time        | It specifies the period at which the rule takes effect.   |
| Date        | It specifies the dates on which the rule takes effect.  |
| Status      | It specifies the status of the rule.  |
| Action      | Click  to delete the rule.  |

## 8.5.3 Examples of Configuring MAC Filter

### Network Topology

The CPE is used in a company to deploy its network, and the CPE is set to Router mode.

**Requirements:** Only allow the procurement staff to access the internet during working hours (9:00 to 17:00, Monday to Friday).

You are recommended to use the MAC Filter function to solve the problem.

**Assumption:**

The MAC address of the procurement staff's device is **CC:3A:61:71:1B:6E**.

### Configuration Procedure

1. Log in to the web UI of the CPE which is working in Router mode.
2. Choose **Advanced** > **MAC Filter**.
3. Select a mode, which is **Allow** in this example.
4. Enter a remark in the **Remark** box, which is **Procurement** in this example.
5. Enter the MAC address of the device, which is **CC:3A:61:71:1B:6E** in this example.
6. Specify a period, which is **9:00** to **17:00** in this example.
7. Tick the dates, which are **Monday to Friday** in this example.
8. Click **Add**.

The screenshot shows the 'MAC Filter' configuration page. At the top left, the title 'MAC Filter' is underlined. A red question mark icon is in the top right corner. The form contains the following fields and options:

- Mode:** A dropdown menu with 'Allow' selected.
- Remark:** A text input field containing 'Procurement'.
- MAC Address:** A text input field containing 'CC:3A:61:71:1B:6E'.
- Time:** Two time selection boxes. The first is '09' and the second is '00', followed by a tilde '~', then '17' and '00'.
- Date:** A row of checkboxes for 'Mon.', 'Tue.', 'Wed.', 'Thu.', 'Fri.', 'Sat.', 'Sun.', and 'Every Day'. The checkboxes for 'Mon.', 'Tue.', 'Wed.', 'Thu.', and 'Fri.' are checked.
- Add:** A red button at the bottom center.

---End

If the rule is added successfully, it is displayed in the list below the **Add** button. See the following figure:

| ID | Remark        | MAC Address       | Time   | Mode  | Status  | Action  |
|----|---------------|-------------------|--|-------|---|---|
| 1  | Procuremen... | CC:3A:61:71:1B:6E | Mon. , Tue. , Wed. , Thur. , Fri.<br>09:00-17:00 | Allow | <input checked="" type="checkbox"/><br>Enable |  |

10 ▼ Datas/Page 1 data in total

## 8.5.4 Verification

Only the device with the MAC address of CC:3A:61:71:1B:6E can access the internet at 9:00 to 17:00 from Monday to Friday. All of other devices cannot access the internet during the period.

## 8.6 Network Service

### 8.6.1 DDNS

This function is available only when the CPE works in **WISP** or **Router** mode.

#### Overview

DDNS, dynamic domain name service, enables the dynamic DNS client on the CPE to deliver the current WAN IP address to the DNS server. Then the server maps the WAN IP address to a domain name for dynamic domain name resolution.

The DDNS function maps a dynamic WAN IP address to a domain name. This function often works with the port forwarding, DMZ host, and remote web management functions. Then users can visit an address with a domain name instead of a dynamic WAN IP address which makes the visit easier.

Choose **Advanced** > **Network Service** to enter the page.

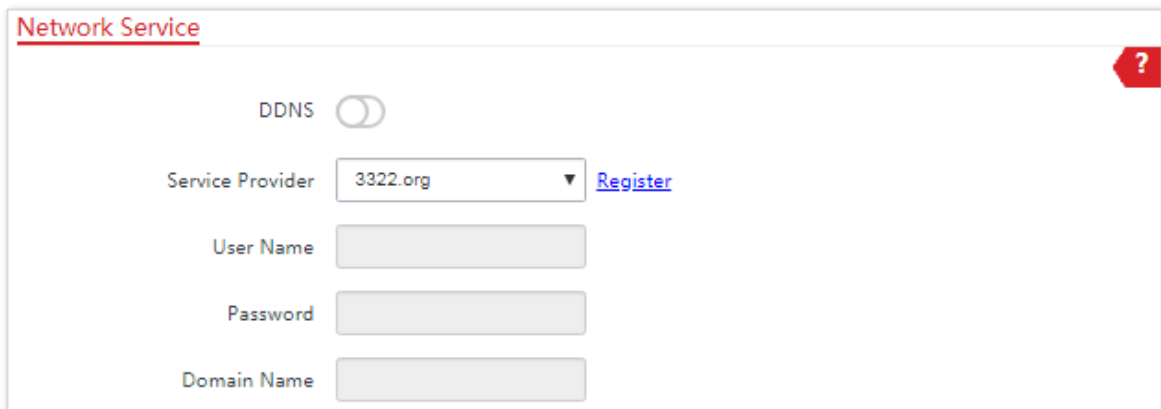

The screenshot shows the 'Network Service' configuration page. At the top left, the title 'Network Service' is underlined in red. In the top right corner, there is a red question mark icon. The main content area features a 'DDNS' toggle switch, which is currently turned off. Below the toggle, there are four input fields: 'Service Provider' (a dropdown menu with '3322.org' selected and a 'Register' link to its right), 'User Name', 'Password', and 'Domain Name' (all text input fields).

#### Configuring DDNS

##### Configuration Procedure

1. Choose **Advanced** > **Network Service**.
2. Enable the **DDNS** function.
3. Select a dynamic DNS provider from the dropdown list.
4. Enter the user name, password, and domain name you registered with DDNS service provider.
5. Click **Save** on the bottom of this page.

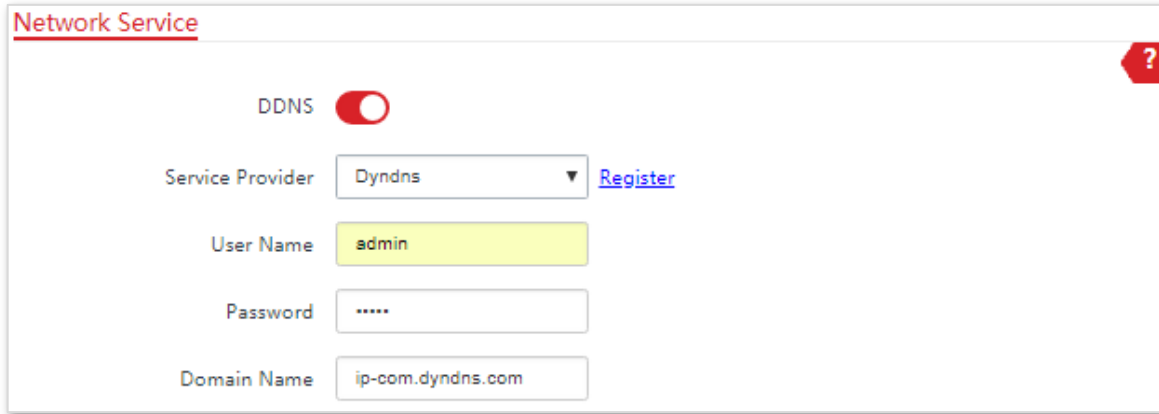

**Network Service**

DDNS

Service Provider: Dyndns [Register](#)

User Name: admin

Password: .....

Domain Name: ip-com.dyndns.com

---End

### Parameters Description

| Name             | Description  |
|------------------|--|
| DDNS             | It Specifies whether to enable the DDNS function.  |
| Service Provider | It specifies Dynamic Domain Name Service provider. The CPE supports Dyndns, No-ip.com, and 3322.org.   |
| User Name        | It specifies the user name used to log in to the dynamic DNS service, as well as the Login user name you registered on the website of the service provider.    |
| Password         | It specifies the password used to log in to the dynamic DNS service, as well as the Login password you registered on the website of the service provider.      |
| Domain Name      | It specifies the domain name information obtained from the dynamic DNS server. You need to enter the domain name which you registered on the website manually. |

## Examples of Configuring DDNS

### Networking Requirement

The CPE is used in a company to deploy its network, and it is set to Router mode. The WAN IP address of the CPE is dynamic.

**Requirement:** The administrator on business can visit the resources on web server in LAN.

You are recommended to use the DDNS and port forwarding functions to solve the problem.

**Assumption:**

The information of the web server in LAN is shown as follows:

**IP Address:** 192.168.2.100

**Service Port of the Web Server:** 80

The registered domain name information is shown as follows:

**Service Provider:** Dyndns

**User Name:** ip-com

**Password:** ip-com

**Domain Name:** ip-com.dyndns.com

## Network Topology

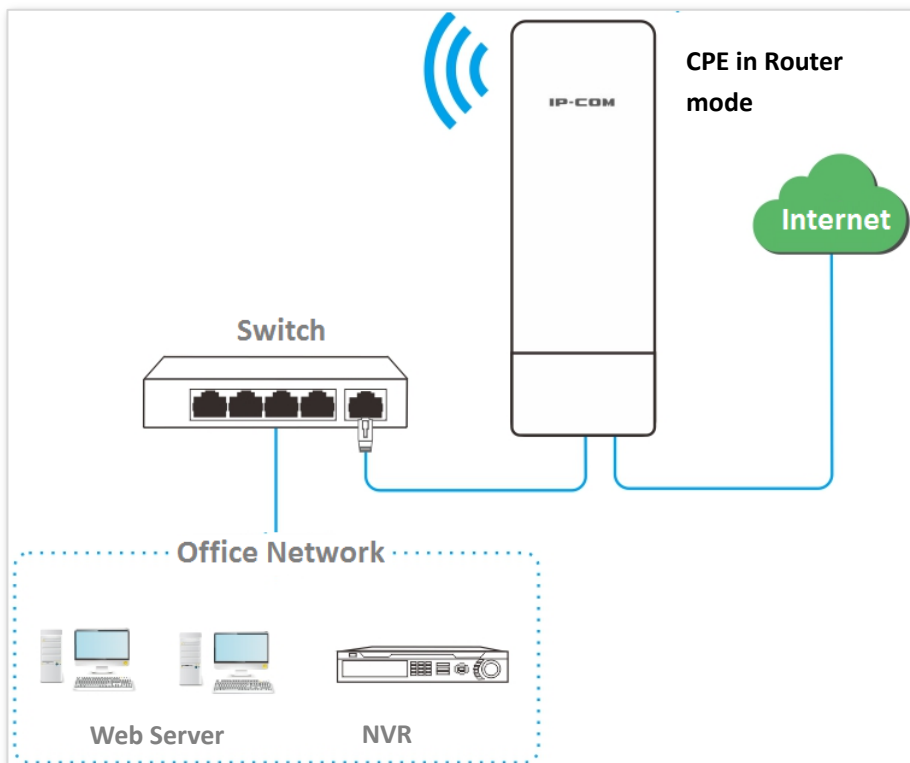

## Configuration Procedure

1. Set up the DDNS function.
  - (1) Log in to the web UI of the CPE which works in Router mode.
  - (2) Choose **Advanced > Network Service**.
  - (3) Enable the **DDNS** function.
  - (4) Select a service provider, which is **Dyndns** in this example.
  - (5) Enter the user name and password you registered, which are **ip-com** and **ip-com** in this example.
  - (6) Enter the domain name you registered, which is **ip-com.dyndns.com**.
  - (7) Click **Save** on the bottom of this page.
2. Set up the port forwarding function.
  - (1) Choose **Advanced > Port Forwarding**.
  - (2) Enter the IP address of the web server, which is **192.168.2.100** in this example.

- (3) Select an application, which is **HTTP** in this example.
- (4) Select the protocol of the service. **TCP&UDP** is recommended if you are not sure.
- (5) Click **Add**.

**Port Forwarding**

Internal IP Address: 192.168.2.100

Internal Port: 80

External Port: 80

Protocol: TCP&UDP

Application: HTTP

**Add**

---End

If the rule is added successfully, it is displayed in the list below the **Add** button. See the following figure:

| ID | Internal IP Address | Internal Port | External Port | Protocol | Application | Status                                     | Action |
|----|---------------------|---------------|---------------|----------|-------------|--|--------|
| 1  | 192.168.2.100       | 80            | 80            | TCP&UDP  | HTTP        | <input checked="" type="checkbox"/> Enable |        |

10 Datas/Page 1 data in total

## Verification

Enter Protocol name://WAN port domain name:External port in the address bar of a web browser on a computer over the internet to access the resources on the web server. In this example, enter **http://ip-com.dyndns.com:80**.



Tip

If internet users still cannot visit the web server in LAN after the configuration, try the following solutions:

- Ensure that the WAN IP address of the CPE is a public IP address, and the internal port you entered is correct.
- Security software, antivirus software, and the built-in OS firewall of the computer may cause port forwarding function failures. Disable them and try again.
- Manually set an IP address and related parameters for the web server to avoid the service disconnection caused by the dynamic IP address.

## 8.6.2 Remote Web Management

### Overview

Generally, only the devices connected to the LAN ports of the device can access its web UI.

The remote web management function enables you to access the web UI of the device on WAN if it is required.

### Configuring Remote Web Management

#### Configuration procedure

1. Log in to the web UI of the CPE.
2. Choose **Advanced > Network Service**.
3. Enter the IP address of a device which is allowed to access the web UI of the CPE remotely, or select **All** to allow any device on WAN to access.
4. Enter a port number.
5. Click **Save** on the bottom of this page.

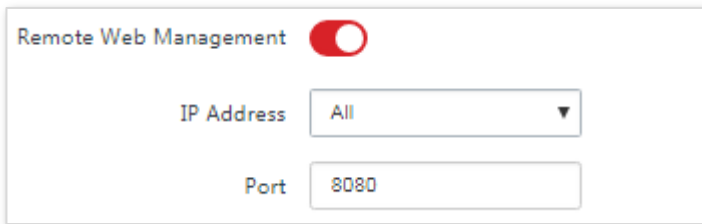

Remote Web Management

IP Address: All

Port: 8080

---End

#### Parameters Description

| Name                  | Description   |
|-----------------------|---|
| Remote Web Management | It specifies whether to enable the remote web management function.  |
| IP Address            | It specifies the IP address of a device which is allowed to access the web UI of the CPE. <ul style="list-style-type: none"><li>– <b>All</b>: It indicates that any computer in WAN can manage this device remotely. For security, it is not recommended.</li><li>– <b>Manual</b>: It indicates that only the device with specified IP address can manage this device remotely. If this device belongs to a LAN, the gateway address (a public IP address) of the device should be entered.</li></ul> |
| Port                  | It specifies the port number used for remote management of device. Default: 8080. You can change it if necessary.<br>Port s1 to 1024 have been used by well-known services. To avoid port conflict, you can set the port number to one between 1025 and 65535. Then you can access the device from WAN by   |

| Name | Description  |
|------|--|
|      | visiting an address in the form of <b>http://WAN IP address:port number</b> . If the DDNS function is enabled on the device, you can access the device by visiting an address in the form of <b>http://Domain name of WAN port:port number</b> . |

## Examples of Configuring Remote Web Management

### Networking Requirement

The CPE is used in a company to deploy its network, and it works in Router mode.

**Requirement:** The administrator needs to maintenance the network when he is on business. So he needs to access the device’s web UI on WAN.

You are recommended to use the remote web management function to solve the problem.

**Assumption:**

- The WAN IP address of the CPE is **202.105.106.55**
- The IP address of the computer which is allowed to access the device on WAN is **202.105.88.77**
- Port number is **8080**

### Configuration Procedure

1. Log in to the web UI of the CPE.
2. Choose **Advanced > Network Service**.
3. Enable the **Remote Web Management** function.
4. Set **IP Address** to **Manual**.
5. Enter the IP address of the computer which is allowed to access the CPE on WAN, which is **202.105.106.55** in this example.
6. Enter the port number, which is **8080** in this example.
7. Click **Save** in the bottom of this page.

Remote Web Management

IP Address

Enter an IP address

Port

---End

## Verification

On the computer with the IP address of **202.105.106.55**, start a browser and visit **http://202.105.106.55:8080**. Then you can log in to the web UI of the CPE and configure the settings.

### 8.6.3 Reboot Schedule

#### Overview

This function enables the CPE to automatically reboot as scheduled. You can use this function to prevent wireless performance degradation or network instability that occurs after a long CPE uptime.

#### Configuration Procedure

1. Choose **Advanced > Network Service**.
2. Enable the **Reboot Schedule** function.
3. Specify a time at which the device reboots.
4. Specify the dates on which the device reboots.
5. Click **Save** on the bottom of this page.

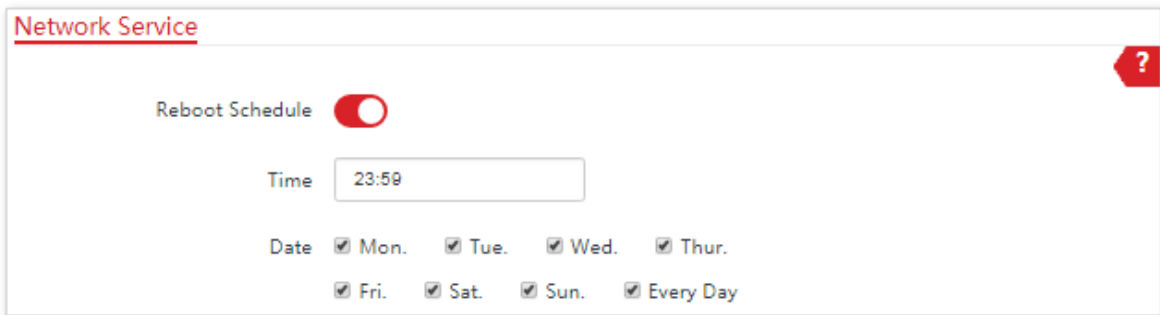

The screenshot shows the 'Network Service' configuration page. The 'Reboot Schedule' toggle is turned on. The 'Time' field is set to '23:59'. The 'Date' section has checkboxes for all days of the week (Mon., Tue., Wed., Thur., Fri., Sat., Sun.) and 'Every Day', all of which are checked. A red question mark icon is visible in the top right corner of the configuration area.

---End

### 8.6.4 Login Timeout Interval

If you log in to the web UI of the CPE and perform no operation within the login timeout interval, the CPE logs you out for network security. The default login timeout interval is 5 minutes.

Choose **Advanced > Network Service** to enter the page.



The screenshot shows the 'Login Timeout Interval' configuration field. The value '5' is entered in the input box. To the right of the input box, the text 'min Range: 1-60 minutes' is displayed.

## 8.6.5 SNMP Agent

### Overview

The Simple Network Management Protocol (SNMP) is the most widely used network management protocol in TCP/IP networks. SNMP enables you to remotely manage all your network devices compliant with this protocol, such as monitoring the network status, changing network device settings, and receive network event alarms.

SNMP allows automatic management of devices from various vendors regardless of physical differences among the devices.

### SNMP Management Framework

The SNMP management framework consists of SNMP manager, SNMP agent, and Management Information Base (MIB).

- **SNMP manager:** It is a system that controls and monitors network nodes using the SNMP protocol. The SNMP manager most widely used in network environments is Network Management System (NMS). An NMS can be a dedicated network management server, or an application that implements management functions in a network device.
- **SNMP agent:** It is a software module in a managed device. The module is used to manage data about the device and report the management data to an SNMP manager.
- **MIB:** It is a collection of managed objects. It defines a series of attributes of managed objects, including names, access permissions, and data types of objects. Each SNMP agent has its MIB. An SNMP manager can read and/or write objects in the MIB based on the permissions assigned to the SNMP manager.

An SNMP manager manages SNMP agents in an SNMP network. The SNMP manager exchanges management information with the SNMP agents using the SNMP protocol.

### Basic SNMP Operations

The CPE allows the following basic SNMP operations:

- **Get:** An SNMP manager performs this operation to query the SNMP agent of the CPE for values of one or more objects.
- **Set:** An SNMP manager performs this operation to set values of one or more objects in the MIB of the SNMP agent of the CPE.

### SNMP Protocol Version

The CPE is compatible with SNMP V1 and SNMP V2C and adopts the community authentication mechanism. Community name is used to define the relationship between an SNMP agent and an SNMP manager. If the community name contained in an SNMP packet is rejected by a device, the packet is discarded. A community name functions as a password to control SNMP agent access attempts of SNMP managers.

SNMP V2C is compatible with SNMP V1 and provides more functions than SNMP V1. Compared with SNMP V1, SNMP V2C supports more operations (GetBulk and InformRequest) and data types (such as Counter64), and provides more error codes for better distinguishing errors.

### MIB Introduction

An MIB adopts a tree structure. The nodes of the tree indicate managed objects. A path consisting of digits and starting from the root can be used to uniquely identify a node. This path is calling an object identifier (OID).The following figure shows the structure of an MIB. In the figure, the OID of A is 1.3.6.1.2.1.1, whereas the OID of B is 1.3.6.1.2.1.2.

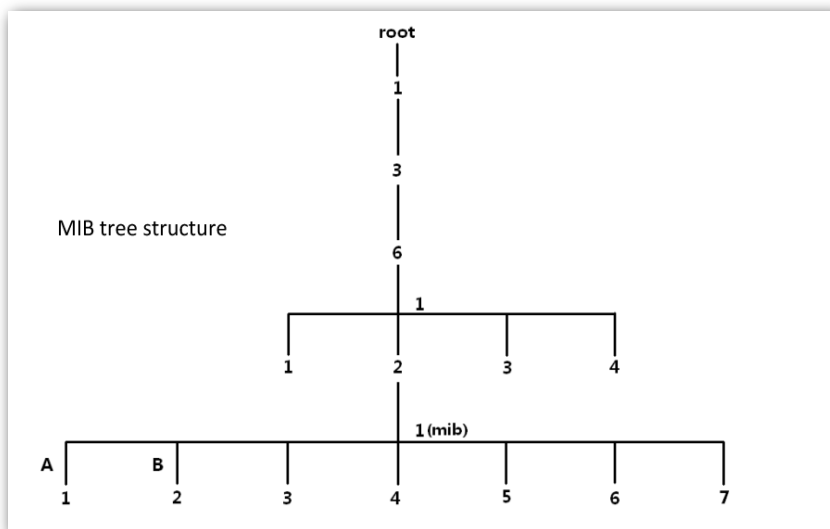

## Configuring the SNMP Function

### Configuration Procedure

1. Choose **Advanced > Network Service**.
2. Enable the **SNMP Agent** function.
3. Set the related SNMP parameters.
4. Click **Save** on the bottom of this page.

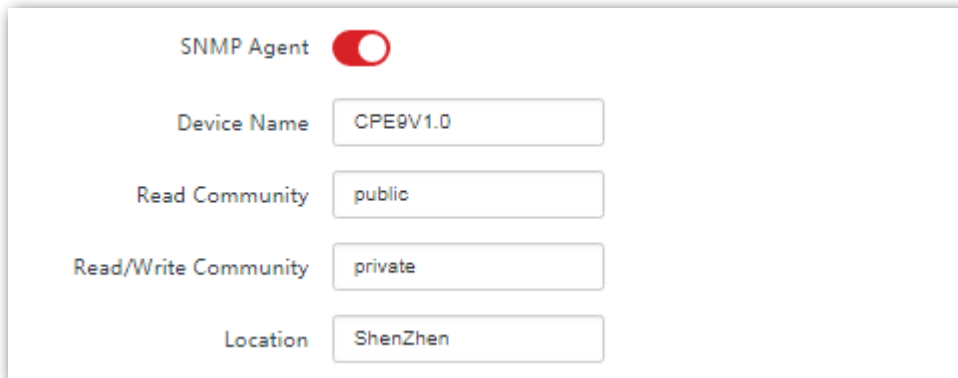

The screenshot shows a configuration panel for the SNMP Agent. At the top, there is a toggle switch labeled 'SNMP Agent' which is currently turned on (indicated by a red circle). Below this, there are five input fields: 'Device Name' with the value 'CPE0V1.0', 'Read Community' with the value 'public', 'Read/Write Community' with the value 'private', and 'Location' with the value 'ShenZhen'.

---End

### Parameters Description

| Name                 | Description  |
|----------------------|--|
| SNMP Agent           | <p>It specifies whether to enable the SNMP agent function of the AP. By default, it is disabled.</p> <p>An SNMP manager and the SNMP agent can communicate with each other only if their SNMP versions are the same. Currently, the SNMP agent function of the CPE supports SNMP V1 and SNMP V2C.</p>  |
| Device Name          | <p>It specifies the device name of the CPE. The default device name is the model and version number of the CPE. For example, the default name of this device is CPE9V2.0</p> <p> <b>Tip</b></p> <p>It is recommended that you change the CPE name so that you can easily identify the CPE when managing the CPE using SNMP.</p> |
| Read Community       | <p>It specifies the read password shared between SNMP managers and this SNMP agent. The default password is public.</p> <p>The SNMP agent function of the CPE allows an SNMP manager to use the password to read variables in the MIB of the CPE.</p>  |
| Read/Write Community | <p>It specifies the read/write password shared between SNMP managers and this SNMP agent. The default password is private.</p> <p>The SNMP agent function of the CPE allows an SNMP manager to use the password to read/write variables in the MIB of the CPE.</p>   |
| Location             | <p>It specifies the location where the AP is used. You can change the location as required.</p>  |

## Example of Configuring the SNMP Function

### Networking Requirement

- The CPE connects to an NMS over an LAN. This IP address of the CPE is 192.168.2.1/24 and the IP address of the NMS is 192.168.2.212/24.
- The NMS use SNMP V1 or SNMP V2C to monitor and manage the CPE.

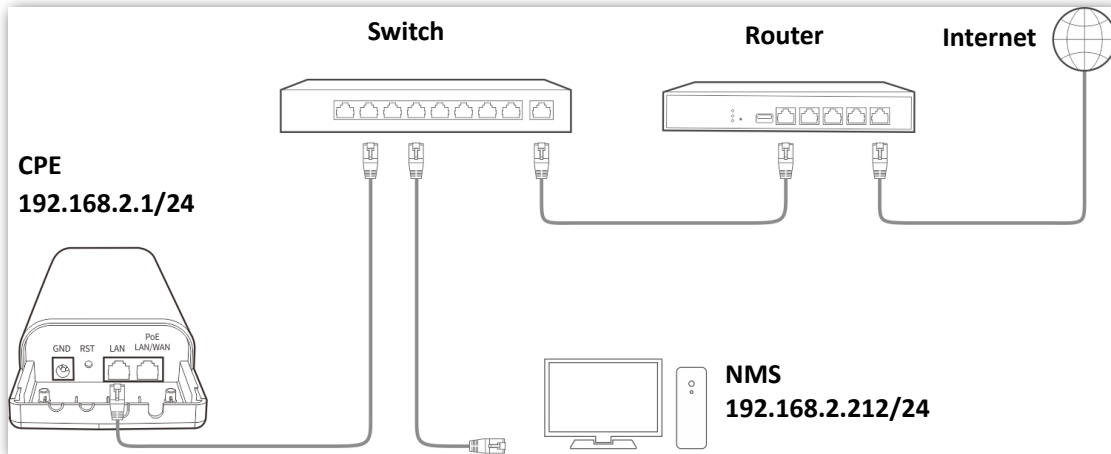

### Configuration Procedure

1. Set up the CPE.

Assume that Read Community is Jack, and Read/Write Community is Jack123.

- (1) Choose **Advanced > Network Service**.
- (2) Enable the **SNMP Agent** function.
- (3) Set the **Read Community**, which is **Jack** in this example.
- (4) Set **Read/Write Community**, which is **Jack123** in this example.
- (5) Click **Save** on the bottom of this page.

The screenshot shows the configuration page for the SNMP Agent. The SNMP Agent is enabled, indicated by a red toggle switch. The configuration fields are as follows:

|                      |                                     |
|----------------------|-------------------------------------|
| SNMP Agent           | <input checked="" type="checkbox"/> |
| Device Name          | CPE0V1.0                            |
| Read Community       | Jack                                |
| Read/Write Community | Jack123                             |
| Location             | ShenZhen                            |

2. Set up the NMS.

On an NMS that uses SNMP V1 or SNMP V2C, set the read community to **Jack** and read/write community to

**Jack123.**For details about how to configure the NMS, refer to the configuration guide for the NMS.

---End

## Verification

After the configuration, the NMS can connect to the SNMP agent of the CPE and can query and set some parameters on the SNMP agent through the MIB.

## 8.6.6 Ping Watch Dog

With this function enabled, the device periodically pings target IP address to check the network connectivity and identify whether the device malfunctions. If it malfunctions, the device will reboot automatically to ensure the network performance.

## Configuring Ping Watch Dog

### Configuration Procedure

1. Choose **Advanced > Network Service**.
2. Enable the **Ping Watch Dog** function.
3. Set the related parameters.
4. Click **Save** on the bottom of this page.

---End

### Parameters Description

| Name                      | Description  |
|---------------------------|--|
| Ping Watch Dog            | It specifies whether to enable the Ping Watch Dog function.  |
| IP Address                | It specifies the target IP address that the device pings.  |
| Ping Interval             | It specifies the interval at which the device transmits packets to ping the target IP address.   |
| Ping Startup Delay        | It specifies the interval at which the device enables the Ping Watch Dog function after the device reboots.<br>You can set this parameter to keep the device from rebooting repeatedly on account that the system triggers Ping Watch Dog during rebooting while users cannot log in to the web UI of the device to change the settings. |
| Threshold of Lost Packets | It specifies the threshold of lost packet that triggers reboot. Range: 1 to 65535, default: 3.<br>If N is set, the device will reboot automatically when it sends N Ping packets to target IP address/domain name, and does not receive response.  |

## 8.6.7 DMZ Host

This function is available only when the CPE works in WISP or Router mode.

### Overview

A DMZ host on a LAN can communicate with the internet without limit. You can set a computer that require higher internet connection throughput, such as a computer used for video conferencing or online gaming, as a DMZ host for better user experience.



- A computer set to DMZ host is not protected by the firewall of the CPE.
- A hacker may leverage the DMZ host to attack your LAN. Therefore, enable the DMZ function only when necessary.

### Configuring DMZ Host

#### Configuration Procedure

1. Choose **Advanced > Network Service**.
2. Enable the **DMZ Host** function.
3. Enter the IP address of the device to be set to DMZ host.
4. Click **Save** on the bottom of this page.

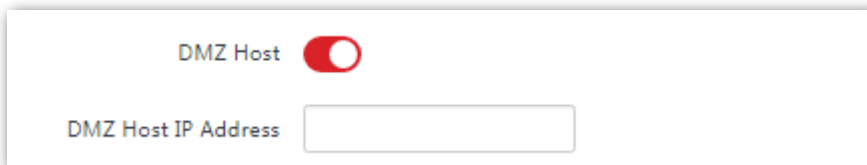

---End

### Examples of Configuring DMZ Host

#### Networking Requirement

The CPE is used in a company to deploy its network, and it is set to Router mode.

**Requirement:** The administrator on business can visit the resources on web server in LAN.

You can use DMZ Host function to solve the problem.

**Assumption:**

The WAN IP address of the CPE is **202.105.106.55**.

The information of the internal web server is shown as follows:

**IP Address:** 192.168.2.100

**Service Port of the Web Server:** 80

## Network Topology

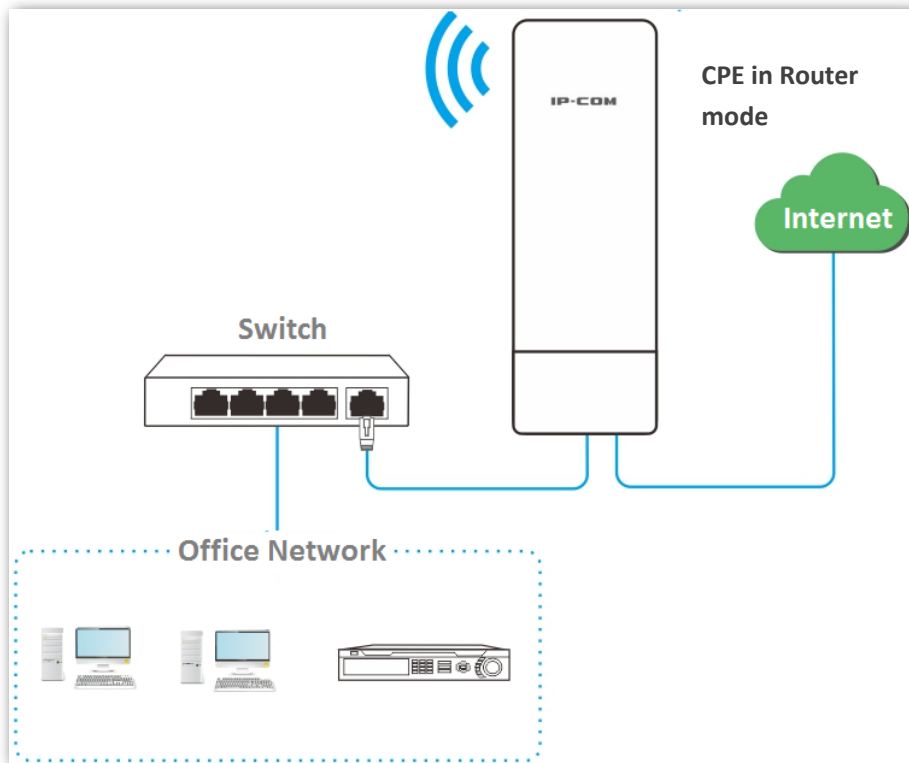

## Configuration Procedure

1. Choose **Advanced > Network Service**.
2. Enable the **DMZ Host** function.
3. Enter the IP address of the computer to be set to DMZ host, which is **192.168.2.100** in this example.
4. Click **Save** on the bottom of this page.

The screenshot shows a configuration interface for DMZ Host. At the top, 'DMZ Host' is followed by a red toggle switch that is turned on. Below this, 'DMZ Host IP Address' is followed by a text input field containing the value '192.168.2.100'.

---End

## Verification

Enter **Protocol name://WAN port IP address:port number** in the address bar of a web browser on a computer over the internet to access the resources on the web server. In this example, enter

**http://202.105.106.55:80.**

If the DDNS function is enabled, you can visit an address in the form of **Protocol name://domain name:port number.**



If internet users still cannot visit the web server in LAN after the configuration, try the following solutions:

- Ensure that the WAN IP address of the CPE is a public IP address.
- Security software, antivirus software, and the built-in OS firewall of the computer may cause the function failures. Disable them and try again.
- Manually set an IP address and related parameters for the web server to avoid the service disconnection caused by the dynamic IP address.

## 8.6.8 Telnet Service

With this function enabled, you can check the information of the CPE via Telnet.

Choose **Advanced > Network Service** to enter the page. By default, the function is disabled.

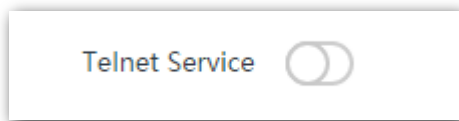

## 8.6.9 UPnP

Universal Plug and Play (UPnP) is a set of networking protocols that makes automatic port forwarding possible. It can identify devices and enable ports for certain applications, such as Thunder. To use this function, it requires that the operating system support UPnP, or application software supporting UPnP is installed.

Choose **Advanced > Network Service** to enter this page. By default, the function is enabled.



## 8.6.10 Hardware Watch Dog (Only for CPE9)

This function uses an embedded watchdog timer to detect the operation condition of the device's main program at scheduled time. During normal operation, the device regularly resets the watchdog timer to prevent it from elapsing, or "timing out". If, due to a hardware fault or program error, the device fails to reset the watchdog timer, the timer will elapse and generate a timeout signal. The timeout signal is used to reboot the device to make it recover from malfunctions.

Choose **Advanced > Network Service** to enter the page. By default, the function is enabled.



# 9 Tools

## 9.1 Date & Time

This module enables you to set the system time of the CPE.

Ensure that the system time of the CPE is correct, so that logs can be recorded correctly and the reboot schedule can be executed correctly.

Choose **Tools > Date & Time** to enter the page.

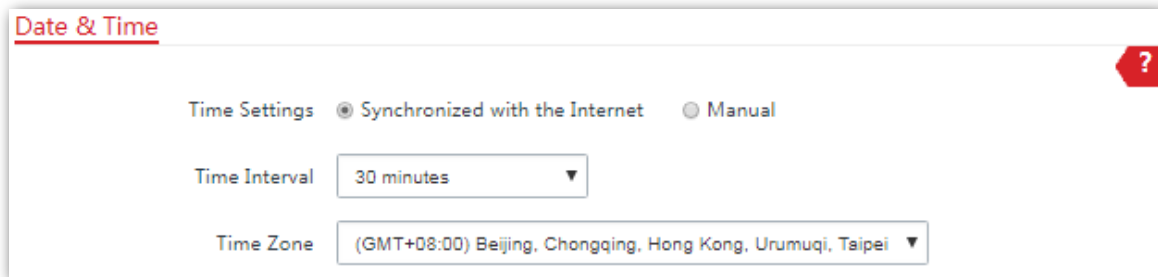

The CPE allows you to set the system time by synchronizing the time with the internet or manually setting the time. By default, it is configured to synchronize the system time with the internet.

### 9.1.1 Synchronized with the Internet

The CPE automatically synchronizes its system time with a time server of the internet. This enables the CPE to automatically correct its system time after being connected to the internet.

For details about how to connect the CPE to the internet, refer to [LAN Setup](#).

### Configuration Procedure

1. Choose **Tools > Date & Time**.
2. Set **Time settings** to **Synchronized with the Internet**.
3. Specify a time interval. The default value **30 minutes** is recommended.
4. Set **Time Zone** to your time zone.
5. Click **Save**.

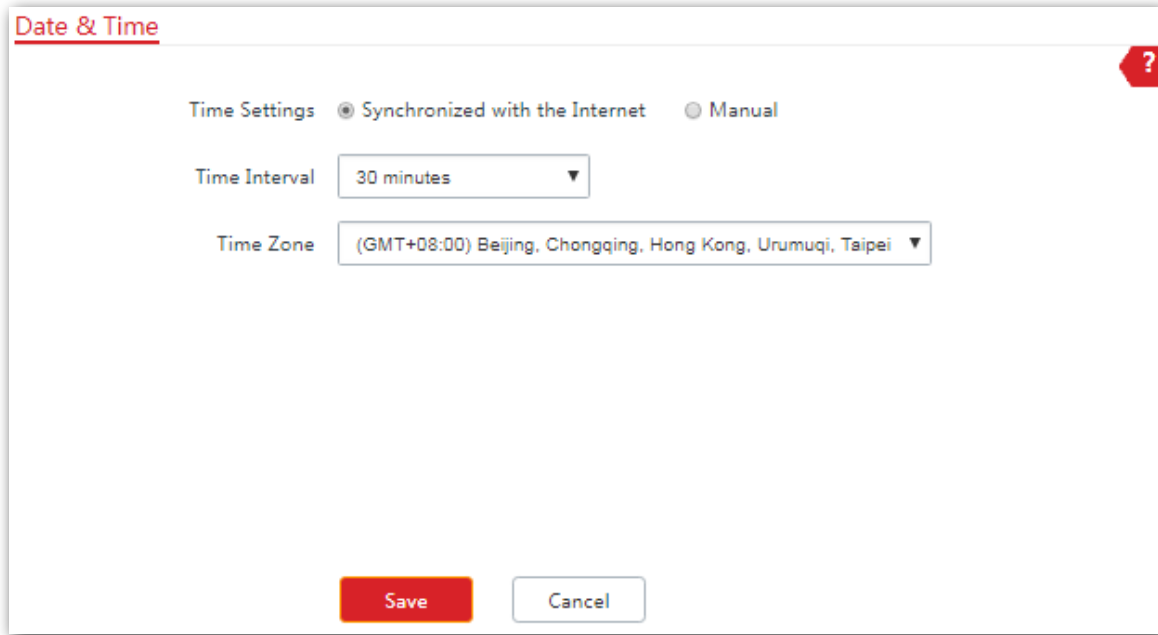

**Date & Time**

Time Settings  Synchronized with the Internet  Manual

Time Interval 30 minutes ▼

Time Zone (GMT+08:00) Beijing, Chongqing, Hong Kong, Urumuqi, Taipei ▼

Save Cancel

---End

## 9.1.2 Manual

You can manually set the system time of the CPE. If you choose this option, you need to set the system time each time after the CPE reboots.

### Configuration Procedure

1. Choose **Tools > Date & Time**.
2. Set the **Time Settings** to **Manual**.
3. Enter a correct date and time, or click **Synchronize with PC Time** to synchronize the system time of the CPE with the system time (ensure that it is correct) of the computer being used to manage the CPE.
4. Click **Save**.

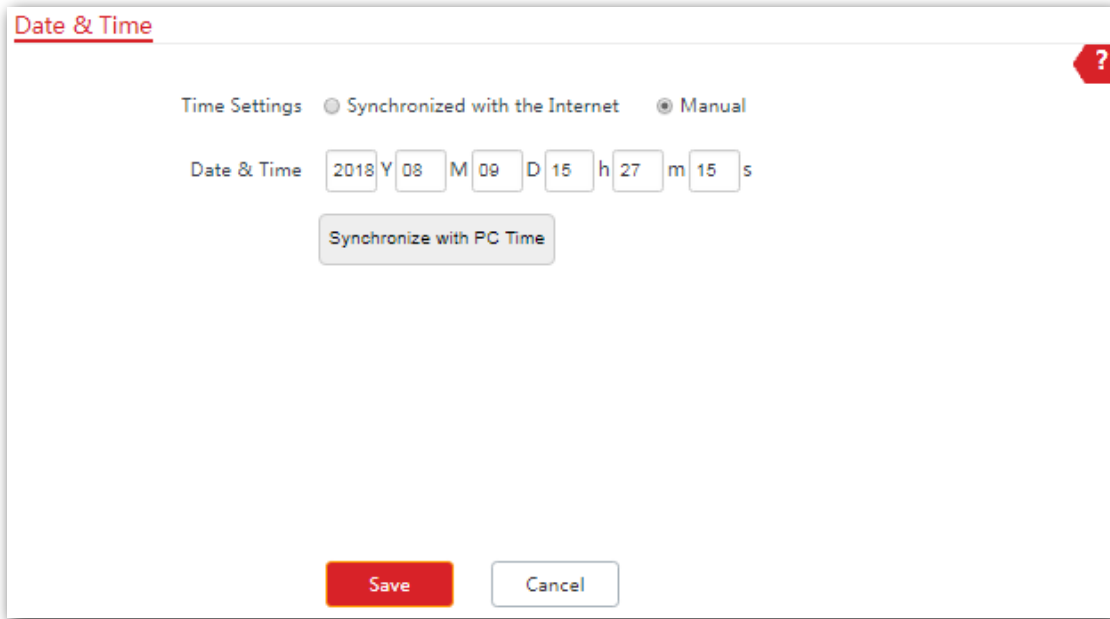

---End

## 9.2 Maintenance

### 9.2.1 Reboot Device

If a setting does not take effect or the CPE works improperly, you can try rebooting the CPE to resolve the problem.



Tip

When the CPE reboots, the current connections disconnect. Perform this operation when the CPE does not work busy.

---

### Configuration Procedure

1. Choose **Tools > Maintenance**.
2. Click **Reboot**.

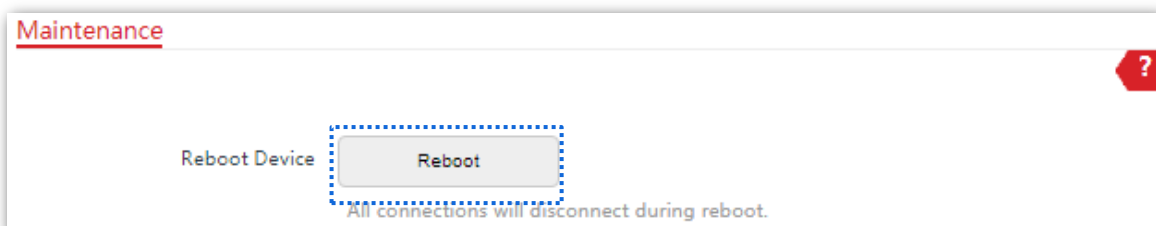

3. Click **OK** on the pop-up window.

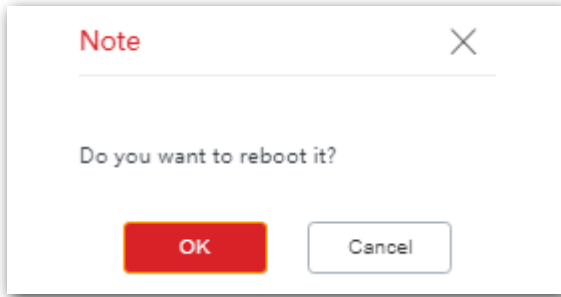

---End

A progress bar is displayed on the page. Wait for it to elapse.

## 9.2.2 Reset to Factory Settings

If you cannot locate a fault of the CPE or forget the login password of the web UI of the CPE, you can reset the CPE to restore its factory settings and then configure it again.



- When the factory settings are restored, the configuration of the CPE is lost. Therefore, you need to reconfigure the CPE to connect to the internet. Restore the factory settings of the CPE only when necessary.
  - To prevent CPE damages, ensure that the power supply of the CPE is normal when the CPE is reset.
  - When the factory settings are restored, the login IP address is 192.168.2.1, and both login user name and password are **admin**.
- 

### Configuration Procedure

1. Choose **Tools > Maintenance**.
2. Click **Reset**.

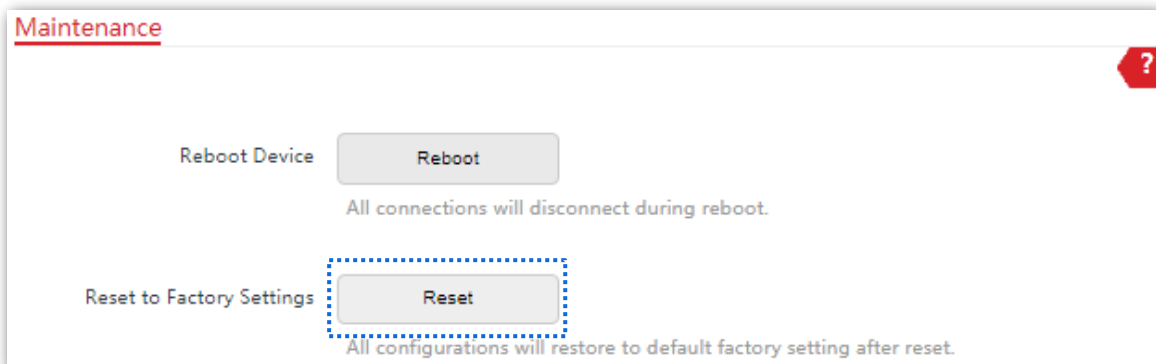

3. Click **OK** on the pop-up window.

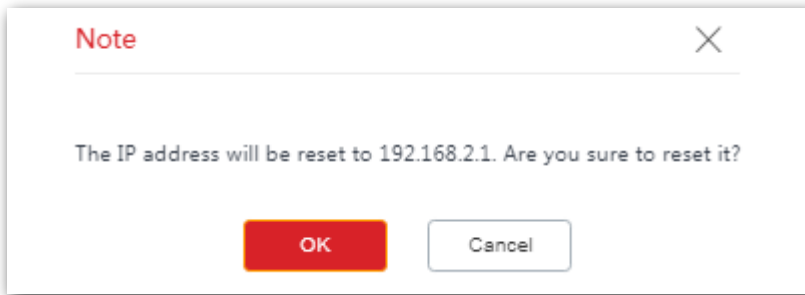

---End

A progress bar is displayed on the page. Wait for it to elapse.

## 9.2.3 Upgrade Firmware

This function upgrades the firmware of the CPE for more functions and higher stability.



To prevent damaging the CPE, verify that the new firmware version is applicable to the CPE before upgrading the firmware and keep the power supply of the CPE connected during an upgrade.

### Configuration Procedure

1. Download the package of a later firmware version for the CPE from <http://www.ip-com.com.cn> to your local computer, and decompress the package.
2. Log in to the web UI of the CPE and choose **Tools > Maintenance**.  
Click **Upgrade**.

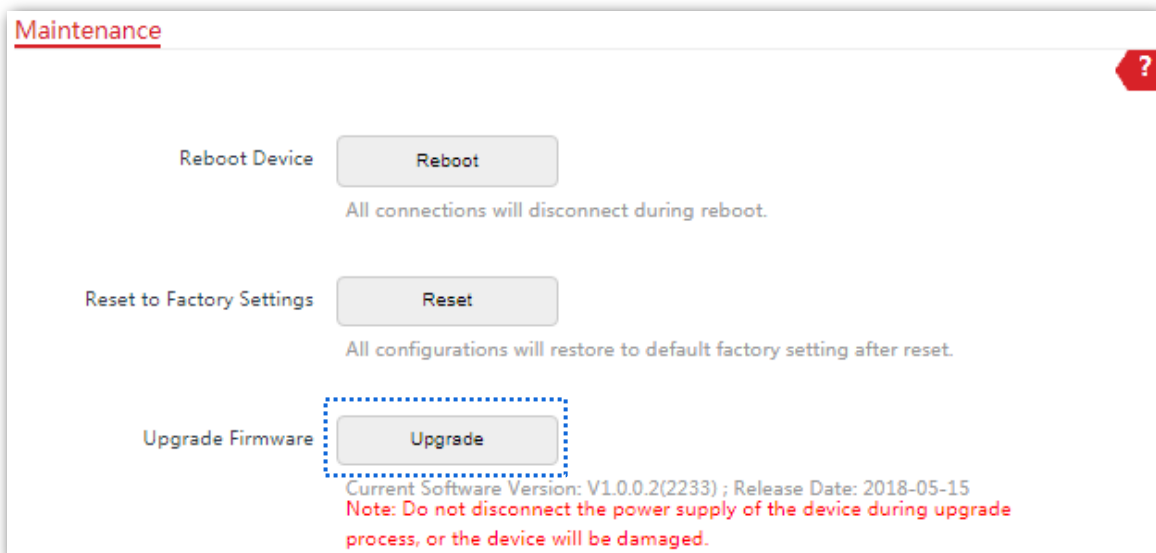

3. Select the file from your local computer for upgrading the firmware.

---End

A progress bar is displayed on the page. Wait for it to elapse. Then Log in to the web UI of the CPE, and check the **Firmware Version** on the **Status** page, and ensure that the version displayed here is the same as the firmware you upgrade.



After the firmware is upgraded, you are recommended to restore the factory settings of the CPE and configure the CPE again, so as to ensure stability of the CPE and proper operation of new functions.

---

## 9.2.4 Backup/Restore

The backup function enables you to back up the current configuration of the CPE to a local computer. The restoration function enables you to restore the CPE to a previous configuration.

If the CPE enters the optimum condition after you greatly change the configuration of the CPE, you are recommended to back up the new configuration, so that you can restore it after upgrading or resetting the CPE.



If you need to apply same or similar configurations to many CPEs, you can configure one of the CPEs, back up the configuration of the CPE, and use the backup to restore the configuration on the other CPEs. This improves configuration efficiency.

---

### Backup

#### Configuration Procedure

1. Choose **Tools > Maintenance**.

2. Click **Backup/Restore**.

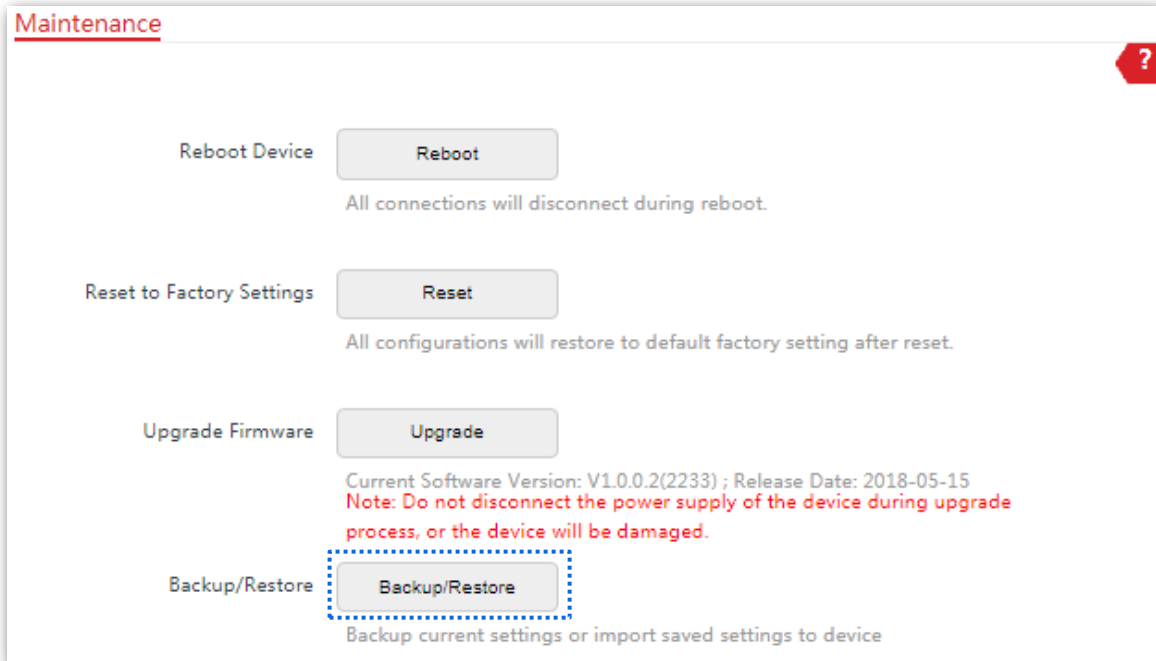

3. Then click **Backup** on the pop-up window.



---End

A file named **APCfm.cfg** is downloaded to your local computer.

## Restore

### Configuration Procedure

1. Choose **Tools > Maintenance**.

2. Click **Backup/Restore**.

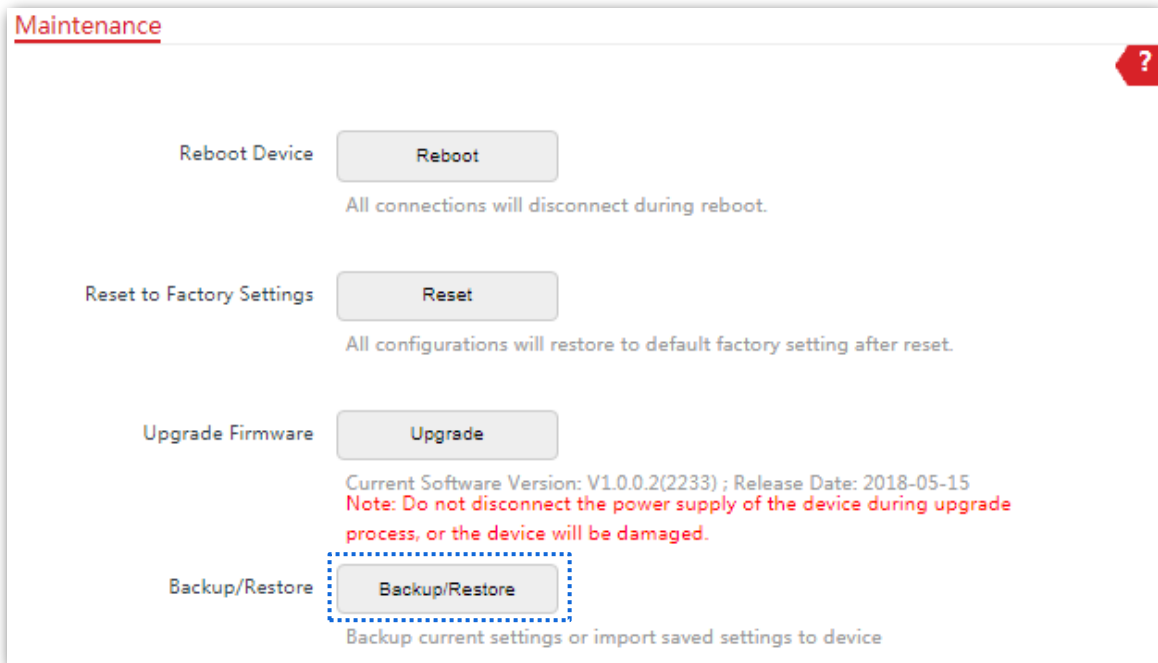

3. Click **Restore** on the pop-up window.

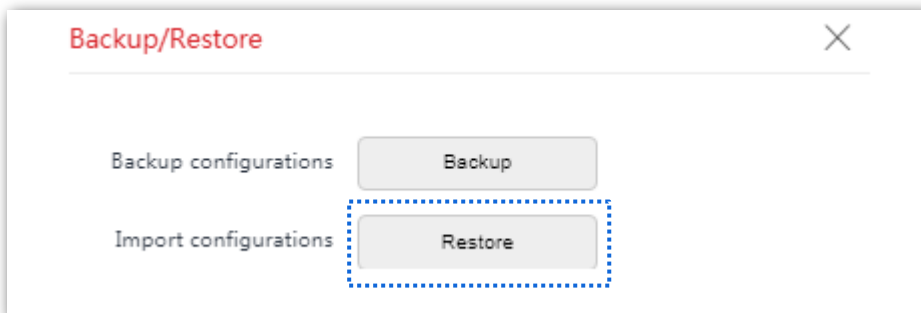

4. Select and upload the file you back up before.

---End

The file is being uploaded.

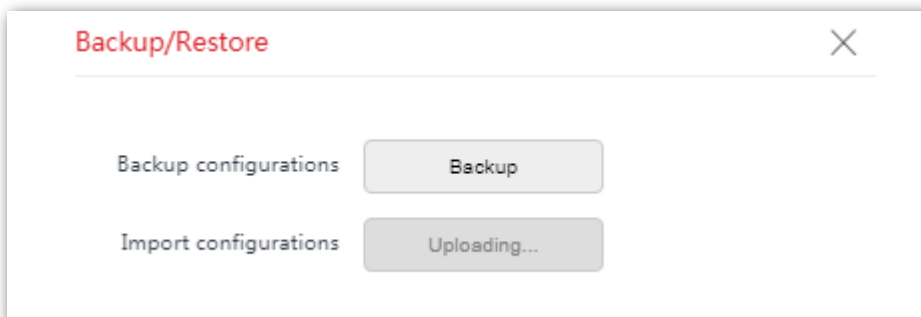

A progress bar is displayed on the page. Wait for it to elapse. Then the CPE is restored the settings successfully.

## 9.3 Account

To access the page, choose **Tools > Account**.

On this page, you can change the login account information of the CPE to prevent unauthorized login.

Click  to change the account information.

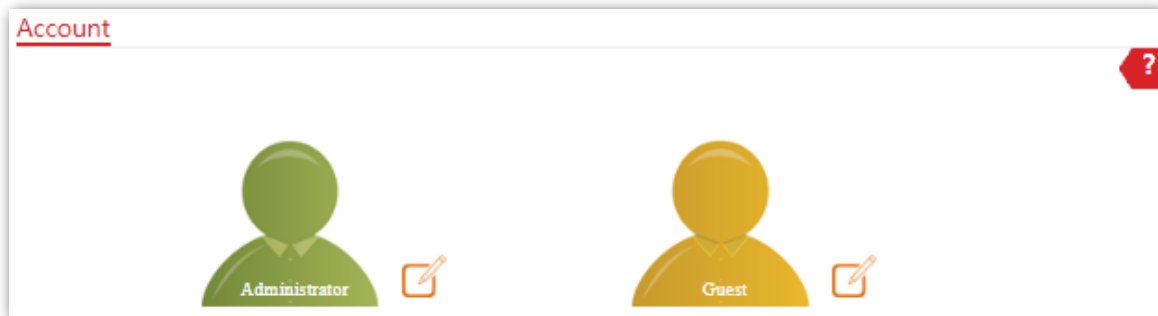

### 9.3.1 Administrator

You can modify and view the settings with the administrator account.

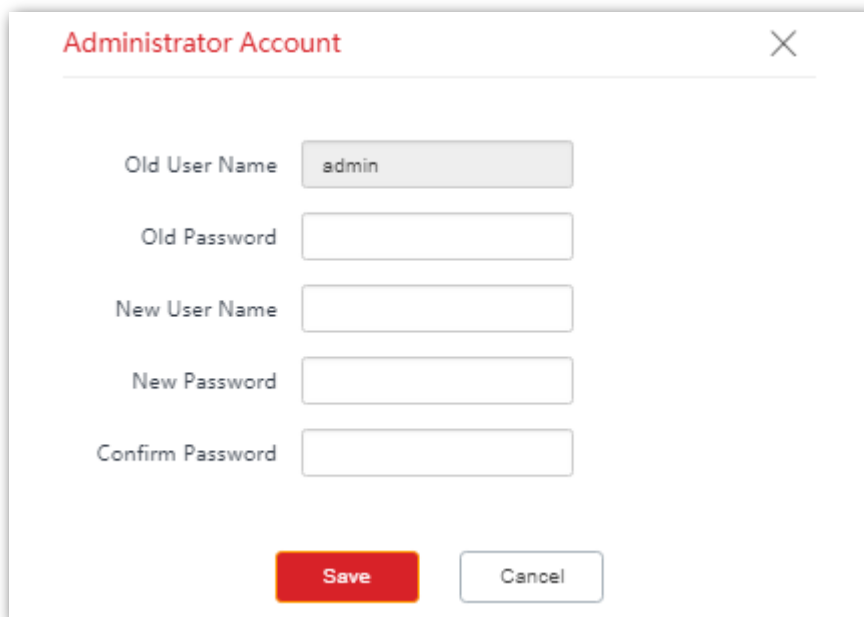
A screenshot of the 'Administrator Account' settings form. The form has a title bar with 'Administrator Account' and a close button. The fields are: 'Old User Name' (value: admin), 'Old Password', 'New User Name', 'New Password', and 'Confirm Password'. At the bottom are 'Save' and 'Cancel' buttons.

## 9.3.2 Guest

This account only allows you to view the settings. By default, this account is disabled.

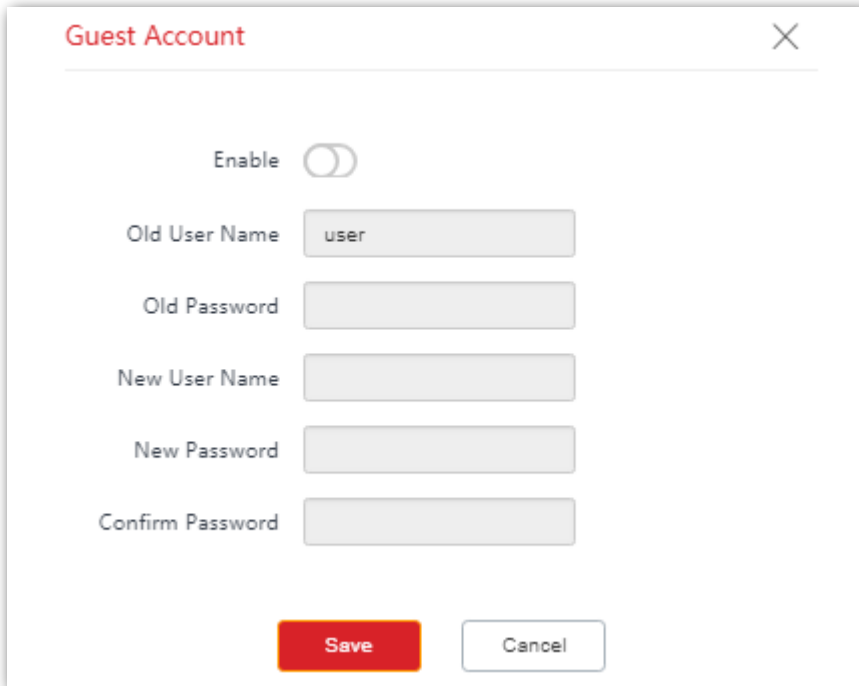

The screenshot shows a dialog box titled "Guest Account" with a close button (X) in the top right corner. The dialog contains the following elements:

- An "Enable" toggle switch, currently in the "off" position.
- An "Old User Name" text input field containing the text "user".
- An "Old Password" text input field.
- A "New User Name" text input field.
- A "New Password" text input field.
- A "Confirm Password" text input field.
- At the bottom, there are two buttons: a red "Save" button and a white "Cancel" button.

### Parameters Description

| Name             | Description  |
|------------------|--|
| Old User Name    | It specifies the user name of the current login account.<br>By default, the CPE has one administrator account and one guest account.<br>Administrator user name/password: admin/admin (all lowercase)<br>Guest user name/password: user/user (all lowercase) |
| Old Password     | It specifies the current login user name.  |
| New User Name    | Specify a new login user name.   |
| New Password     | Specify a new login password.  |
| Confirm Password | Enter the new login password again.  |

## 9.4 System Log

To access the page, choose **Tools > System Log**.

The logs of the CPE record various events that occur and the operations that users perform after the CPE starts. In case of a system fault, you can refer to the logs during troubleshooting.

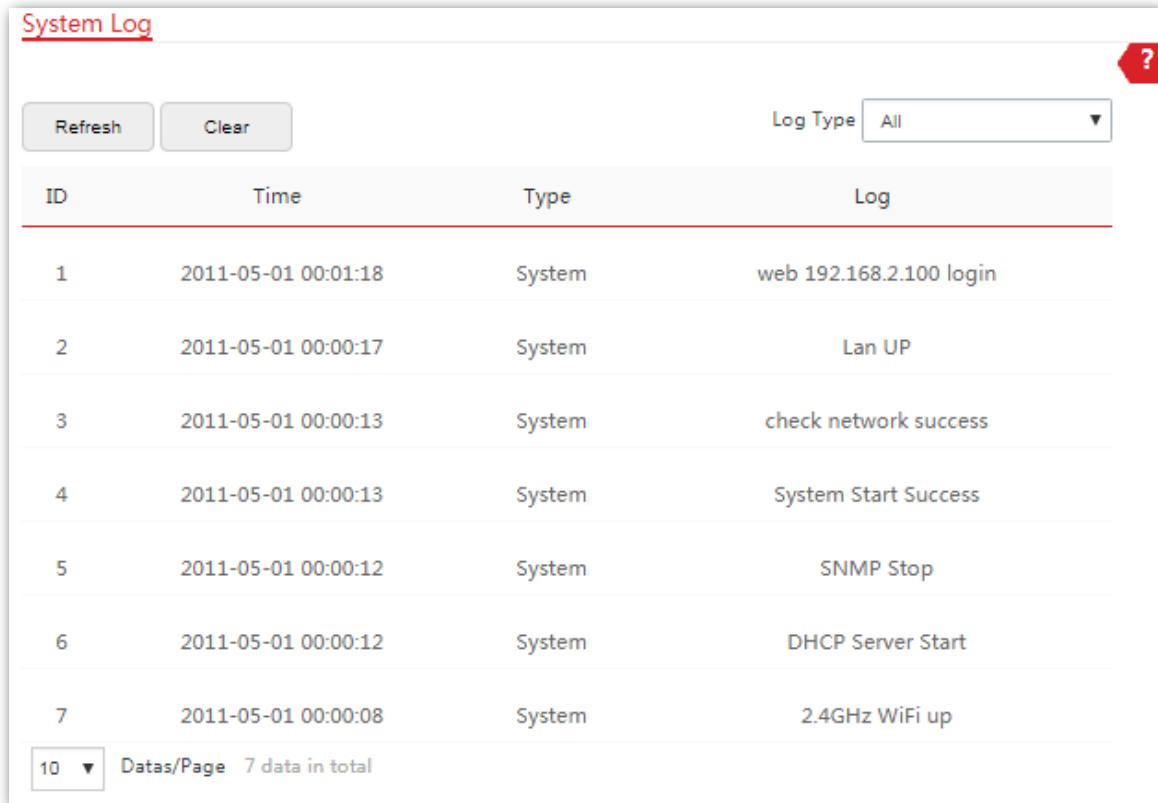

| ID | Time                | Type   | Log                     |
|----|---------------------|--------|-------------------------|
| 1  | 2011-05-01 00:01:18 | System | web 192.168.2.100 login |
| 2  | 2011-05-01 00:00:17 | System | Lan UP                  |
| 3  | 2011-05-01 00:00:13 | System | check network success   |
| 4  | 2011-05-01 00:00:13 | System | System Start Success    |
| 5  | 2011-05-01 00:00:12 | System | SNMP Stop               |
| 6  | 2011-05-01 00:00:12 | System | DHCP Server Start       |
| 7  | 2011-05-01 00:00:08 | System | 2.4GHz WiFi up          |

To ensure that the logs are recorded correctly, verify the system time of the CPE. You can correct the system time of the CPE by choosing **Tools > Date & Time**.

To view the latest logs of the CPE, click **Refresh**. To clear the existing logs of the CPE, click **Clear**.

### Note

- When the CPE reboots, the previous logs are lost.
- The CPE reboots when the CPE is powered on after a power failure, the VLAN function is configured, the firmware is upgraded, a CPE configuration is backed up or restored or the factory settings are restored.

# Appendix

## A.1 FAQ

**Q1: I cannot log in to the web UI of the device by entering 192.168.2.1. What should I do?**

**A1:** Try the following methods and try again:

- Ensure that the device has been connected to the power supply and the computer properly.
- Ensure that the IP address of the login computer is 192.168.2.X (X ranges from 2 to 254).
- Reset the device to factory settings.

**Q2: How to reset the device to factory settings?**

**A2: Note: Resetting the device will clear all settings, and you need to configure it again.**

**Method One:** 1 minute after the device is powered on, uncover the device, and hold down the reset button for about 8 seconds.



**Method Two:** Log in to the web UI of the device, choose **Tools > Maintenance**, and click the **Reset** button.

**Q3: How to judge whether the bridging signal is optimal when the devices are used for CCTV surveillance?**

**A3:**

**Method One:** Observe the LED indicators of the two devices. The bridging signal is optimum when the LED1, LED2 and LED3 indicators are solid on or flashing.

**Method Two:** Log in to the web UI of one device (default login address: 192.168.2.1), choose **Status**, and check the wireless status on the following page:

| Wireless Status        |        |                        |  |
|------------------------|--------|------------------------|--|
| Working Mode           | Client | AP's MAC Address       | 50:2B:73:FE:F5:79  |
| SSID                   | N/A    | Signal Strength        |  -32dBm |
| Security Mode          | N/A    | Background Noise       |  -95dBm |
| Channel/Radio Band     | 1/2412 | TX/RX Link             | 1X1  |
| No. of Wireless Client | N/A    | Transmit/Receive Speed | 72Mbps/26Mbps  |

Stronger signal strength (-90 is better than -100) and less background noise (-100 is better than -90) indicates better bridging signal.

**Q4: After the installation succeeds, the monitors connected to the NVR cannot display the surveillance videos. What should I do?**

**A4:** Try the following solutions:

- Ensure that all devices are working normally, and connected properly.
- Refer to the following figure to find the problem. Ensure that the IP addresses of computer, NVR, and IP cameras are in the same network segment.

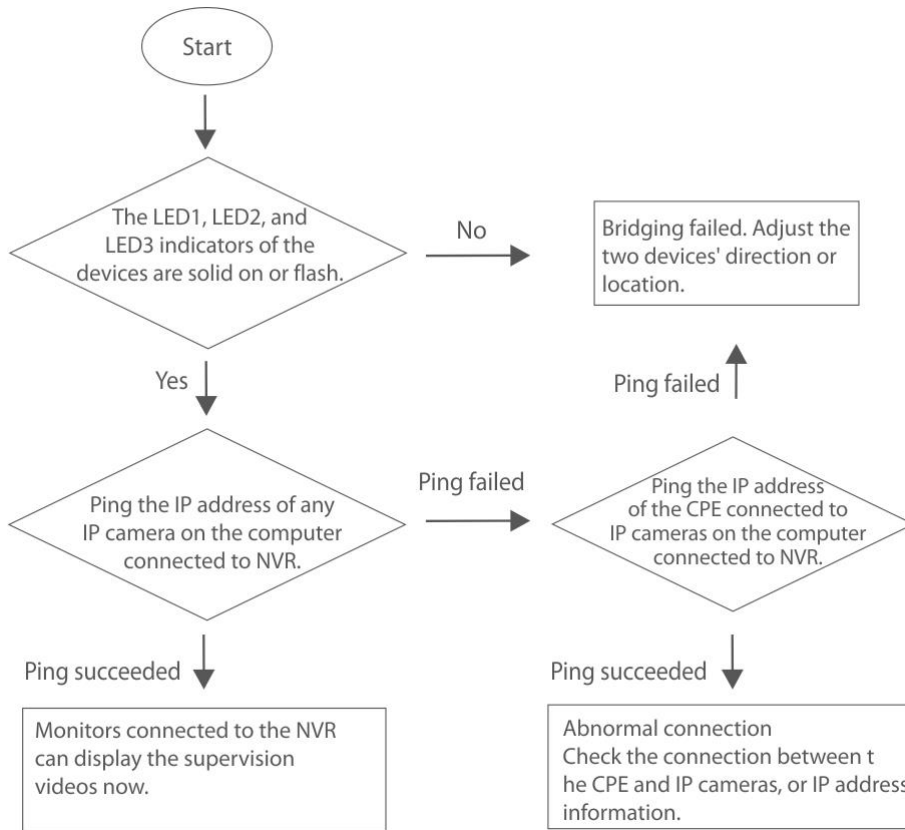

- If the preceding check is normal, it indicates the connections are properly. Please check the configuration information, including the configuration information of NVR, and IP cameras.

## A.2 Default Parameters

By default, the parameters are shown in the following table:

| Parameters     | CPE3                 | CPE9   |             |
|----------------|----------------------|--|-------------|
| Login          | Login IP Address     | 192.168.2.1  |             |
|                | Account              | Administrator  | admin/admin |
|                |                      | Guest  | Disabled    |
| Quick Setup    | Working Mode         | AP mode  |             |
|                | IP Address Type      | Static IP address  |             |
| LAN Setup      | IP Address           | 192.168.2.1  |             |
|                | Subnet Mask          | 255.255.255.0  |             |
|                | Default Gateway      | 192.168.2.254  |             |
|                | Primary DNS Server   | 8.8.8.8  |             |
|                | Secondary DNS Server | 8.8.4.4  |             |
|                | Device Name          | CPE3V1.0   | CPE9V2.0    |
|                | DHCP Server          | Enable   |             |
| DHCP Server    | Start IP Address     | 192.168.2.100  |             |
|                | End IP Address       | 192.168.2.200  |             |
|                | Subnet Mask          | 255.255.255.0  |             |
|                | Gateway Address      | 192.168.2.254  |             |
|                | Primary DNS Server   | 8.8.8.8  |             |
|                | Secondary DNS Server | 8.8.4.4  |             |
|                | Lease Time           | 1 day  |             |
| VLAN Settings  | VLAN Settings        | Disable  |             |
|                | PVID                 | /  | 1           |
|                | Management VLAN      | 1  | 1           |
|                | WLAN                 | 1000   | 1000        |
|                | LAN                  | /  | 1           |
| Wireless-Basic | Wireless Network     | Enable   |             |
|                | Country/Region       | China  |             |
|                | SSID                 | IP-COM_XXXXXX, and XXXXXX is the last six characters of the LAN MAC address of the CPE |             |
|                | Broadcast SSID       | Enable   |             |
|                | Network Mode         | 11b/g/n  |             |
|                | Channel              | Auto   |             |

| Parameters               | CPE3             | CPE9              |
|--------------------------|------------------|-------------------|
| Transmit Power           | 20 dBm           | 29 dBm            |
| Channel Bandwidth        | 20 MHz           | Auto              |
| Extension Channel        | /                | Auto              |
| Transmit Rate            | Auto             | Auto              |
| Security Mode            | None             |                   |
| Isolate Client           | Disable          |                   |
| Max. Number of Clients   | 16               | 48                |
| WMM                      | Enable           |                   |
| APSD                     | Disable          |                   |
| Minimum RSSI Threshold   | Disable          |                   |
| Preamble                 | Long Preamble    |                   |
| Signal Transmission      | /                | Coverage-oriented |
| Signal Reception Level   | Level 4          | Auto              |
| Transmission Distance    | /                | 3 km              |
| Beacon Interval          | 100ms            |                   |
| Fragment Threshold       | 2346             |                   |
| RTS Threshold            | 2347             |                   |
| DTIM Interval            | 1                | 1                 |
| Signal LED1 Threshold    | -90 dBm          | -90 dBm           |
| Signal LED2 Threshold    | -80 dBm          | -80 dBm           |
| Signal LED3 Threshold    | -70 dBm          | -70 dBm           |
| Wireless –Access Control | Disable          |                   |
| PoE/LAN Speed            | /                | Auto Negotiation  |
| LAN Speed                | Auto Negotiation |                   |
| Diagnose                 | Disable          |                   |
| Reboot Schedule          | Disable          |                   |
| Login Timeout Interval   | 5 min            |                   |
| SNMP Agent               | Disable          |                   |
| Ping Watch Dog           | Disable          |                   |
| Telnet Service           | Disable          |                   |
| UPnP                     | Enable           |                   |
| Hardware Watch Dog       | /                | Enable            |

| Parameters |             | CPE3   | CPE9 |
|------------|-------------|--|------|
| Tools      | Date & Time | Synchronized with the Internet<br>(GTM+8:00) Beijing, Chongqing, Hong Kong, Urumqi,<br>Taipei<br>Time Interval: 30 minutes |      |

---