



Questo manuale d'istruzione è fornito da trovaprezzi.it. Scopri tutte le offerte per [Lego Creator 31109 Galeone dei pirati](#) o cerca il tuo prodotto tra le [migliori offerte di Lego](#)



Questo manuale d'istruzione è fornito da trovaprezzi.it. Scopri tutte le offerte per [Lego Creator 31109 Galeone dei pirati](#) o cerca il tuo prodotto tra le [migliori offerte di Lego](#)



# CREATOR™

31109

3 IN 1



3 in 1  
3 en 1  
3 em 1  
3 az 1-ben  
Trīs viena  
3 合 1

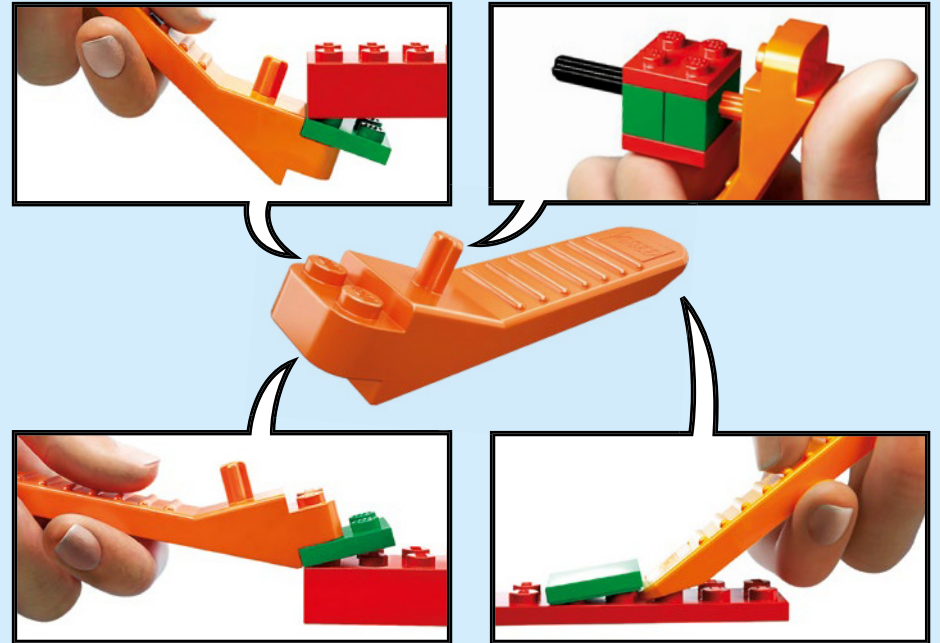

[LEGO.com/brickseparator](https://LEGO.com/brickseparator)

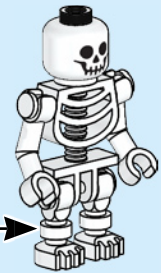
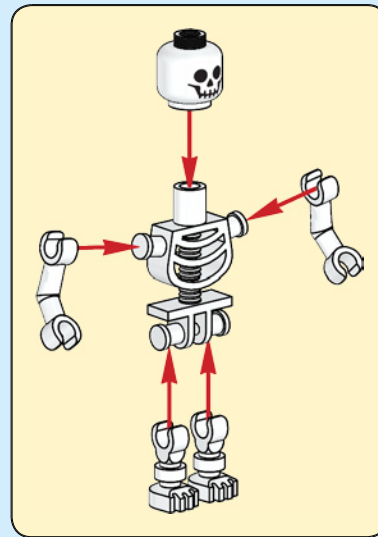
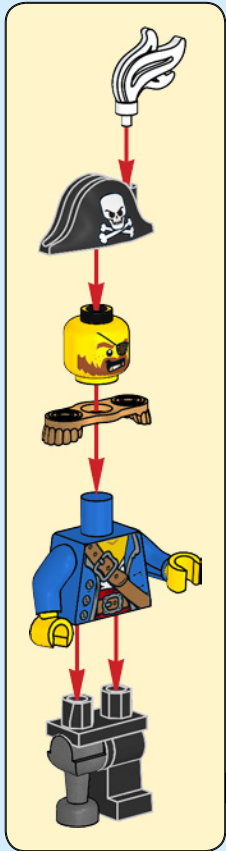
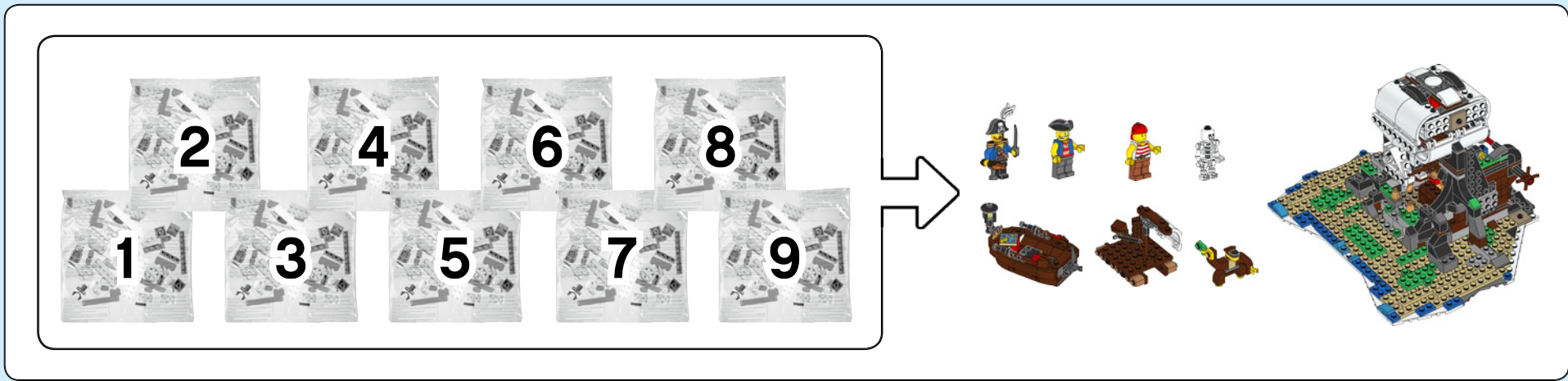

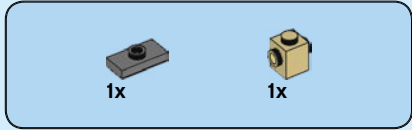

1

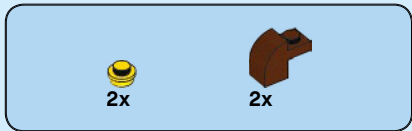
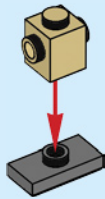

2

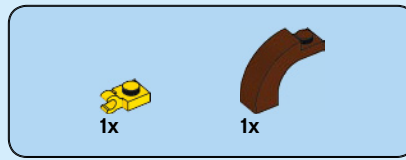
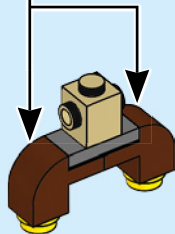
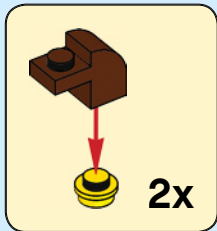

3

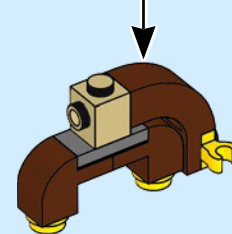
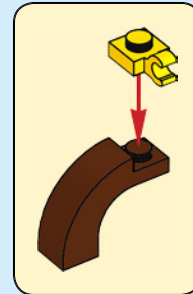

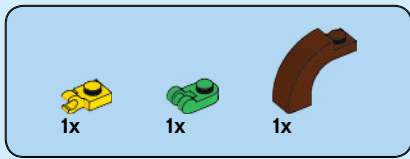

4

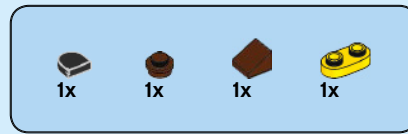
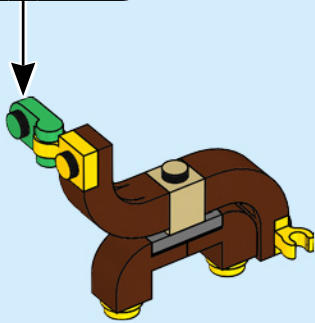
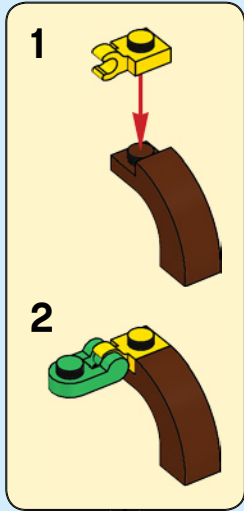

5

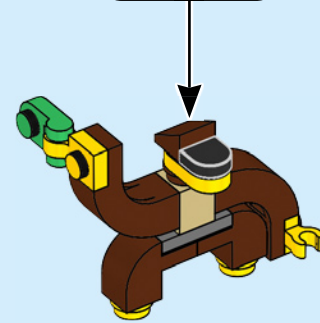

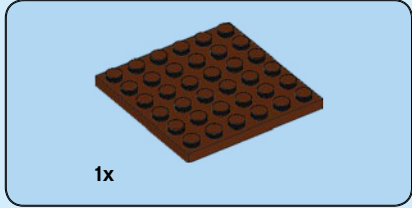
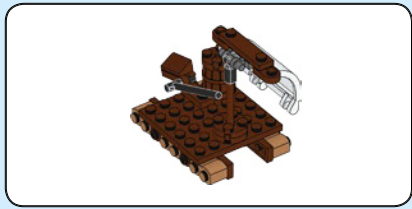

1

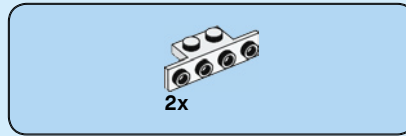

2

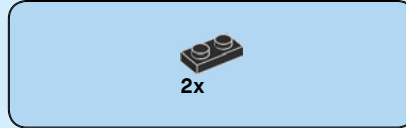
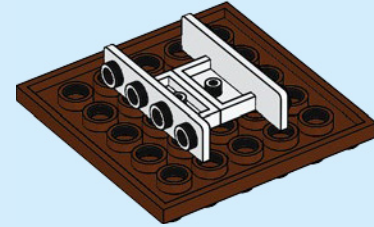

3

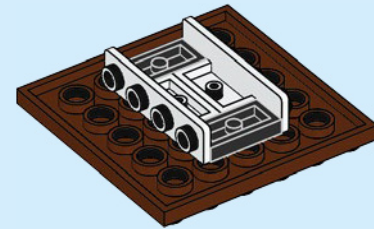

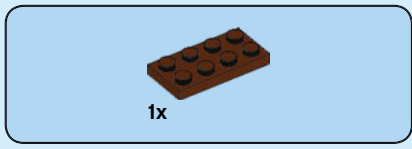

4

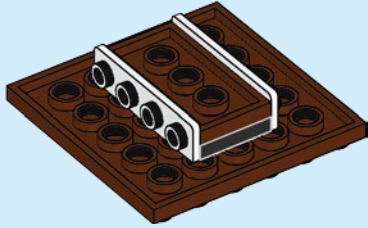

5

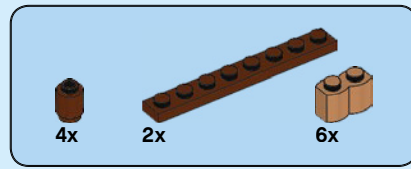
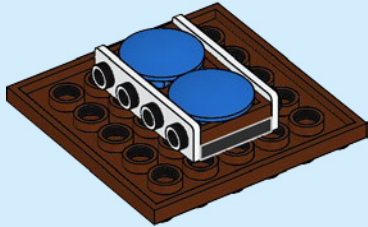

6

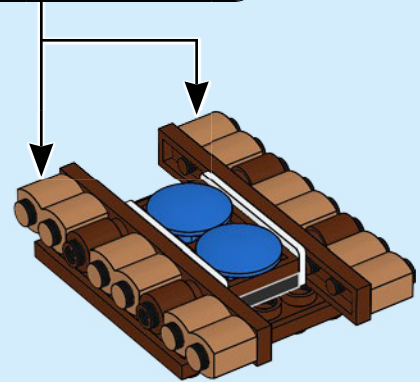
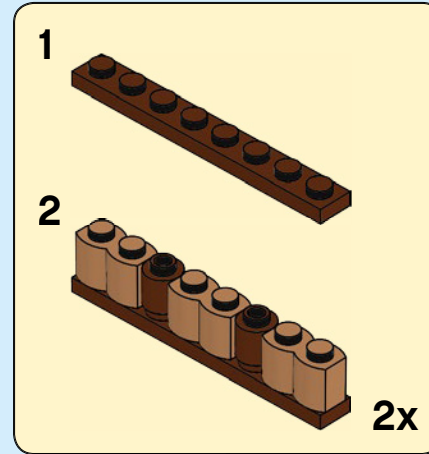

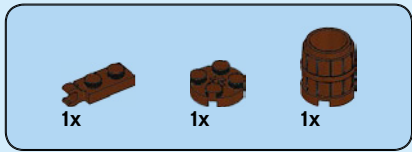

7

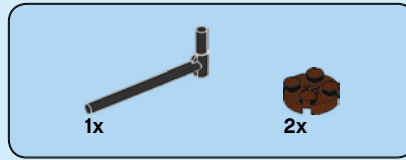
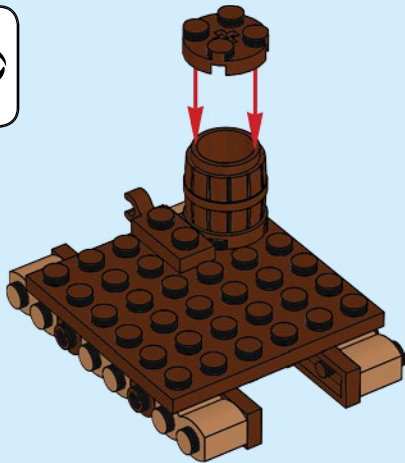

8

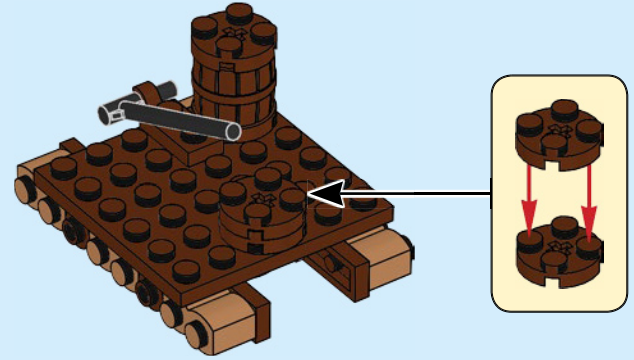

9

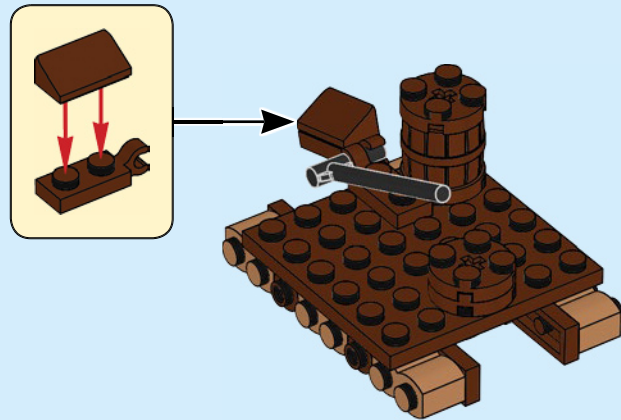

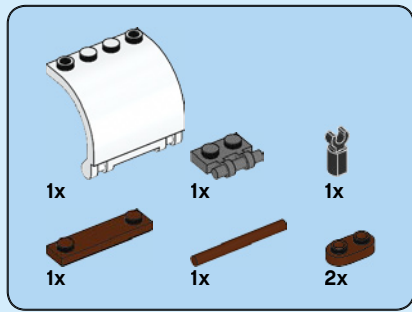

10

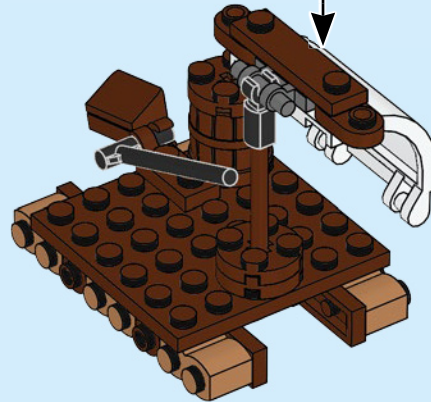
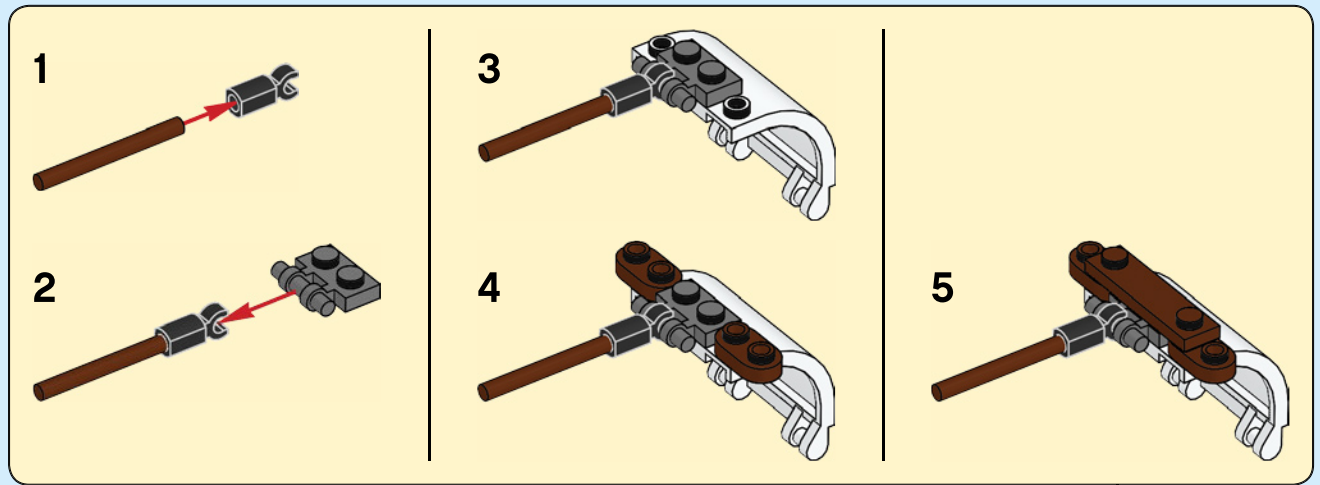

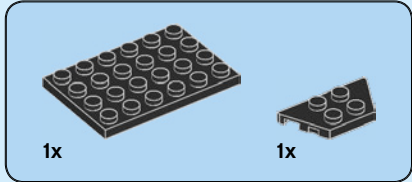
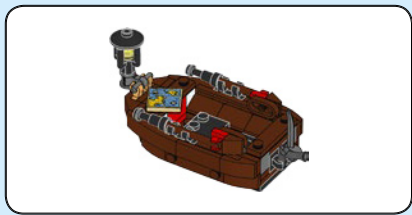

1

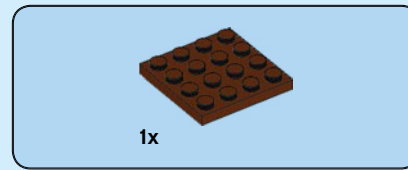
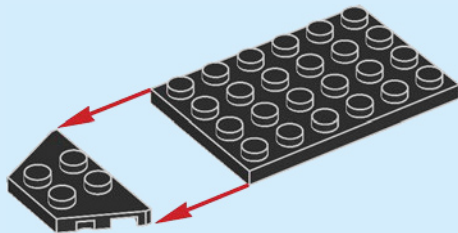

2

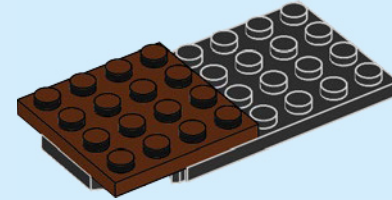

3

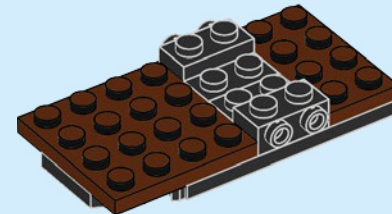



4

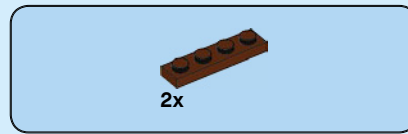
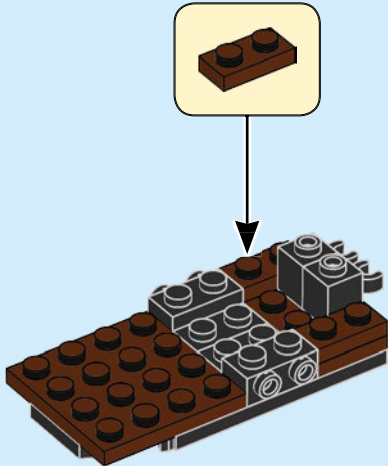

5

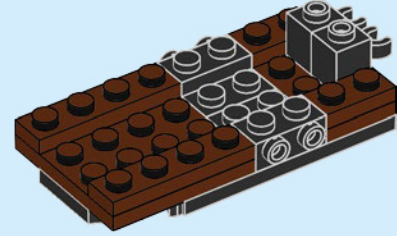

6

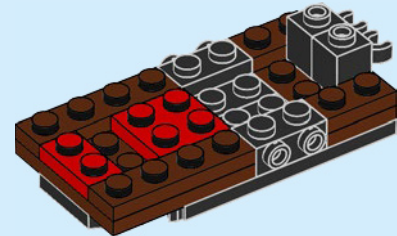



7

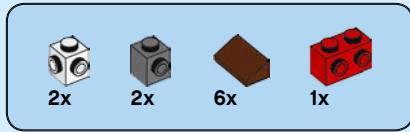
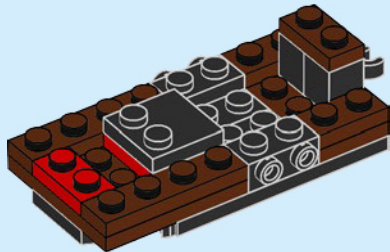

8

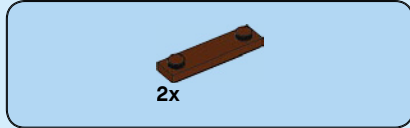
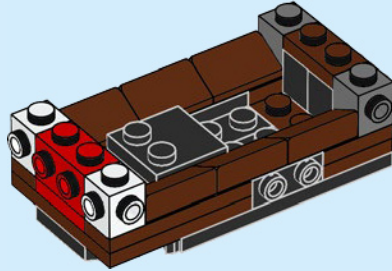

9

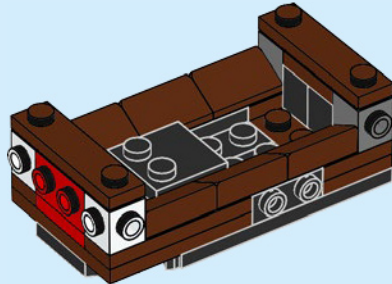

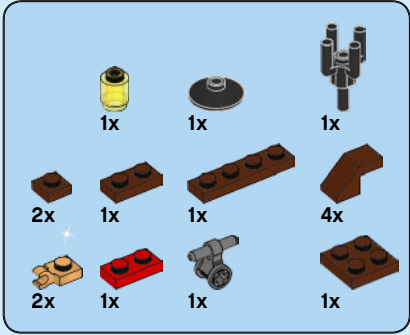

# 10

1



2



3

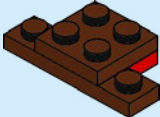

4

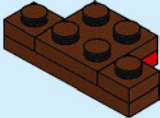

5

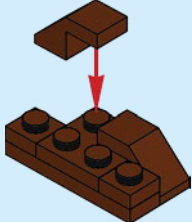

6

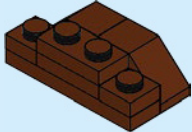

7

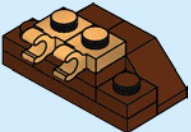

8

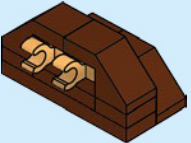

9

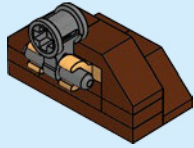

10

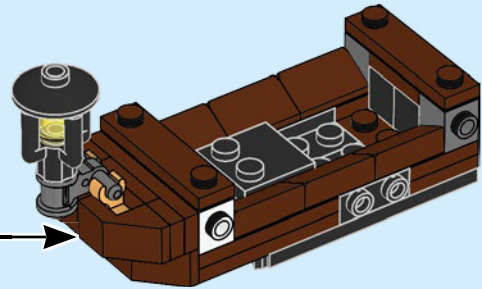
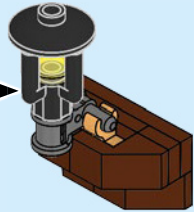
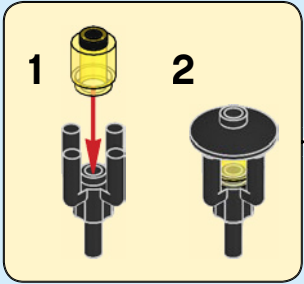

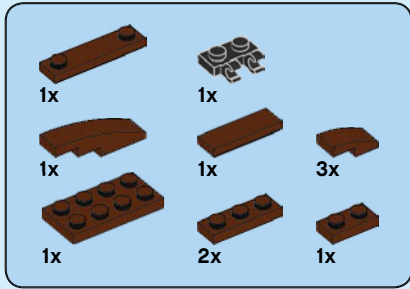

11

1

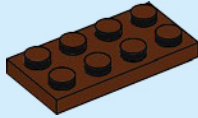

2

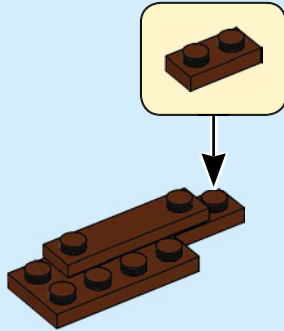

3

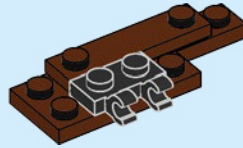

4

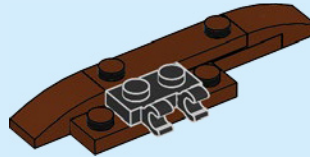

5

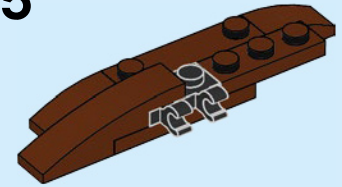

6

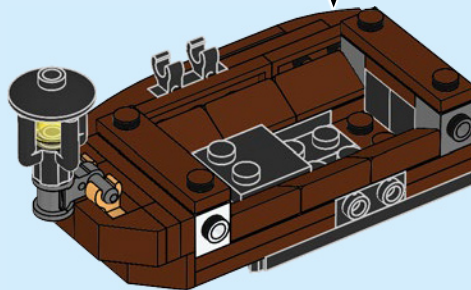
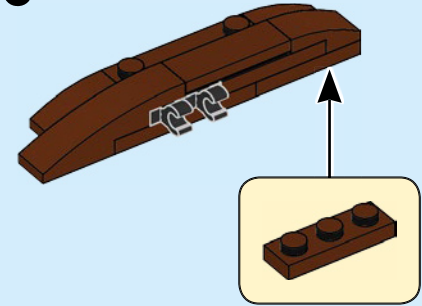



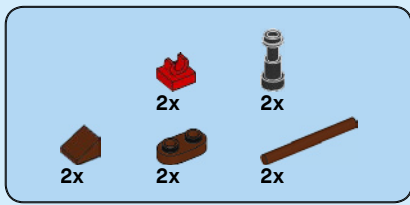

13

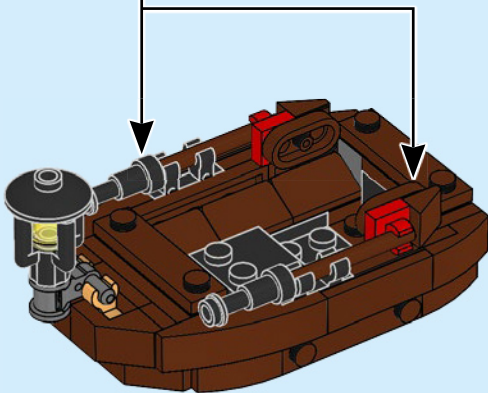
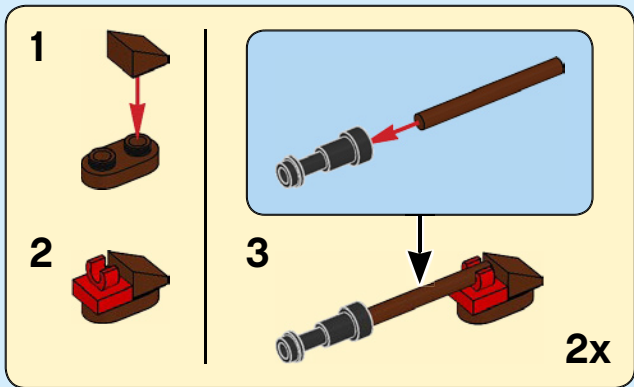

14

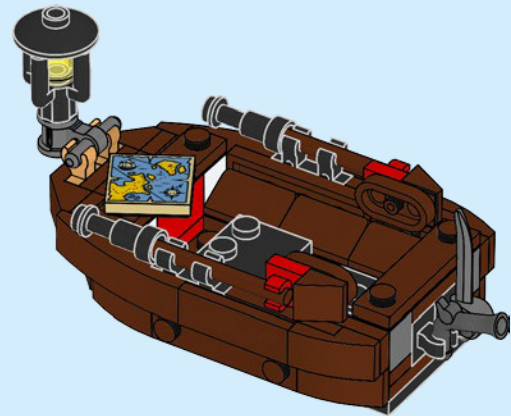

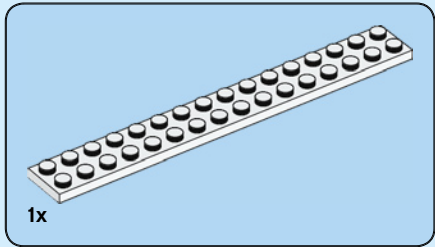
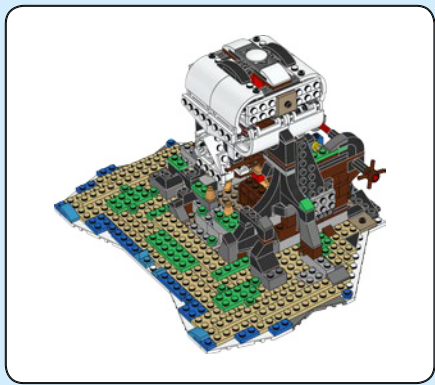

1x

**1**

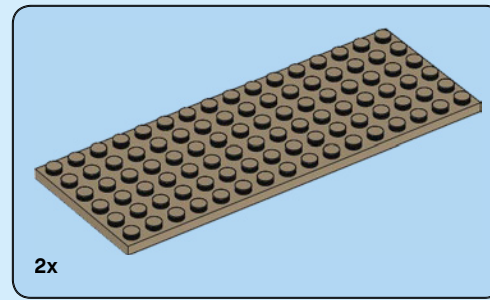
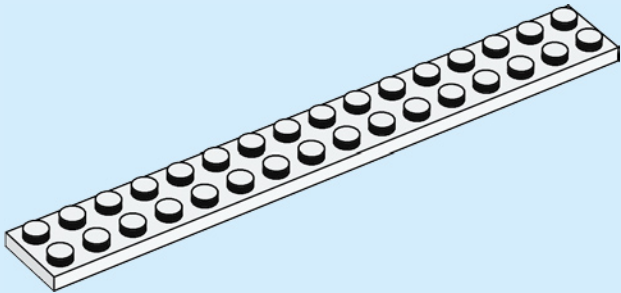

2x

**2**

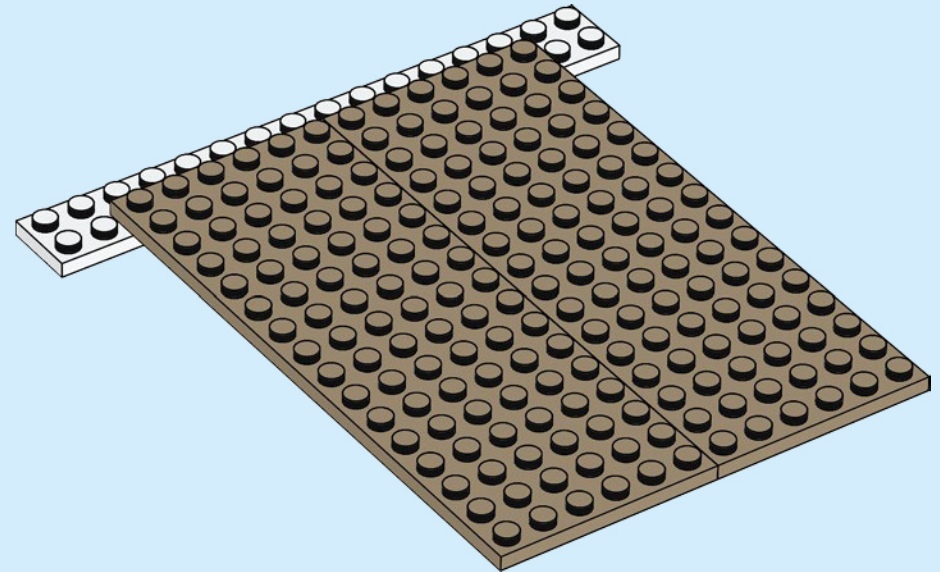

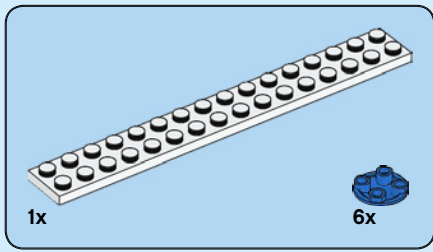

3

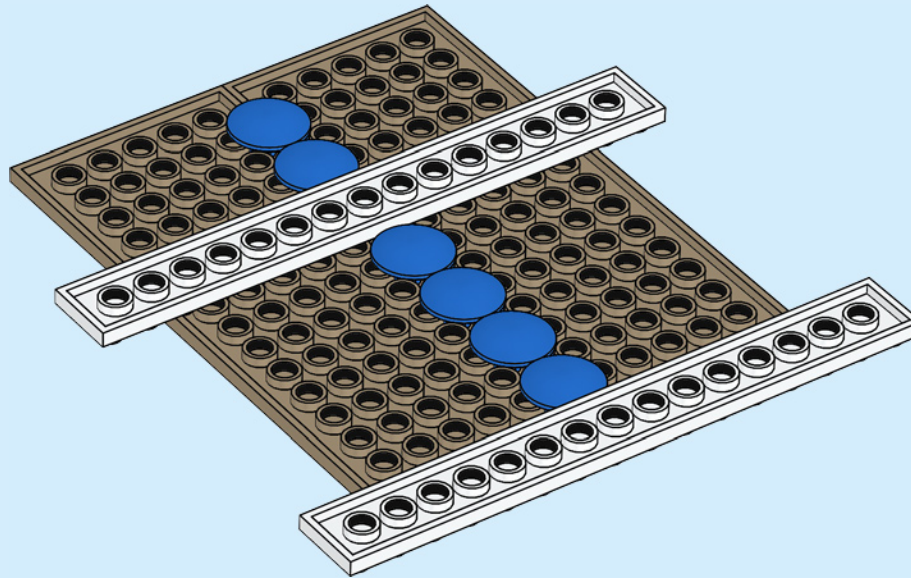

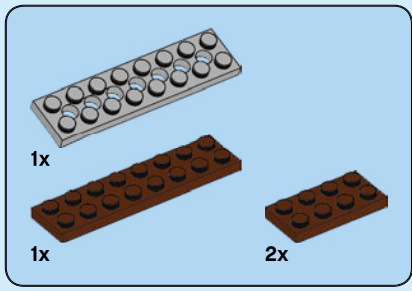

4

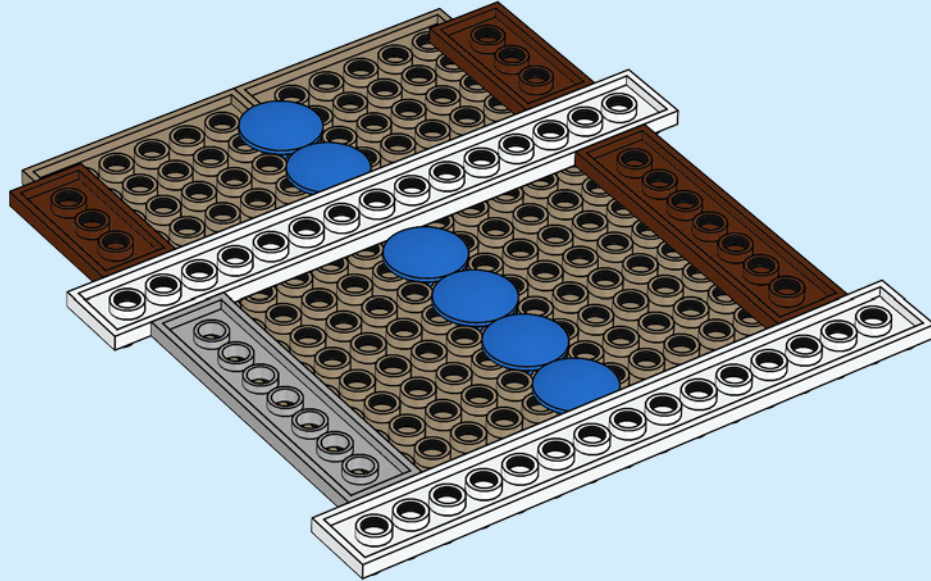

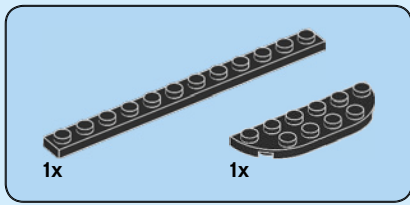

5

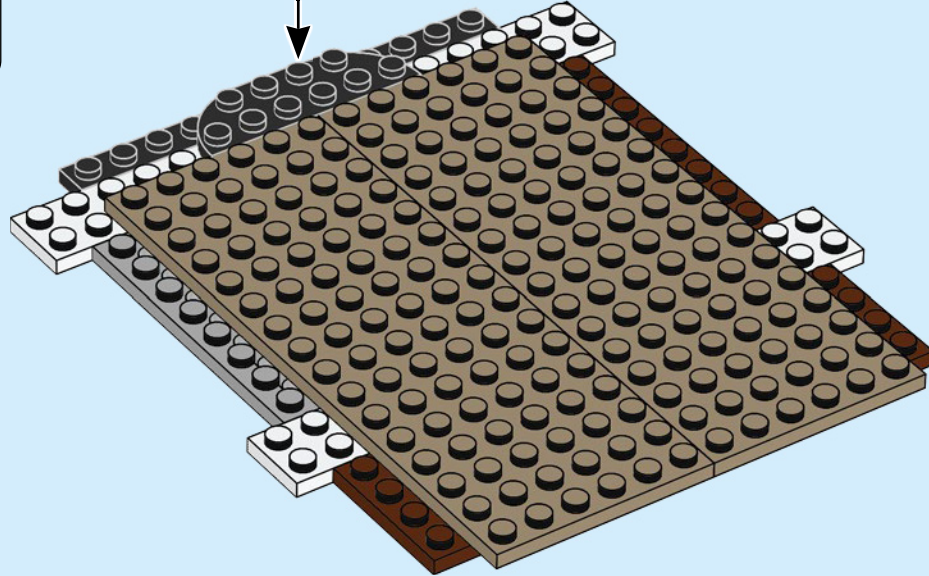
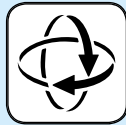
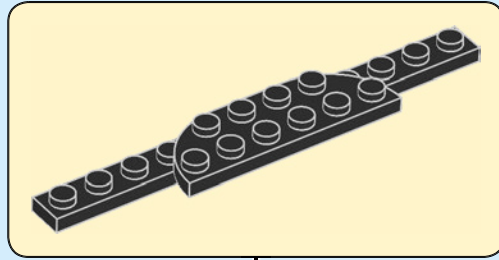

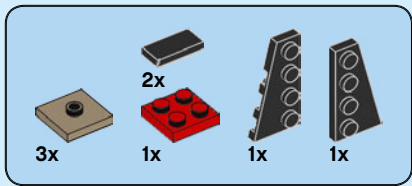

6

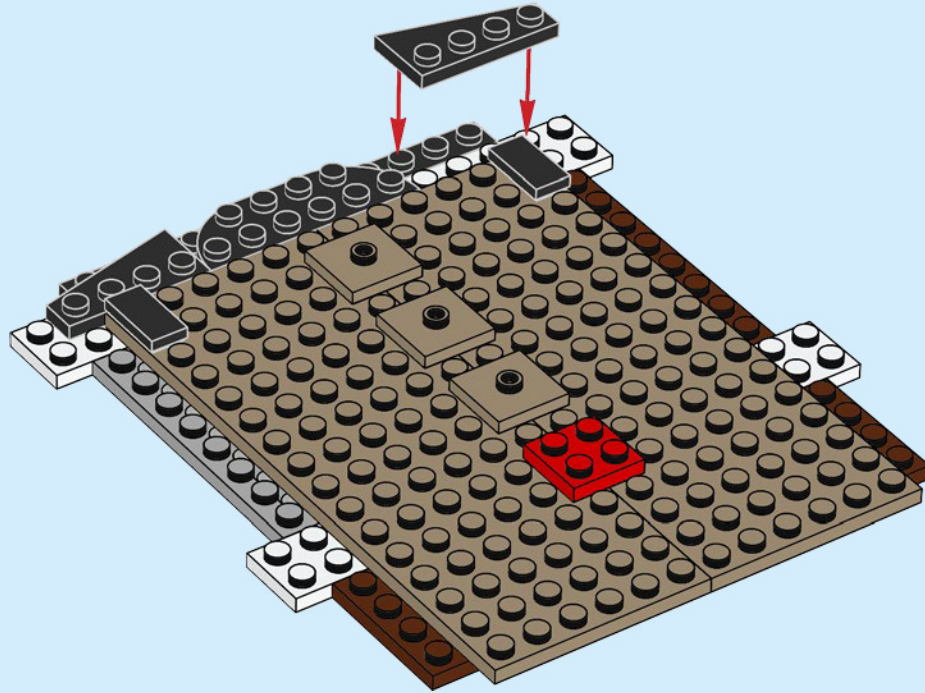

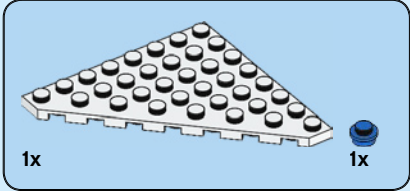
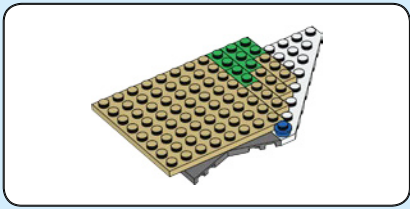

7

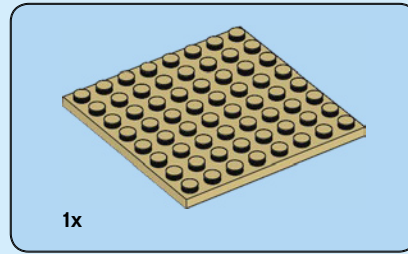
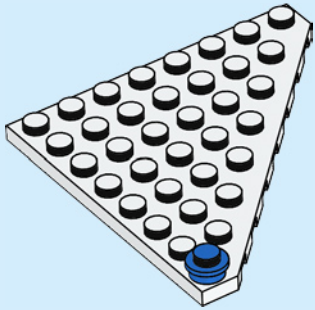

8

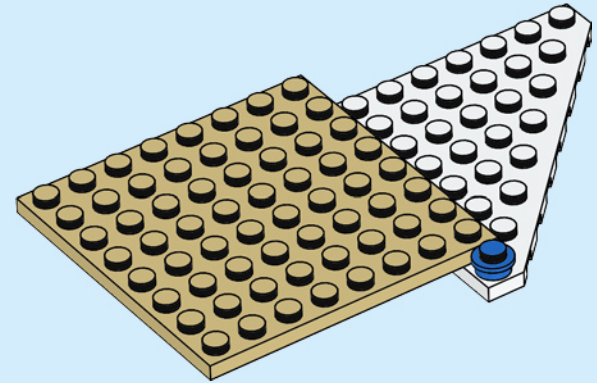

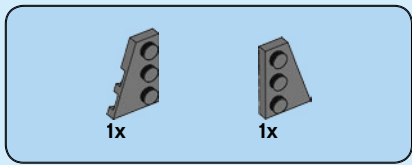

9

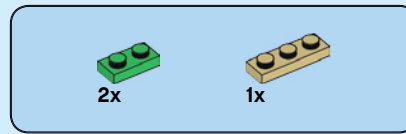
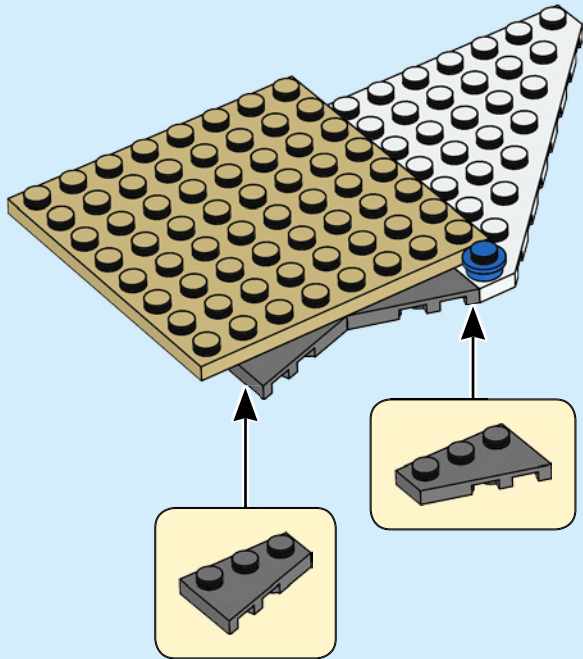

10

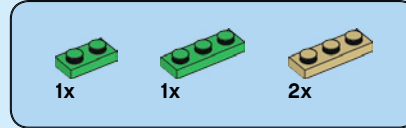
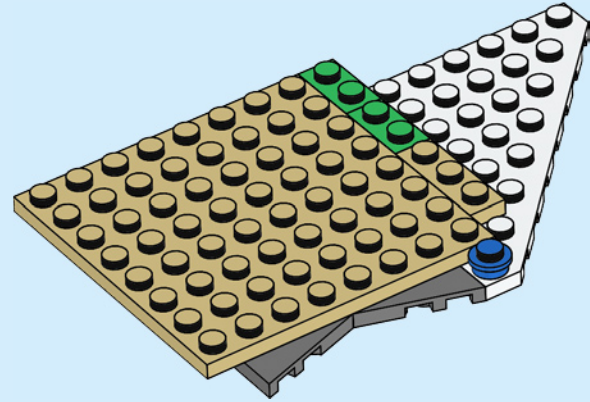

11

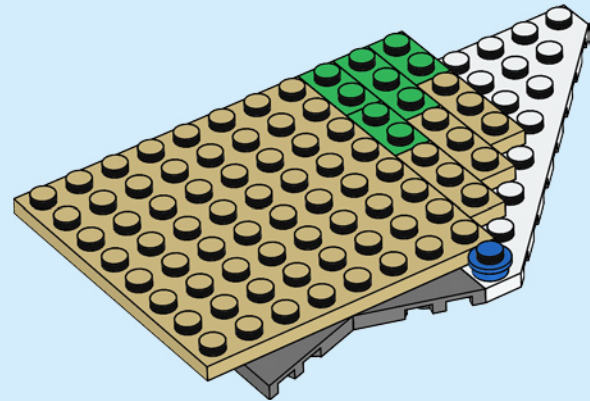

12

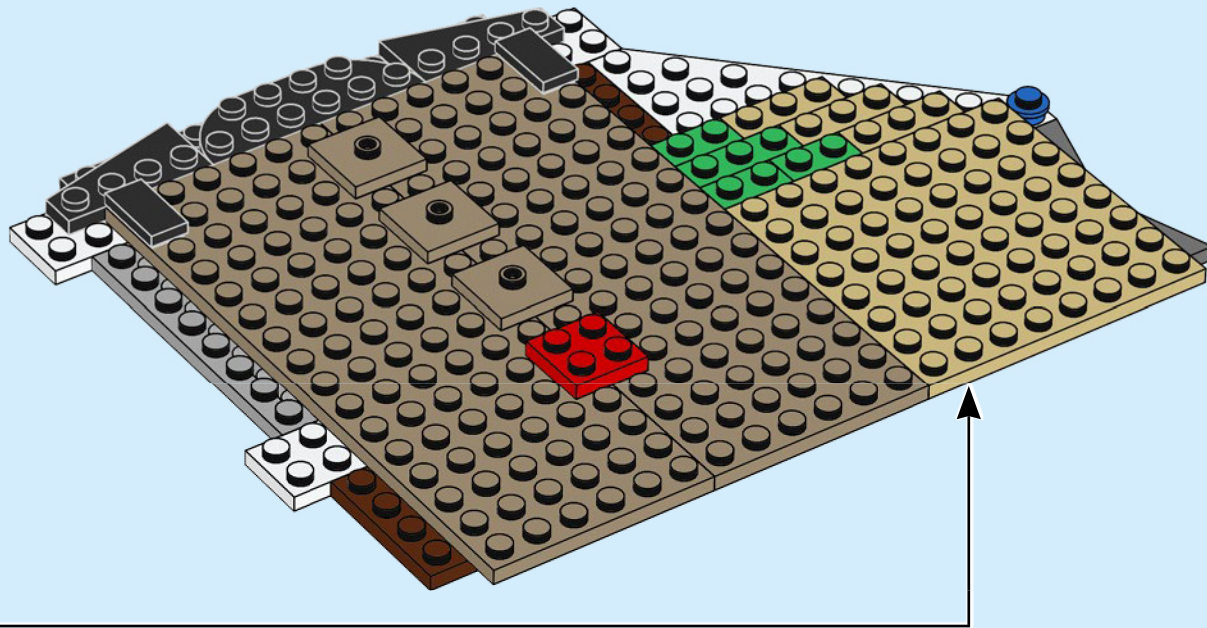

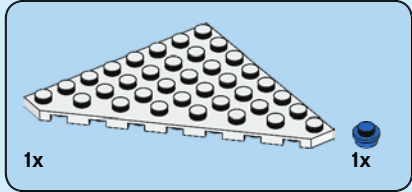
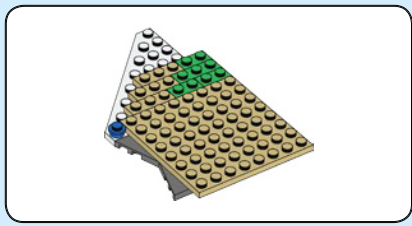

13

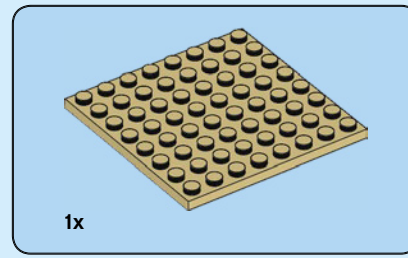
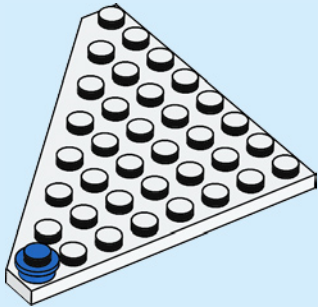

14

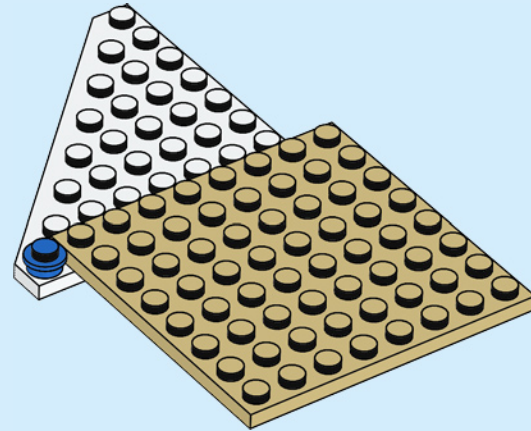

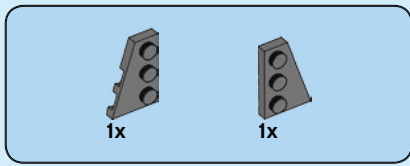

15

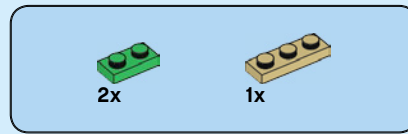
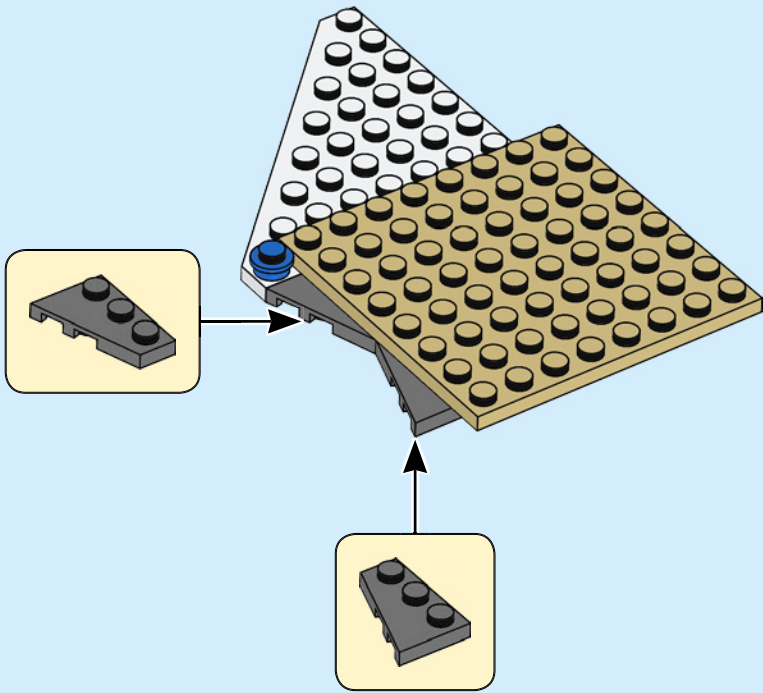

16

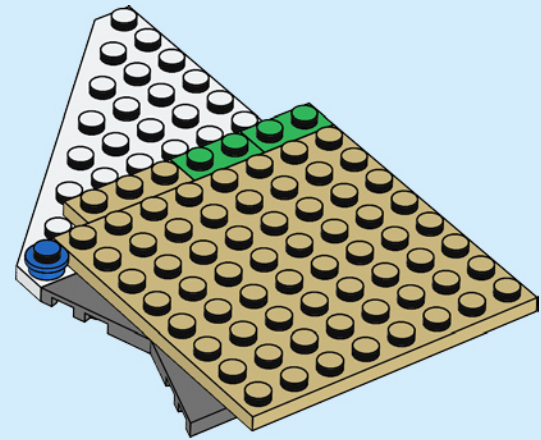

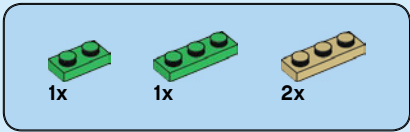

17

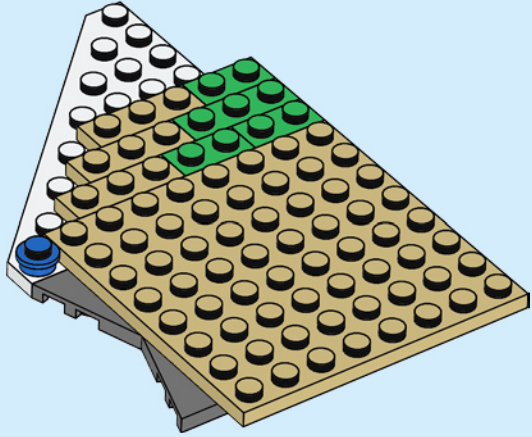

18

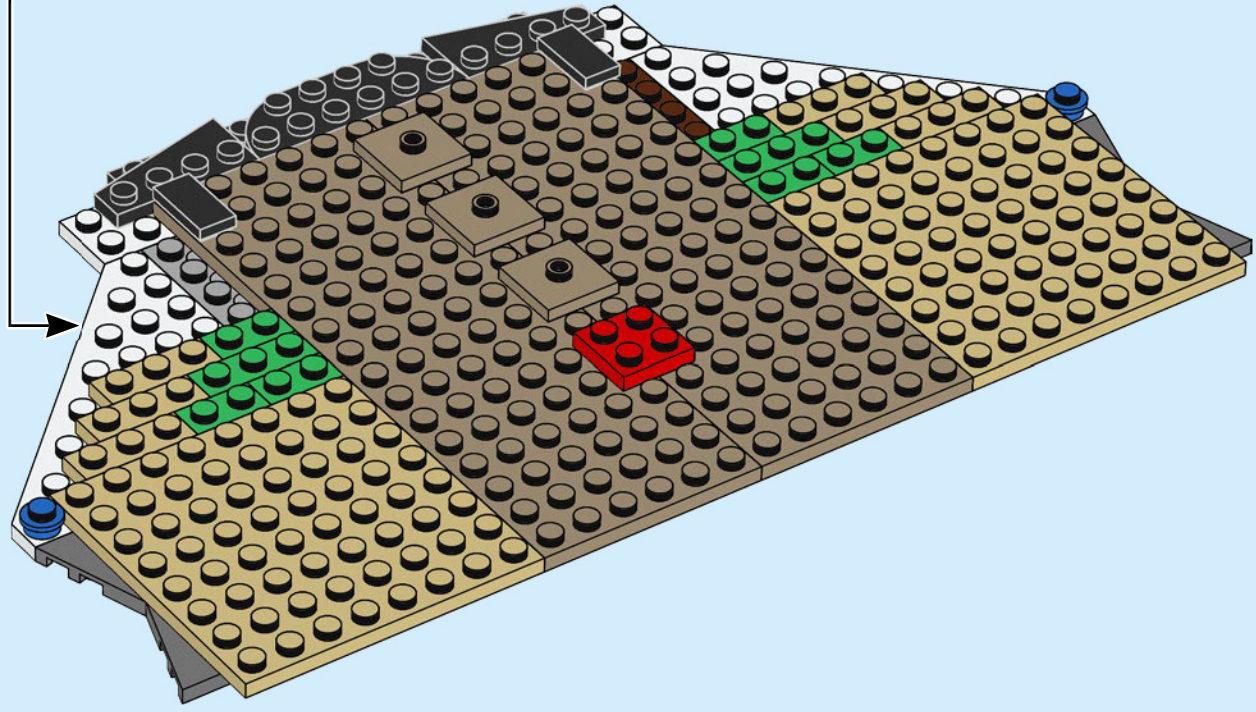

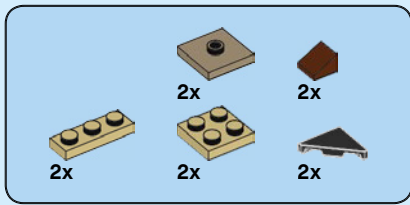

19

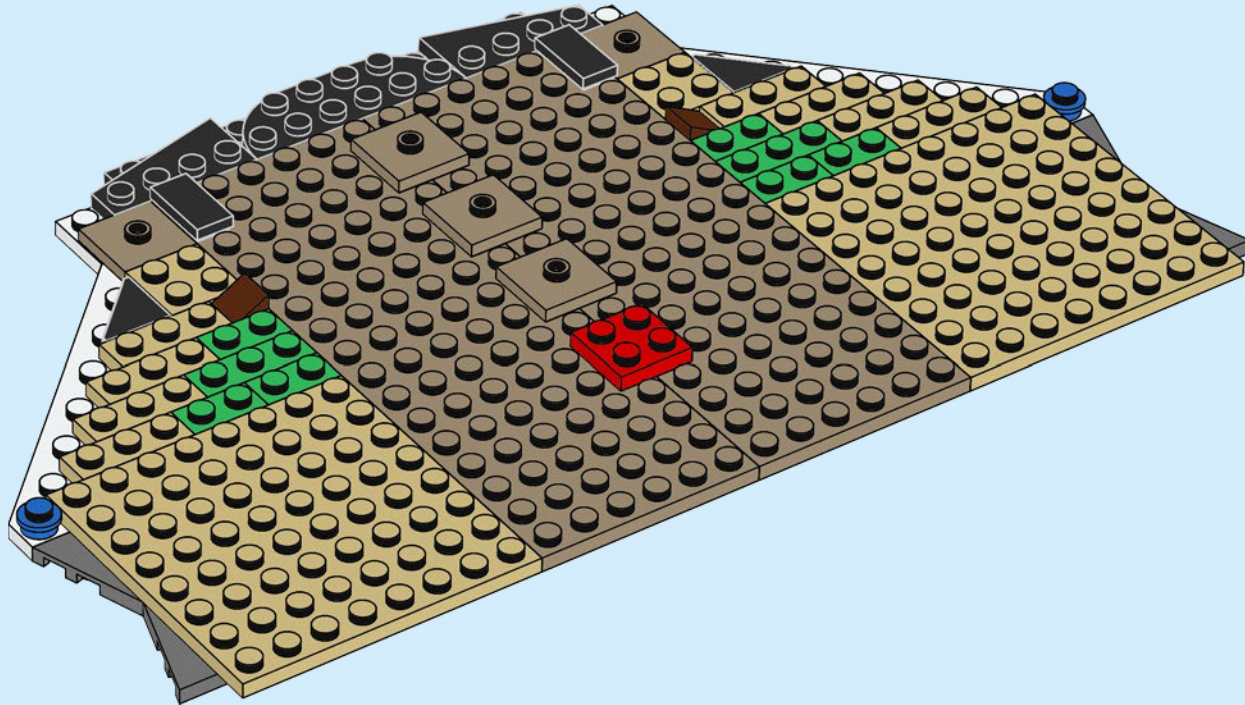

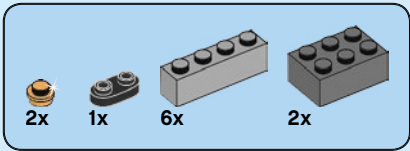

20

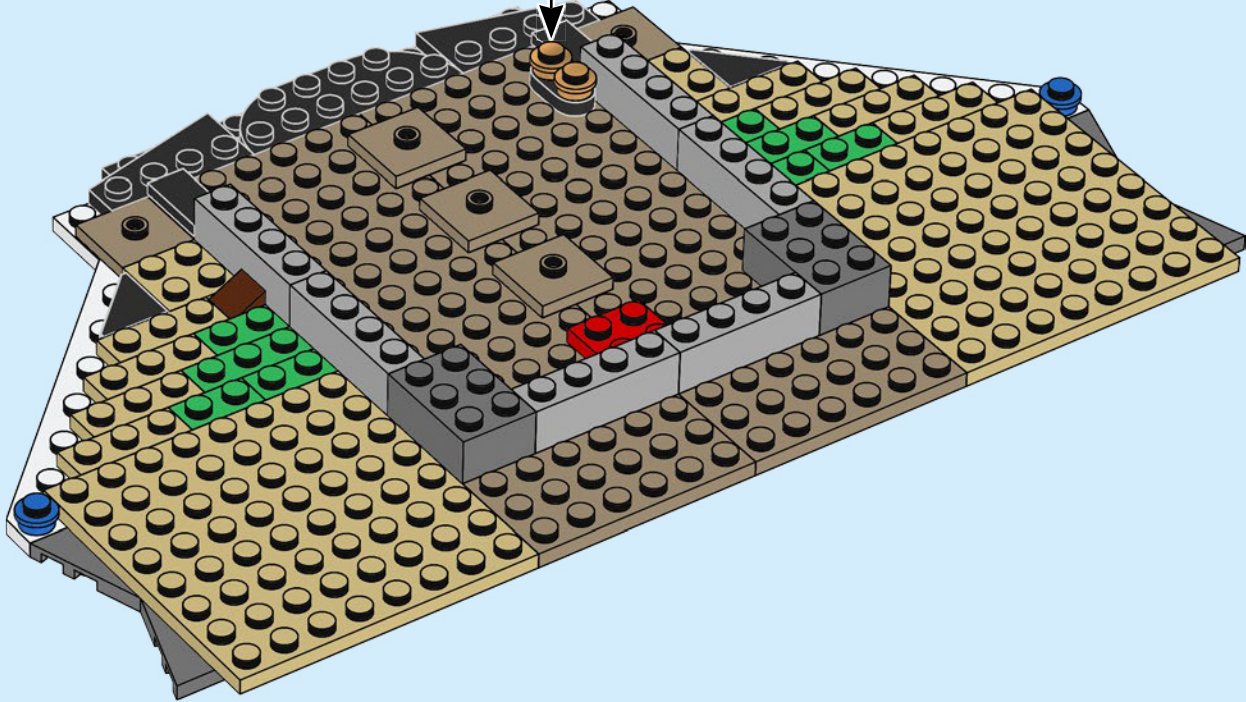
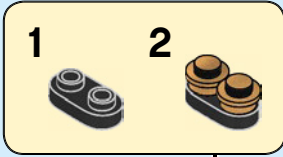

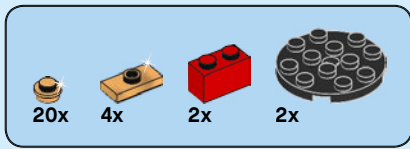

21

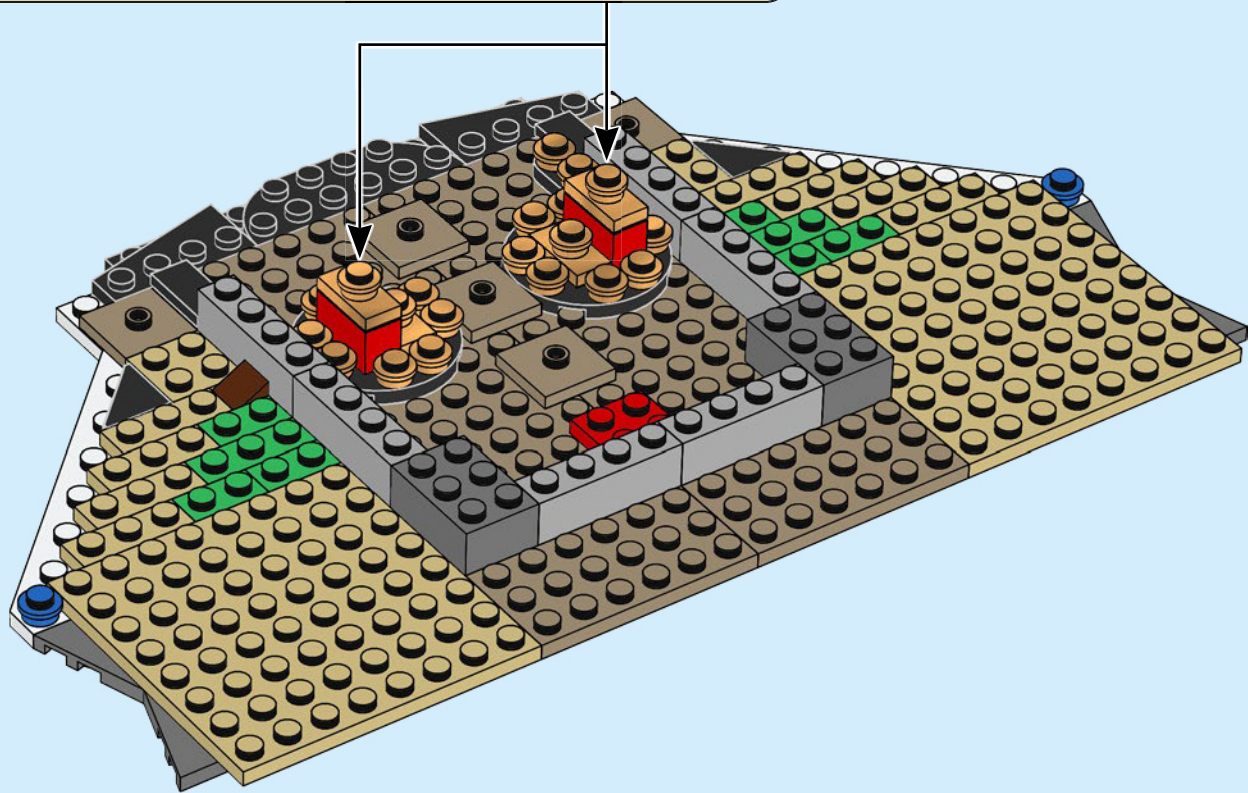
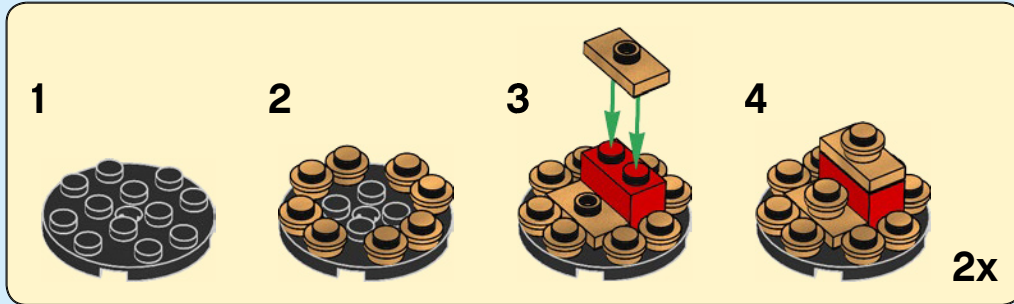

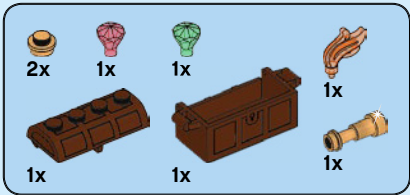

22

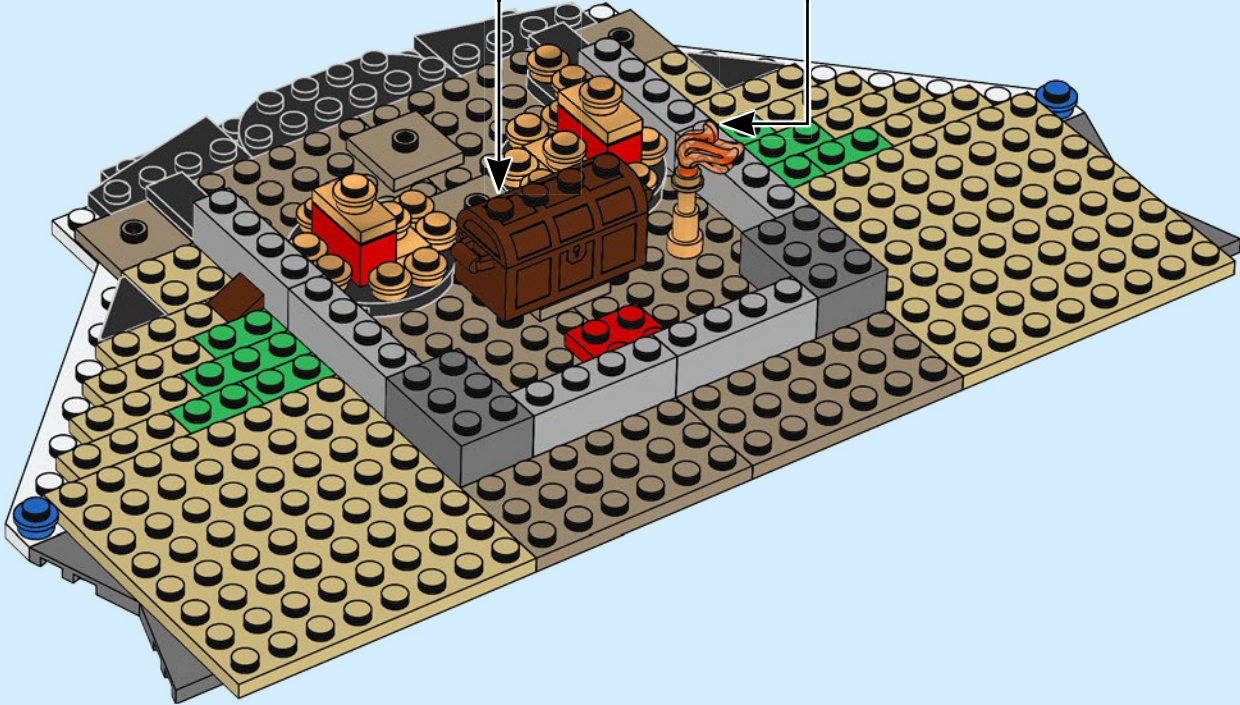
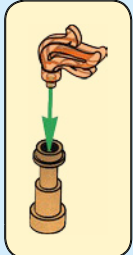
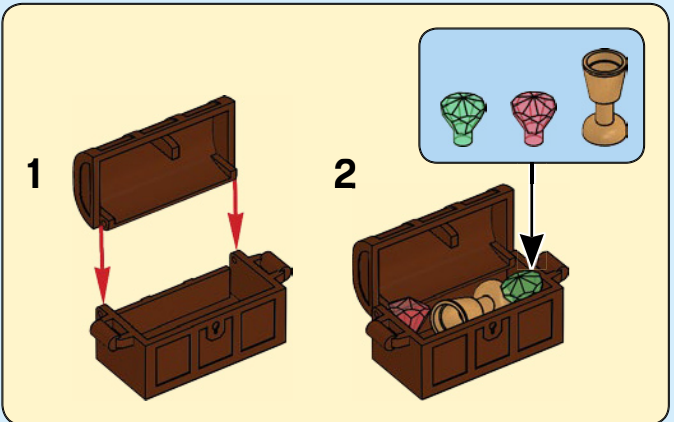



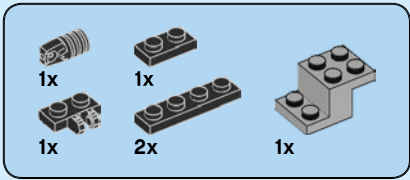

24

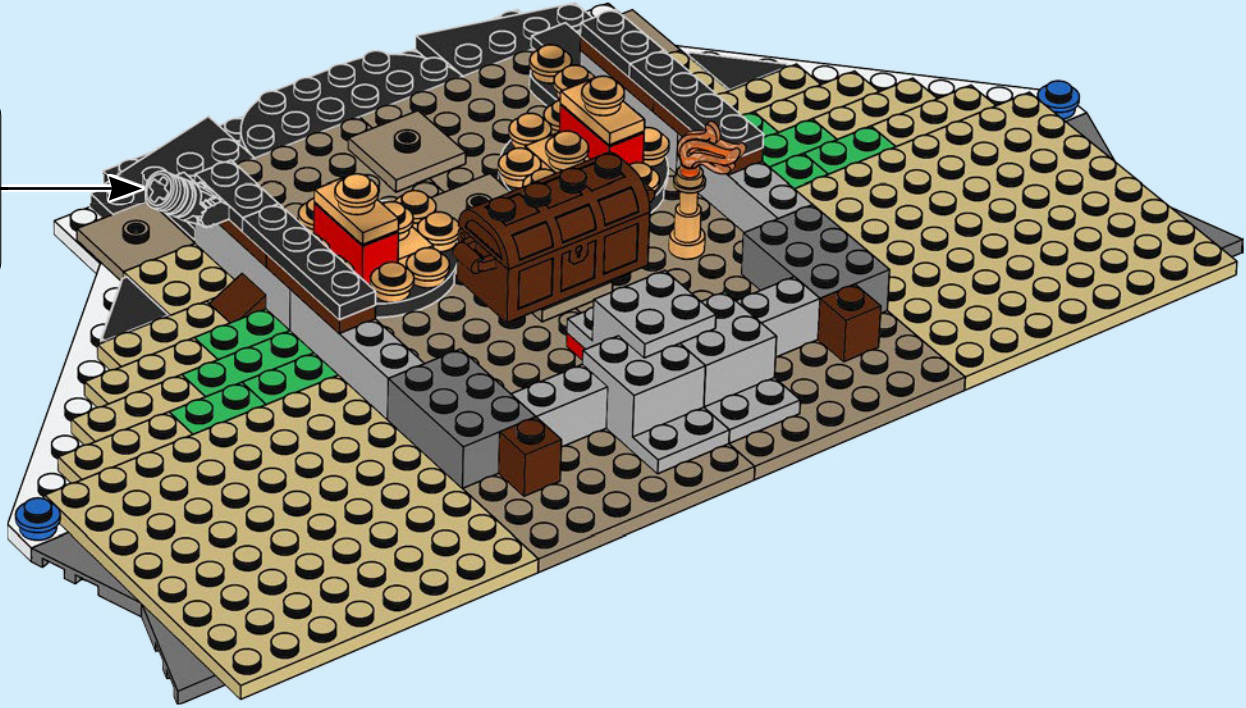
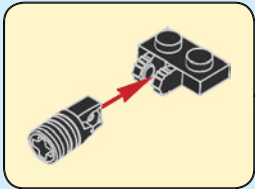

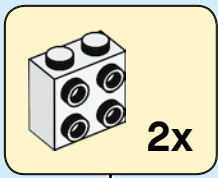
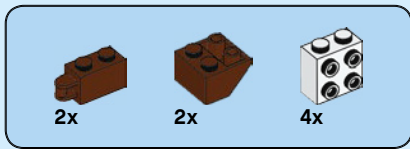

25

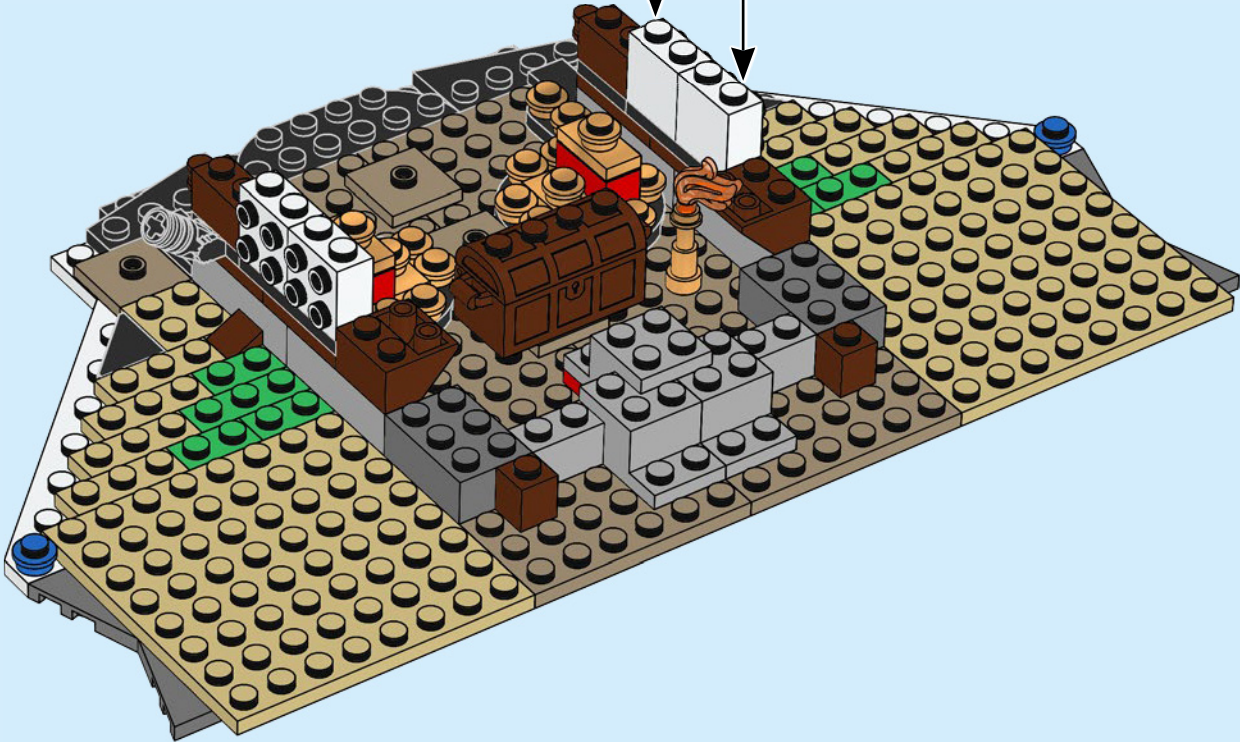

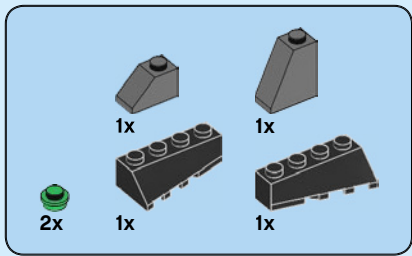

26

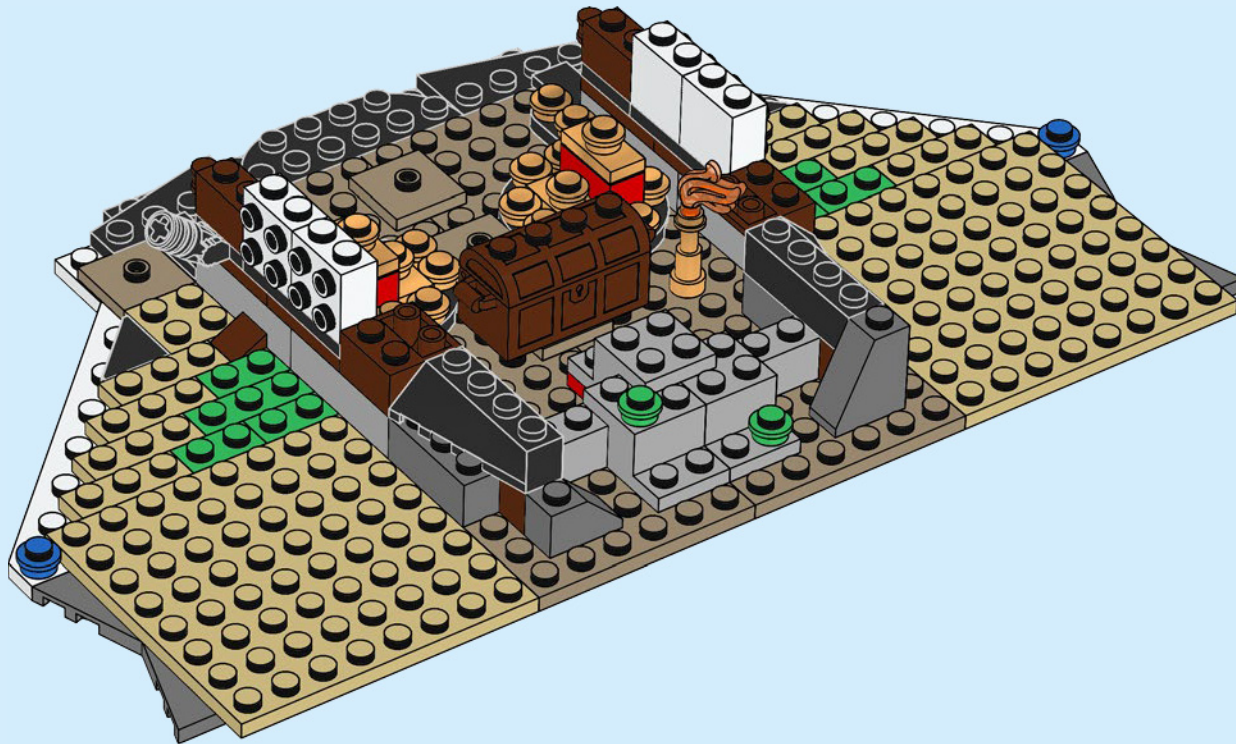

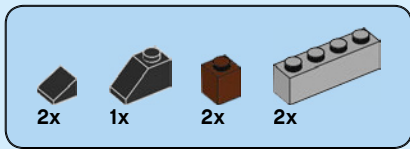

27

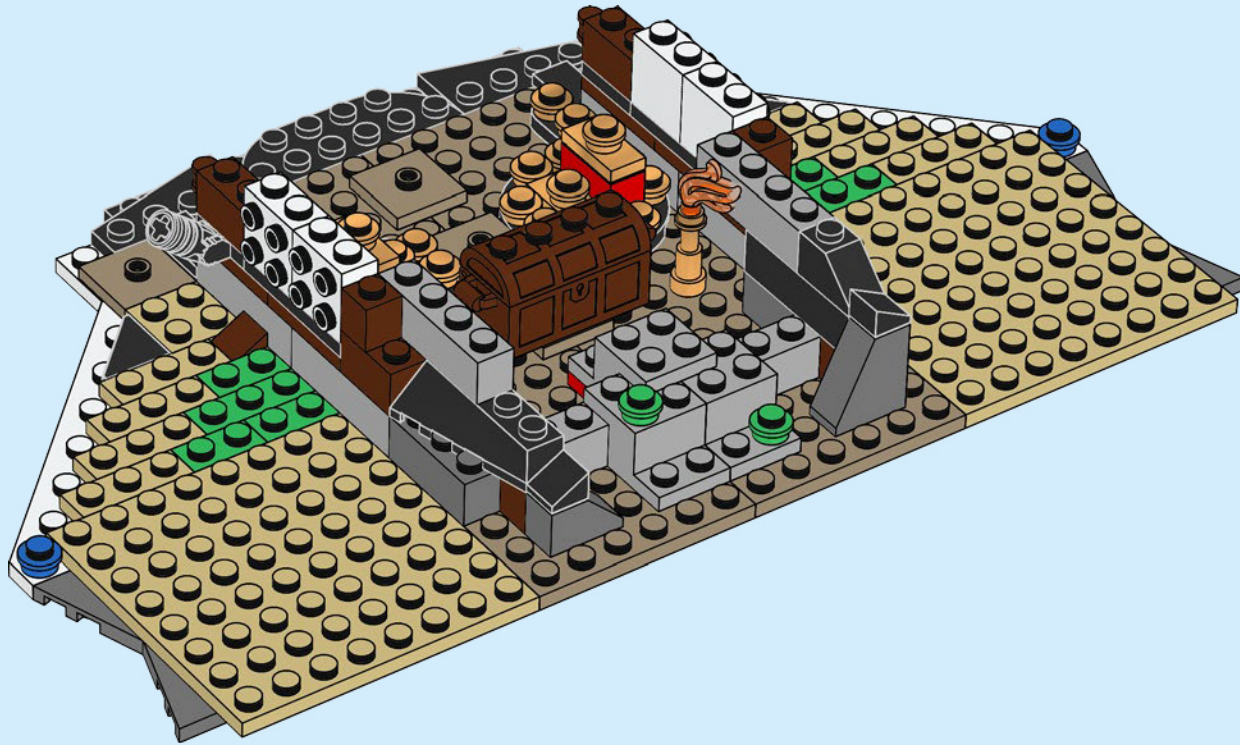

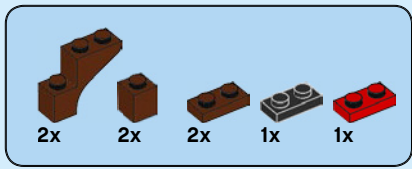

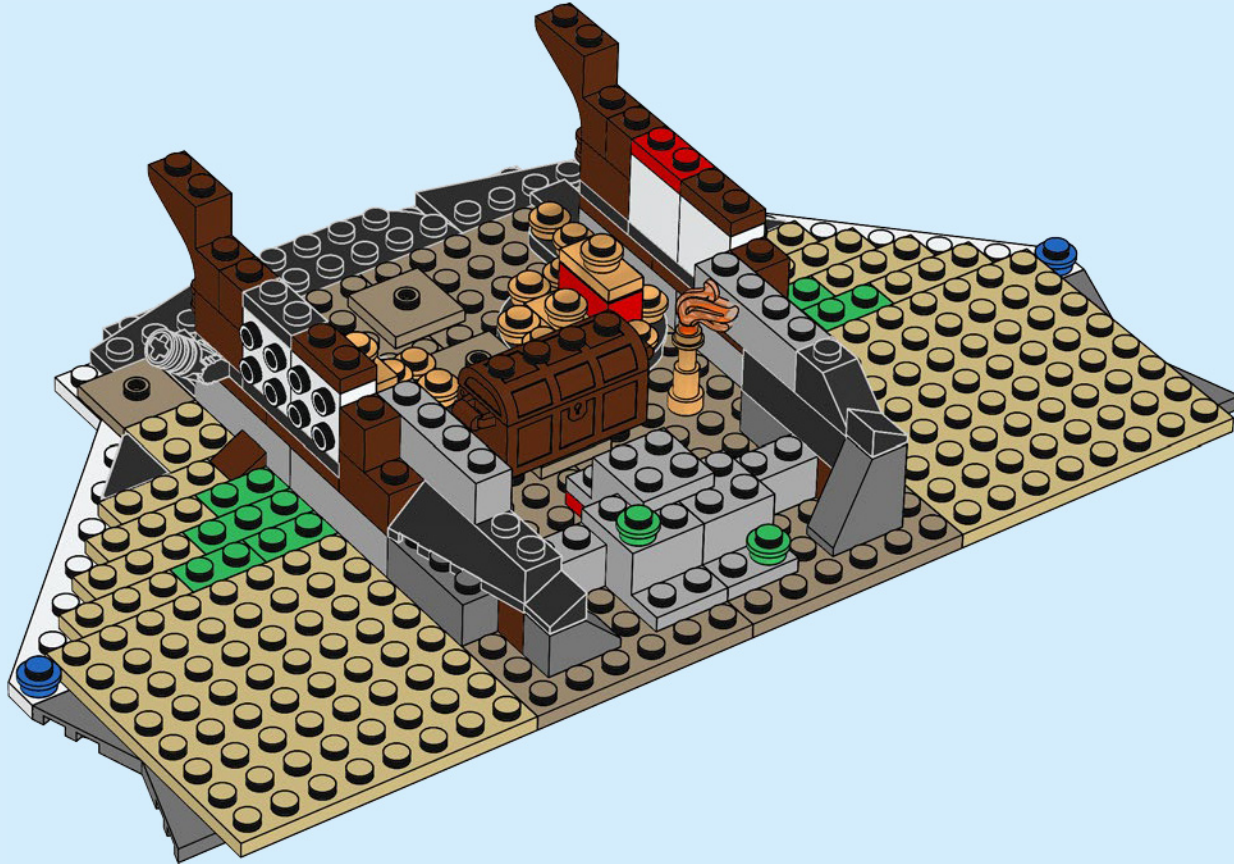

28

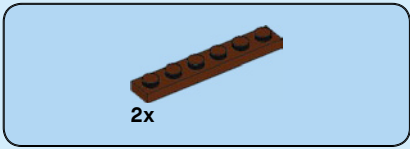

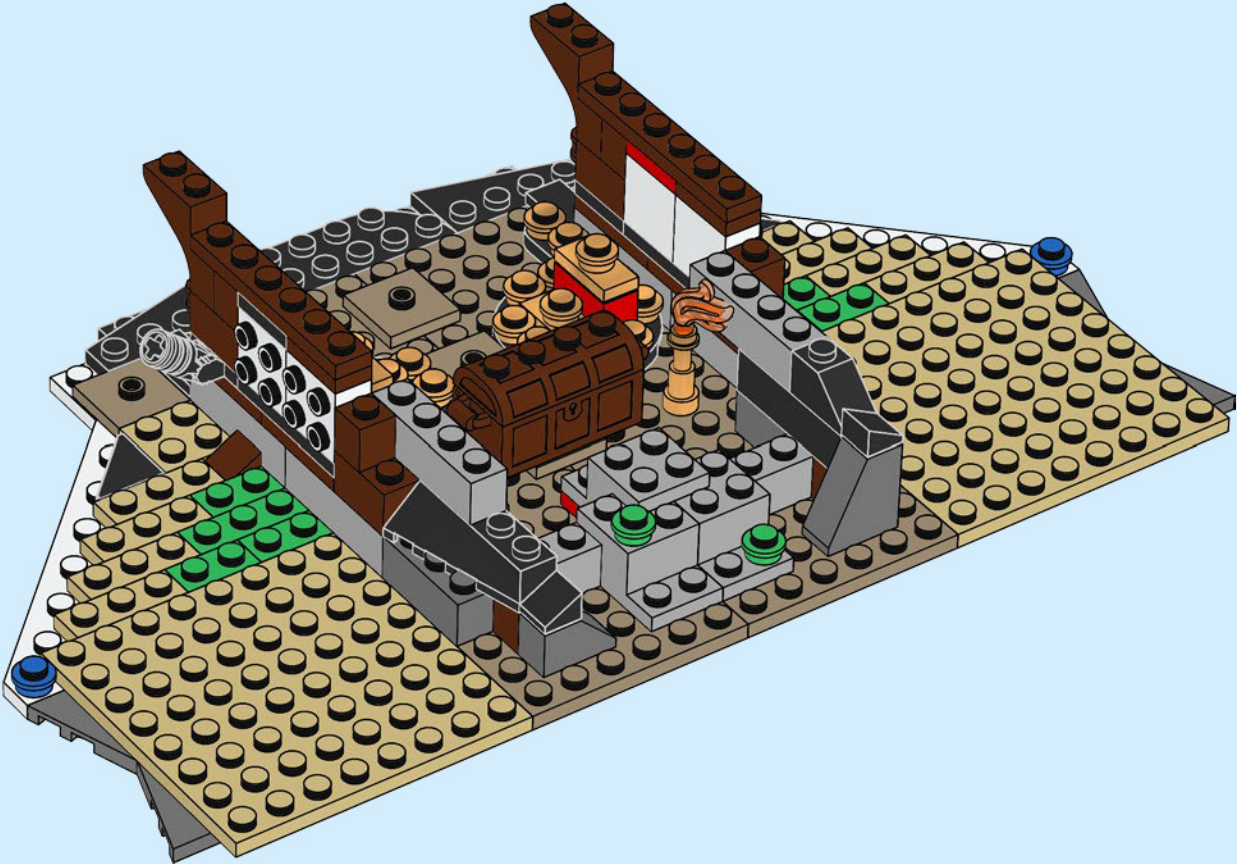

29



2x  2x 

30

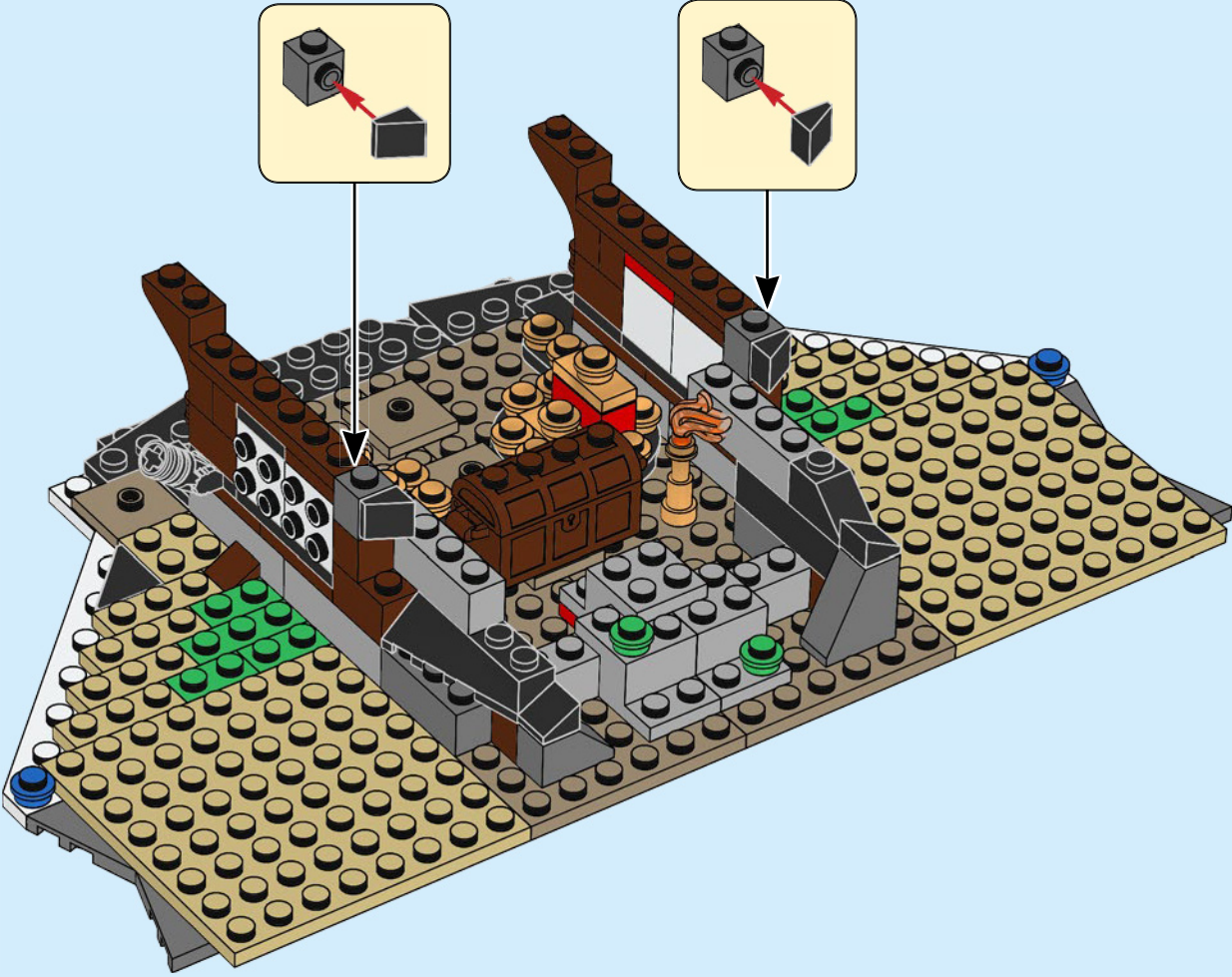

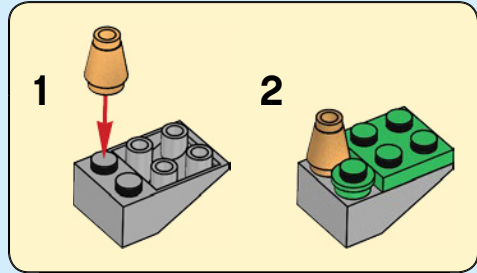
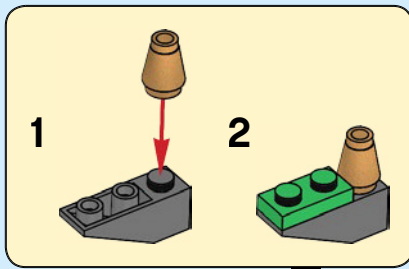
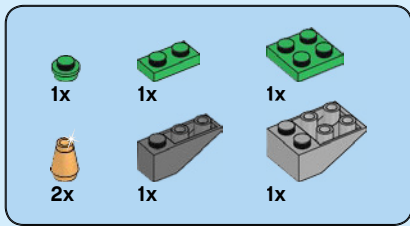

31

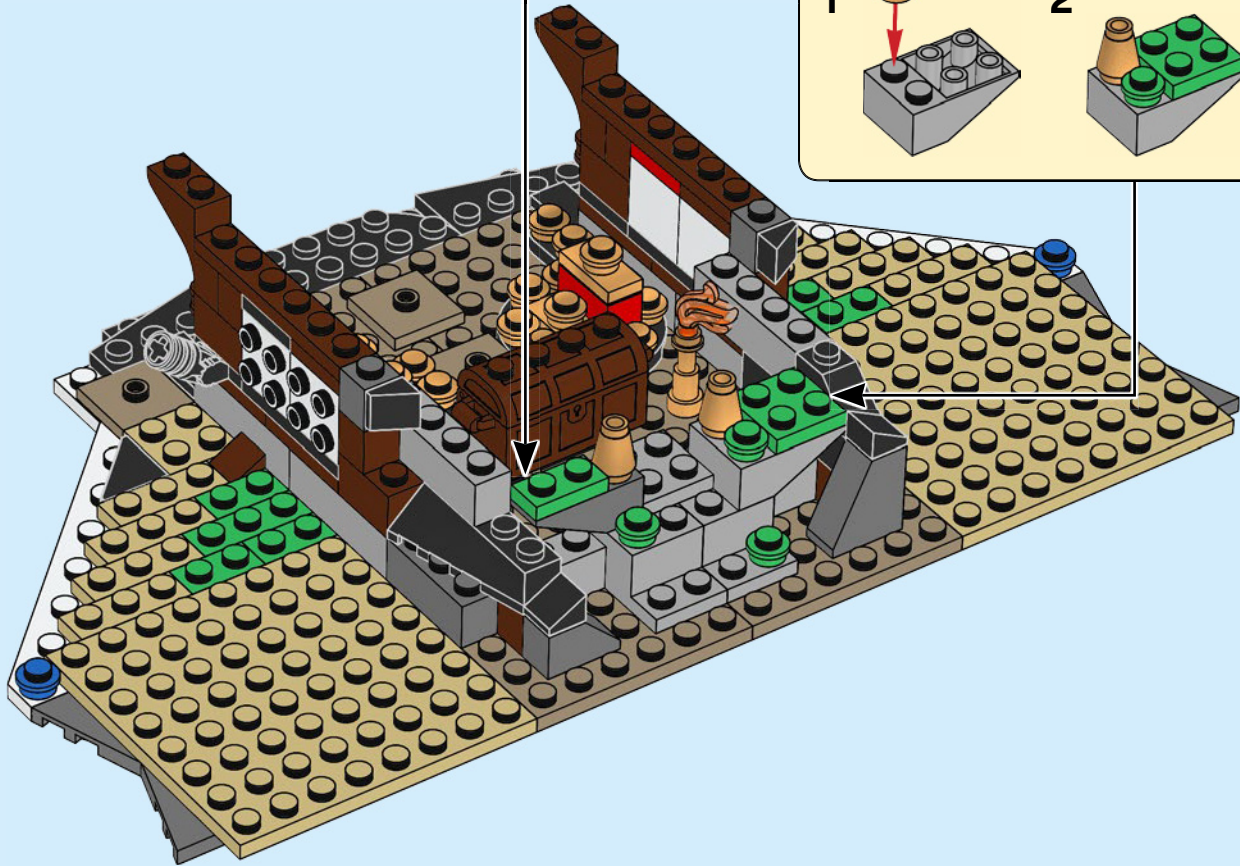

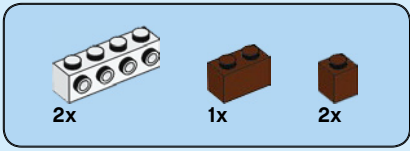

# 32

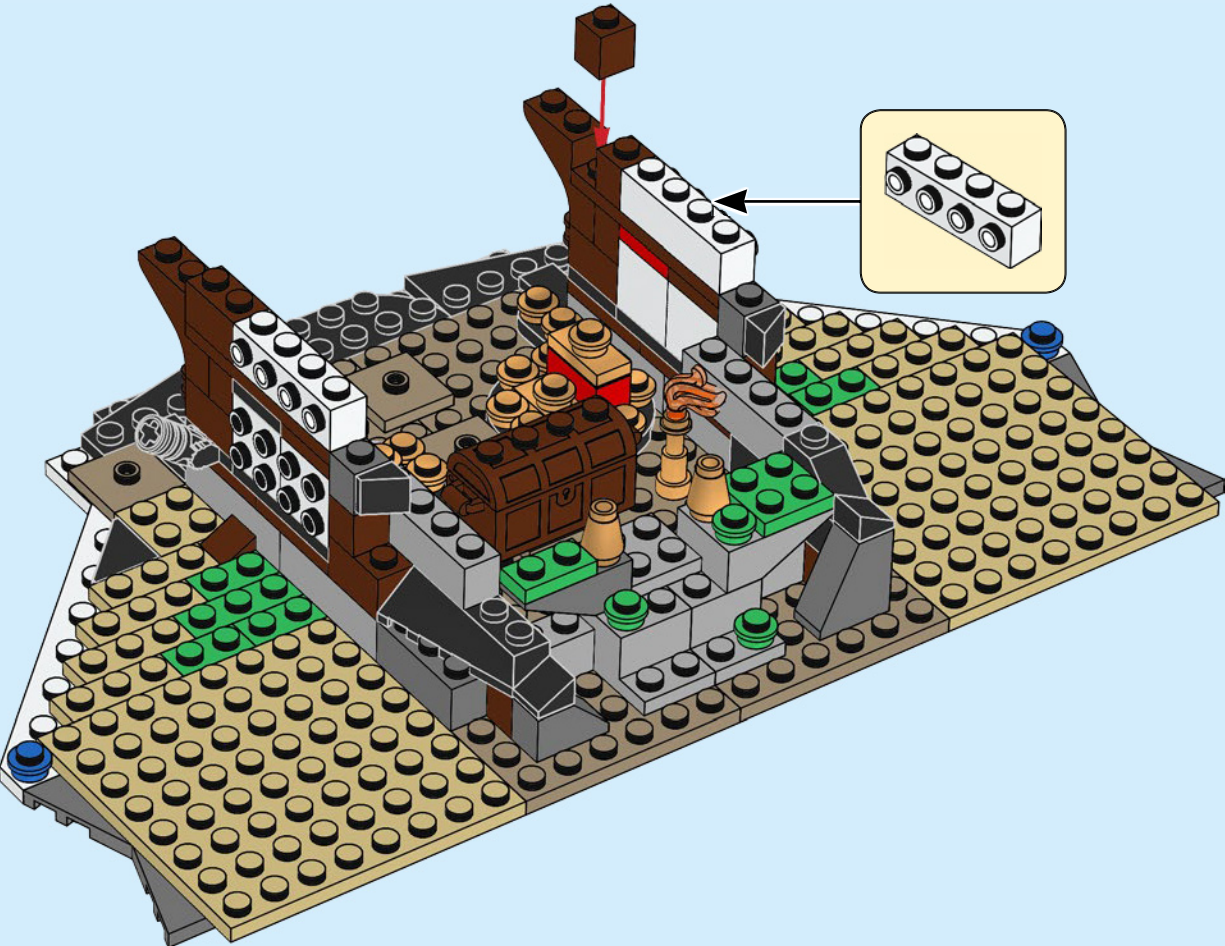

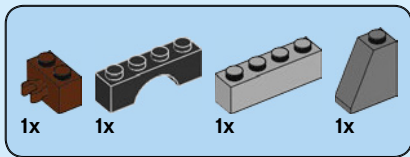

33

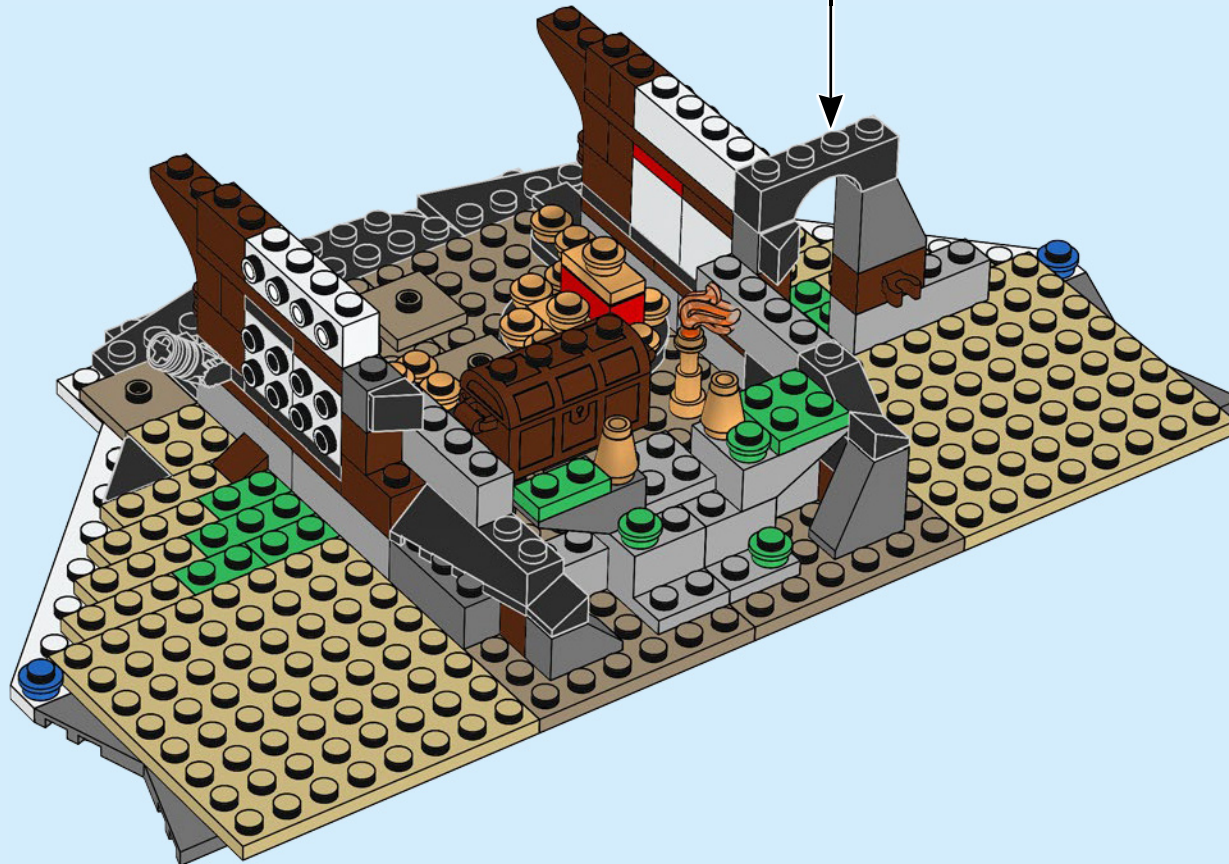
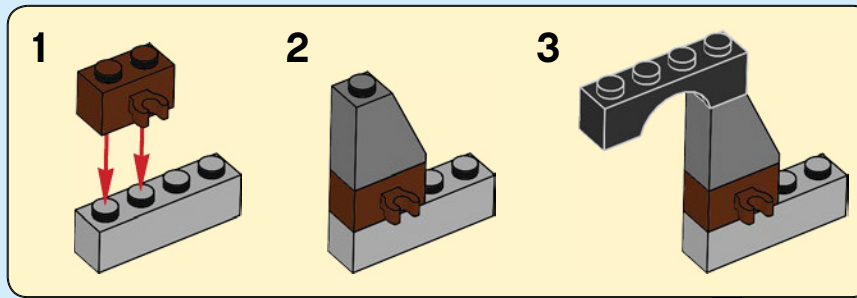

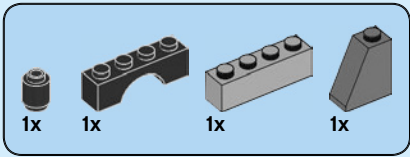

34

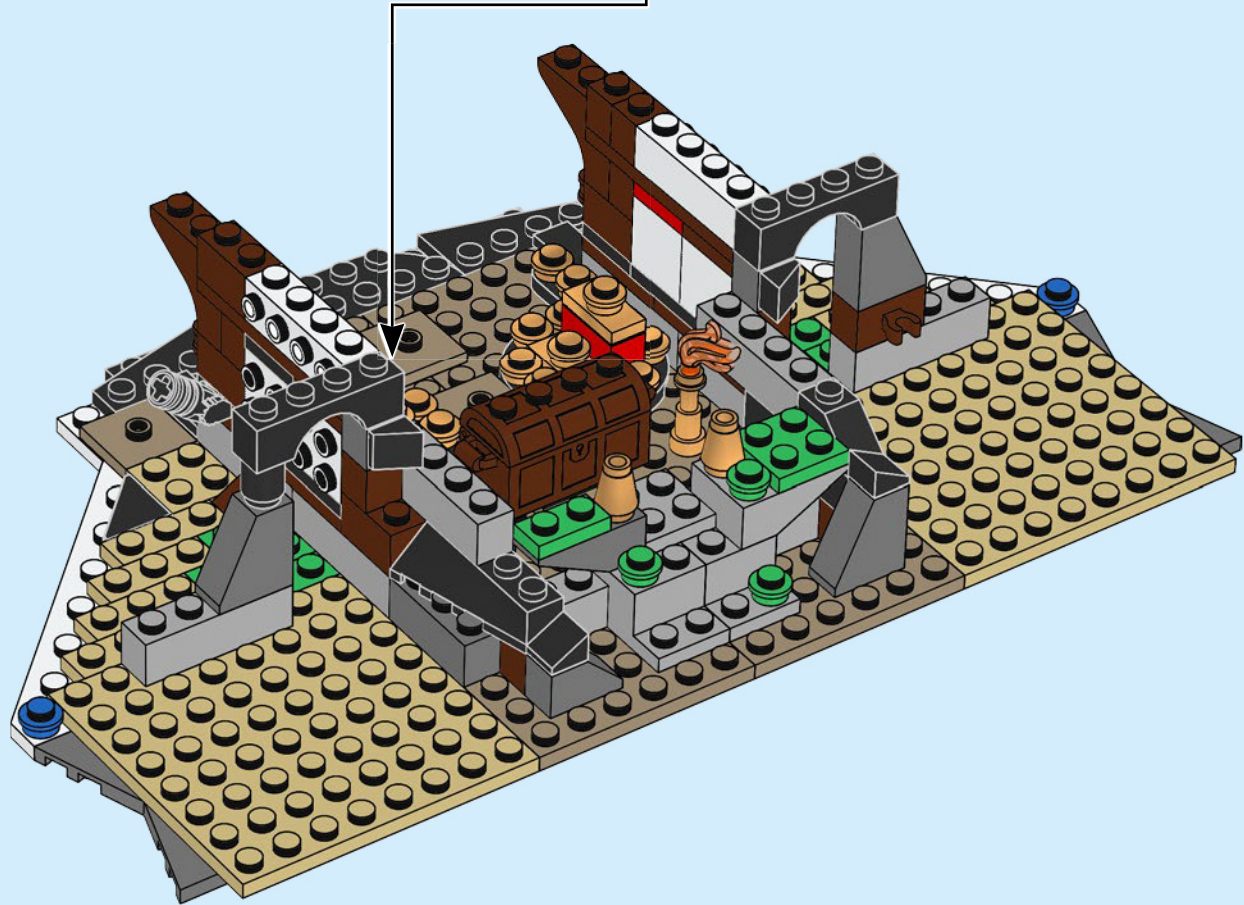
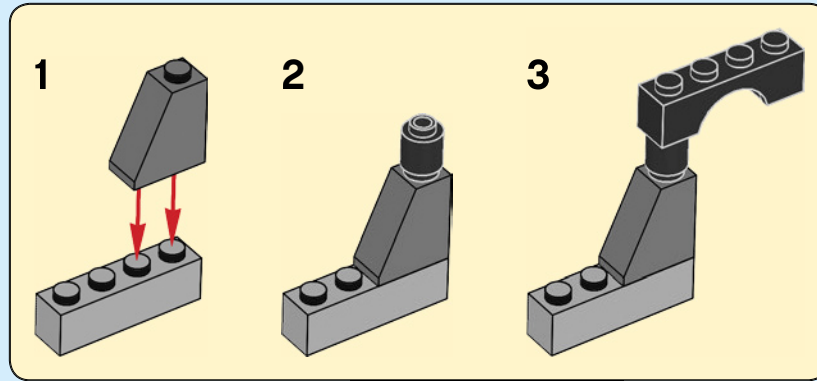

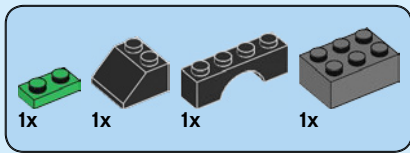

35

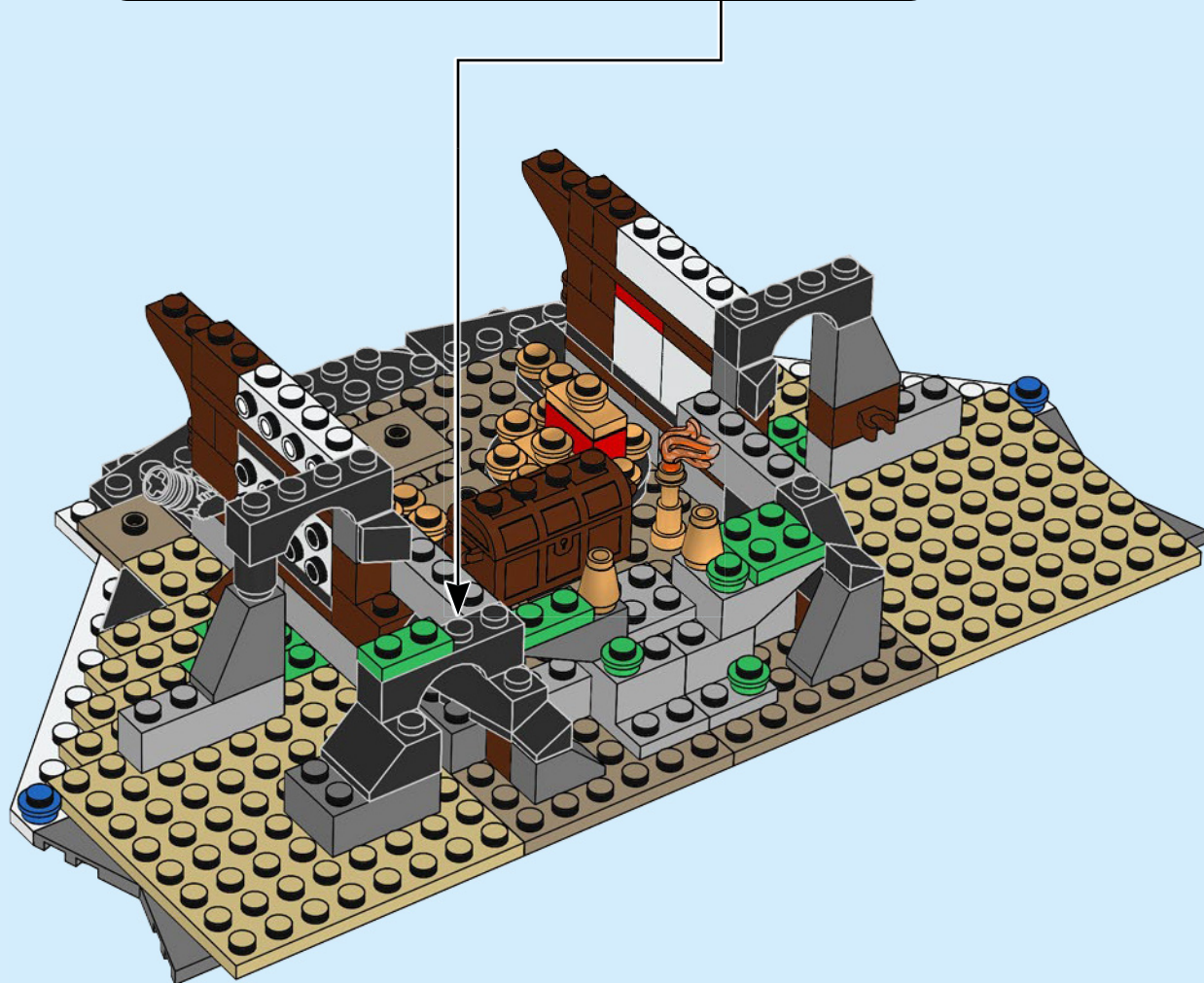
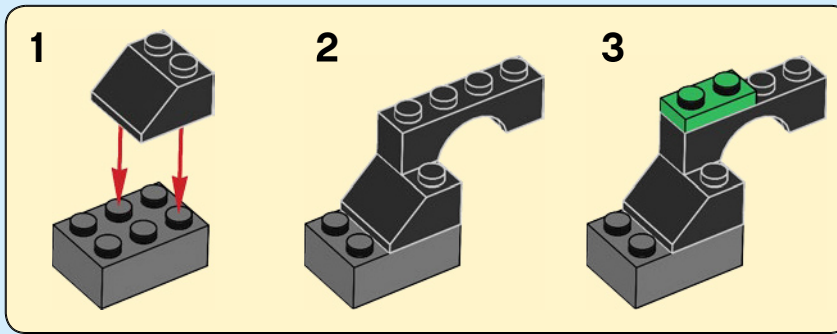

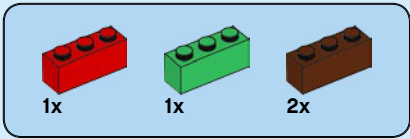

36

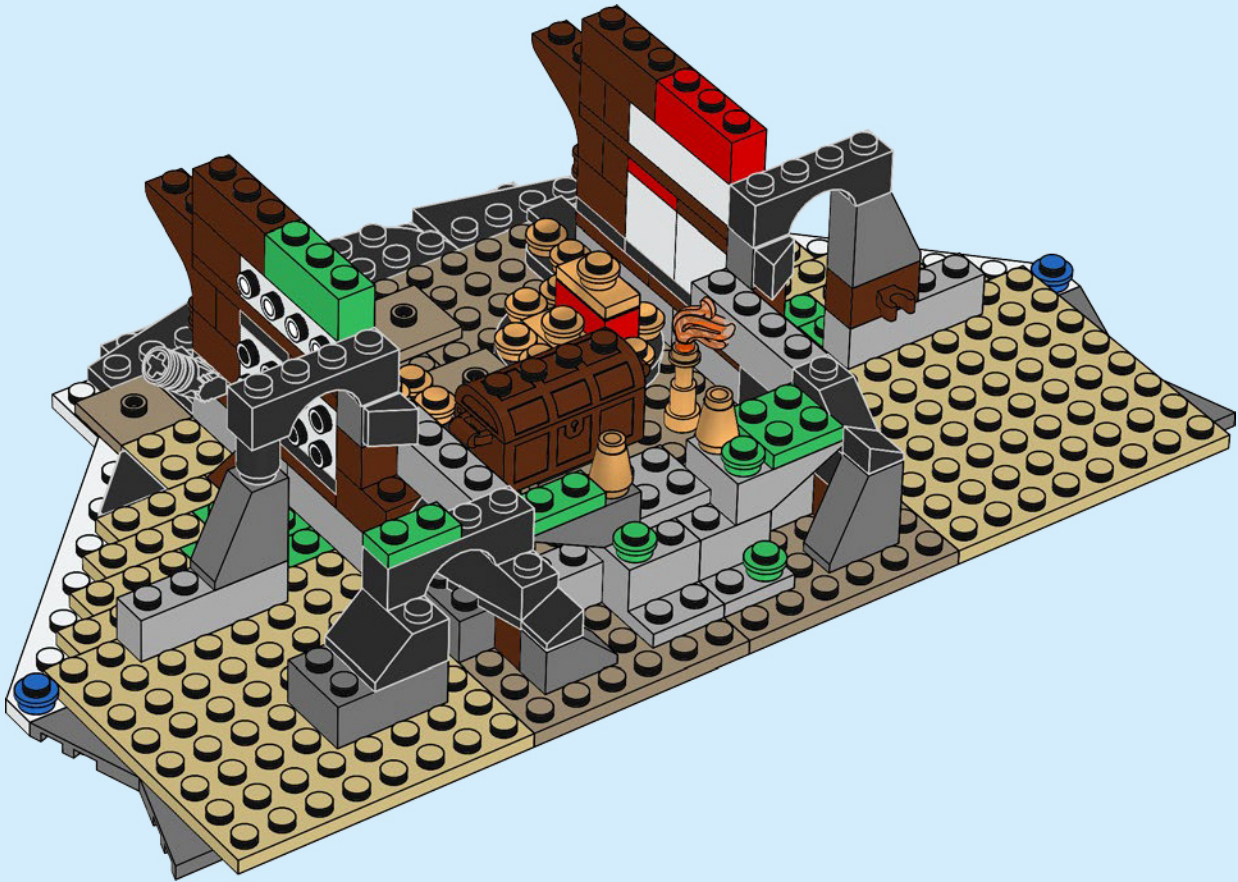

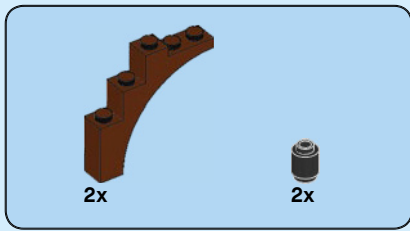

37

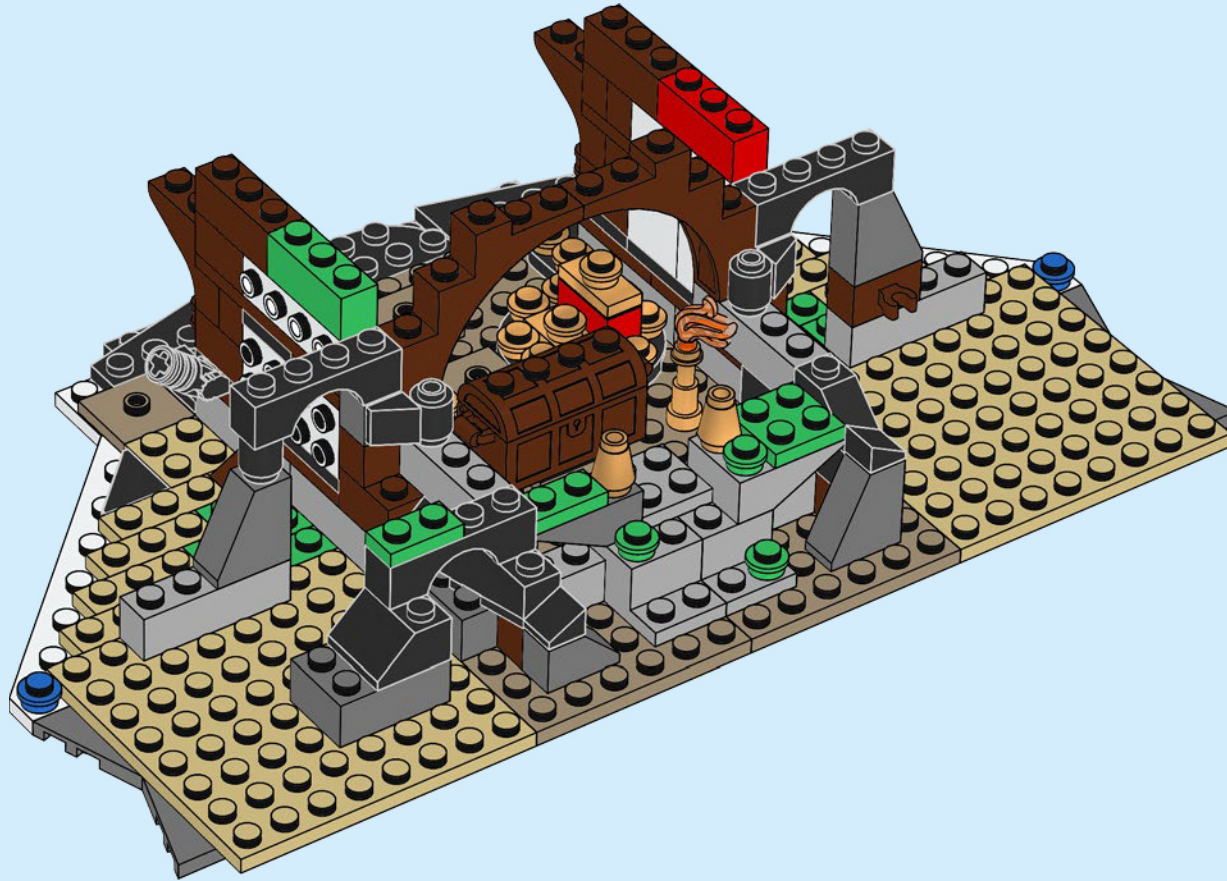

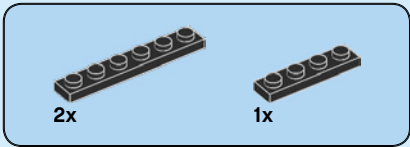

38

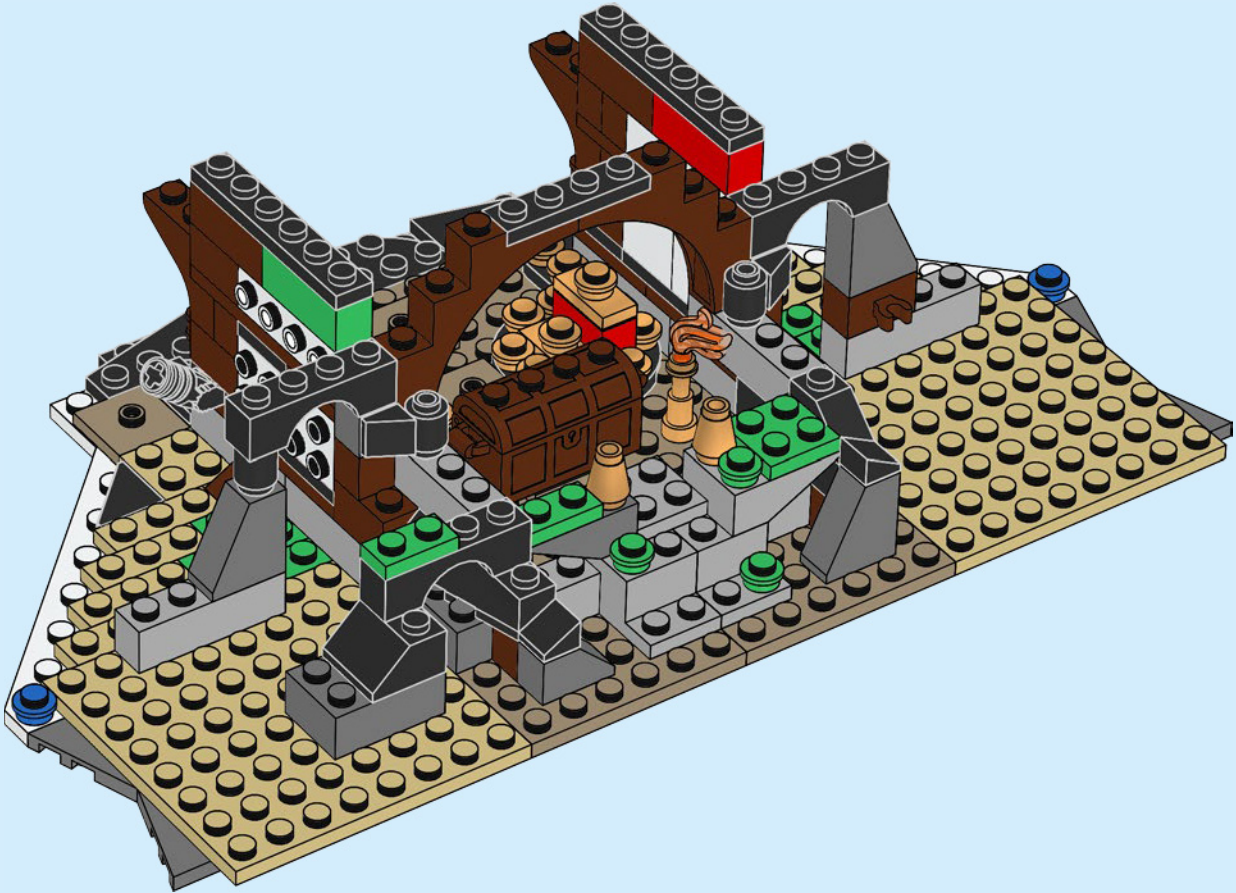

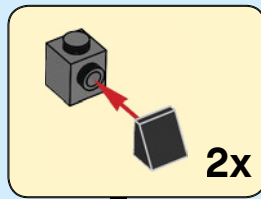
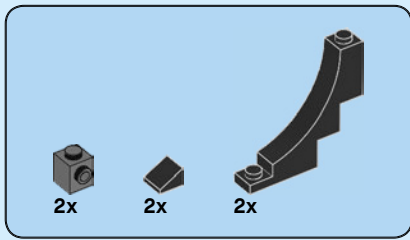

39

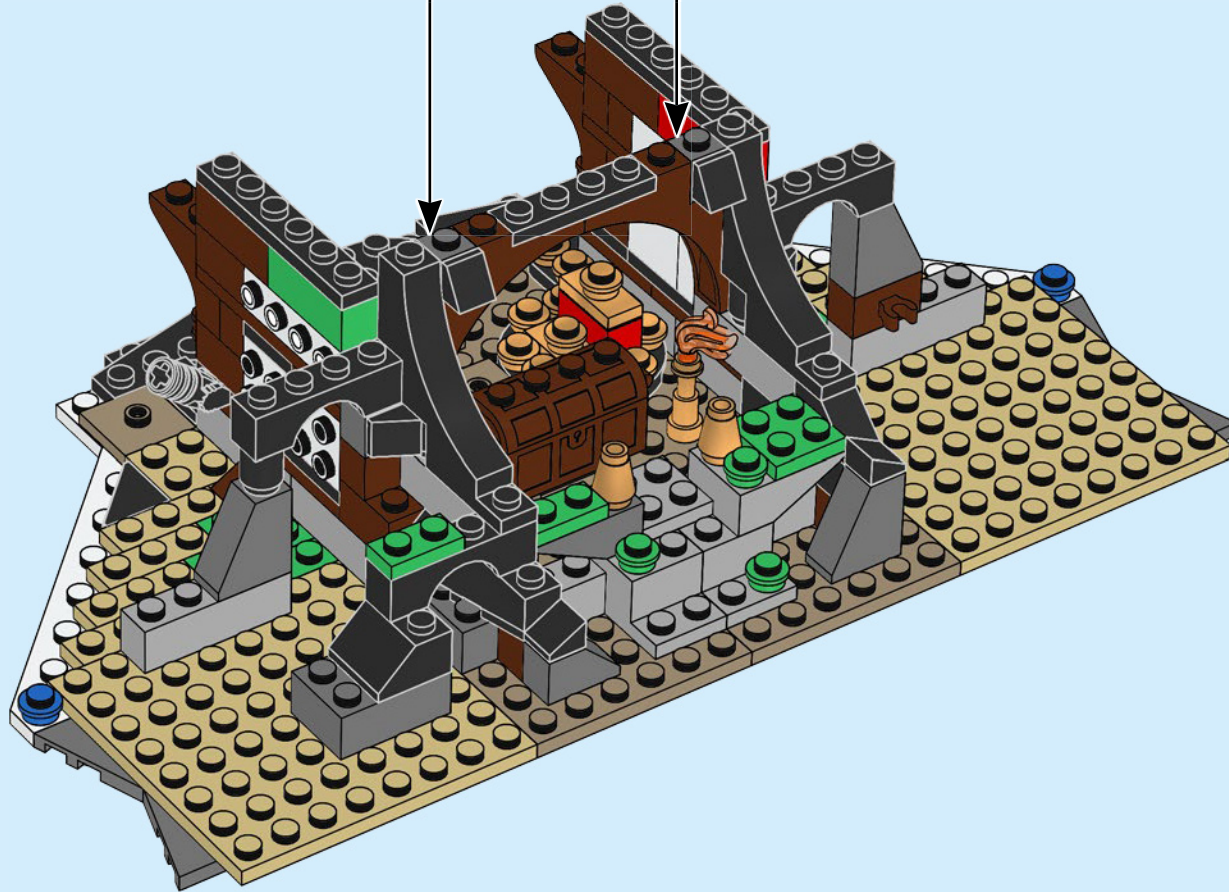

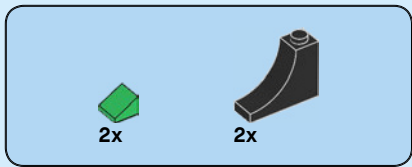

40

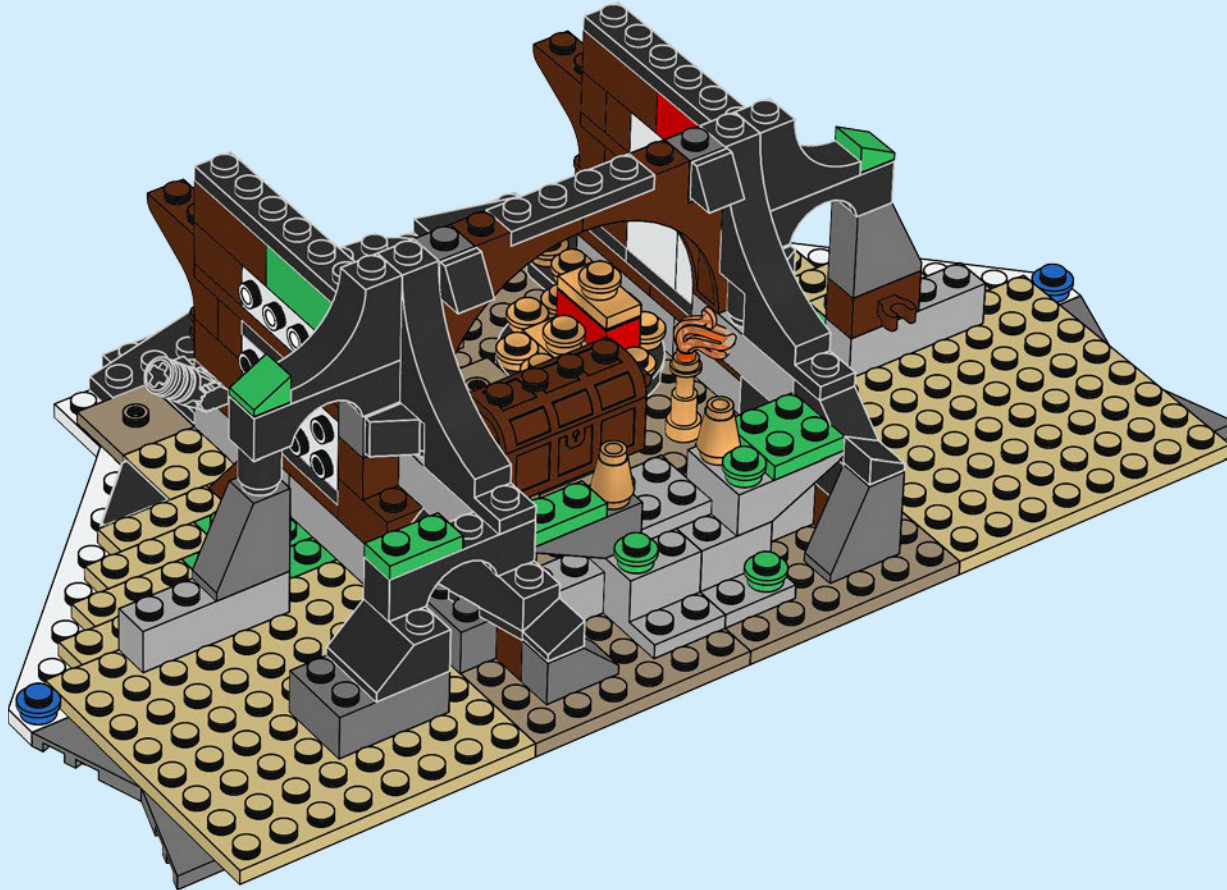

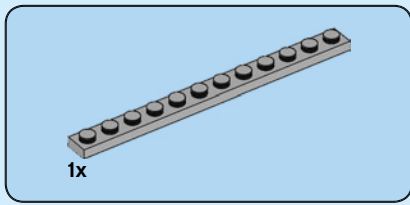

41

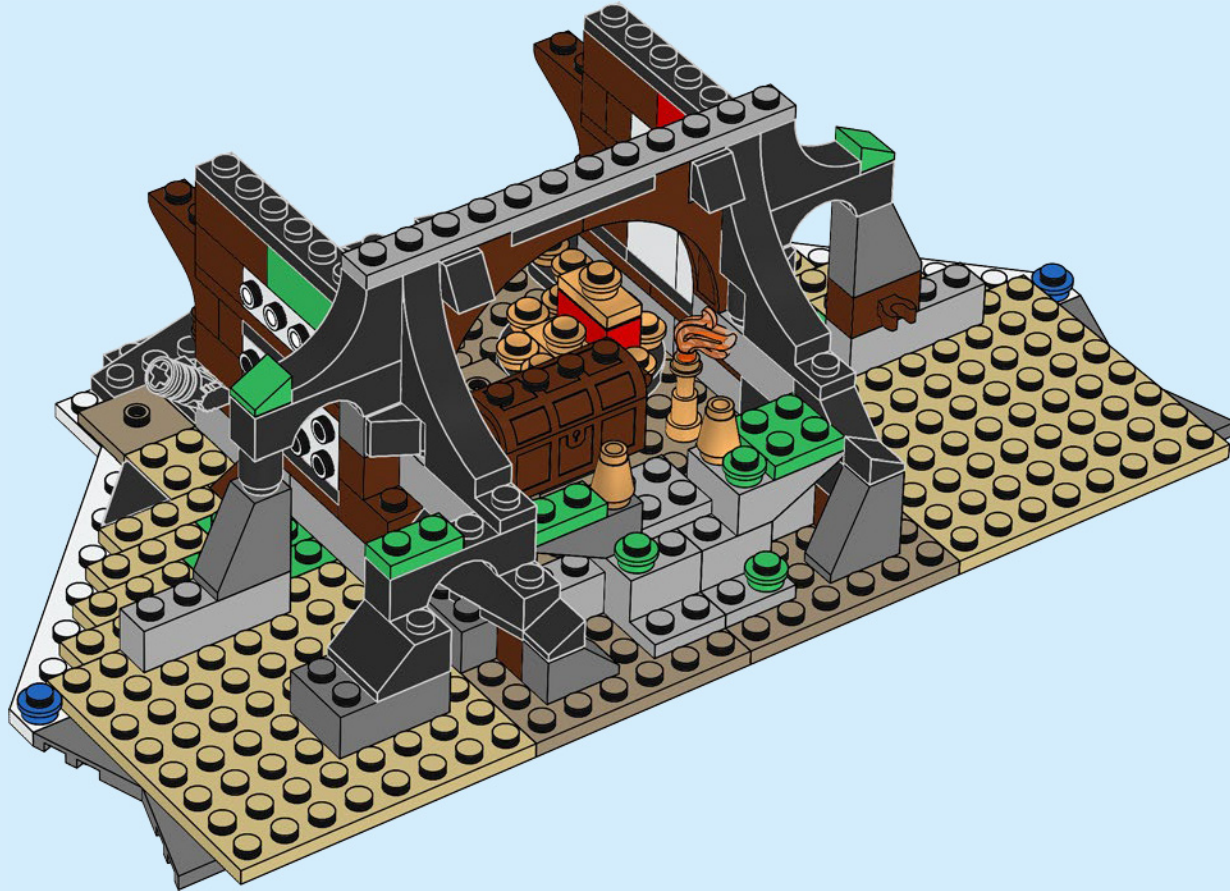

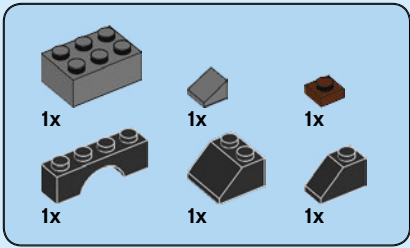

42

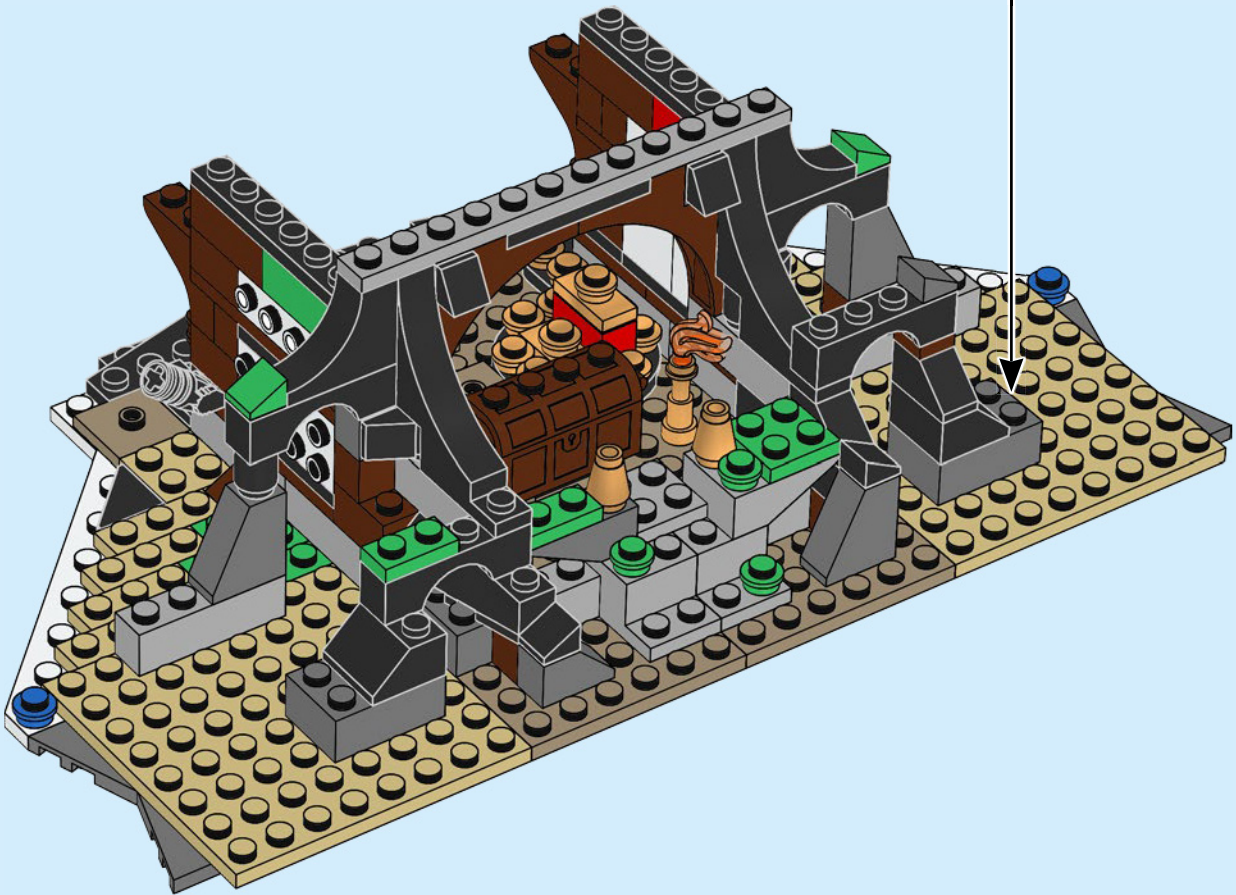
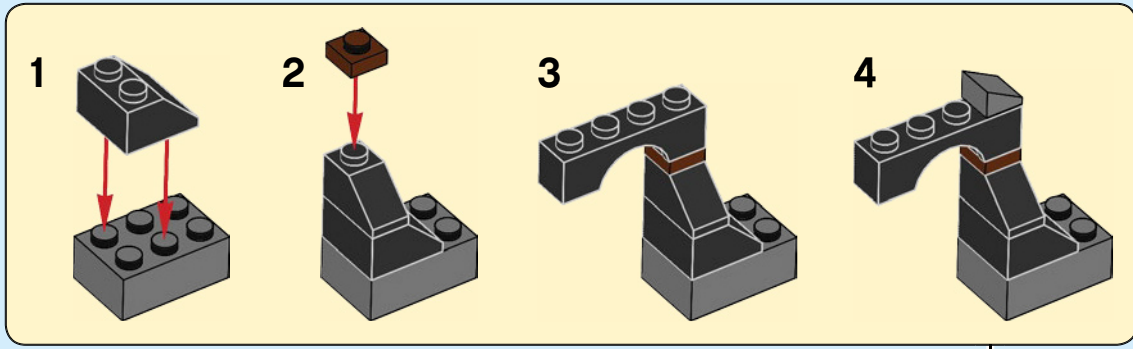

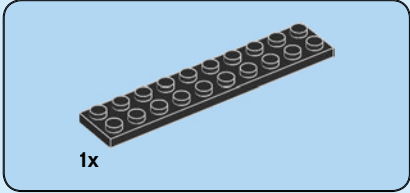
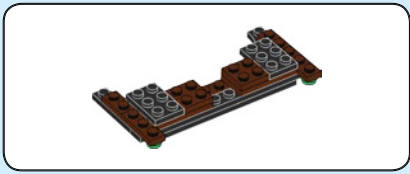

43

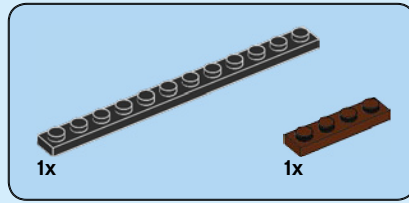
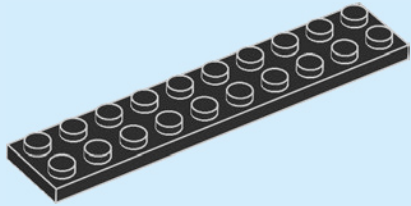

44

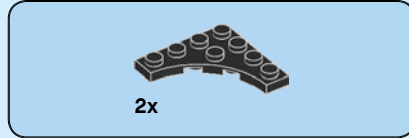
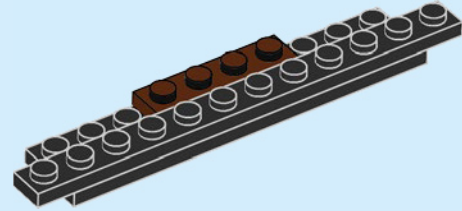

45

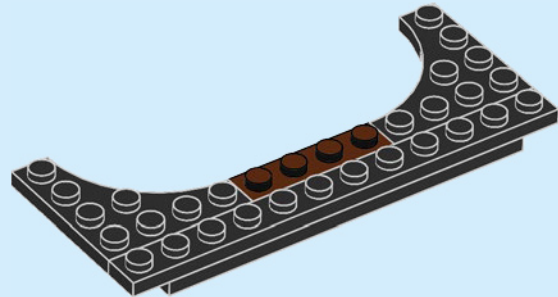

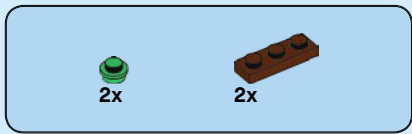

46

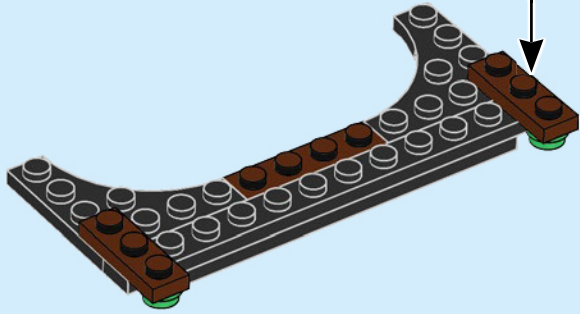
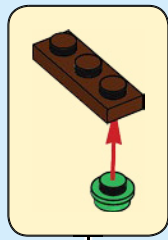

47

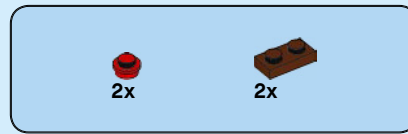
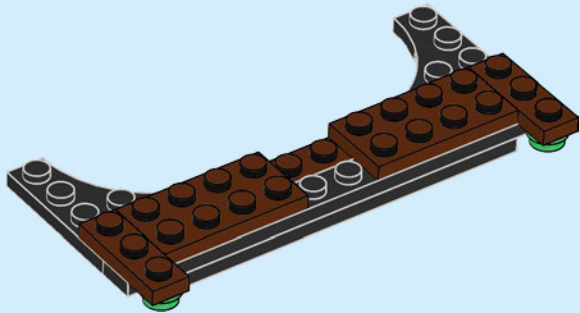

48

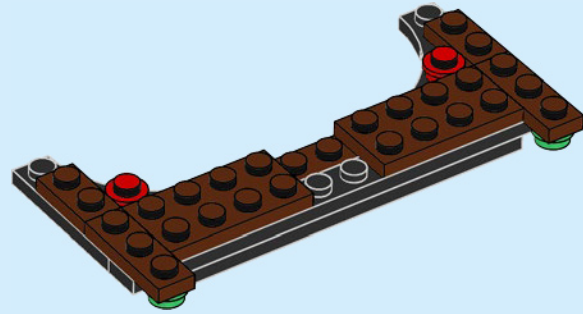

49

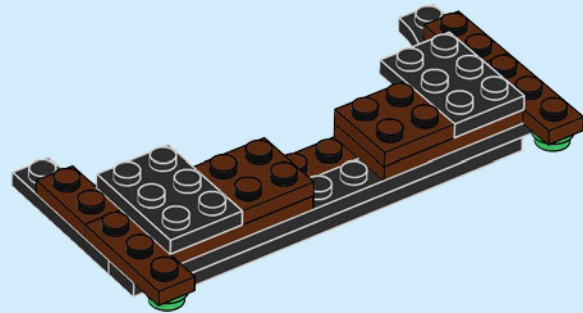

50

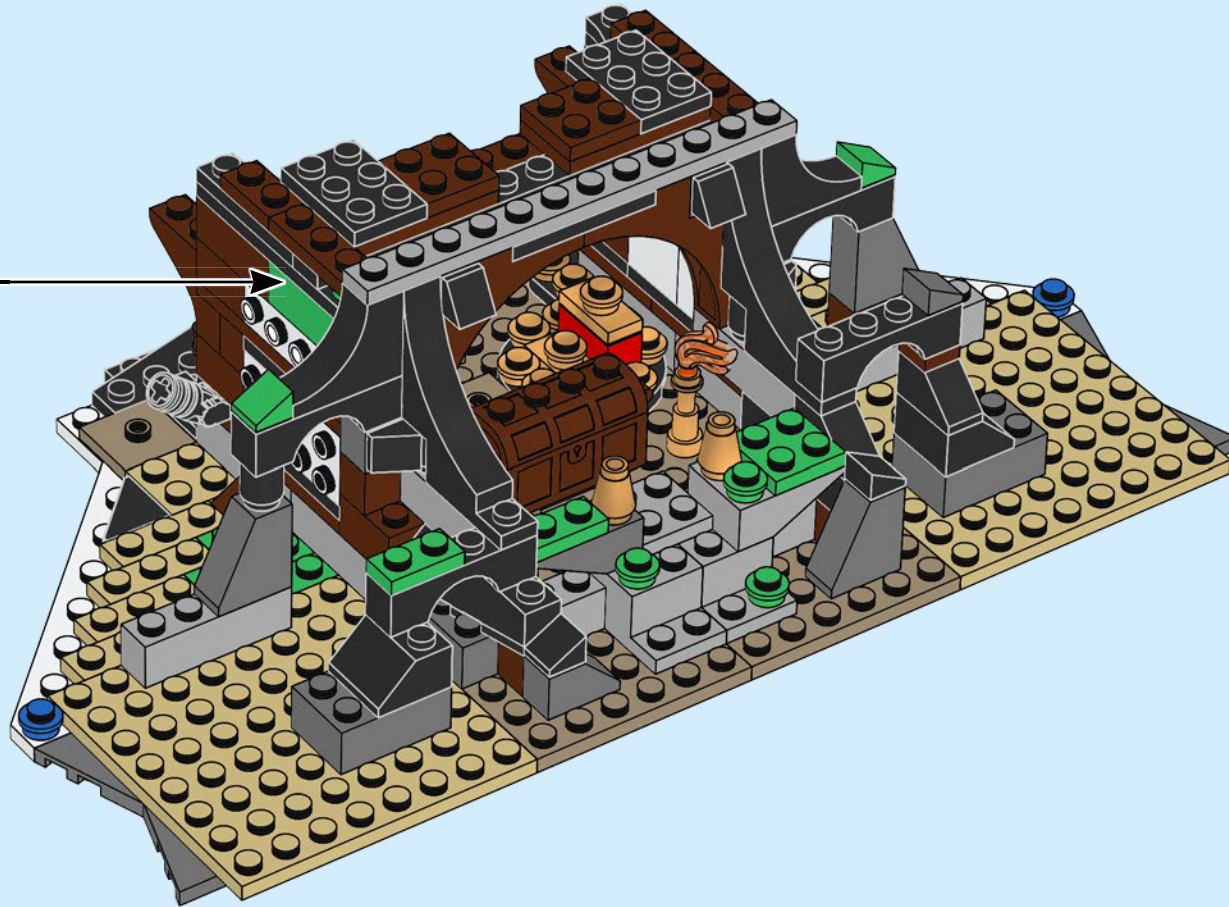

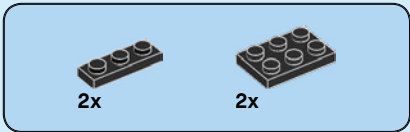

51

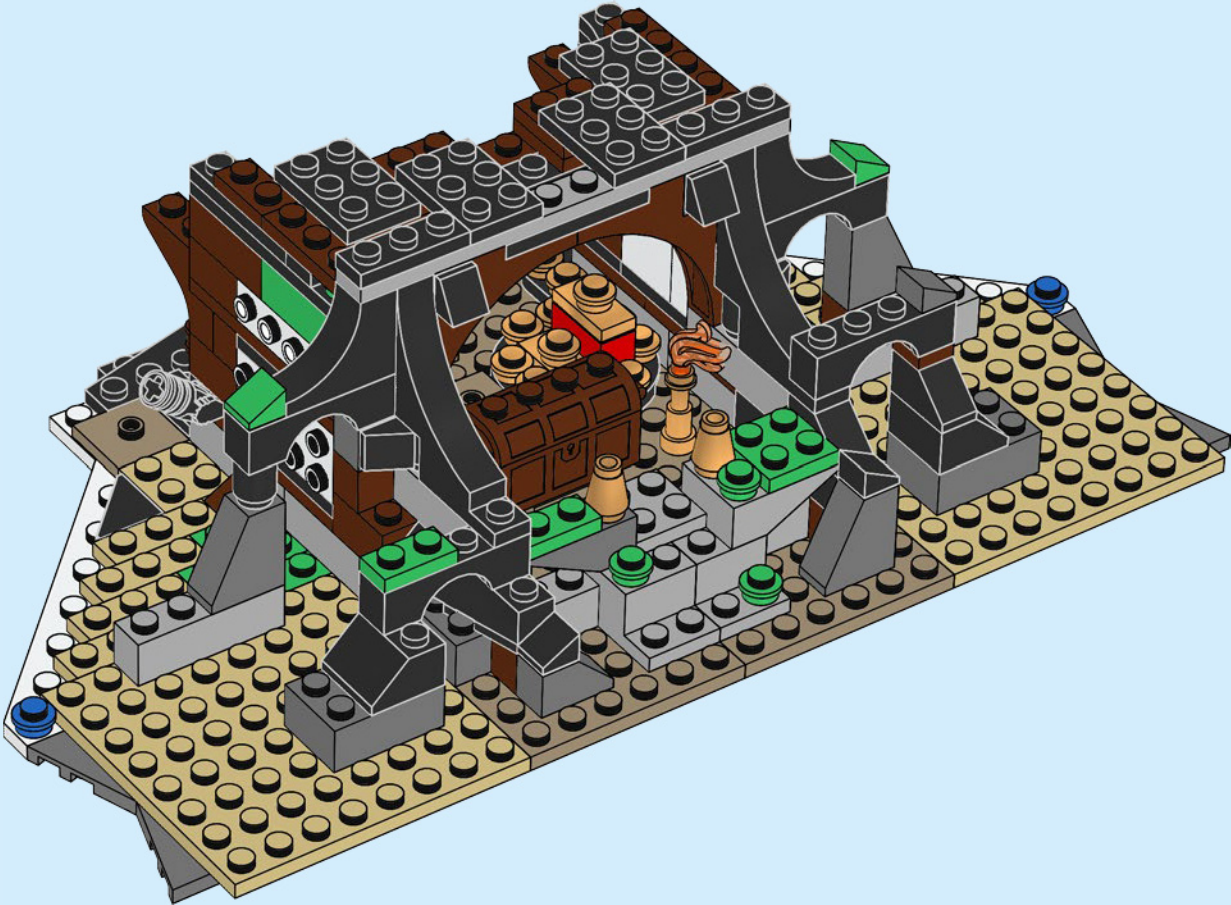

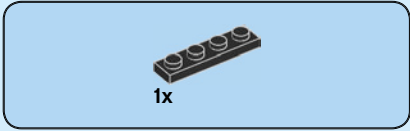
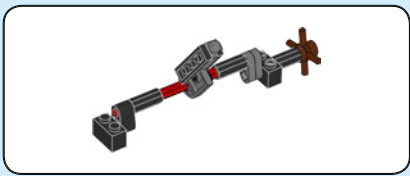

52

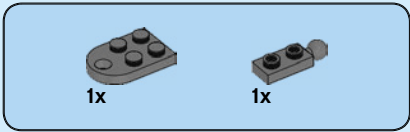
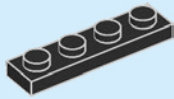

53

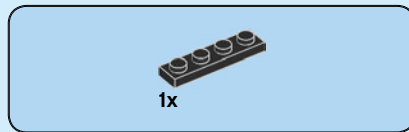
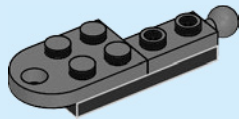

54

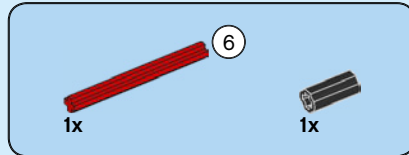
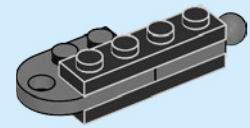

55

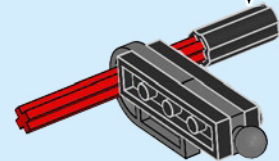
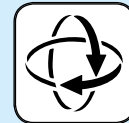
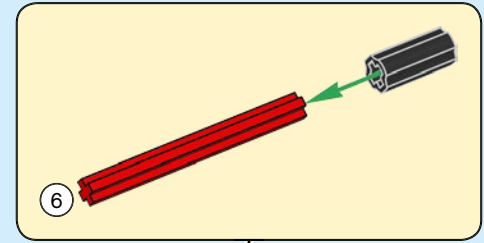



1x

56

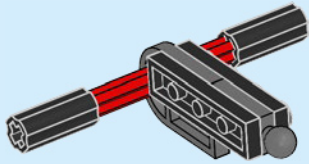

2x

57

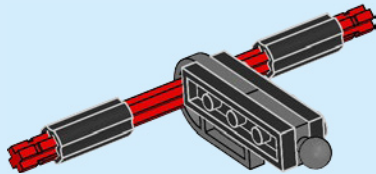

2x



1x

58

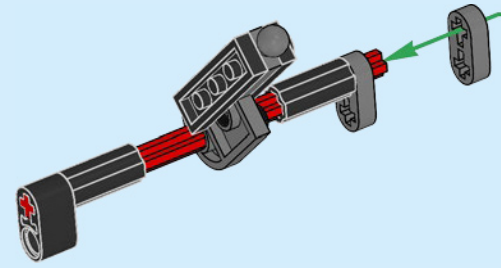

1x

59

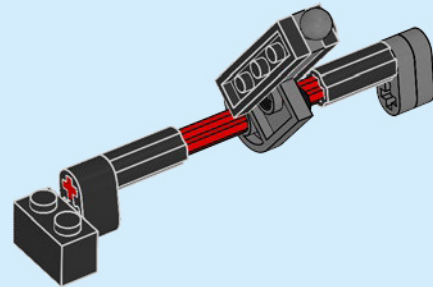

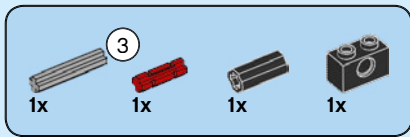

60

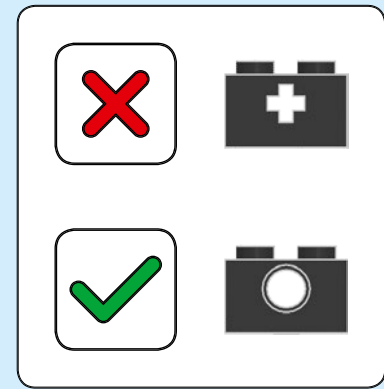
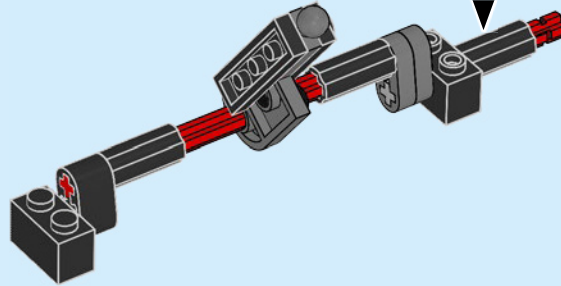
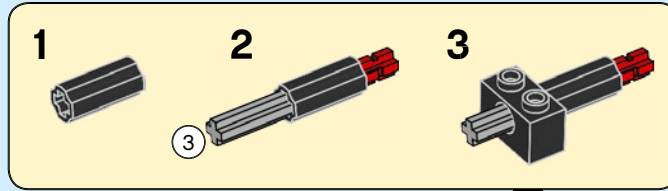
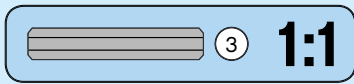

61

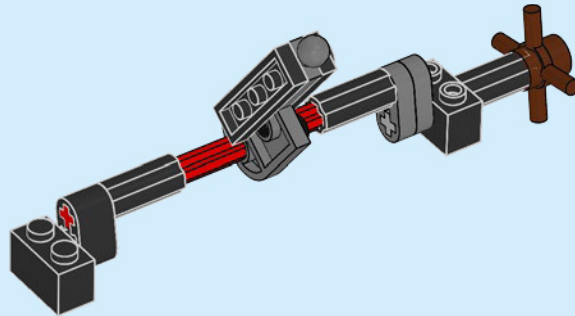

62

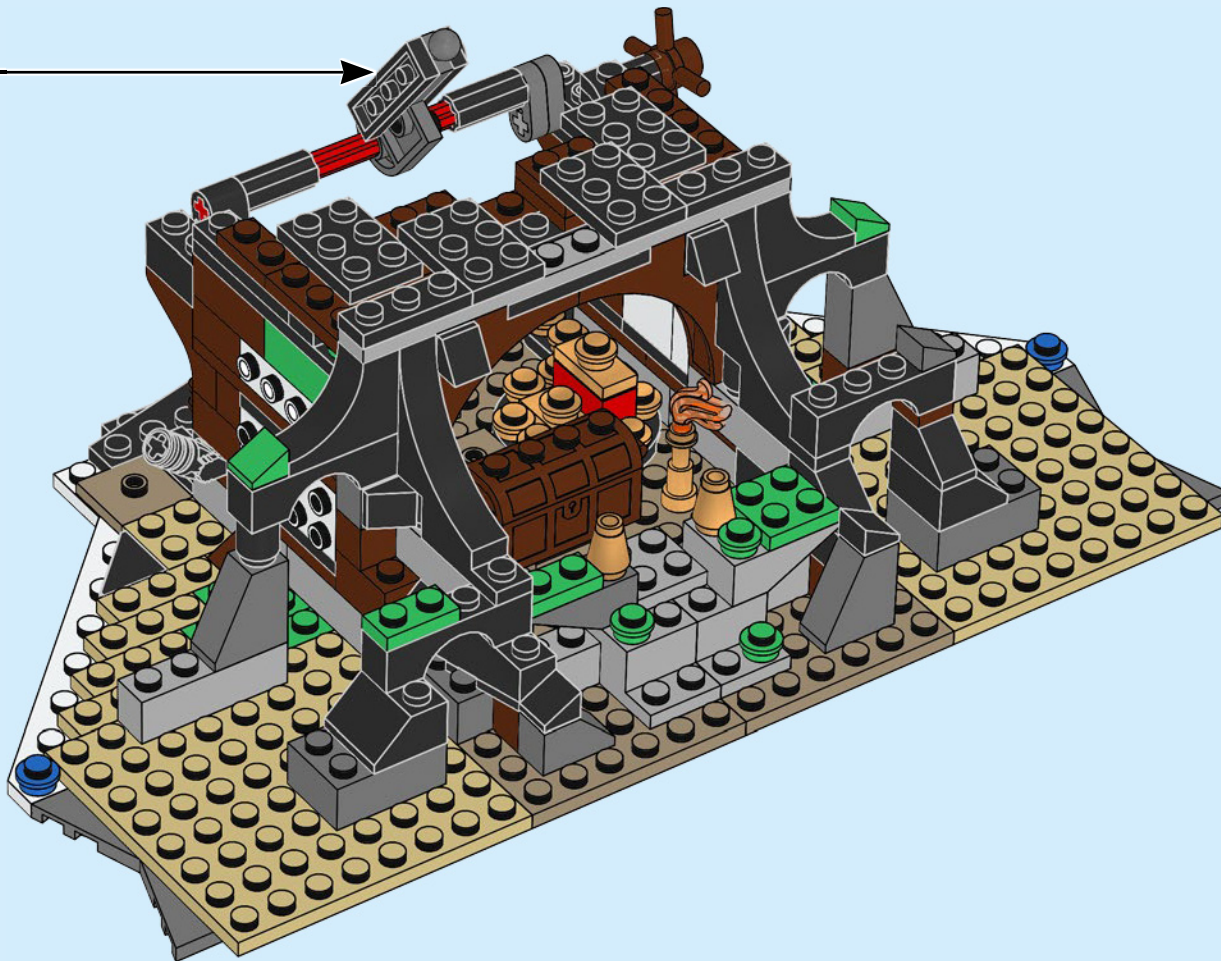









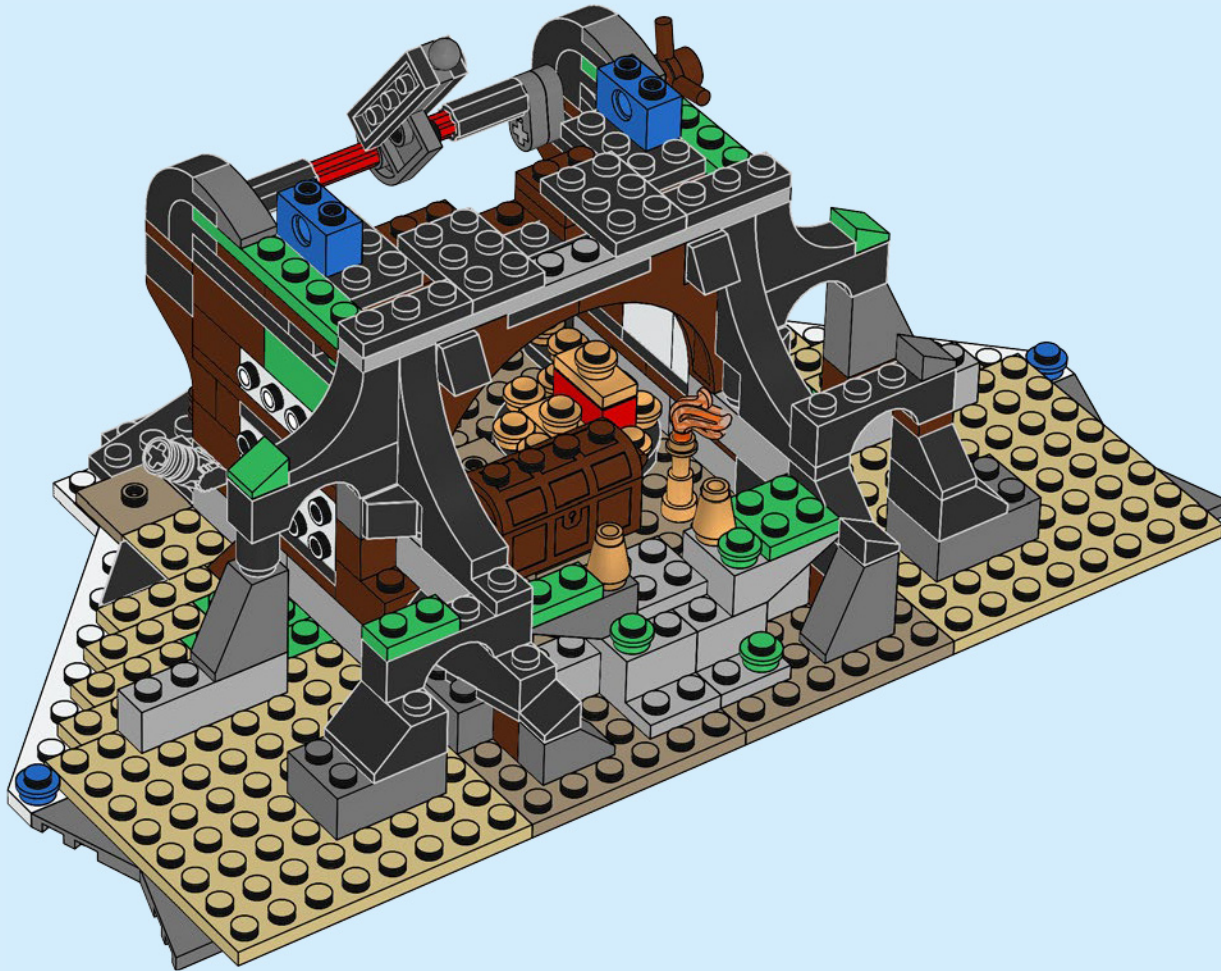

2x

64



4x  2x 

65

1  2   
   2x

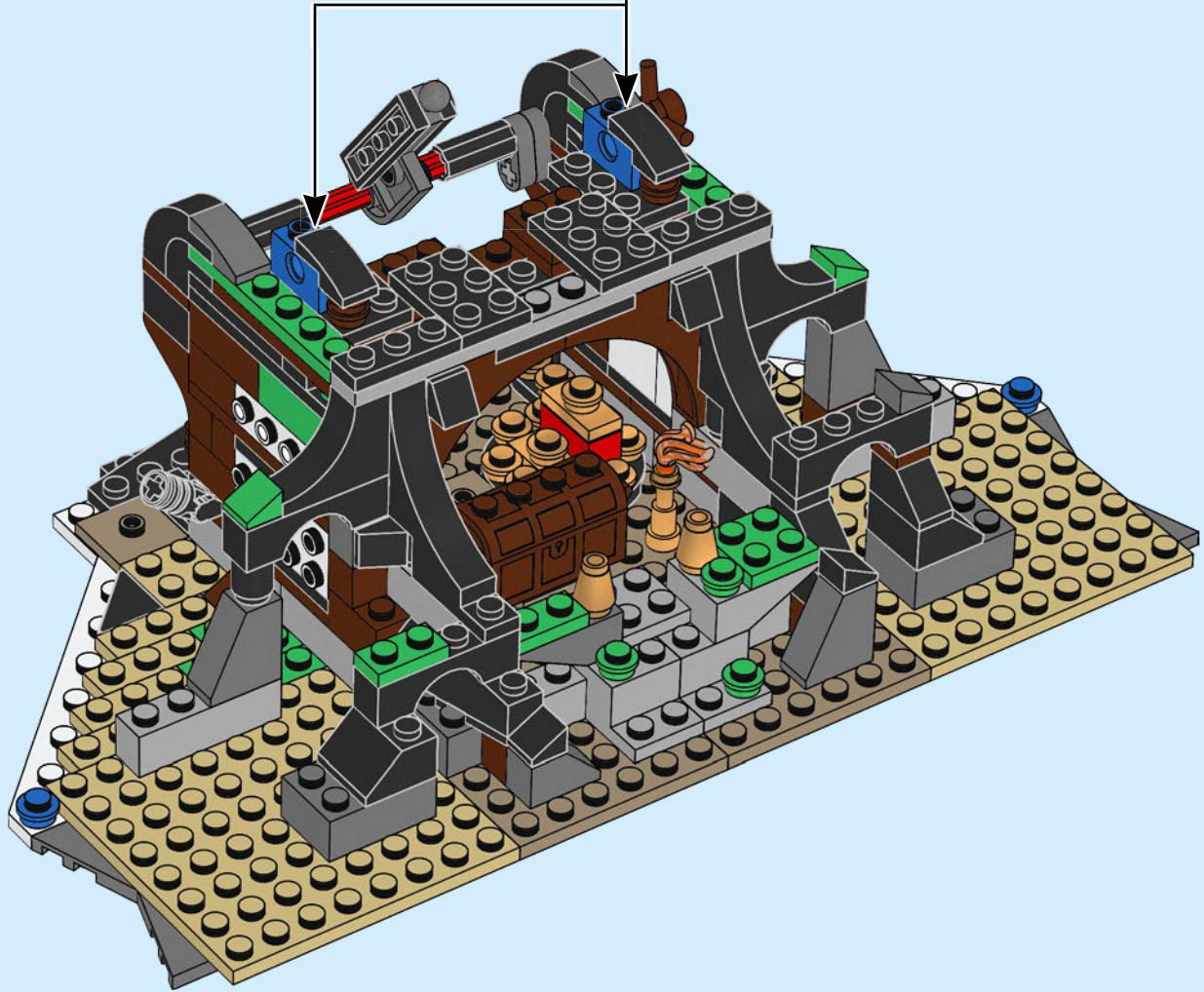

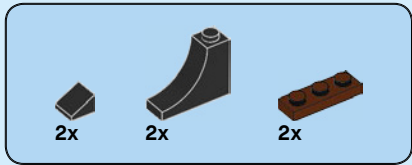

66

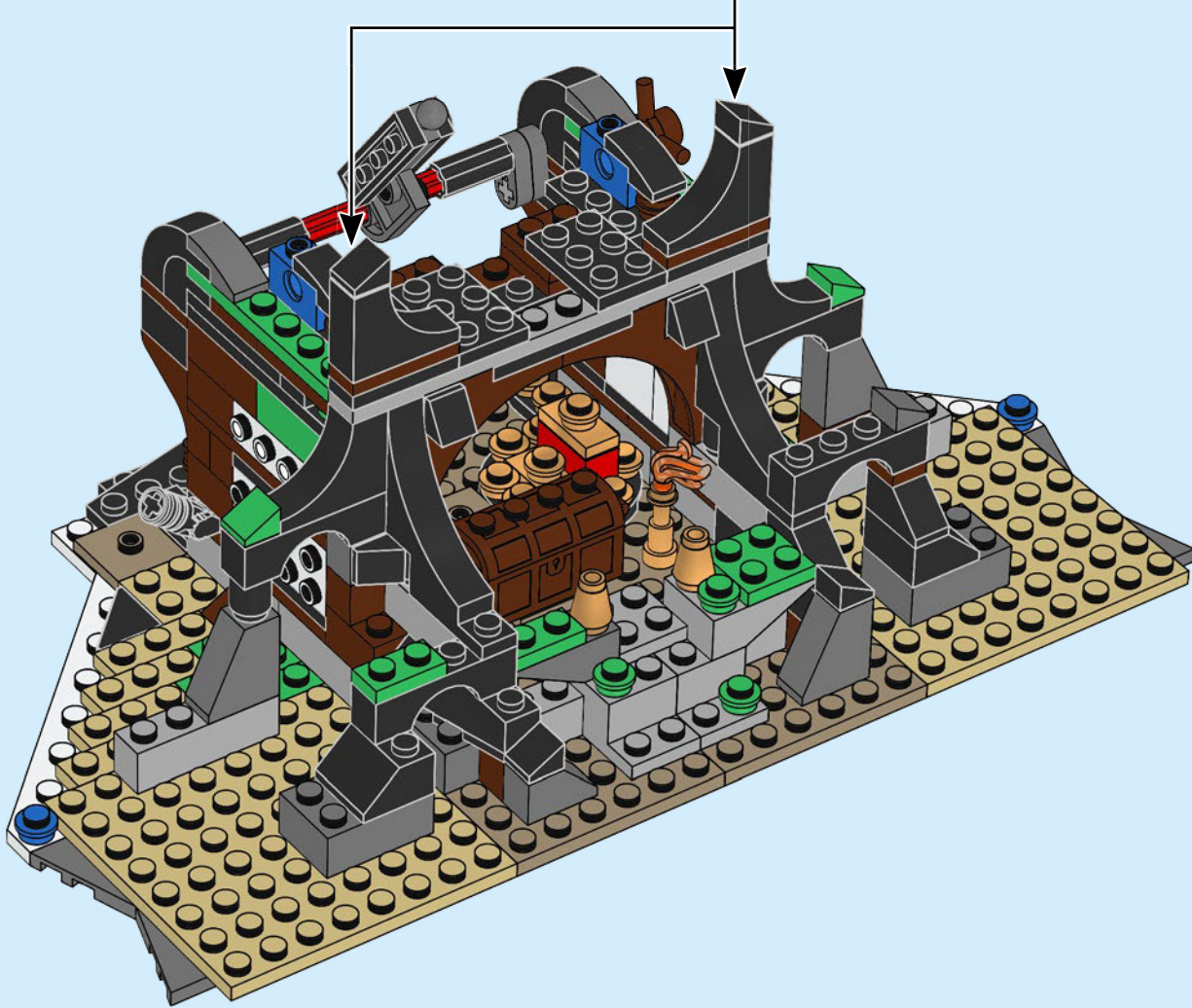
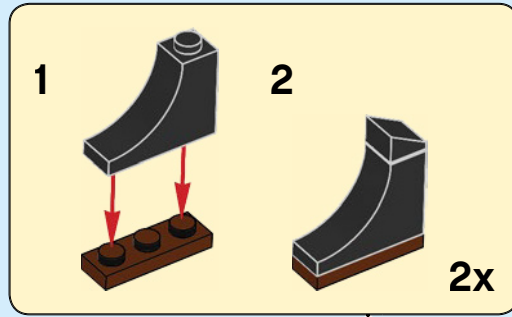

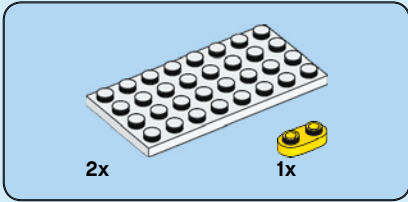
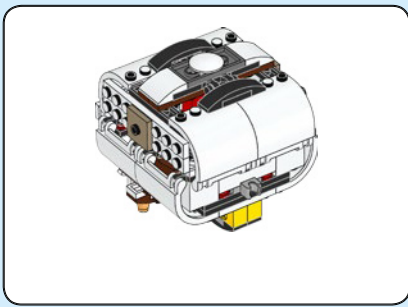

67

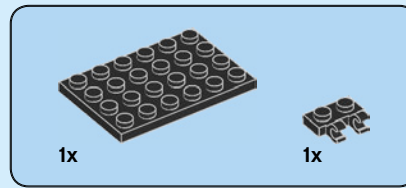
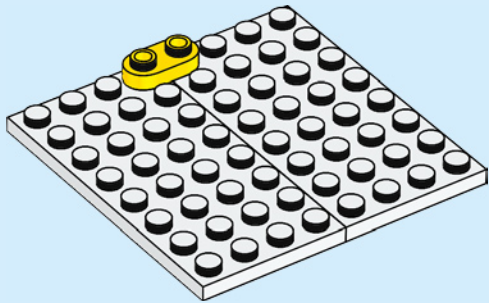

68

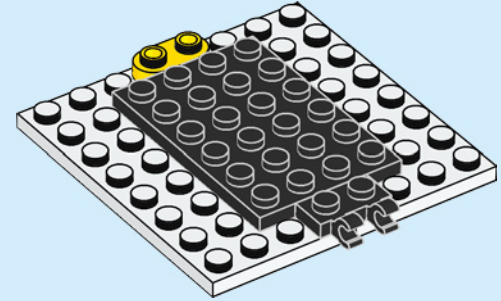

69

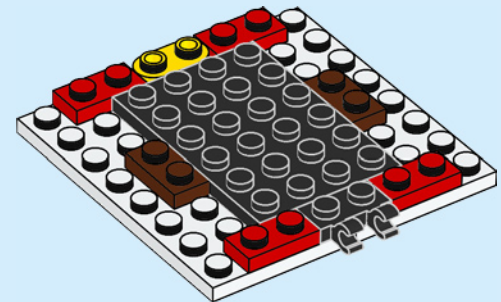



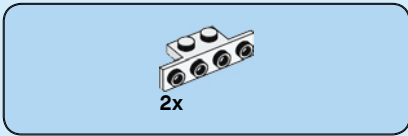

73

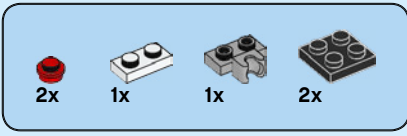
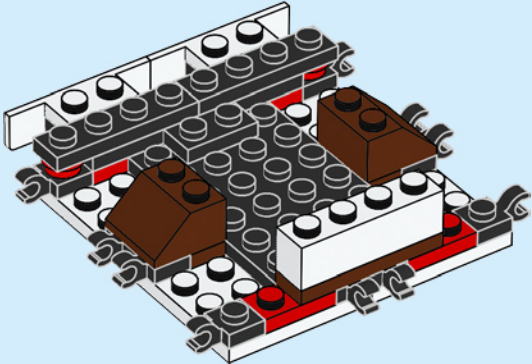

74

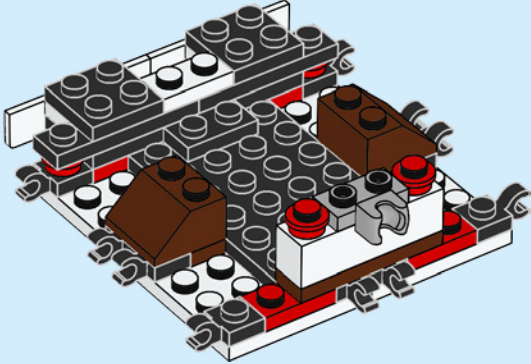

75

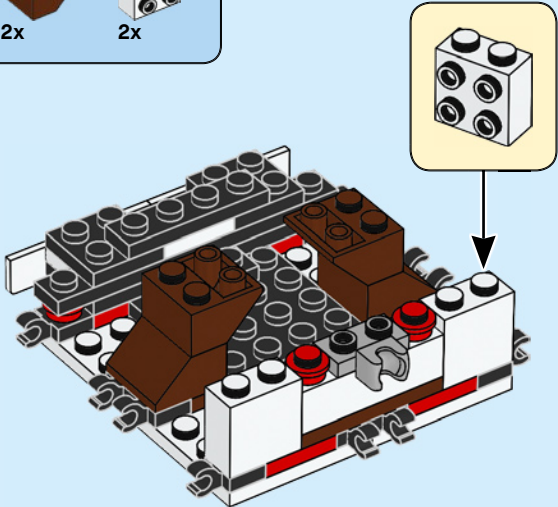

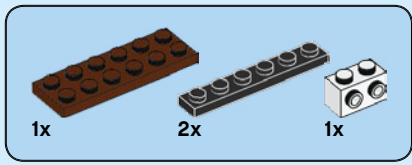

76

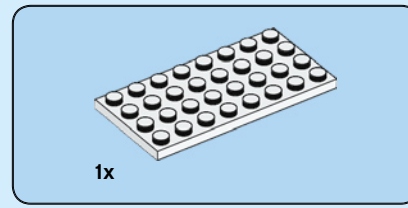
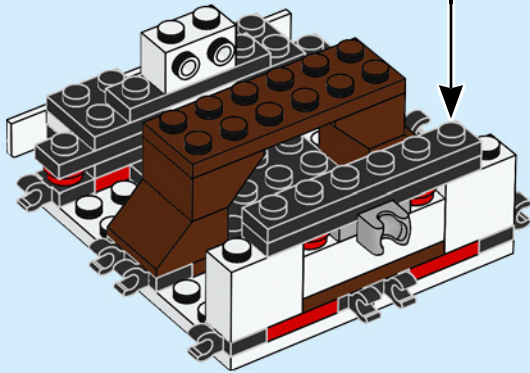
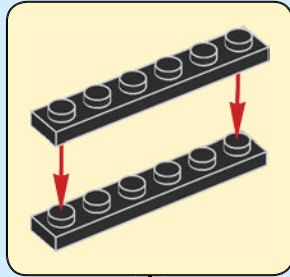

77

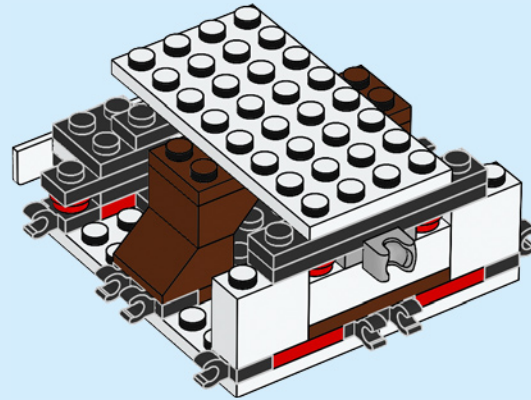

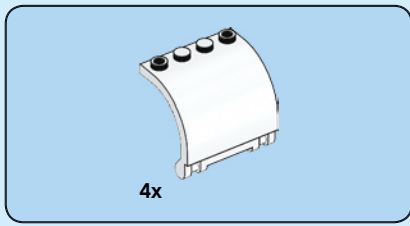

78

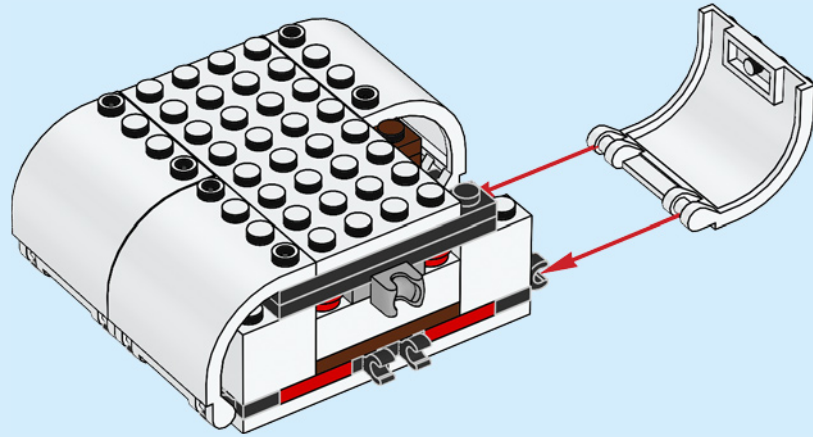

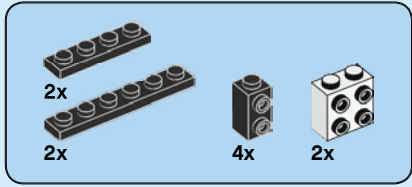
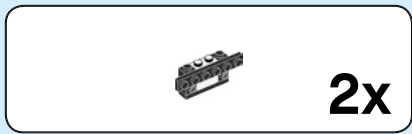

79

1

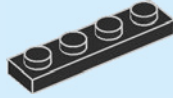

2

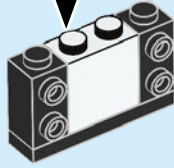
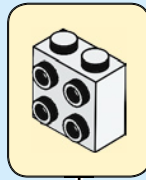

3

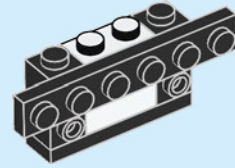

2x

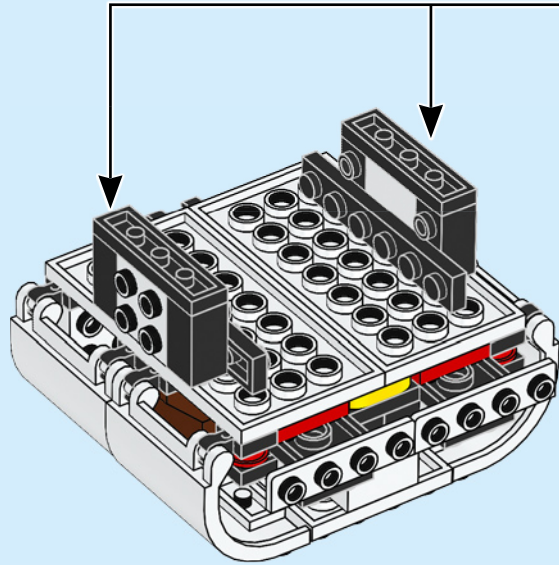

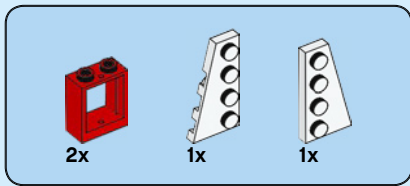

80

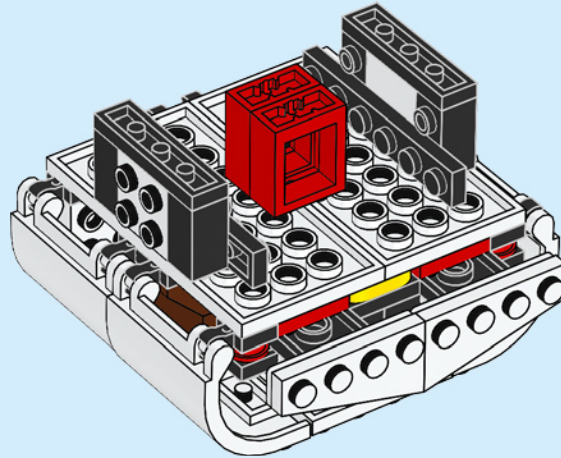

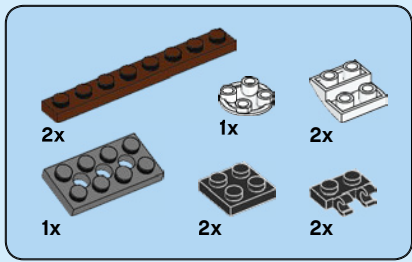

81

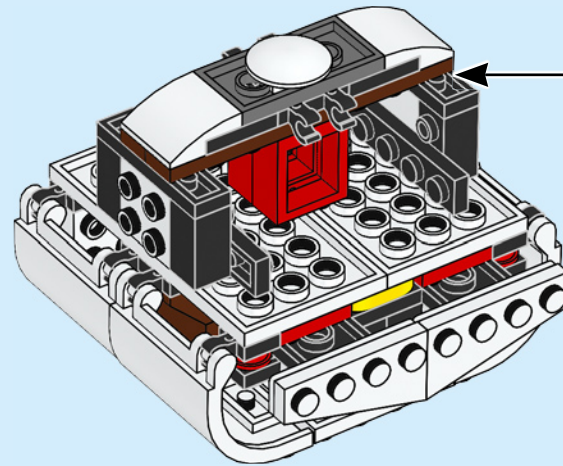
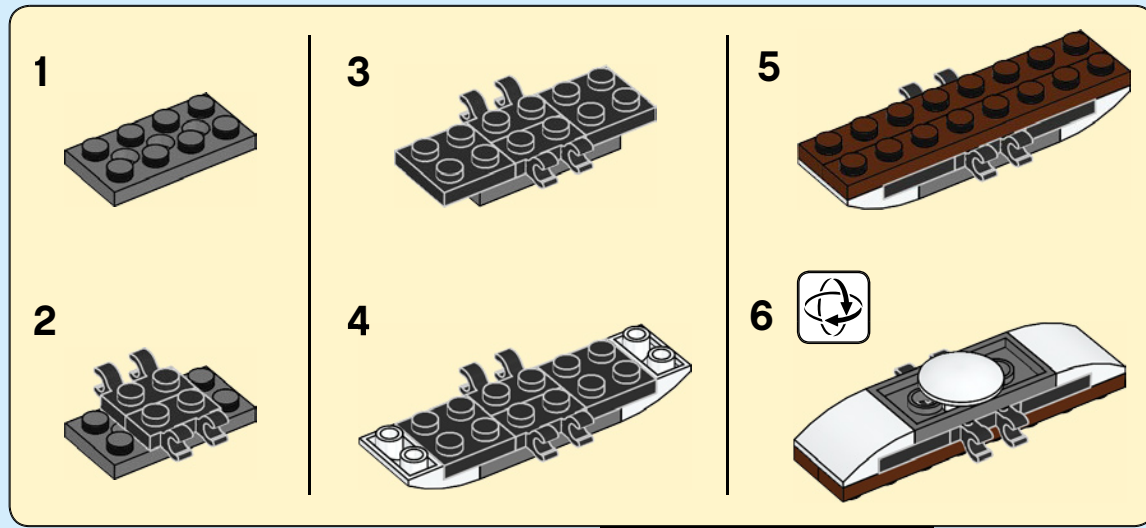

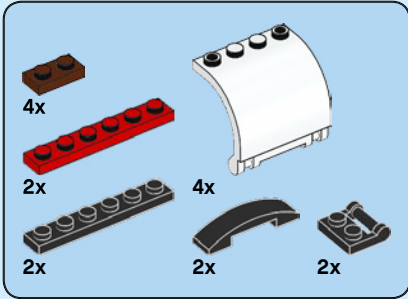
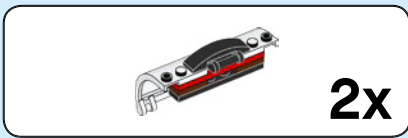

82

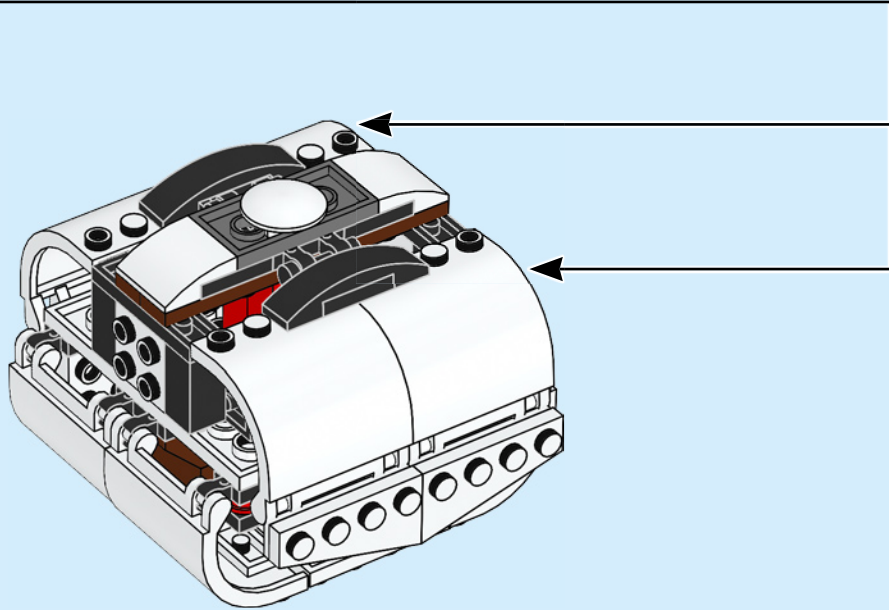
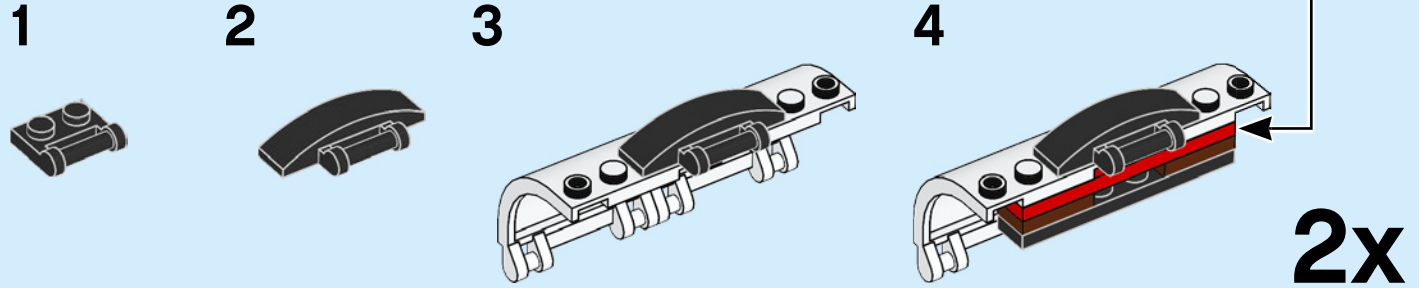
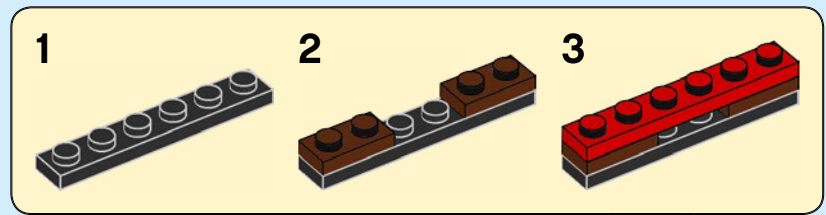

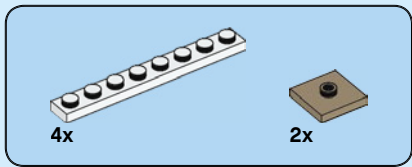

83

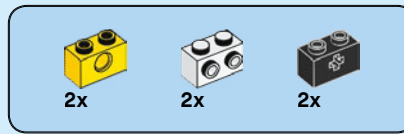
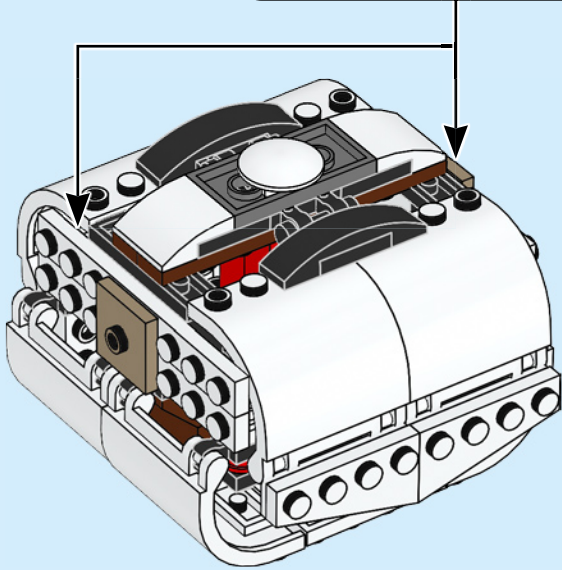
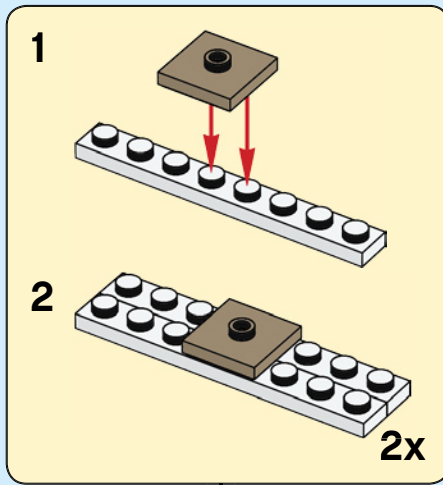

84

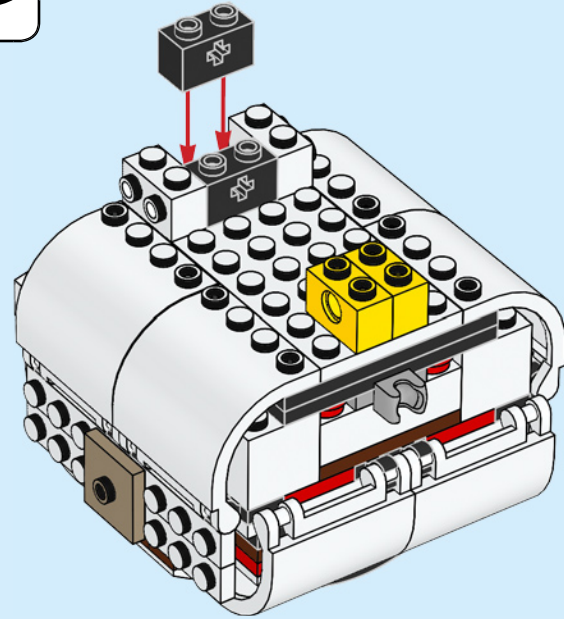

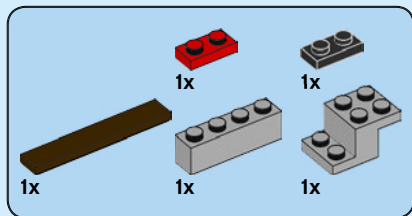

85

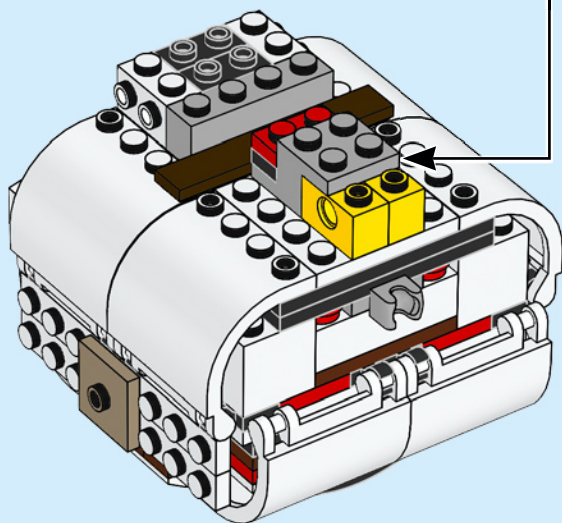
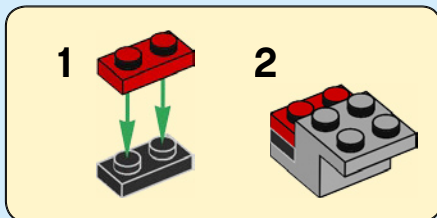

86

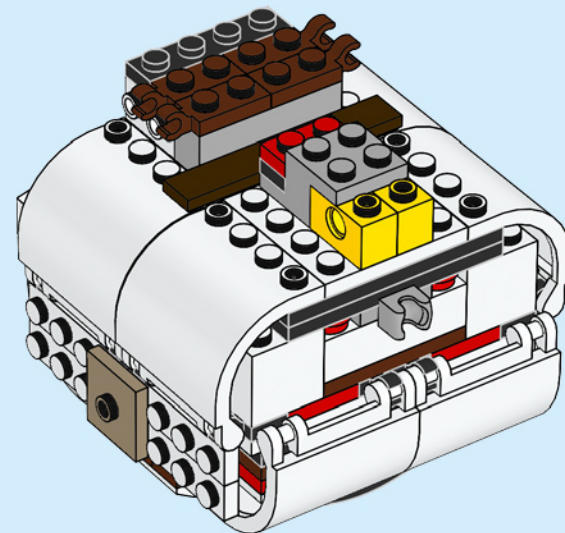



87

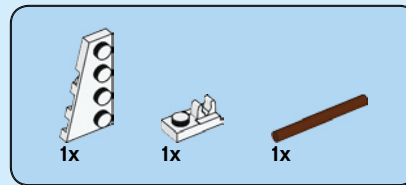
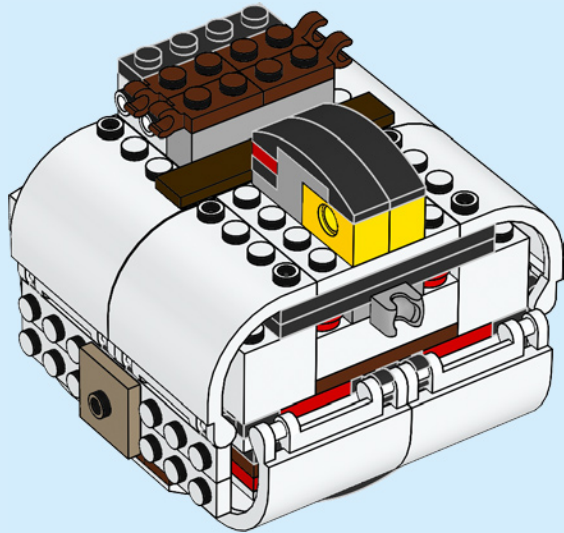

88

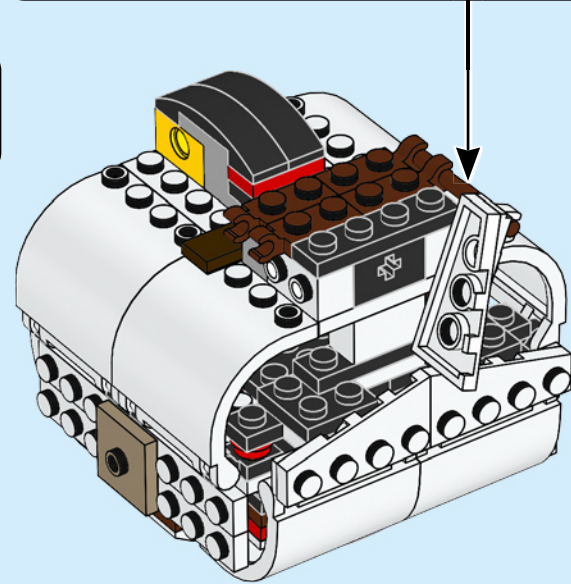
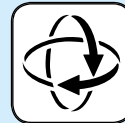
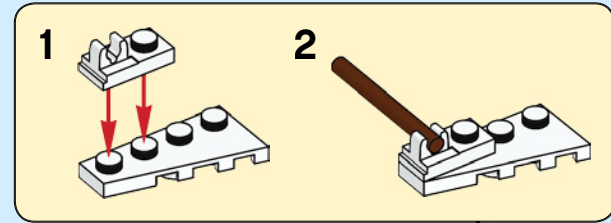

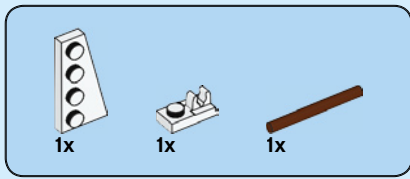

89

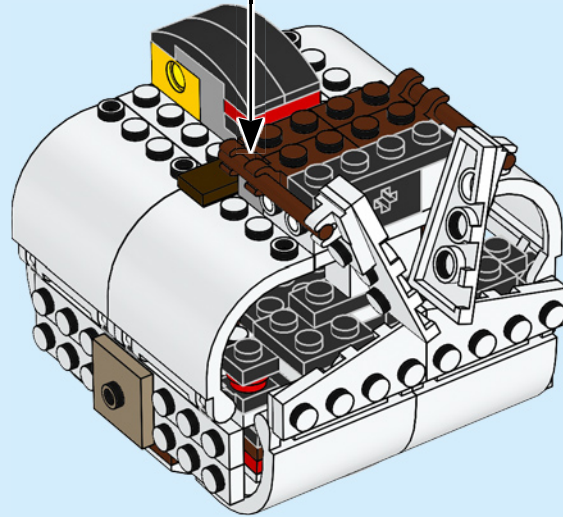
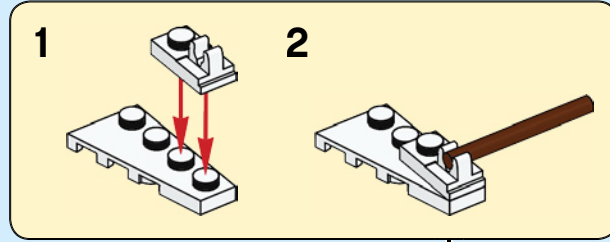

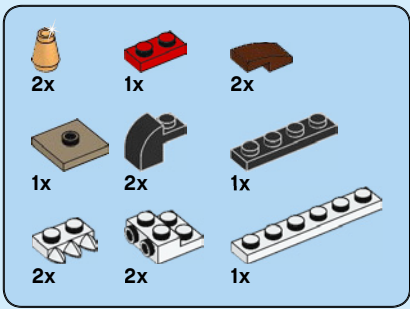

90

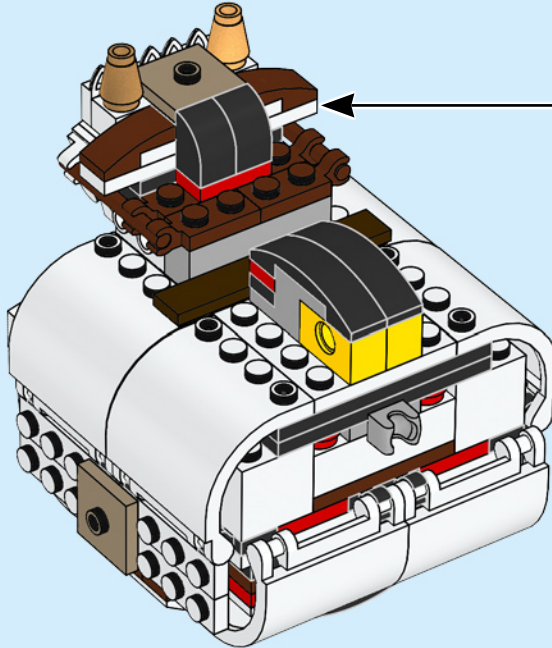
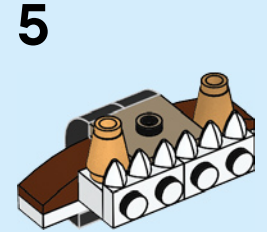
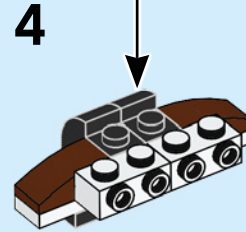
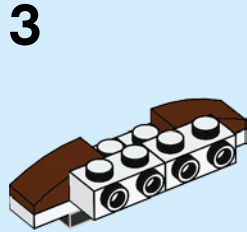
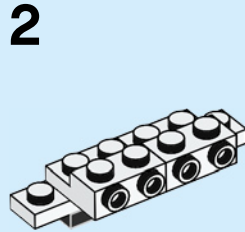
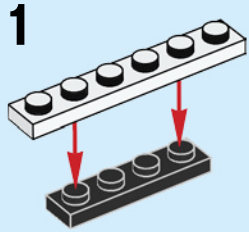
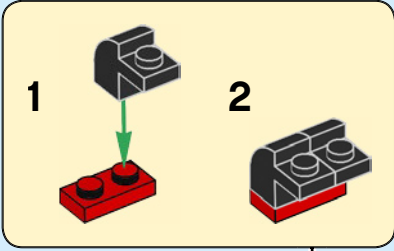

91

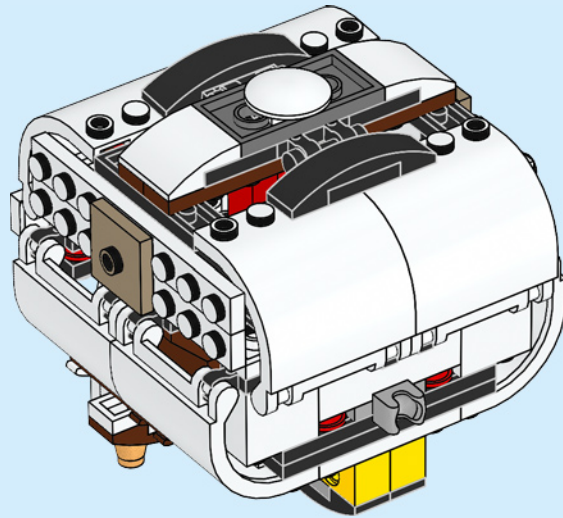

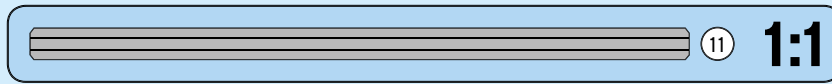
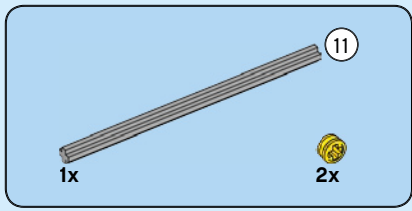

92

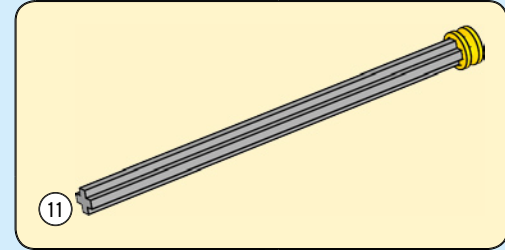
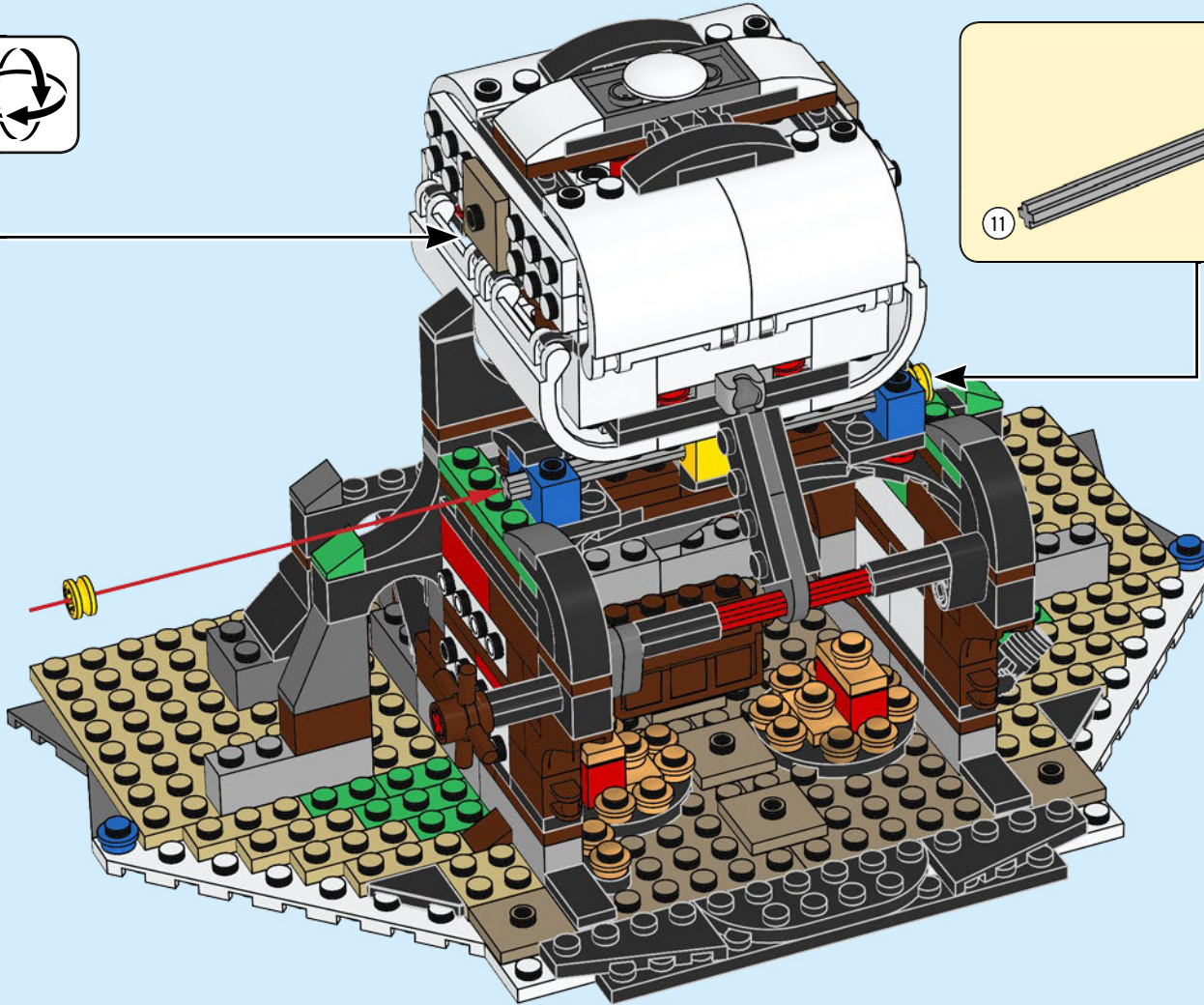

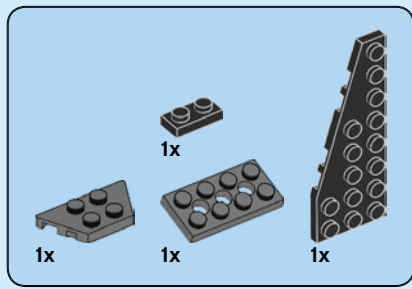

93

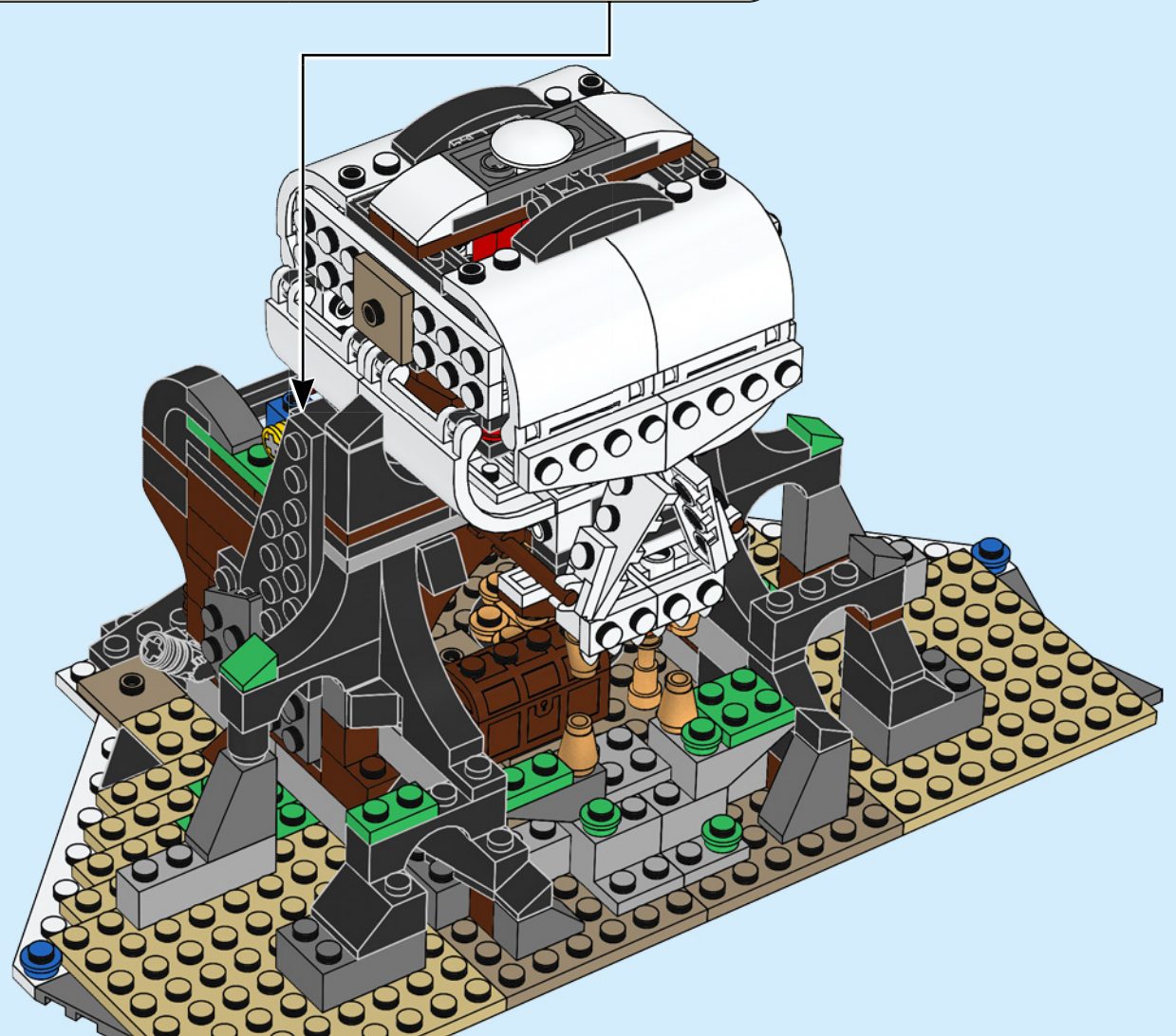
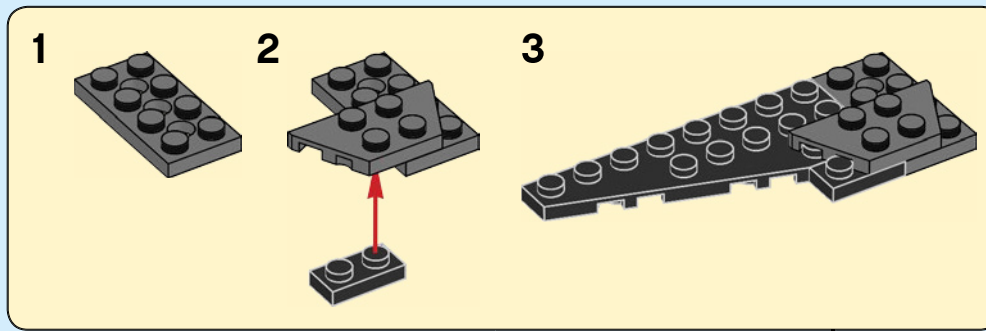

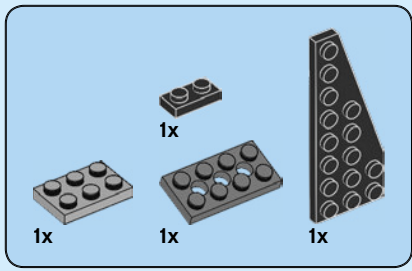

94

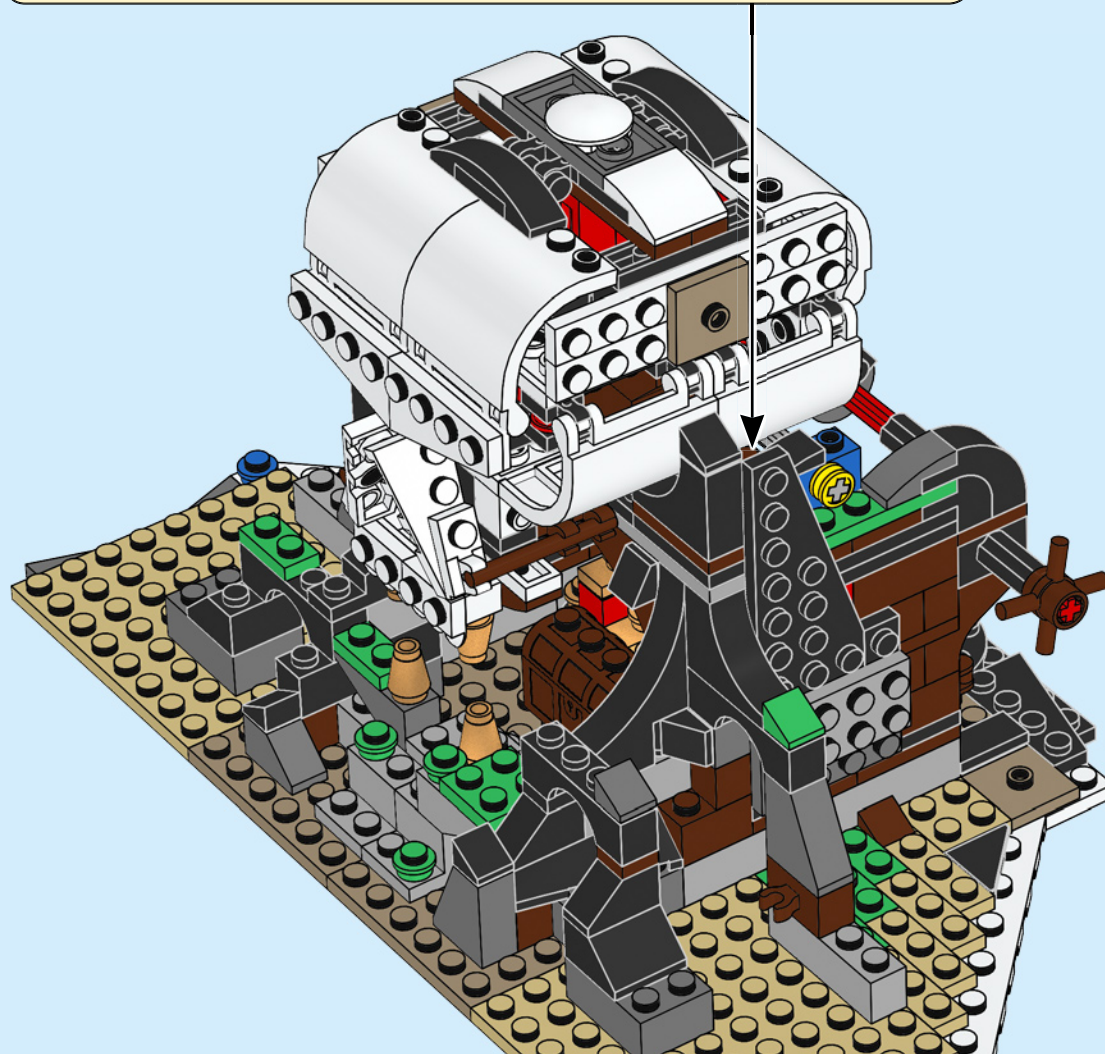
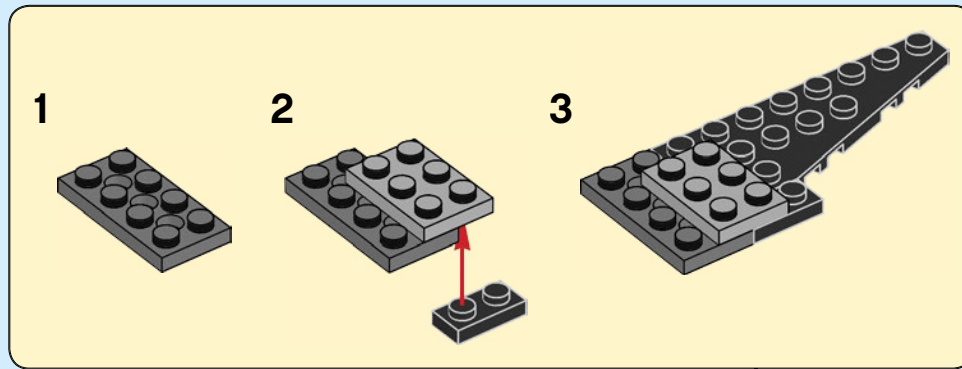

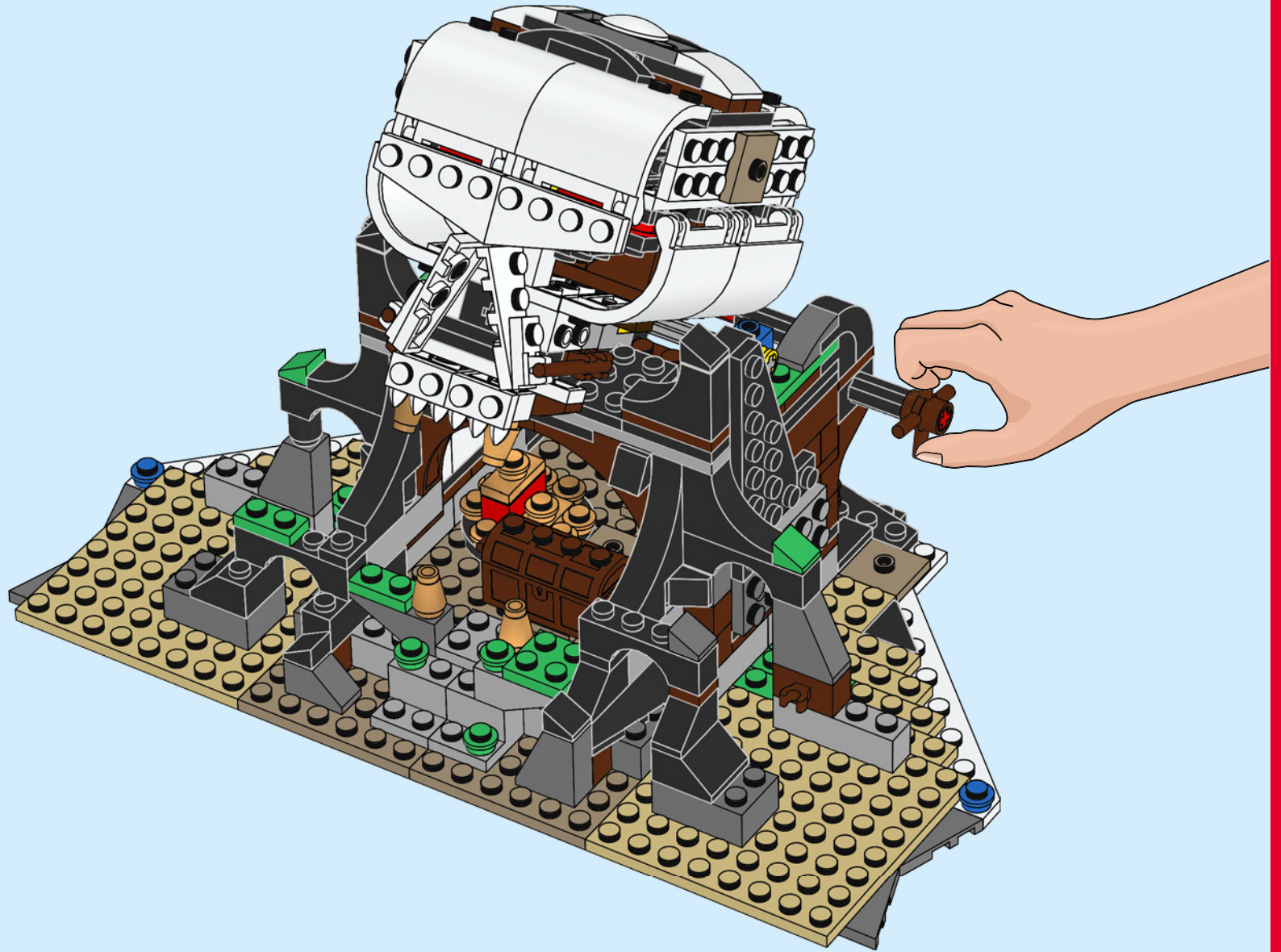

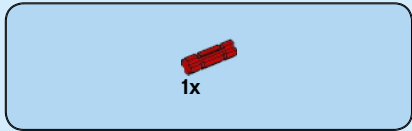
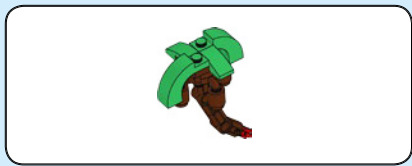

95

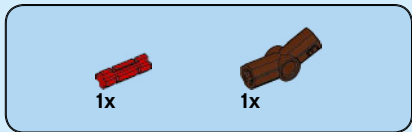

96

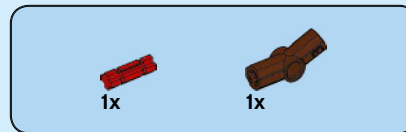
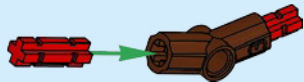

97

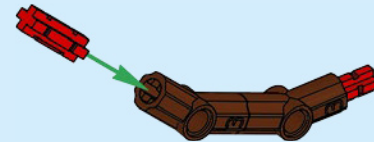

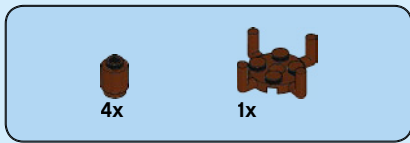

98

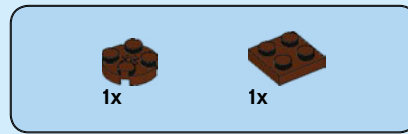
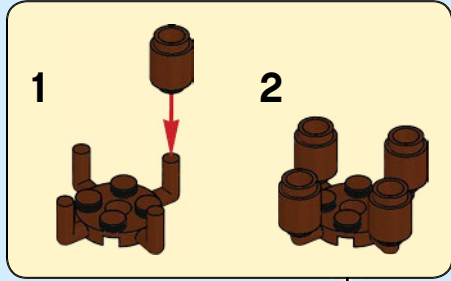

99

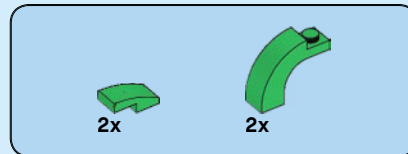
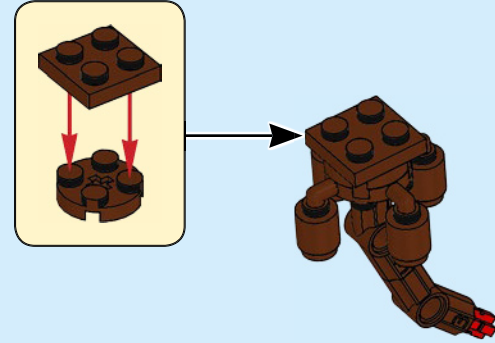

100

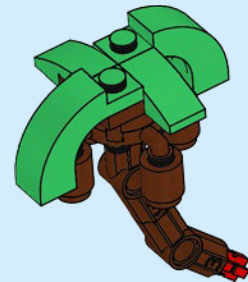

101

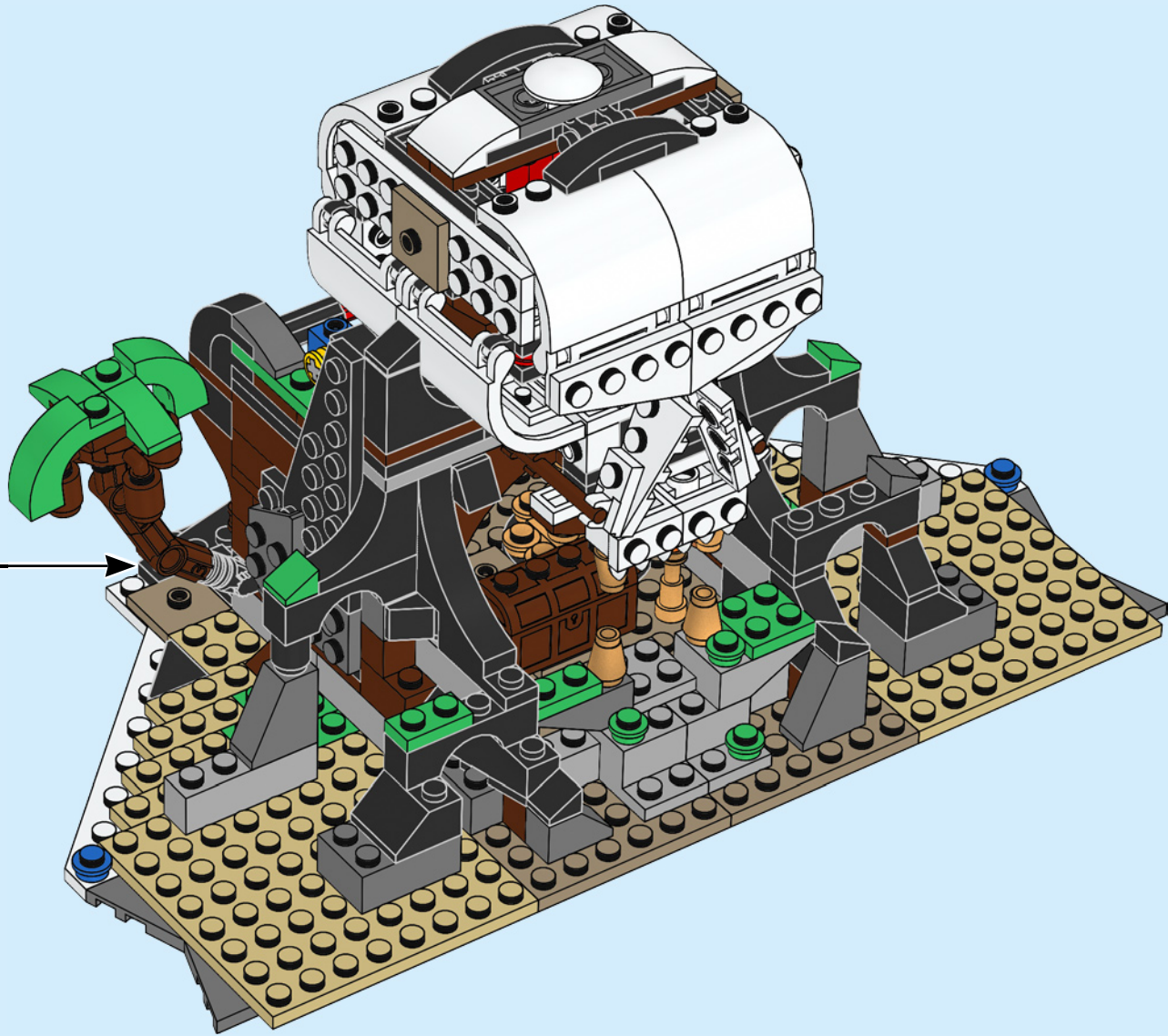

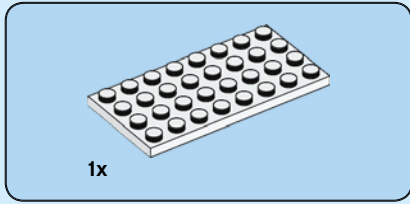
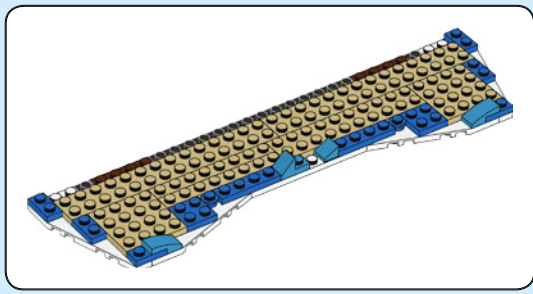

**102**

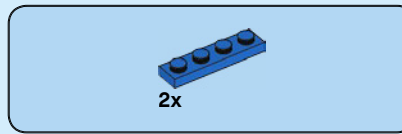
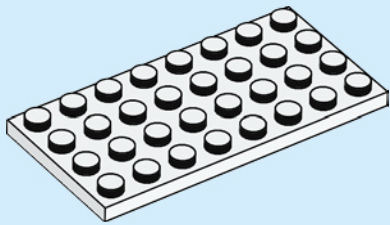

**103**

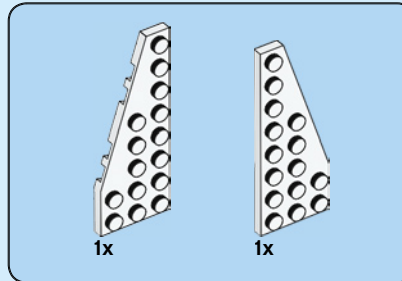
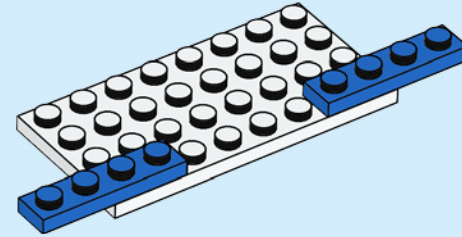

**104**

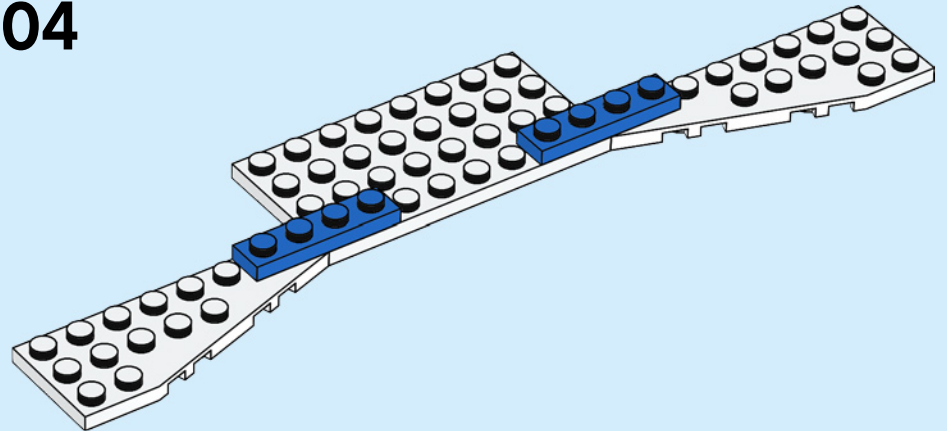

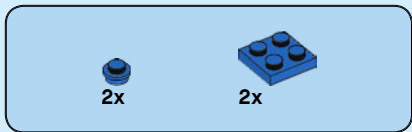

105

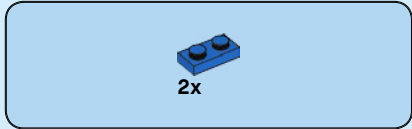
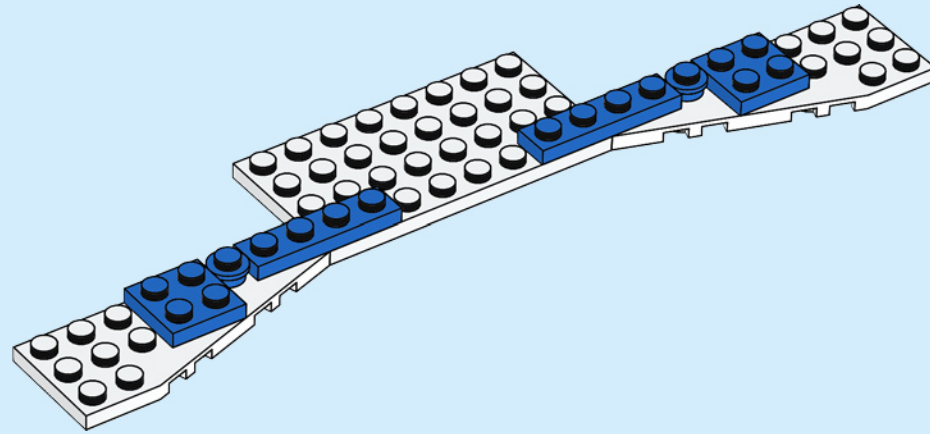

106

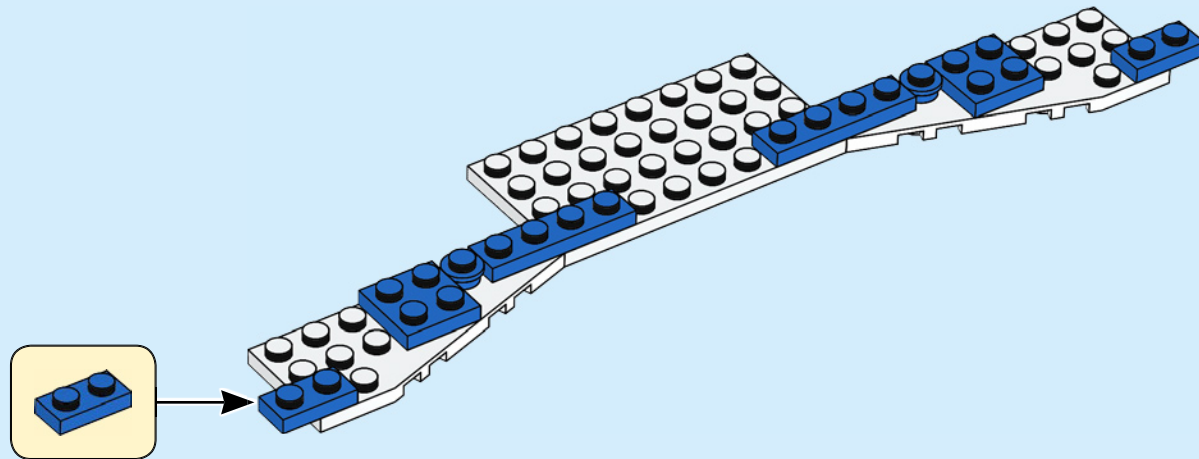

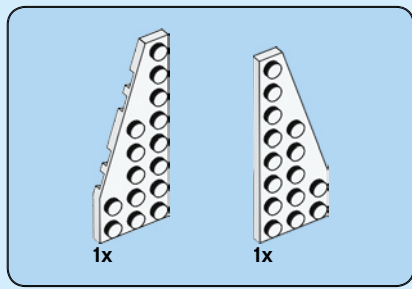

107

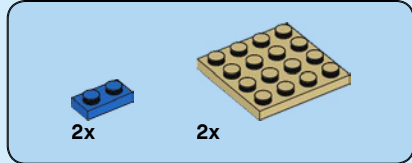
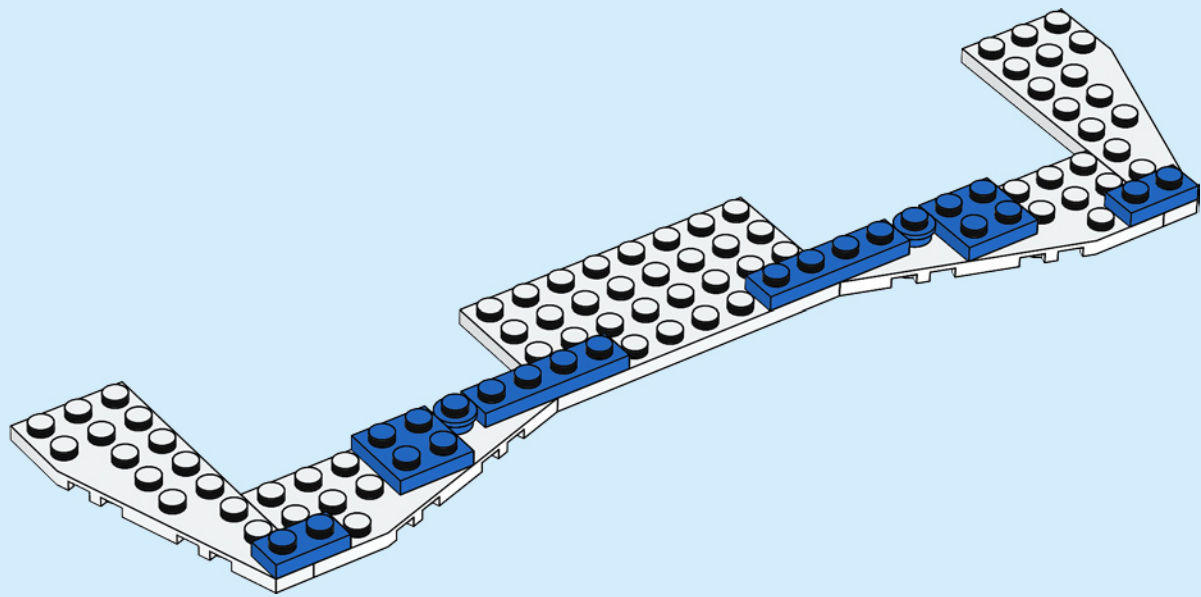

108

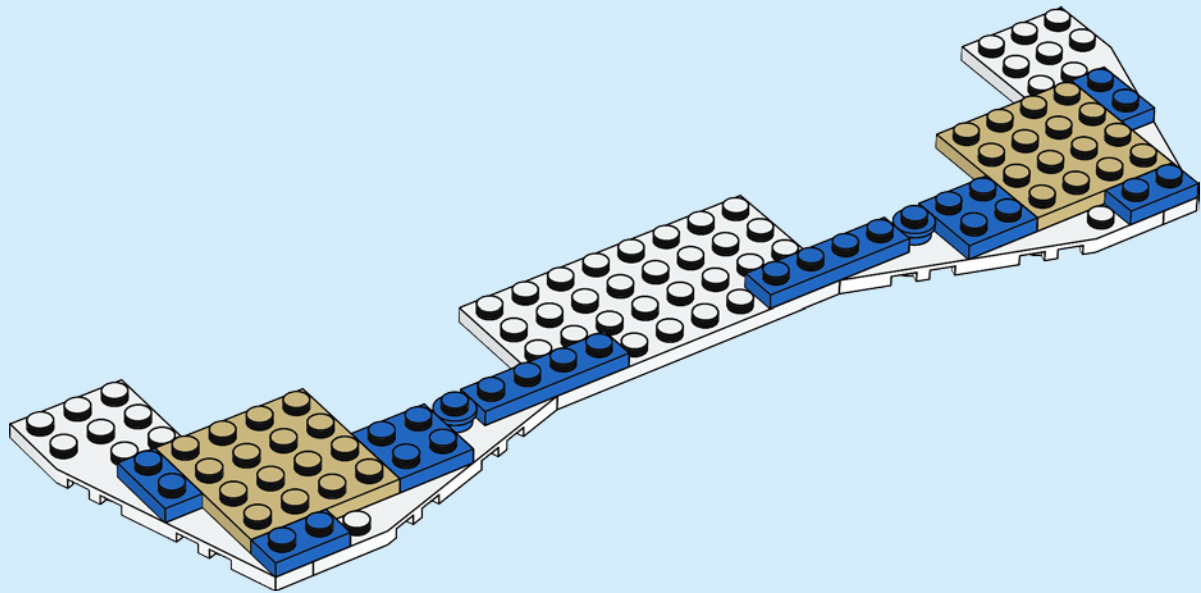

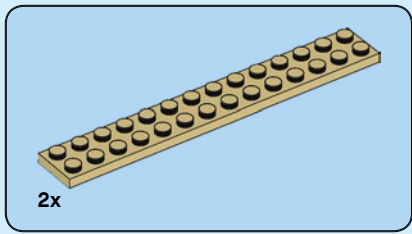

109

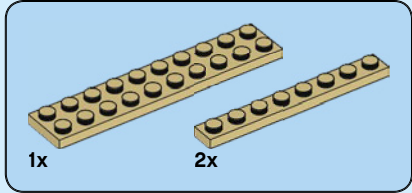
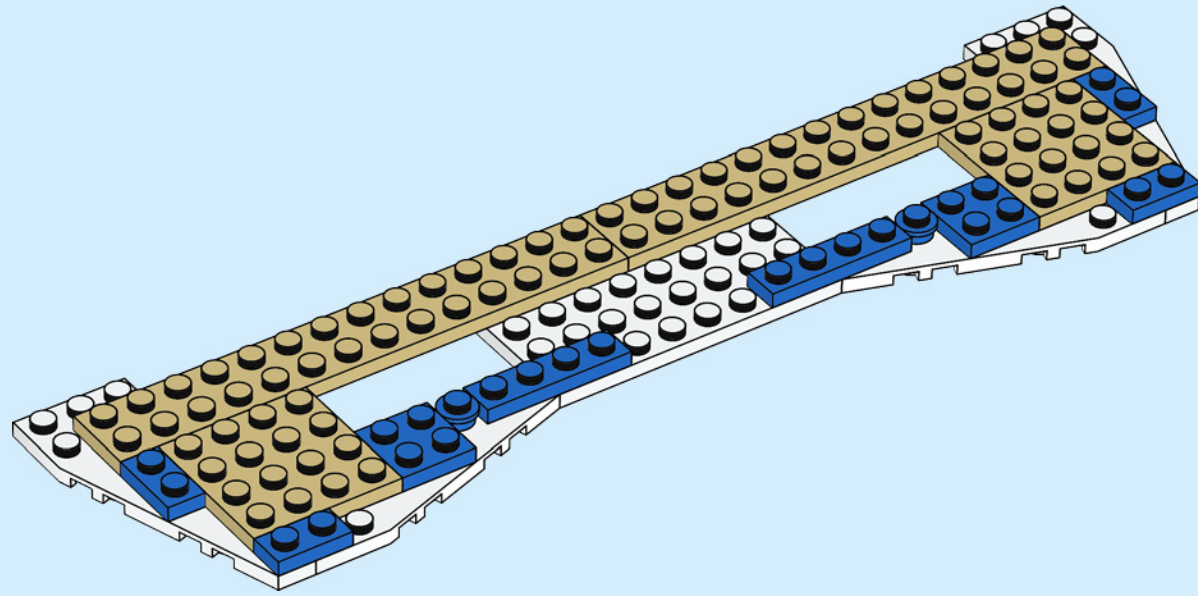

110

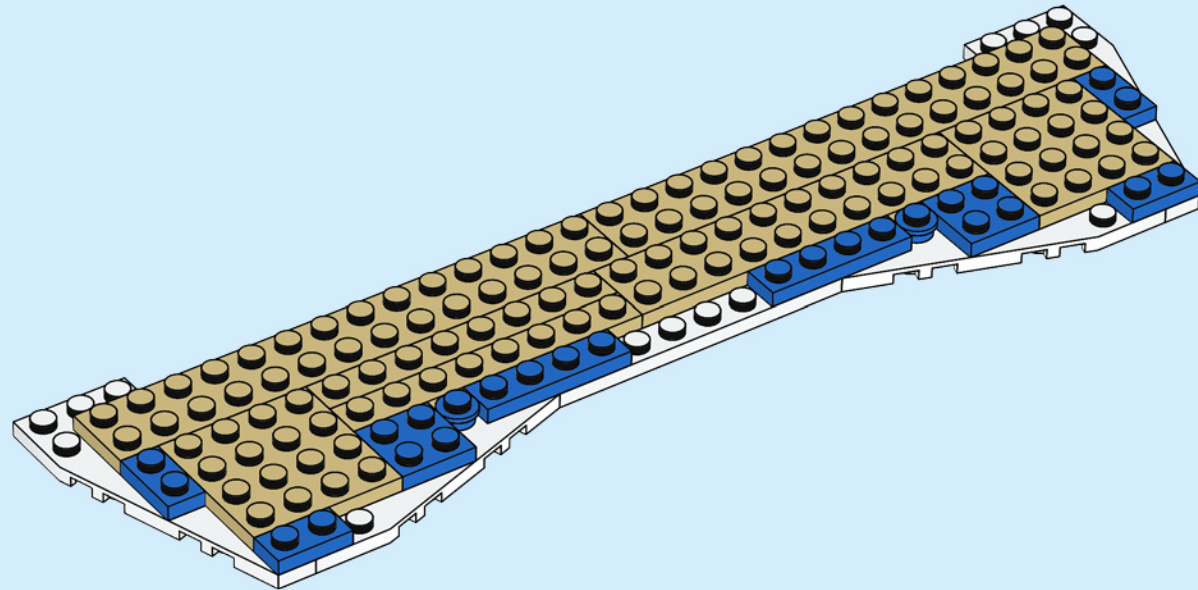

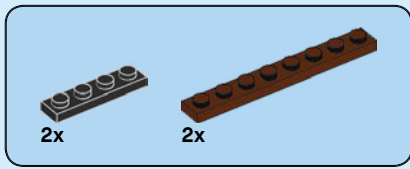

111

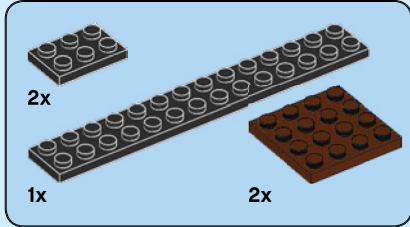
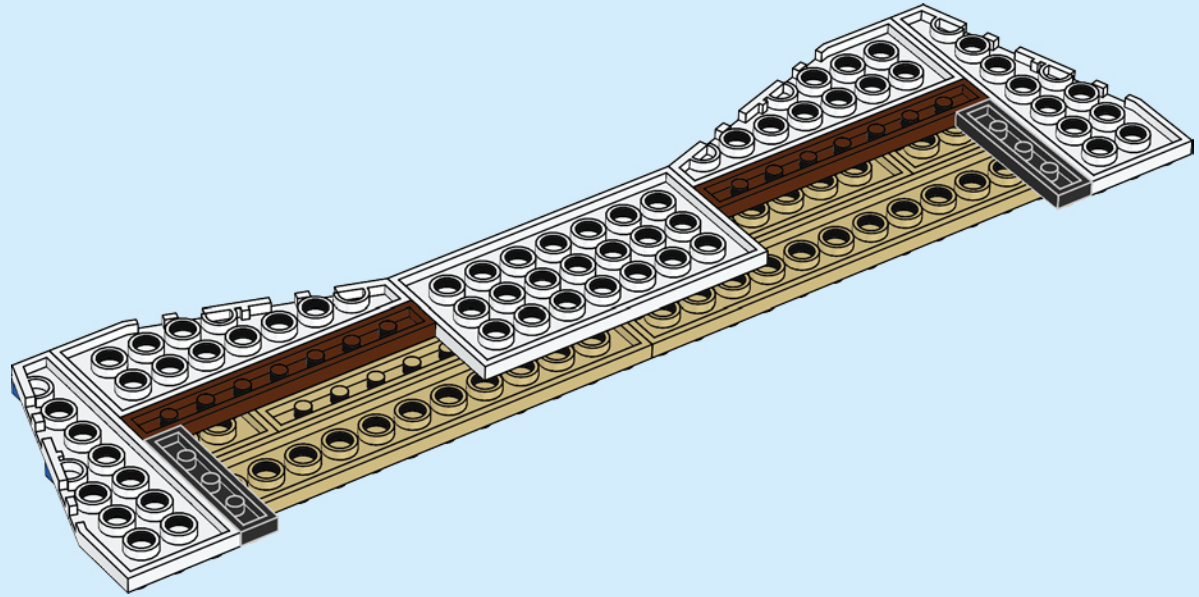

112

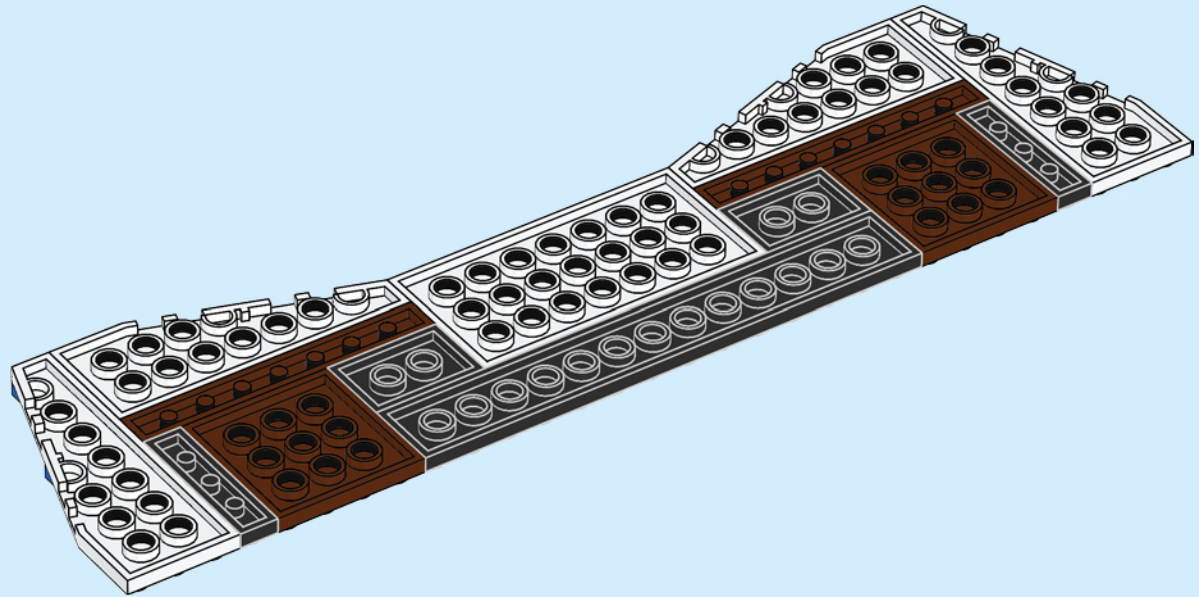

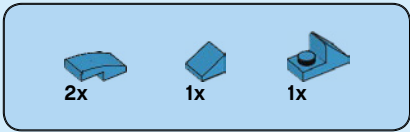

113

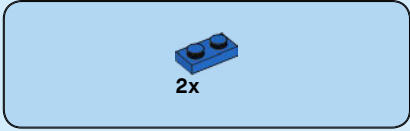
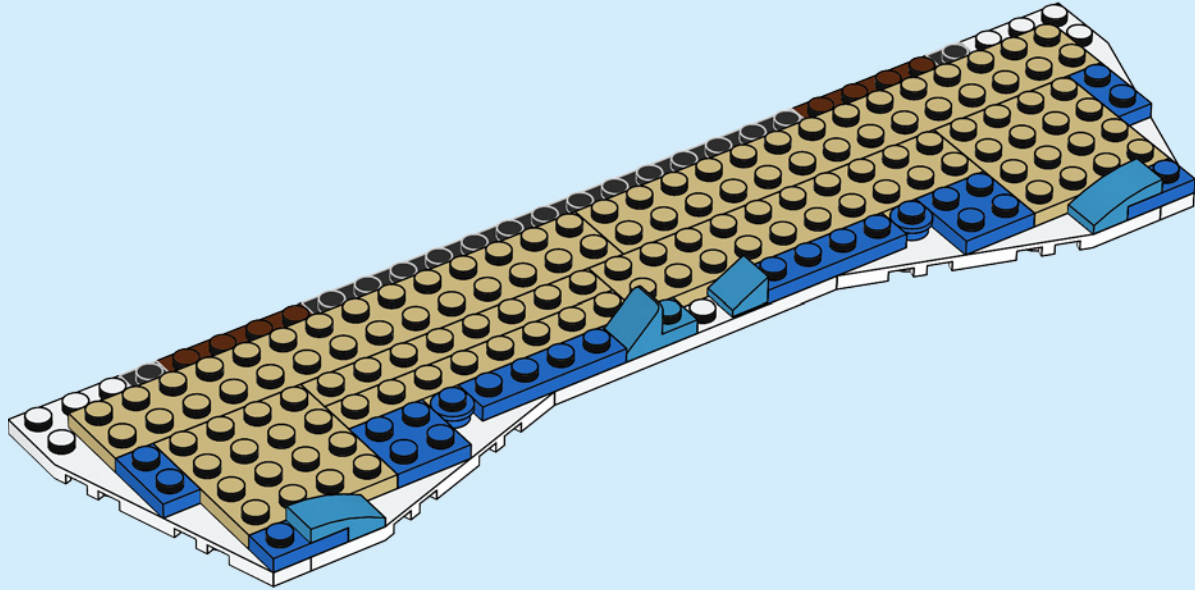

114

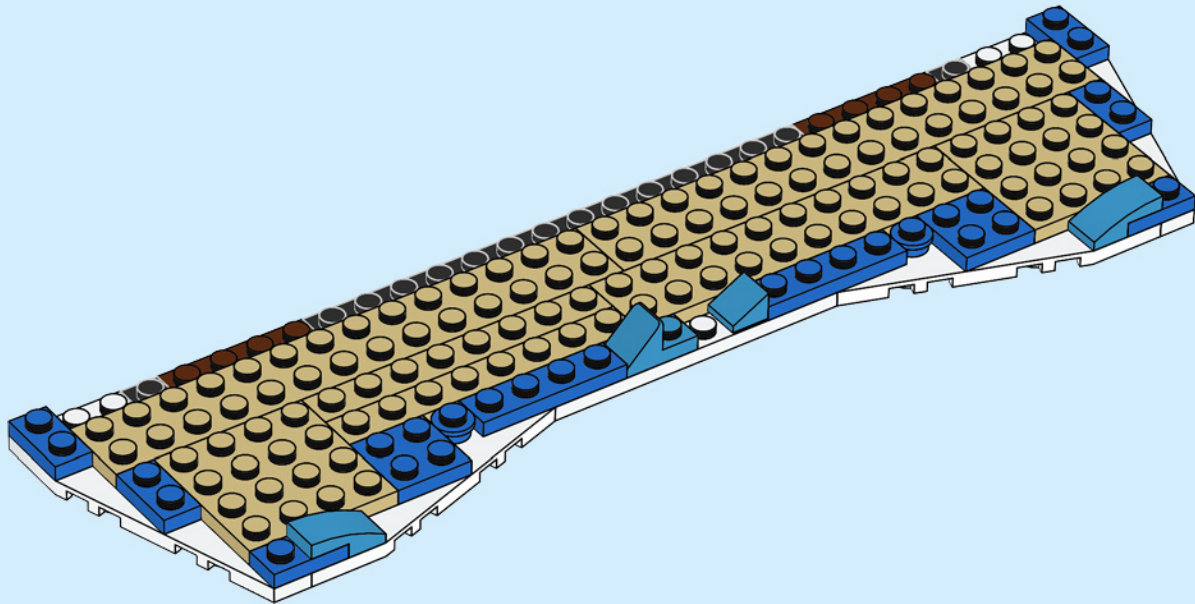

115

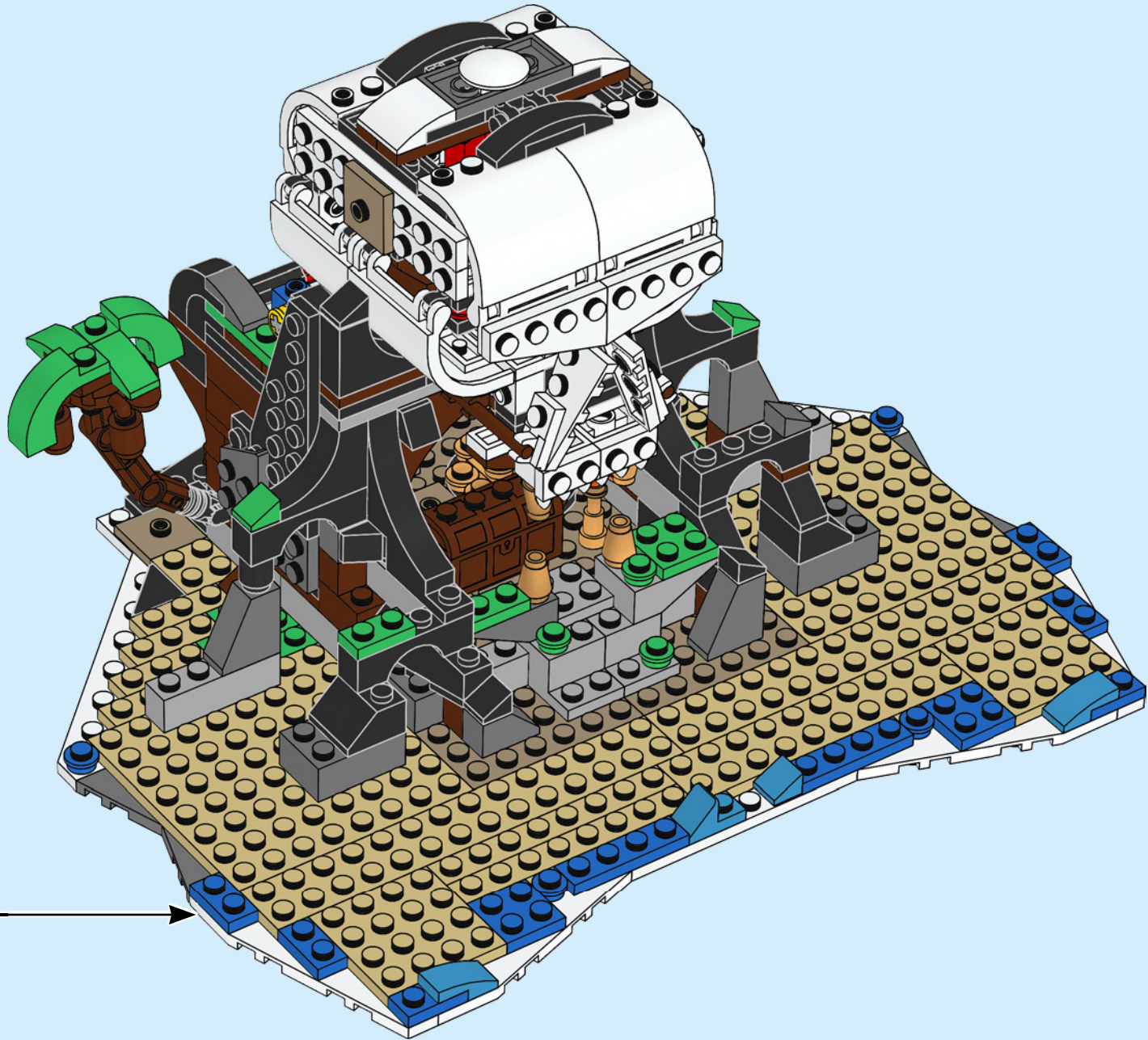

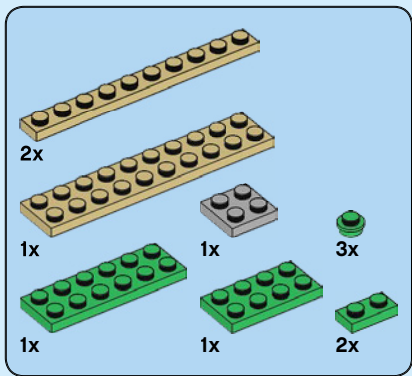

116

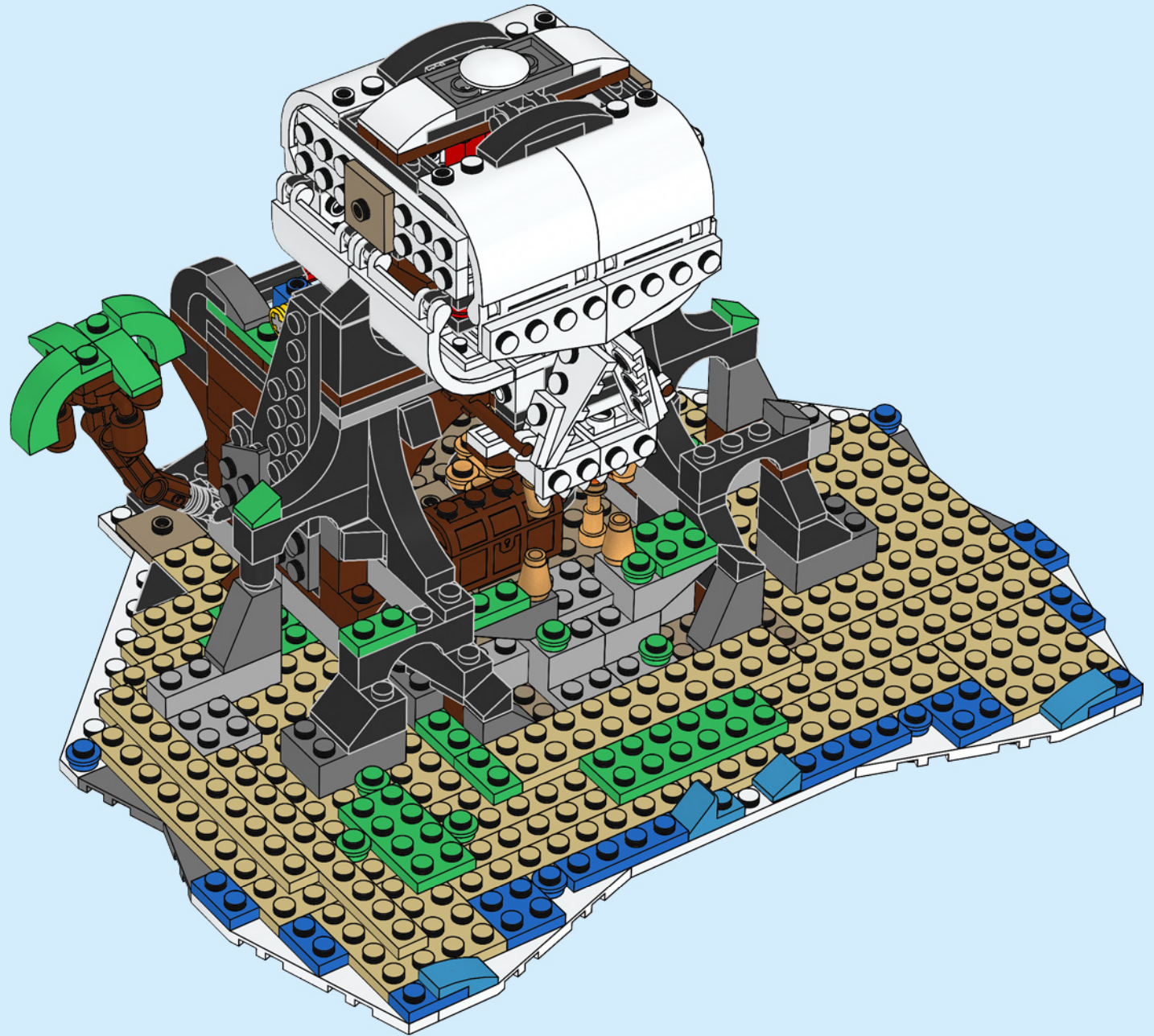

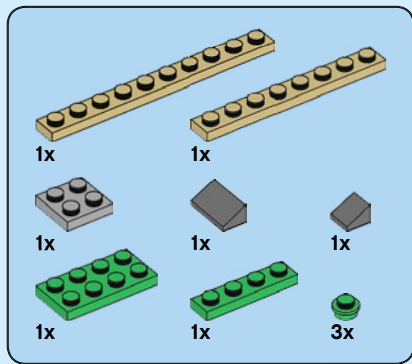



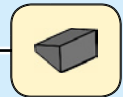
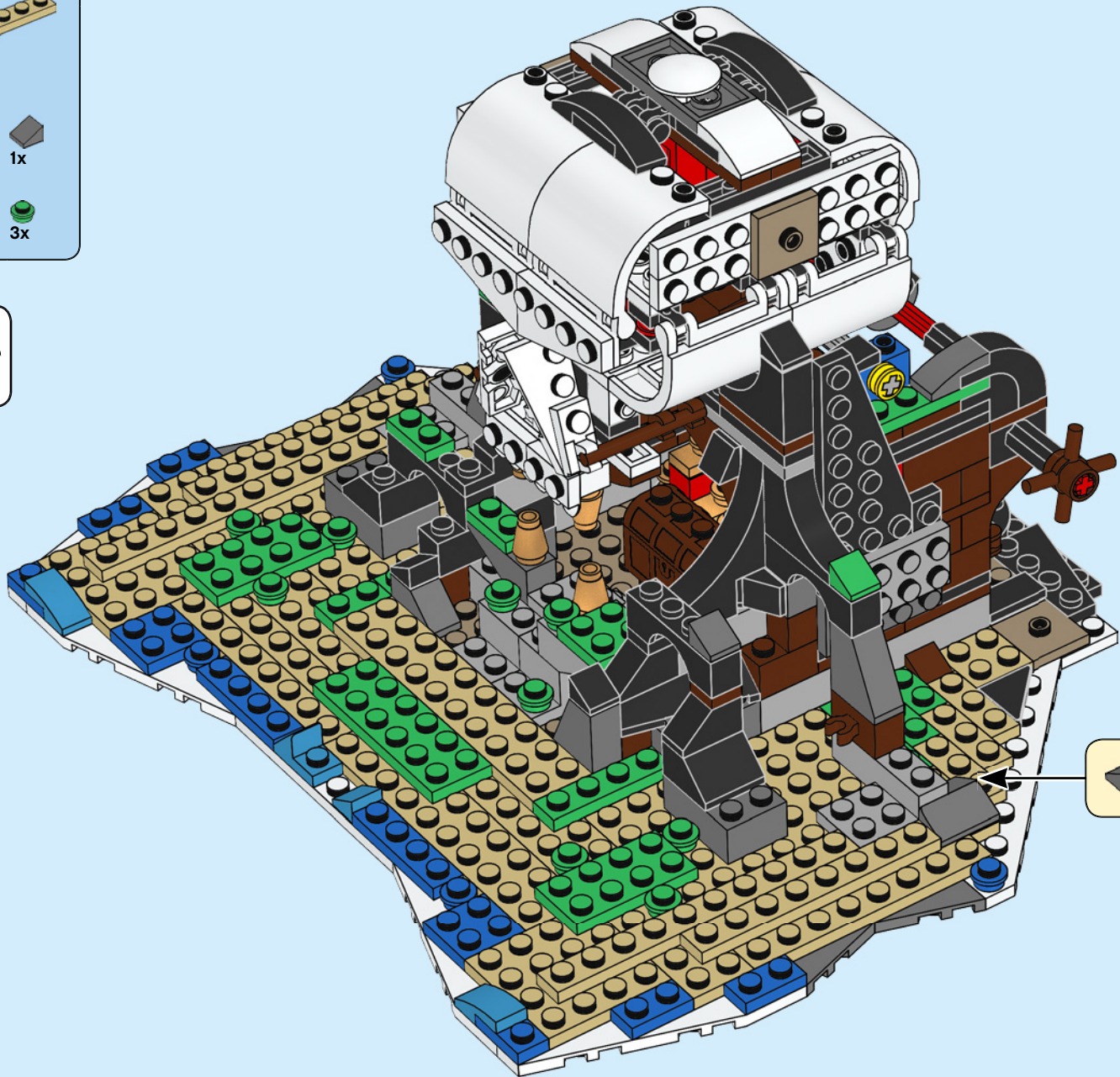







117





5x 6256435	4x 306926	5x 6265091	1x 6170421	2x 4180536	2x 4515350	8x 6069984	1x 4538950	1x 4205470	10x 421186
6x 6172383	10x 302326	2x 474026	2x 242026	1x 4161332	1x 6105963	9x 4211242	5x 6116613	1x 4264755	1x 4225869
2x 307026	4x 241226	1x 4278359	4x 362326	1x 4160869	2x 6208787	6x 6248854	1x 4538252	2x 4264755	1x 4225869
10x 4504382	2x 6047276	3x 6143850	3x 243126	1x 4160869	1x 4211222	1x 4211222	1x 4211219	3x 4508616	4x 4636170
1x 302426	2x 393826	3x 6143850	5x 6254045	2x 4618880	2x 6252902	1x 4252456	8x 6257604	2x 6280388	3x 4243838
4x 6308000	1x 6266207	3x 614326	20x 371026	4x 6154860	1x 6170707	1x 4252456	8x 4211190	1x 6254220	1x 4211247
2x 6273589	7x 6310268	2x 6116990	6x 6102782	1x 6277462	1x 6170707	4x 6035547	4x 6045941	1x 4579690	1x 4541875
8x 306226	4x 6166859	1x 4144024	2x 6037746	1x 6279754	2x 303226	9x 4211159	4x 6299939	1x 4533101	1x 4541875
1x 6015891	2x 4225201	7x 614326	12x 4613153	2x 416226	8x 366626	1x 4211149	4x 6299939	2x 6186577	4x 6299945
2x 4538456	1x 370026	2x 6178922	6x 302126	3x 373726	2x 416226	1x 6127734	2x 6186577	1x 6313506	12x 6299940
4x 6210270	2x 6184784	1x 6053077	2x 6052126	2x 4116854	2x 416226	2x 6234272	1x 6313506	4x 6295366	2x 6044725
1x 6265699	4x 6184784	2x 6192346	4x 365926	1x 4531412	2x 416226	4x 4216695	2x 4595814	1x 6295366	2x 6044725
5x 4121715	2x 4121966	2x 6052126	1x 4531412	1x 4251394	3x 373726	1x 6226436	1x 4542131	2x 4221590	7x 4216945
15x 4512363	2x 4141580	4x 460026	1x 4531412	1x 4251394	8x 447726	2x 4211202	1x 4542131	7x 4216945	1x 4217848
1x 6284699	1x 6271346	2x 303926	1x 6116604	1x 4251394	12x 4514845	2x 4211221	1x 6278989	1x 4211211	1x 4217848
4x 6214807	1x 4540699	4x 460026	1x 6116604	1x 4251394	1x 383226	2x 4211210	2x 4211220	2x 4223683	1x 6096716
8x 4295370	1x 6185327	2x 303926	1x 4623113	1x 4251394	1x 6001494	2x 6050918	1x 6177697	2x 4223683	1x 6096716
4x 4533771	4x 6228987	2x 4532220	4x 6171264	1x 4251394	1x 6001494	2x 6050918	1x 6177697	2x 4223683	1x 6096716

10x 4216581		8x 4210660	1x 6123814		4x 6284574		4x 614123	4x 614124
2x 4211288	2x 6205488		3x 6039479	2x 4644085	11x 614121	2x 6137300	1x 4632567	2x 6271167
19x 4221744		1x 6214341	2x 4581225	1x 371028	17x 302421			1x 6182787
1x 6170813	1x 6184874	1x 4211135	11x 4569058	2x 302028	1x 4504379	1x 6151674	2x 4206482	1x 6097174
7x 4504376	3x 4504378	1x 6071261	2x 4546705	2x 302028	2x 6072998	1x 6151668	6x 302323	1x 6097174
1x 4529242	6x 4558955	1x 4211068	1x 300528	2x 366628	1x 6249907	1x 6004943	12x 4278276	1x 6099581
12x 4211183		6x 4225733	1x 6253140	1x 379528	2x 4632572	3x 362221	2x 370023	1x 307024
6x 6248944	2x 6265669	3x 6013658	2x 6047426	1x 6097192	9x 4142865	2x 371021	2x 302223	3x 4540040
20x 4211150	2x 4210980	2x 4210872	10x 302328	1x 4278275	1x 6186398	2x 6102786	2x 302223	2x 6248971
8x 6035291	1x 4567887	2x 4210869	1x 4107736	2x 4651524	11x 300521	2x 6138800	1x 6023600	1x 614324
13x 6173132	2x 6029948	5x 4211105	1x 302228	11x 302321	2x 6019155	2x 302021	1x 6301950	2x 370024
3x 4645103	2x 6092572	1x 6005668	1x 300328	1x 362321	2x 302221	2x 6224366	2x 4509443	1x 6097241
2x 6100769	2x 6092572	1x 6015356	1x 300328	1x 6078641	2x 302221	2x 6224366	2x 4509443	2x 370024
8x 6008297	1x 4211063	1x 6015356	1x 302228	1x 6078641	2x 302221	2x 6224366	2x 4509443	2x 370024
4x 6102975		1x 6015356	1x 302228	1x 6078641	2x 302221	2x 6224366	2x 4509443	2x 370024
12x 4211152	1x 6015356	1x 6015356	1x 302228	1x 6078641	2x 302221	2x 6224366	2x 4509443	2x 370024
2x 6261388	2x 6167281	1x 4527082	1x 300328	1x 6078641	4x 6011814	2x 6224366	2x 4509443	1x 6097241
4x 4211257	2x 6167281	1x 4527082	2x 4107758	4x 300421	6x 4521438	2x 6224366	2x 4509443	2x 623224
	2x 4211053	3x 4227398	1x 4109679	2x 6184782	1x 300321	3x 6130002	2x 371023	1x 616606
							1x 379523	
								

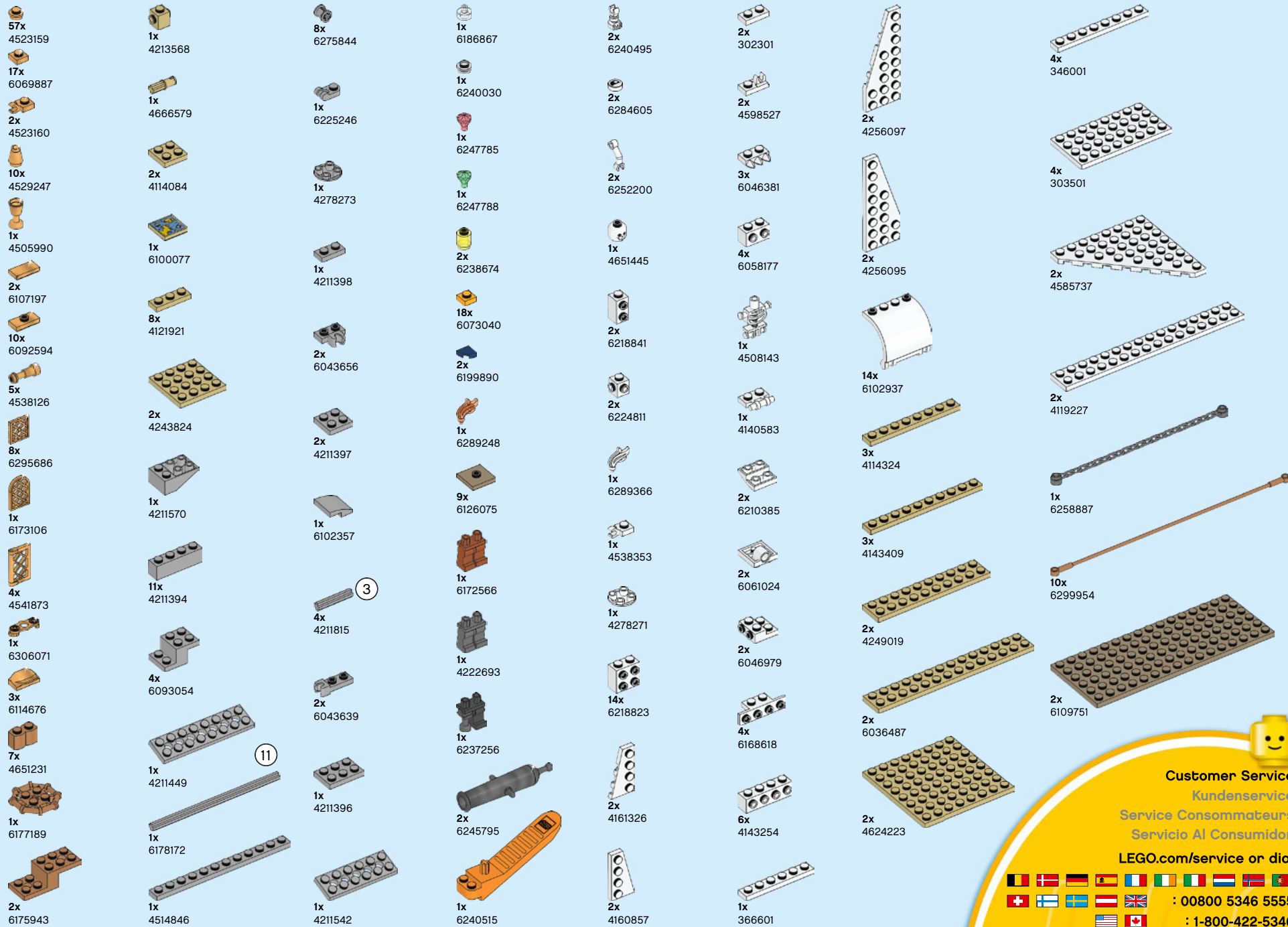

Customer Service  
 Kundenservice  
 Service Consommateurs  
 Servicio Al Consumidor

LEGO.com/service or dial



: 00800 5346 5555  
 : 1-800-422-5346

# WIN

GO TO [WWW.LEGO.COM/PRODUCTFEEDBACK](http://WWW.LEGO.COM/PRODUCTFEEDBACK) AND  
GIVE US YOUR SHORT **FEEDBACK** ABOUT THIS  
LEGO® SET FOR A CHANCE TO WIN  
A COOL LEGO PRIZE.

Terms & Conditions apply

## [LEGO.com/productfeedback](http://LEGO.com/productfeedback)

### GEWINNE

Erzähle uns auf  
[www.LEGO.com/productfeedback](http://www.LEGO.com/productfeedback)

etwas über die Erfahrungen, die  
du mit diesem LEGO® Set gemacht  
hast, und sichere dir die Chance  
auf einen coolen LEGO Preis!

Es gelten die  
Teilnahmebedingungen

### GAGNE

Rends-toi sur  
[www.LEGO.com/productfeedback](http://www.LEGO.com/productfeedback)

et donne-nous quelques com-  
mentaires sur ce produit LEGO®  
pour avoir une chance de gagner  
un prix LEGO !

Voir Conditions Générales

### GANAN

Visita  
[www.LEGO.com/productfeedback](http://www.LEGO.com/productfeedback)

y envíanos tu opinión acerca de  
este set LEGO®. ¡Participarás en el  
sorteo de un premio LEGO!

Términos y Condiciones aplicables

### 获取奖品

登录  
[www.LEGO.com/productfeedback](http://www.LEGO.com/productfeedback)

给出关于此乐高®套装的简短反馈，  
就有机会获得炫酷乐高奖品

《条款及条件》适用

### 경품 당첨 기회

[www.LEGO.com/productfeedback](http://www.LEGO.com/productfeedback)

페이지로 이동하여 이 레고® 세트에  
대한 간략한 피드백을 보내 주시고  
멋진 레고 경품을 탈 수 있는 기회도  
잡으십시오

약관 적용

### ЗАПОЛНИ АНКЕТУ И ПОЛУЧИ ПРИЗ

Перейди по ссылке  
[www.LEGO.com/productfeedback](http://www.LEGO.com/productfeedback)

ответь всего на несколько во-  
просов об этом наборе LEGO®,  
и у тебя появится шанс выиграть  
замечательный приз от компании  
LEGO.

Применяются Условия и правила  
участия