



Questo manuale d'istruzione è fornito da trovaprezzi.it. Scopri tutte le offerte per [Logitech Pro mouse](#) o cerca il tuo prodotto tra le [migliori offerte di Mouse, Tastiere, altro Input](#)



Questo manuale d'istruzione è fornito da trovaprezzi.it. Scopri tutte le offerte per [Logitech Pro mouse](#) o cerca il tuo prodotto tra le [migliori offerte di Mouse, Tastiere, altro Input](#)

PRO WIRELESS

SETUP GUIDE



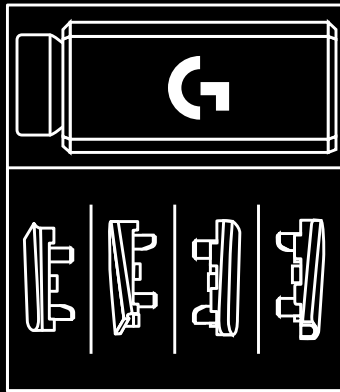
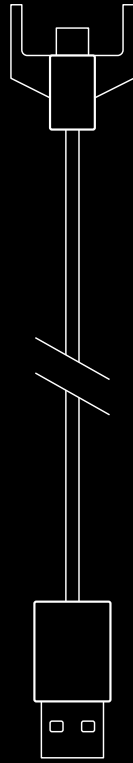
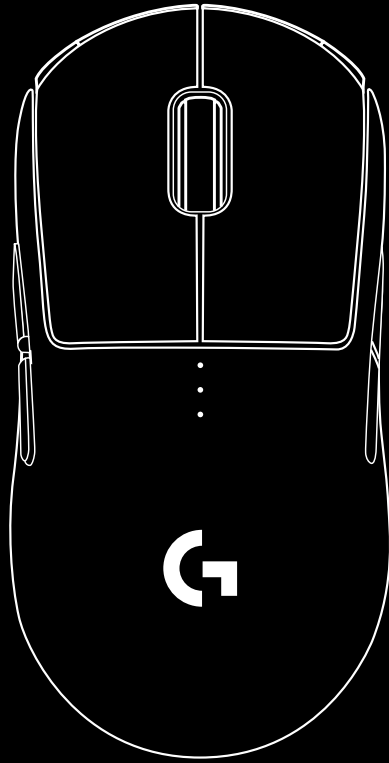

logitech 

Important Safety, Compliance and
Warranty Information
Informations importantes
concernant la sécurité,
la mise en conformité et la garantie

ENGLISH 3
FRANÇAIS 12
ESPAÑOL 21
PORTUGUÊS 30

SETUP INSTRUCTIONS

1 A wireless receiver attached to the USB adapter can be found in the accessory box. Plug one end of the cable into your PC, and the other end into the USB adapter and receiver.

- The receiver can also be used plugged directly into your PC. However, using the cable and adapter when in wireless mode is recommended and allows for better connectivity and easy access to the cable for recharging.

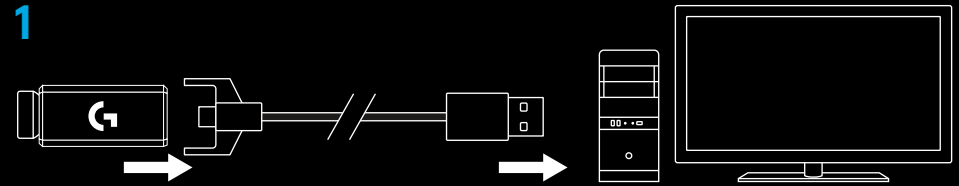

2 Turn mouse on via the switch on the bottom of the mouse.

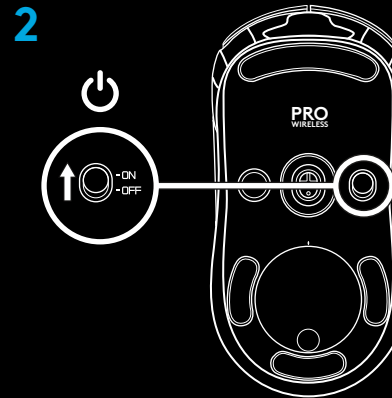

3 Download Logitech Gaming Software

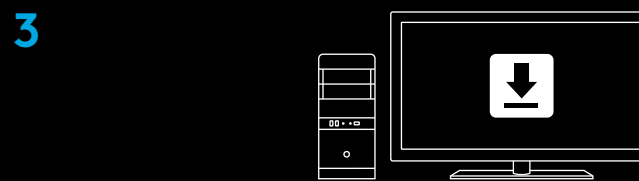

www.logitechG.com/support/pro-wireless

4 To charge, disconnect the cable from the adapter and plug into the front of the mouse. Your mouse will operate in data-over-cable mode whenever it is plugged in directly to a PC. Full charge from empty requires around 2 hours plugged in to a PC USB port.

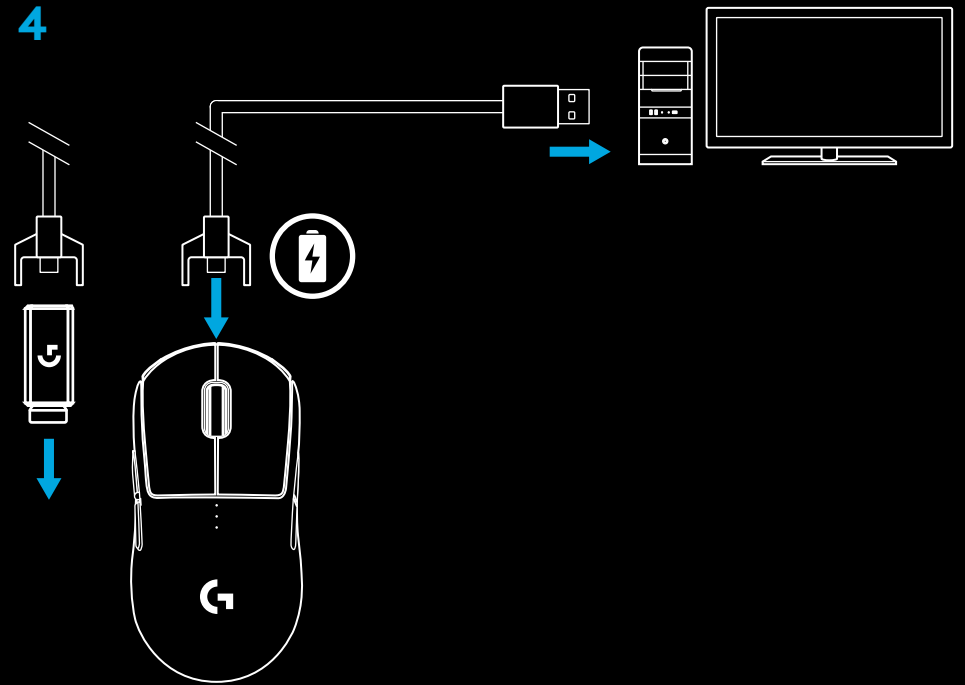

Tips:

- Keep the mouse and receiver 2 m+ away from wireless routers or other 2.4GHz wireless devices to minimize environmental noise.
- PRO WIRELESS has a wireless range of up to 10 meters. To ensure optimal performance in noisy wireless environments, and to keep the charging cable easily accessible, it is recommended to keep the receiver within 20 cm of the mouse.

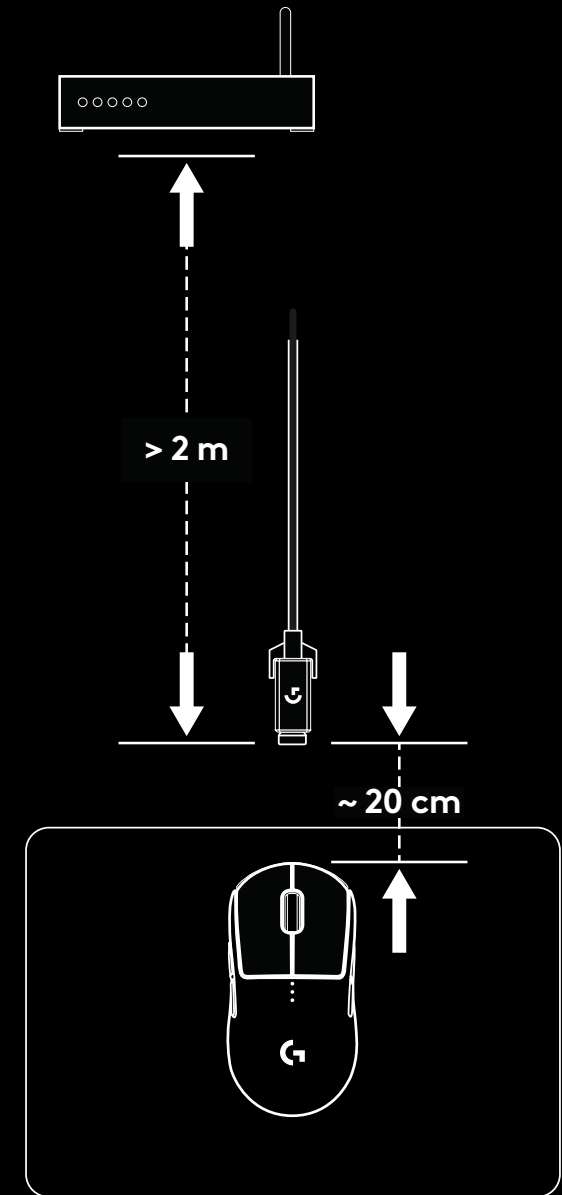
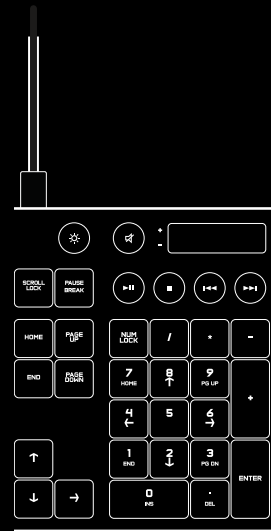

BUTTON CONFIGURATIONS

PRO WIRELESS comes with replaceable buttons and button caps, which are held onto the mouse magnetically. These should be stored in box when not in use. These replaceable buttons support conversion to the following configurations:

- 1 Right handed
- 2 Left handed
- 3 No buttons
- 4 Full buttons

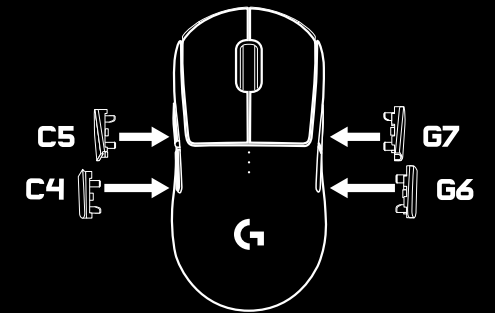
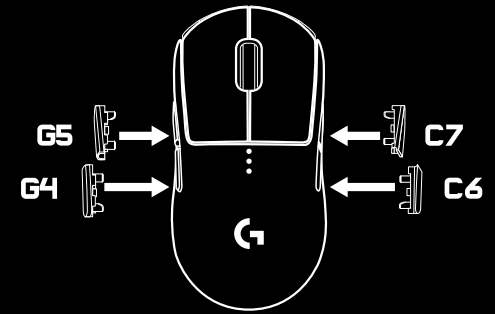
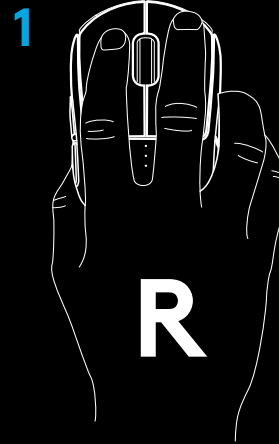

3

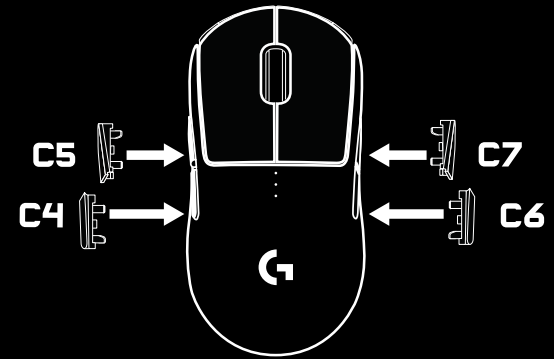

4

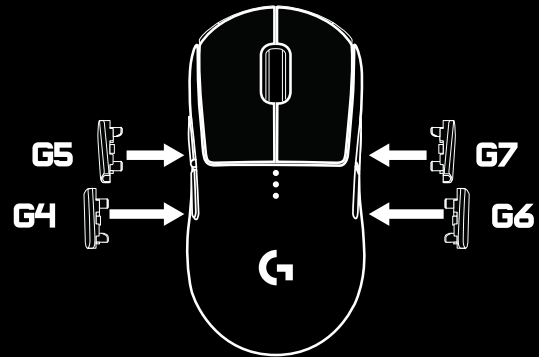

8 FULLY PROGRAMMABLE BUTTONS

- 1 Left (Button 1)
- 2 Right (Button 2)
- 3 Wheel click (Button 3)
- 4 Back (Button G4)
- 5 Forward (Button G5)
- 6 Back (Button G6)
- 7 Forward (Button G7)
- 8 DPI cycle (bottom of mouse, Button 8)
- 9 Receiver storage door + Powerplay module enclosure (bottom of mouse)
- 10 On/Off switch (bottom of mouse, not programmable)

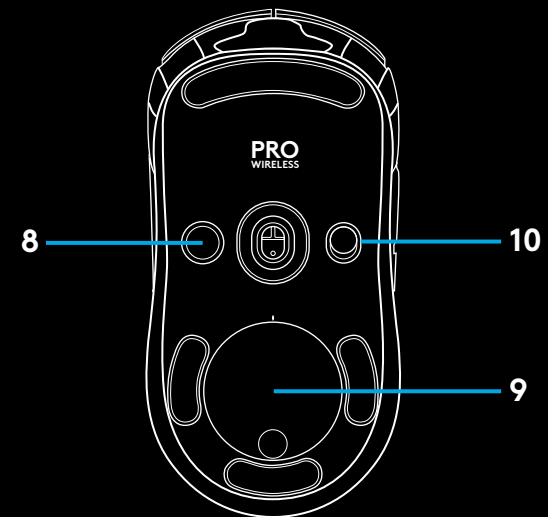

BATTERY LIFE

PRO WIRELESS has a rechargeable 250mAH LiPol battery which provides it with up to 60 hours non-stop gaming at 1ms report rate with lights off, or 48 hours non-stop gaming at 1ms report rate with RGB color cycling on.*

- Charge level can be checked when the mouse is powered on or using Logitech Gaming Software to assign a button to check charge level.
- Charge level is displayed for seven seconds at mouse power-on using the color and number of bars illuminated on the DPI indicator:
 - 3 green dots = 50–100%
 - 2 green dots = 30–50%
 - 1 green dots = 15–30%
 - 1 flashing red dot = <15%

Tips:

- You can program a button to show charge level using LGS.
- The bottom dot will flash red when battery is at 15% or less. When this happens, plug in your mouse to charge.
- Charge level, power draw, and estimated remaining battery life can be checked in Logitech Gaming Software.

*Battery life and capacity may vary with age and use. Rechargeable batteries have a limited number of charge cycles.

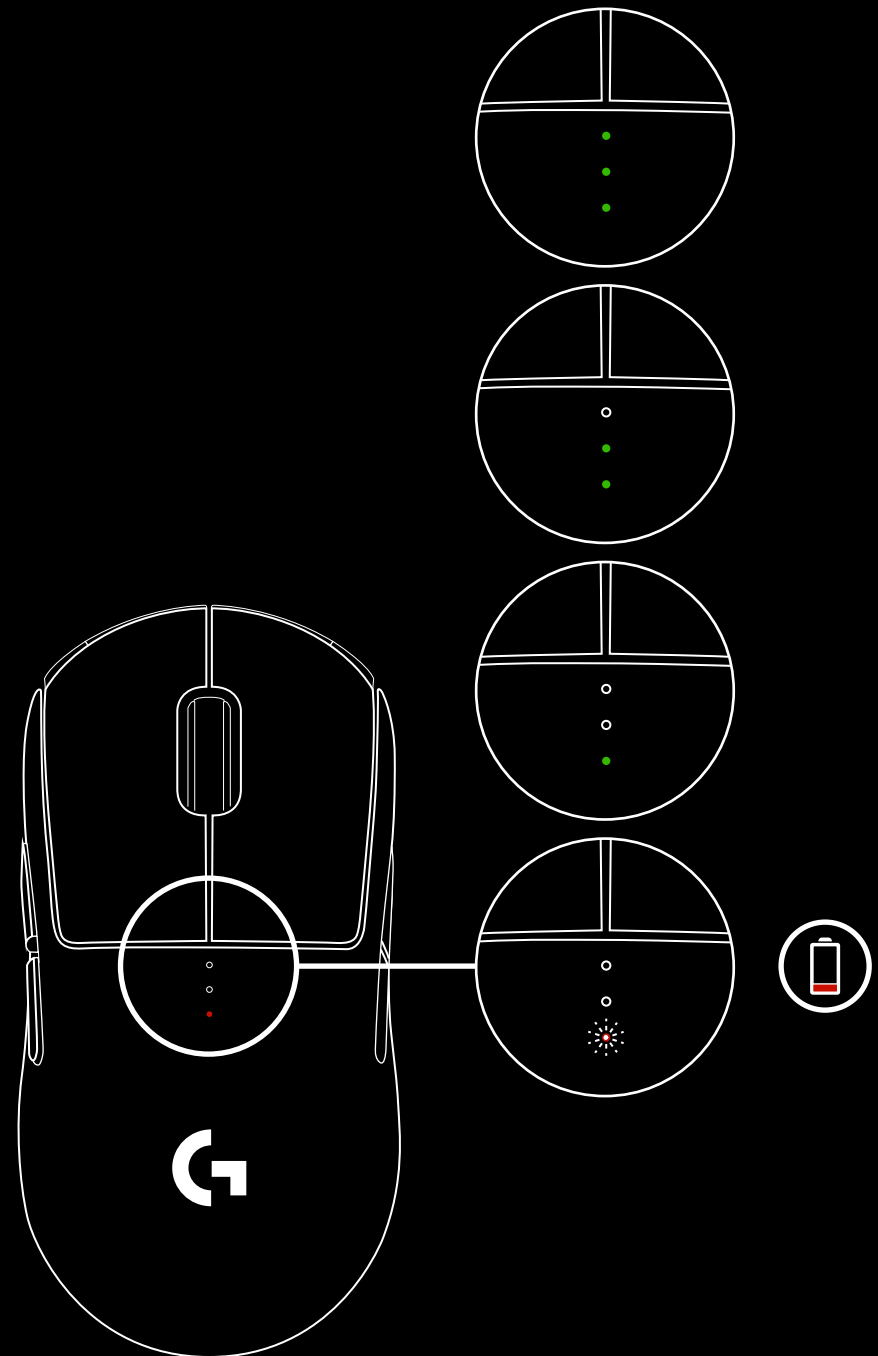

CHARGING/DATA OVER CABLE

Plug your mouse in via the provided USB charging cable when the battery is low. PRO WIRELESS is also compatible with the Logitech G POWERPLAY wireless charging system, sold separately.

LOGITECH GAMING SOFTWARE

You can customize the onboard profile settings using the Logitech Gaming Software. These settings include button programming, report rate, performance/endurance modes and tracking behavior. PRO WIRELESS allows up to 5 DPI settings.

By default, PRO WIRELESS has the following settings:

- DPI: 400/800/1600/3200
- Report rate: 1ms
- Performance mode

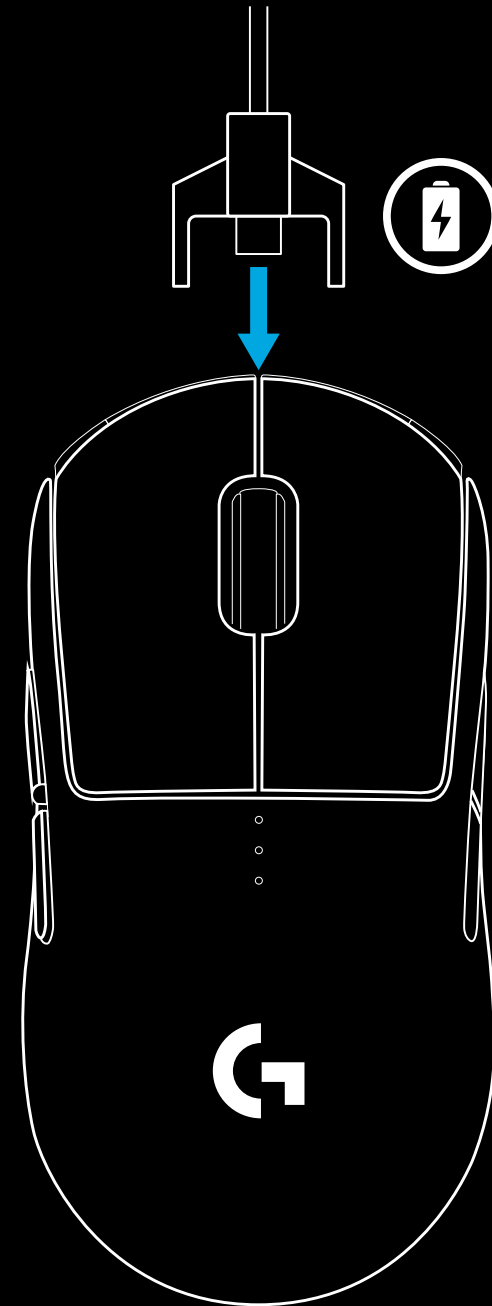

DPI/ONBOARD PROFILE INDICATORS

DPI/Onboard profiles are shown using three LEDs under the main buttons. The image below shows which values are being indicated by the LED panel.

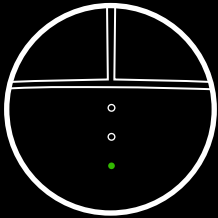

DPI/Profile 1

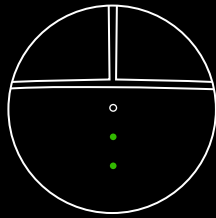

DPI/Profile 2

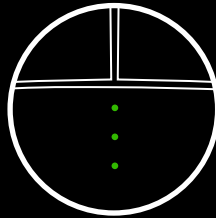

DPI/Profile 3

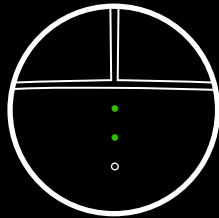

DPI/Profile 4

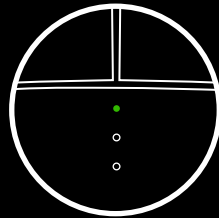

DPI/Profile 5

FREQUENTLY ASKED QUESTIONS

<http://support.logitechG.com/product/pro-wireless>

INSTRUCTIONS D'INSTALLATION

- 1 Vous trouverez un récepteur sans fil installé sur l'adaptateur USB dans la boîte des accessoires. Branchez l'une des extrémités du câble à votre ordinateur et l'autre à l'adaptateur et récepteur USB.
 - Vous pouvez également brancher directement le récepteur sur votre PC. Cependant, il est recommandé d'utiliser le câble et l'adaptateur en mode sans fil, car ils permettent d'améliorer la connectivité et l'accès au câble pour la recharge.
- 2 Mettez la souris sous tension à l'aide du commutateur située sous la souris.

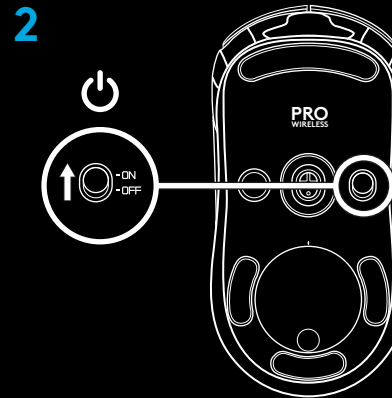
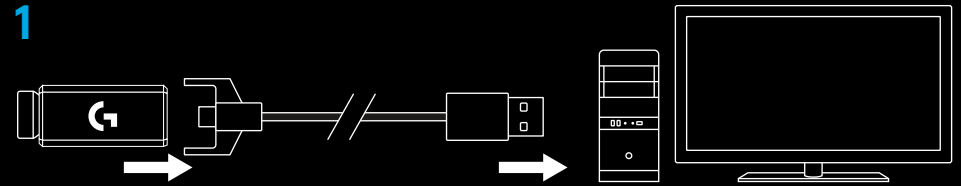

- 3 Télécharger l'Assistant pour jeux vidéo de Logitech

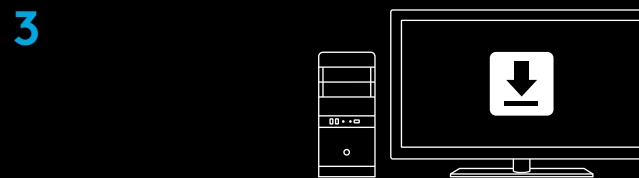

www.logitechG.com/support/pro-wireless

- 4 Pour charger, déconnectez le câble de l'adaptateur et branchez-le à l'avant de la souris. La souris passe automatiquement en mode transmission de données par câble lorsqu'elle est branchée au PC. La charge pleine de la batterie requiert le branchement de la souris à un port USB pendant 2 heures environ.

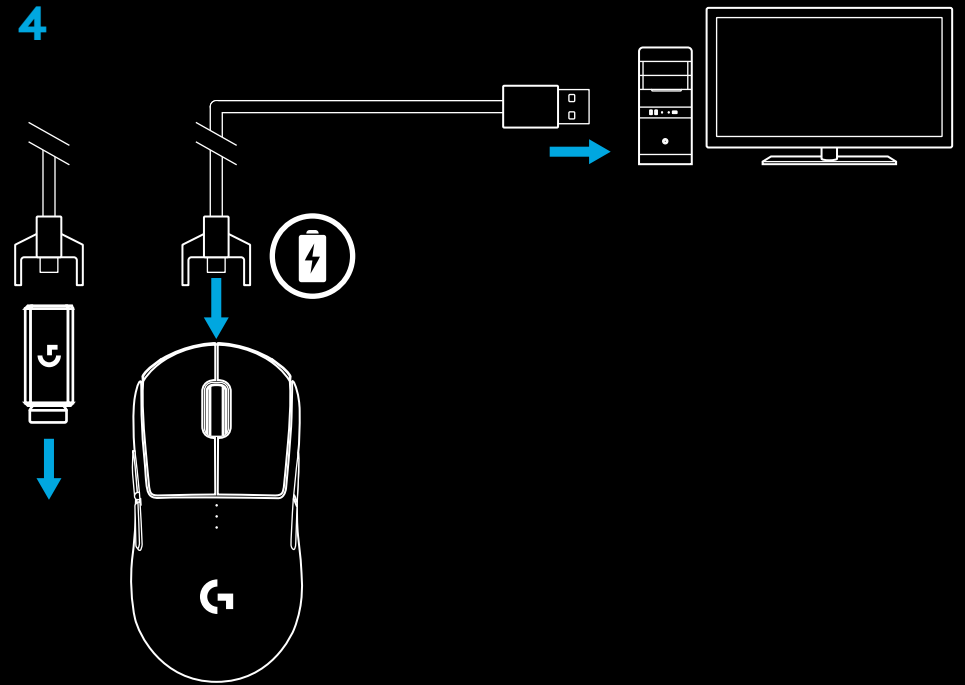

Conseils:

- Tenez la souris et le récepteur à au moins 2 m de tout routeur sans fil ou tout autre dispositif sans fil 2,4 GHz afin de minimiser les interférences.
- La souris PRO sans fil a une portée sans fil de 10 mètres maximum. Pour une performance optimale dans les environnements sans fil sujets aux interférences, et pour faciliter l'accès au câble de charge, il est recommandé de placer le récepteur à moins de 20 cm de la souris.

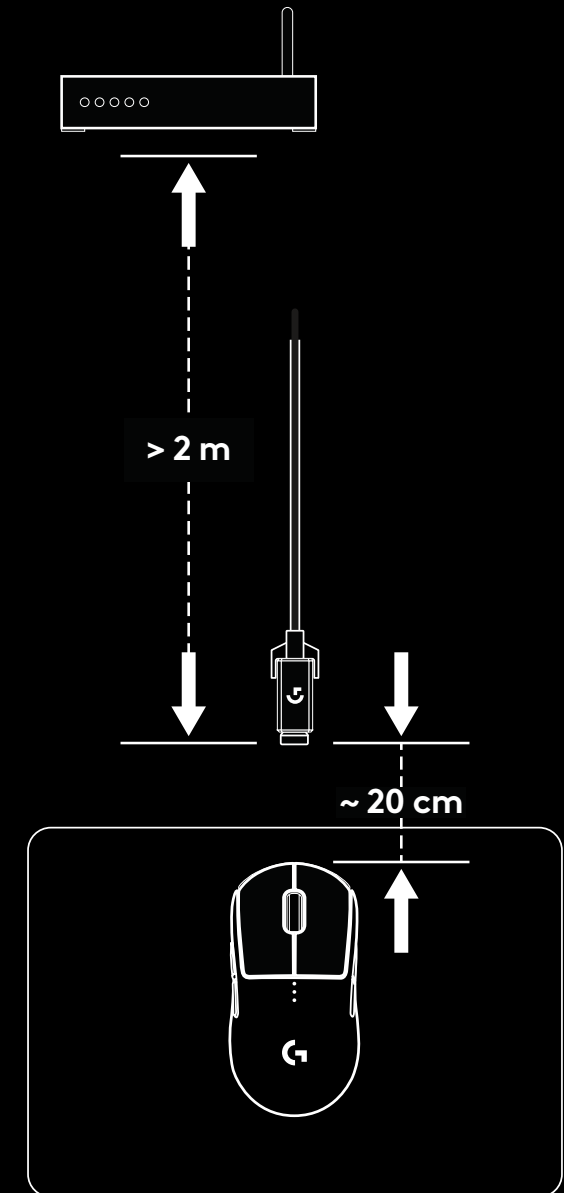
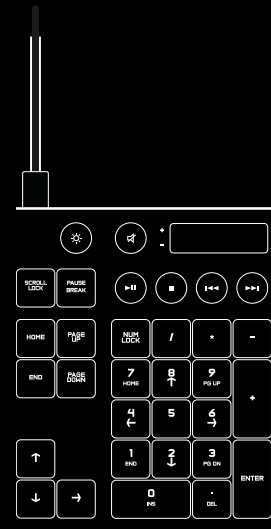

CONFIGURATIONS DES BOUTONS

La souris PRO sans fil est livrée avec des boutons remplaçables fixés à la souris par des aimants. Ceux-ci doivent être rangés dans leur boîte lorsque vous n'utilisez pas la souris. Les boutons remplaçables permettent d'adopter les configurations suivantes:

- 1 Droitier
- 2 Gaucher
- 3 Aucun bouton
- 4 Tous les boutons

1

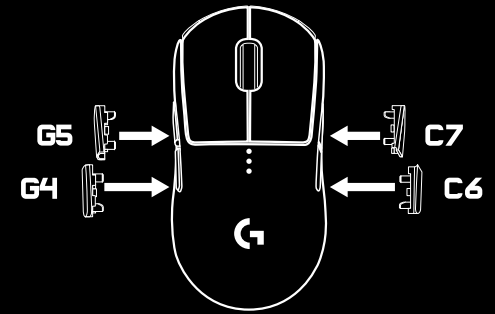
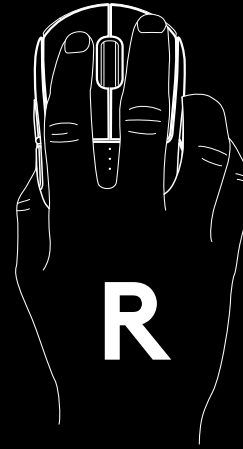

2

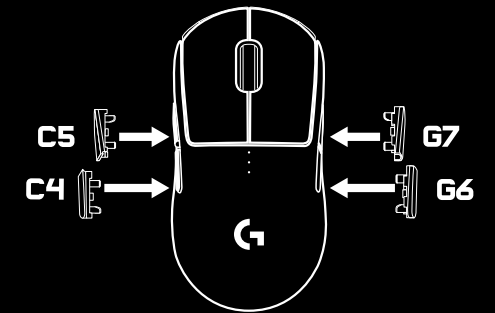
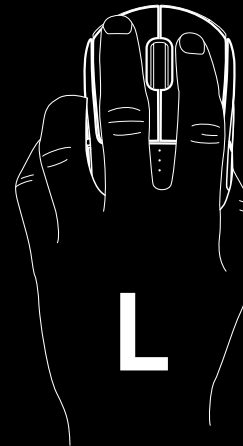

3

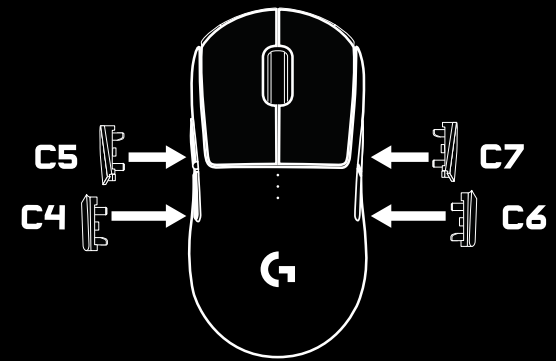

4

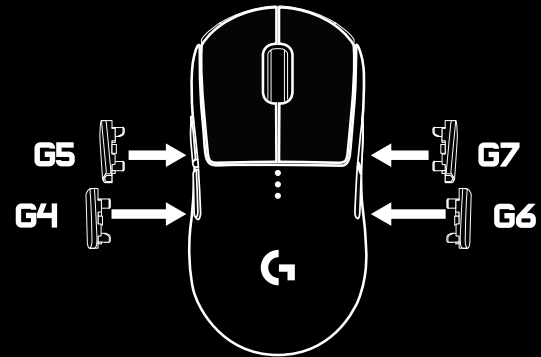

8 BOUTONS ENTIÈREMENT PROGRAMMABLES

- 1 Gauche (bouton 1)
- 2 Droit (bouton 2)
- 3 Clic de roulette (bouton 3)
- 4 Précédent (bouton G4)
- 5 Suivant (bouton G5)
- 6 Précédent (bouton G6)
- 7 Suivant (bouton G7)
- 8 Cycle de résolution (partie inférieure de la souris, bouton 8)
- 9 Espace de rangement du récepteur + boîtier du module Powerplay (partie inférieure de la souris)
- 10 Commutateur Marche/Arrêt (sous la souris, non programmable)

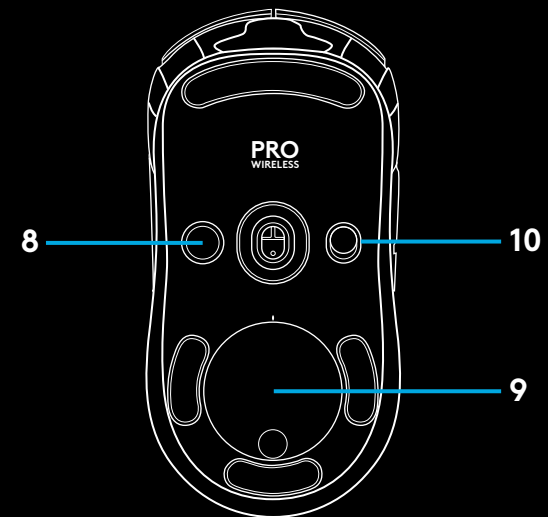

LONGÉVITÉ DE LA BATTERIE

La souris PRO sans fil est dotée d'une batterie rechargeable LiPol 250 mAH offrant jusqu'à 60 heures de jeu non-stop avec un taux de rapport de 1 ms lumières éteintes, ou 48 heures de jeu non-stop avec un taux de rapport de 1 ms et le cycle de couleur RVB.*

- Le niveau de charge peut être contrôlé à l'allumage de la souris ou en associant un bouton à cette fonction via l'Assistant pour jeux vidéo de Logitech.
- Les témoins lumineux PPP indiquent le niveau de charge pendant sept secondes à l'allumage de la souris sous la forme de barres de couleur:
 - 3 points verts = 50-100 %
 - 2 points verts = 30-50 %
 - 1 point vert = 15-30 %
 - 1 point rouge clignotant = < 15 %

Conseils:

- Vous pouvez attribuer l'affichage du niveau de charge à un bouton en utilisant l'Assistant pour jeux vidéo de Logitech.
- Le point inférieur clignote en rouge lorsque la charge de la batterie est inférieure ou égale à 15 %. Dans ce cas, branchez votre souris pour la charger.
- Le niveau de charge, la consommation d'énergie et l'autonomie restante estimée peuvent être affichés dans l'Assistant pour jeux vidéo de Logitech.

*L'autonomie et la capacité de la batterie peuvent varier avec le temps et l'usure. Les batteries rechargeables ne peuvent être rechargées qu'un nombre limité de fois.

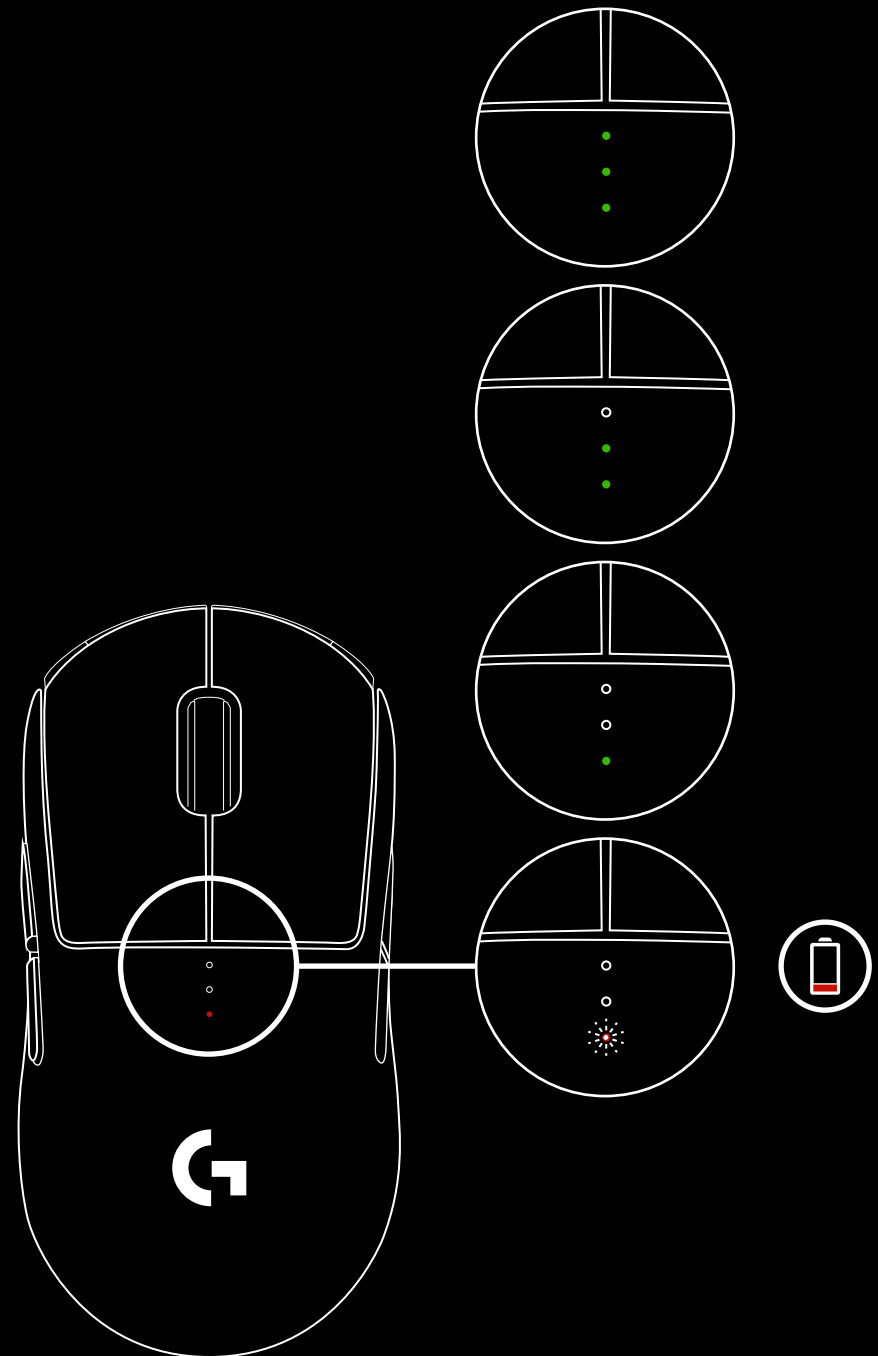

CHARGE ET TRANSMISSION DE DONNÉES PAR CÂBLE

Branchez votre souris via le câble de charge USB fourni lorsque le niveau de la batterie est faible. La souris PRO sans fil est également compatible avec le système de charge sans fil POWERPLAY vendu séparément.

ASSISTANT POUR JEUX VIDÉO DE LOGITECH

Il est possible de personnaliser les paramètres de profil enregistrés à l'aide de l'Assistant pour jeux vidéo de Logitech. Ces paramètres comprennent la programmation des boutons, le taux de rapport, les modes performance/endurance et le comportement de suivi. La souris PRO sans fil accepte jusqu'à 5 paramètres de résolution.

Par défaut, la souris PRO sans fil propose les paramètres suivants:

- PPP: 400/800/1 600/3 200
- Taux de rapport: 1 ms
- Mode de performances:

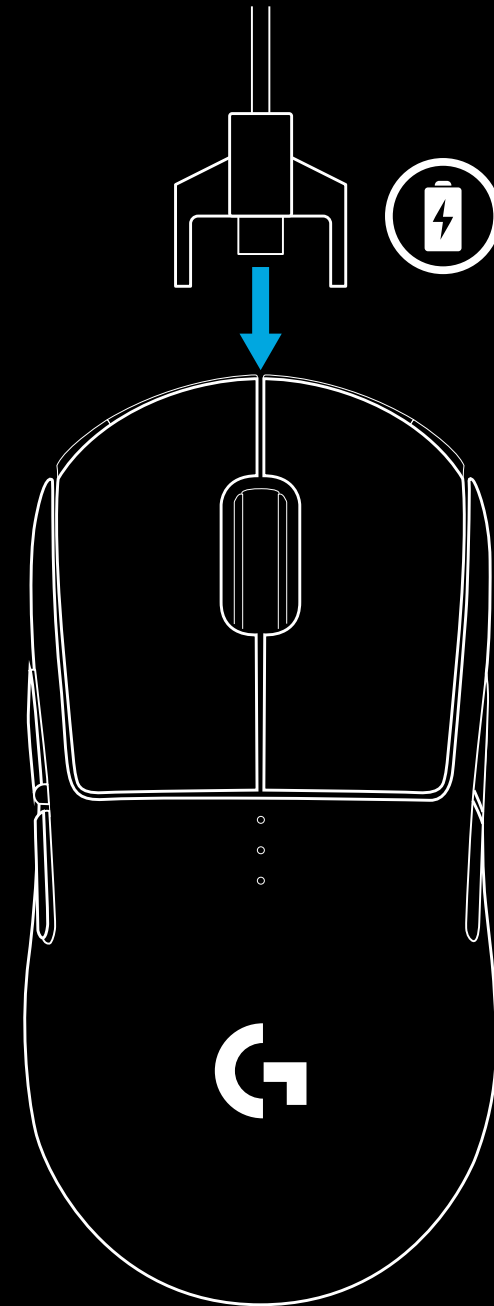

TÉMOINS DE PROFIL ENREGISTRÉ/PPP

Trois témoins lumineux sous les boutons principaux indiquent les profils enregistrés/PPP. L'image ci-dessous montre les valeurs indiquées par le panneau des témoins lumineux.

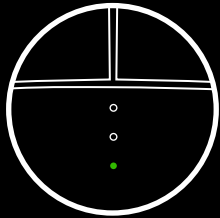

PPP/Profil 1

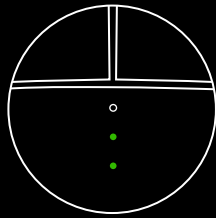

PPP/Profil 2

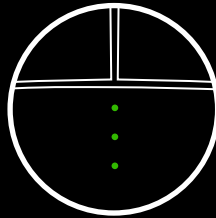

PPP/Profil 3

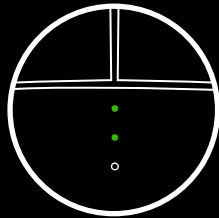

PPP/Profil 4

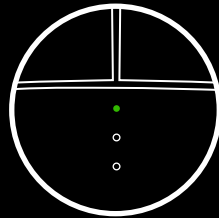

PPP/Profil 5

QUESTIONS FRÉQUENTES

<http://support.logitechG.com/product/pro-wireless>

INSTRUCCIONES DE INSTALACIÓN

1 En la caja de accesorios encontrarás un receptor inalámbrico acoplado al adaptador USB. Conecta un extremo del cable a la PC, y el otro extremo al adaptador USB y al receptor.

- El receptor también se puede usar conectado directamente a la PC. Sin embargo se recomienda usar el cable y el adaptador en modo inalámbrico ya que permite mejor conectividad y más facilidad de acceso al cable para recargar.

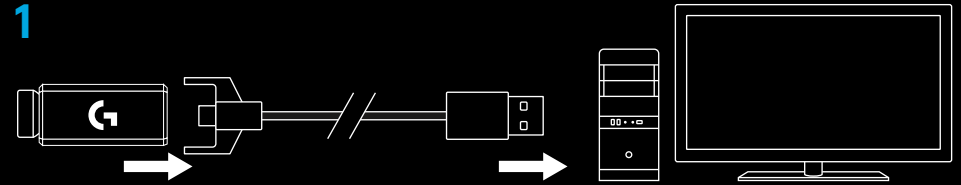

2 Enciende el mouse mediante el conmutador en la parte inferior del mouse.

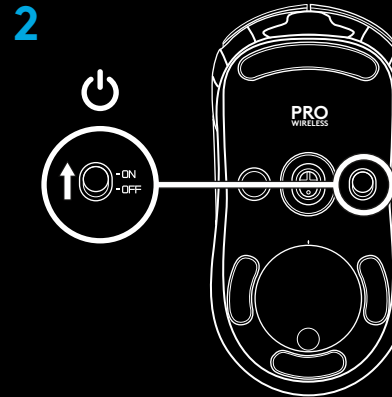

3 Descarga Logitech Gaming Software.

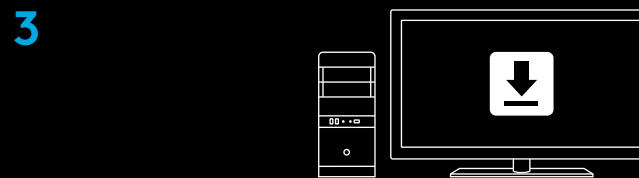

www.logitechG.com/support/pro-wireless

- 4 Para cargar, desconecta el cable del adaptador y conéctalo a la parte frontal del mouse. El mouse funcionará en modo de datos por cable siempre que se conecte directamente a una PC. Una carga completa desde vacío requiere alrededor de 2 horas de conexión a un puerto USB de PC.

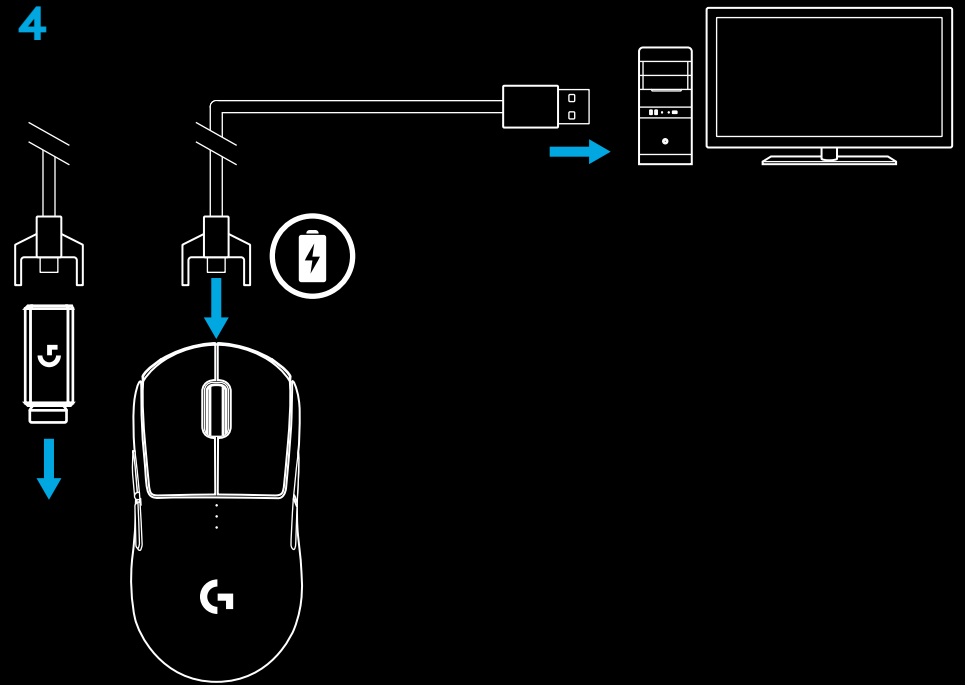

Sugerencias:

- Mantén el mouse y el receptor a más de dos metros de enrutadores inalámbricos o de otros dispositivos inalámbricos de 2,4 GHz para minimizar el ruido ambiental.
- PRO WIRELESS tiene un radio de acción inalámbrico de hasta 10 metros. Para garantizar un desempeño óptimo en entornos inalámbricos con ruido, y para mantener el cable de carga fácilmente accesible, se recomienda mantener el receptor a menos de 20 cm del mouse.

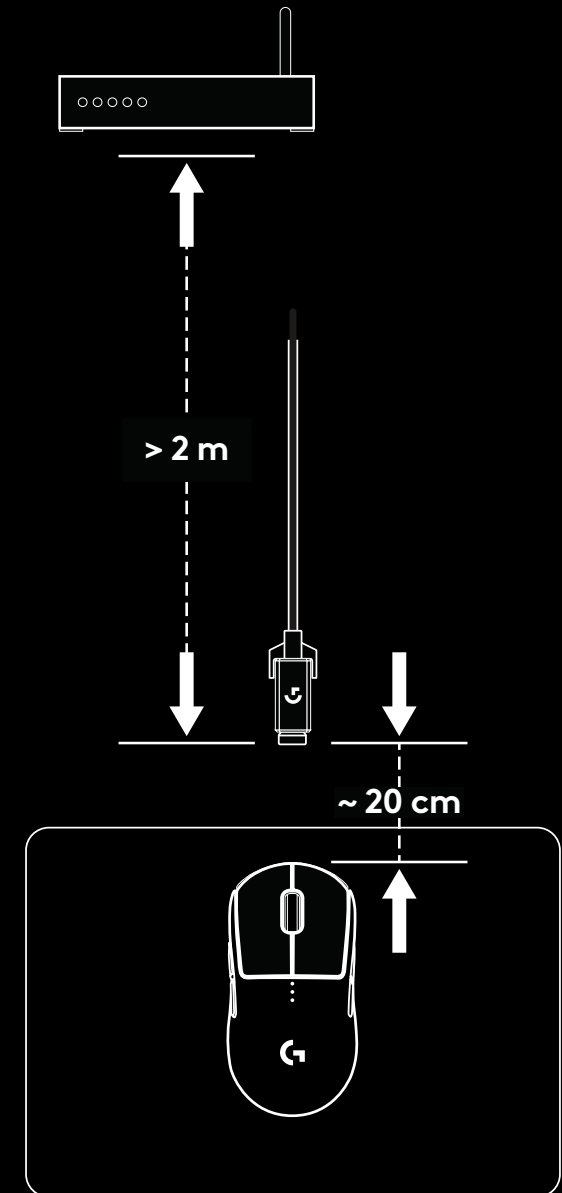
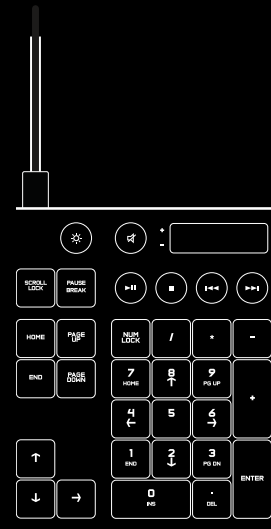

CONFIGURACIONES DE BOTONES

PRO WIRELESS incluye botones y capuchones de botones sustituibles, que se sujetan al mouse magnéticamente. Deberían guardarse en la caja cuando no se usen. Estos botones sustituibles hacen posible la conversión a estas configuraciones:

- 1 Usuario diestro
- 2 Usuario zurdo
- 3 Ningún botón
- 4 Todos los botones

1

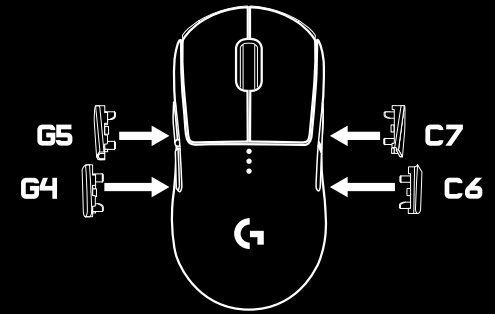
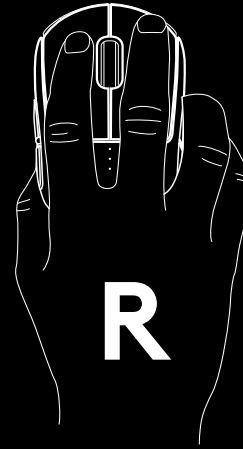

2

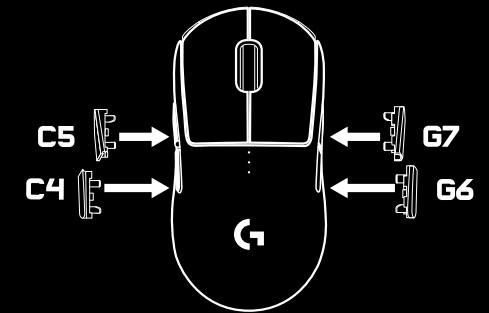
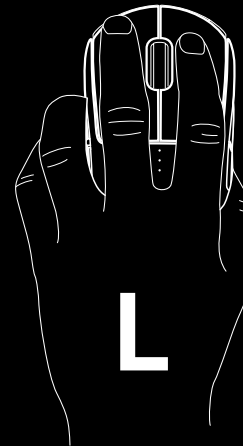

3

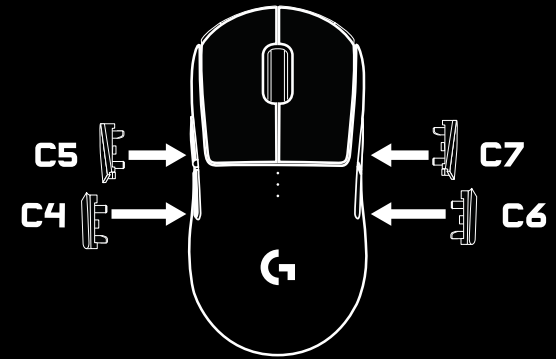

4

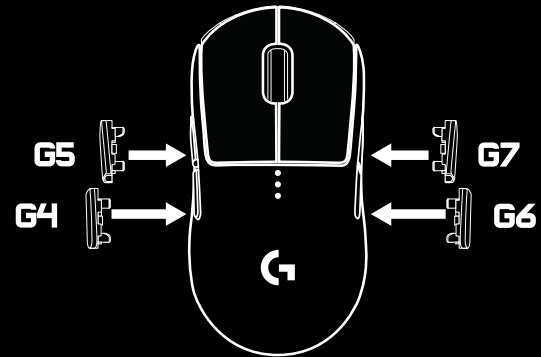

OCHO BOTONES TOTALMENTE PROGRAMABLES

- 1 Izquierda (botón 1)
- 2 Derecho (botón 2)
- 3 Click con botón rueda (botón 3)
- 4 Retroceso (botón G4)
- 5 Avance (botón G5)
- 6 Retroceso (botón G6)
- 7 Avance (botón G7)
- 8 Ciclo de dpi (parte inferior del mouse, botón 8)
- 9 Compartimento de receptor + compartimento de módulo Powerplay (parte inferior del mouse)
- 10 Conmutador de encendido/apagado (parte inferior del mouse, no programable)

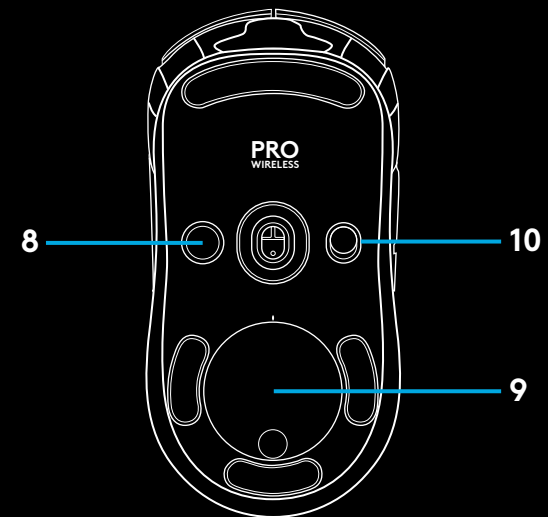

DURACIÓN DE BATERÍAS

PRO WIRELESS tiene una batería recargable de polímero de litio de 250 mAH que proporciona hasta 60 horas de juego ininterrumpido con una velocidad de respuesta de 1 ms con luces apagadas, o 48 horas de juego ininterrumpido con una velocidad de respuesta de 1 ms con ciclo de colores RGB activado.*

- El nivel de carga se puede comprobar al encender el mouse o mediante Logitech Gaming Software para asignar un botón a la comprobación del nivel de carga.
- El nivel de carga se muestra durante siete segundos al encender el mouse mediante el color y el número de barras iluminadas en el indicador de dpi:
 - 3 puntos verdes = 50-100%
 - 2 puntos verdes = 30-50%
 - 1 punto verde = 15-30%
 - 1 punto rojo parpadeante = <15%

Sugerencias:

- Mediante LGS se puede programar un botón para que muestre el nivel de carga.
- El punto inferior emitirá destellos rojos cuando la batería esté al 15% o menos. Cuando esto ocurra, conecta el mouse para cargarlo.
- En Logitech Gaming Software se pueden comprobar el nivel de carga, el consumo de energía y el tiempo estimado de duración de la batería.

*La capacidad y la duración de la batería pueden variar con el tiempo y el uso. Las baterías recargables tienen un número limitado de ciclos de carga.

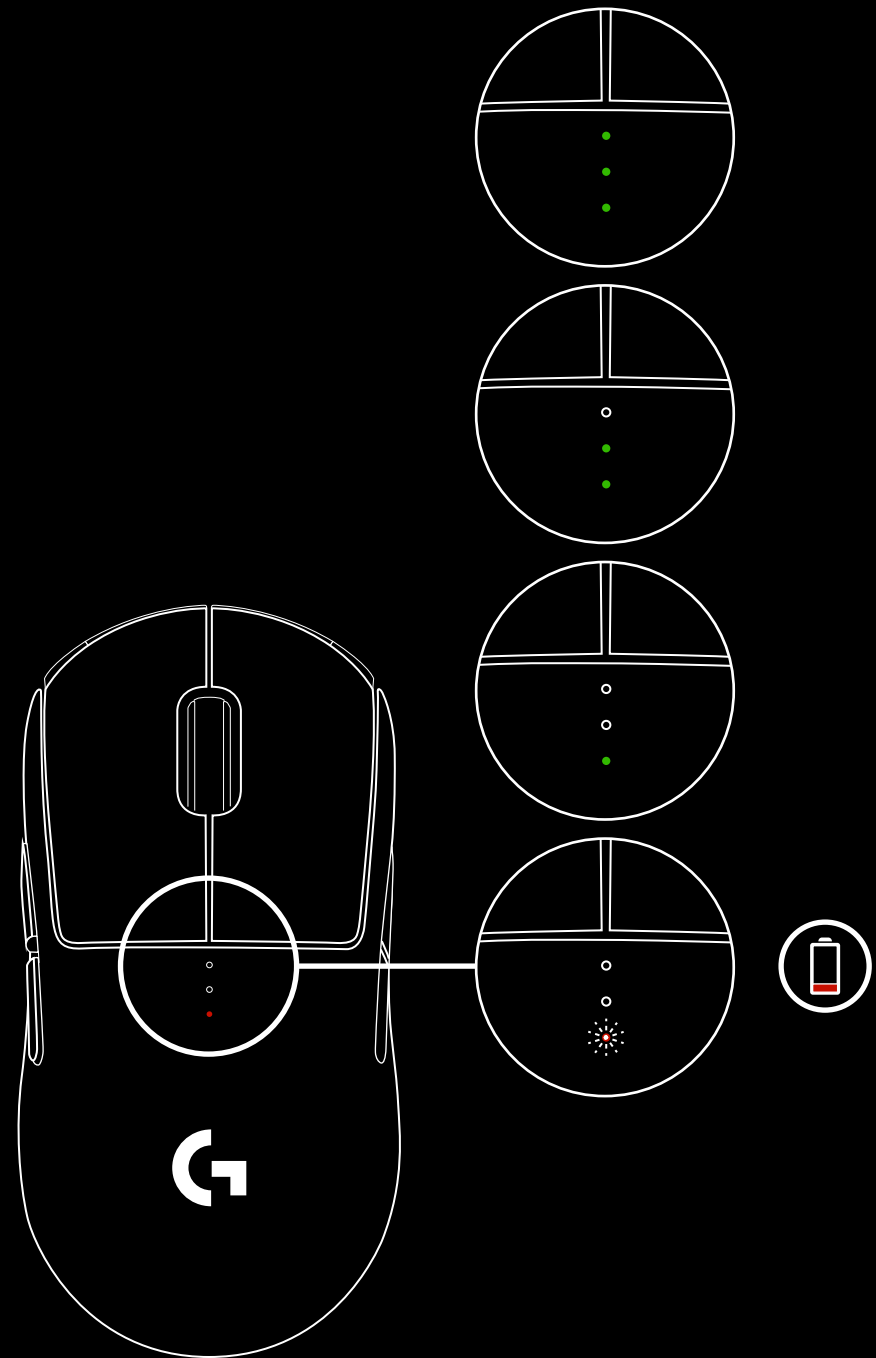

CARGA/DATOS POR CABLE

Cuando la batería se descargue, conecta el mouse mediante el cable de carga USB suministrado. PRO WIRELESS también es compatible con el sistema inalámbrico de carga Logitech G POWERPLAY, a la venta por separado.

LOGITECH GAMING SOFTWARE

Puedes personalizar las configuraciones de perfil integradas utilizando Logitech Gaming Software. Estas configuraciones incluyen programación de botones, velocidad de respuesta, modos de desempeño/resistencia y comportamiento de seguimiento. PRO WIRELESS permite hasta 5 valores de dpi por perfil.

La configuración predeterminada de PRO WIRELESS es la siguiente:

- dpi: 400/800/1600/3200
- Velocidad de respuesta: 1 ms
- Modo de desempeño

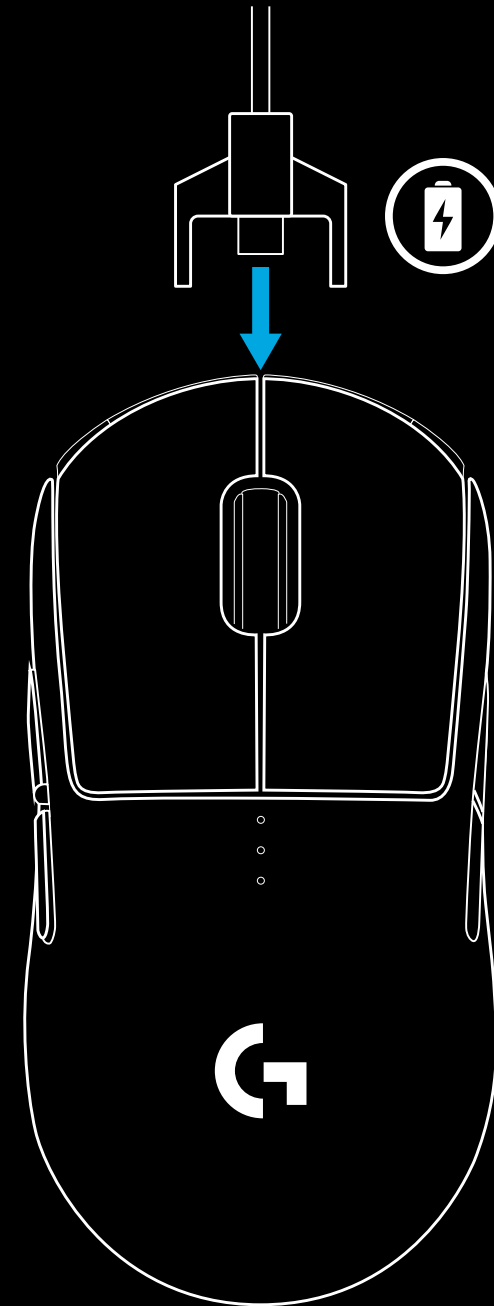

INDICADORES DE DPI/ PERFILES INTEGRADOS

Los valores de dpi/perfiles integrados se muestran mediante tres indicadores LED bajo los botones principales. La imagen siguiente muestra qué valores de dpi se indican en el panel LED.

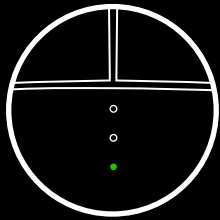

dpi/perfil 1

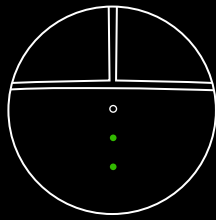

dpi/perfil 2

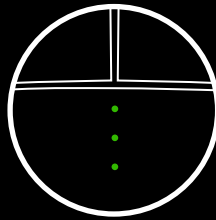

dpi/perfil 3

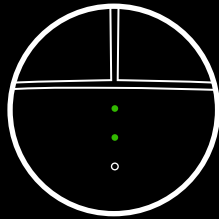

dpi/perfil 4

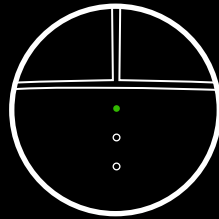

dpi/perfil 5

PREGUNTAS MÁS FRECUENTES

<http://support.logitechG.com/product/pro-wireless>

INSTRUÇÕES DE CONFIGURAÇÃO

- 1 Um receptor sem fio conectado ao adaptador USB pode ser encontrado na caixa de acessórios. Conecte uma extremidade do cabo ao PC e a outra extremidade ao adaptador USB e receptor.
 - O receptor também pode ser usado conectado diretamente ao PC. No entanto, o uso do cabo e do adaptador é recomendado no modo sem fio e permite uma melhor conectividade e fácil acesso ao cabo para recarregar.

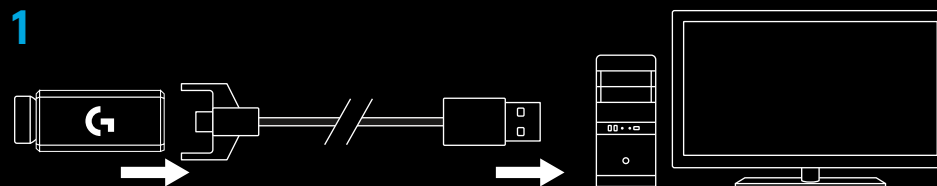

- 2 Ligue o mouse através da chave na parte inferior do mouse.

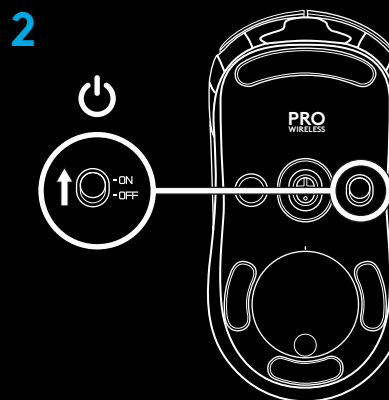

- 3 Fazer download do Logitech Gaming Software



www.logitechG.com/support/pro-wireless

4 Para carregar, desconecte o cabo do adaptador e o conecte à frente do mouse. O mouse funcionará no modo de dados por cabo sempre que estiver conectado diretamente a um PC. A carga total quando a bateria está vazia requer aproximadamente duas horas de conexão à porta USB do PC.

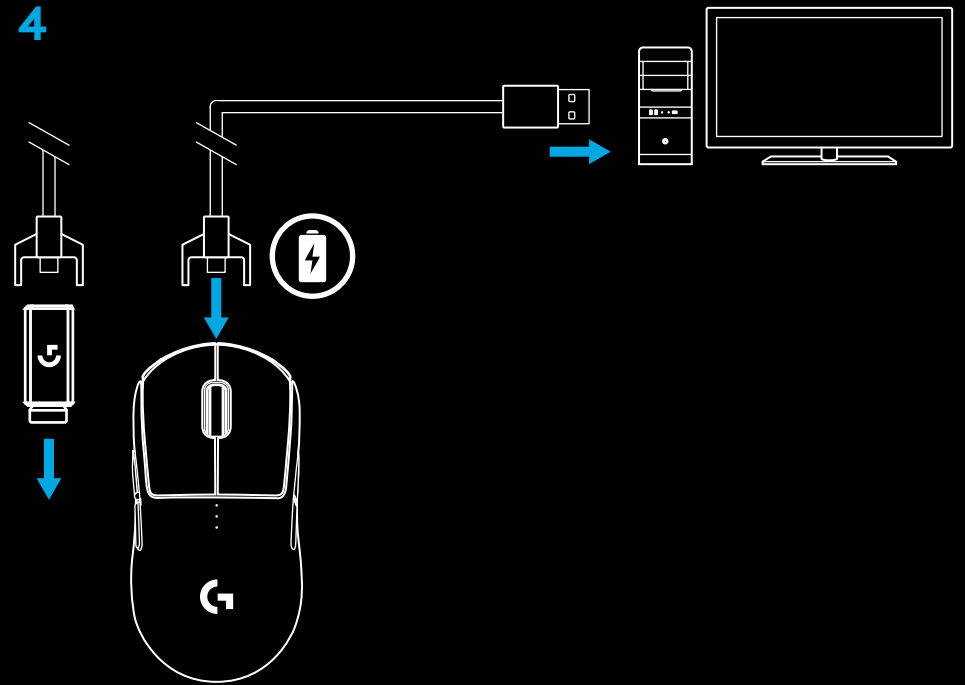

Dicas:

- Mantenha o mouse e o receptor a mais de 2 m de roteadores sem fio ou outros dispositivos sem fio de 2,4 GHz para minimizar a interferência ambiental.
- O PRO WIRELESS tem um alcance de até 10 metros. Para garantir um desempenho ideal em ambientes cheios de dispositivos sem fio, e para manter o cabo de carregamento facilmente acessível, é recomendado manter o receptor a uma distância de 20 cm do mouse.

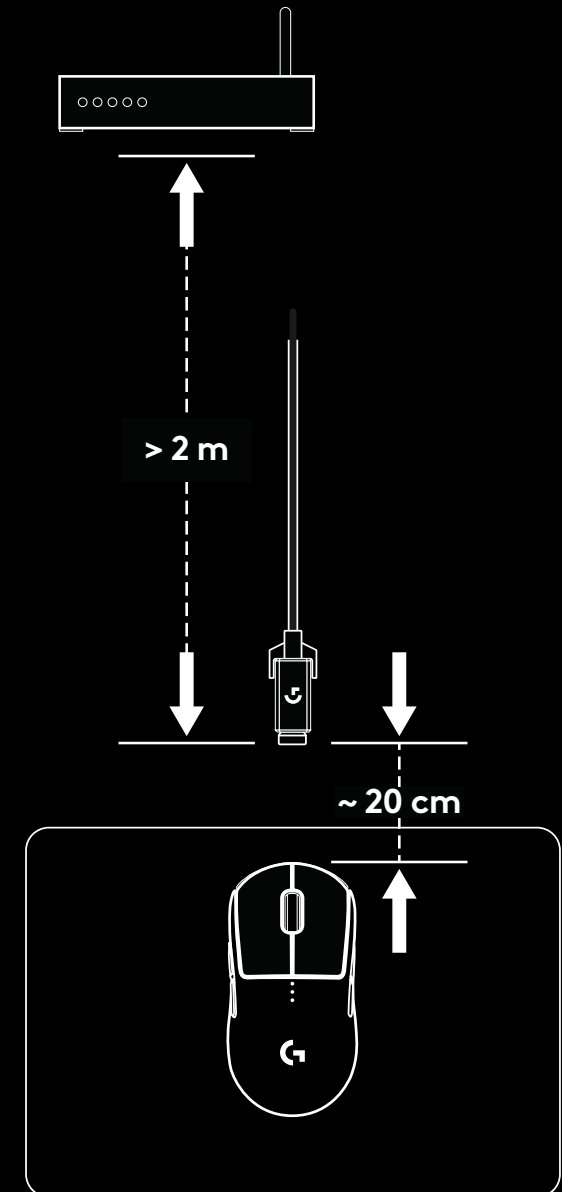
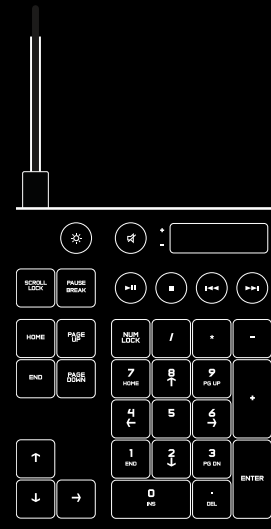

CONFIGURAÇÕES DE BOTÕES

O PRO WIRELESS vem com botões substituíveis e tampas de botão, que são mantidos no mouse magneticamente. Estes devem ser armazenados na caixa quando não estiverem em uso. Esses botões substituíveis suportam a conversão para as seguintes configurações:

- 1 Destro
- 2 Canhoto
- 3 Sem botões
- 4 Todos os botões

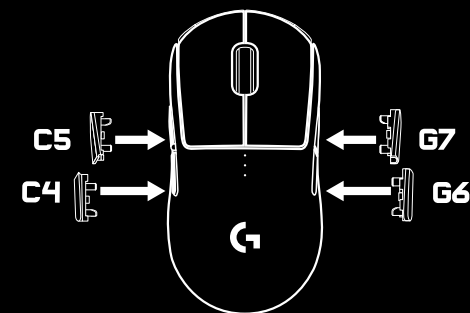
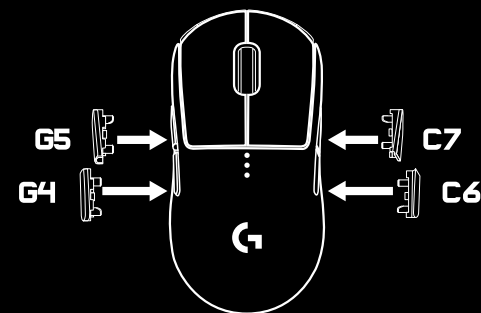
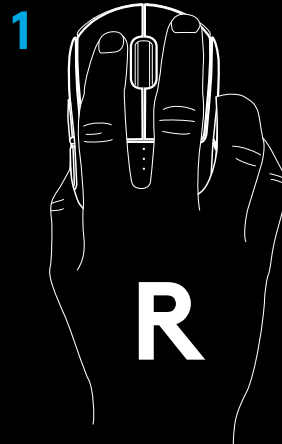

3

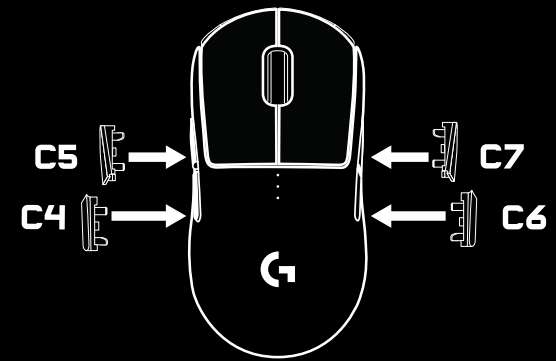

4

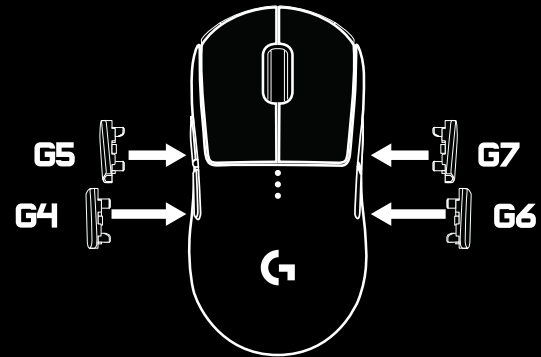

8 BOTÕES TOTALMENTE PROGRAMÁVEIS

- 1 Botão esquerdo (1)
- 2 Botão direito (2)
- 3 Roda clicável (3)
- 4 Voltar (G4)
- 5 Avançar (G5)
- 6 Voltar (G6)
- 7 Avançar (G7)
- 8 Ciclo DPI (parte inferior do mouse, botão 8)
- 9 Tampa do armazenamento do receptor + compartimento do módulo Powerplay (parte inferior do mouse)
- 10 Ligar/desligar (fundo do mouse, não programável)

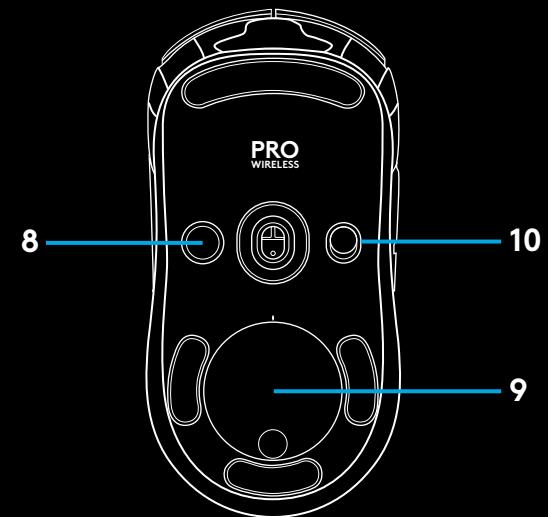

DURAÇÃO DA BATERIA

O PRO WIRELESS possui uma bateria LiPol recarregável de 250 mAH que oferece até 60 horas de jogo sem interrupção a uma taxa de resposta de 1 ms com luzes desligadas, ou 48 horas de jogo sem interrupção a uma taxa de resposta de 1 ms com ciclo de cores RGB ativado.*

- O nível de carga pode ser verificado quando o mouse está ligado ou usando o Logitech Gaming Software para atribuir um botão para verificar o nível de carga.
- O nível de carga é exibido durante sete segundos ao ligar o mouse usando a cor e o número de barras acesas no indicador de DPI:
 - 3 pontos verdes = 50 a 100%
 - 2 pontos verdes = 30 a 50%
 - 1 ponto verde = 15 a 30%
 - 1 ponto vermelha piscando = menos de 15%

Dicas:

- Você pode programar um botão para mostrar o nível de carga usando o LGS.
- O ponto inferior pisca em vermelho quando a bateria está com 15% ou menos. Quando isso acontecer, conecte o mouse para carregar.
- O nível de carga, o consumo de energia e a duração restante da bateria podem ser verificados no Logitech Gaming Software.

*A duração e a capacidade da bateria podem variar com o tempo e uso. Baterias recarregáveis têm um número limitado de ciclos de carregamento.

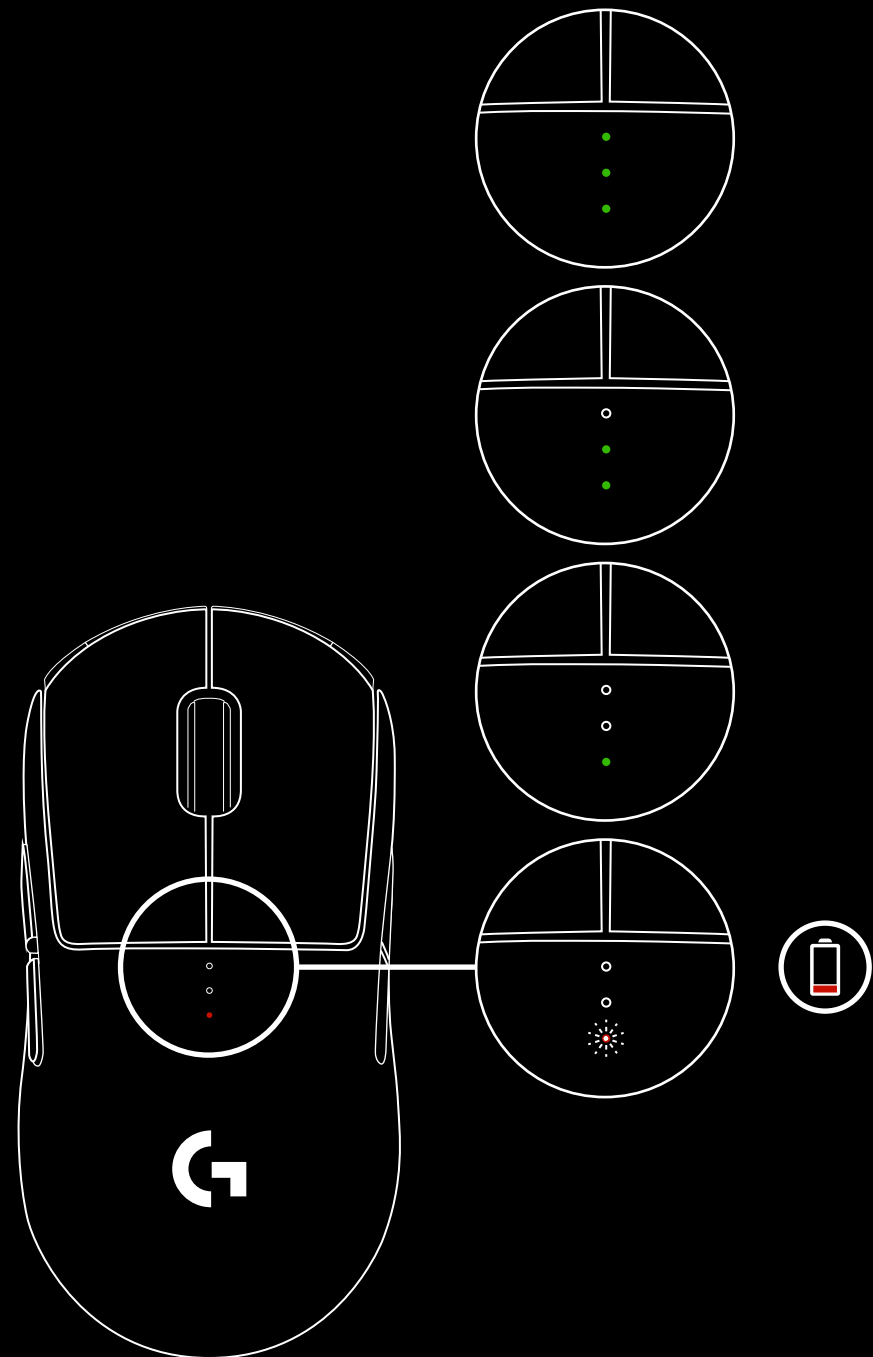

CARREGANDO/DADOS POR CABO

Conecte o mouse através do cabo de carregamento USB fornecido quando a bateria estiver fraca. O PRO WIRELESS também é compatível com o sistema de carregamento sem fio Logitech G POWERPLAY, vendido separadamente.

LOGITECH GAMING SOFTWARE

Você pode personalizar as configurações do perfil internas usando o Logitech Gaming Software. Essas configurações incluem programação de botões, relatório de taxa, modos de desempenho/resistência e comportamento de rastreamento. O PRO WIRELESS permite até cinco configurações de DPI.

Por padrão, o PRO WIRELESS tem as seguintes configurações:

- DPI: 400/800/1600/3200
- Relatório de taxa: 1 ms
- Modo de desempenho

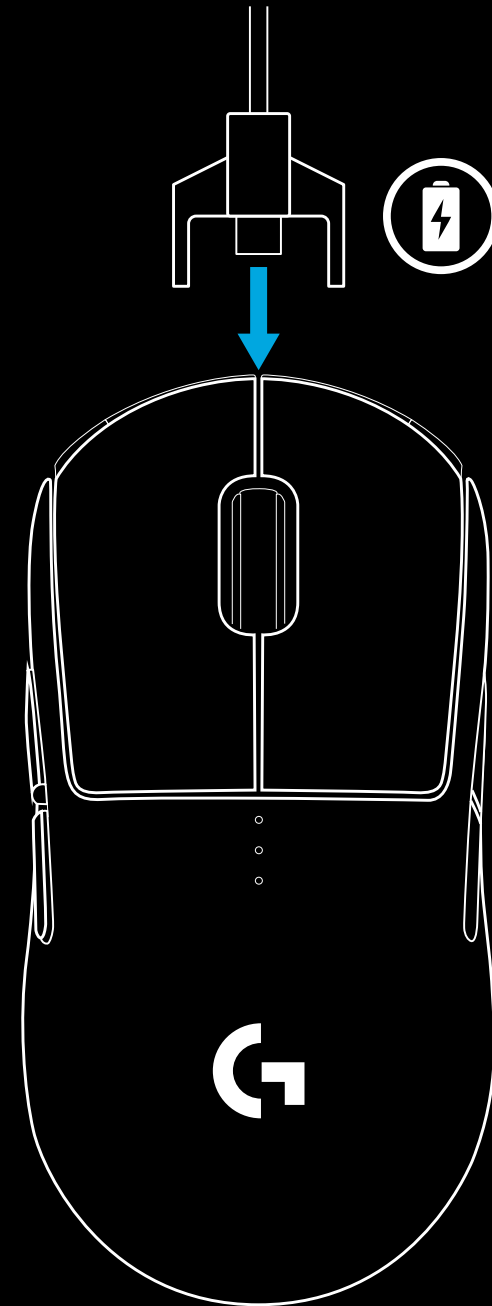

INDICADORES DE PERFIL DE DPI/ INTEGRADO

Os perfis de DPI/integrados são mostrados usando três LEDs sob os botões principais. A imagem abaixo mostra quais valores são indicados pelo painel LED.

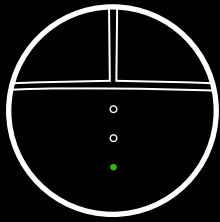

DPI/perfil 1

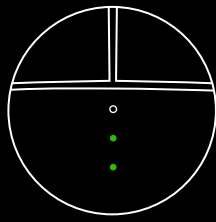

DPI/perfil 2

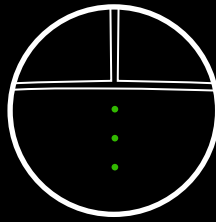

DPI/perfil 3

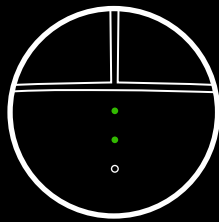

DPI/perfil 4

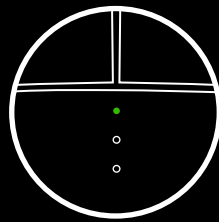

DPI/perfil 5

PERGUNTAS FREQUENTES

<http://support.logitechG.com/product/pro-wireless>



© 2019 Logitech. Logi and the Logitech Logo are trademarks or registered trademarks of Logitech Europe S.A. and/or its affiliates in the U.S. and other countries. All other trademarks are the property of their respective owners. Logitech assumes no responsibility for any errors that may appear in this manual. Information contained herein is subject to change without notice.

© 2019 Logitech. Logitech, Logitech G, ainsi que les logos Logitech et Logitech G sont des marques commerciales ou déposées de Logitech Europe S.A. et/ou de ses sociétés affiliées aux États-Unis et dans d'autres pays. Toutes les autres marques sont la propriété exclusive de leurs détenteurs respectifs. Logitech décline toute responsabilité en cas d'erreurs dans ce manuel. Les informations énoncées dans le présent document peuvent faire l'objet de modifications sans avis préalable.

WEB-621-001129.003