



Questo manuale d'istruzione è fornito da trovaprezzi.it. Scopri tutte le offerte per [Oppo A17](#) o cerca il tuo prodotto tra le [migliori offerte di Cellulari e Smartphone](#)



Questo manuale d'istruzione è fornito da trovaprezzi.it. Scopri tutte le offerte per [Oppo A17](#) o cerca il tuo prodotto tra le [migliori offerte di Cellulari e Smartphone](#)

OPPO Smartphone ColorOS 3.2 User Guide

Content

1. Welcome Page.....	6
2. Safety Information.....	6
3. Get started.....	11
3.1. Quick look.....	11
3.1.1. ColorOS 3.2 Features.....	11
3.1.2. ColorOS 3.2 Applicable products and specifications.....	13
3.1.3. Buttons and components.....	21
3.1.4. Sleep/Wake button.....	24
3.1.5. Menu, Home and Return buttons.....	25
3.1.6. Volume buttons.....	34
3.1.7. Micro-USB port.....	36
3.1.8. Headset jack.....	37
3.1.9. SIM and SD cards.....	37
3.1.10. Accessories came with OPPO phone.....	39
3.1.11. Charge the battery.....	41
3.1.12. Gesture & Motion.....	42
3.1.13. Key combinations.....	48
3.1.14. Status Icons.....	51
3.2. Configure settings.....	54
3.2.1. Google account.....	54
3.2.2. Fingerprint, Face and Passcode.....	56
3.2.3. Set up other mail and calendar accounts.....	65
3.2.4. Transfer data with Clone Phone.....	65
3.2.5. Date and Time.....	70
3.2.6. Language and Region.....	71
3.2.7. Connect to the Internet.....	73
3.3. Instructions.....	74
4. What's new in ColorOS 3.2.....	75
4.1. Face ID.....	75
4.2. Virtual Navigation Keys.....	80
4.3. Game Acceleration.....	85
4.4. Enhanced Security Mechanism.....	89
4.5. Search Settings and Files.....	92
4.6. Optimized File management.....	93
4.7. Auto Recording.....	97
4.8. Reset password with fingerprint.....	101
4.9. Reset password with fingerprint.....	104

4.10. Control the volume.....	107
5. Basics.....	109
5.1. Use apps.....	109
5.2. Share from apps.....	111
5.3. One-click cleanup.....	112
5.4. Lock the running background apps.....	114
5.5. View, zoom in and out.....	115
5.6. Navigation Keys.....	117
5.7. Change the screen orientation.....	125
5.8. Multiple modes with easy access.....	126
5.9. Take a screenshot.....	127
5.10. Notification and Status Bar.....	130
5.11. Personalize your Control Center.....	134
5.12. Search.....	136
5.13. Text.....	137
5.13.1. Add or change keyboard languages.....	137
5.13.2. Type, edit and delete text.....	140
5.13.3. Smart input.....	143
5.13.4. Voice typing.....	145
5.13.5. TouchPal for OPPO.....	147
5.14. Sound, Vibration and System Feedback.....	149
5.15. Charge and monitor the battery.....	151
5.16. Location Service.....	154
5.17. Use the phone internationally.....	156
5.18. Power Saving Mode.....	157
6. Personalize your OPPO phone.....	158
6.1. ColorOS 3.2 device name.....	158
6.2. Personalize the Home screen.....	159
6.2.1. Organize the Home screen.....	159
6.2.2. Home screen widgets & Transition Effects.....	164
6.3. Change the wallpaper.....	166
6.4. Lock screen magazine.....	167
6.5. Adjust the screen brightness and color temperature.....	169
6.6. Change auto-screen lock time.....	171
6.7. Change the text size.....	172
6.8. Keyboard and input method.....	173
6.8.1. Customize the look of the keyboard.....	173
6.8.2. Split keyboard.....	175
6.8.3. Trends.....	176
6.8.4. Keyboard general settings.....	177
6.9. Set up Startup Manager.....	179
6.10. Clone Apps.....	180
6.11. Manage Default App.....	181
6.12. Gesture & Motion.....	182

6.13. Timing Power On/Off.....	186
6.14. Game Acceleration.....	189
6.15. App display in full-screen.....	193
7. Apps.....	194
7.1. Phone.....	194
7.1.1. Make and Answer Phone Calls.....	194
7.1.2. Conference calls.....	202
7.1.3. Block calls.....	203
7.1.4. Emergency calls.....	205
7.1.5. Auto Recording.....	205
7.1.6. Operator's Call Related Settings.....	210
7.2. Messages.....	212
7.2.1. Send and receive messages.....	212
7.2.2. Customize message settings.....	214
7.3. Contacts.....	216
7.3.1. Add a contact.....	216
7.3.2. Edit and delete a contact.....	218
7.3.3. Import and export contacts.....	221
7.3.4. SIM contacts.....	223
7.3.5. Manage contacts.....	225
7.3.6. Back up your contacts.....	228
7.4. Phone Manager.....	230
7.4.1. Scan and optimize the phone.....	230
7.4.2. Cleanup & Accelerate.....	231
7.4.3. Privacy Permissions.....	233
7.4.4. Virus Scan.....	234
7.4.5. Payment protection.....	234
7.4.6. Frequently Used Functions.....	235
7.5. Weather.....	238
7.6. Cameras.....	241
7.6.1. Take photos.....	241
7.6.2. Take a selfie.....	247
7.6.3. Shoot video.....	252
7.6.4. Camera settings.....	253
7.7. Photos.....	254
7.7.1. Photos overview.....	254
7.7.2. Albums.....	256
7.7.3. View and use photos and videos.....	260
7.8. Music.....	265
7.8.1. Music.....	265
7.8.2. Change sort mode.....	268
7.8.3. Scan local songs.....	269
7.9. Videos.....	271
7.10. Theme Store.....	274

7.10.1. Online phone theme.....	274
7.10.2. Online wallpaper.....	275
7.10.3. My profile.....	276
7.10.4. Manage your downloads.....	278
7.11. Clock.....	279
7.11.1. Set Alarm Clocks.....	279
7.11.2. Add and view clocks for locations around the world.....	283
7.11.3. Use the stopwatch.....	284
7.11.4. Set the timer.....	284
7.12. Files.....	285
7.12.1. Fast file browsing.....	285
7.12.2. View and manage files.....	286
7.12.3. Fast cleanup.....	288
7.12.4. Remote Management.....	290
7.12.5. File Safe.....	291
7.13. Calculator.....	293
7.14. Sound Recorder.....	294
7.14.1. Record.....	294
7.14.2. Manage recordings.....	296
7.15. Compass.....	298
7.16. Chrome.....	300
7.16.1. Search the web.....	300
7.16.2. Browse the web.....	302
7.16.3. Quick Access.....	308
8. Safety & Privacy.....	310
8.1. Device security.....	310
8.1.1. Lock screen password.....	310
8.1.2. Smart Lock.....	312
8.1.3. Safe keyboard.....	313
8.1.4. Payment protection.....	314
8.1.5. Set up a SIM card lock.....	315
8.1.6. Virus Scan.....	317
8.1.7. Pseudo Base Station Blocking.....	318
8.2. Device administration.....	320
8.2.1. Allow and install apps from unknown sources.....	320
8.2.2. App Encryption.....	321
8.2.3. App permissions.....	322
8.2.4. Kids Space.....	323
8.2.5. Block unwanted calls and messages.....	324
8.2.6. Find my device.....	326
8.3. Privacy.....	328
8.3.1. Location Service.....	328
8.3.2. Join User Experience Project.....	329
8.3.3. Security Warning.....	330

8.4. Advanced--Screen pinning.....	332
9. Share Internet connection and files.....	334
9.1. Tether your phone's Internet connection.....	334
9.2. Share files.....	338
9.2.1. Wireless file sharing.....	338
9.2.2. Wired file sharing.....	343
9.2.3. Share from apps.....	345
10. Restart, update, reset, and restore.....	346
10.1. Restart the phone.....	346
10.2. Update your software version.....	347
10.3. Backup and restore the phone.....	349
10.3.1. Back up your OPPO phone.....	349
10.3.2. Restore data on your phone.....	350
10.4. Reset the phone.....	354
11. Accessibility.....	357
11.1. TalkBack.....	357
11.2. Magnification Gestures.....	359
11.3. End Calls with the Power Button.....	361
11.4. Speak password.....	362
12. Safety, handling and support.....	363
12.1. Health and Safety.....	363
12.1.1. Using Environment.....	363
12.1.2. Battery Safety.....	364
12.1.3. Charger Usage Notes.....	366
12.1.4. Traffic Safety.....	367
12.1.5. Electromagnetic (EM) Radiation.....	368
12.1.6. Other Important Safety Information.....	368
12.2. Maintenance and Repair.....	370
12.2.1. Phone Cases.....	370
12.2.2. Screen Protector.....	370
12.2.3. Maximize battery life and lifespan.....	370
12.2.4. Keeping Clean.....	372
12.2.5. Keeping Dry and Solving Water Damage.....	373
12.2.6. Use Connectors, Ports and Buttons.....	373
12.2.7. Other Maintenance and Repairing Information.....	374
12.3. OPPO Mobile Warranty Information.....	375

1. Welcome Page



2. Safety Information

Read through the following information carefully. Failure to follow these safety precautions could result in danger or illegal activities.

Safe Startup

Do not switch on the device when phone use is prohibited or when it may cause interference or danger.



Traffic Safety First

Traffic safety is always of first importance. Use of phones and headphones while driving a vehicle or riding a bicycle is not recommended and is illegal in some areas. Obey and follow all related local laws.



Switching off at Gas Stations

Turn off your phone when in any area with a potentially explosive atmosphere, such as gas stations or any other fueling area. Sparks in such areas could cause an explosion or fire, resulting in serious injury or even death.



Switching off When Taking an Airplane

Wireless devices might be prohibited while in the air in some countries or regions. Obey all related local laws and turn off your phone or switch to airplane mode.



Switching off near Medical Equipment

Hospitals or healthcare facilities might use radio-frequency-sensitive equipment. Obey the relevant rules and regulations.



Switching off at Blasting Areas

To avoid interfering with blasting operations, turn off your phone when in a

“blasting area” or in areas posted “Turn off two-way radio.” Obey all signs and instructions.

Radiation

Nearly every electronic device gives off radiation. Mobile phone use does not increase the risk of getting brain cancer or other head tumors. Its effect in humans is negligible.

Interference

Nearly every electronic device is susceptible to interference for external sources if inadequately shielded or designed. As a result, your phone may cause interference with other devices.

Temperature

Operate your phone in a place where the temperature is always between 10°C to 45°C. Using or storing your phone in a too hot or too cold environment might damage the battery, or even cause your phone to short-circuit or burn.

Proper Usage

Use your phone appropriately. Do not touch the antenna area unnecessarily when the phone is turned on. Do not drop, disassemble, crush, bend, deform, puncture, incinerate, or insert foreign objects into your phone.

Qualified Maintenance and Service

Never attempt to repair or modify the phone yourself. If your phone has any hardware or software failure, do not use it until you take it to an authorized service provider. Do not disassemble or root your phone yourself, otherwise the warranty service will be terminated immediately.

Batteries, Chargers and other Accessories

Do not dismantle the built-in lithium-ion battery of your device. Use only the batteries, chargers and other accessories authorized by OPPO, for third-party accessories might cause damage or danger.

Waterproofness

Your device is not waterproof. Do not use your device in rain, or other wet locations.

Avoiding Hearing Damage

Permanent hearing loss may occur if the receiver, speakerphone, headphones, or earpieces are used at high volume. You can adapt over time to a higher

volume of sound that may sound normal but can be damaging to your hearing. Set the volume to a safe level to protect your hearing.

Avoiding Eyestrain

Your device's screen color and brightness might have a different degree of stimulation to your eyesight. Long-term viewing of your phone in normal or darker environments will damage your eyesight. When watching video or reading text on your phone, avoid prolonged use, take breaks and turn on eye protection mode to prevent eyestrain.

Glass Parts

The outside cover of your phone's screen, front/rear camera and flash is made of glass. This glass could break if your phone is dropped on a hard surface or receives a substantial impact. Do not attempt to touch or clean the broken glass. Stop using your phone until the glass is replaced by an authorized service provider.

Connecting to Other Devices

Before connecting to other devices, carefully read the user manual for more detailed, accurate and safety instructions. Do not connect to incompatible products.

Being Aware of Laser Safety

If your phone supports laser focusing, carefully read this user manual before using it. Failure to follow the instructions might lead to harmful radiation exposure. To prevent direct exposure to laser beam, do not attempt to open your phone's outer shell, or keep close contact with laser light.

3. Get started

3.1. Quick look

3.1.1. ColorOS 3.2 Features

ColorOS 3.2 is designed to make OPPO smartphones more convenient, fluid and intelligent for every user. It is jam-packed with thoughtful and easy-to-use functions such as facial recognition, game acceleration, power saving mode, eye protection mode, kid space, and more. These make ColorOS 3.2 a close assistant beyond a system.

Better visual experience

- **Give you a larger view.** A limitless screen design gives you a beautiful visual effect. It could have content extended to the edges of the screen, and let you see a larger world. ColorOS 3.2 devices have their fingerprint sensor relocated to the rear to make the screen to body ratio more than 80 percent.



- **Virtual navigation keys.** ColorOS 3.2 replaces the physical Home Button with fast and fluid gestures, also offers you virtual navigation keys to operate your phone. The virtual keys follow the typical order for OPPO - recent apps, home, and return from left to right. If you are left-handed, you can also switch their order yourself. The system also set multiple colors for the navigation background to match the color scheme of the popular apps. See Navigation keys.

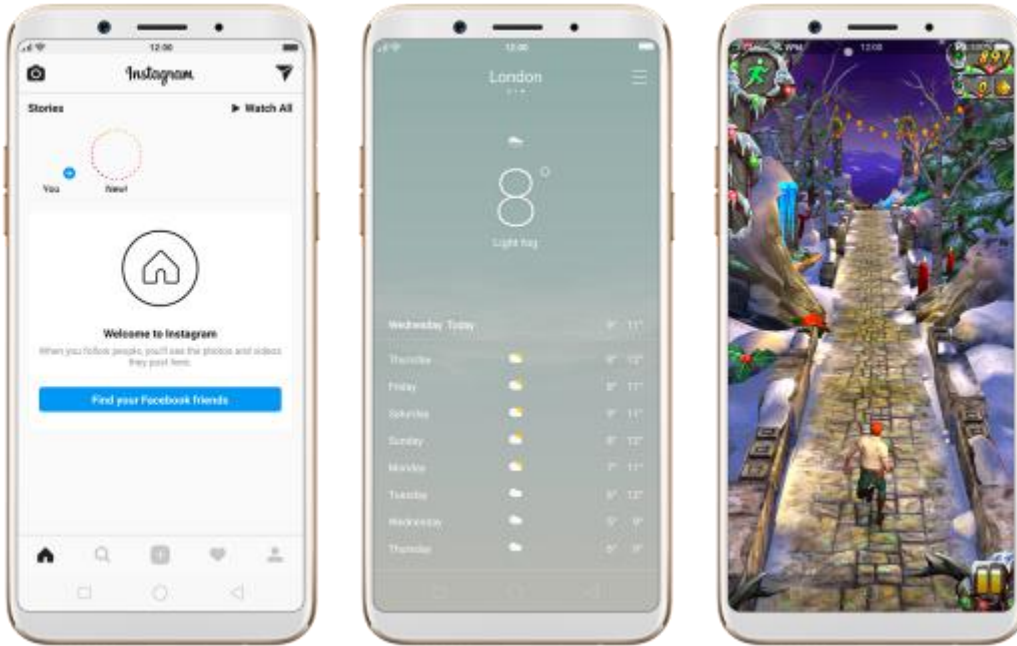

Facial Recognition

A major highlight of the new features is the Facial Recognition which can identify up to 128 facial recognition spots while clicking selfies. With Facial Recognition, you just need to pick up and wake your phone, then it unlocks the instant you look at it, quickened to 0.08s. It does a great help if you've had trouble with your fingerprints over time. See Face ID.

3.1.2. ColorOS 3.2 Applicable products and specifications

Models

R11s / R11s Plus

F5 / F5 Youth

A83

Appearance

R11s / R11s Plus

Black

Champagne

Red (Limited / R11s only)

F5 / F5 Youth

Gold

Red (F5 only)

Black

A83

Champagne

Black



Height

155.1mm (R11s)

164.8mm (R11s Plus)**Height****156.5mm****Width**

75.5mm (R11s)

80.2mm (R11s Plus)**Width**

76mm

Thickness

7.1mm (R11s)

7.3mm (R11s Plus)**Thickness**

7.5mm

Weight

153g (R11s)

182g (R11s Plus)

Weight

152g

Operating System

ColorOS 3.2, based on Android 7.1

Operating System**ColorOS 3.2, based on Android 7.1**

GPU

Adreno 512

GPU

ARM Mali G71 MP2 770MHz

RAM

4GB (R11s)

6GB (R11s Plus)

RAM

4GB (F5)

6GB (F5)

3GB (F5 Youth)

Storage

64GB (Expandable up to 256GB)

Storage

32GB (Expandable up to 256GB) (F5 4GB / F5 Youth)

64GB (Expandable up to 256GB) (F5 6GB)

Battery

3205mAh (R11s)

4000mAh (R11s Plus)

Battery

3200mAh

Processor

Qualcomm SDM660

Processor

Octa-core MT6763T (F5)

MT6763T (F5 Youth)

Size

6.01 inches (R11s)

6.43 inches (R11s Plus)

Size

6.0 inches

Type

AMOLED

Type

LTPS TFT

Resolution

FHD+(2160 by 1080 pixels)

Resolution

FHD+(2160 by 1080 pixels)

Colors

16 million colors

Colors

16 million colors

Touchscreen

Multi-touch, Capacitive Screen

Touchscreen

Multi-touch, Capacitive Screen

Rear Sensor

20-megapixel,16-megapixel

Rear Sensor**16-megapixel (F5)****13-megapixel (F5 Youth)****Front Sensor**

20-megapixel

Front Sensor

20-megapixel (F5)

16-megapixel (F5 Youth)

Flash

LED Flash

Flash

LED Flash

Aperture

Rear: f/1.7

Front: f/2.0

Aperture

Rear: f/1.8 (F5)

Rear: f/2.2 (F5 Youth)

Front: f/2.0

Frequencies

GSM: 850/900/1800/1900MHz

WCDMA:

850/900/1700/1900/2100MHz

FDD-LTE:

Frequencies**FDD: B1/2/3/5/7/8/20/28****TDD: B38/39/40/41****WCDMA: B1/2/5/8****GSM: 850/900/1800/1900****Frequencies****FDD: B1/3/5****TDD: B38/40****WCDMA: B1****GSM: 850/900**

Bands 1/2/3/4/5/7/8/20/28

TD-LTE:

Bands 38/39/40/41(2535-2655)

SIM Card Type	SIM Card Type	SIM Card Type
Dual Nano-SIM Cards	Dual Nano SIM Cards & Micro SD Card (Total 3 slots)	Dual Nano SIM Cards & Micro SD Card (Total 3 slots)
GPS	GPS	GPS
Supported	Supported	Supported
Bluetooth	Bluetooth	Bluetooth
4.2	4.2	4.2
Wi-Fi	Wi-Fi	Wi-Fi
2.4/5GHz 802.11 a/b/g/n/ac	2.4/5GHz 802.11 a/b/g/n	2.4/5GHz 802.11 a/b/g/n
OTG	OTG	OTG
Supported	Supported	Supported
NFC	NFC	NFC
No	No	No

Proximity Sensor

Distance sensor (F5)

Light sensor

Proximity Sensor (F5 Youth)

G-sensor

Light sensor

E-compass

G-sensor

Gyro Sensor

E-compass

In the Box

OPPO R11s / **R11s Plus**

OPPO F5 / F5 Youth

OPPO A83

Earphones

Earphones

Earphones

Micro USB cable

Micro USB cable

Micro USB

Charger

Charger

cable

SIM ejector tool

SIM ejector tool

Charger

Documentation

Documentation

SIM ejector

Case

Case

tool

Documentation

n



3.1.3. Buttons and components

F5 features

A. Front camera

B. Receiver

C. Sleep/Wake button

D. Volume up button

E. Volume down button

F. Rear camera

G. Flash

H. SIM card tray

I. SIM tray hole

J. Noise cancelling microphone

K. Speaker

L. Micro-USB port

M. Microphone

N. Headset jack

Control Center

Swipe up from the bottom edge of the screen to open control center, which

gives you easy access to Wi-Fi, Mobile data, Bluetooth, GPS, OPPO Share, Nightly Shield, Flashlight, Calculator, Clock and camera. You can also use it to adjust the brightness, boost your phone, disable Bottom keys and go to settings. If you want to change or rearrange the shortcuts, or add other shortcuts, swipe right and click "More".

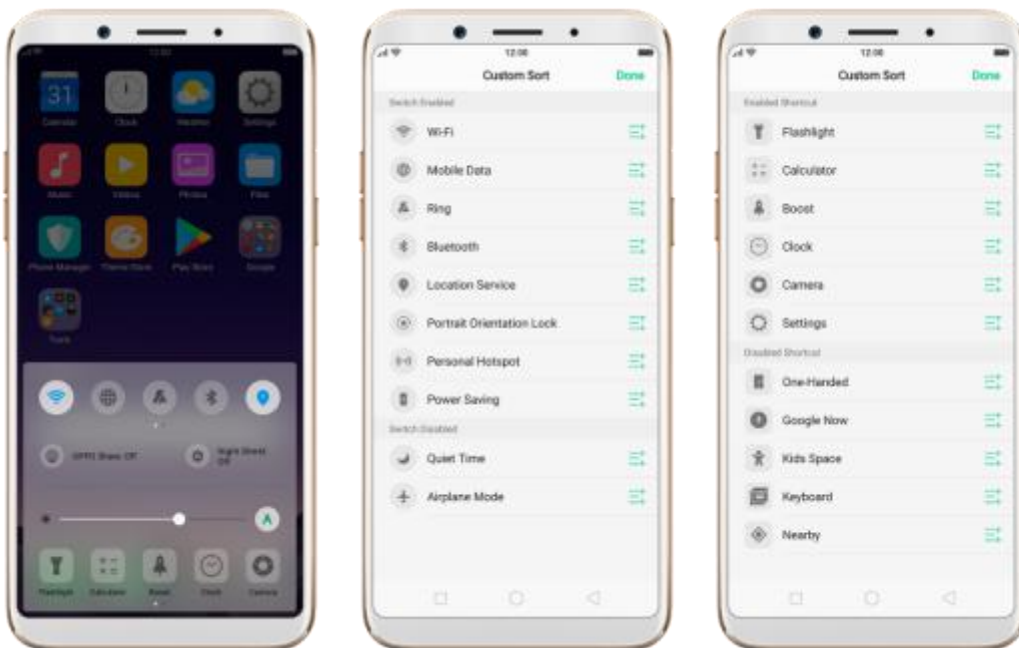

Notification center

Swipe down from the top edge of the screen to open notification center, which brings all your information into one location, and allows you to manage all the alerts from different apps. Press a notification to respond to it, or swipe a notification left for settings or deleting it.



3.1.4 Sleep/Wake button

The **Wake/Sleep** button on the right side of your phone has a number of different uses.

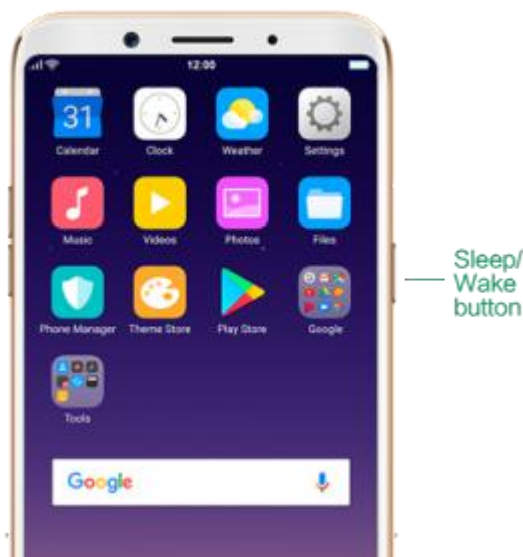

When R11 is on

Wake or lock the screen: With the phone powered on, press the **Wake/Sleep** button once will wake the phone up to the point that you can see the lock screen, like the clock and any notifications that are setup to display there.

When the phone screen is wakened, press this button will blacken the screen and lock the phone.

Take a screenshot: Press and hold the **Sleep/Wake** and **Volume Down** buttons at the same time, your phone will take a picture of whatever was displayed on the screen. The image is saved in the Photos app.

Take a long screenshot: Press and hold the **Sleep/Wake** and **Volume Up** buttons at the same time, your phone will capture a long screenshot.

End a call: Go to [Settings] > [Additional Settings] > [Accessibility] and turn on [Power Button Ends Call], then you can press the **Sleep/Wake** button to end phone calls.

Turn off the phone: Press and hold the **Sleep/Wake** button for a few seconds, whether the phone is on the lock screen or home screen, it will ask you to slide down to power off the device.

Force restart the phone: Press and hold the **Sleep/Wake** and **Volume Up** buttons for at least 5 seconds until your device is turned on to force restart your phone.

When R11 is off

Turn on the phone: Press and hold the **Sleep/Wake** button for a few seconds, and the phone will turn on.

Force restart the phone: Press and hold the **Sleep/Wake** and **Volume Up** buttons until your device is turned on to force restart your phone.

Enter Recovery Mode: Press and hold the **Sleep/Wake** and **Volume Down** buttons at the same time to enter Recovery Mode.

3.1.5.Menu, Home and Return buttons

ColorOS 3.2 replaces the traditional hardware buttons with on-screen virtual navigation keys, also offers you fast and fluid *gestures* to operate your phone. You can change the order of the virtual keys, and set them to appear only when needed to free space on the screen.

Enable virtual navigation keys. Virtual navigation keys are default on. If you want to enable them manually, go to **[Settings]** > **[Additional Settings]** > **[Navigation Keys]** and click Virtual Navigation Keys.

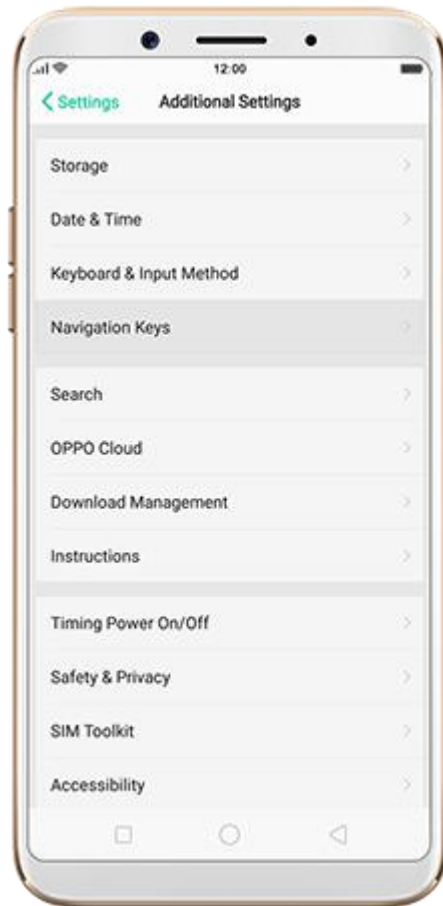
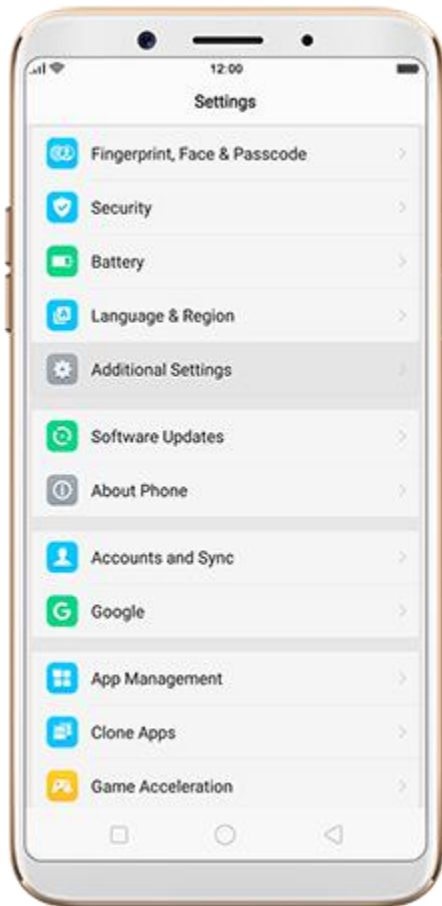

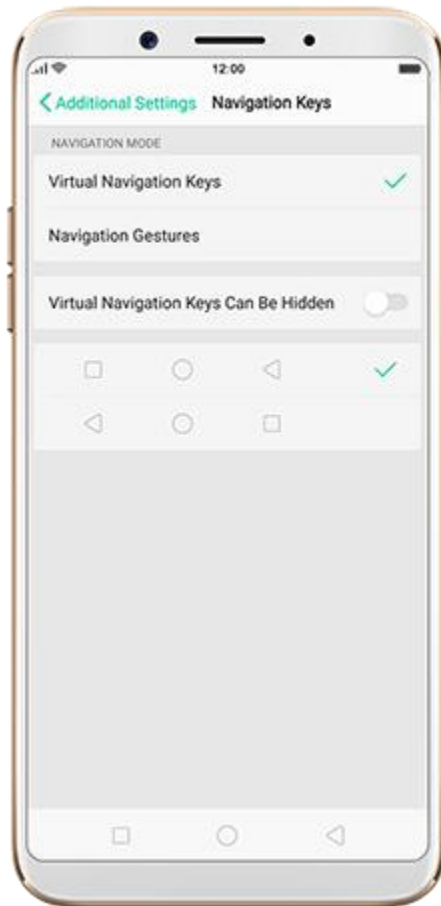

Change the order of virtual navigation keys. The keys follow the typical order for OPPO: Menu, Home, and Return from left to right. If you are left-handed, you can change them to the return-home-recent order.

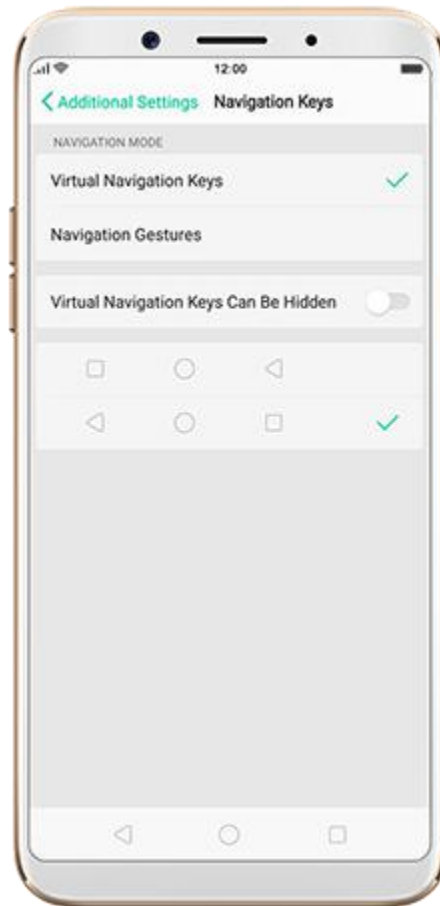

Hide the virtual navigation keys. When you launch a full-screen app, the keys will automatically hide, and can be brought back with a simple swipe:

- When in portrait mode, swipe up from the bottom.
- When in landscape mode, swipe from the bottom to the left.





Manually hide the virtual navigation keys. To set the keys to appear only when needed, go to **[Settings] > [Additional Settings] > [Navigation Keys]** and enable Virtual Navigation Keys Can Be Hidden. Then you can click  on the left-lower corner of the screen to hide the keys, and swipe from the bottom to reveal them.

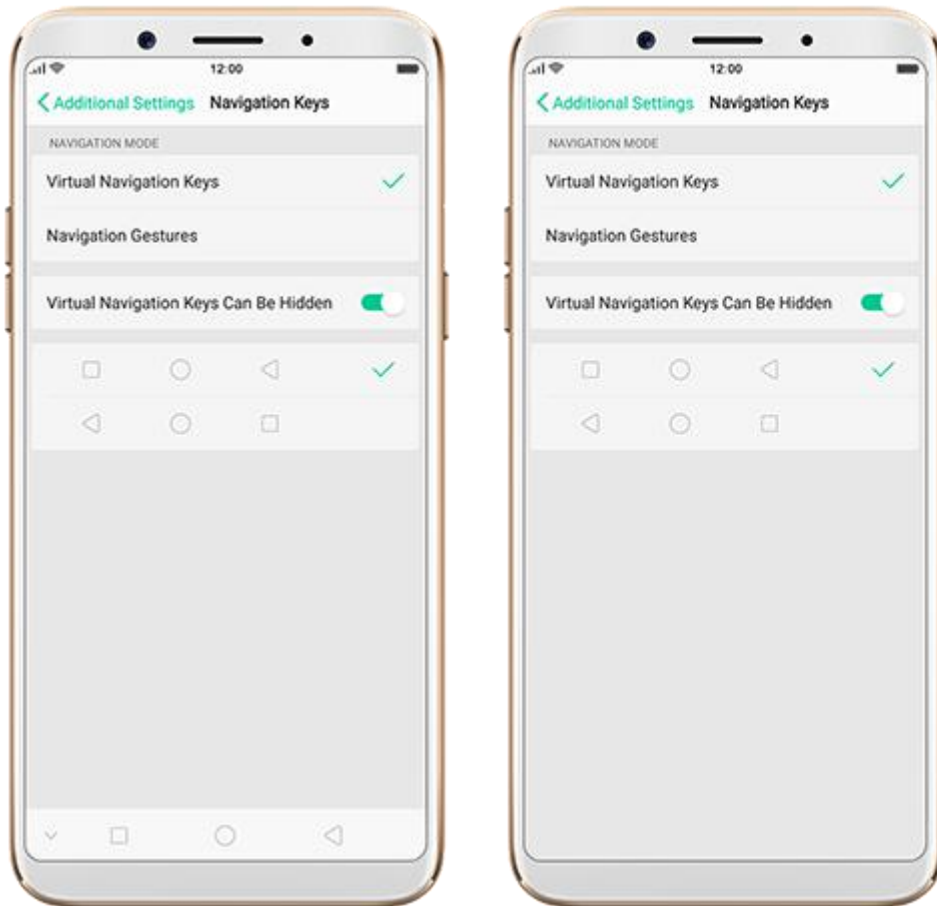

Immersive navigation background. The system set multiple colors for the navigation background to match the color scheme of the popular apps. The background color is default white, and it will become translucent or immersive when you open some of the third-party apps.

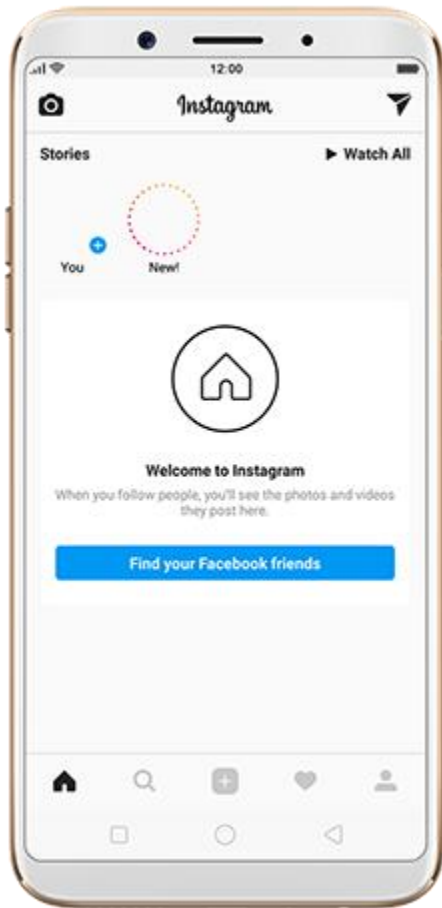

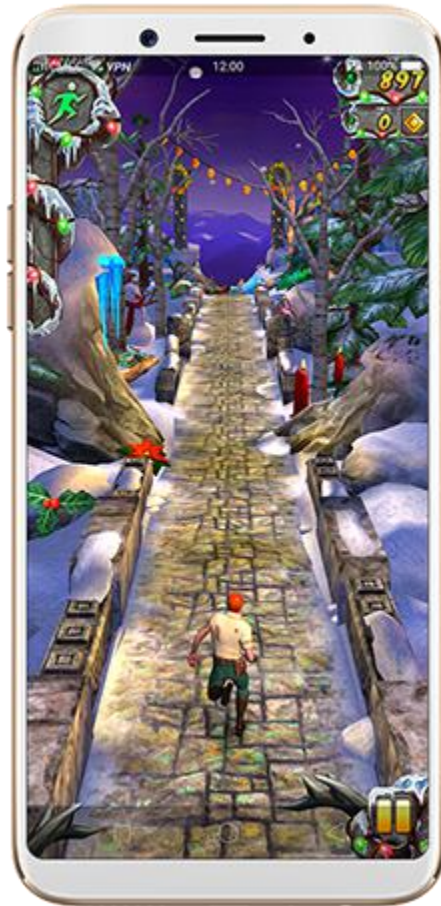

3.1.6. Volume buttons

Volume buttons give you easy access to adapt over time to a proper volume of sound. It refers not simply ringer or media, F5 also keeps track of the volume level separately in headphone, microphone and speaker.

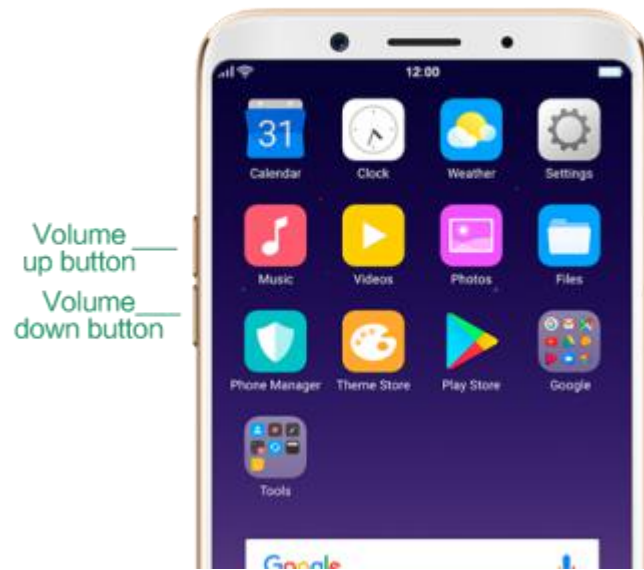

Media volume: When listening to music, videos and phone calls, use the buttons on the side of the phone to adjust the volume. For information about avoiding hearing loss, see Security Information.

Ringer volume: You can also use the volume buttons to control the volume for the ringer and alerts. When you press and hold the **volume down** button, your phone will switch to silent mode.

Call volume: When making or receiving phone calls, use the volume buttons to adjust the volume of the call.

* You can also adjust the volume (except call volume) in [Settings] > [Sound & Vibration].+



Controlling the camera: Volume buttons can also be used to control your camera. Go to [Settings] > [Camera] > [Volume Button] and set up the volume buttons for Shutter or Zoom.

3.1.7. Micro-USB port

R11's Micro-USB port is the connector on the bottom of your device where your battery charger connects. It also doubles as the data port, which lets you transfer data to and from a personal computer. Plug the cable in the port to charge or transfer data.



Notice:

1. Repeated connecting and disconnecting of your cable can cause the port to wear out, resulting in a poor connection to your cable.
2. Never force a connector into the port, for that might cause damage.

3.1.8. Headset jack

The headset jack is an audio socket that accepts a 3.5mm audio plug. Plug your headset in the jack to listen to music, videos and phone calls. Do not force a mismatched headset into the jack for that might cause damage.



3.1.9. SIM and SD cards

SIM card

* Insert the SIM card before turning on your phone. If you hold a new SIM card, you might need to wait until it is activated by the carrier before you can use it.

A SIM card is provided by your carrier and is used to activate your phone's mobile network. Because it has a small amount of memory, the SIM card not only enables communications between two persons, but stores information

such as phone numbers, security data and more. When using the mobile network, you need to pay charges. To avoid high charges, you can shop data plans with your carrier, or shop international data roaming plans when traveling abroad.

Insert the SIM card: Most OPPO Smartphones support Dual SIM. You can choose to insert one or two.

1. Insert the card needle into the hole outside the card tray to pop it open.
2. Pull out the card tray and place SIM card(s) on it.
3. Put the card tray back in as the same orientation that you removed it.

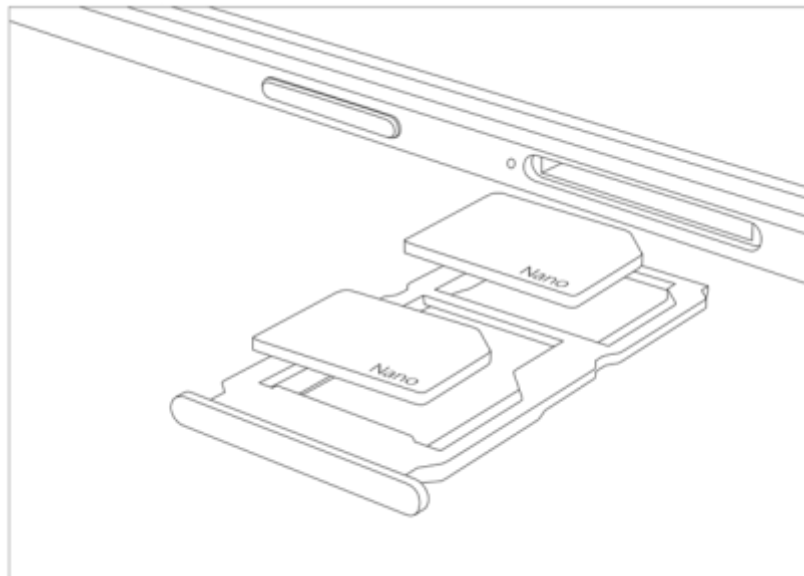

Remove the SIM card: Remove the card(s) in the same way that you insert it(them).

SD card

The SD card is a way to store and transfer images, music, video and other data. You can insert a SD card in your phone to expand phone's memory.

SIM1, SIM2 and SD cards share the same card tray. Insert your SD card in the same way that you insert the SIM card(s).

3.1.10. Accessories came with OPPO phone

Along with the handset, the accessories came with are headset, USB Connecting cable, Power adapter, SIM card tool and Phone case.

Notice : All photos shown are for illustration purpose ONLY. Actual products may vary due to product enhancement.

Headset: A standard headset with 3.5 mm headset plug. Use to listen to music, videos, and phone calls. Use the built-in microphone to talk. When playing the music or videos, click the button once to pause or play a song or video.



USB Connecting cable: Use the cable to connect your phone to the computer to charge and transfer files, or use it with the power adapter to charge.



Power adapter: Connect the power adapter to your phone using the included cable, then plug it into a standard power outlet to charge the phone.



SIM card tool: Use to pop out the SIM card tray.



Phone Case: Use to protect against drops and shock damage on the corners and rear of your phone.



3.1.11. Charge the battery

How to charge the battery:

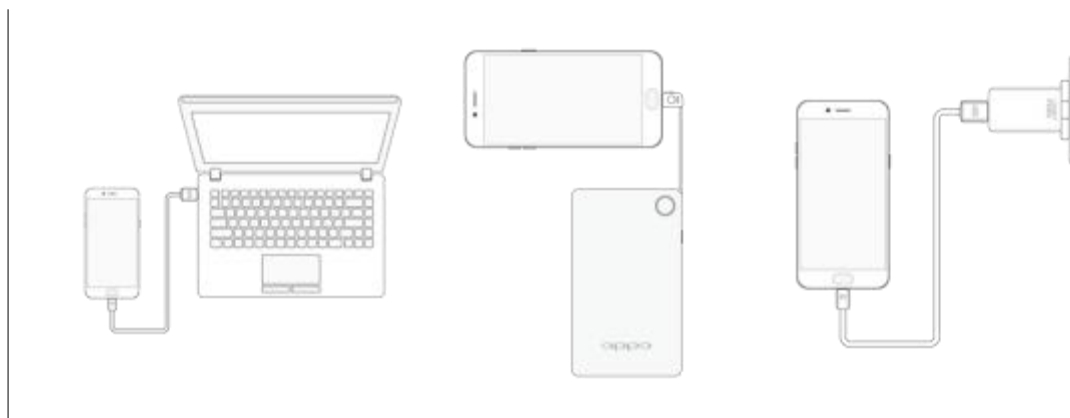

Notice : All photos shown are for illustration purpose ONLY. Actual products may vary due to product enhancement.

Charge with the jack: Connect adapter to your phone using the USB cable, then plug it into a standard power outlet to charge the phone.

Connect to a computer to charge: Use the cable to connect your phone to the computer to charge. Your phone will charge slowly if you connect it to the computer.

Charge with Power Bank: Connect Power Bank to your phone, and your phone will be charged wherever you go. It is an absolute necessity if you are a frequent traveler.

Charging Notice:

1. Charge the phone with the original charging accessories (including adapter, cable and power bank).
2. Charge your phone in a place where the temperature is always between 15° C to 40° C. Extreme ambient temperatures will affect flash charging system.

3.1.12. Gesture & Motion

Gestures

OPPO smartphone is designed to understand gestures. You can use gestures such as tap, swipe, drag and spread to operate your phone.

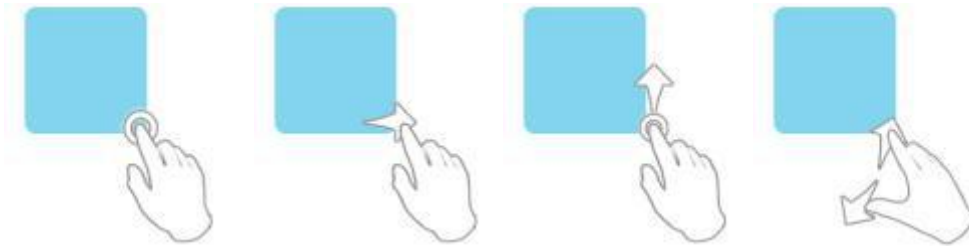

To set up complex gestures for specific functions, go to **[Settings]** > **[Gesture & Motion]**.



Screen-off Gestures

To set up screen-off gestures, you need to turn it on first.

Double tap fingerprint button for screen-on: Turn it on to wake up your locked screen with a double-click on the Home button. This function is only effective when the fingerprint sensor is turned off.

Double tap to turn screen on: Turn it on to wake up your locked screen with a double-click on the screen.

Draw O to start camera: When turn it on, you can draw O on the locked screen to open Camera app.

Draw V to open torchlight: When turn it on, you can draw V on the locked screen to open the torchlight.

Music control: When turn it on, you can draw || to pause/play a track, or draw < or > to switch the track when the screen is off.

Add more screen-off gestures: OPPO smartphone of ColorOS 3.1 gives you 7 options, which are **Draw ^, Slide up, Slide down, Slide left, Slide right, Draw M and Draw W**. Choose one to unlock the phone, call someone or start an app.

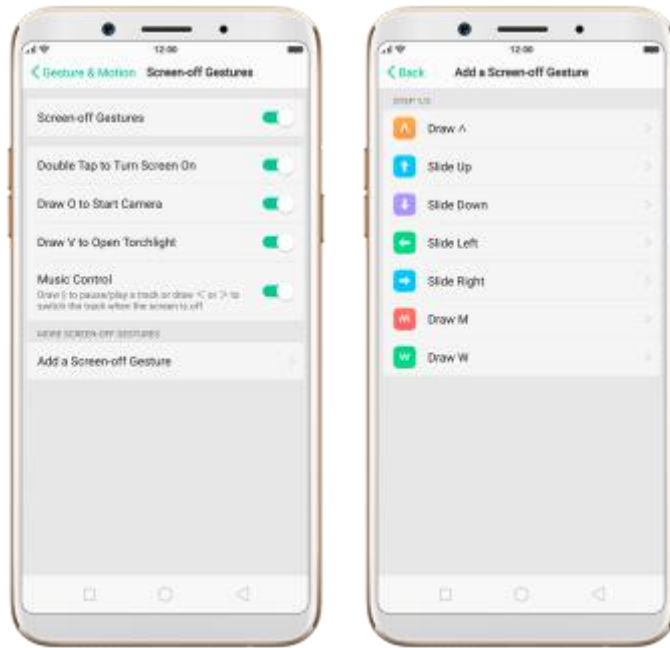

Screenshot Gesture

When turn it on, you can take a screenshot by swiping the screen up or down with three fingers.



Motion

The motion-sensing technology is used in OPPO smartphone. Use it to let your phone response to motion.

Smart call

Auto call when near the ear: Before you can use auto call, you need to set the default SIM card for calling. Go to a contact detail, call detail, message conversation or info interface, put the phone near your ear and your phone will automatically call that specific person.

Auto answer when near the ear: This function lets your phone to answer any incoming calls automatically when putting the phone near your ear.

Switch to receiver for calls: Use it to automatically switch from speaker to receiver when you put the phone near your ear during phone calls.

Flip to mute incoming calls: Use it to silence the ringer by turning the phone over on a table or other flat surfaces.

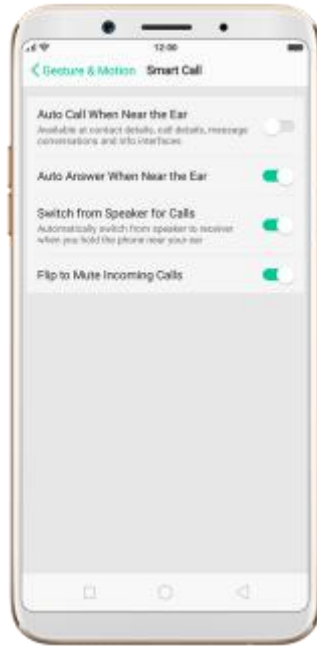

Touch-disable mode

Turn it on to prevent incorrect operations if the lock screen is covered.

+

Take selfies

Open Camera app and switch to the front camera. Click  > Palm on the top of the screen. Pose the same hand gesture towards the camera, once the camera captures that, it will take a photo automatically after two seconds.

You can change your pose and expression within this two seconds.

3.1.13.Key combinations

Generally, you can use two buttons of your phone to generate a specific result. The common key combinations include:

When phone is on

Press and hold the Power and Volume Down buttons: Your phone will take a screenshot for the current page.

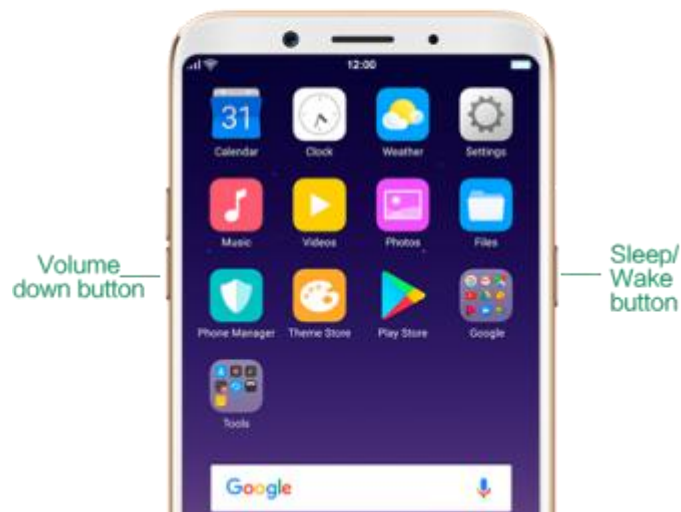

Press and hold the Power and Volume Up buttons:

1. **Capture long screenshots:** About 2 seconds, your phone will be ready to capture a long screenshot. Click **[Page-down]** to scroll to the next page, continue to click Page-down until you want to stop capturing, then click **[Save]** to generate a long screenshot.

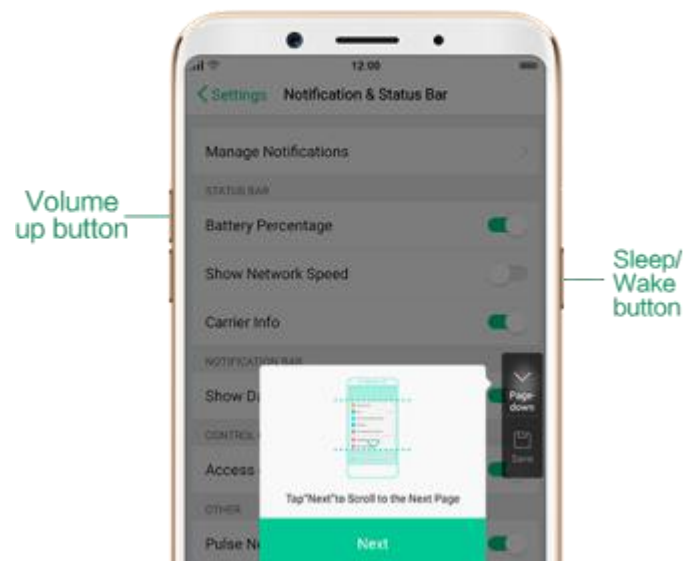

2. **Force restart your phone:** Press and hold the two buttons for at least 8 seconds until your smartphone is restarted.

Press and hold the Volume Up and Down buttons: Quit Talkback app temporarily.

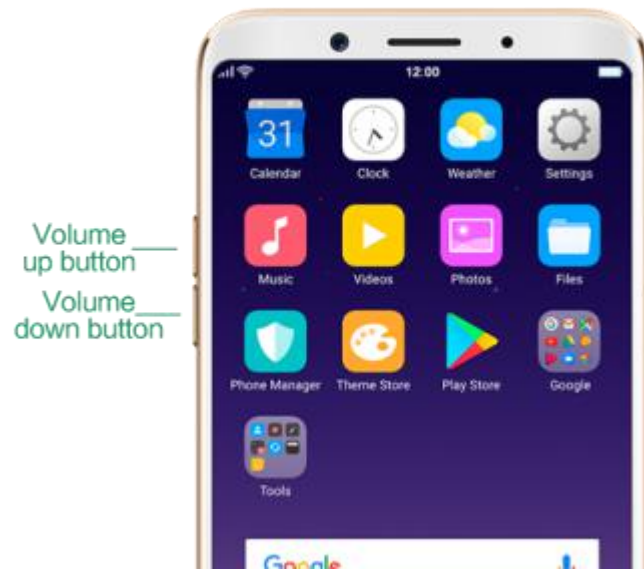

When phone is off

Press and hold the Power and Volume Down buttons: Phone will enter Recovery Mode, which does help to update the system, wipe data, check disk and more.

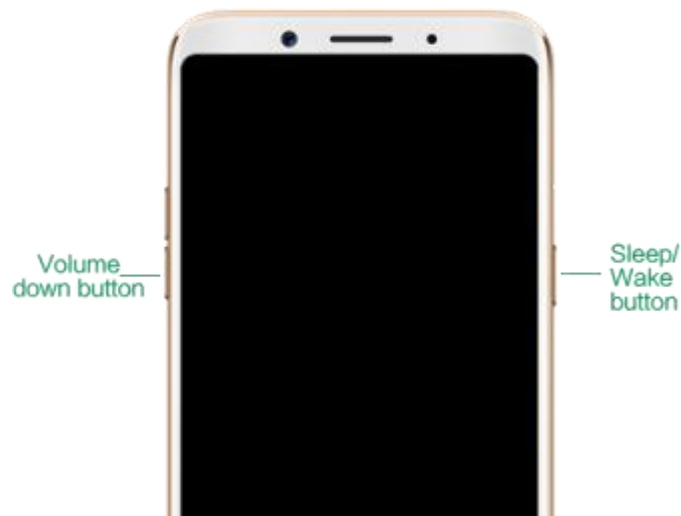





Press and hold the Power and Volume Up buttons: Phone will be force restarted. Press and hold the two buttons until your phone is turned on.

3.1.14. Status Icons

The icons in the status bar at the top of the screen give information about your OPPO smartphone:

Status icon	What it means
	Mobile network signal Shows whether you're in range of operator's network and can make and receive calls. The

		more bars, the stronger the signal.
	Airplane Mode	Shows that airplane mode is on. Phone's wireless communication abilities are disabled.
4G/ 4G ⁺	LTE/ LTE – A	4G network is available, including LTE and LTE-A. Your phone can connect to the Internet over that network.
3G/ H ⁺	UMTS/WCDMA	3G UMTS network is available. Your phone can connect to the Internet over that network.
E	EDGE /GSM	EDGE (GSM) network is available. Your phone can connect to the Internet over that network.
	Wi-Fi	Shows that your phone is connected to a Wi-Fi network. The more bars, the stronger the signal. See Connect to Wi-Fi .
	Call Forwarding	Call forwarding is turned on.
	VPN	You're connected to a network using VPN.
	Quiet Time	Quiet Time is turned on.

**Portrait orientation lock**

Phone screen is locked in portrait orientation.

**Alarm**

An alarm is set up on your phone.

**Bluetooth**

Bluetooth is on, or your phone is connected to a Bluetooth device.

**Bluetooth**

Bluetooth Tethering is on.

**Silent**

Silent Mode is on.

**HD Voice**

Your operator's VoLTE service is available.
HD Voice works to make your calls.

**USB Debugging**

USB Debugging is on. You can transfer files via USB.

**Wireless Display**

Wireless projector is connected.

**Location Service**

Location Service is on.

**No service**

Your phone has no signal.

**Power Saving**

Power Saving Mode is on.

3.2. Configure settings

3.2.1. Google account

A Google account is the key to accessing all of Google's products and services, such as Maps, Play Store, Voice Search, YouTube, and more. To sign in your Google account and get the most out of Google, do the following:

Create and sign in your Google account. The first time you switch your OPPO phone on, it will prompt you to sign in to Google. You can also create or sign in your account in **[Settings] > [Google] > [Sign-in & security]**, or in any of the Google apps on your phone.

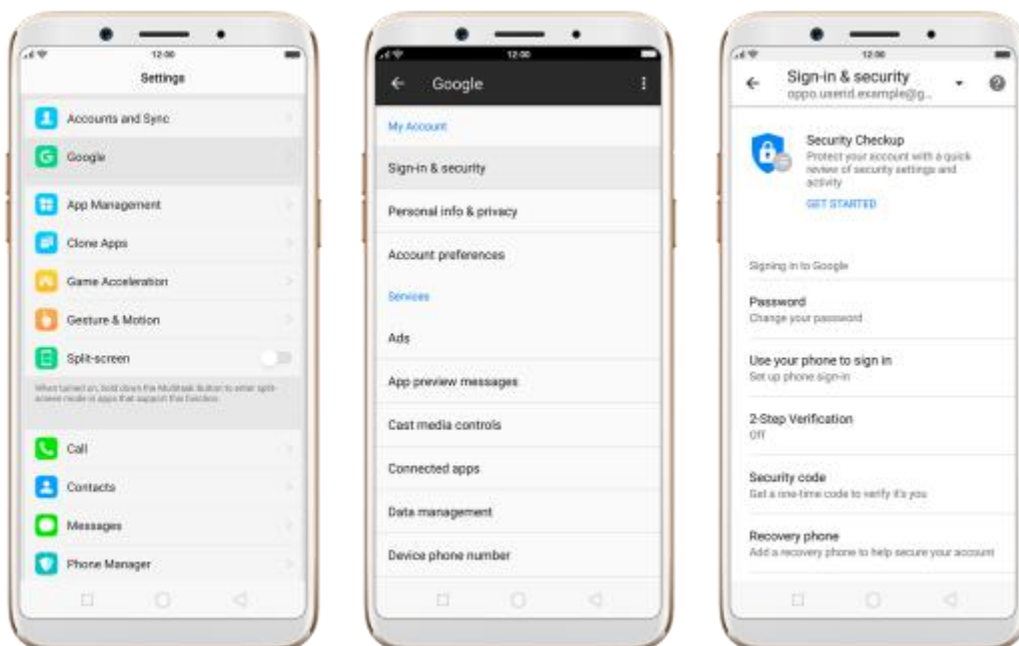

Note: Your Google Account is hooked up with all the Google Services you use. After you login to a Google app, other Google apps on your phone will automatically login to the same account.

View apps with access to your account. Go to **[Settings]** > **[Google]** > **[Sign-in & security]**, scroll down and click **Apps with access to your account**. If there's an app or service that shouldn't have access to your account, you can revoke its privileges.

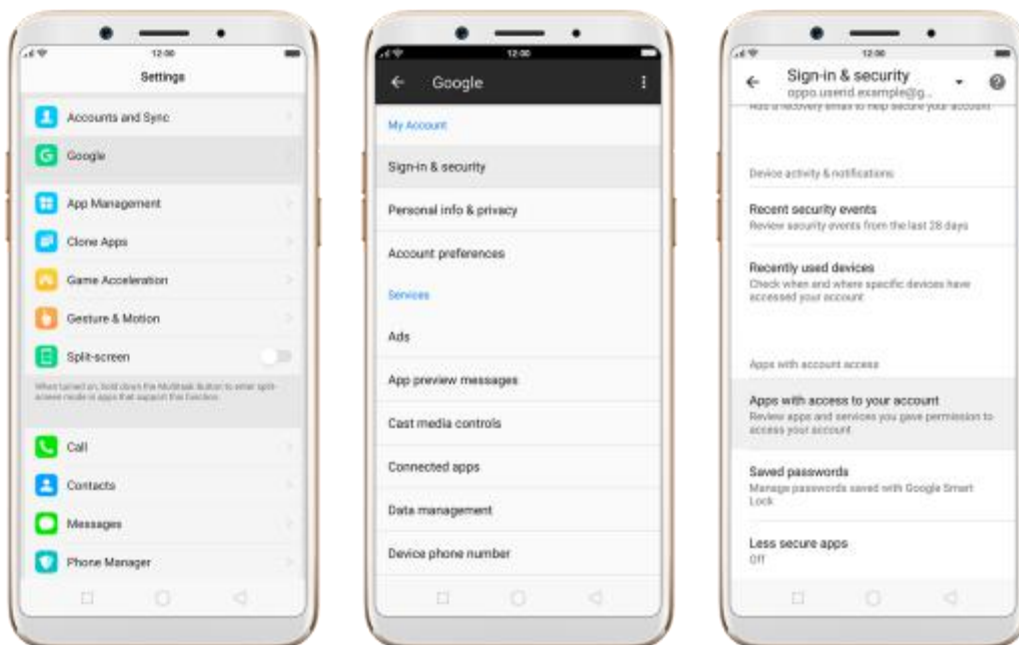

Sync the Google account. If you have your Google account configured, go to **[Settings]** > **[Accounts and Sync]**, click Google and you will see the sync options. You can choose which parts of the service you would like to be synced, then click **Sync now** to start syncing.

Remove your Google account. Go to **[Settings]** > **[Accounts and Sync]**, click Google, then click **Remove acct.**

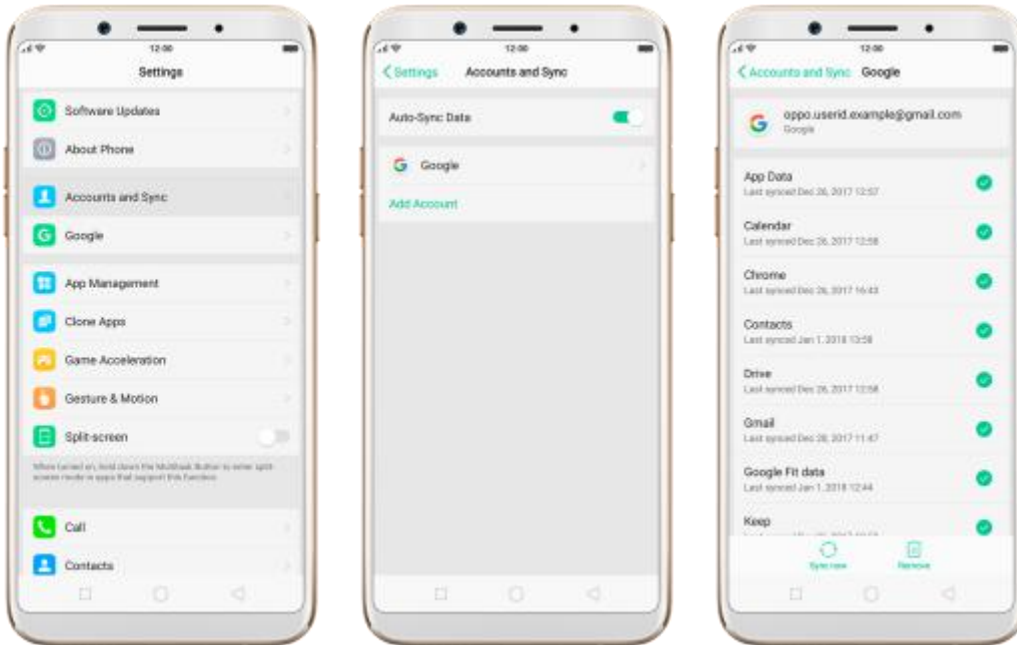

3.2.2. Fingerprint, Face and Passcode

Setting a passcode and fingerprint on your OPPO phone are security measures that all users should take. Follow these steps to set a passcode and fingerprint that will be needed to unlock your phone and access the information stored on it.

Use a passcode on your OPPO phone

Set the passcode

1. Go to **[Settings]** > **[Fingerprint & Passcode]**, click **[Turn on Passcode]**.

2. You'll be prompted to draw a pattern. If you want to use other passcode types, see step 3.

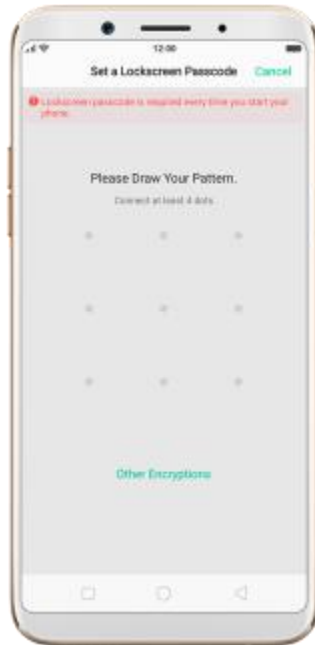

3. Click **[Other Encryptions]**. You can choose from two types of passcodes:

- Click **Custom Alphanumeric Code** to use a passcode that contains numbers and/or letters as your preference.
- Click **4-Digit Numeric Code** to use a numbers-only passcode that contains four characters.

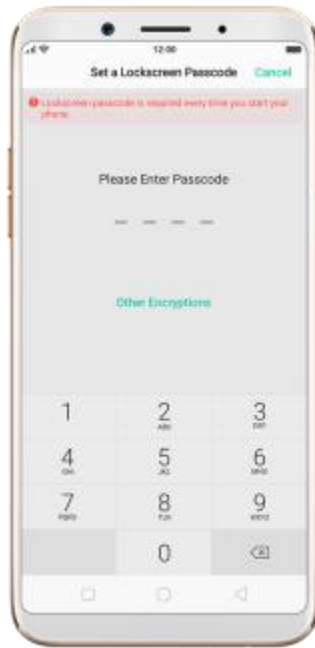

4. Draw your pattern or enter your passcode.
5. Re-draw or re-enter your pattern or passcode to confirm it and activate it.

Change the passcode

1. Go to **[Settings]** > **[Fingerprint & Passcode]**, click **[Modify Passcode]**.
2. Draw or enter your current pattern or passcode.
3. Draw or enter your new pattern or passcode. If you want to use other passcode types, click **[Other Encryptions]** at the bottom of the screen.
4. Re-draw or re-enter your pattern or passcode to confirm it and activate it.

Turn off the passcode

1. Go to **[Settings]** > **[Fingerprint & Passcode]**, click **[Turn off Passcode]**.
2. Draw or enter your current pattern or passcode to confirm.

View more details in Set and use a passcode with your OPPO smartphone.

Use a fingerprint on your OPPO phone

Before you can add a fingerprint, you need to create a passcode for your OPPO phone. You can use fingerprints for:

- Unlocking the phone from the lock screen.
- Making purchases without entering a passcode.
- Encrypting apps
- Protecting files

Add a fingerprint

1. Go to **[Settings]** > **[Fingerprint & Passcode]**, click **[Add a Fingerprint]**.
2. Follow the on-screen instructions, placing your finger gently on the Home button until your fingerprint is recorded.

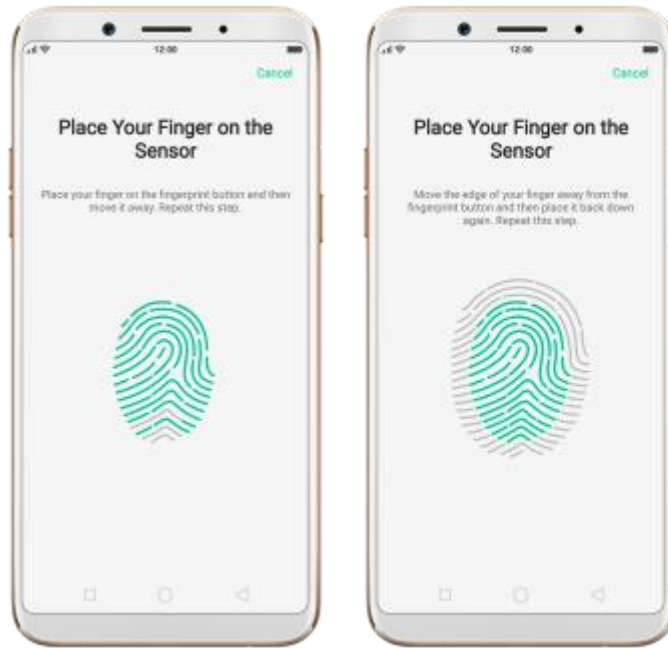

3. Repeat step 1 and 2 for as many fingers as you like.

Delete or Rename a fingerprint

1. Go to **[Settings]** > **[Fingerprint & Passcode]**, click the fingerprint you've added.
2. Enter a name for your fingerprint, or click **[Delete Fingerprint]**.



Use fingerprint to reset passcode

Prerequisite: The user must have entered the fingerprint and enabled the fingerprint unlock

Reset Passcode methods:

1. Restart your phone-enter 5 times the wrong passcode or pattern code-wait for 30s-click the "Use Fingerprint to Reset passcode"-verify fingerprint-reset passcode.



2. Without restarting the phone, follow the following operation to reset:
- [Settings] > [Fingerprint, Face and Passcode]** - Enter the wrong passcode 5 times - Wait 30s - click on the bottom of the screen to enter the "Reset Passcode" - verify fingerprint - Reset passcode.

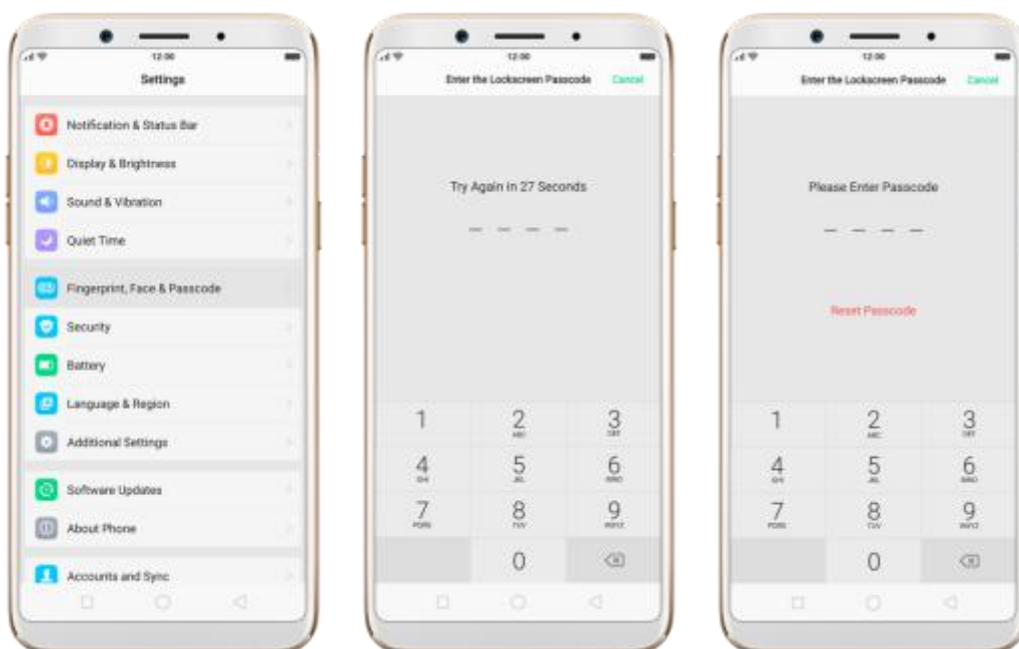

+

Enroll a Face on your OPPO phone

Before you can add a fingerprint, you need to create a passcode for your OPPO phone. You can use fingerprints for:

- Unlocking the phone from the lock screen.
- Encrypting apps
- Protecting files

Enroll a face

1. Go to **[Settings]** > **[Fingerprint,Face & Passcode]**, click **[Enroll Face]**.

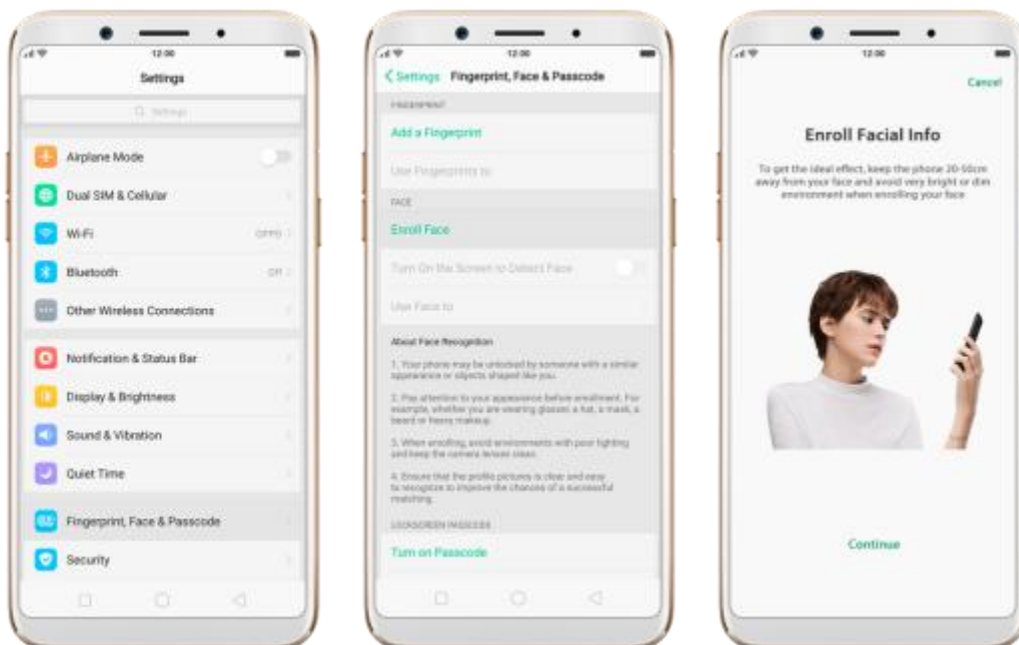

2. Follow the on-screen instructions. To get the ideal effect, keep the phone 20-50cm away from your face, make your whole face in the circle until the enrollment is done and avoid very bright or dim environment when enrolling your face.

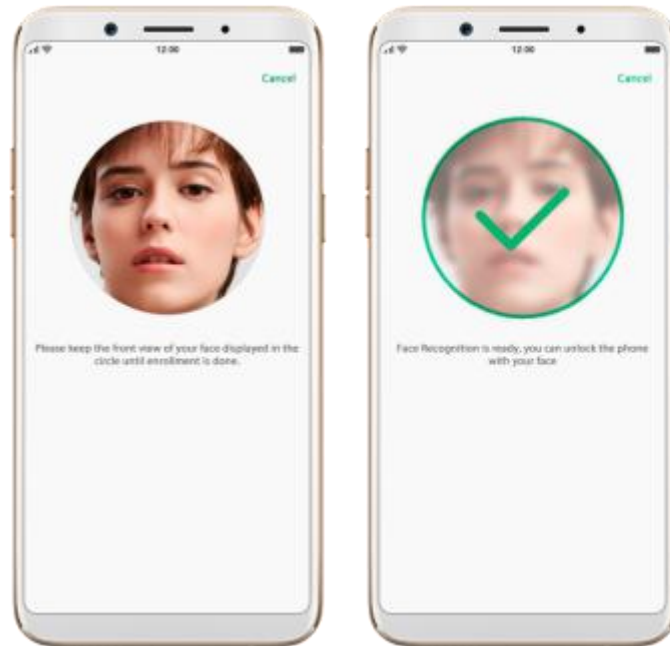

+

Delete Enrolled Faces

1. Go to **[Settings] > [Fingerprint, Face & Passcode]**, click **[Delete Enrolled Faces]**.

Use Face to

1. Go to **[Settings] > [Fingerprint, Face & Passcode]**, click **[Use Face to]** then you can choose to use your Face ID to **Unlocking, App Lock, File Safe** these function on or off.

View more details in Add and use a fingerprint on your OPPO Smartphone.

3.2.3. Set up other mail and calendar accounts

In addition to the apps that come with your phone, if you want to use other mail and calendar apps, add the accounts to your phone to let the apps associated with those accounts sync with your phone.

Set up an account. Go to **[Settings] > [Accounts and Sync]**, then click **[Add Account]**.

Repeat the steps for as many accounts as you like.



3.2.4. Transfer data with Clone Phone

Clone Phone can safely and rapidly transfer all the data including Personal

Data

(Contacts, Messages, etc.), System Data (System Settings, Clock, Weather Info, etc.),

Applications (Applications and Application Data) and Files like Audios, Videos,

Photos and Documents.

Before Clone Phone

- To support the whole backup process to complete, make sure the battery level of

OPPO smartphone is over 50% and don't turn off or restart your phone during the

backup process.
- Progress and details will be displayed on your phone during the cloning process.
- Your phone might get hot during the process as the processor is overloaded, which

generates heat.
- Keep your device close to the other to ensure the network connection between two

Devices.

How to Clone Phone

Follow these steps to transfer your data from the old phone to the new phone

easily and quickly:

From an Android Phone to an OPPO

Before Clone phone, you have to make sure Clone Phone is available on both your new phone and old phone.

If Clone Phone is not available in your phone, you can type in **i.clonephone.coloros.com/download** in your **phone's** web browser to download and install Clone Phone.

After both of your phones have installed Clone Phone.

1. On your new phone, go to **[Tools] > [Backup and Restore] > [Clone Phone]**,

select "This is the new phone". Wi-Fi and mobile data will be turned off automatically.
2. On you old phone, go to **[Clone Phone]** and select "This is the old phone"

and scan the QR Code generated by the new phone to start cloning. If the

QR code cannot be scanned, manually connect to the Hotspot below the QR code.

You can also select the data (Personal Data, System Data, Applications, Storage Data) to be cloned by clicking **“Manually Select the Data to be Cloned”**.

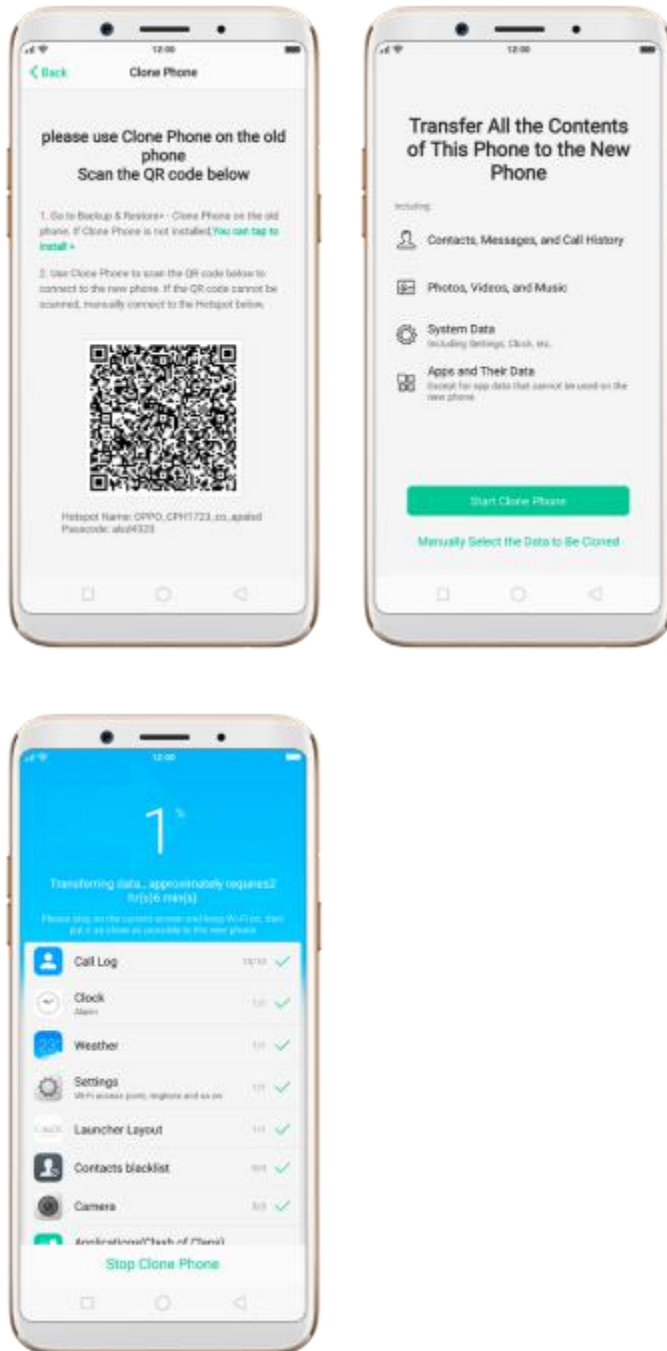

3. Enter the lockscreen password to continue.

From an iPhone to an OPPO Phone

For the data transfer between OPPO and iPhone, you can download

third-party apps, such as Zarya and Share it to transfer the data between OPPO and iPhone

* Pictures, settings and paths might differ from those of your phone, but that do not affect the description in this article.

3.2.5. Date and Time

Knowing the time and date is crucial to keeping on schedule. If you want to set the date and time display on your OPPO phone, or if you're out of synch or need a time update, just start with step 1 as below.

1. Go to **[Settings]** > **[Additional Settings]** > **[Date & Time]**, click it.

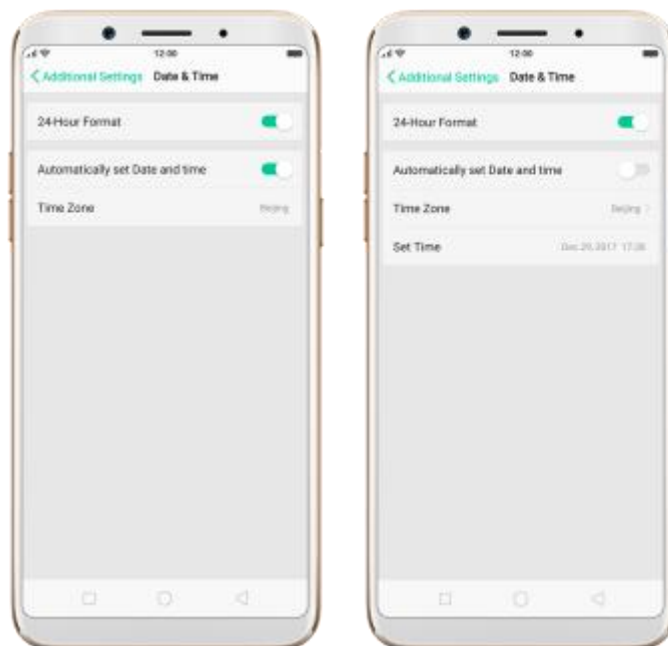

2. **24- Hour Format.** Switch from 12-hour or a 24-hour format optionally.

3. **Set Automatically.** Enable **[Set Automatically]** if you want to use the data

given by your network provider or your GPS, or you can set the time yourself if you prefer. See step 4.

4. **Set Manually.** You can manually set the time and date. To do so, disable **[Set Automatically]**, and then:

- **Select your time zone.** Click **[Time Zone]** and select the location you would like to adjust your time to.
- **Change the date and time.** You will see the date and time appear under the current time zone. Drag your finger across each column to change the date and time. Scroll wheels will appear to allow you to change the date and time simultaneously.

View more details in Set up date and time on your OPPO smartphone.

3.2.6. Language and Region

OPPO smartphone offers you an easy access to configure it to display information in another language. If you want to change its language to yours, or if you've relocated to a new country, you can change language and region by following a few easy steps.

1. Go to **[Settings]** > **[Language & Region]**, click it.

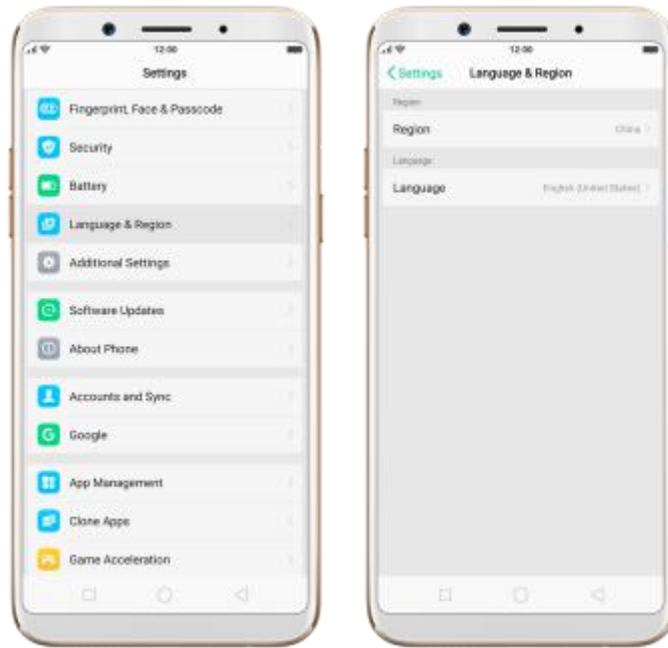

2. Find your desired language.

- Click **[Language]**, you will see a list of languages. Scroll down to find the language you wish to use.
- Select your desired language and click "Done." A confirmation message will appear at the bottom of your screen. Confirm the change by clicking "Change to ____." Then your OPPO phone will be in the new desired language.

3. Find your desired region. Refer to step 2 to change the region you want to use.

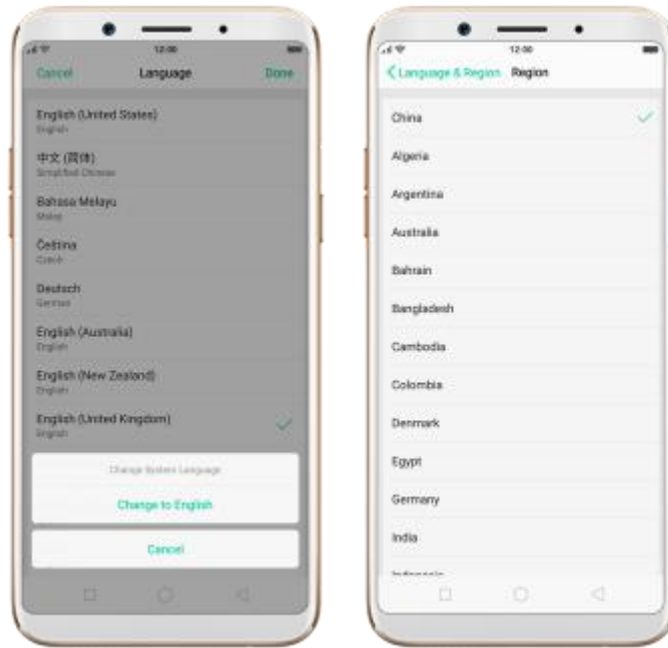

3.2.7. Connect to the Internet

OPPO smartphone connects to the Internet whenever necessary, using a Wi-Fi connection or mobile network.

Wi-Fi connection

1. Go to **[Settings]** > **[Wi-Fi]**, or swipe up from the bottom of your screen to open Control Center, then tap . The detected Wi-Fi networks will be displayed.
2. Tap the Wi-Fi network you want to connect to.
3. Fill in the password if required.

Mobile data connection

Go to **[Settings]** > **[Dual SIM & Cellular Data]** and enable **[Mobile Data]**, or swipe up from the bottom of your screen to open Control Center, then tap  .

Notice: Enabling the mobile networks connection may result in extra cost.

Check with your mobile network service carrier.

3.3. Instructions

To view Instructions on OPPO smartphone, go to **[Settings]** > **[Additional Settings]** > **[Instructions]**.

- **Operation skills**, including Camera, App permission management, Trash removal, Lock screen magazine, Screen-off gestures, Screenshot with 3 fingers, Long screenshot, Notification settings, Quick setup, System application settings, Low power mode and Add widgets.
- **Troubleshooting:** Before requesting after-sales services, you can troubleshoot the phone by yourself.
- **Product security**, including Statement, Safety precautions and Health and safety.
- **After-sales service**, including E-Warranty Card and Help.

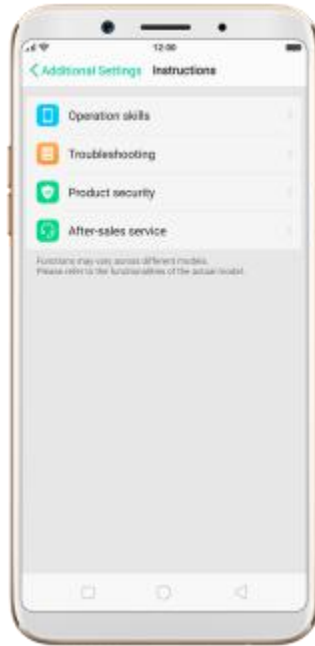

4. What's new in ColorOS 3.2

4.1. Face ID

Face Recognition feature can identify up to 128 facial recognition spots while clicking selfies. With Facial Recognition, you just need to pick up and wake your phone, then it unlocks the instant you look at it, or even when you close your eyes. It does help if you've had trouble with your fingerprints over time.

To use Face ID, you must set up a passcode on your phone. When your phone has just been turned on or restarted, you will be required to enter your passcode to unlock the phone.

Set up Face ID

1. Go to **[Settings]** > **[Fingerprint, Face & Passcode]**, then click **[Enroll Face]**. Click Continue and follow the on-screen instructions.

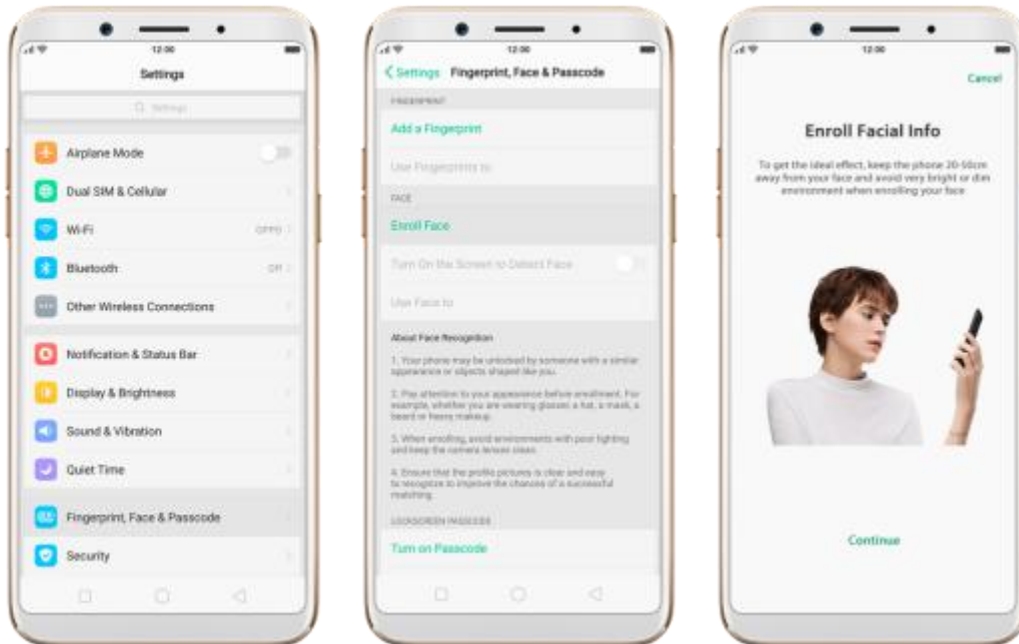

2. Keep the phone 20-50 cm away from your face and position your face in the onscreen frame. Keep the front view of your face displayed in the circle until the enrollment is done.

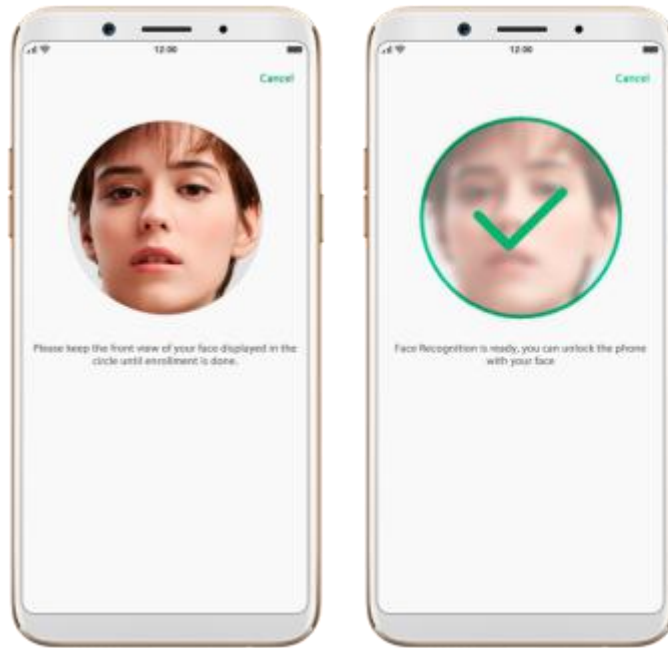



Unlock your phone with Face ID. Go to **[Settings] > [Fingerprint, Face & Passcode]** first, then choose whether to enable **[Turn on the Screen to Detect Face]**:

- When **[Turn on the Screen to Detect Face]** is on: wake and pick up the phone, then your phone will unlock near instantly.

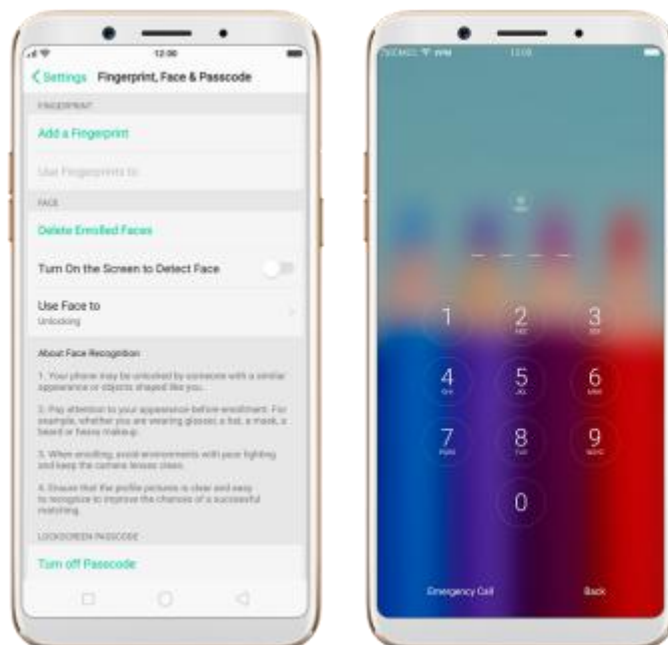

- When **[Turn on the Screen to Detect Face]** is off: wake the phone and slide up the lock screen, then your phone will unlock near instantly.



- If Face ID fails to unlock your phone, you can click  to retry. Face ID might fail when there's no or low light. In this case, you can use the lock screen passcode or fingerprint to unlock the phone.



Use Face ID for App Lock and File Safe. Face ID is used for more than unlocking your phone. You can also use it to unlock apps and the File Safe. Go to **[Settings] > [Fingerprint, Face& Passcode] > [Use Face to]**, then turn on App Lock and File Safe.



Note

- 1. Your phone may be unlocked by someone with a similar appearance or objects like you.*
- 2. Pay attention to your appearance before enrollment. For example, check whether you are wearing glasses, a hat, a mask, a beard or heavy makeup.*
- 3. When enrolling, avoid environments with poor lighting and keep the camera lenses clean.*
- 4. Ensure that the profile picture is clear and easy to recognize to improve the chances of a successful matching.*

4.2. Virtual Navigation Keys

ColorOS 3.2 replaces the traditional hardware buttons with on-screen virtual

navigation keys, also offers you fast and **fluid gestures** to operate your phone. You can change the order of the virtual keys, and set them to appear only when needed to free space on the screen.

Enable virtual navigation keys. Virtual navigation keys are default on. If you want to enable them manually, go to **[Settings] > [Additional Settings] > [Navigation Keys]** and click Virtual Navigation Keys.

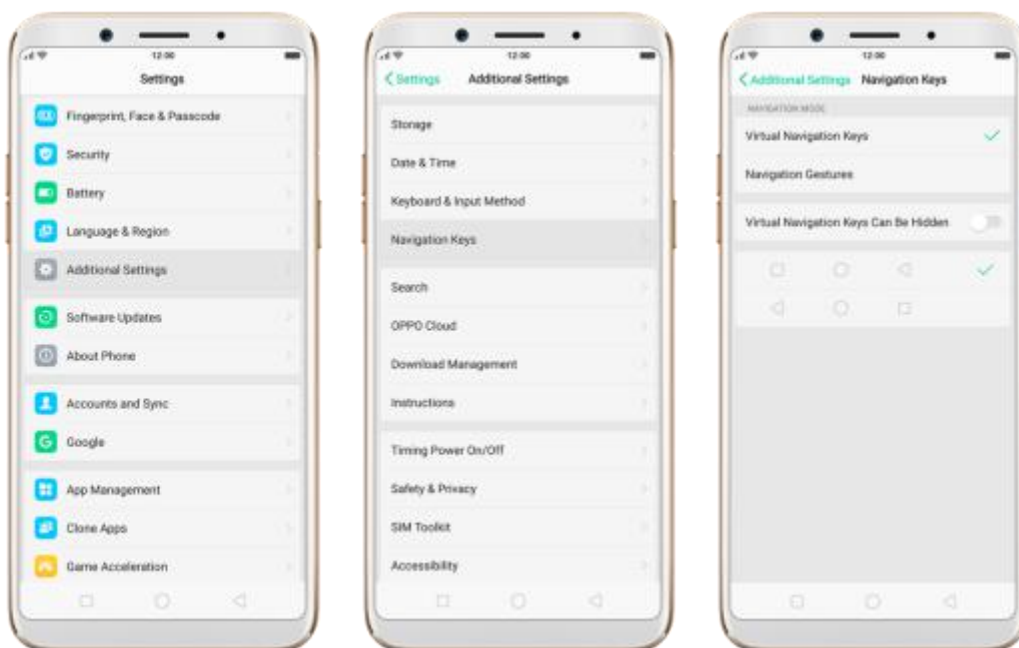

Change the order of virtual navigation keys. The keys follow the typical order for OPPO: Menu, Home, and Return from left to right. If you are left-handed, you can change them to the return-home-recent order.

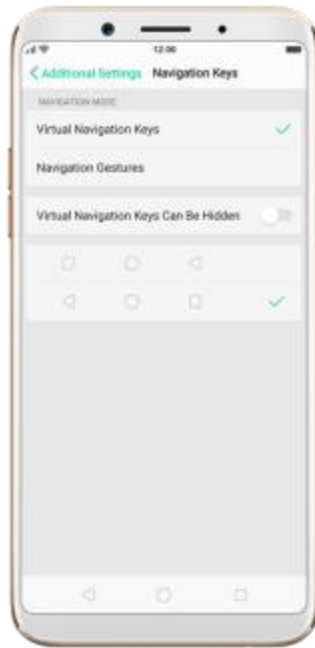

Hide the virtual navigation keys. When you launch a full-screen app, the keys will automatically hide, and can be brought back with a simple swipe:

- When in portrait mode, swipe up from the bottom.
- When in landscape mode, swipe from the bottom to the left.





Manually hide the virtual navigation keys. To set the keys to appear only when needed, go to **[Settings] > [Additional Settings] > [Navigation Keys]** and enable Virtual Navigation Keys Can Be Hidden. Then you can click  on the left-lower corner of the screen to hide the keys, and swipe from the bottom to reveal them.

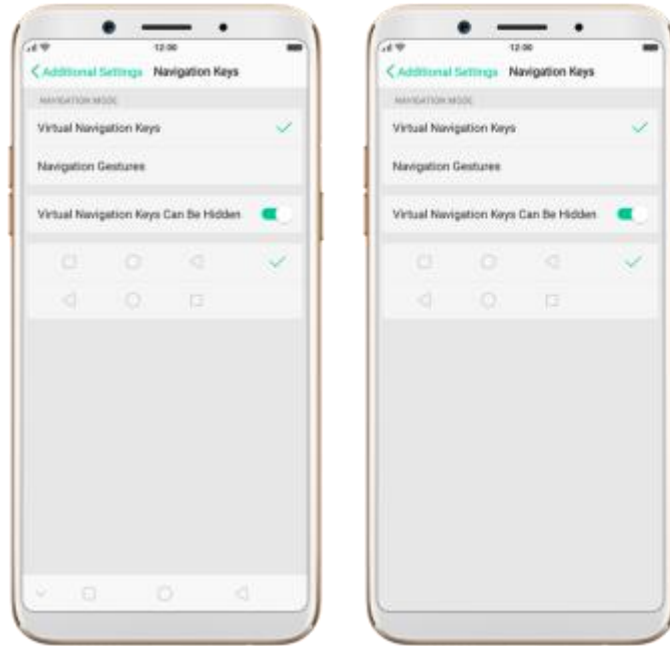

Immersive navigation background. The system set multiple colors for the navigation background to match the color scheme of the popular apps. The background color is default white, and it will become translucent or **immersive** when you open some of the third-party apps.

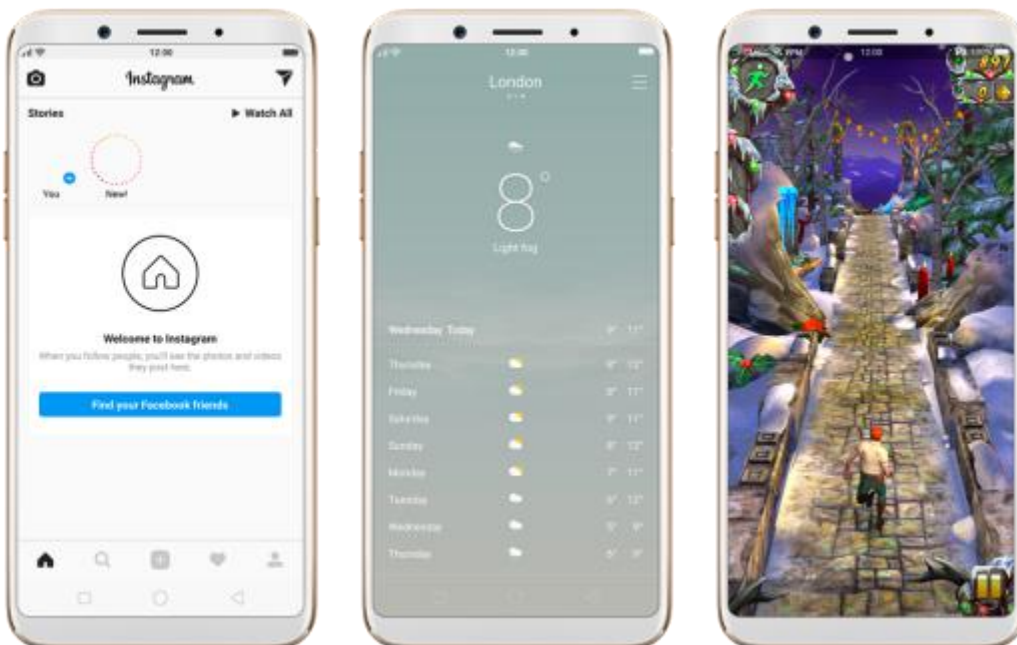

4.3. Game Acceleration

Game Acceleration feature is an all-in-one game optimization tool that allows you to run your games at the best possible performance. When you're running a game, your phone will automatically turn on high performance state, adjust the distribution of system resources, and optimize the game display configuration to provide the best gaming experience available. To prevent from being interrupted during games, you can also disable bottom keys, turn on No Disturbance mode, and more.

Tip: Currently, games that can be accelerated contain Candy Crush Saga, Clash of Clans, My Talking Tom, Candy Crush Soda Saga, Ball Pool, My Talking Angela, Farm Heroes Saga, Toy Blast, Hay Day, Temple Run 2 and Mobile Legend (VN/TH/ID). More games will be added soon.

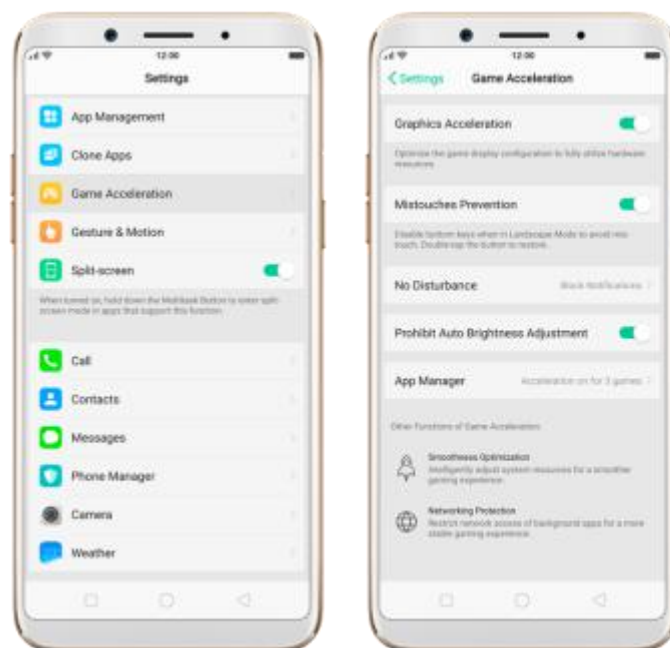

Manage games that can be accelerated. Go to **[Settings]** > **[Game Acceleration]**, click **[App Manager]** and you will see a list of your games that can be accelerated by your phone. To accelerate a game, toggle its slider to green.

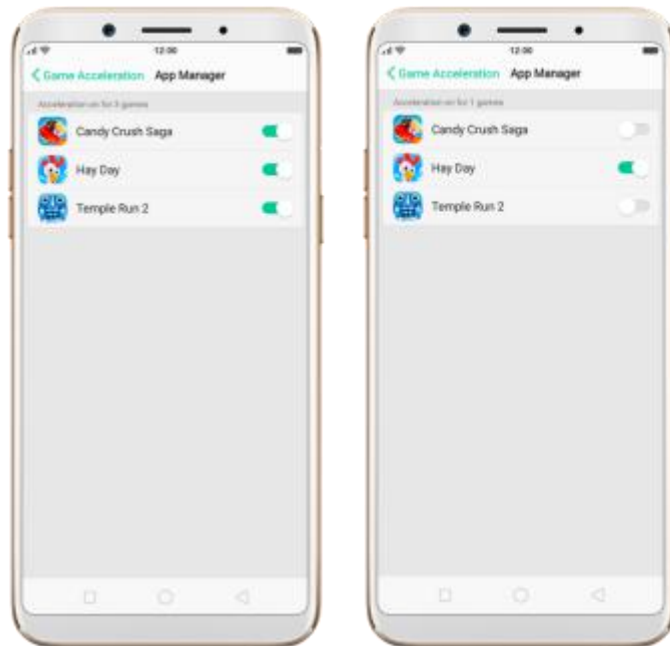

- Your phone will automatically speed up your game. Notice that acceleration details display on the screen, and  appears in the status bar when you launch the game.





Set up Game Acceleration. Go to **[Settings] > [Game Acceleration]**.

1. **Graphics Acceleration:** optimize the game display configuration to fully utilize hardware resources.
2. **Mistouches Prevention:** disable bottom keys when you run a game in landscape mode. You can double-tap on the keys to enable them.



3. **No Disturbance:** block calls and notifications so that you can get fully immersed in the games.

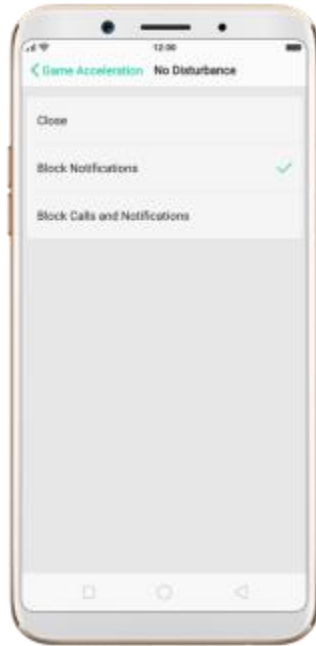

- **Close:** do not block any calls or notifications.
- **Block Notifications:** block notifications except calls, alarm clocks and scheduled reminders. Notifications will be displayed with a banner on the top screen.





- **Block Calls and Notifications:** block all calls and notifications.

4. **Prohibit Auto Brightness Adjustment:** your phone will not automatically adjust the brightness of the screen when ambient light changes.

4.4. Enhanced Security Mechanism

For better security, OPPO has provided two new functions to prevent your information from being leaked, including blocking pseudo base stations and preventing apps from taking pictures or making recordings in the background.

Block pseudo base stations. Go to **[Settings] > [Security] > [Pseudo Base Station Blocking]** and you will see a list of pseudo base stations identified by the phone.

Your phone might receive many spam messages or be infected by mobile viruses sent from the pseudo base stations. When these stations are identified, your phone will block the information sent by them, thus

safeguard your property and information security.

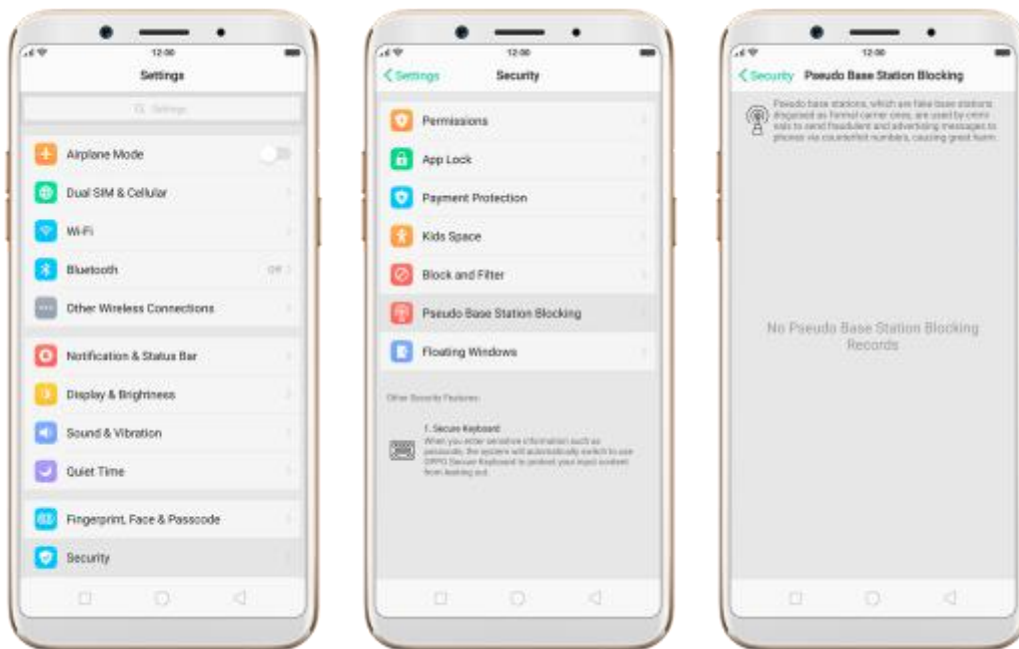

Prevent apps from taking pictures or making recordings in the background.

Some Android malware can spy on your activities in the background, and can take pictures or make recordings without notifying you, resulting in leaking of the information. When the malware performs these activities, your phone will remind you immediately:

- Pop up a warning window on your phone screen.



- If you start the sound recorder and go to another application, the status bar turns red.



4.5. Search Settings and Files

ColorOS 3.2 devices enable you to search for system settings and files that match a specified keyword or string, so you can spend more time acting on information and less time looking for information.

Search for system settings. A search bar is added at the top of the Settings page to help you quickly find the feature you want to use. Click the search bar and type the name of a feature (or a part of it). Features matching what you've typed appear below and get filtered more specifically when you type in more text. Click a feature to access its settings screen.

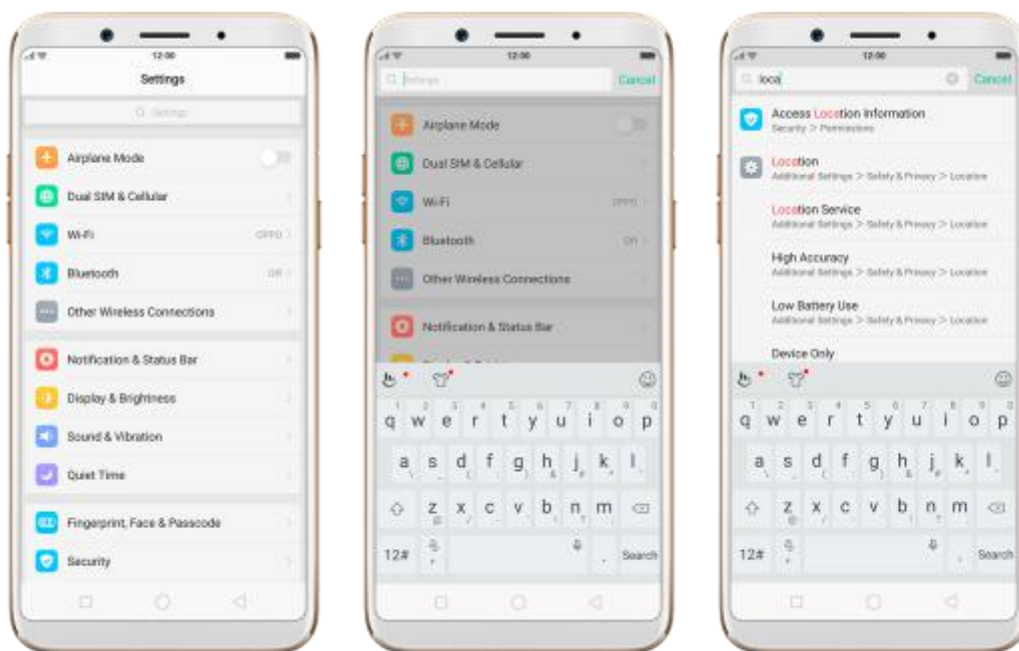

Search for files. Click Files app on the home screen, click , then type the name of a file (or a part of it). Files matching what you've typed appear below.

If you are sure that the certain file that you are searching for is on a specific

folder, you can search specifically from that location. This will make the search more specific and faster.

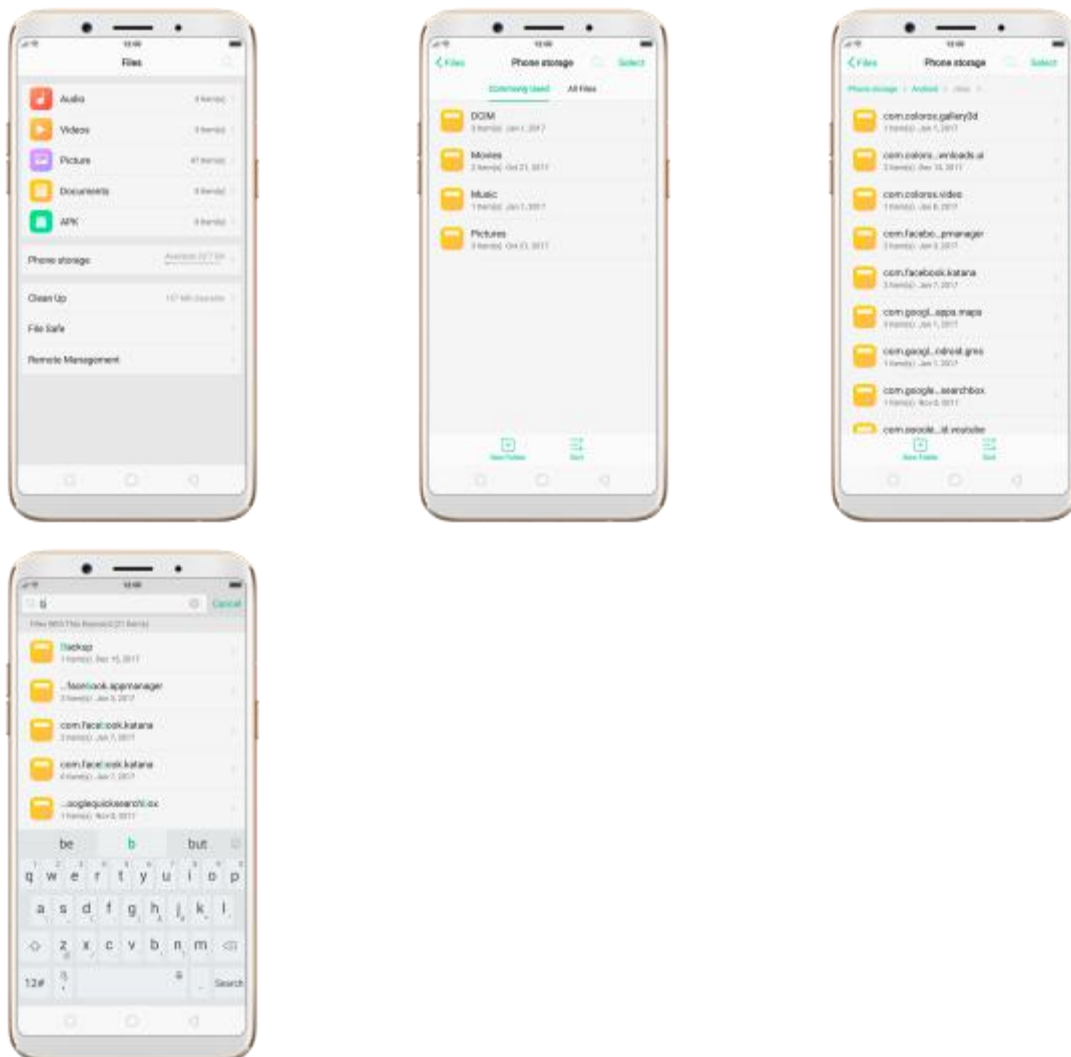

4.6. Optimized File management

The optimized Files app provides you a more convenient way to work with the file system and perform various operations on files and folders such as search, create, edit, rename, copy, delete, compress, batch process etc.

Optimized search capability. You can search for a file under the root directory, or on a specific folder if you know its general location. This will

make the search more specific and faster.

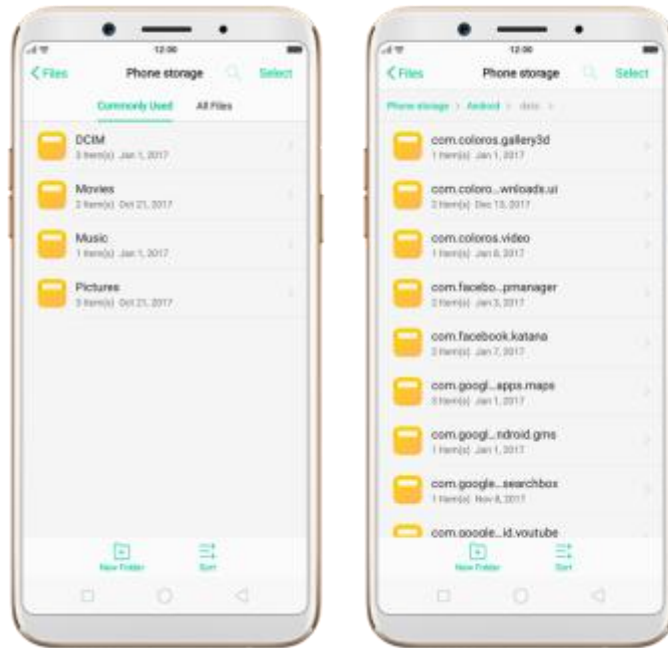

File classification

- The Files app automatically categorizes your files based on their extensions so you can browse them more clearly and conveniently.

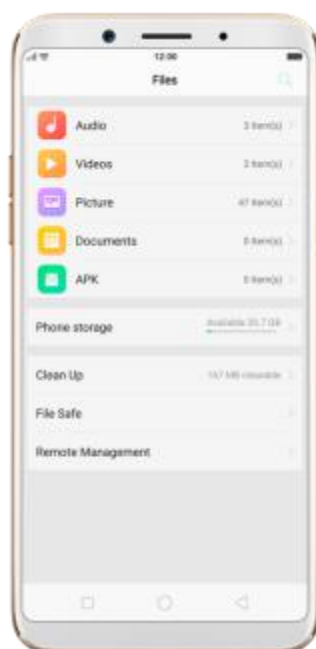

- Under Phone storage, your commonly used folders will be listed separately so that you can quickly look up them later.

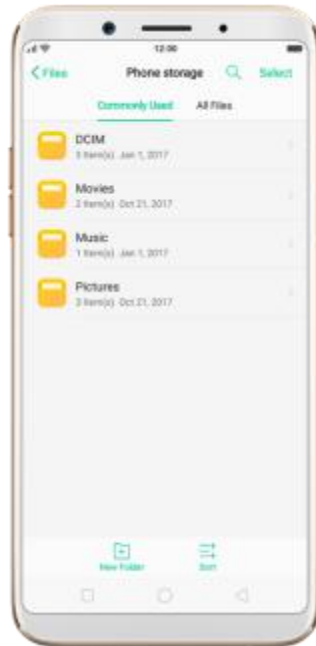

- In **[Phone storage]** > **[All Files]** > **[Android]**, app files and the files you downloaded from the app will be saved in different folders, so you can quickly find the files you need.



Select All feature. Select All feature is added in Files, so you can process the files in batches.

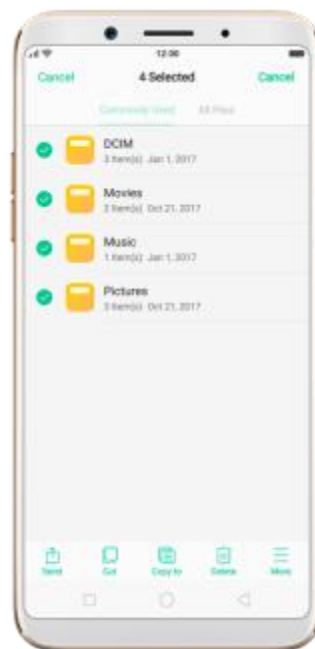
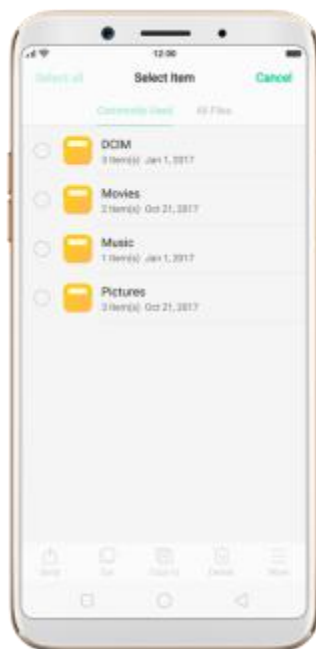
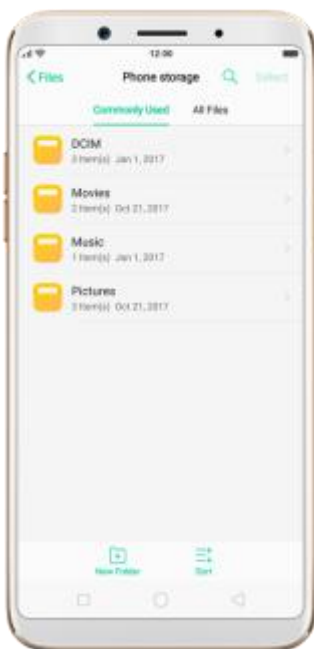

4.7. Auto Recording

Auto Recording feature enables you to automatically record conversations, which makes it easier for you to review your important incoming and outgoing calls on a daily basis. You can record all calls, or those from your designated numbers or unknown numbers. You can also share your recording files, set them as ringtones, and more.

Turn on Call Recording. Go to **[Settings]** > **[Call]**, click **[Call Recording]**, then select which calls to be recorded:

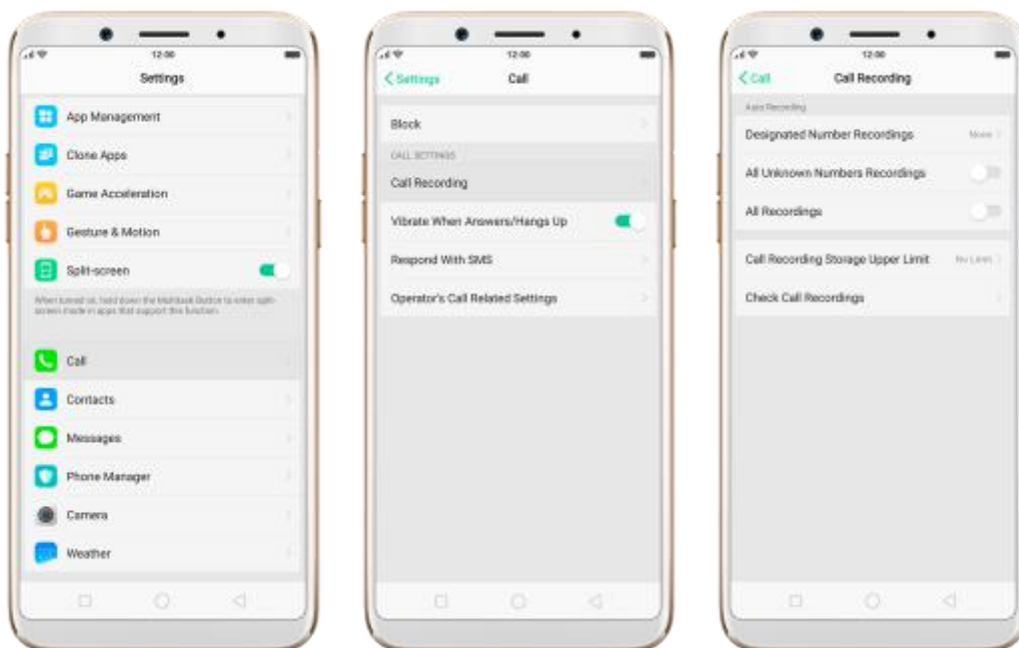

- **Record calls from designated numbers.** To add the numbers, click Designated Number Recordings, then click Add. Choose the contacts from Call Log, Groups or Contacts, then click Add.

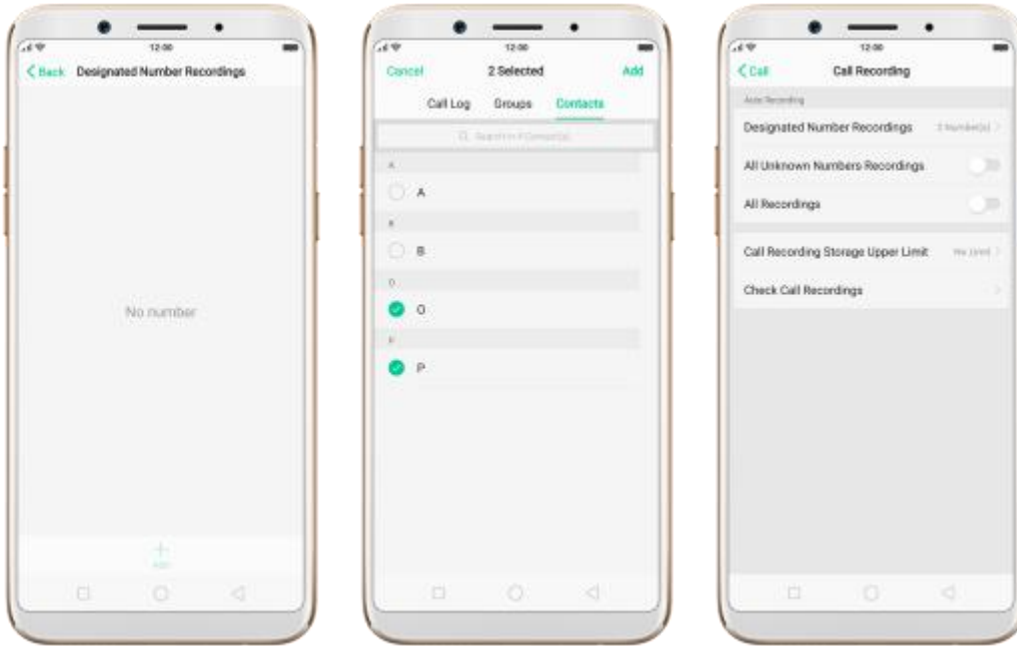

- **Record calls from all unknown numbers.** Toggle the All Unknown Numbers Recordings slider to green, then your phone will automatically record calls from numbers that are not in your Contacts.

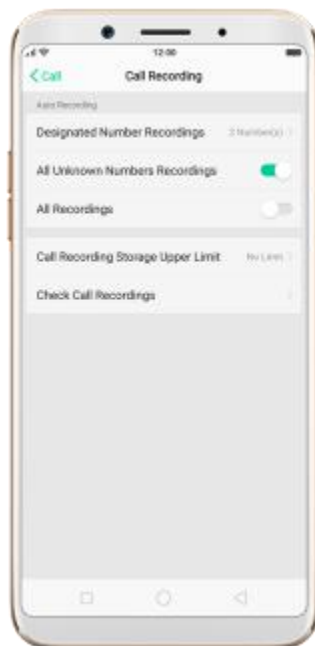

- **Record all your calls.** Toggle the All Recordings slider to green.

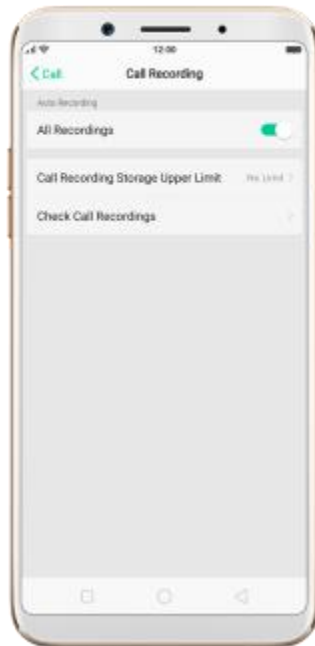

Set the storage limit for recording files. Click Call Recording Storage Upper Limit, then choose a storage capacity for the recording files. If your recordings exceed the threshold, the earliest recording will be deleted automatically.

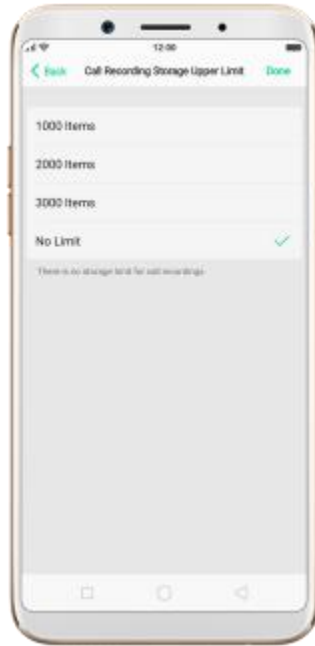

Manage your call recordings. Click Check Call Recordings, then click Call Recording.

- **Play a recording back.** Click the recording to play it back.
- **Send, rename or delete a recording.** Click Select, choose the recording, then choose an option.
- **Set a recording as ringtones.** Click Select, choose the recording, click Set as, then set the recording as the call, SMS, alarm or contact ringtone.

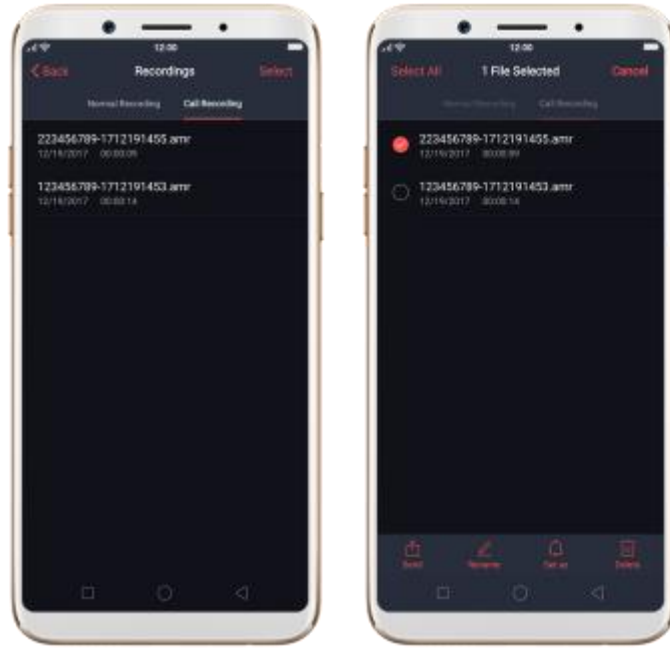

Note: Call Recording feature is not available in the United States and Australia.

4.8. Reset password with fingerprint

When you enter the wrong passcode five times in a row, or you've forgotten your passcode, you can easily reset the passcode with your fingerprint.

Before you can use the reset feature, you must add at least one fingerprint to your phone.

Reset passcode with fingerprint after restarting the phone.

1. When you enter the wrong password five times from the lock screen of your phone, your phone will temporarily restrict you from entering the passcode again and ask you to wait 30 seconds.
2. When the waiting period is up, click **[Use Fingerprint to Reset Passcode]** on the bottom of the screen.



3. Place your finger on the fingerprint sensor, then enter your new passcode and confirm it.

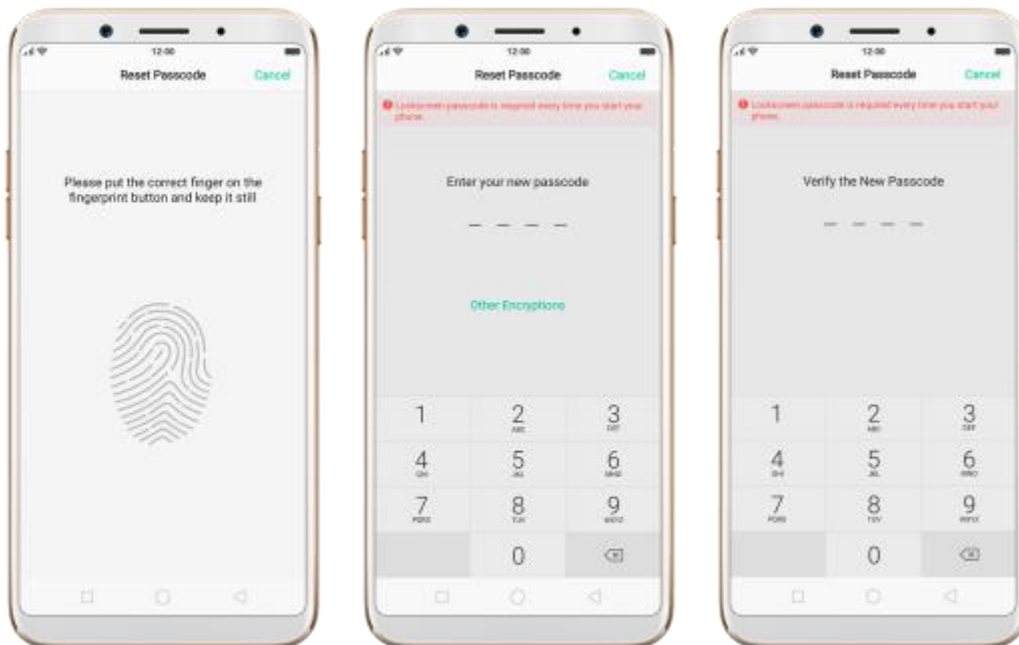

Reset passcode with fingerprint when the phone is unlocked.

When your phone is unlocked, you can change the lock screen password directly from the Settings page.

1. Go to **[Settings] > [Fingerprint, Face & Passcode]**, enter the wrong password five times, then your phone will temporarily restrict you from entering the passcode again and ask you to wait 30 seconds.

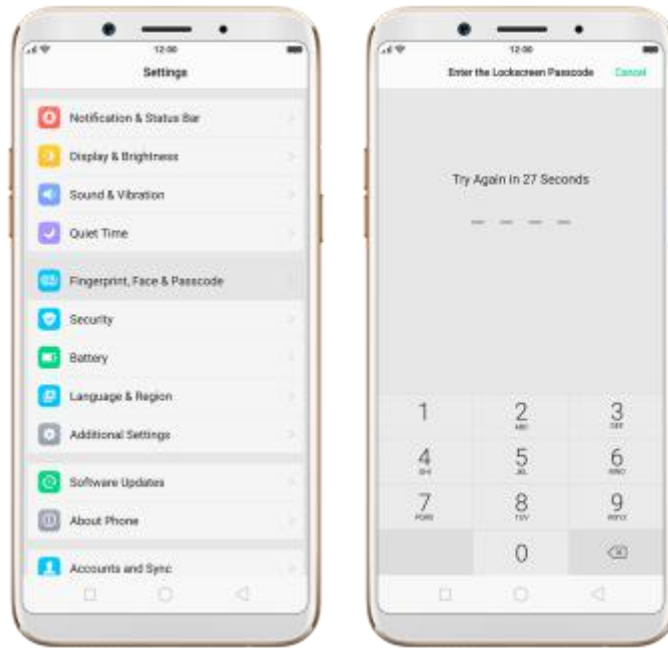

2. When the waiting period is up, click **Reset Passcode**.



3. Place your finger on the fingerprint sensor, then enter your new passcode and confirm it.

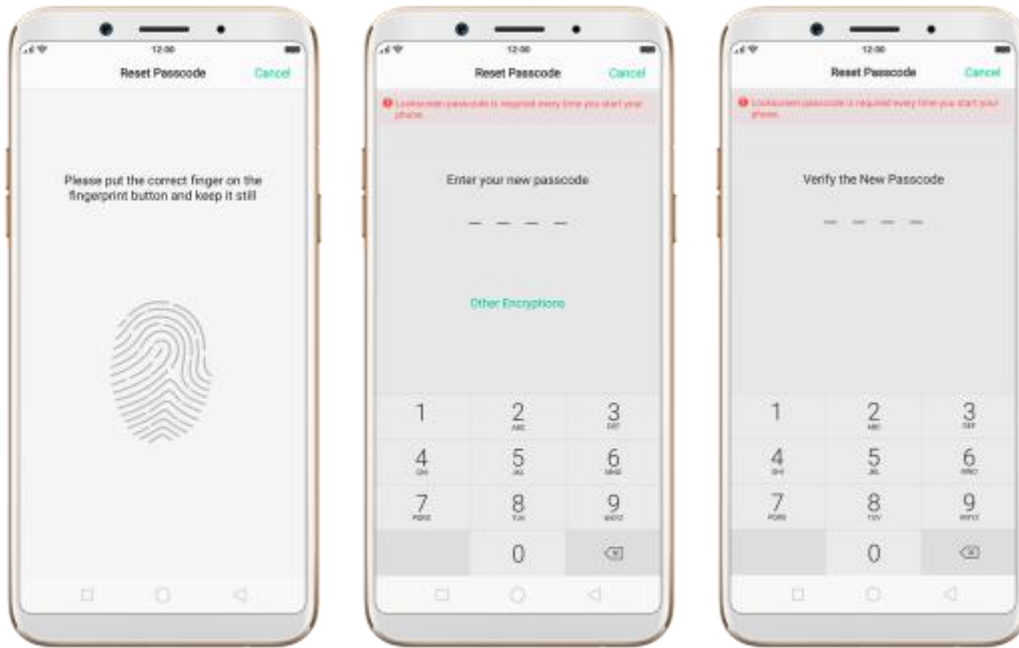

4.9. Reset password with fingerprint

When you enter the wrong passcode five times in a row, or you've forgotten your passcode, you can easily reset the passcode with your fingerprint.

Before you can use the reset feature, you must add at least one fingerprint to your phone.

Reset passcode with fingerprint after restarting the phone.

1. When you enter the wrong password five times from the lock screen of your phone, your phone will temporarily restrict you from entering the passcode again and ask you to wait 30 seconds.
2. When the waiting period is up, click **Use Fingerprint to Reset Passcode** on the bottom of the screen.



3. Place your finger on the fingerprint sensor, then enter your new passcode and confirm it.

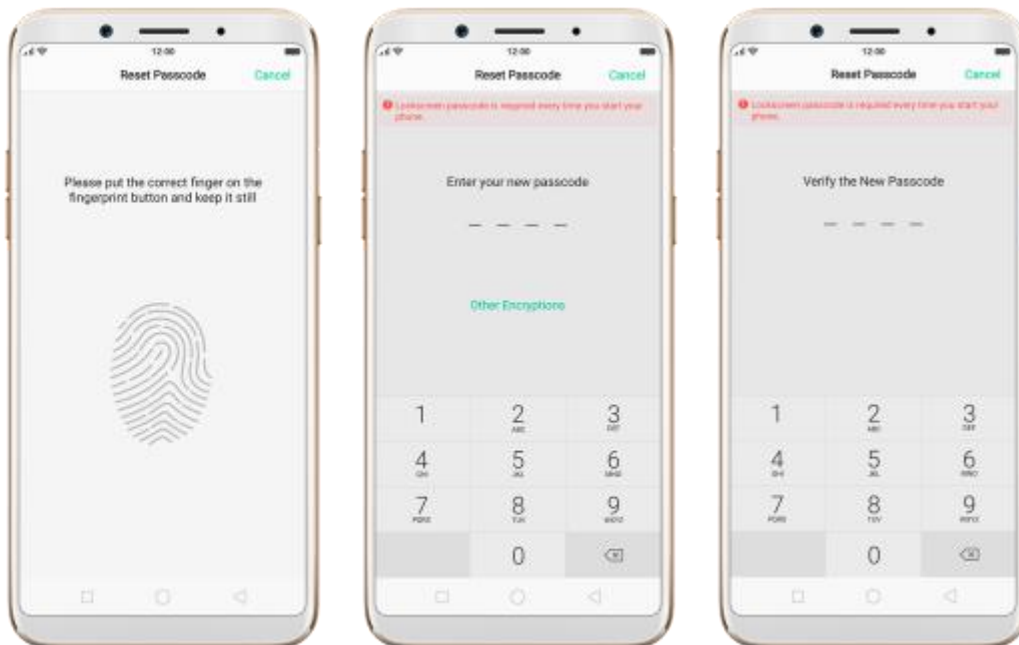

Reset passcode with fingerprint when the phone is unlocked.

When your phone is unlocked, you can change the lock screen password directly from the Settings page.

1. Go to **[Settings] > [Fingerprint, Face & Passcode]**, enter the wrong password five times, then your phone will temporarily restrict you from entering the passcode again and ask you to wait 30 seconds.

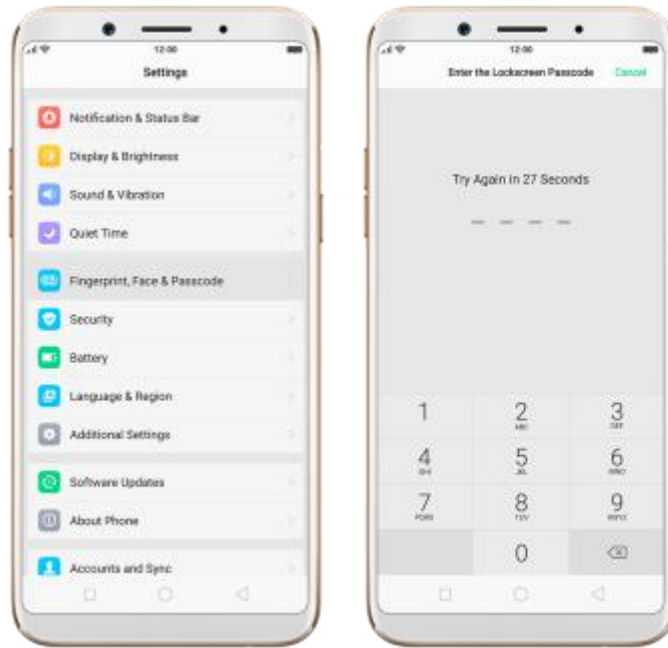

2. When the waiting period is up, click **Reset Passcode**.



3. Place your finger on the fingerprint sensor, then enter your new passcode and confirm it.

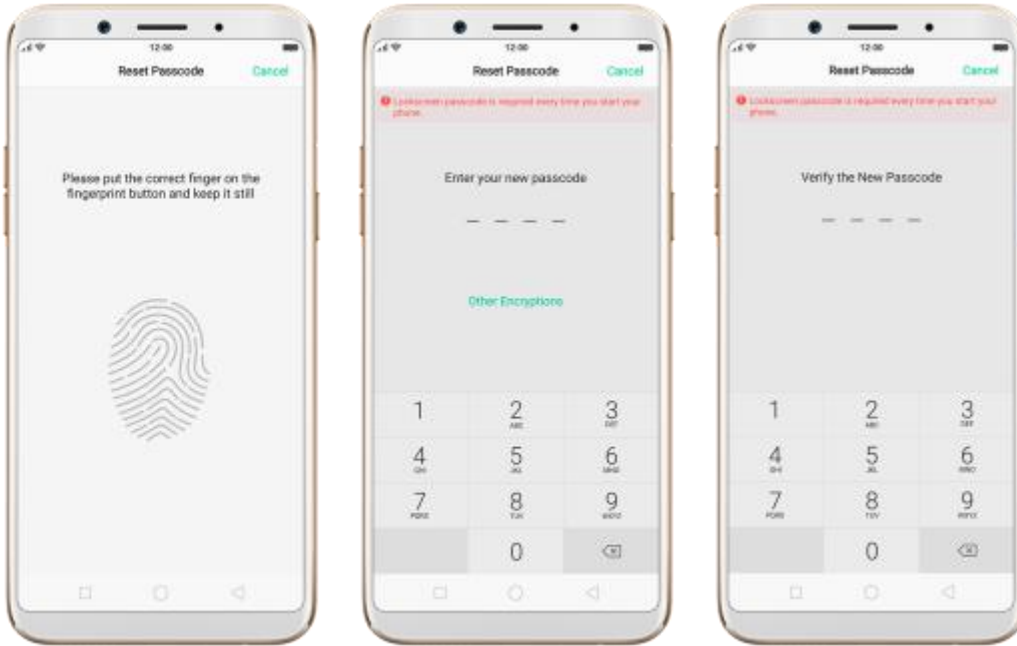

4.10. Control the volume

ColorOS 3.2 devices redesign the volume controls, which give separate controls for the ringer/notifications as well as media. Now you can control the media volume with the volume buttons even if your phone isn't playing anything at the moment.

Raise or lower the volume.

- **Using the Volume Buttons.** Click the volume buttons on the side of the phone, then you can control the ringer/notifications volume directly. To control the media volume, click  on the right, and then move its slider to the left or right.



- **Using Settings.** Go to **[Settings]** > **[Sound & Vibration]**, then you control the ringer and media volumes by moving the sliders or clicking the Volume Buttons.

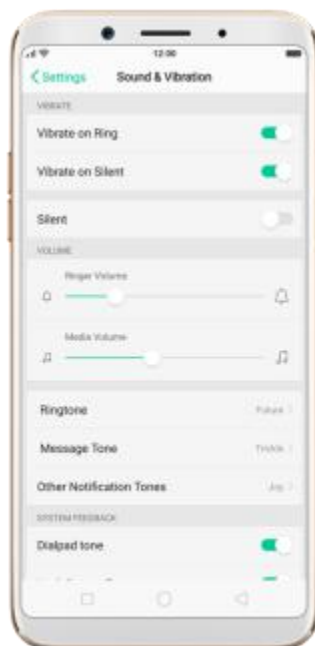

- **Put the phone in ring or silent mode.** Go to **[Settings] > [Sound & Vibration]**, then toggle the Silent slider to white or green.

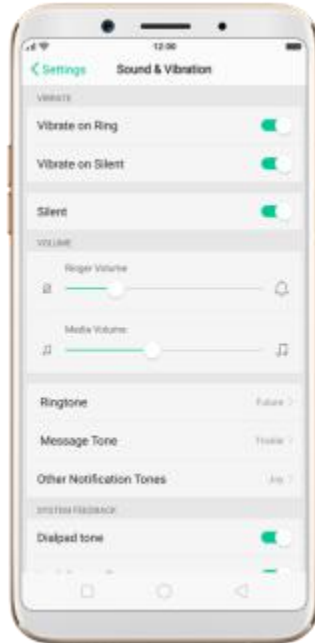

5. Basics

5.1. Use apps

Open apps

Press the Home button at any time to see your phone applications. Click any application icon to get started.

Apps will show the number of messages pending to be read in red on their Home screen icon.



Switch between apps

Click Menu button on the bottom left would bring up a menu for apps that you were in. Swipe left or right to see more. To switch to another app, click it.



Close apps

Click Menu button on the bottom left, and then:

- **Close an app:** Swipe the app up to the top edge of the screen.
- **Close all apps:** Click  to clean up the list.

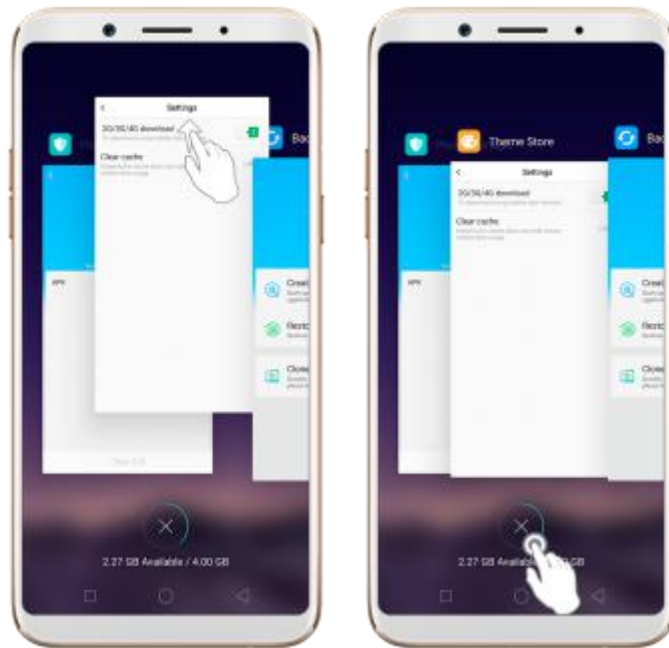

5.2. Share from apps

In addition to share your information from the Files app, you can also share from many other apps in your OPPO smartphone.

Share from apps. In many apps, you can click Send or  to choose how to share your information. The choices vary depending on the app you're using. Additional options may appear if you've downloaded apps with multiple sharing options.

Take the Photos app as an example, click  and you'll see all the sharing options.

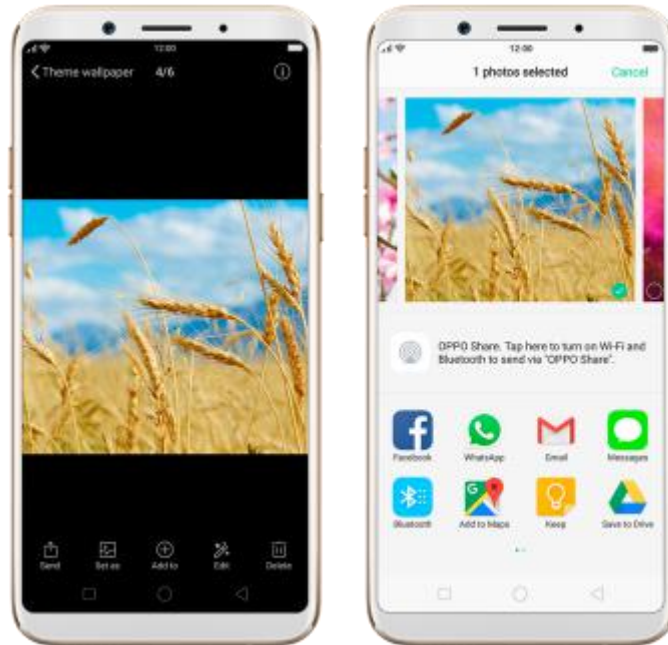

5.3. One-click cleanup

One-click cleanup option helps you to make your phone perform steadily and faster.

Stop background apps. Click Menu button >  to close all active apps. If you want to close a specific app, swipe it up.



Clean up & Accelerate. Click Phone Manager on the Home screen, then click **[Cleanup & Accelerate]**. Scan and delete all kinds of junk files. You can also delete unnecessary files, such as downloaded APKs, music, pictures, and more.

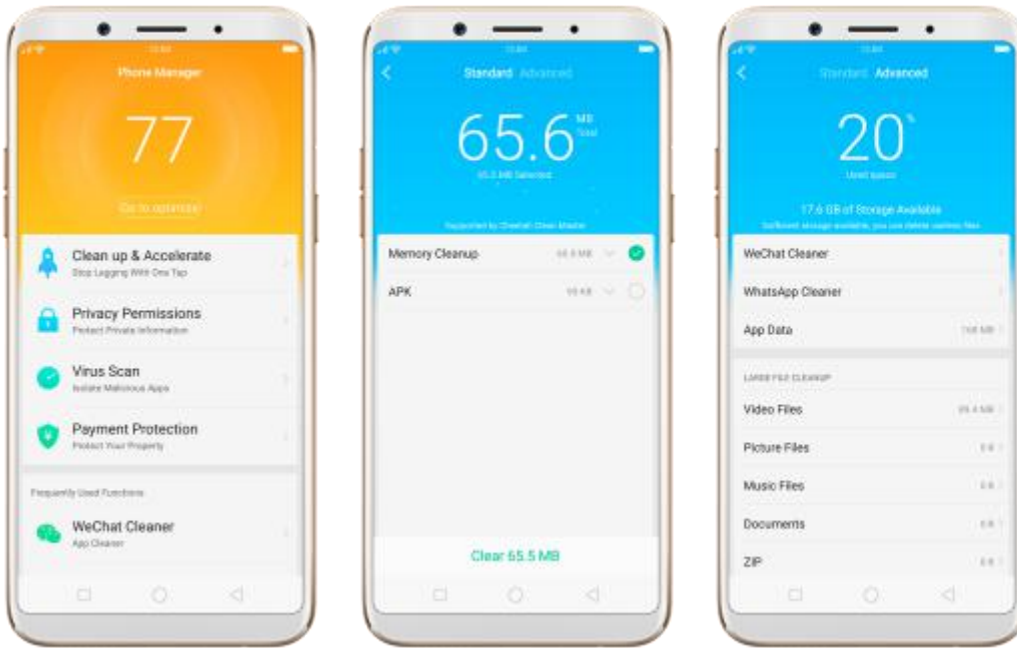

5.4. Lock the running background apps

You may close the running background apps frequently to make your phone perform steadily and faster. If you want some apps to be always connected and reachable, do the following:

Lock an app. Click **Menu** button to reveal your open apps, then swipe an app down to the bottom edge of the screen. Notice that a lock appears in the upper-left corner of the app.

Repeat the action for more apps.



5.5. View, zoom in and out

Use the touchscreen to interact directly with what is displayed.

View items. Drag up or down to scroll. You can also drag some screens in any direction, such as webpages. Flick to scroll quickly. You can wait for the scrolling to come to a stop, or touch anywhere on the screen to stop it immediately.



On some screens such as Settings and Contacts page, double-click the status bar to quickly scroll to top.

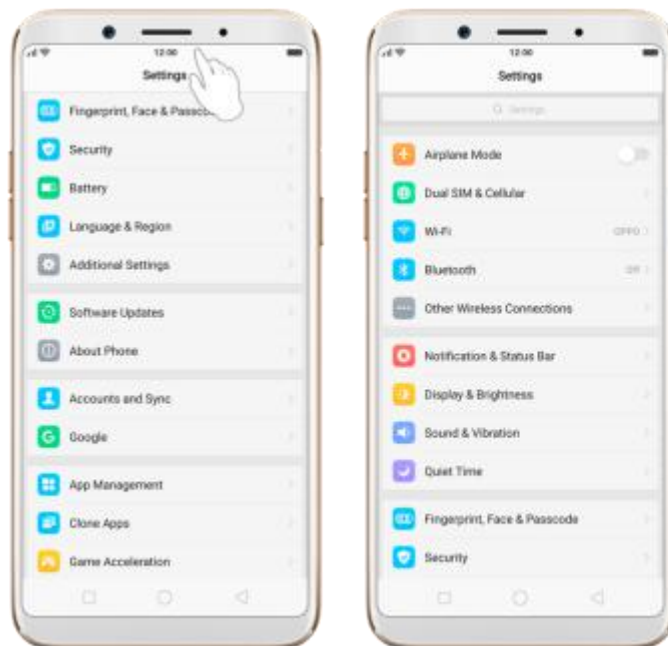

Zoom in and out. When viewing photos, maps, or web pages, you can zoom in and out. Pinch your fingers together or apart. For photos and web pages,

you can double-click to zoom in, then double-click again to zoom out. For maps, double-click to zoom in and click once with two fingers to zoom out.



5.6. Navigation Keys

ColorOS 3.2 replaces the traditional hardware buttons with on-screen virtual navigation keys, which can be hidden when not in use. You can also arrange the "Back" and "Recent" placements to how you prefer them. Besides, several fast and fluid gestures are added in your phone, which will give you a fresh experience of smartphone interaction.

Virtual Navigation Keys

Enable virtual navigation keys. Virtual navigation keys are default on. If you want to enable them manually, go to **[Settings]** > **[Additional Settings]** > **[Navigation Keys]** and click Virtual Navigation Keys.

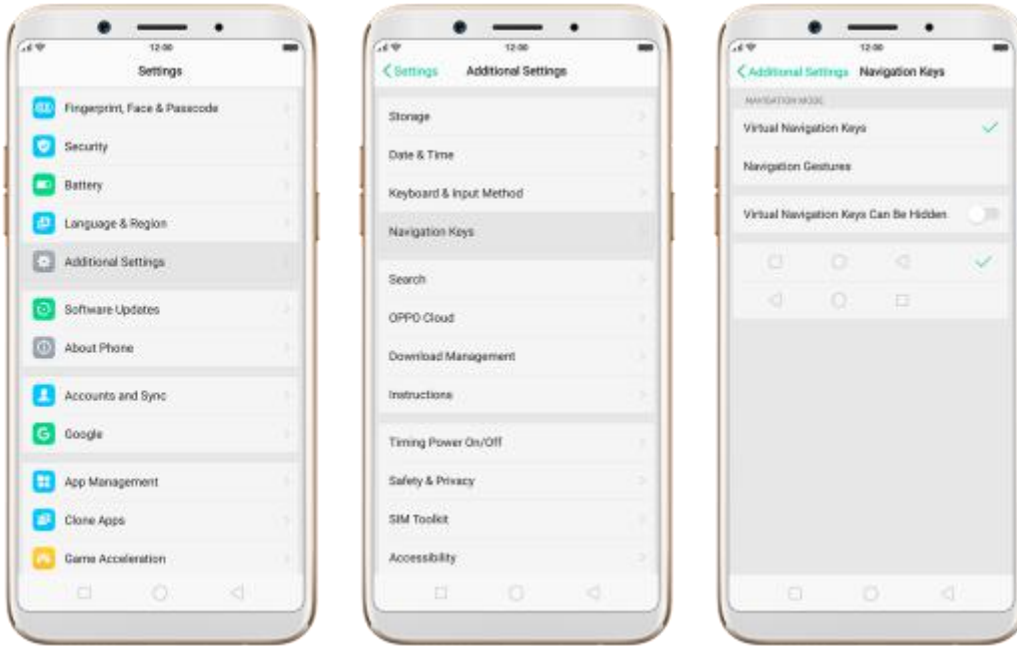

Change the order of virtual navigation keys. The keys follow the typical order for OPPO: recent, home, and return from left to right. If you are left-handed, you can change them to the return-home-recent order.

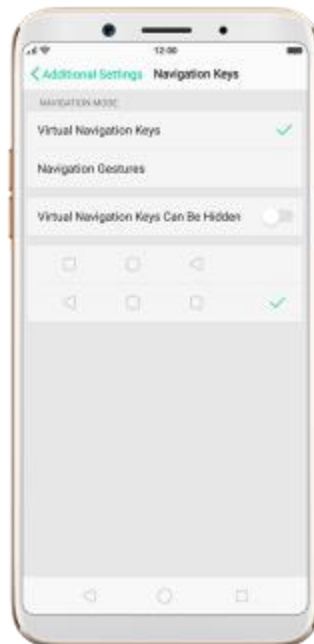

Hide the virtual navigation keys. When you launch a full-screen app, the keys will automatically be hidden, and can be brought back with a simple swipe:

- When in portrait mode, swipe up from the bottom.
- When in landscape mode, swipe from the bottom to the left.





Manually hide the virtual navigation keys. To set the keys to appear only when needed, go to **[Settings] > [Additional Settings] > [Navigation Keys]** and enable **[Virtual Navigation Keys Can Be Hidden]**. Then you can click  on the left-lower corner of the screen to hide the keys, and swipe from the bottom to reveal them.

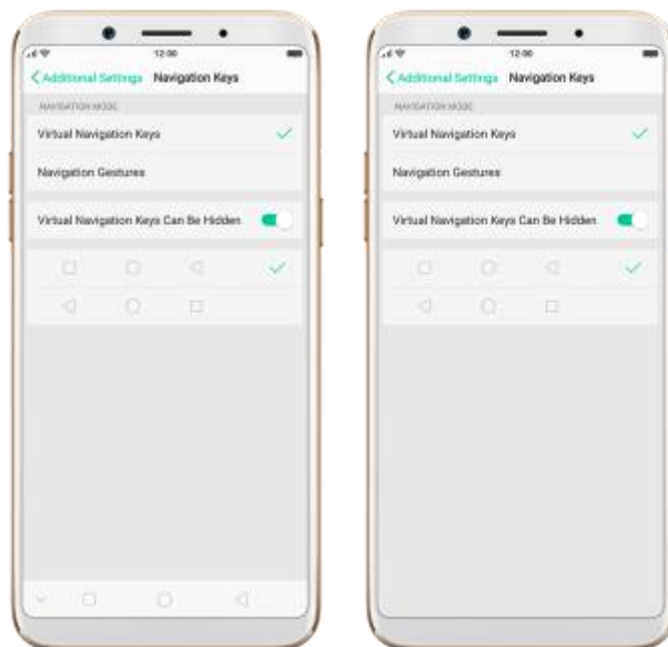

Immersive navigation background. The system set multiple colors for the navigation background to match the color scheme of the popular apps. The

background color is default white, and it will become translucent or immersive when you open some of the third-party apps.

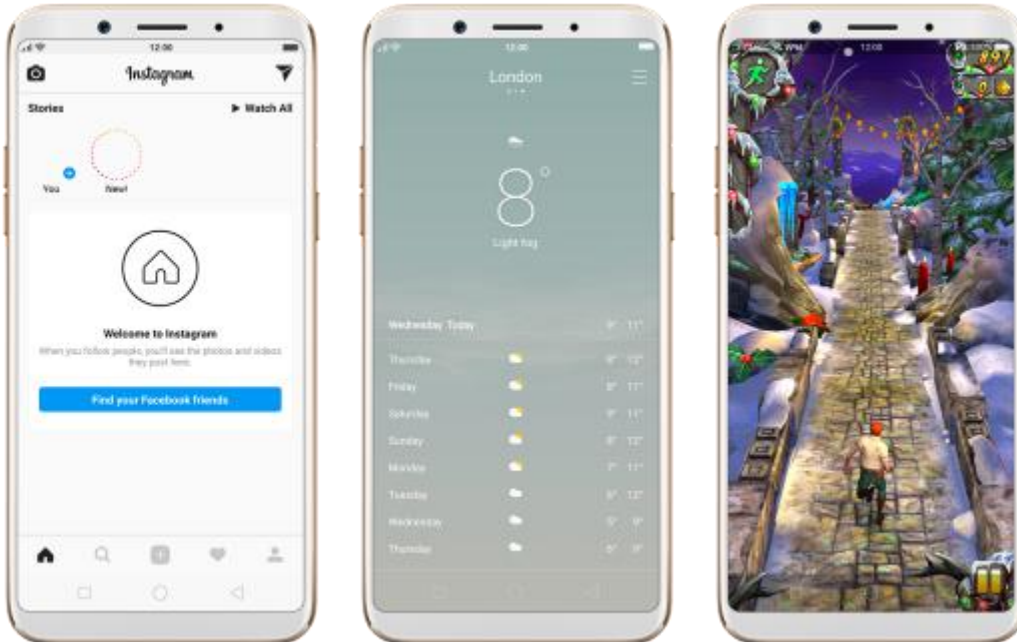

Navigation Gestures

Enable navigation gestures. Go to **[Settings]** > **[Additional Settings]** > **[Navigation Keys]** and click Navigation gestures.

Virtual navigation keys will be hidden and replaced by navigation gestures once you enable navigation gestures.

For example, to perform **[Back from right, control center from left]**, you can operate your phone with the following gestures:

- **Return to upper page.** Swipe up from the right bottom edge of the screen.



- **Open Control Center.** Swipe up from the left bottom edge of the screen.



- **Return to the Home screen.** Swipe up from the middle bottom edge of the screen.



- **Open recent tasks.** Swipe up from the middle bottom edge of the screen and pause 1 second.

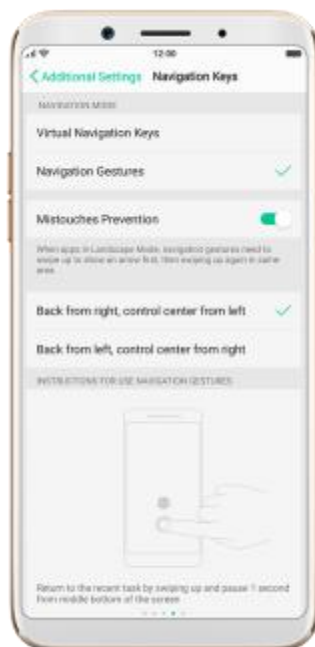

- When in landscape mode, you need to swipe up from the bottom of the landscape screen.

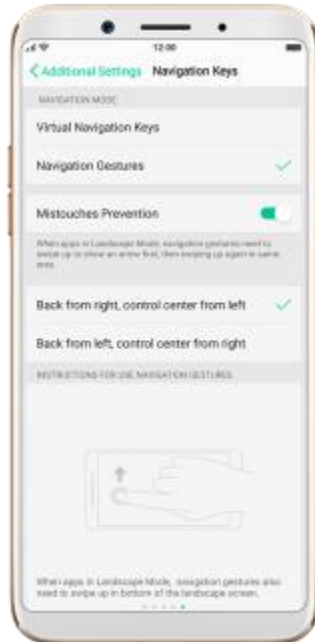

Enable Mistouches Prevention. Go to **[Settings] > [Additional Settings] > [Navigation Keys]**. When you open apps in Landscape Mode, you need to swipe up to show an arrow first, then swipe up again in the same area.



5.7. Change the screen orientation

OPPO smartphone supports portrait and landscape screen orientations.

Every time you shift your hands, the screen rotates.

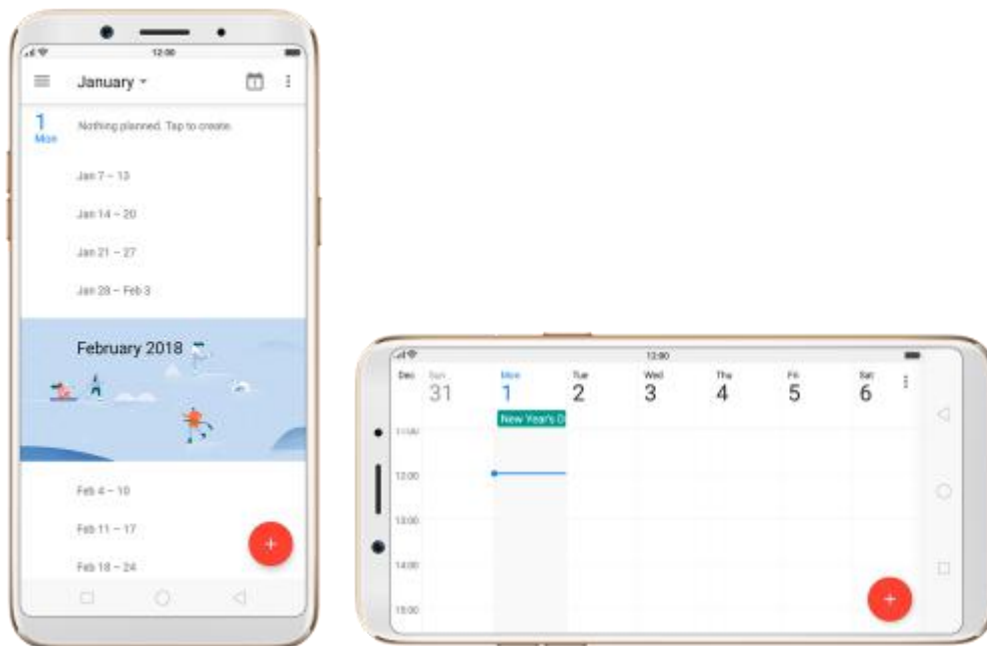

To lock the screen in portrait orientation, swipe up from the bottom of the screen to open Control Center, then click . Or go to **[Settings] > [Display & Brightness]** and toggle the **[Portrait Orientation Lock]** slider to green.

Notice that  appears in the status bar.



5.8. Multiple modes with easy access

ColorOS 3.1 lets you set multiple modes to fulfil your personal needs. The split screen mode allows you to work with a second app with the other one remained active. Now you can watch a movie and chat with friends at the same time.

To use Split-screen: Go to **[Settings]** > **[Split-screen]** and turn on Split-screen, then open an app. Under the interface of the app, press and hold Menu button and select the other split-screen app. Now your screen will be divided into two areas, which each area shows a different scene at the same time.

* Notice: Both apps need to support Split-screen function. Your phone will alert you if the app doesn't support that.

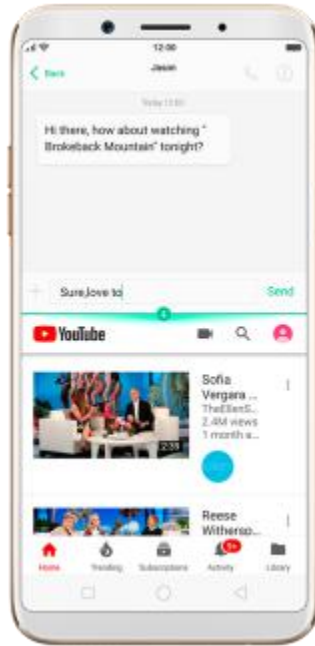

5.9. Take a screenshot

You can capture the screen on your OPPO smartphone using three ways:

Capture the current page

- **Press and hold the Power and Volume Down buttons** for about 2 seconds, the screen will briefly flash white, and you'll hear a shutter sound if your phone's sound is on.



- **Gesture Screenshot:** Go to **[Settings] > [Gesture & Motion]** and turn on **[Gesture Screenshot]**. Then swipe the screen up or down with three fingers to take a screenshot.



Capture a long screenshot

With OPPO smartphone, you can easily take longer and scrolling screenshot with simple clicks. Long screenshot allows you to take scrolling screenshot of your conversations on messaging apps or a full webpage. ColorOS 3.1 devices can take long screenshots up to 40 pages.

Note: Long screenshot cannot work when you are on the home page of your phone.

To capture long screenshots:

1. Press and hold the **Power** and **Volume Up** buttons for about 2 seconds, then your phone will be ready to capture the screen.
2. Click **[Page-down]** to scroll to the next page, continue to click **[Page-down]** until you want to stop capturing.
3. Click **[Save]** to generate a long screenshot. The image is saved in the **Photos** app.

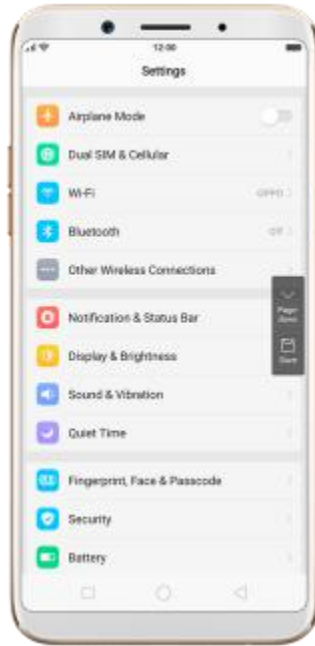

5.10. Notification and Status Bar

Notifications

Notifications alert you to the arrival of new messages, incoming calls, calendar events and so on. When a notification appears, you can click it to open or swipe it away to dismiss.



View all notifications. Swipe down from the top of any screen to open notification center.

Open the app to respond. Click a notification to go to the related app.

When phone screen is locked, swipe the notification right. You may need to enter your passcode.

Dismiss notifications. Swipe the notification left. To dismiss all notifications, Click  .

Manage your notification settings. Swipe the notification left, click **[Settings]**, or go to **[Settings] > [Notification & Status Bar] > [Manage notifications]**.

Select an app from the list to customize whether new notifications from that

app appear on the lock screen or notification bar, display a banner, play a sound or vibrate, and more.

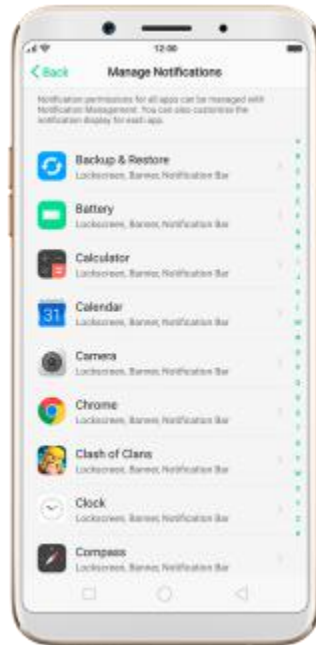

You can also let your phone pulse light and turn on screen for new notifications.

Status Bar

Status icons are displayed on the status bar, indicating for instance wireless connectivity, the battery status and operator info.

Display or hide status icons. Go to **[Settings]** > **[Notification & Status Bar]**, and toggle the slider to green/white.

Control Center

OPPO smartphone allows you to control many basic features with just a swipe.

By accessing the Control Center,



1. You can quickly access to frequently used functions such as Wi-Fi, Mobile Data, GPS, Bluetooth, OPPO Share, Personal Hotspot, **Flashlight**, **Calculator**, **Clock**, Camera and more.
2. You can also personalize your settings such as **Silent Mode**, **Airplane Mode**, **Portrait Orientation Lock**, **Disable Button keys**, **Brightness** and more.

Open Control Center

Swipe up from the very bottom of any screen to access it.



5.11. Personalize your Control Center

Swipe the shortcut bar left and click . You can change or rearrange the shortcuts according to preference. Drag  next to a shortcut name up or down to enable or disable the shortcut. You can add nine shortcut keys at most.





Airplane Mode. Airplane mode disables your phone's wireless communication abilities, theoretically making it approved for use on aircraft. While in airplane mode, your phone cannot send or receive phone calls and messages.

Turn on Airplane Mode: Go to **[Settings]** > **[Airplane Mode]** and tap the

slider to turn it on. You can also swipe up from the bottom of your screen to open Control Center, then tap . Notice that the carrier information in the upper-right will be replaced with an airplane icon. Wi-Fi and Mobile Data will be turned off when Airplane mode is enabled, but you can still turn on Wi-Fi under Airplane mode.



Quiet Time. With OPPO phone's Quiet Time feature, you can silence your phone when you need privacy. You can even set it to a schedule, or allow only specific people to reach you.

Turn on Quiet Time. Swipe up from the bottom of the screen to bring up the Control Center, then click . Or go to **[Settings] > [Quiet Time]** and toggle the **[Enable Manually]** slider to green. Notice that  appears in the status bar.



Schedule Quiet Time. If you want to set Quiet Time to automatically turn on at specific times, you can set a schedule for it. Toggle the Scheduled slider to green, and change times when you want it to start and stop.

Allow notifications. You can set Quiet Time to allow notifications, and allow calls and messages to come through from people that you specify.

Allow repeated calls. Toggle the **[Repeated Calls]** option to allow a call to come through if it rings for the second time in three minutes or less.

Close Control Center. Swipe down, tap the top of the screen, or press the Home or Return button.

5.12. Search

Use the OPPO smartphone's Search feature to find specific apps, contacts,

messages, or quickly search the Internet.

Search with OPPO phone. Swipe down on any page of the Home screen. Do not start swiping at the very top of the screen - that will open the Notification Center instead. Type in your search query, then click a search result in the list to open it.



Close Search. Click "Cancel", the **Return** button, or the middle of the screen.

5.13. Text

5.13.1. Add or change keyboard languages

If you need to type in a foreign language on your OPPO phone, you can do so by adding and changing the input language:

Add installed languages. Go to **[Settings] > [Additional Settings] > [Keyboard & Input Method] > [TouchPal for OPPO] > [Languages]**, then tick the languages to use.

You can also add languages as you type. Click  > **[Language] > [Add language]**.

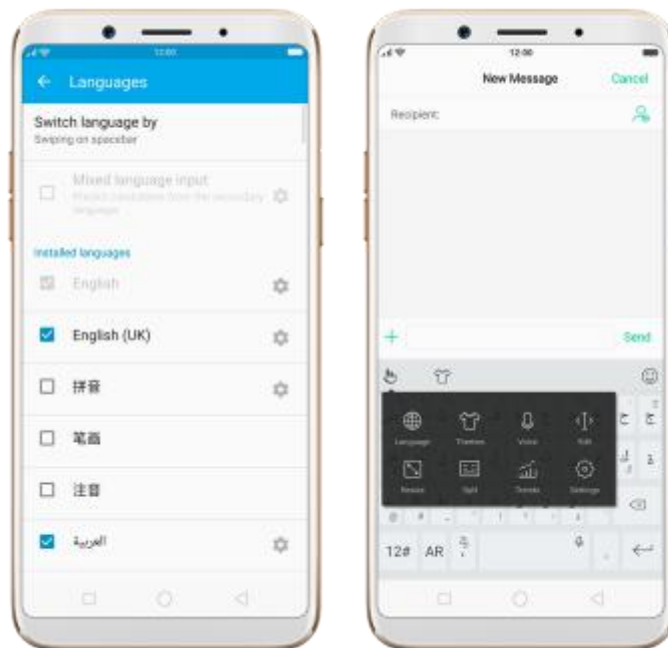

Download available languages. Click to download the language pack. You'll see the language in Installed languages list when the download completes.



Change Keyboard languages. As you type, switch language by clicking **EN** or swiping on spacebar.

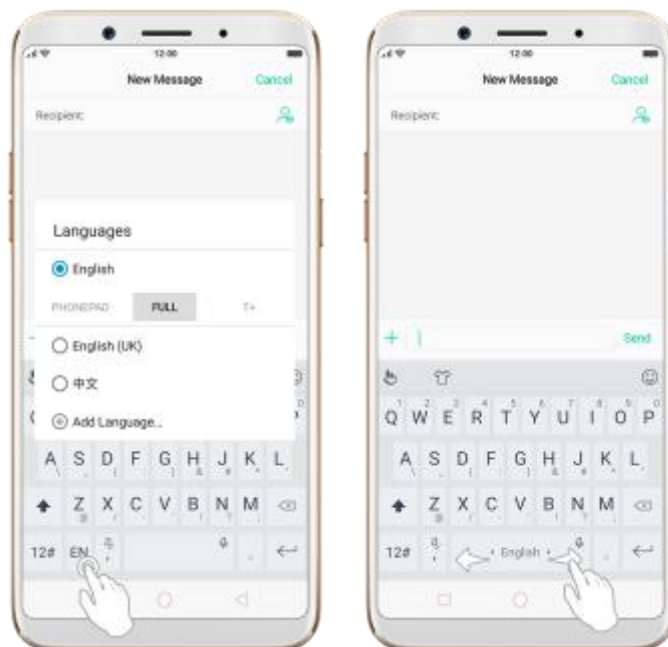

5.13.2. Type, edit and delete text

Type text

Click a text field to pop up the keyboard, then click the letter to type.

Type capital letters. OPPO smartphone auto-capitalizing the first letter of a sentence, or you can click  to type capital letters.

Turn on Caps Lock. Double-click . A line will appear under the arrow if you have done this correctly.

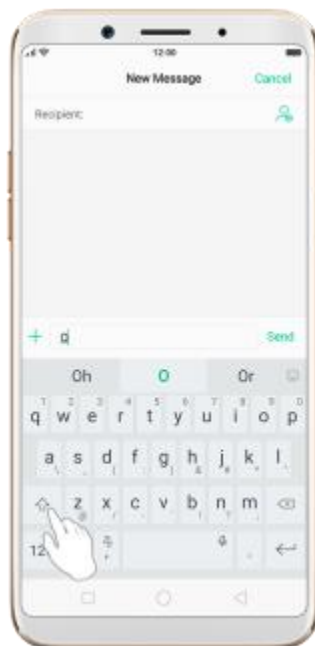

Enter numbers, punctuation, or symbols. Click 12#. To type alternate characters, touch and hold a key, then slide to choose one of the options.



Switch language. Go to [Settings] > [Additional Settings] > [Keyboard & Input Method] > [TouchPal for OPPO] > [Languages].

Tick the languages to use, then switch language by clicking **EN** or swiping on spacebar.

Revise text. Click on your text to move the cursor to the insertion point.

Edit text

Select text. Touch and hold the target text, or double-click the target text to select. Drag the control points on either side of the highlighted word to select more or less text, or click **[Select all]** to highlight all of the text.

You can cut, copy, paste or share your text then.



Delete text

Click  to delete the selected text or characters before the cursor.



5.13.3. Smart input

Smart input lets you to enter text with ease and without errors.

Go to **[Settings]** > **[Additional Settings]** > **[Keyboard & Input Method]** > **[TouchPal for OPPO]** > **[Smart input]**.

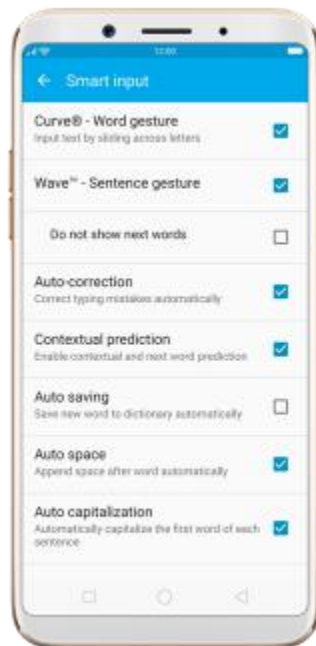

Use TouchPal Curve to input text simply by swiping across the keyboard, from one letter to another.

Use Wave – Sentence gesture to input commonly used phrases/sentences.

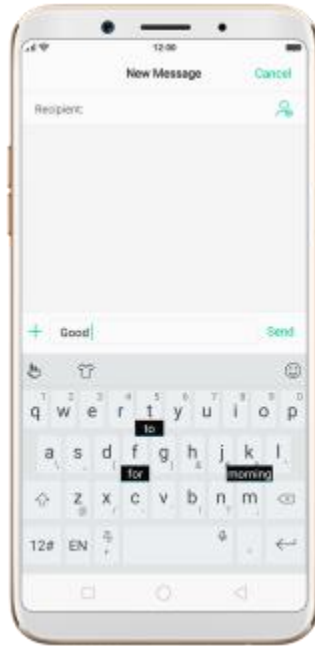

Correct spelling automatically. The keyboard will automatically check and correct the spelling of the text.

Predictive text. While you type, the keyboard predicts your next word, and offer suggestions for likely words before you finish typing. Click the word or the spacebar to select.

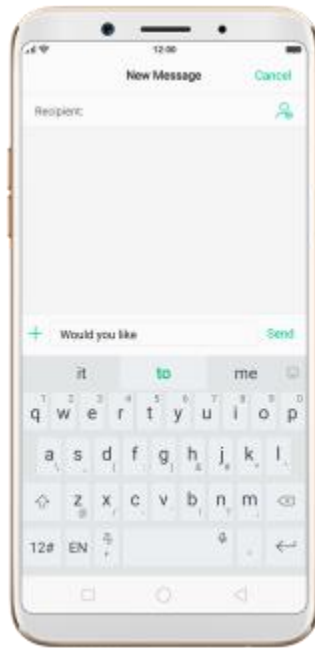

As you type, the keyboard will also automatically save new words to dictionary, append space after word and capitalize the first word of each sentence.

5.13.4. Voice typing

When you're connected to the Internet, you can use the built-in microphone to speak the text instead of typing it.

Start voice typing. Touch and hold the space bar on the bottom of the screen, or click  > **[Voice]**, then speak.

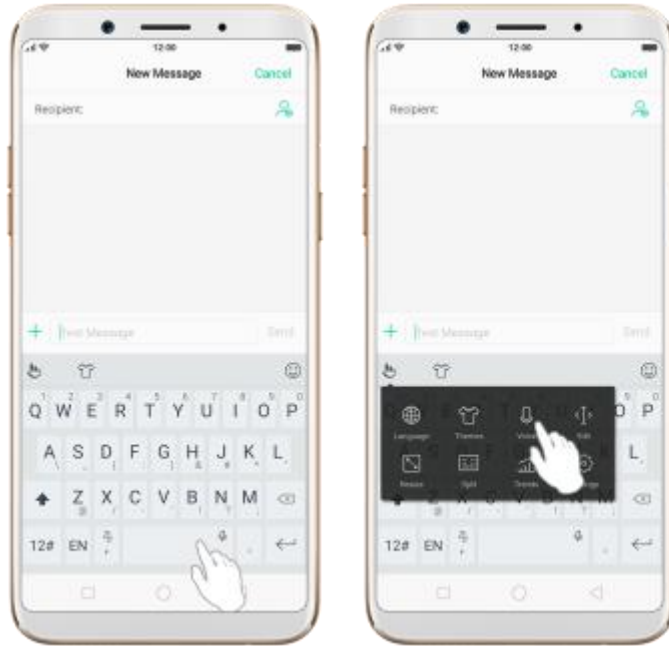

Pause voice typing. Click the microphone icon to pause/continue dictating.

Click ✕ to quit voice typing.

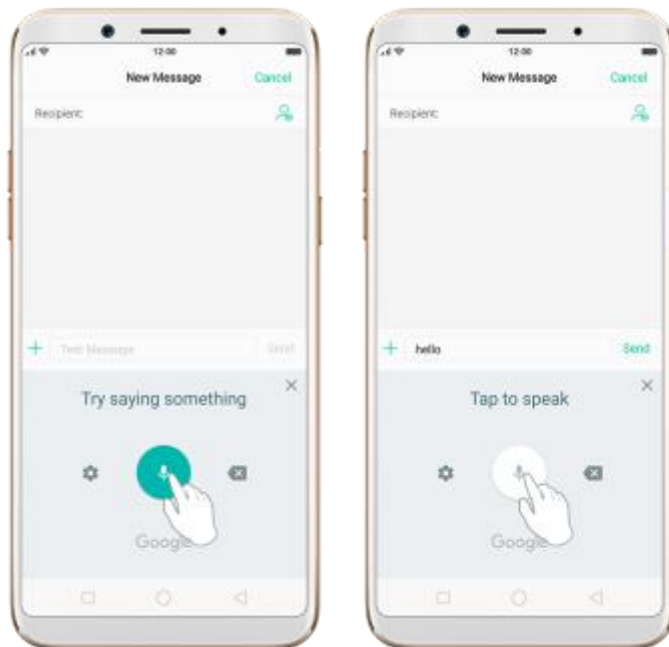

Select input languages. Click  on the panel, or go to **[Settings]** >

[Additional Settings] > [Keyboard & Input Method] > [Google voice typing] > [Languages].

Select your preferred languages. To select a primary language, touch and hold the language.

Insert and delete text. To insert or delete text, click to place the insertion point first. Click  to the right of the microphone icon to delete text.

To enable voice input while offline: Click  on the panel to manage [Offline speech recognition].

5.13.5. TouchPal for OPPO

TouchPal Keyboard is the default keyboard on OPPO smartphones. You can use it to enter text by tapping on the keys or swiping across the keyboard, from one letter to another. Besides its basic typing features, TouchPal has introduced some innovations. Click  on the on-screen keyboard to get more information.

Multiple themes available. You can dress up the keyboard with various themes or customize the keyboard by yourself.

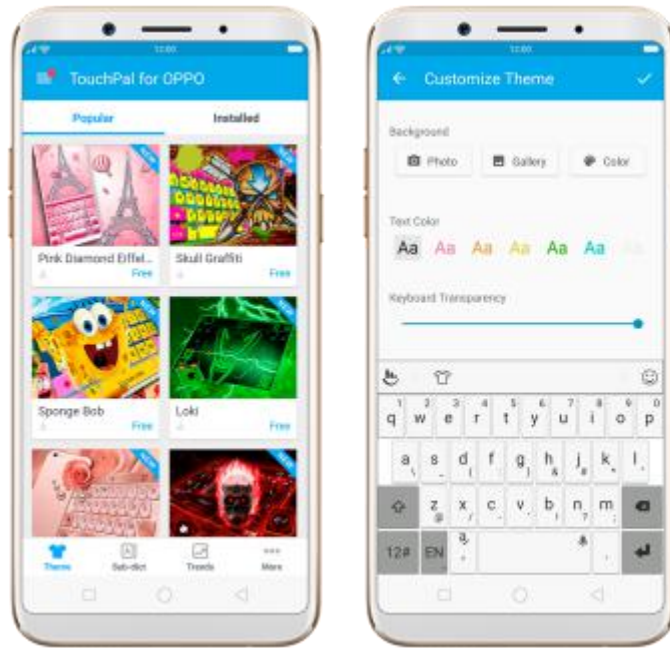

Emojis and stickers. TouchPal has multiple emojis and stickers, and can predict what emoji comes next.

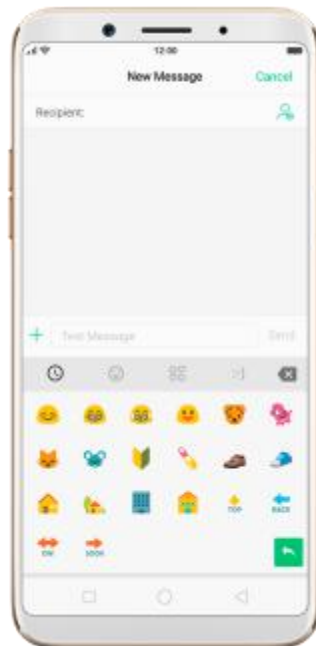

Smart input. With TouchPal Curve®, you can type by sliding from letter to letter instead of tapping. Advanced technologies such as Contextual Prediction, Autocorrection and Cloud Prediction also make typing faster. See Smart input.

5.14. Sound, Vibration and System Feedback

You can set an OPPO smartphone to sound or vibrate for incoming calls, messages and other notifications, and let your phone send sound or haptic feedbacks on key clicks.

Set your phone to vibrate. Go to **[Settings] > [Sound & Vibration]**. Separate controls let you set your phone to vibrate in ring mode, silent mode, or both.

Turn ringing on or off. Toggle the **[Silent]** slider to green or white. You can also swipe up from the bottom of the screen to open the Control Center, then click  to turn on Silent mode.



Adjust the ringer and media volume. Drag the control point left or right.

Change ringtones for incoming calls, messages and other notifications. In addition to the default ringtones, you can create ringtones using your own audio files.



Turn system feedback on or off. Toggle the sliders to green or white. When turn **Vibrate on Touch** on, your phone vibrates when you touch the **Menu**, **Home**, and **Return** buttons.

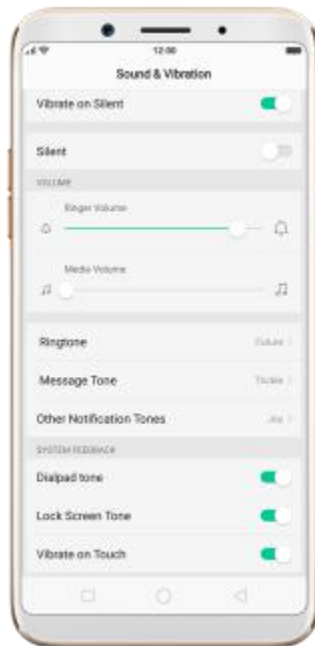

To temporarily silence incoming calls and alerts (without vibrations), see Quiet Time.

5.15. Charge and monitor the battery

OPPO smartphones are equipped with a non-removable, lithium-ion rechargeable battery. Do not attempt to open your phone. Charge the phone using the included cable and USB power adapter.

Charge the battery. Connect your phone to a standard power outlet or a

Power Bank.

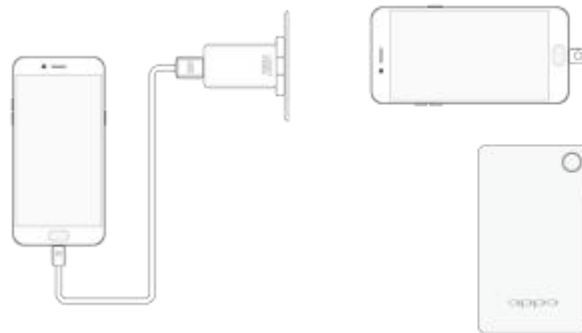

Charge the battery and transfer files. Connect your phone to a computer.



Notice : All photos shown are for illustration purpose ONLY. Actual products may vary.

An icon in the upper-right corner of the screen shows battery charging status.



Charging

VOOC Flash Charging

Notice: Rechargeable batteries have a limited number of charge cycles and may eventually need to be replaced. The OPPO smartphone battery is not

user replaceable; it can only be replaced by an authorized service provider.

Removing the battery yourself will void your warranty and might cause damage to your phone.

Show percentage of battery in the status bar. Go to **[Settings]** > **[Notification & Status Bar]** and turn on **[Battery Percentage]**.

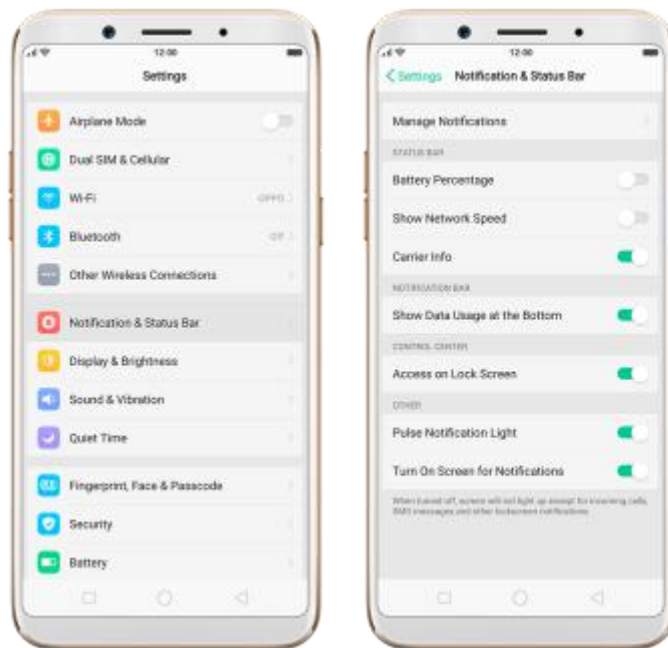

View detailed battery info listed for each app. Go to **[Settings]** > **[Battery]**.



5.16. Location Service

Apps like Maps, Weather and Compass must know your exact position before it can provide accurate services and results.

Turn on Location Service. Swipe up from the bottom of the screen to open

Control Center, then click  . You can also go to **[Settings] > [Google] > [Location]** and toggle the slider to green.



You can choose from three types of **positioning modes**, which differ in accuracy and battery drain:

1. **High accuracy** (GPS, Wi-Fi, Bluetooth and mobile network).
2. **Battery saving** (Wi-Fi, Bluetooth and mobile network).
3. **Device only** (GPS).

A history of recent location requests. You'll see a list of apps that have requested location. You can turn off each app's access to each of these categories of information:

- Camera
- Location
- Microphone
- Phone

- Storage

Google Location service

Use **Google Location History** to retrace your steps. Google Location History will customize search results for location and search history.

Use **Google Location Sharing** to share your locations with friends and contacts in real time.

5.17. Use the phone internationally

When you travel overseas to other countries, do the following steps to make sure you stay connected to friends and family while traveling - without paying more than you have to.

Unlock your phone. Call your wireless operator and ask if your phone needs to be unlocked.

Shop international data roaming plans with your operator. Consult your operator or visit online to shop roaming plans used in the destination country or region.

Buy or rent local Nano SIM cards. You can buy or rent SIM cards for most of the countries and regions. Learn more from travel guides and websites related to the country or region.

Use Wi-Fi. Turn off global roaming on your phone and head to a Wi-Fi hotspot, such as a hotel lobby, or local cafes.

5.18. Power Saving Mode

Power Saving Mode helps increase battery life by intelligently decreasing background activities, for example, background media playback and downloads may be cut out, and notifications may be disabled. Using Power Saving Mode can give you at least extra 30 minutes to use the phone.

Turn on Power Saving Mode. The phone will let you know when your battery level goes down to 20%, and again at 10%, and will ask you to turn on Power Saving.



To manually turn on or off Power Saving Mode at any time, swipe up from the bottom of your screen to open Control Center, then click . You can also go to **[Settings]** > **[Battery]** and enable Power Saving.



6. Personalize your OPPO phone

6.1. ColorOS 3.2 device name

If you scan for a Wi-Fi Direct or Bluetooth connection with your OPPO phone, your device name will display on the target devices.

Change device name for Wi-Fi and Bluetooth. Go to **[Settings] > [About Phone]**. You can also change the device name when you enable Bluetooth or Wi-Fi Direct.

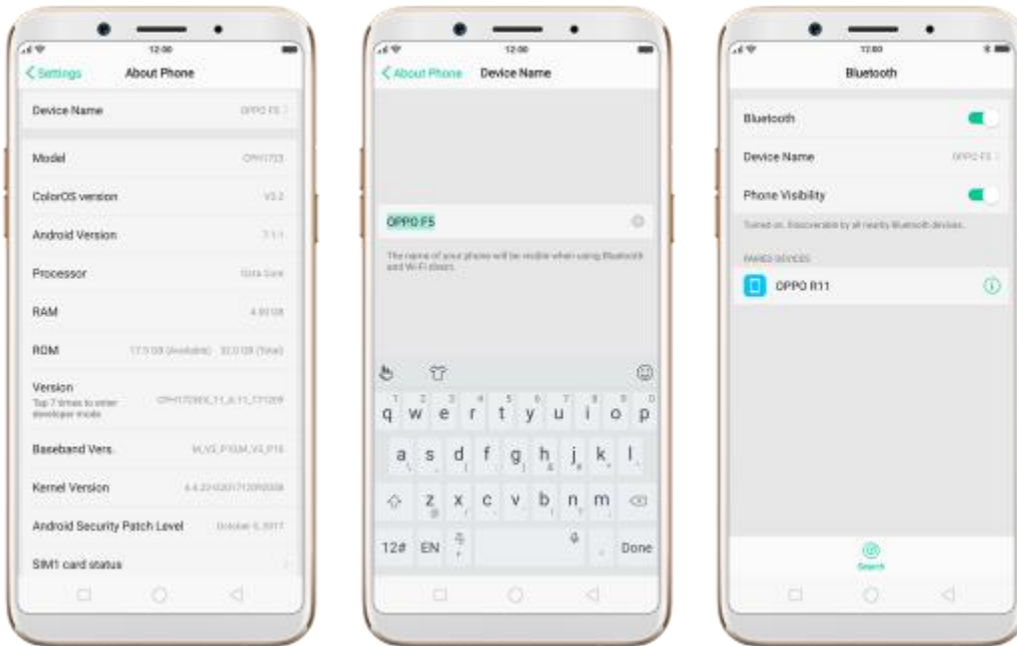

6.2. Personalize the Home screen

6.2.1. Organize the Home screen

From the Home screen, you can access all your apps and widgets. To keep everything in order, you can organize your home screen to make it more manageable and keep it looking neat.

Add or Remove a Home screen page

Add a Home screen page. Swipe to the rightmost screen and drag an app or widget off the screen to the right.



Remove a Home screen page. Drag all the apps and widgets on a Home screen page to another page. The empty Home screen page will be automatically deleted.

Group Apps

Make folders and group apps. You can put apps in folders, which can keep your home screen neat or help to organize similar apps.

Create a folder. Tap and hold on an app until the icons start wiggling. Drag one of the apps onto the other, and lift your finger when the first app seems to merge into the second one. Add more apps by dragging them in.



Edit the folder's name. When you first create a folder, your phone assigns a suggested name to it. To edit the name, tap on the text.



Rearrange apps and folders

Remove apps from a folder. Tap the folder, then tap and hold on an app until the icons start wiggling. Drag the app out of the folder and onto the home screen.

Delete a folder. Drag all the apps out of the folder and onto the home screen, and the folder will disappear.

Rearrange apps and folders. OPPO smartphone has set a default arrangement for users, but you can still rearrange the apps and folders to fit how you use your phone.

Rearrange apps. Tap and hold on an app until the icons start wiggling. Drag and drop the app icon to a new location. To save your changes, press the **Home** or **Return** button.

Notice: Icons will be aligned to the left automatically.



Move the icon to a new screen. Drag the icon off the screen to the right and let it go when the new page appears.



Add or remove Home screen widgets. See Home screen widgets.

6.2.2. Home screen widgets & Transition Effects

You can give yourself a fancy home screen with a highly-detailed set of widgets, for example, clock, weather, battery or mail widgets. You can also use them to tweak notifications, alarms and other options. In other words, there's considerably more here than just widgets.

Manage widgets

Add a widget. Pinch your fingers together, then click **[Widgets]**. You'll see all available widgets. Touch, hold and drag one widget to the screen. Make sure there is enough space for that widget.



Move a widget. Touch and hold a widget for about 2 seconds, then drag it around.

Delete a widget. Click  in the upper left corner of the widget.

Customize transition effect

You can change the transition effect on your OPPO smartphone, which is the style in which you slide the home screen right or left.

Set up transition effect. Pinch your fingers together, then click **[Effects]**.



Preview and choose an effect. Click a transition effect and it will show the preview effect. You can choose one from the five options:

- Default Mode
- Cube Slide
- Flipping Slider
- Card Effect
- Tilting Mode

6.3. Change the wallpaper

You see a wallpaper background picture when you unlock your OPPO phone.

You can select one of the images that are pre-installed in the phone, or use a photo from your photo gallery, or get some more wallpaper online.

Change the wallpaper. Go to **[Settings] > [Display & Brightness] > [Lockscreen Magazine & Wallpaper] > [Set wallpaper]**.

Tip: When setting the wallpaper as your Home screen or Lock screen, you can drag to move the image, or pinch to zoom in and out, so the image fits the screen.



Download online wallpapers. Click Wallpaper, then click Download more.

You can also click Theme Store on the Home screen directly to find more.



6.4. Lock screen magazine

You can let your lock screen's wallpaper to switch to a new picture every time you wake up your phone, **reducing** the likelihood of you getting bored with the same look.

Turn on Lock screen magazine. Go to **[Settings] > [Display & Brightness] > [Lock screen Magazine & Wallpaper]** and toggle the slider to green.



Add your local pictures to Lock screen magazine. Click My added photos, click  , then select your preferred pictures.

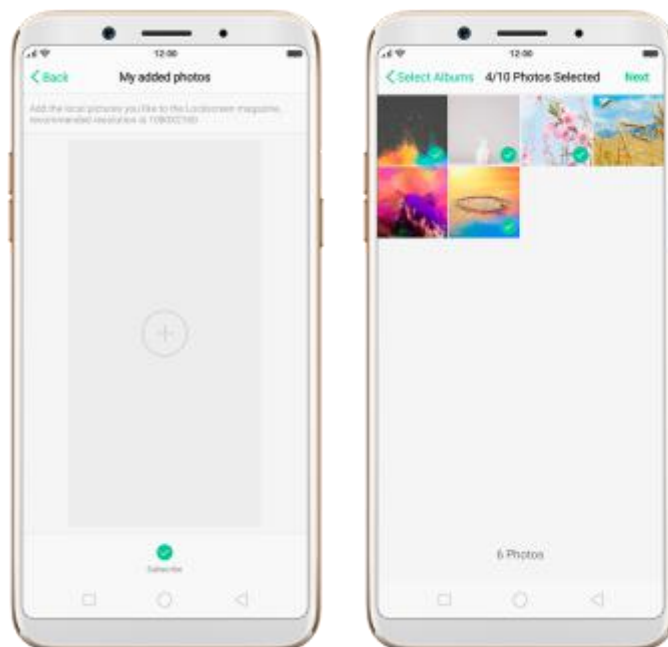

Add online pictures to Lock screen magazine. Click Subscribe and select

your preferred channels, then go back and click Check for updates. You can also set the lock screen magazine to update automatically.

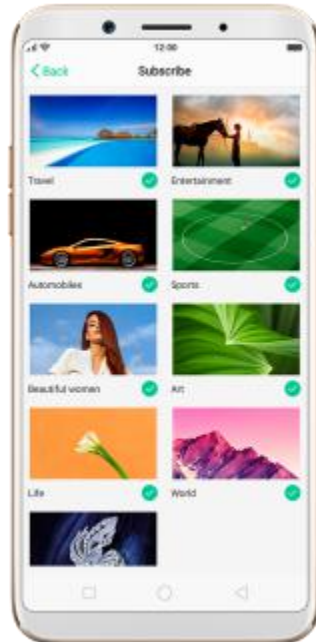

6.5. Adjust the screen brightness and color temperature

Adjusting the brightness on your OPPO phone tailors visibility to suit your environment. You can manually dim the screen when reading in bed, for example, or make it brighter when you're in a direct sunlight situation. Or use Auto-Brightness, which can automatically change screen brightness depending on the level of ambient light. Reducing screen brightness can also help to conserve battery life.

Adjust the screen brightness. Swipe up from the bottom of the screen to open Control Center, then drag . Or go to **[Settings] > [Display &**

Brightness], then drag the slider.



Set OPPO phone to adjust screen brightness automatically. Open Control Center, then click . Or go to **[Settings] > [Display & Brightness]**, then toggle the Auto-Brightness slider to green. If Auto-Brightness is on, your phone adjusts the screen brightness for current light conditions using the built-in ambient light sensor.

Use Nightly Shield. Go to **[Settings] > [Display & Brightness] > [Nightly Shield]**. Drag the control point to adjust color temperature. The warmer you set your screen, the less blue light will be emitted from the display. When you use the OPPO phone at night, you can turn on Nightly Shield to cut down on eye strain and sleeplessness you might get.

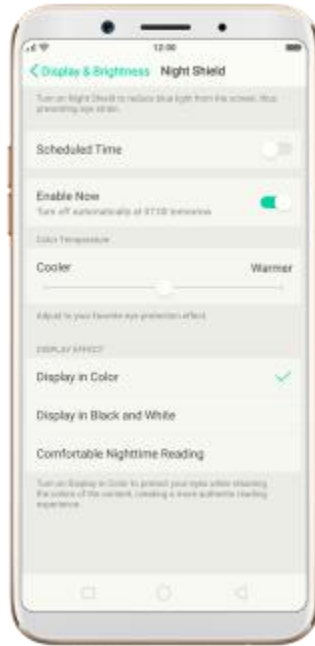

6.6. Change auto-screen lock time

By default, your OPPO smartphone locks automatically after 30 seconds. To modify this, alter the amount of time yourself.

Change auto-screen lock time. Go to **[Settings] > [Display & Brightness] > [Auto Screen off]**. Options range from 15 seconds to 30 minutes.

Tip: The longer your display, the more the battery drain.



6.7. Change the text size

OPPO smartphone lets you change the text size to fit your eyesight needs.

Change the text size. Go to **[Settings] > [Display & Brightness] > [Text Size]**. Drag the slider to the left or right to shrink or enlarge sample text, then you'll see your new text size immediately applied to the menu text in the upper-left corner of the screen.

Tip: This will not affect the size of your icon text.



6.8. Keyboard and input method

6.8.1. Customize the look of the keyboard

Make the keyboard your own by customizing the font and appearance.

Go to **[Settings] > [Additional Settings] > [Keyboard & Input Method] > [TouchPal for OPPO] > [General settings]**.

Change the font type. Click **[Keyboard font]** and choose one of the two fonts:

- TouchPal font
- System default font

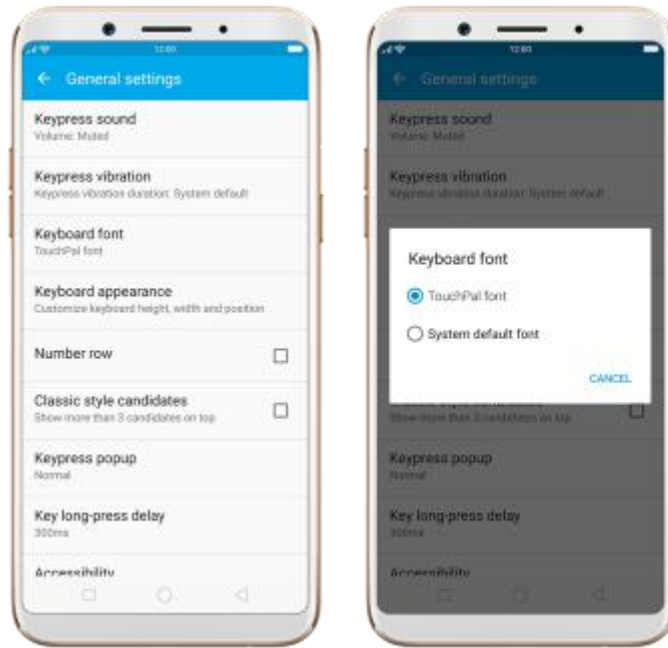

Adjust candidate word size. Click **[Keyboard appearance]**, then drag the control point to change font size to small, normal or large.

Customize keyboard appearance. Click **[Keyboard appearance]**, or click  on the on-screen keyboard > **[Resize]**, then drag the control arrow to adjust keyboard height, width and position.

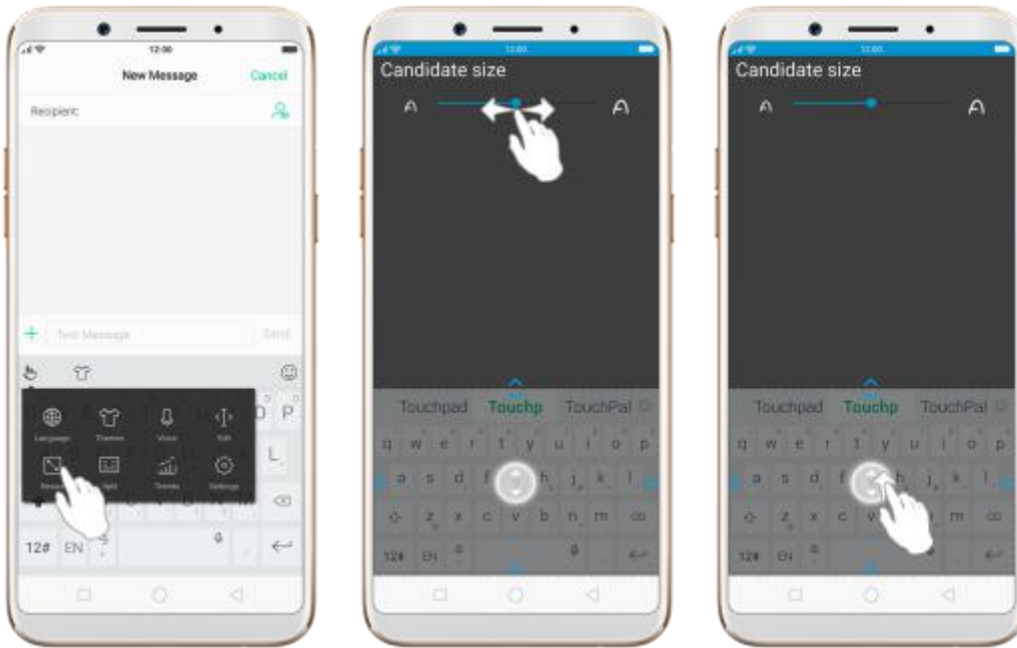

6.8.2. Split keyboard

You can split the phone's on-screen keyboard into two so you can grasp the phone with two hands and type with your thumbs in landscape orientation.

Split the on-screen keyboard. Click  on the on-screen keyboard, then click Split.

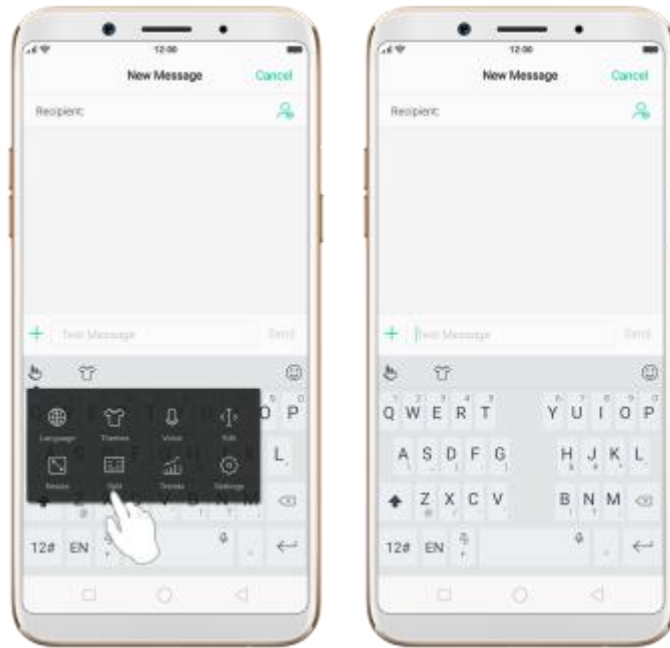

6.8.3. Trends

With TouchPal's Trends feature, you can download the keyboard themes and buzzwords, and get the latest news and headlines.

Get the latest trends. Click on the on-screen keyboard, then click Trends.

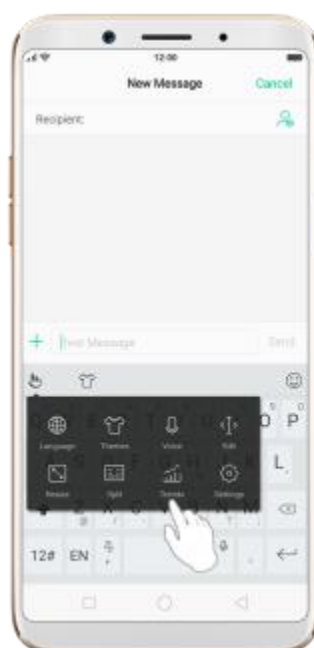

6.8.4. Keyboard general settings

OPPO smartphones come preloaded with TouchPal Keyboard. You can change the keyboard settings directly on your phone. click  on the on-screen keyboard, then click **[Settings]** > **[General settings]**.

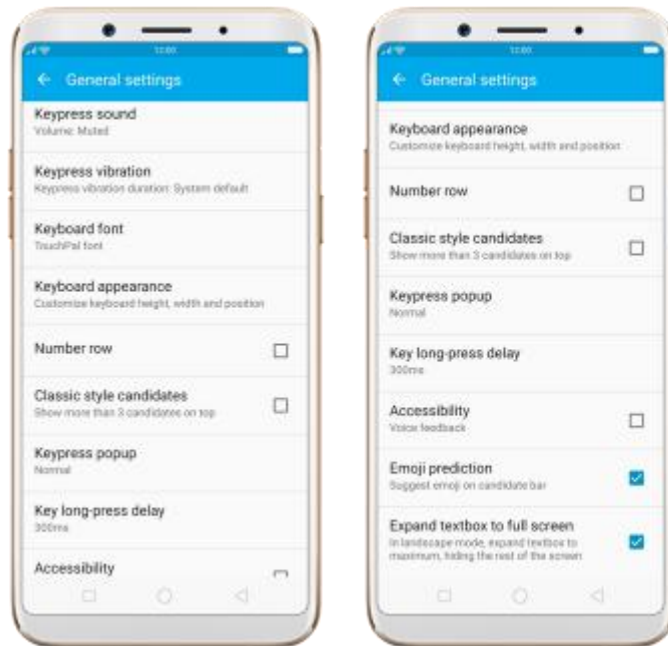

Setting	Effect
Keypress sound	Adjust the keypress sound, or use the system volume.
Keypress vibration	Adjust the keypress vibration duration, or use the system default setting.
Keyboard font	Switch to TouchPal or System default font on

	your phone.
Keyboard appearance	Customize keyboard height, width and position. See Customize the look of the keyboard.
Number row	Add the number row option in quick menu.
Classic style candidate	Show more than three candidates on top.
Keypress popup	A popup bubble displays when you click a key.
Key long-press delay	Adjust the long-press delay time ranging from 200ms to 1000ms.
Input animation	Float up effect when clicking the candidate word.
Accessibility	TouchPal reads exactly what you 're typing.
Emoji style	Switch to Android or System emoji on your phone.
Emoji prediction	As you type, TouchPal predicts what emoji comes next
Expand textbox to full screen	Keyboard opens as full screen in landscape mode.

6.9. Set up Startup Manager

Startup Manager helps you to manage system startup entries. You can choose what apps to startup after the phone reboots to meet your using habits.

* Too many self-starting apps may cause a low startup or operating speed.

Set up Startup Manager. Click Phone Manager on the Home screen, then click **[Privacy Permissions] > [Startup Manager]**. Toggle the sliders to white if you don't want to start apps when phone boots or in background.



Tip: For apps that receive real-time messages, such as Facebook, WhatsApp and Twitter, you are suggested to allow them running in the background without their being suspended.

6.10. Clone Apps

Clone Apps allows an app to run two accounts on a single phone on parallel.

To turn on **[Clone Apps]**, go to **[Settings] > [Clone Apps]**, choose an app and turn on **[Enable App Cloning]**. A new copy of this app will be generated on the homescreen after Clone Apps is enabled. This copy and its original app can run simultaneously without affecting each other.

1. "Clone Apps" works only if both the app itself and the phone supports it.

If a cloned app does not work properly, it means that the function or operation is not supported by the app or phone. Now OPPO smartphone supports two apps: WhatsApp and BBM.

2. "Clone Apps" currently does not support data transfer between a cloned app and a computer.

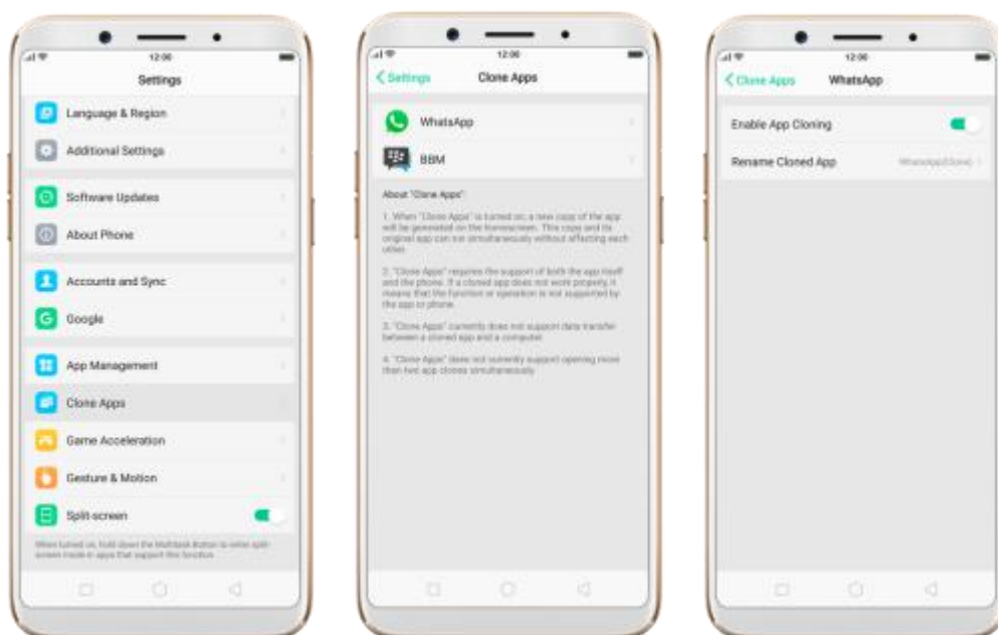

6.11. Manage Default App

What is Default App: If you've ever installed two different applications that essentially do the same thing (music players, web browsers), you'll likely be presented with a pop-up menu when trying to play a song or open a web page, asking you which application you'd like to complete the action with. You can manage your default app and never be bothered when performing that action again.

Manage Default App. Go to **[Settings] > [App Management]** and click **Default App** to manage Default App.

Take **[Photos]** as an example, there are six apps and you can choose one of them to be the default one. You are suggested to use the default apps to get a best performance.

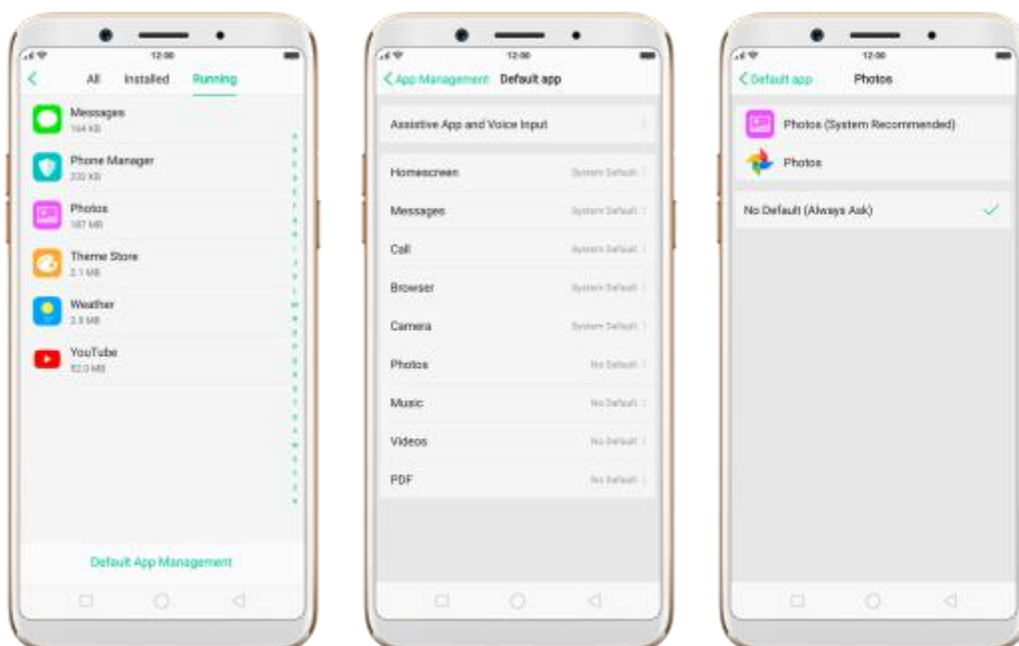

6.12. Gesture & Motion

Gestures

OPPO smartphone is designed to understand gestures. You can use gestures such as tap, swipe, drag and spread to operate your phone.

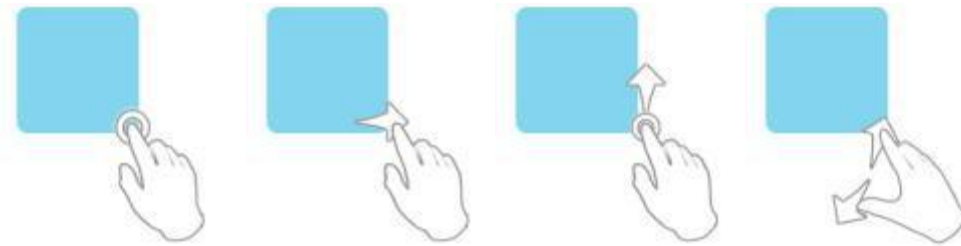

To set up complex gestures for specific functions, go to **[Settings]** > **[Gesture & Motion]**.

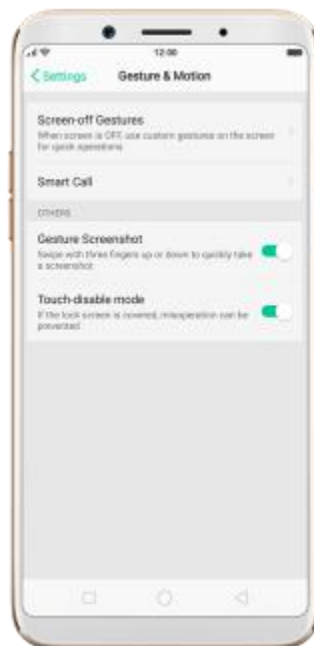

Screen-off Gestures

To set up screen-off gestures, you need to turn it on first.

Double tap fingerprint button for screen-on: Turn it on to wake up your locked screen with a double-click on the Home button. This function is only effective when the fingerprint sensor is turned off.

Double tap to turn screen on: Turn it on to wake up your locked screen with a double-click on the screen.

Draw O to start camera: When turn it on, you can draw O on the locked screen to open Camera app.

Draw V to open torchlight: When turn it on, you can draw V on the locked screen to open the torchlight.

Music control: When turn it on, you can draw || to pause/play a track, or draw < or > to switch the track when the screen is off.

Add more screen-off gestures: OPPO smartphone of ColorOS 3.1 gives you 7 options, which are **Draw ^**, **Slide up**, **Slide down**, **Slide left**, **Slide right**, **Draw M** and **Draw W**. Choose one to unlock the phone, call someone or start an app.



Screenshot Gesture

When turn it on, you can take a screenshot by swiping the screen up or down with three fingers.



Motion

The motion-sensing technology is used in OPPO smartphone. Use it to let your phone response to motion.

Smart call

Auto call when near the ear: Before you can use auto call, you need to set the default SIM card for calling. Go to a contact detail, call detail, message conversation or info interface, put the phone near your ear and your phone will automatically call that specific person.

Auto answer when near the ear: This function lets your phone to answer any incoming calls automatically when putting the phone near your ear.

Switch to receiver for calls: Use it to automatically switch from speaker to receiver when you put the phone near your ear during phone calls.

Flip to mute incoming calls: Use it to silence the ringer by turning the phone over on a table or other flat surfaces.

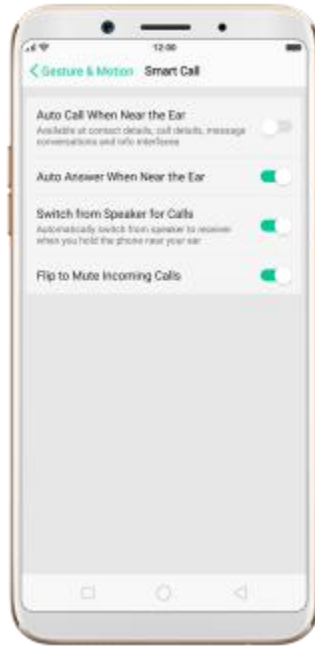

Touch-disable mode

Turn it on to prevent incorrect operations if the lock screen is covered.

Take selfies

Open Camera app and switch to the front camera. Click  > Palm on the top of the screen. Pose the same hand gesture towards the camera, once the camera captures that, it will take a photo automatically after two seconds. You can change your pose and expression within these two seconds.

6.13. Timing Power On/Off

Timing Power On/Off is a powerful and useful feature that helps you

automatically turn on or off your OPPO smartphone at the scheduled time you specify – for example, you can fall asleep while listening to your favorite music without having to worry about turning off your phone. It also gives you different ways to schedule the events for your needs, such as daily, weekly and only once.

Turn on Timing Power On/Off. Go to **[Settings]** > **[Additional Settings]** > **[Timing Power On/Off]**, then toggle the sliders to green as needed.

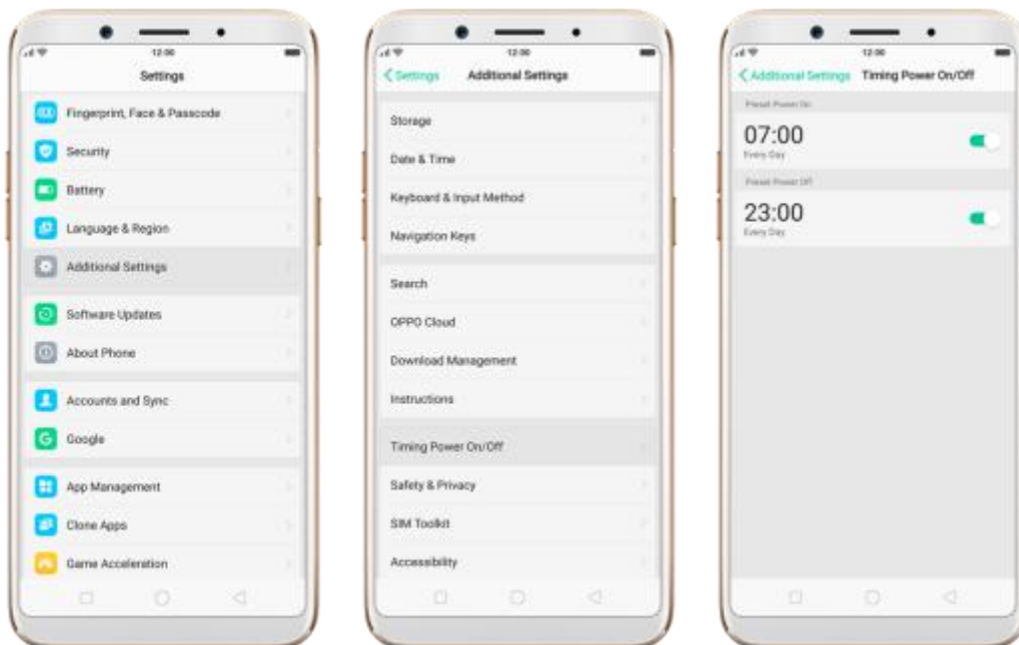

Set when to turn on or off the phone automatically. Click the time, drag your finger across each column to change the time, then click Save.



Repeat the event on certain days. Click the time, click Repeat, then choose the days.

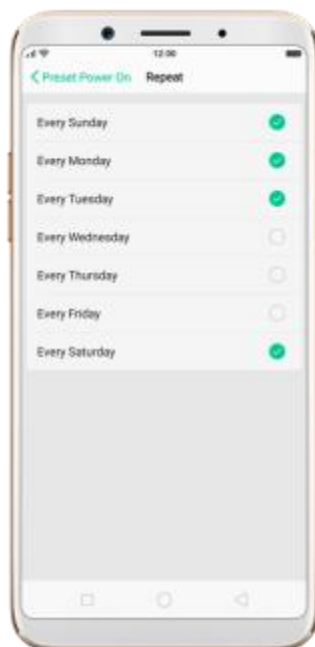

6.14. Game Acceleration

Game Acceleration feature is an all-in-one game optimization tool that allows you to run your games at the best possible performance. When you're running a game, your phone will automatically turn on high performance state, adjust the distribution of system resources, and optimize the game display configuration to provide the best gaming experience available. To prevent from being interrupted during games, you can also disable bottom keys, turn on No Disturbance mode, and more.

Tip: Currently, games that can be accelerated contain Candy Crush Saga, Clash of Clans, My Talking Tom, Candy Crush Soda Saga, Ball Pool, My Talking Angela, Farm Heroes Saga, Toy Blast, Hay Day, Temple Run 2 and Mobile Legend(VN/TH/ID). More games will be added soon.

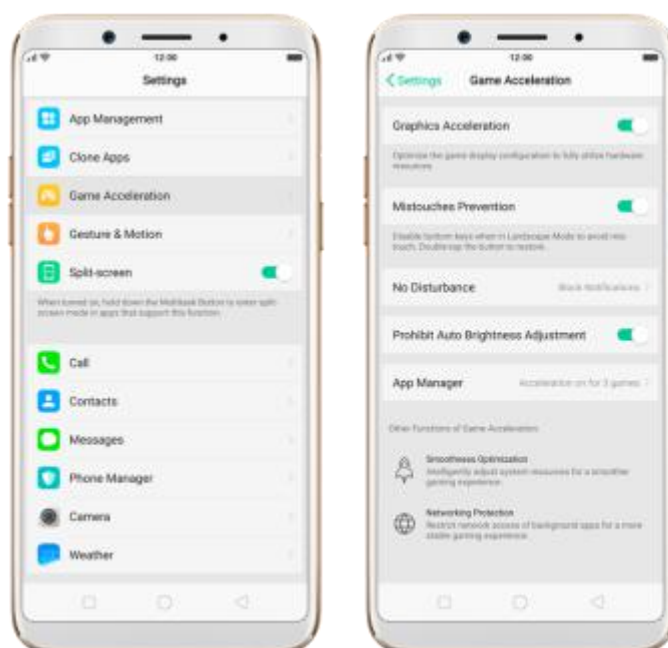

Manage games that can be accelerated. Go to **[Settings]** > **[Game Acceleration]**, click **[App Manager]** and you will see a list of your games that can be accelerated by your phone. To accelerate a game, toggle its slider to green.



- Your phone will automatically speed up your game. Notice that acceleration details display on the screen, and  appears in the status bar when you launch the game.

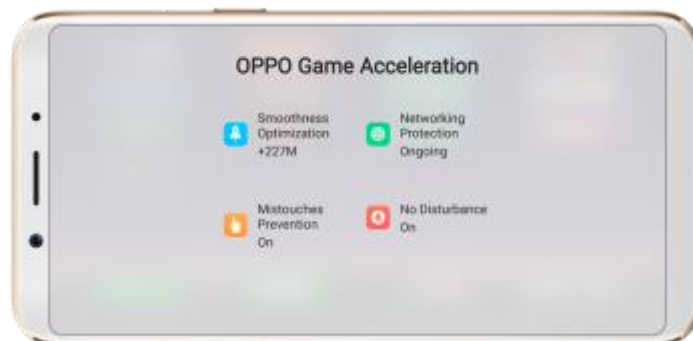



Set up Game Acceleration. Go to **[Settings] > [Game Acceleration]**.

1. **Graphics Acceleration:** optimize the game display configuration to fully utilize hardware resources.
2. **Mistouches Prevention:** disable bottom keys when you run a game in landscape mode. You can double-tap on the keys to enable them.



3. **No Disturbance:** block calls and notifications so that you can get fully immersed in the games.

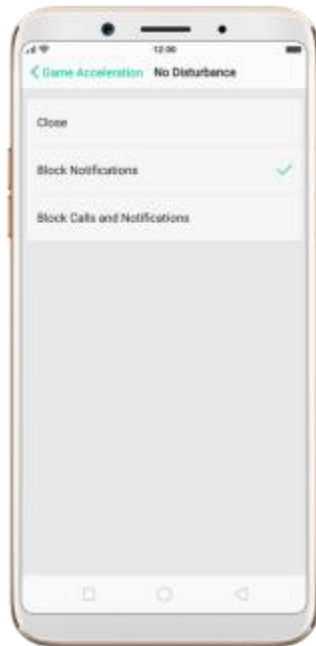

- **Close:** do not block any calls or notifications.
- **Block Notifications:** block notifications except calls, alarm clocks and scheduled reminders. Notifications will be displayed with a banner on the top screen.





- **Block Calls and Notifications:** block all calls and notifications.

4. **Prohibit Auto Brightness Adjustment:** your phone will not automatically adjust the brightness of the screen when ambient light changes.

6.15. App display in full-screen

ColorOS 3.2 devices feature a new full screen display format with an aspect ratio of 18:9, and most of the apps are supposed to adapt their size automatically to the new screen size. If some apps are not compatible with full screen mode, you can set them to display at the common 16:9 ratio, till they can support the full screen mode.

Adjust your app layouts. Go to **[Settings] > [Display & Brightness] > [App Display in Full-screen]** and you will see a list of apps that may not support the 18:9 aspect ratio. Toggle the slider to white if you want an app to display at a 16:9 ratio.

When the app has been optimized for full-screen display, its slider will turn

grey, and the app will display at a18:9 ratio by default.

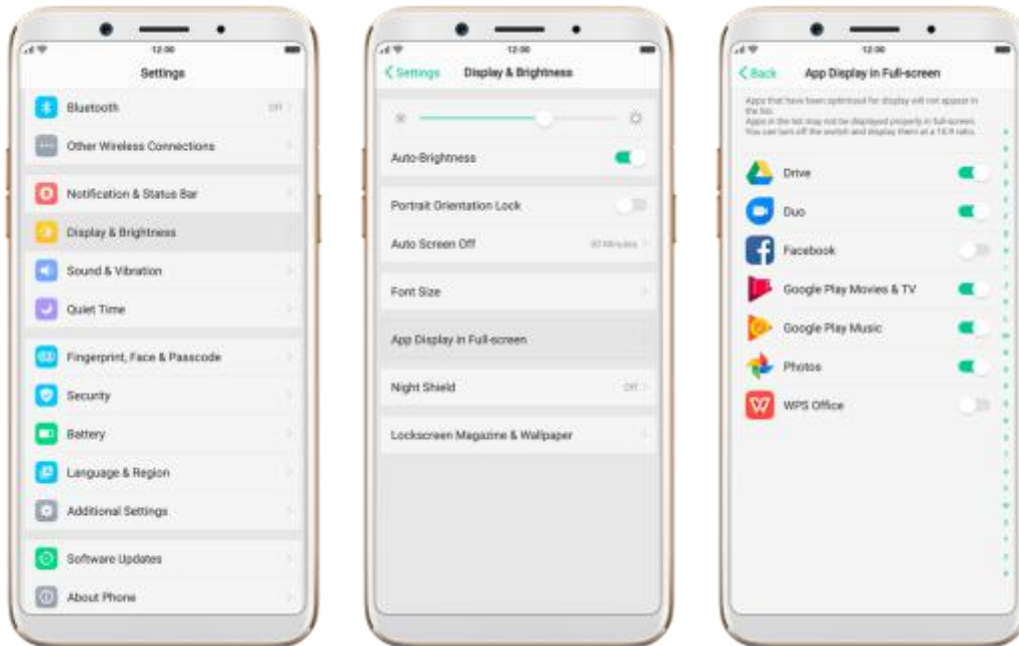

7. Apps

7.1. Phone



7.1.1. Make and Answer Phone Calls

- **Make a call**

To make a call and talk to your friends, you can manually enter a phone number on the dialer, choose a number in your Contacts or Favorites, or click one of the recent calls.

Note: The signal indicator at the upper-left corner of the screen shows whether you're in range of your operator's network and can make and receive

calls. The more bars, the stronger the signal.

Dial the number you want to call. Click Phone, click the keypad to enter the number, then click . Click  if you make a mistake. You can also copy a phone number then open the keypad, it will automatically paste the number to the keypad.

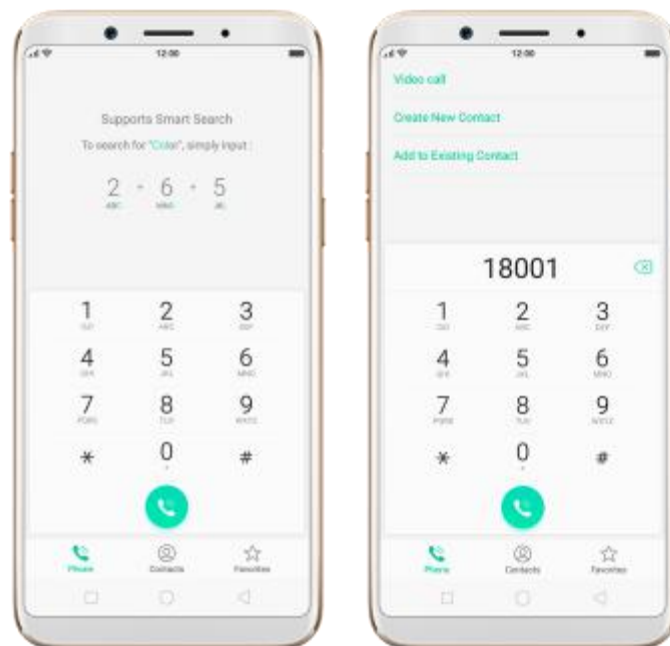

Call someone in your contacts list. Click Contacts and choose a contact, then click the phone number to make a call. You can also use Search feature to find a contact, see Search.

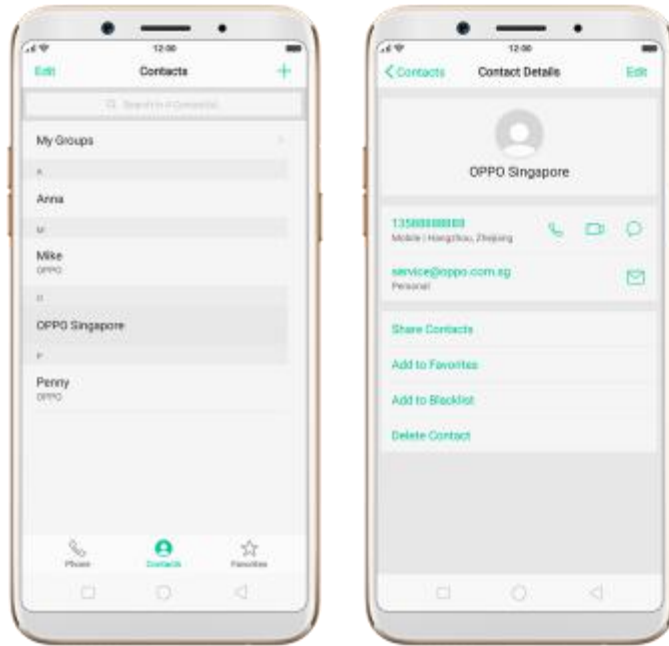

Call someone in your favorites list. Click Favorites and choose a contact. To add favorites, click .



Call someone you've recently called or who has recently called you. Click

Phone, and you'll see the recent calls. Click a number to make the call. Click  to get more info about the call, or the caller. Click "All" to see all, only missed, or only blocked calls.

+

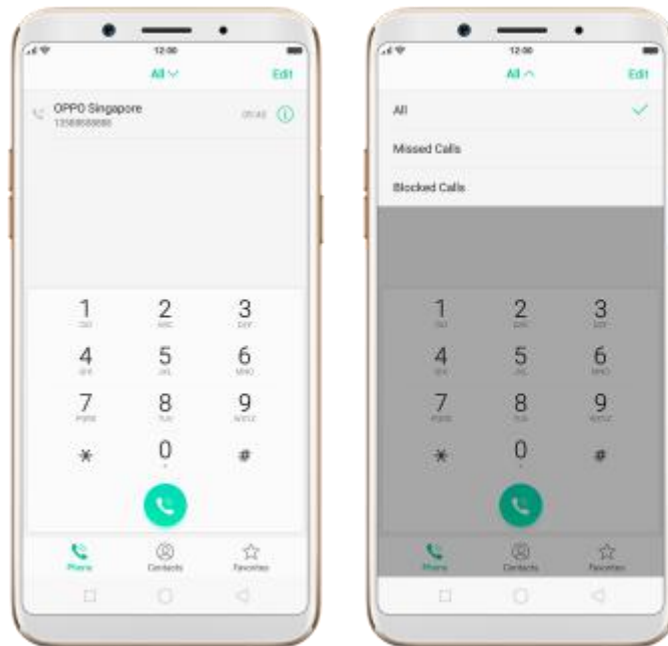

● Answer or decline a call

When someone calls you, the OPPO smartphone rings and displays the caller's information, if available.

Answer a call. Click Answer. If the phone is locked, click Slide up to answer.



- If you're listening through the headset, you can click the mic button to answer.

Silence a call. Click Mute, or press the **Sleep/Wake** button or either of the volume buttons once to stop the phone from ringing or vibrating.

Decline a call. Click Decline, or press the **Sleep/Wake** button twice quickly.

Respond with a text message instead of answering. Click "Message", then choose a reply or click Customize to reply with your own words. To create

your own default replies, go to **[Settings]** > **[Call]** > **[Respond with SMS]**.

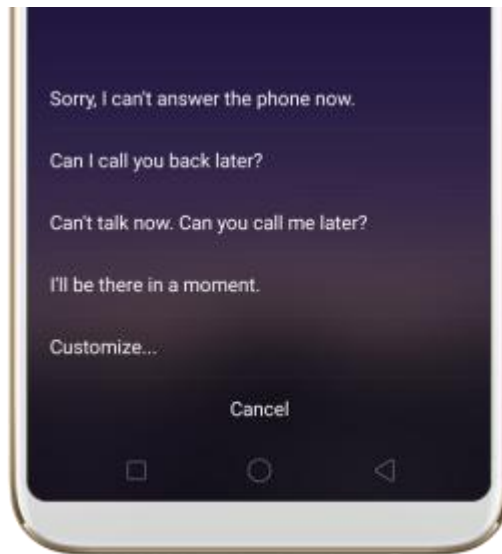

- **While you're on a call**

While on a call, call options will show up on your screen.



To

Do this

Record a call.

Click Record. The recording will be

saved in **[Phone storage]** >
[recordings].

Get contact info.

Click Contacts.

Mute the microphone.

Click Mute. The caller can't hear you when you are on mute, but you can still hear the caller. Click Mute again to cancel it.

Activate speakerphone.

Click Speaker.

Use the dialpad to enter information.

Click Dialpad.

Make a second call during a call.

Click Add call and make a second call. The first call will be put on hold. Click the phone number to switch back to the first call and put the second call on hold. Click Merge calls to merge the two calls, so all three of you can talk and hear each other. See Conference calls.

Respond to a second call, do one of the following:

- **To decline the call**, click Decline.
- **To hold the first call and answer the new call**, click Answer.



Use other features while on a call. Click the **Home** button. Click the green status bar on the top of the screen to return the call.



7.1.2. Conference calls

A conference call lets you talk to more than one person at a time. You can merge up to six calls for a phone conference.

Notice: You might need to contact your network operator to activate conferencing services first.

Make a conference call.

Do the following:

1. Make a call.
2. Tap Add Call and make another call. The first call will be put on hold.
3. Tap Merge calls. The calls are merged onto one line and everyone can hear each other.
4. Repeat second and third steps to add more calls to the conference.



7.1.3. Block calls

Block feature does help to prevent unwanted phone calls. You can also add numbers to blacklist to block specific phone numbers from calling.

Block calls. Go to **[Settings] > [Call]**, or go to **[Settings] > [Security] > [Harassment blocking]**. Click **[Block Calls]**, you'll see several options available for blocking incoming calls:

- Block one-ring incoming calls
- Block hidden incoming calls
- Block all unknown incoming calls
- Do not block repeated incoming calls
- Block all incoming calls

Note: The unknown number refers to an unsaved real phone number, and your phone is able to show its number and location; while the hidden number means the caller's number or location is not accessible, which usually is a harassing call.

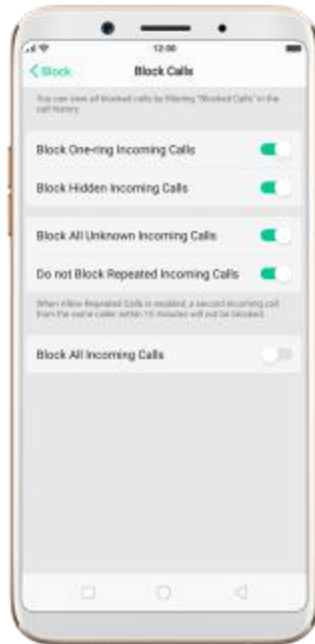

Add a contact or a phone number to the blacklist. Click Phone, then click Contacts. Choose a contact, then click Block This Contact. You can also go to **[Settings] > [Call] > [Block]**, or go to **[Settings] > [Security] > [Block]**, click **[Blacklist]**, click  , then enter the number or choose your contacts.

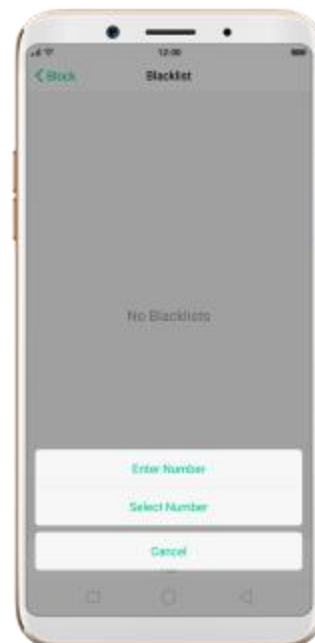

7.1.4. Emergency calls

Call for help in an emergency. You can make an emergency call even if you do not have a SIM card installed in your OPPO smartphone in some countries.

Make an emergency call. Click Phone, click keypad and dial the number, then click . Or if your phone is locked with a passcode, click Emergency Call, then dial the number.



7.1.5. Auto Recording

Auto Recording feature enables you to automatically records conversations, which makes it easy for you to review your important incoming and outgoing calls on the daily basis. You can record all calls, or those from your designated numbers or unknown numbers. You can also share your recording files, set them as ringtones, and more.

Turn on Call Recording. Go to **[Settings]** > **[Call]**, click **[Call Recording]**, then select which calls to be recorded:

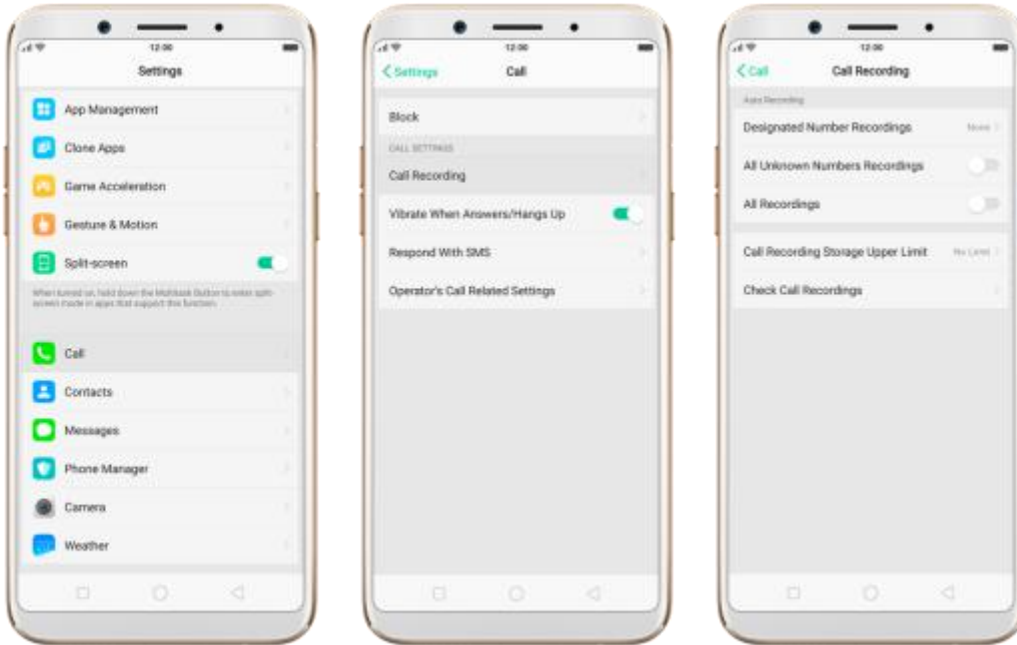

- **Record calls from designated numbers.** To add the numbers, click Designated Number Recordings, then click Add. Choose the contacts from Call Log, Groups or Contacts, then click Add.

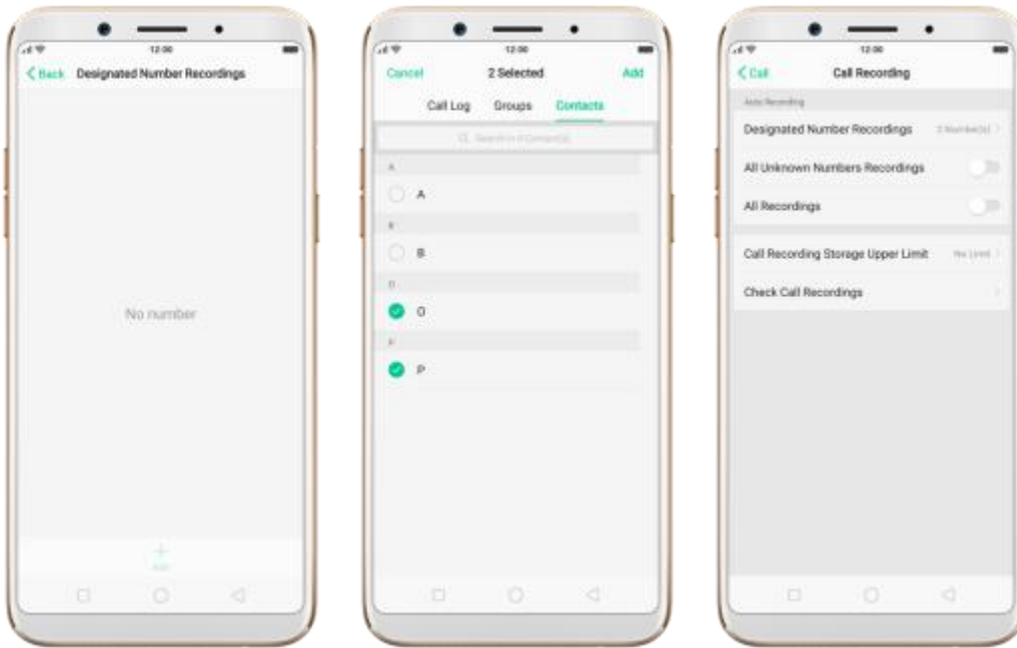

- **Record calls from all unknown numbers.** Toggle the All Unknown Numbers Recordings slider to green, then your phone will automatically record calls from numbers that are not in your Contacts.

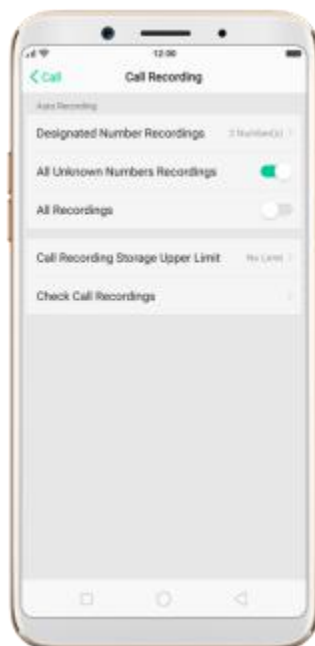

- **Record all your calls.** Toggle the All Recordings slider to green.

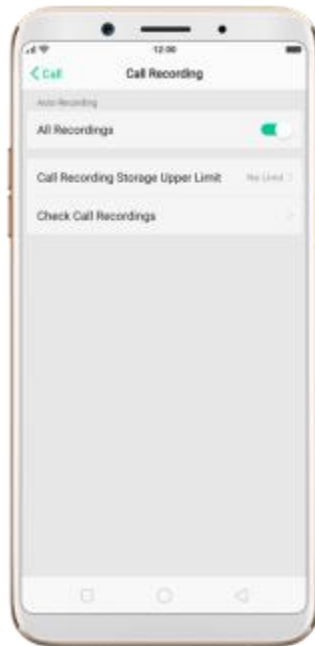

Set the storage limit for recording files. Click Call Recording Storage Upper Limit, then choose a storage capacity for the recording files. If your recordings exceed the threshold, the earliest recording will be deleted automatically.

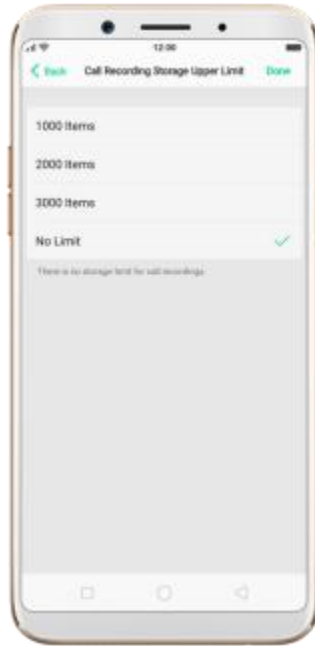

Manage your call recordings. Click Check Call Recordings, then click Call Recording.

- **Play a recording back.** Click the recording to play it back.
- **Send, rename or delete a recording.** Click Select, choose the recording, then choose an option.
- **Set a recording as ringtones.** Click Select, choose the recording, click Set as, then set the recording as the call, SMS, alarm or contact ringtone.

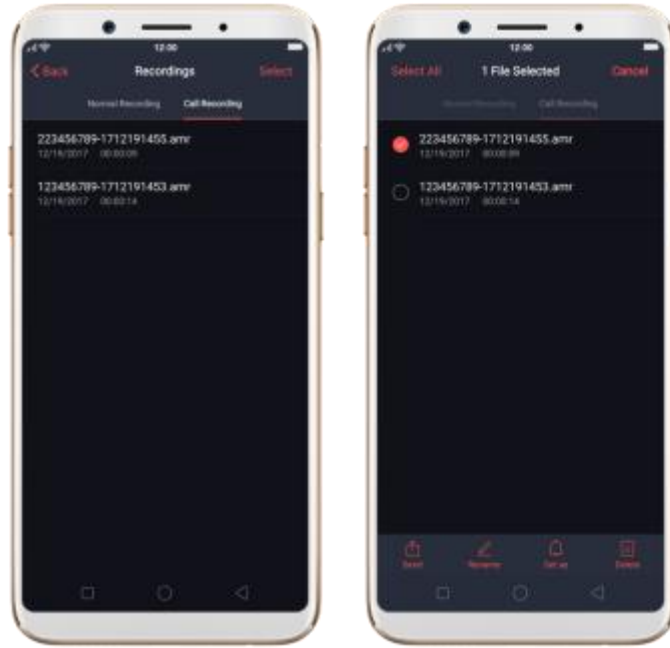

Note: Call Recording feature is not available in the United States and Australia.

7.1.6. Operator's Call Related Settings

The OPPO smartphone includes several calling features such as Call Forwarding, Call Waiting, Voicemail and more.

Set up calling features. Go to **[Settings]** > **[Call]** > **[Operator's Call Related Settings]**.

- **Voicemail:** When you're away or can't get to the phone, your Voicemail does the answering for you. Callers can leave recorded audio messages to you, and you can view, listen to, and manage the messages.

- **Fixed Dialing Numbers:** Add numbers to the FDN list, and when activated, FDN restricts outgoing calls to only those numbers listed, or to numbers with certain prefixes.
- **Call Forwarding:** An incoming call will be redirected to another telephone number where the desired called party is able to answer.
Notice that  appears in the status bar.
- **Call Restriction:** Certain types of outgoing calls (such as international calls) and/or incoming calls will be restricted.
- **Call Waiting:** You'll hear short beeps if someone calls you while you're on the call.

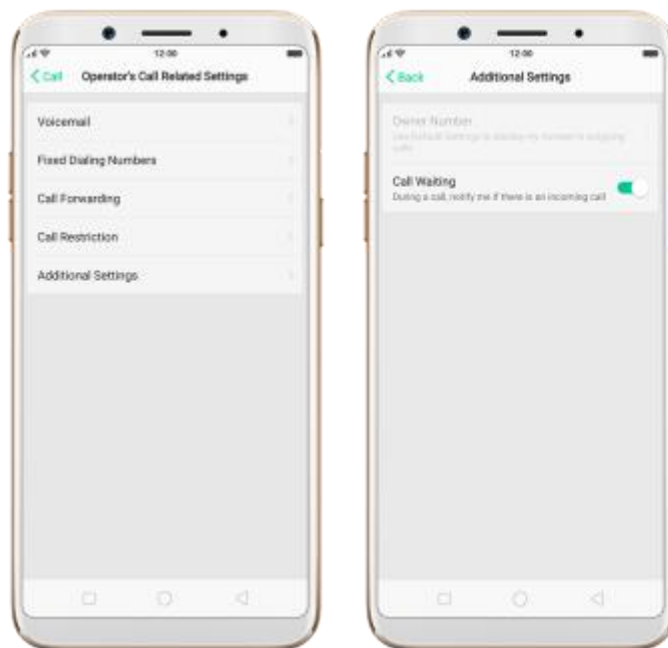

7.2. Messages

7.2.1. Send and receive messages

You can send and receive text messages anytime you're in range of the cell network. Depending on your phone plan, you may be charged for messages you send or receive.

Send a new message. Click **+**, then enter a phone number or name, or click **👤** and choose a contact from your contacts list. Type a message and tap **Send**.

Tip: As you type, click **+** next to the text field to add an attachment.

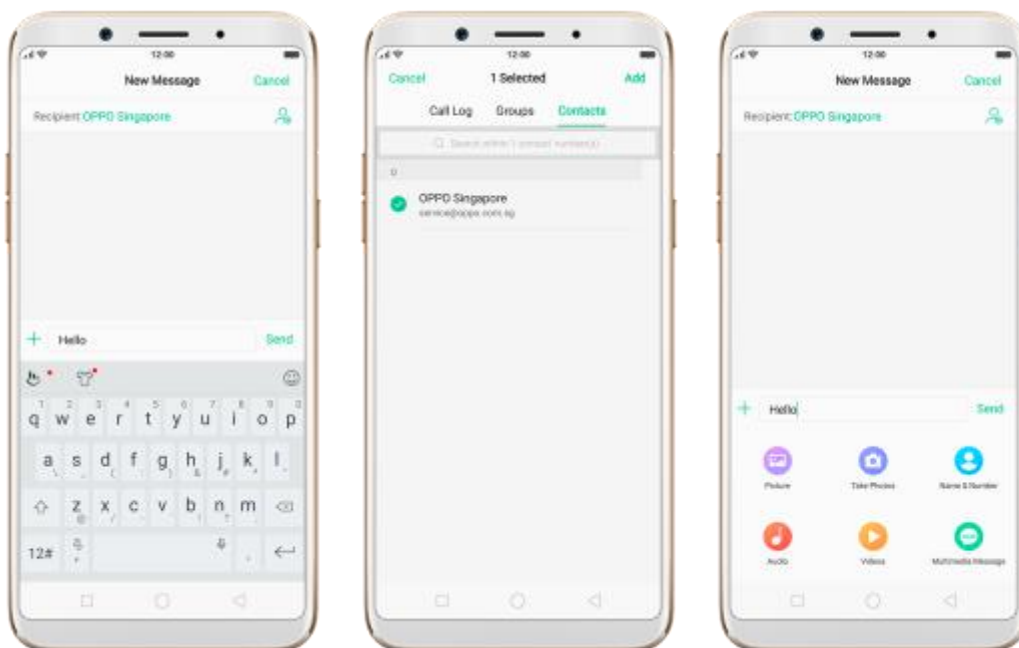

Send a message to multiple people. Click **+**, then enter multiple recipients, or click **👤** and tick all contacts you wish to include in the group message,

then click **Add**.

Read and reply to a new message. Click the notification on the top of your screen, or click . When phone screen is locked, swipe the notification right.

Type your message and tap **Send**.



Tip: The Messages icon on the Home screen shows the total number of unread text messages you have.

Delete conversations from the Messages list. Click **Edit**, tick the conversations and click **Delete**. You can also delete a conversation by swiping left over a conversation and clicking **Delete**.

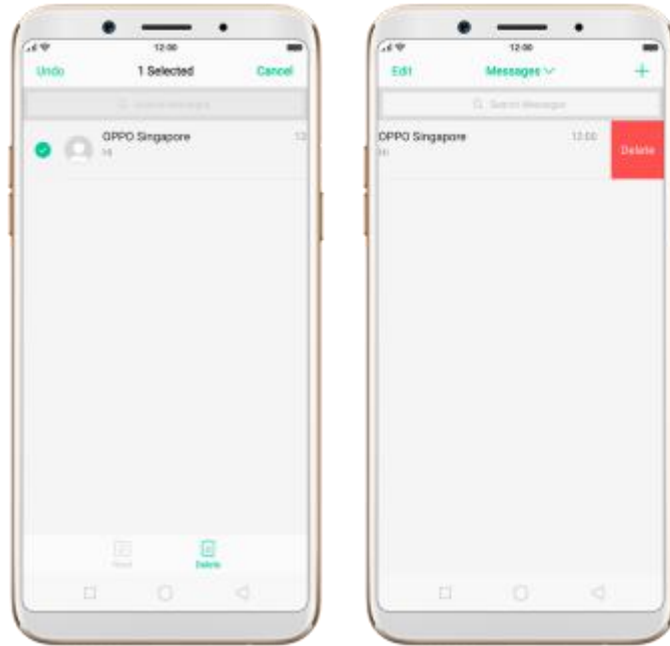

7.2.2. Customize message settings

The Messages settings menu lets you control options for your text and MMS messages including message limits, displays, notifications, and more. Go to **[Settings] > [Messages]**.

Block messages. Click **[Block] > [Block Messages]**. Enter the keywords for spam messages. To block all unknown messages, toggle the slider to green.

Note: When **Block all unknown messages** is turned on, you might miss important verification text messages, as well as messages from people who you know, but are not in your contact list.



Receive instant SMS messages. Toggle the slider to green if you want to receive life related messages pushed by your operator during a call.

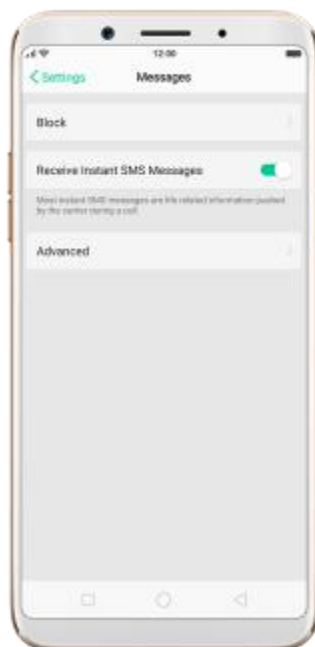

Customize advanced settings. Click **[Advanced]**, then set up message

display and notifications, and the MMS and system related settings.

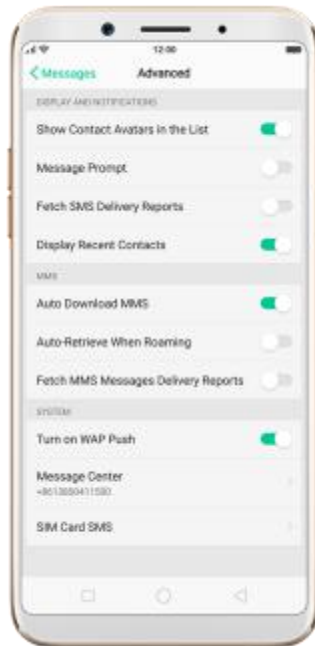

7.3. Contacts

7.3.1. Add a contact

With OPPO smartphone Contacts, it's easy to have all your contact information with you.

Add a new contact. Click Contacts, click , then enter the contact information.

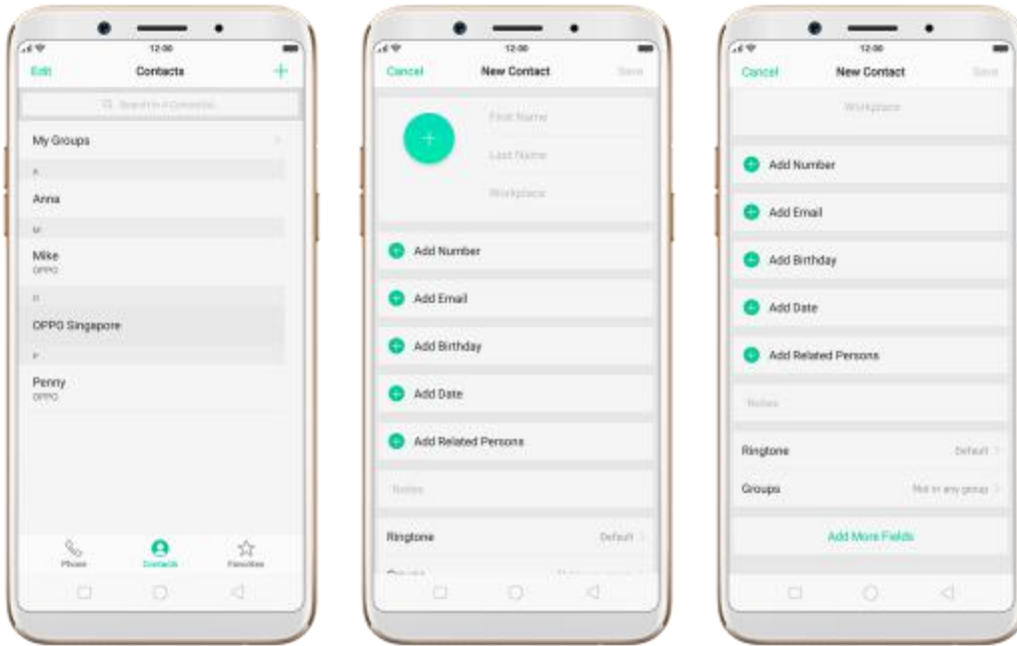

Add a contact from a number entered using the keypad. Click Phone and enter a number, then click **Create New Contact** and enter the contact information, or click **Add to Contacts** and choose a contact.

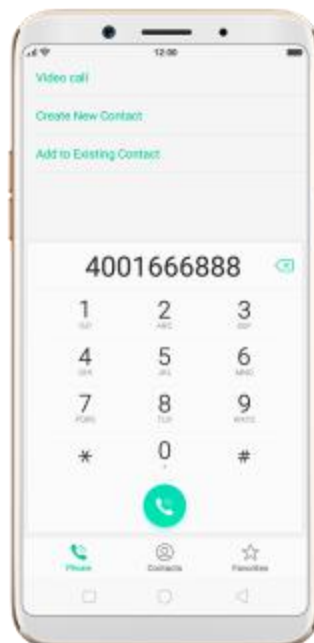

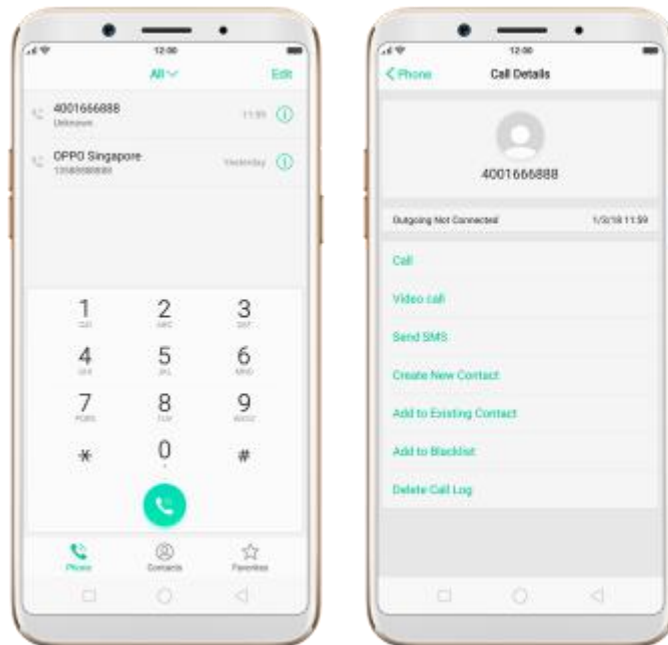

Add a recent caller's information to your contacts. Click Phone, and you'll see the recent calls. Click , then click **Create New Contact** or **Add to Contacts**.



7.3.2. Edit and delete a contact

You can make changes to your contacts directly on your OPPO smartphone.

Edit a contact's phone number, address, and other information. Click Contacts and choose a contact, then tap **Edit**.

- To add an item - such as an Email address or phone number, click  next to the item.
- To delete an item, click  next to it.

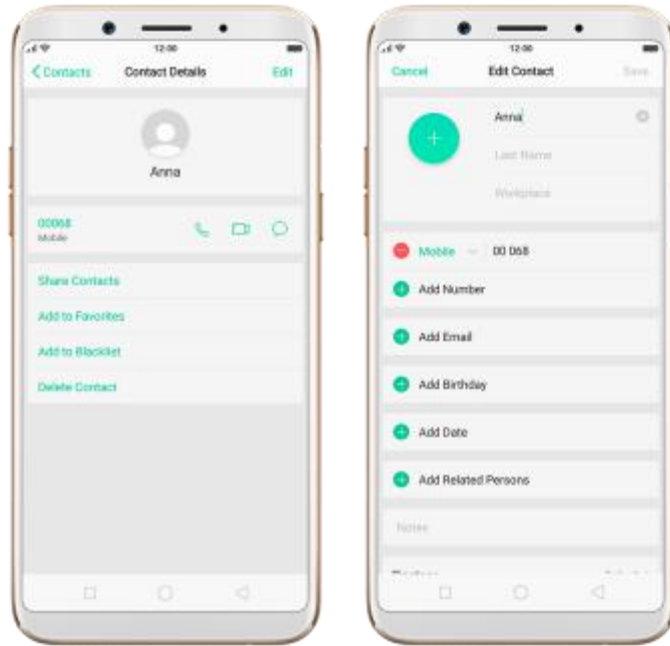

Assign a photo to a contact or change a contact's photo.

1. Click , or click the existing photo.
2. Click **Take Photo** to use the camera to take a picture, or click **Select a Photo** and select an existing photo, or click **Delete Avatar** to delete the photo.
3. Drag to region to crop the photo, then click Done.

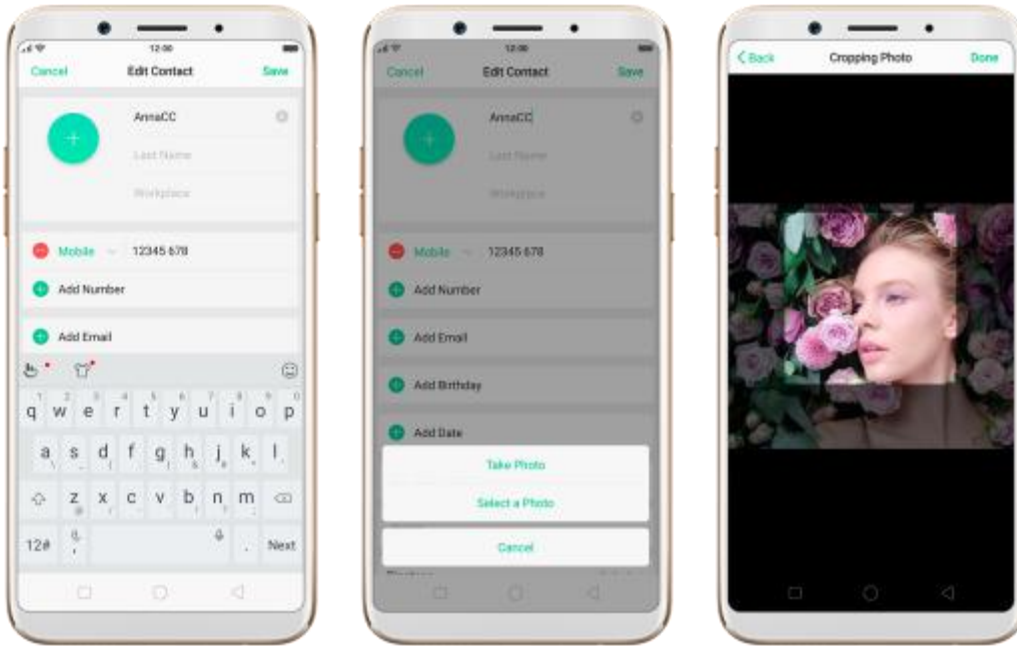

Delete a contact. Click **Delete Contact** in contact Details page or Scroll to the bottom of the contact information and click **Delete Contact**.

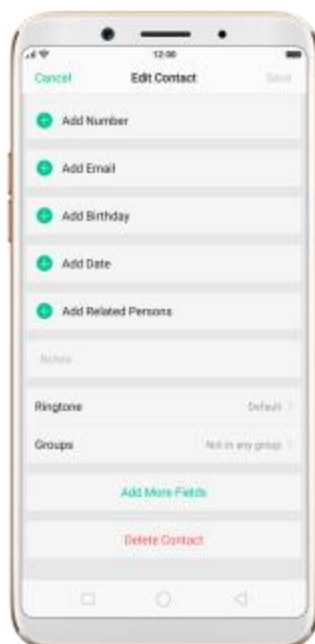

7.3.3. Import and export contacts

You can import/export contacts from/to the phone storage or your SIM card. If you have contacts stored in your old phone, you can transfer them through Bluetooth from that phone. If there are repeat contacts it will automatically merge them when you import contacts.

Import contacts. Go to **[Settings] > [Contacts] > [Import/Export Contacts]**.

- **Import from device storage.** Save the imported contacts to your phone or mail accounts.
- **Import from other phones.** Import the contacts stored on other phones to your OPPO phone through Bluetooth.

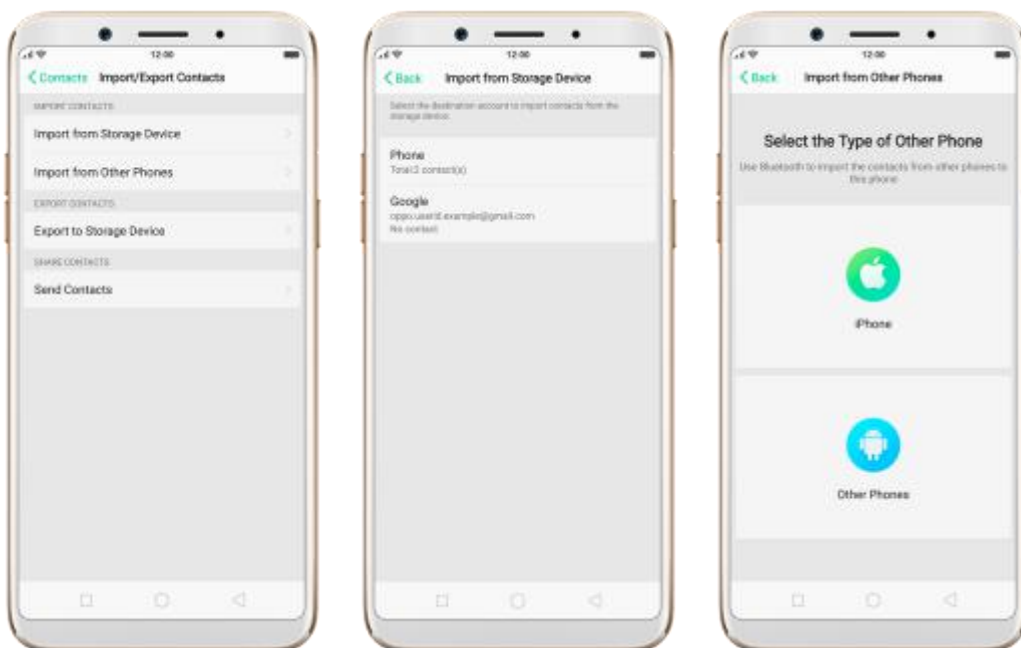

Export Contacts. Export your contacts to the phone storage. Contacts you

export are saved as .vcf file.



Import/export SIM card contacts. Go to **[Settings] > [Contacts] > [SIM Card Contacts]**, click **Import** or **Export**, then tick the contacts and move them to either SIM or phone.

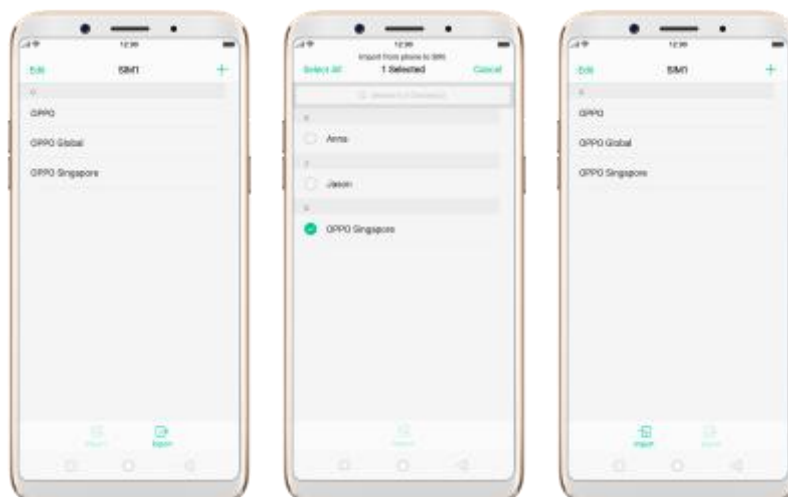



View more details in Import and export contacts on your OPPO smartphone.

7.3.4. SIM contacts

You can add, edit, delete, import and export SIM contacts directly on your OPPO smartphone. Go to **[Settings] > [Contacts] > [SIM card Contacts]**.

Add a SIM contact. Click **+**, then enter the contact information and click **Save**.



Edit and delete a SIM contact. Click a contact, then click **Edit**. To delete the contact, scroll to the bottom of the contact information and click **Delete Contact**.

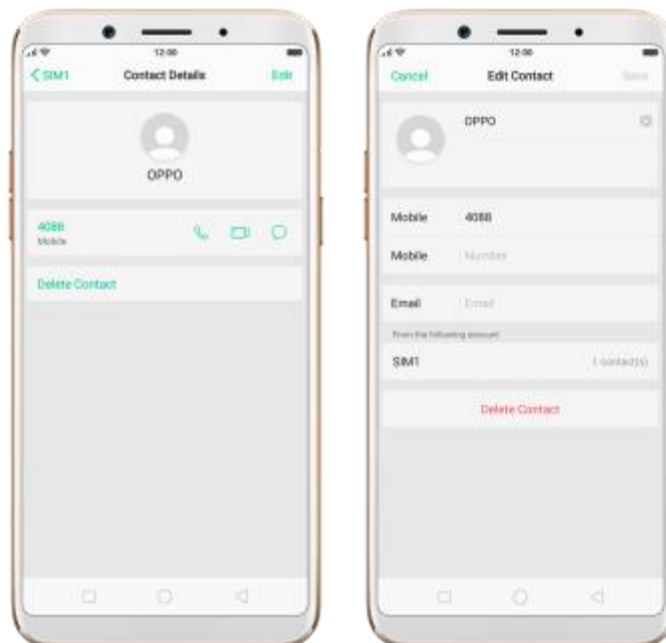

Delete SIM contacts at a time. Click **Edit** in the upper-left corner, tick the contacts and click **Delete**.

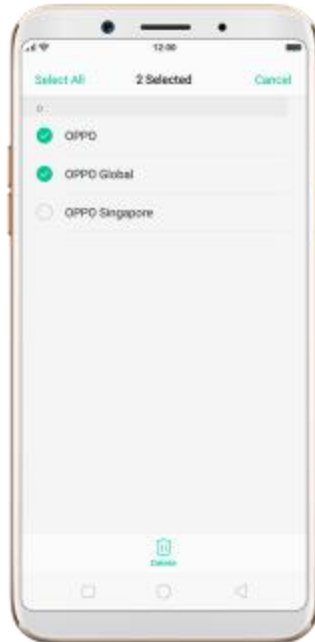

Display SIM contacts in the Contacts list. You need to import SIM contacts to your phone. See Import and export contacts.

7.3.5. Manage contacts

Contacts allows you to easily save and edit contact information, including names, numbers, addresses, and more. To make your contacts more organized and available, do the following:

Add a new contact. Click Phone on the Home screen, click Contacts, then click **+**. The contact will be saved to your phone storage.

Modify existing contacts. If you want to add details to an existing account,

click the account then edit.

Import or export contacts. Go to [**Settings**] > [**Contacts**], then select the import/export path. View Import and export contacts on your OPPO smartphone.

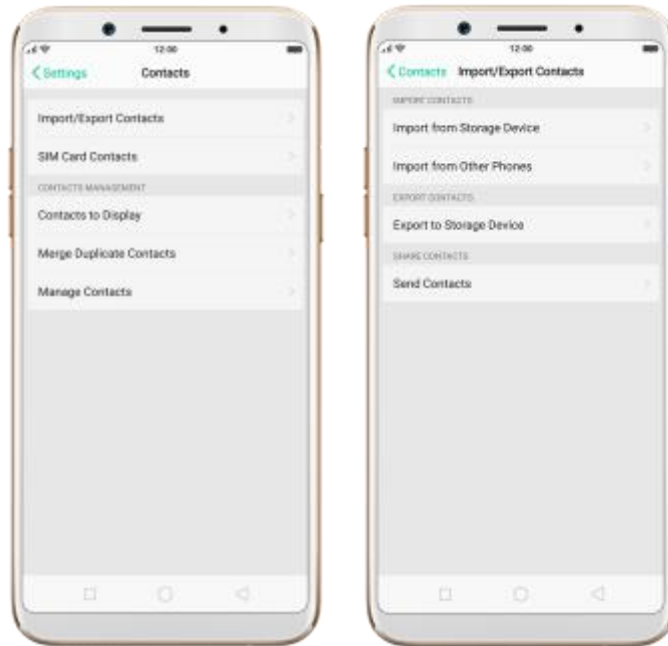

Contacts to Display. Go to [**Settings**] > [**Contacts**] then click **Contacts to Display**. You can choose Only show Contacts with Numbers, All Contacts, Phone, Google or others. Also you can customize the contacts in your phone to show.

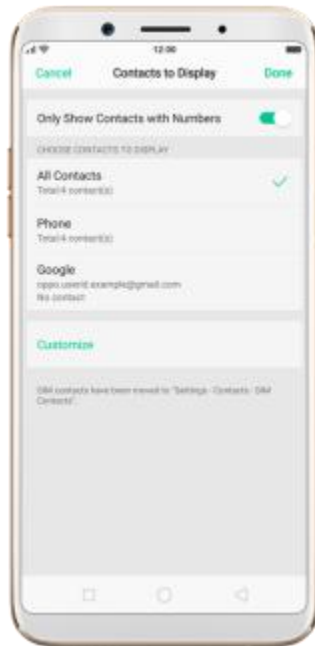

Merge duplicate contacts. Click **Merge duplicate contacts**. The phone will automatically merge contacts with the same name.

Manage contacts. To manage contacts without name or number, or quickly remove invalid numbers, click **[Manage Contacts]**.



Send Contacts. Go to [Settings] > [Contacts] > [Import/Export Contacts].

All contacts stored on your phone will be shared.

Backup your contacts. Click [Backup and Restore] > [Create New Backup].

View Back up your OPPO smartphone.

7.3.6. Back up your contacts

If you use your OPPO smartphone on a regular basis, it is necessary to back up the contacts so that you can easily restore them or use them on another device.

Use OPPO Cloud. OPPO Cloud allows you to back up the Contacts and SMS to the cloud drive. You need to register or sign in OPPO account first.



Use the built-in backup tool. Go to **[Settings]** > **[Additional Settings]** > **[Back up and reset]**, or click **[Tools]** folder on the Home screen, then click **[Backup and Restore]**. Back up your contacts. You need to make a copy of the existing backup file and move it to another storage device.

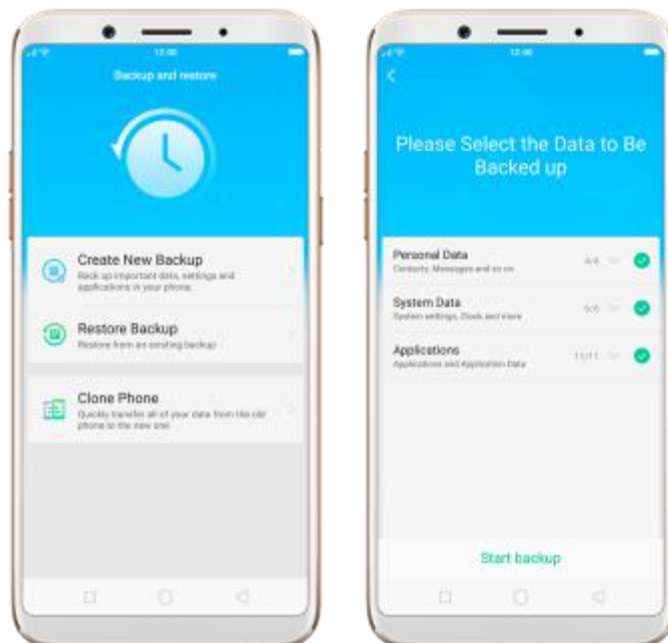

Export contacts. Export your contacts to your SIM card or a folder on your phone. See Import and export contacts.

7.4. Phone Manager

7.4.1. Scan and optimize the phone

Regularly optimizing your OPPO smartphone can make it perform steadily and faster.

Automatic optimization items. Go to **[Phone Manager]**, the system will start scanning your phone automatically. After the scan is over, click **[Go to optimize]**, then click **[One Touch Optimization]**. You can also select the items that you want to optimize optionally.



Manual optimization items. Click the green button on the right side of each item, respectively, then encrypt apps or back up your phone when prompted.

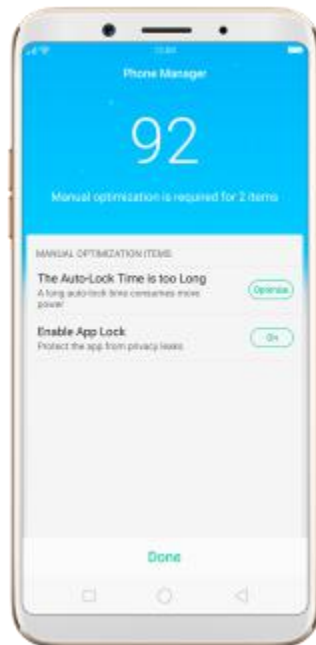

7.4.2. Cleanup & Accelerate

You can use Cleanup & Accelerate to speed up your phone performance with just one click. It helps you to quickly detect and remove hidden temp, cookie and cache files generated by inner calculations and data exchanges to free up more storage space.

Stop lagging with one click. Click Phone Manager, then click Cleanup & Accelerate. Your phone will thoroughly scan for junk files and APKs, and lets you choose files to be deleted.

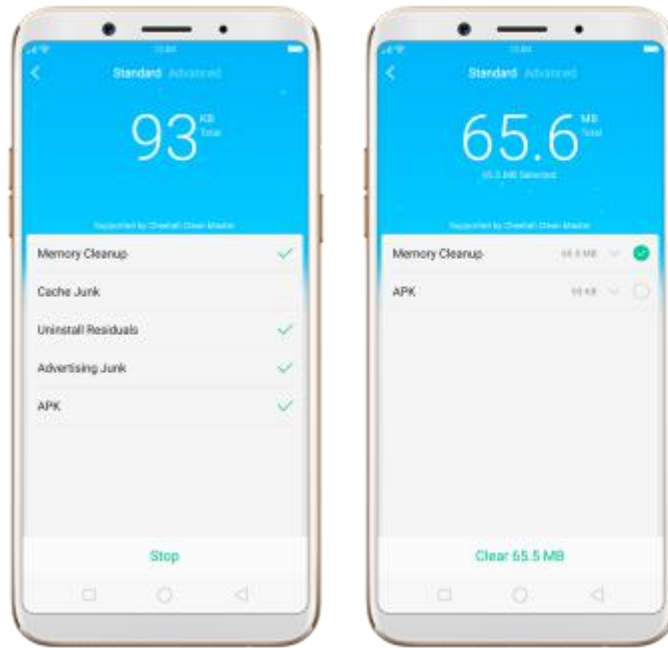

Free up more storage space. Click Advanced, then remove your App data and downloads, or click File Management and go to manage all your data.

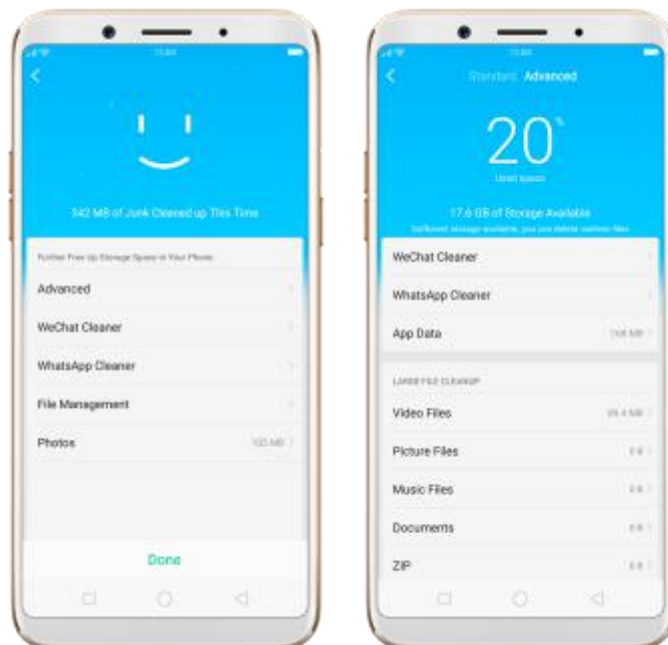

7.4.3. Privacy Permissions

Use Privacy permissions feature to manage app permissions, protect your privacy, and manage apps that start when phone startup. Click Phone Manager, then click Privacy Permissions.

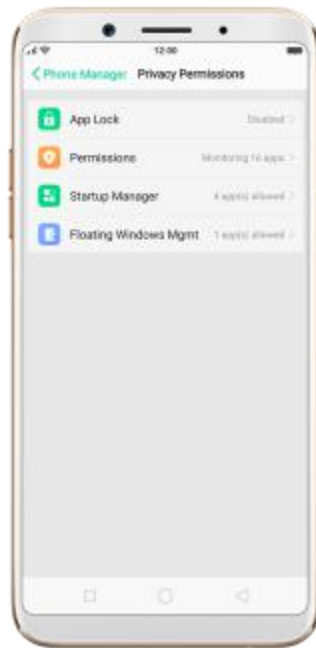

Encrypt the apps. Select the apps and click **Enable encryption**, then set up your passcode and security question.

Grant the app permissions. Select an app and choose to accept, decline or limit call, SMS, device and privacy related permissions.

Allow apps to start when phone boots or in background. Toggle the sliders to green. See Set up Startup Manager.

Enable floating windows. Toggle the app slider to green. Your app message

will be displayed in the floating window for easy viewing and use. (Only for apps which can support Floating window feature.)

View more details in Use Phone Manager on your OPPO smartphone.

7.4.4. Virus Scan

For better security, you can regularly scan and remove potential and actual threats to your phone.

Scan for virus. Click Phone Manager, then click Virus Scan. Wait for the scan to complete.

If threats were found, remove them; if not, you will see a message that says your phone is in a good state.



7.4.5. Payment protection

While you shop online, your OPPO phone will provide protection for the

mobile transactions, such as detecting captcha and app security.

Set up payment protection for apps. Go to **[Settings] > [Security] > [Payment Protection]**.

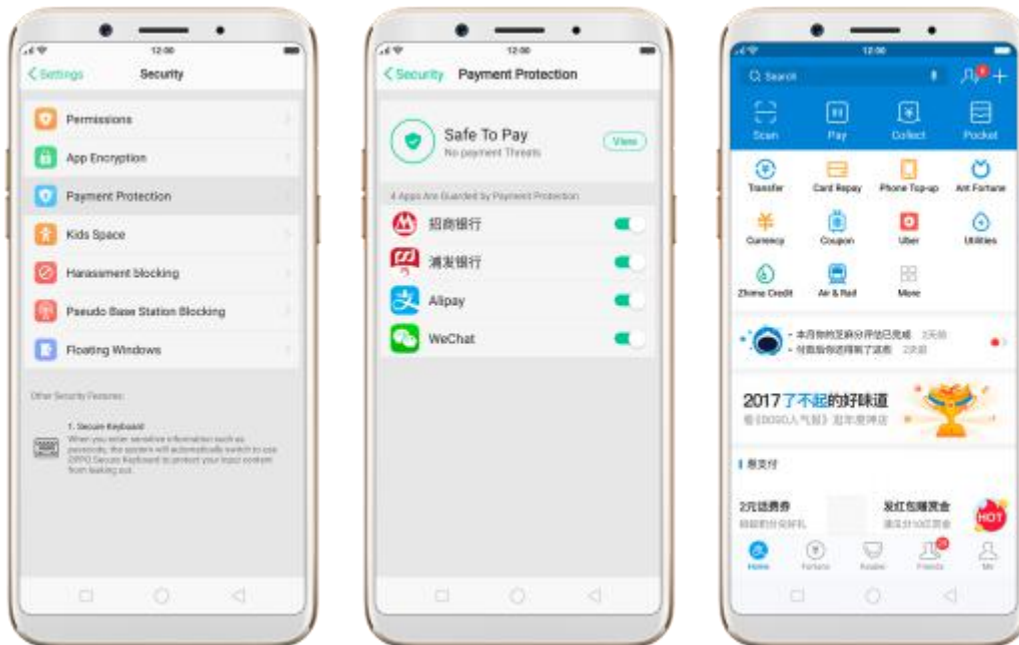

7.4.6. Frequently Used Functions

In Phone Manager, you can quickly clear your downloads and junk files of the apps which are used frequently, such as WhatsApp, WeChat, and more.

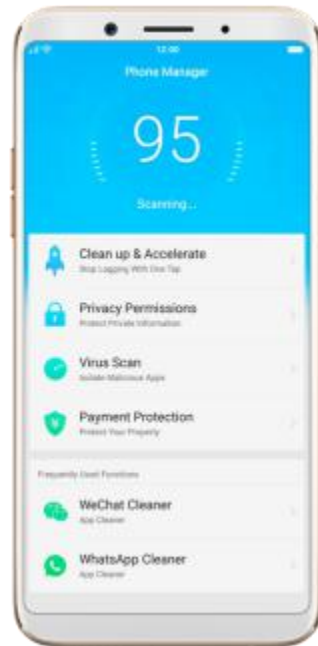

WhatsApp Cleaner

Clear junk files. Click Clear button to clear the cache files generated when the app was in use.

Clear other app files. You can delete the app files to free up the phone storage, including pictures, videos, audio, voice message and files. Select an option, click Select to select the files, then click Delete.



WeChat Cleaner

Clear Temporary cache. Take WeChat Cleaner as example, click WeChat Cleaner and wait a few minutes for your phone to scan the cached data, click Clear button on the right to clear the app's cached data. And when the next time you use the app, it will download everything it needs from the internet again.

Clear Old files. Click to clear pictures, videos and downloaded files generated from chats three months ago.

Clear other app files. You can delete the app files to free up the phone storage, including chat images and videos, downloaded files and saved images. Select an option, click Select to select the files, then click Delete.

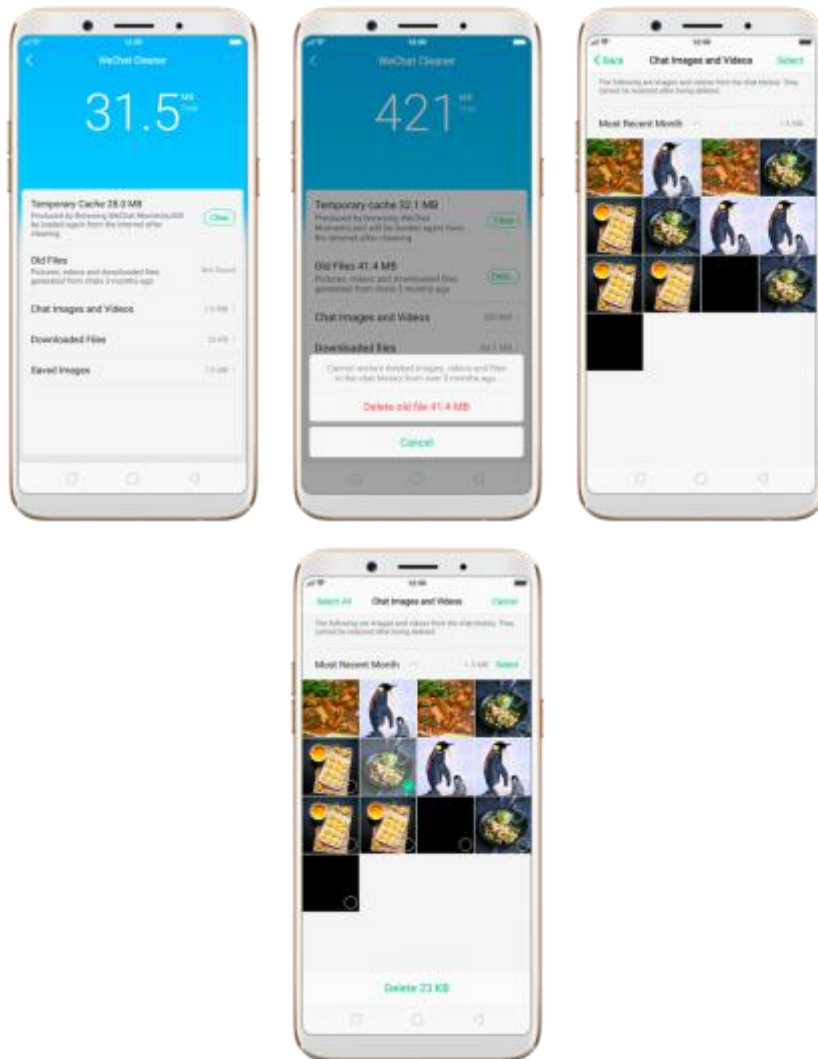



7.5. Weather

Click Weather from the Home screen to see the current temperature and the upcoming week's forecast for a city of your choice. You can store multiple cities for quick access.





Look at your local weather. Open Weather, and your phone will attempt to find your current location using the Location Services. Scroll down to see more details, including surface temperature, humidity, visibility, and more.

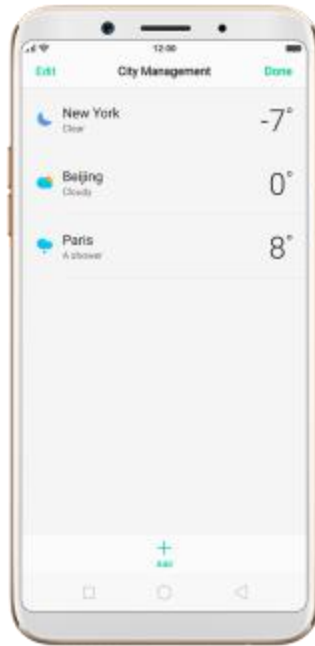

Add a city. Click , then click . Enter a city name, then click the city when you see it.

Switch to another city. Swipe left or right. The number of dots below the city name shows how many cities are stored. You can also click , then choose a city from the list.

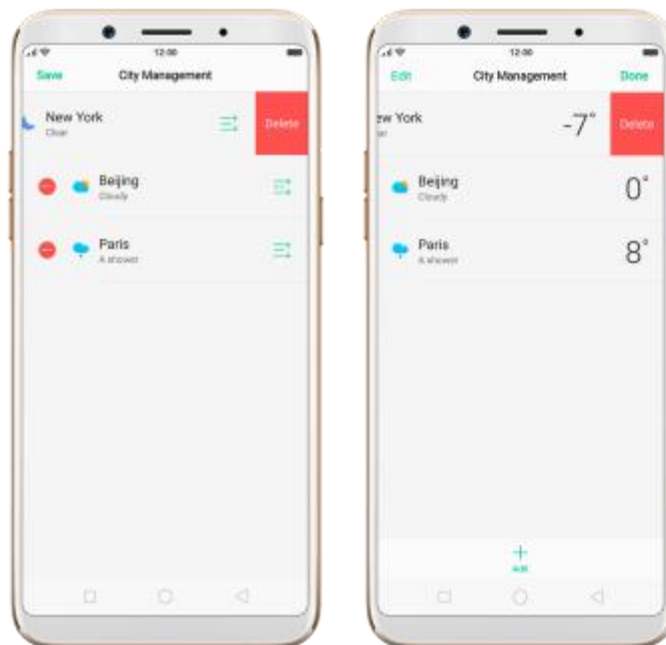

Delete a city. Click , swipe left on the city, then click Delete, or click Edit, click  next to a city, then click Delete.



Reorder cities. Click , click Edit, then drag  next to a city up or down

in the list.

Turn on Disaster warning. Go to **[Settings]** > **[Weather]** and toggle the slider to green.

Choose Fahrenheit or Celsius. Go to **[Settings]** > **[Weather]** > **[Temperature unit]**.



7.6. Cameras

7.6.1. Take photos

You can use the cameras to take pictures and videos.



Open camera. Click Camera icon. To quickly get to the camera, touch Camera icon on the Lock screen and swipe up.

Choose a photo mode. Click  , then choose to shoot standard, square-format, or full screen photos.





Switch the cameras. Click .

Take a photo. Aim your camera at the subject and click .

Zoom in or out. The dual 20MP cameras capture full-resolution video and stills at 1x and 2x zoom. To quickly switch, toggle  or . You can also pinch the screen to zoom in and out.



Turn the flash on or off. Click , then click On or Off. When you click Auto, your phone will automatically detect lighting conditions and determine if flash is necessary. When you click Fill Light, your phone will use the built-in flash as the fill light.

Turn HDR on or off. Click , then click On, Off or Auto. When HDR (high dynamic range) is on, photos take multiple exposures of the same scene and then combine them to create a better looking, more detailed image.

Use the capture timer. Capture timer gives you time to get in the picture. Click , then click 3s or 10s. Click Tap if you want to take photos by tapping on the screen.

Add a filter. You can apply a filter before you take a photo. Click , and you'll see eight filter options, with each one showing a preview of what it will look like applied to your photo. Click the filter you want to use. Click None or

 to remove the filter.



Take a panorama photo. Choose PANO.

- With the rear cameras, click the Shutter button, then move the phone slowly and steadily across the subject you want to capture. Click the button again when you've got your full photo.

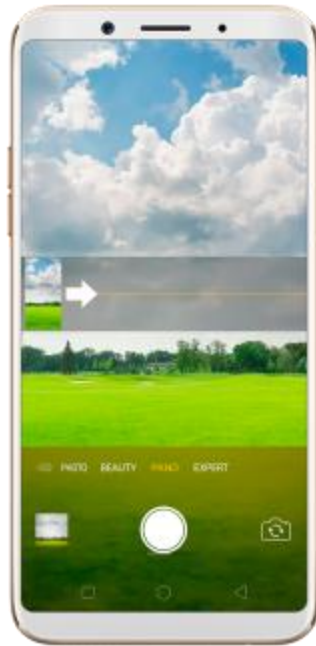

- With the front camera, click the Shutter button and you'll hear a "Ding" sound. Rotate the phone left or right until the phone sounds again. The photo will be taken automatically.



Use Expert mode. Expert Mode allows you to take more professional-looking photos. Choose EXPERT, then you can adjust camera's white balance, exposure compensation, ISO, shutter speed, and more.



Take Burst shots. Touch and hold the Shutter button, and you'll see an onscreen count rapidly rise, which shows the number of photos you're taking. Lift your finger to stop. To select the photos you want to keep, click Gallery, click , select the photos, then click Done.



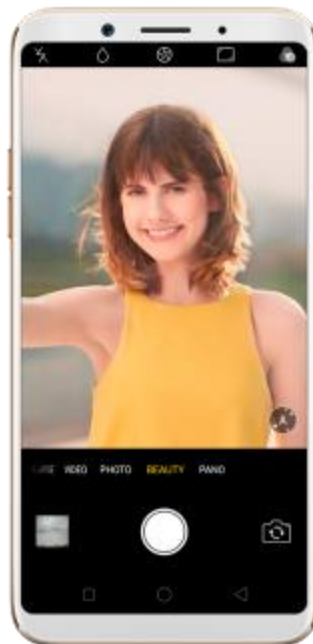

7.6.2. Take a selfie

To switch to the front-facing camera, click  in the lower-right corner of the screen.

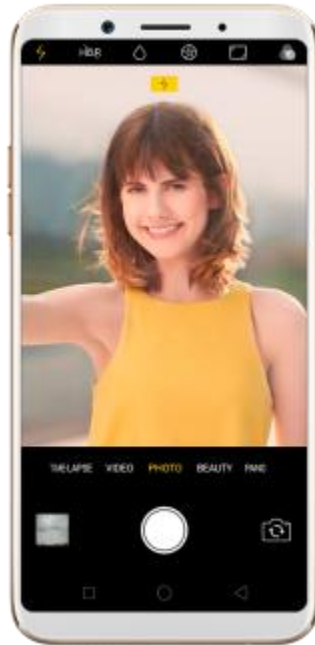

Turn the flash on. Click ✨, then click On. A white screen at full brightness is used as front-facing flash.



Choose a photo mode. Click , then choose to shoot standard, square-format, or full screen photos.





Add a photo watermark or filter. You can apply a watermark or filter before you take a photo. Click , then choose a watermark or filter, or click **Revert** to remove that.



Use Beauty Mode. The built-in beauty filter will automatically adjust the skin tone, enhance facial features, and make other minor changes to your appearance. To change the beauty level, click .



Turn Depth Effect on for a photo. Click  on the top of the screen. Depth Effect blurs the background while keeps the face in the foreground perfectly focused.

Use the capture timer. Capture timer gives you time to get in the picture. Click , then click 3s or 10s. Click Tap if you want to take photos by tapping on the screen.

Show palm to take photo. Click , then click Palm. Show your palm to the front camera. After recognizing your palm, the phone will take a photo after two seconds.



Take a panorama photo. Choose PANO. Click the Shutter button and you'll hear a "Ding" sound. Rotate the phone left or right until the phone sounds again. The photo will be taken automatically.



7.6.3. Shoot video

With Camera you can shoot video, including time-lapse and 10s short videos.

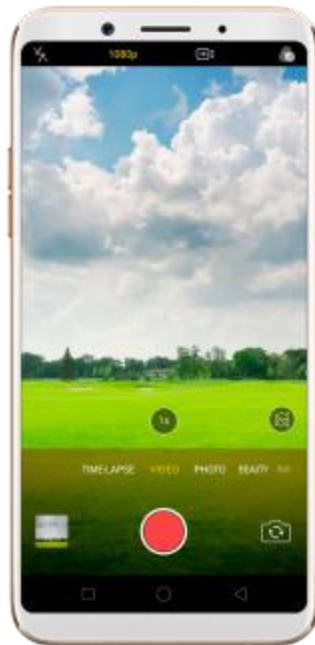

Record a video. Choose Video, then click the Record button, or press either volume button, to start and stop recording. You can choose between 720p, 1080P and 4k video.

Note: 4k video is only available on R11, R9s Plus, A57 and F3 Plus.

Capture time-lapse video. Choose Time-Lapse. It records a scene or object that has a slow state-of-change and turns it into a video that plays back in high speed.

Capture 10s short video. Click  on the top of the screen. You can capture a video up to 10 seconds.

Take photos when shooting a video. Click the Shutter button in the lower-left corner of the screen.



7.6.4. Camera settings

Camera settings are special options that help you to take pictures or record videos easier. Go to **[Settings]** > **[Camera]**.

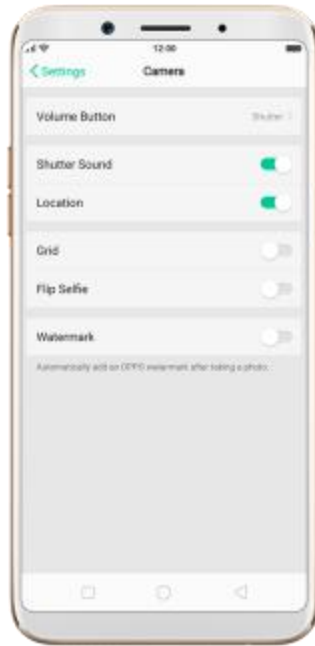

Volume button. Set the Volume buttons to function as the volume or zoom controls, or the shutter release.

Shutter sound. Make or mute camera shutter sound when capturing photos.

Location. Tag your photos with geo-locations.

Grid. Display grid lines to ensure the camera is leveled.

Flip selfie. Mirror flips your front facing camera photos.

7.7. Photos

7.7.1. Photos overview

The Photos app is where you store your photos and videos, including those you've taken with the built-in camera, saved from an app or a webpage,

copied from optional storage devices, and more. You can view, share, and edit your photos and videos directly on your phone.

View Photos. You can view the roll of photos in either Camera or Photos. All photos are sorted by the dates and times they were taken. In Photos, newly added Timeline year & month view help to position photo faster and more precise. Select YEAR & MONTH view in timeline, easy and convenient operation allows you to fast lock the look-up scope, and no need to slide up and down to look up in DAY view. Also you can click an album to view the photos or videos in that album.

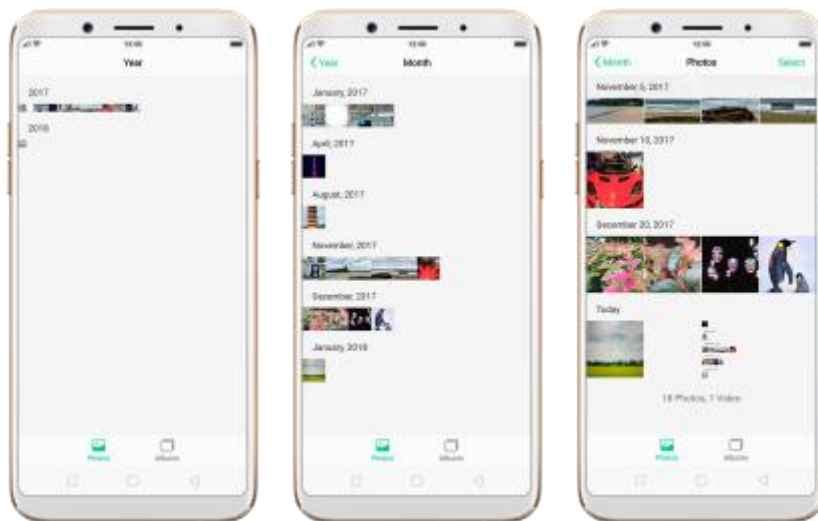

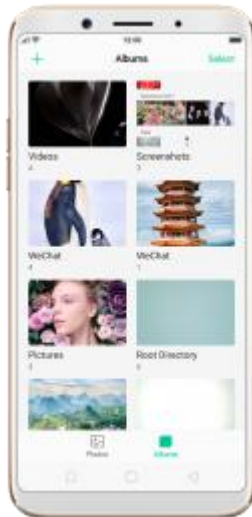

7.7.2. Albums

Each time you take a new photo, by default, it gets stored in the Photos album. Within the Photos app, there are a number of default albums into which your photos get automatically organized. In addition to these, you can also create your own albums into which you can organize photos further.

You can see your photo albums by clicking **Albums** at the bottom right of the Photos app.

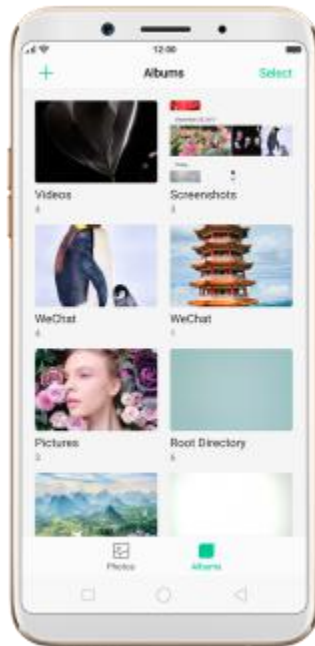

Create a new album. Click **+**, enter a name, then click **Save**. Select photos and videos, then click **Done**.

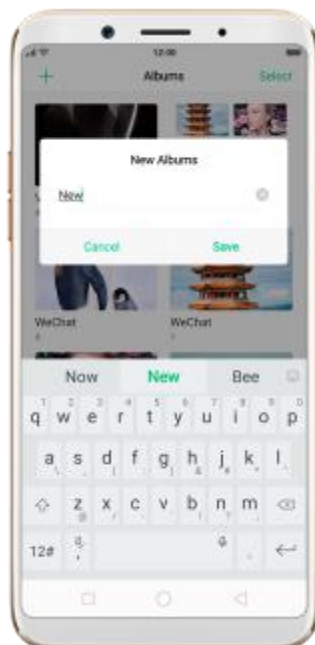

Add items to an existing album. While viewing photos, click **Select**, select items, click **Add to**, then select the album.

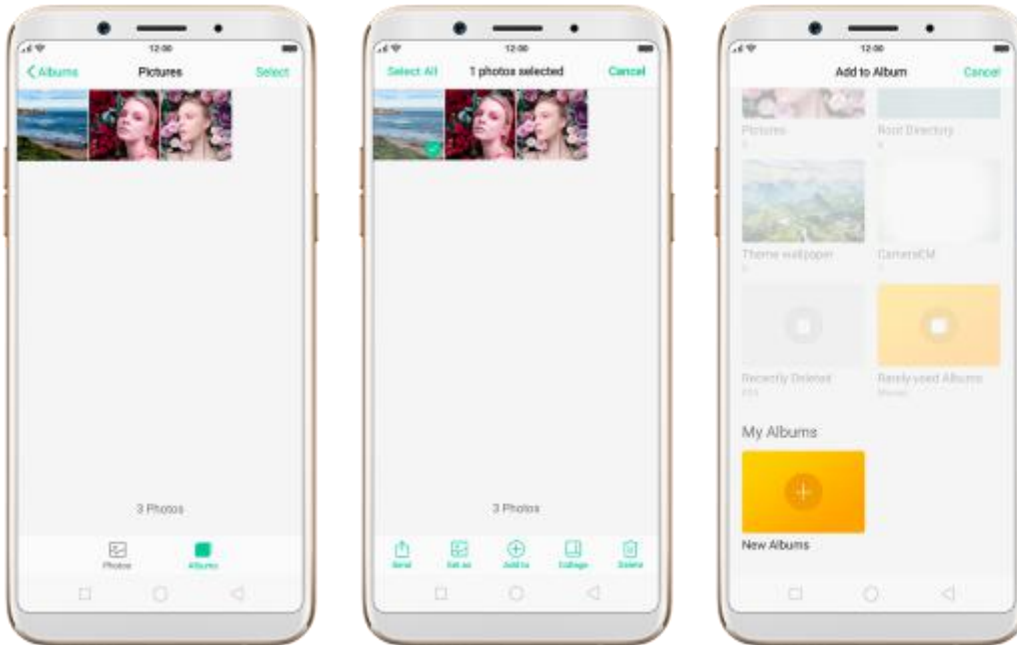

Remove items from an album. From the album screen, click **Select**, select items, click **Delete**, then click **Delete photo**.

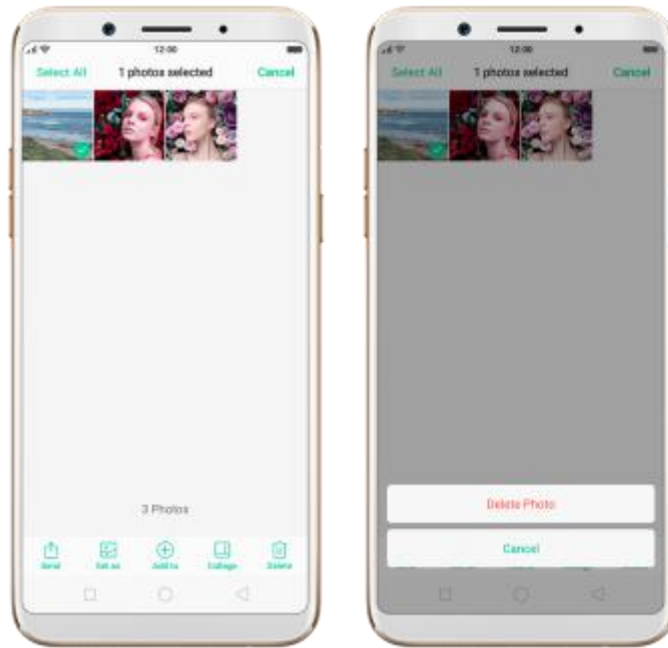

Delete an album. From the Albums screen, click **Select**, click the album, then click **Delete Album**. Default photo albums cannot be deleted.

Delete a photo or video from Photos. Click a photo or video, then click **Delete Photo**, or click **Select**, select the photos or videos to be deleted, then click **Delete**. Deleted photos and videos are kept in the Recently Deleted album for 30 days before they're permanently removed.

Restore a deleted photo or video. In the Recently Deleted album, click the photo or video, click **Restore**, then click **Restore Photo** or **Restore Video** to move the item to the Photos. Or from the Recently Deleted album, click **Select**, select the photos and videos you want to restore, then click **Restore**.

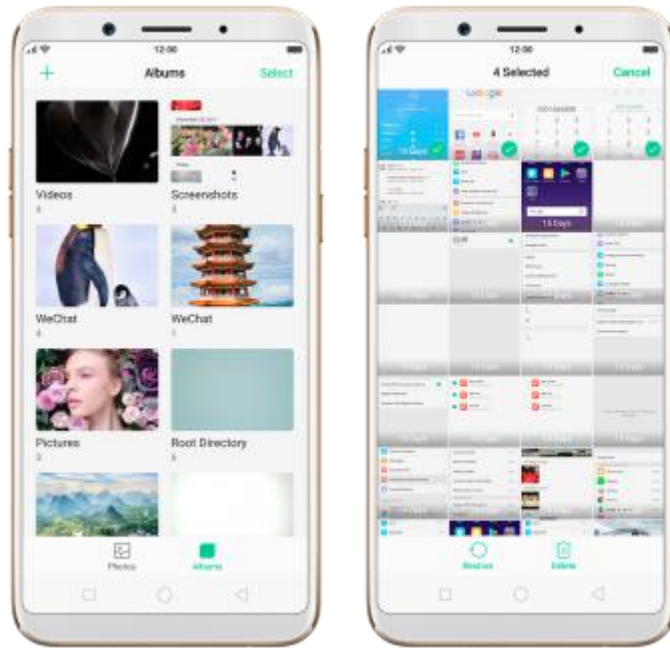

7.7.3. View and use photos and videos

View your photos and videos. Click Photos, then click a photo or video. Click  to play a video. Or click Camera, then click the thumbnail in the lower-left corner of the screen.

View a photo at full screen. Click a photo, then click the screen to hide the controls.

View the next or previous photo. Flick left or right.

View a photo in landscape orientation. On Control center, turn [**Portrait Orientation Lock**] off, then rotate your phone sideways. The photo automatically reorients and, if it's in landscape format, expands to fit the screen.

Zoom in or out. Double-click or pinch a photo open or closed. Drag to see

other parts of the photo.

See photo and video details. Click a photo or video, and then click .



Send a photo or video. Click **Send**, then choose where to send your photo or video.



Use a photo as wallpaper. Click a photo, click **Set as**, then click **Set as wallpaper**. Drag the photo to pan, or pinch the photo to zoom in or out, until it looks the way you want. Then click **Set as** to set the wallpaper as your Home screen or Lock screen.



Assign a photo to a contact. Click a photo, click **Set as**> **Set as contact's photo**, select a contact, crop photo and then click **Done**.

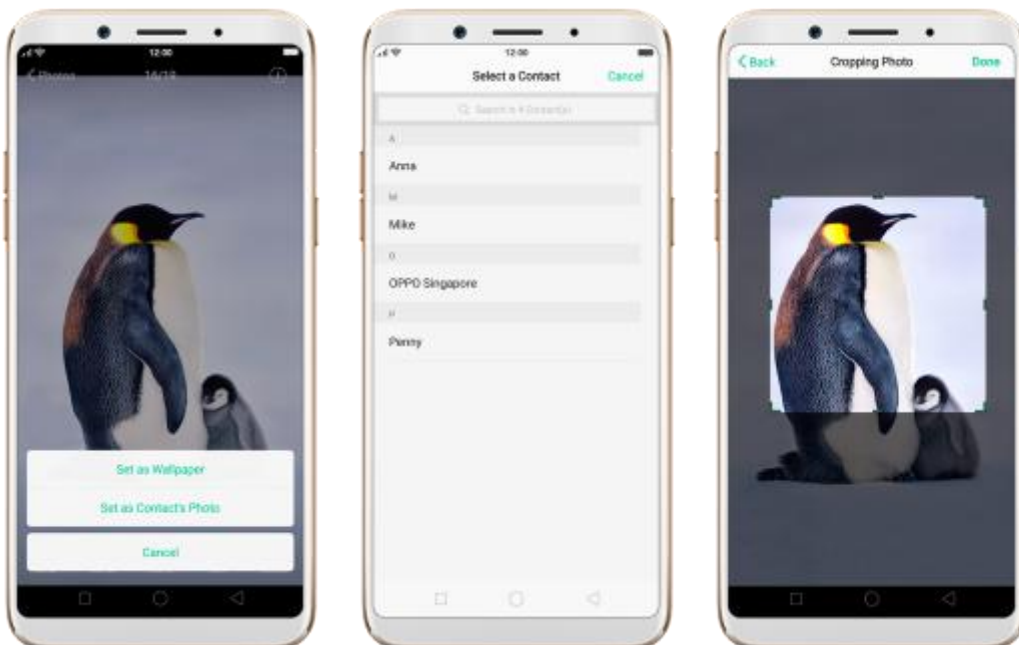

Add a photo or video to an existing album. Click **Add to**, then select the album.

Edit the photo. Click **Edit**. You can crop and rotate the photo, add photo effects, and more.



Delete a photo or video. Click **Delete**.

Combine the photos. From the Photos screen, click **Select**, select the photos, then click **Collage**. Choose a collage template, then click **Done**.

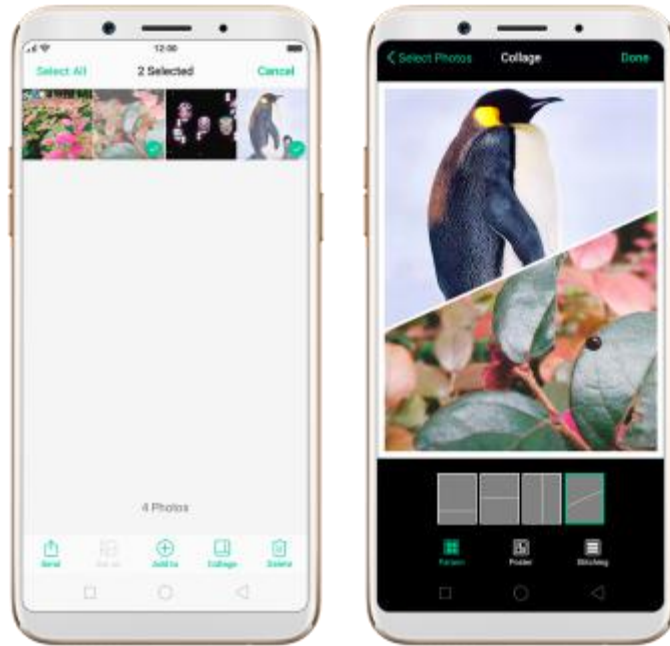

7.8. Music

7.8.1. Music

Use the Music app to enjoy music stored on your phone. You can also create playlists, set songs as ringtones for incoming calls, and more.

To see what you can do with your music, click  to the right side of the song name.

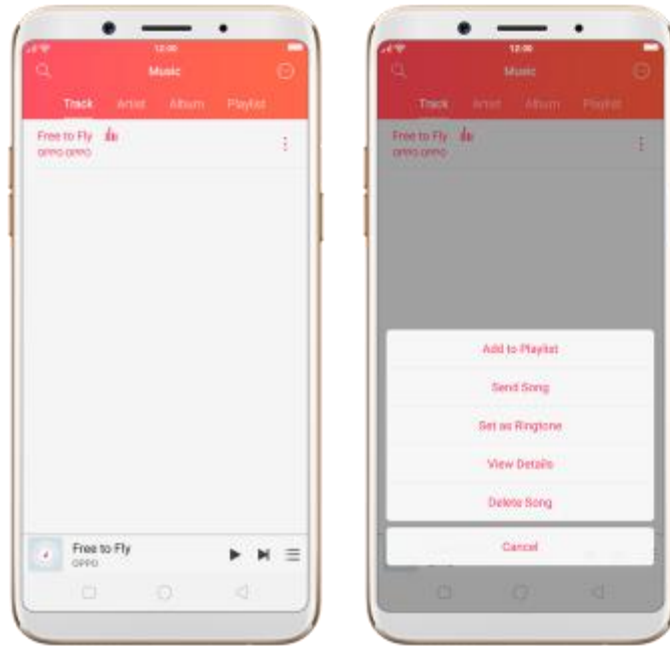

Add to playlist. Add a song to an existing playlist. You can also create a new playlist.

Send song. You can share a song with your friends using multiple ways.



Set as ringtone. You can set a song as a ringtone for all incoming calls and messages, or for a contact. You can also set a song as an alarm tone.

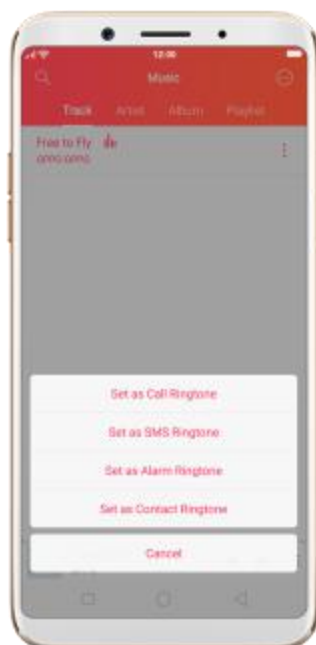

View details. Click to view the name, artist, album, format, size and storage location of a song.

Delete song. Remove the song from the playlists and your phone storage.

7.8.2. Change sort mode

By sorting your playlist, you can easily order the songs in your phone.

Change the order of your songs. From the Music screen, click **Track**, click  in the upper-right corner of the screen, then click **Select Sort Mode**. Your songs can be sorted alphabetically, by time when the song is added, or by folders the songs are in.

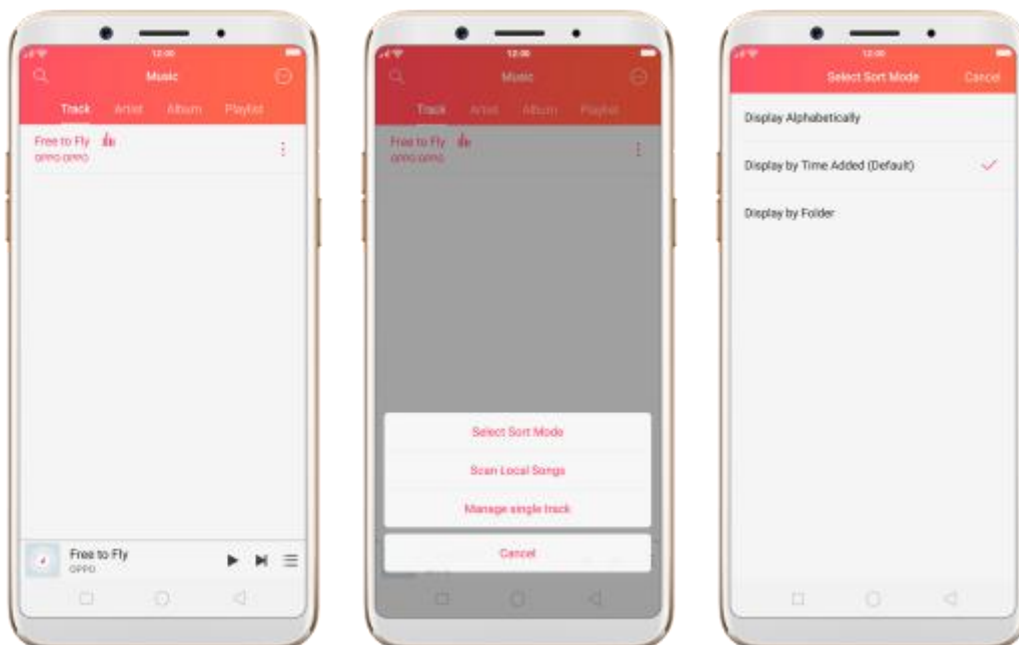

7.8.3. Scan local songs

The Music app contains all music-related materials on your phone storage. To manually scan for local songs, or choose which songs can be displayed in your list, do the following:

Scan all local songs. Click  in the upper-right corner of the Music screen, then click **Scan Local Songs**. Your phone will automatically start scanning.

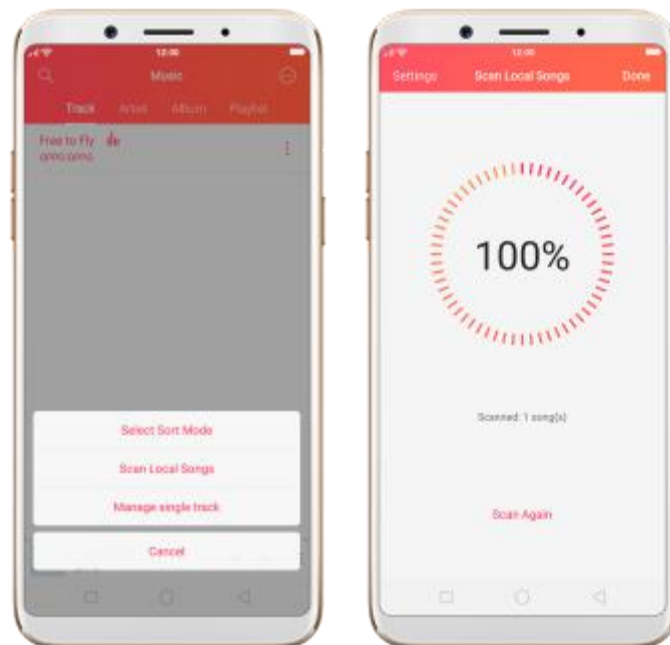

Scan specific folders. Click **Settings**, click **Scan specific folders**, then choose the folders you want the phone to scan for. Go back to the Scan Local Songs screen, then click **Scan again**.

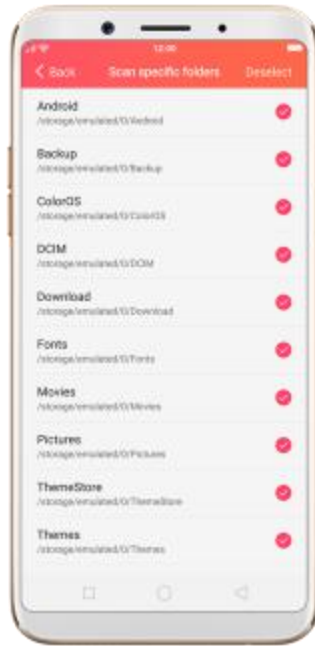

Filter audio files. To filter tracks that are too short (under 60 seconds) and too small (under 100KB), toggle the sliders to red.

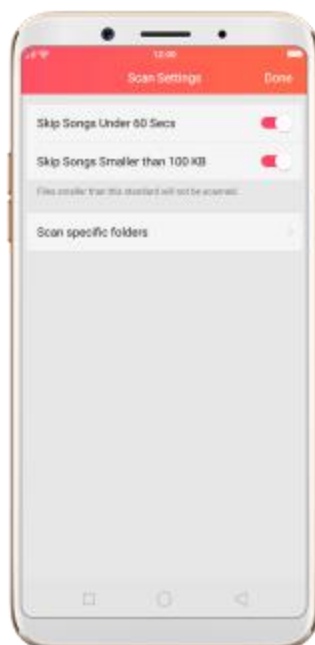

7.9. Videos





Use Videos to watch videos you've downloaded or recorded with the built-in camera.

Play a video. Click Videos on the Home screen, then click the video.

Control video playback. Click the screen to show or hide the controls.



TO	Do this
Play or pause a video	Click ► or .
Raise or lower the volume	Click the volume buttons on the side of the phone, or swipe your finger up

	or down on the right side of the screen.
Increase or dim the brightness	Swipe your finger up or down on the left side of the screen.
Skip to the next or previous video	Click  or  .
Rewind or fast-forward	Swipe your finger left or right on the screen.
Start a video over	Click  twice quickly.
Skip to any point in a video	Drag the playhead left or right.
Lock the screen rotation and disable bottom keys	Click  .

Sort videos. From the video screen, click  choose By Name, By Date Added or By Duration.

Send videos. From the Videos screen, click Select, choose videos, click Send, then choose an option for sending the video (for example, Messages, Mail, third-party apps, and so on).



Rename a video. Click Select, choose a video, then click Rename. Enter the name, then click Save.

See details about a video. Click Select, choose a video, then click Details.

Delete videos. Click Select, choose videos, click Delete, then click Delete videos.

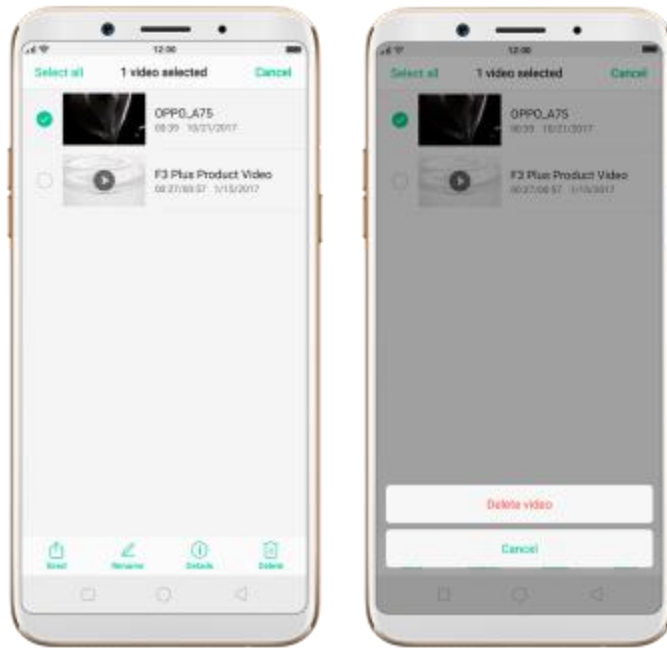

7.10. Theme Store

7.10.1. Online phone theme

A phone theme refers to the general look and feel of the phone's user interface. It changes color schemes for background images, icons, and more.

The entire phone's functions will not be affected.

Change the phone theme. Click Theme Store on the Home screen, then click **Themes**. Click your desired theme, click **Download**, then click **Apply** and wait a few seconds for the changes to apply.

Tip: Your phone will suggest similar themes based on the ones you've viewed or downloaded.



Search a theme. Click the search bar on the top of the screen, enter the theme name, then click .

7.10.2. Online wallpaper

In addition to use your photos as wallpaper, you can get some more wallpapers online from Theme Store.

Change the wallpaper. Click Theme Store on the Home screen, then click **Wallpapers**.

Click your desired wallpaper, click **Download**, then click **Apply**.

Drag to move the image. Or pinch to zoom in and out, so the image fits the screen. Click **Set as** to set the wallpaper as your Home screen or Lock screen.

Note: Lock screen image can only be changed in this way in phone default theme. If you use other phone themes, change the lock screen image in **[Settings] > [Display & Brightness] > [Lock Screen Magazine & Wallpaper]**.



Search a wallpaper. Click the search bar on the top of the screen, enter the wallpaper name, then click .

7.10.3. My profile

You can change Theme Store settings in My profile.

Open My profile. Click Theme Store, then click . You need to login to your OPPO account first.

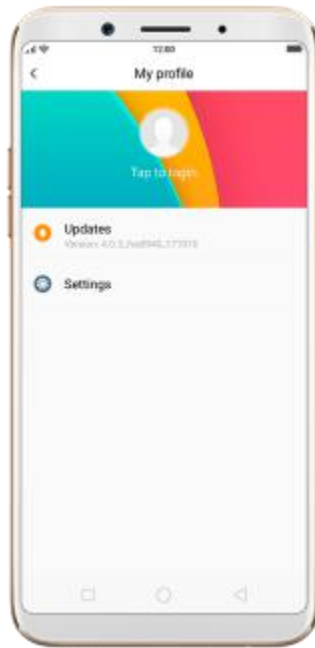

Update the Theme Store app. Click **Updates**, then click **Check for updates**.

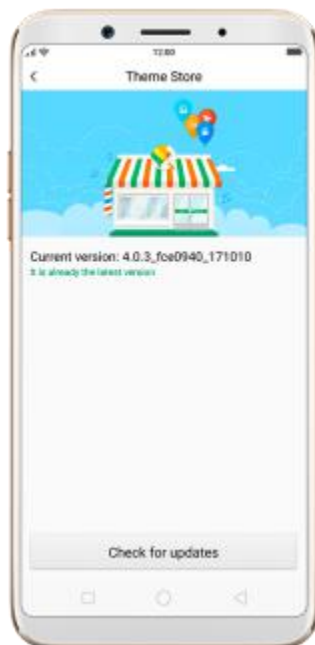

Download with a mobile data connection. Click **Settings**, then toggle the

2G/3G/4G download slider to green.

Clear app cache. Tap on the "**Clear cache**".



7.10.4. Manage your downloads

You can view and delete your downloaded themes and wallpapers in Local storage.

View and change phone theme or wallpaper. Click Theme Store, then click  in the upper-right corner of the screen. Click a theme or wallpaper, then click **Apply**. See Change the wallpaper and theme on your OPPO smartphone.

Delete downloaded themes and wallpapers. Click **Edit**, select the themes and wallpapers you want to delete, respectively, then click **Delete**.

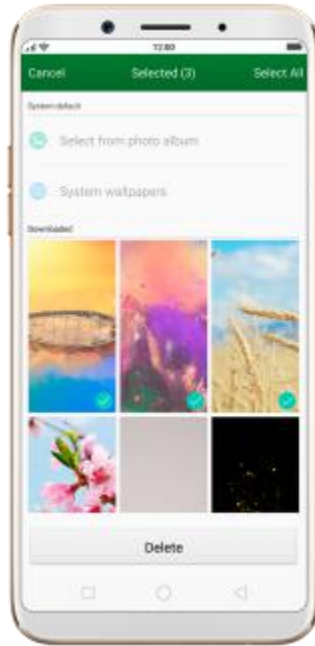

7.11. Clock

7.11.1. Set Alarm Clocks

With the Clock app, you can set an alarm that plays a sound at a specific time, so you will be reminded to do things in time and your doze won't go overtime. You can also set multiple alarms, set each alarm to repeat on days you specify, or to sound only once.

Set an alarm. Click Alarm and click **+**, scroll wheels to change the time, then adjust any of the following settings:



- To set the alarm to repeat on certain days, click Repeat and choose the days.
- To give the alarm a description, click Label. Your phone displays the label when the alarm sounds.
- To choose the ringtone that sounds when the alarm goes off, click Ringtone.
- To set whether the alarm gives you the option to hit snooze, turn Snooze on or off.

If Snooze is on and you click Snooze when the alarm sounds, the alarm stops and then sounds again in five minutes.

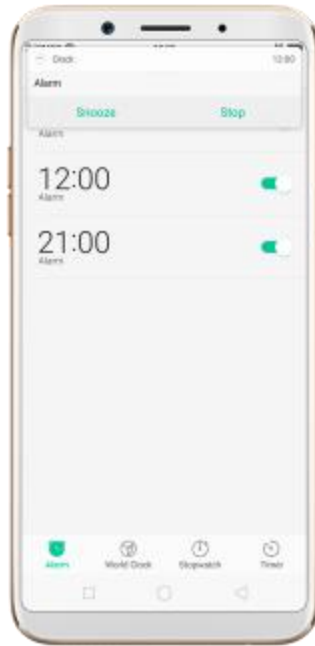

Turn an alarm on or off. Toggle the slider to green or white. If at least one alarm is set and turned on,  appears in the status bar at the top of the screen.

Tip: The alarm still works if your phone is turned off.

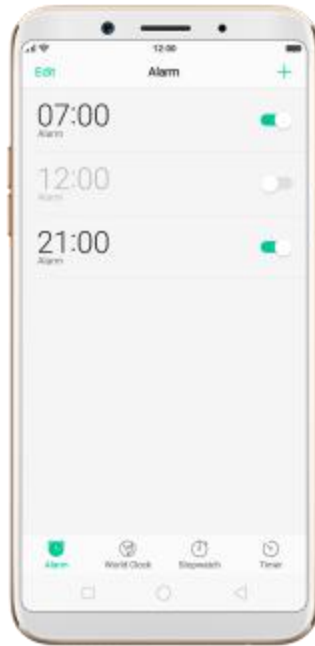

Change settings for an alarm. Click the alarm.

Delete an alarm. Click **Edit**, then click  next to an alarm and click **Delete**. Or swipe left on the alarm, then click **Delete**.



7.11.2. Add and view clocks for locations around the world

You can add multiple clocks to show the time in major cities around the world.



View clocks. Click World Clock. If the clock face is white, it's daytime in that city. If it's black, it's nighttime.

Add a clock. Click **+** and type the name of a city. Cities matching what you've typed appear below. Click a city to add a clock for that city.

Delete a clock. Swipe left on the clock, then click **Delete**. Or click **Edit**, then click **-** next to a clock and click **Delete**.

Rearrange clocks. Click **Edit**, then drag **⇄** next to a clock to a new place in

the list.

7.11.3. Use the stopwatch

You can measure the duration of an event with the stopwatch.

Use the stopwatch to measure time. Click Stopwatch. Click **Start** to start the stopwatch. To record lap times, click **Lap** after each lap. Click **Stop** to pause the stopwatch. Then click **Start** to resume, or click **Reset** to reset the stopwatch to zero.

If you start the stopwatch and go to another application, the stopwatch continues running in the background.



7.11.4. Set the timer

In the Clock app, you can count down from a specified time with the timer.

Set the timer. Click Timer, then scroll the wheels to set the duration of time.

If you start the timer and go to another application, the timer continues running in the background. When the timer ends, your phone sounds and vibrates to prompt you to stop the timer.

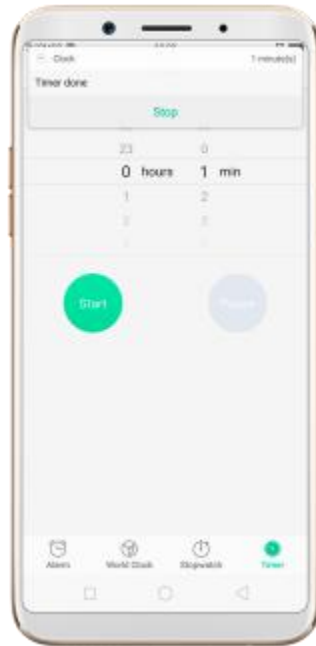

7.12. Files

7.12.1. Fast file browsing

The Files app automatically categorizes your files based on their extensions so you can browse them more clearly and conveniently.

Fast file browsing. Click Files, then you'll see all nine categories, including Audio, Videos, Photos, Documents, and more. Click a category to browse and manage files.



7.12.2. View and manage files

The Files app provides you various ways to manage your files and folders.

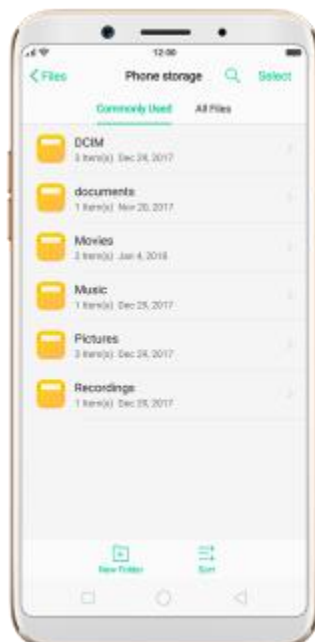

Commonly Used. You can view the folders which files are commonly used.

Click any one to enter and choose the file to manage.

Search a document or folder. Click All Files, click the search icon, then enter the name of a document or folder.

Create a new folder. Click New Folder. Enter the folder name, then click Save.

Sort files and folders. Click Sort, then choose to sort your files and folders by name, size, type or the time they were generated.

Share, move, copy, delete, compress, show details, rename a document or a folder. Click Select, choose the document or folder, then choose an option.

Move documents to Safe and set a password to lock them. Click Select, choose the documents, click More, then click To Safe. Folders cannot be moved to Safe. See File Safe.

Select all. In each page when you click Select you can quickly choose all by click Select all in the top left corner.

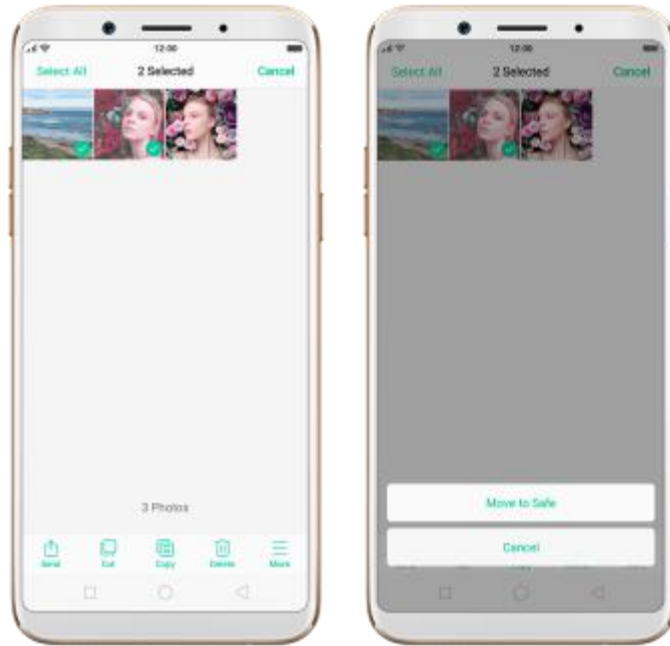

7.12.3. Fast cleanup

Use Clean Up feature to quickly detect and remove hidden temp, cookie and cache files generated by inner calculations and data exchanges to free up more storage space.

Clean up junk files. Click Files, then click Clean up. Your phone will thoroughly scan for junk files and APKs, and lets you choose files to be deleted, then click Clear.



Free up more storage space. Click Advanced, then remove your App data and downloads (including videos, pictures, music, documents, ZIP and miscellaneous files). To manage all your data, click File Management and go to Files.



7.12.4. Remote Management

Remote Management can turn your phone into a FTP (File Transfer Protocol) Server so you can view and download files on your phone remotely from your computer.

Use Remote Management to view and download files. Click Files, and then click Remote Management. Connect to a Wi-Fi network, then click Start Service. Search the URL displayed on your phone screen with your computer, then you can view your phone's file system and download files directly to your computer.

Note: Make sure that your phone and computer are connected to a same Wi-Fi network.

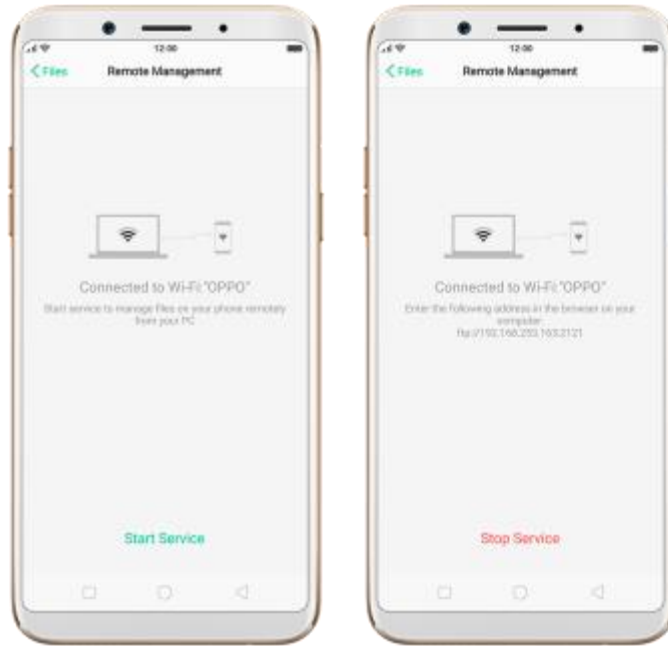

7.12.5. File Safe

To keep your private files strictly confidential, you can move them into File Safe and set a password to lock them.

Move files to File Safe. Click File Safe, set up the passcode, then click Add File. You can also click All Files from the Files screen, select files, click More, then click To Safe.

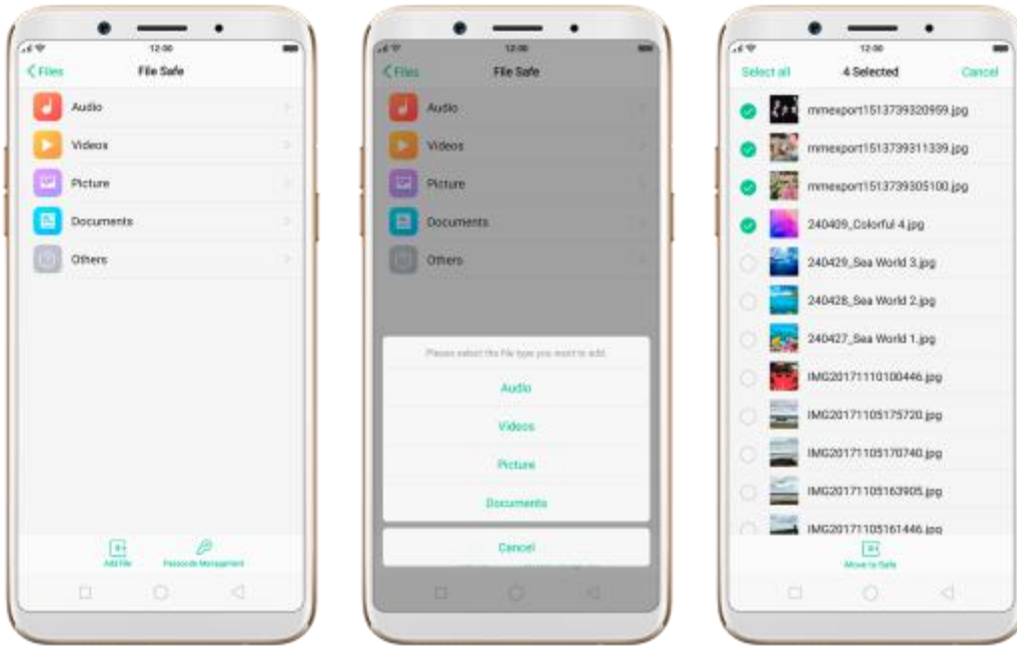

Move out or delete a file from File Safe. Enter File Safe, select the file, then click Delete or Move Out. You can also swipe left on the file, then click Move Out or Delete.

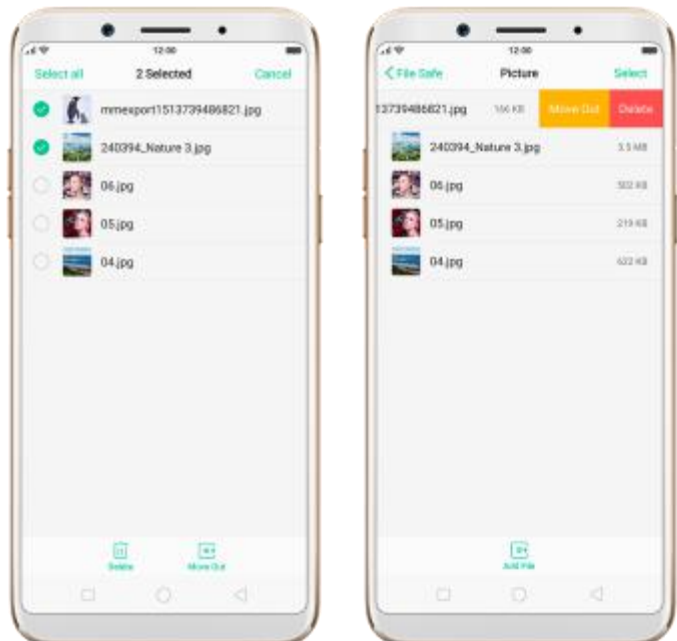

Change the passcode for File Safe. Enter File Safe, then click Passcode Modification. Enter the old passcode, then set a new one.

7.13. Calculator

The Calculator app combines the standard and scientific calculators, which fits all objects with different demands.



Delete the last digit. Click .

Clear the calculation results. Click .

Hide or show the keypad. Click  in the middle of the screen to hide the keypad. Click **Calculate** or the calculation formula to resume.

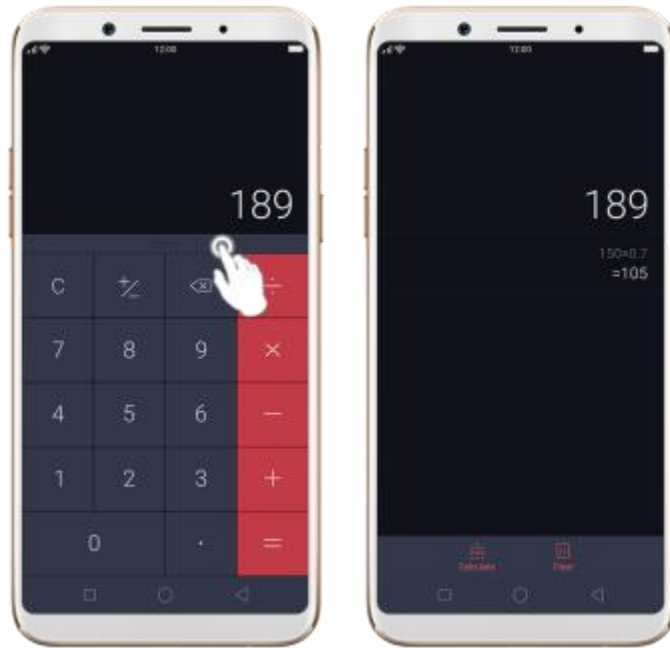



Use the scientific calculator. Rotate your phone to landscape orientation.



7.14. Sound Recorder

7.14.1. Record

With the Sound Recorder app, you can use your phone's built-in microphone to record sounds when you need it.

Make a sound recording. Open Sound Recorder, click  to start recording. Click  to pause. Click  to stop and save the recording.

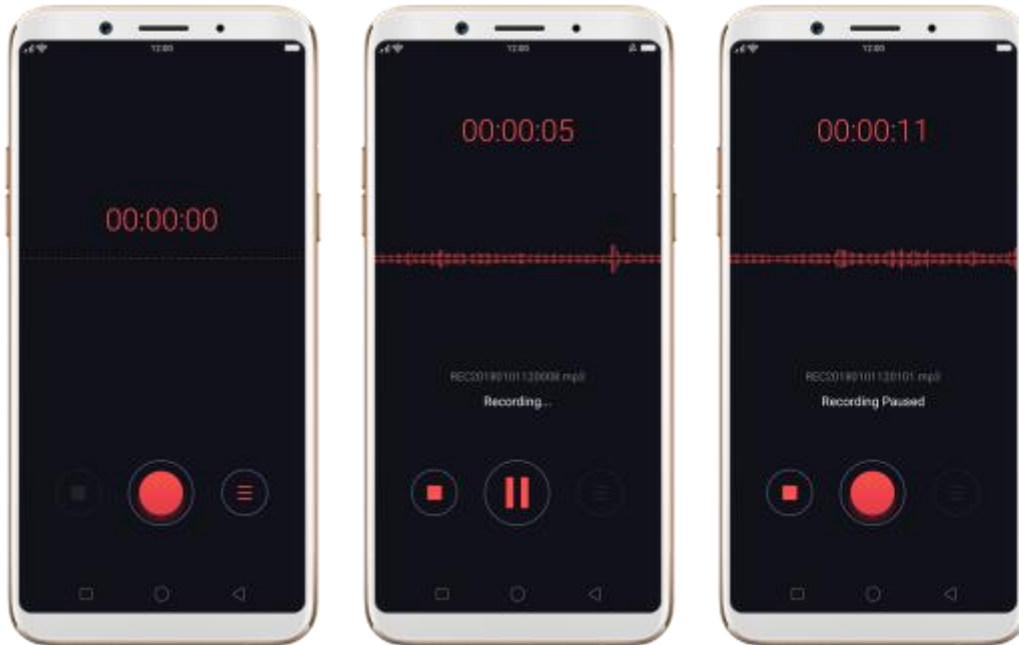

If you start the sound recorder and go to another application, the sound recorder continues running in the background. To return to Sound Recorder, click the red bar at the top of the screen.



7.14.2. Manage recordings

Play the sound back. Open Sound Recorder, then click  . You'll see all recordings on your phone. Divided into Call recording and Normal recording. Click a recording to play it back.

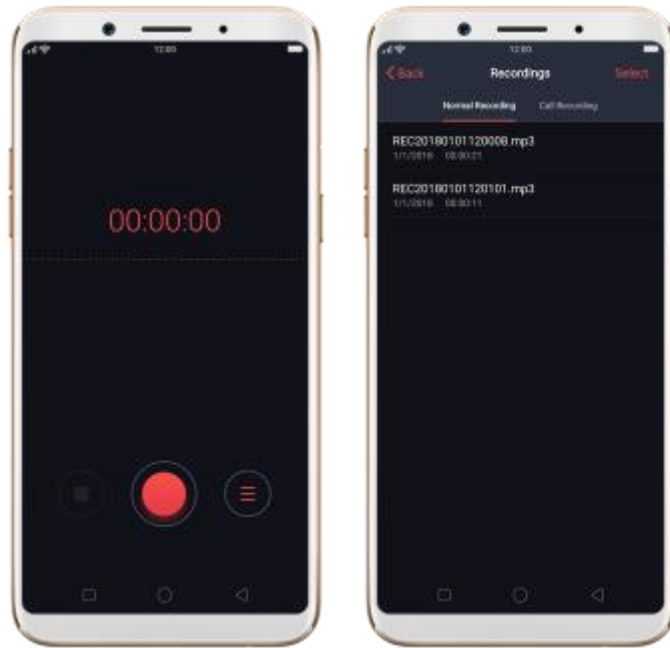

Send, rename or delete a recording. Click Select, choose the recording, then choose an option.



Set the recording as ringtones. Click Select, choose the recording, click Set

as Ringtone, then set the recording as the call, SMS, alarm or contact ringtone.

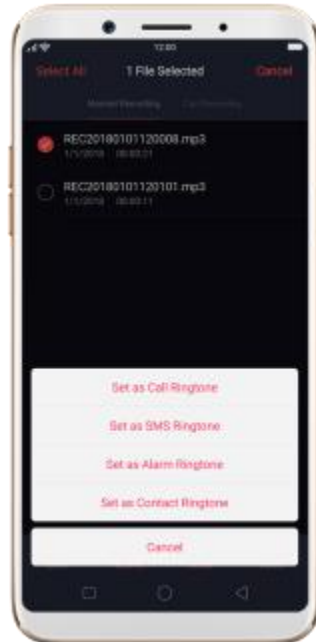

7.15. Compass

You can use the compass app to quickly find the direction you're facing.

Calibrate the compass when prompted. Move away from the interference and spin your phone in the pattern of an infinity symbol.



Find your direction. Turn on Location Service first, then click Tools folder on the Home screen, click Compass, and you can quickly find your direction, see your latitude and longitude.



7.16. Chrome

7.16.1. Search the web

The Browser lets you see webpages just as they were designed to be seen in computer-based browsers. Pinch the screen to zoom in and out; rotate the phone sideways for a wider view. You can also add page icons and bookmarks for quick accesses.

Search the web. Click  and say whatever you want to search for, or click the search bar, type the content or web address, then click a matching result under the search bar, or click Go in the lower-right corner of the keyboard.

As you type, any web address in your bookmarks or history list that contains those letters appears below. Click a web address to visit its webpage.

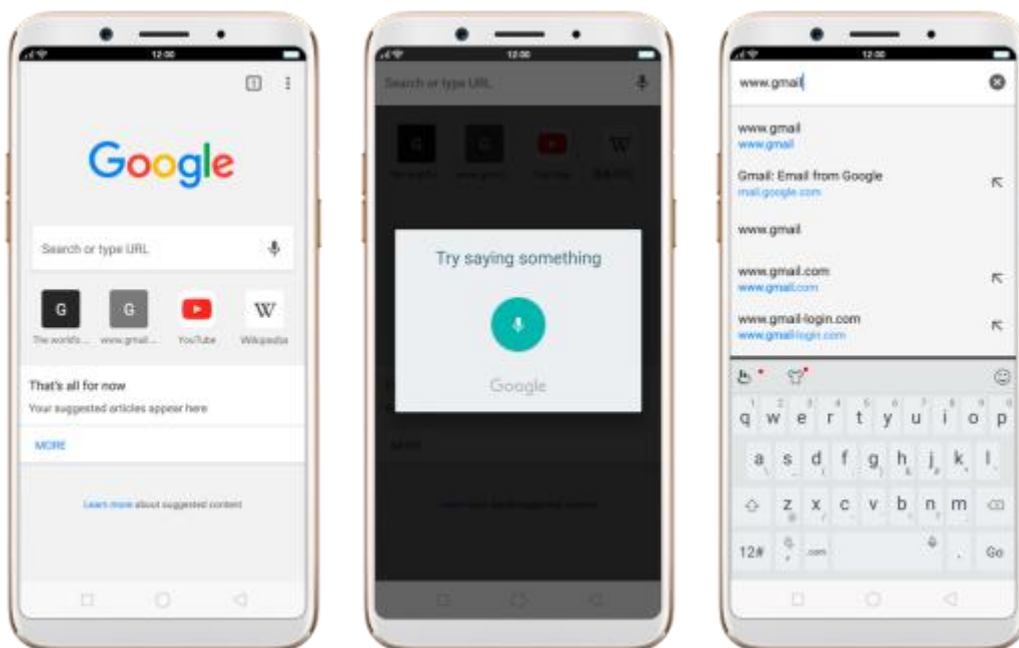

You can also click the Google search bar on the Home screen, then type or say whatever you want to search for.

Erase all the text in the address field. Click the address field, then click .

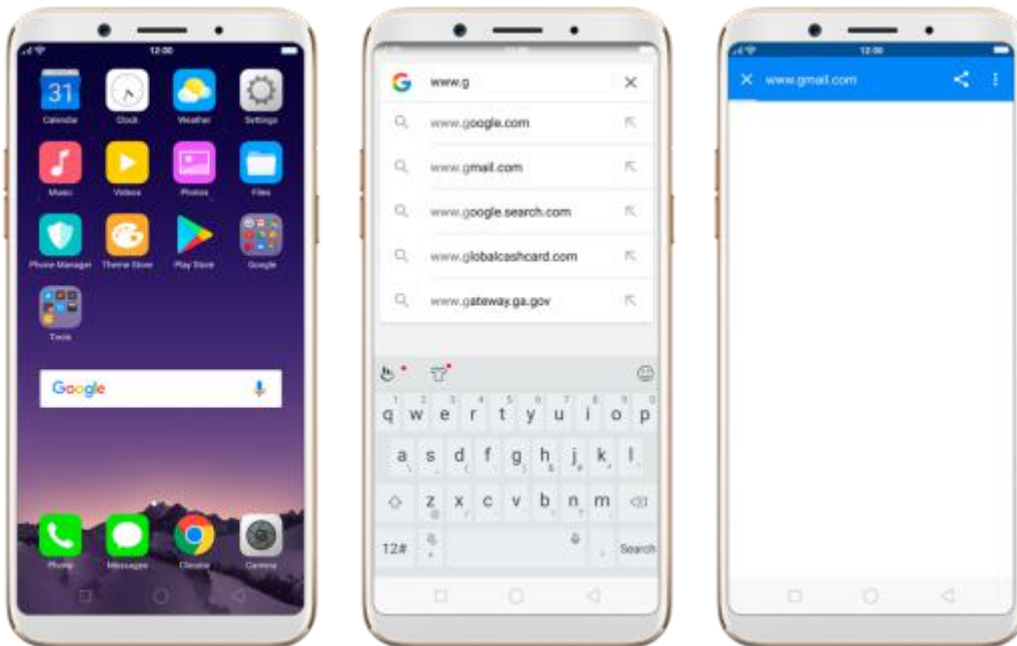

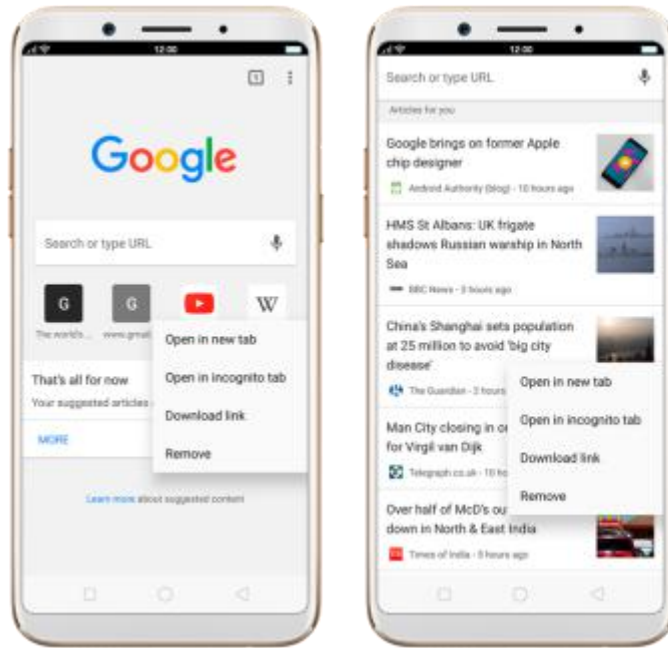

Open a suggested article. Chrome will suggest similar articles based on the ones you've viewed. Touch and hold the suggested articles window, then you can view, download or remove it.

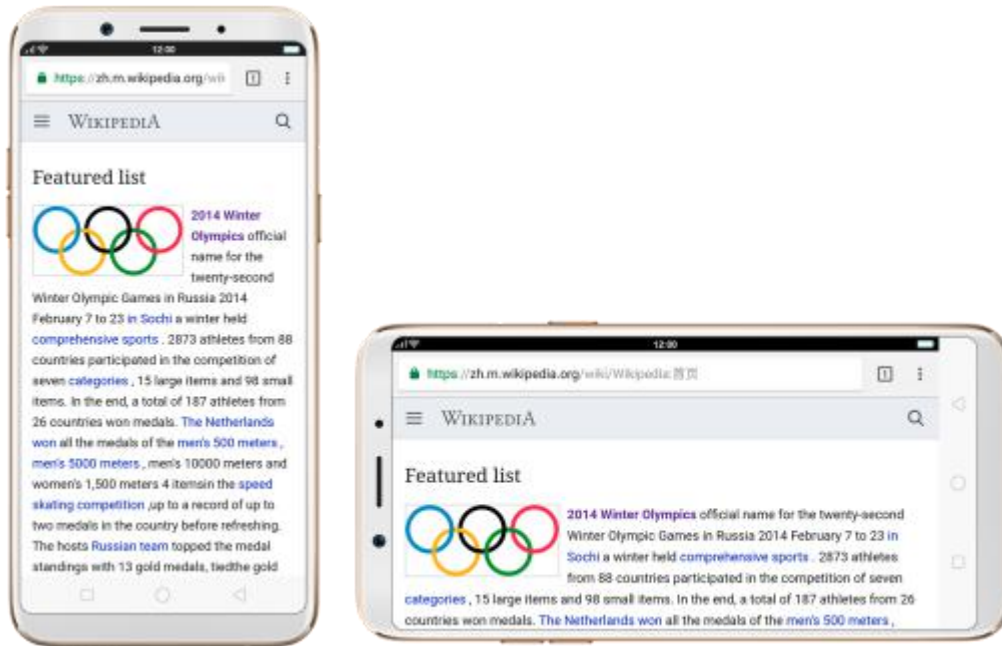

7.16.2. Browse the web

View a webpage in landscape orientation. Swipe up from the bottom of the screen to open Control Center, then turn off **[Portrait Orientation Lock]**. Rotate the phone sideways. The Browser automatically **switch to landscape mode**.



Zoom in or out. Pinch to zoom in or out. When you browse a website which has a mobile-specific view that prevents you from pinching in to zoom, you can use the Force enable zoom feature to override the site's demands. Click  , click **[Settings]**, click **[Accessibility]**, then turn on **[Force enable zoom]**. You can now pinch to zoom wherever you want, whether the website technically supports it or not.

Change the text size. Click  , click **[Settings]**, click **[Accessibility]**, then drag the Text scaling slider to the left or right to shrink or enlarge sample text until you can read comfortably.

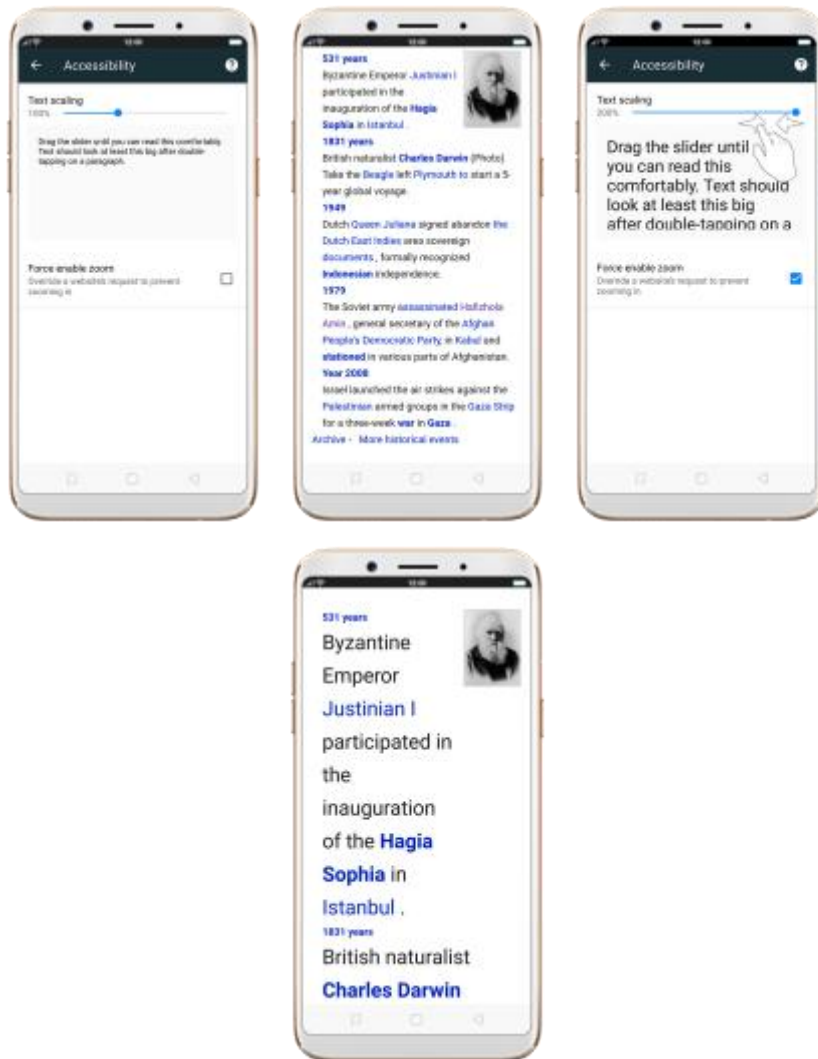





Scroll around the page. Drag up, down, or sideways. When scrolling, you can touch and drag anywhere on the page without activating any links.

Click on a webpage. Click the link. Many images also have links. A link can take you to another place on the web, open another app, call a phone number, and more.

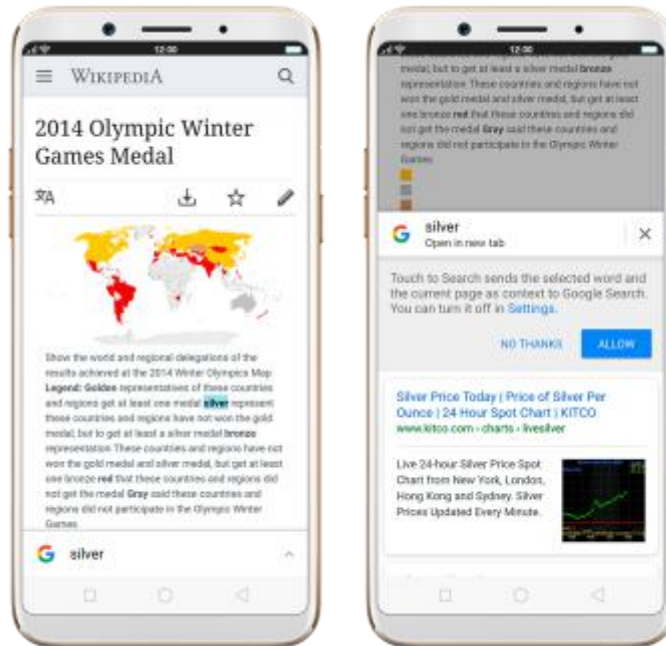

Search the selected text in new tab. Touch the screen to select text, then Chrome will search the related content in a new tab. Click [^] to view the

search results.

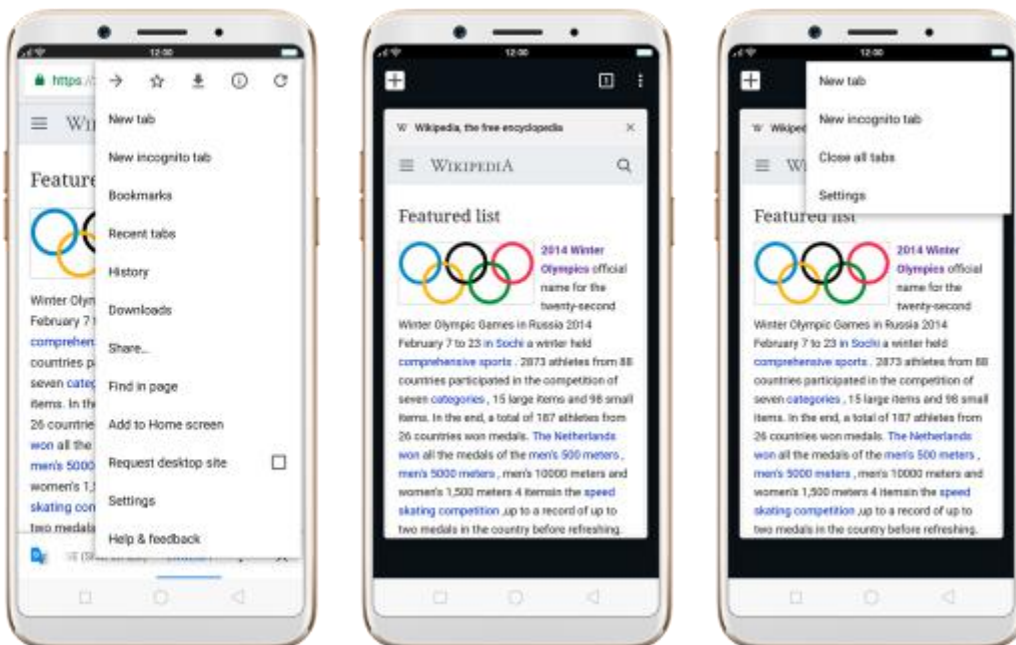

Open a new tab. Click  , then click **[New tab]** or **[New incognito tab]**. You can also click  on the left, then click  to open a new tab, or click  on the right, then click **[New tab]** or **[New incognito tab]**.



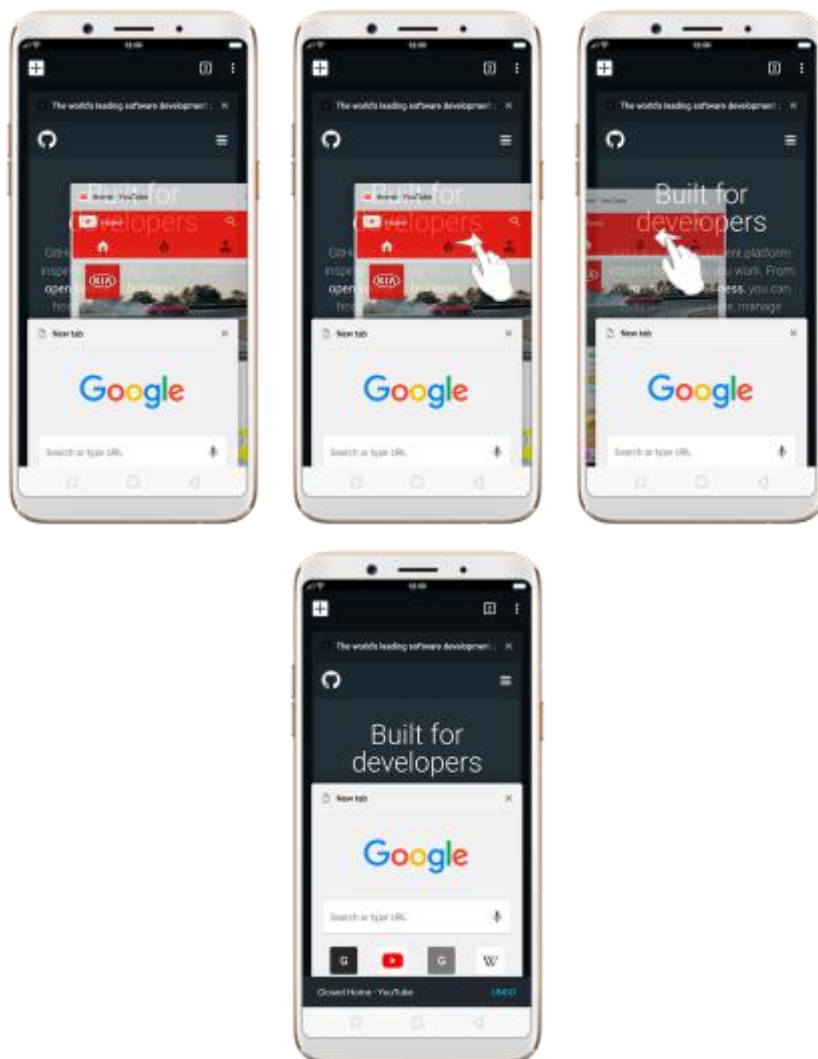

View all open tabs. If you open three tabs, for example, click  , then swipe up or down. To go to another tab that's open, swipe to the tab, then click it. To close a tab, swipe left or right on the tap, or click  . To restore a tab you just closed, click UNDO.

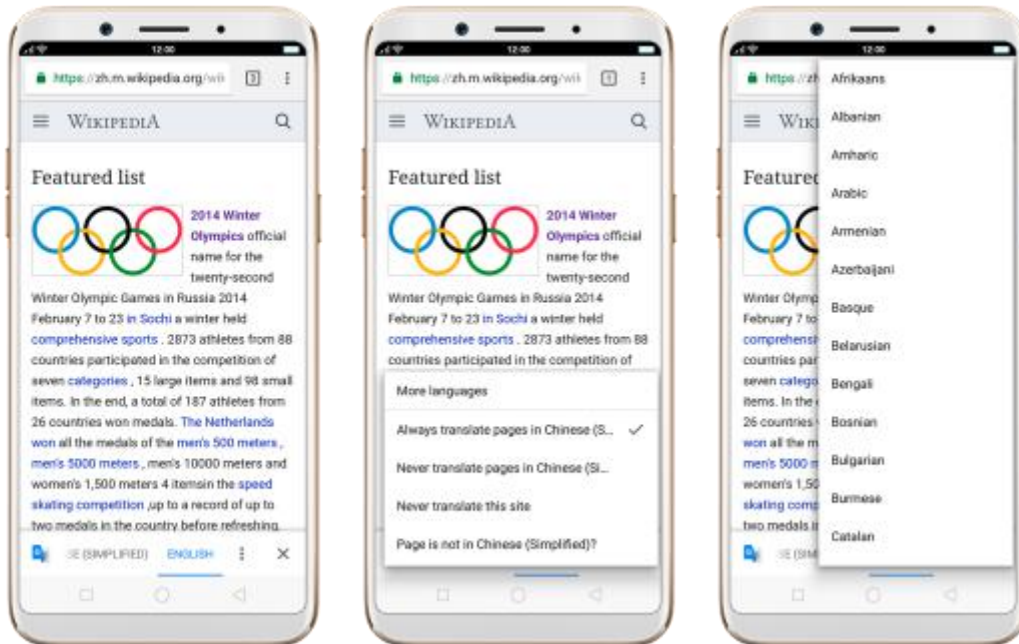

Translate a webpage. When you open a webpage, a translation bar will pop up at the bottom of the screen. Click  , then click More languages to choose your default one. To set when to translate a webpage, click a

translation option available below. Translating a webpage takes time, please be patient.



Find in page. Click  , click Find in Page, enter the text, then the browser will find text matches in the current webpage.



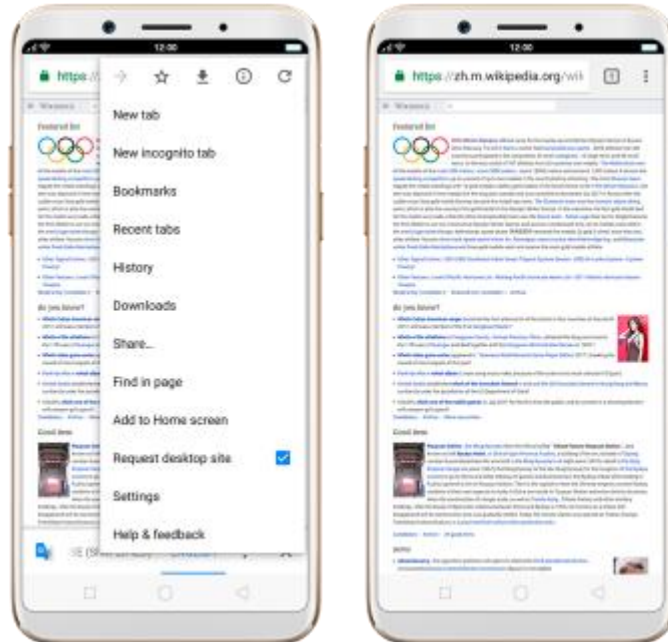

Request desktop site. To see webpages just as they were designed to be seen in computer browsers, click  , then enable Request desktop site.



7.16.3. Quick Access

With Chrome app, you can add webpages to Bookmarks, so that you can quickly return to them at any time without having to type the address. You can also add page icons to the Home screen for quick access, and download the webpages to view them offline.

Bookmark a webpage. Open the page, click  , then click  to bookmark a webpage. To view, edit, move and delete your bookmarks, click  , then click Bookmarks.

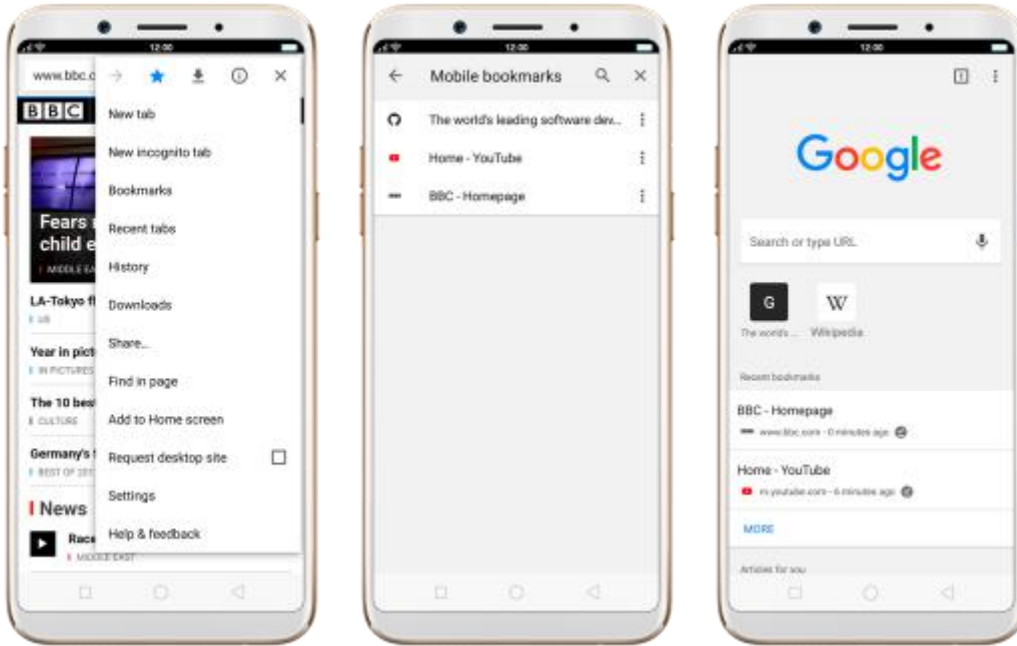

Add an icon for the current page to your Home screen. Open the page, click  , then click **[Add to Home screen]**, edit its title, then click **ADD**.

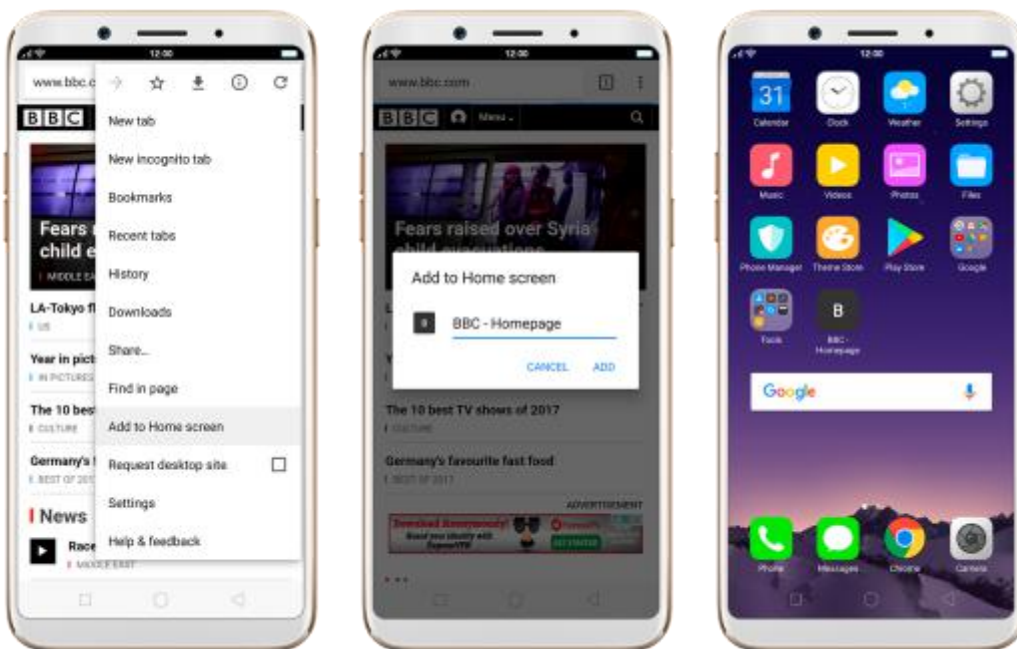

Save a webpage for offline reading. Open the page, click  , then click 

to download the webpage. To view and open your offline page, go back to Chrome homepage, or click , click Downloads, then click a page.

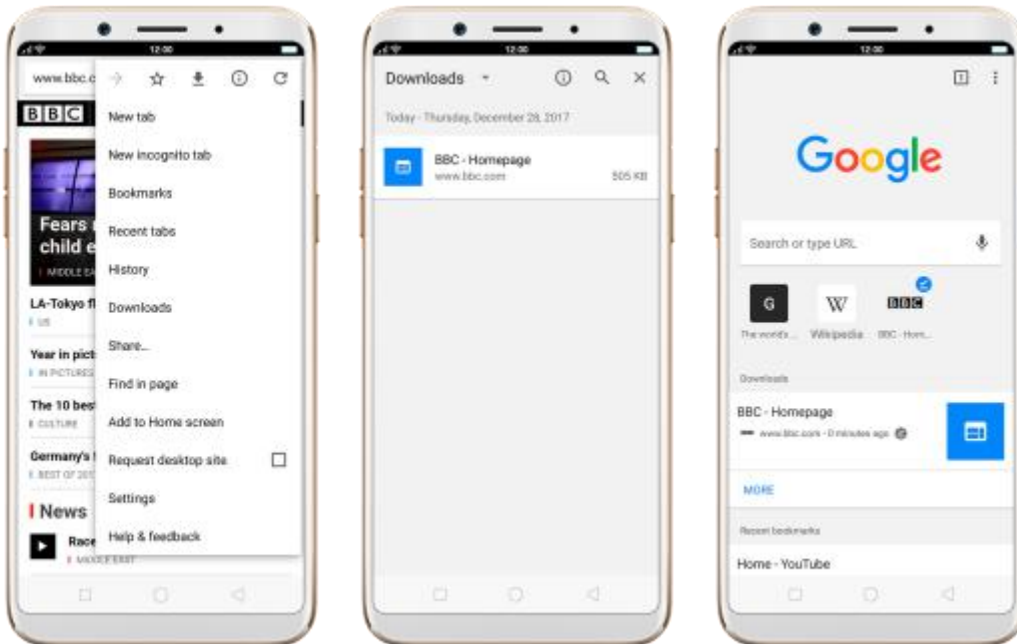

8. Safety & Privacy

8.1. Device security

8.1.1. Lock screen password

Security on your OPPO smartphone begins at the lock screen. You can set a passcode that will be needed to unlock your phone.

Set, change, or turn off the passcode. Go to **[Settings] > [Fingerprint & Passcode]**. You can draw a pattern, use a Custom Alphanumeric Code or 4-Digit Numeric Code.

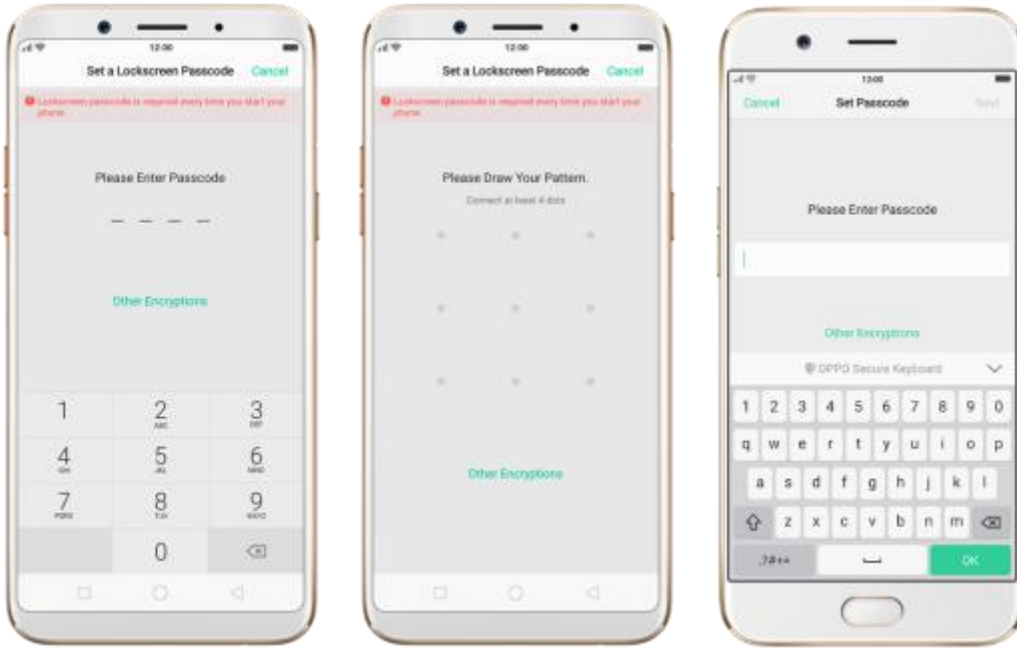

Add fingerprints. Before you can add a fingerprint, you need to create a passcode. You can use the fingerprint to unlock the phone.



8.1.2. Smart Lock

Smart lock is a handy way to make gaining access to your phone easier.

Turn on Smart Lock options. Go to **[Settings]** > **[Additional Settings]** > **[Safety & Privacy]** > **[Smart Lock]**, then enter your phone passcode.

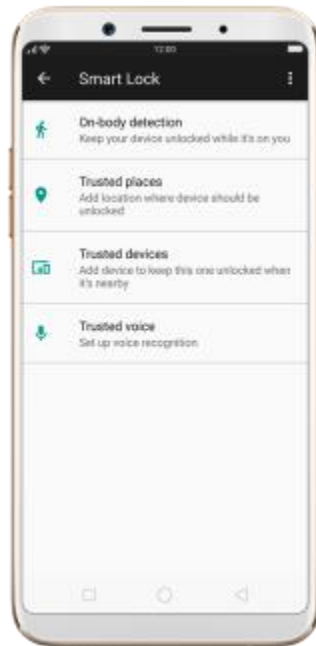

- **On-body detection.** Once enabled, your device will keep unlocked while it's on you, like when you are holding it or carrying it. Your device will lock when it detects that it's been set down.
- **Trusted places.** If you have added trusted places, your device will keep unlocked when it's nearby. For example, if you have added your home as a trusted place, when you are nearby home within 80m, device keep unlock.

- **Trusted devices.** If you have added trusted devices, for example, your Bluetooth watch, your car's Bluetooth system, when they are connected, your device phone keeps unlock. (Note: Bluetooth connections have a range of up to 100 meters.)
- **Trusted voice.** Save your voice or other audio in your Google account and your device will be unlocked once it recognizes your voice.

Note: When Smart Lock is on, your phone will remain unlocked if you're carrying the phone, which will quickly drain your phone's battery, also will lead to incorrect operations if you put the phone in your pocket. Therefore, if you want to use Smart Lock, use it wisely, and in right conditions.

- +

8.1.3. Safe keyboard

- When you enter sensitive information such as passcodes, the system will automatically switch to OPPO Safe Keyboard to protect your input content from leaking out.
- **Enable Safe Keyboard.** Go to **[Settings]** > **[Additional Settings]** > **[Keyboard & Input Method]** and toggle the slider to green.

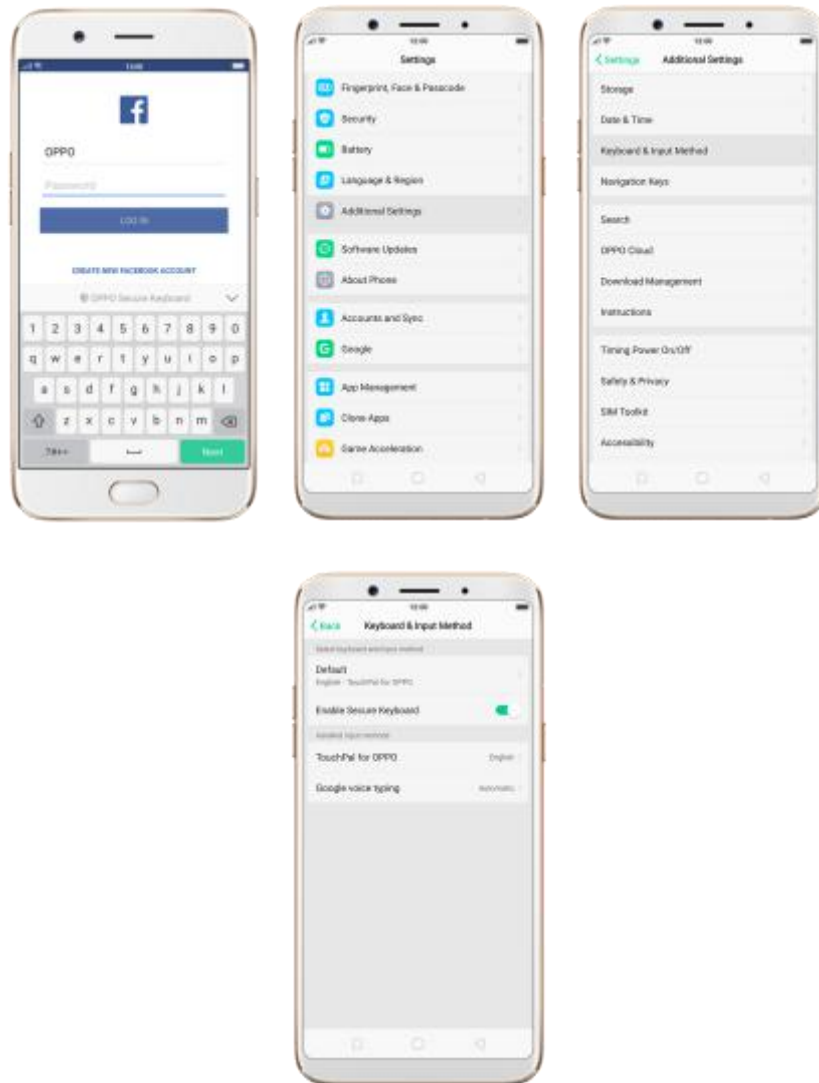

8.1.4. Payment protection

- While you shop online, your OPPO phone will provide protection for the mobile transactions, such as detecting captcha and app security. You can see the detected information of the current payment environment in the upper-right corner of the screen.
- **Set up payment protection for apps.** Go to **[Settings] > [Security] > [Payment Protection]**.



8.1.5. Set up a SIM card lock

- For better security, you can set up a SIM card lock. The SIM lock will make sure that only those who know the password can use the phone.

- **Set up a SIM card lock.** Go to **[Settings]** > **[Additional Settings]** > **[Safety & Privacy]** > **[Set up SIM card lock]**. Click the slider next to Lock Sim Card, type in the PIN code and then click OK.
- **Note:** If the wrong PIN is entered more than three times, both your SIM card and phone will be locked. You can enter the PUK code to unlock them. See About SIM card PIN & PUK code.
- **Change the SIM card PIN code.** Click Change SIM PIN, type in the current PIN code, click OK. Then you can type in the new PIN code, click OK, retype your new PIN code when prompted, then click OK.



8.1.6. Virus Scan

- For better security, you should regularly scan and remove potential and actual threats to your phone.

- **Scan for virus.** Click Phone Manager, then click Virus Scan. Wait for the scan to complete. If threats were found, remove them; if not, you will see a message that says your phone is in a good state.



8.1.7. Pseudo Base Station Blocking

- Your phone might receive many spam messages (including investment advice, promotional messages, and more), or be infected by mobile viruses sent from the pseudo base stations. When these stations are identified, your phone will automatically block the information sent by them, thus safeguard your property and secure you information.
- **Block pseudo base stations.** Go to **[Settings] > [Security] > [Pseudo Base Station Blocking]** and you will see a list of pseudo base stations identified and blocked by the phone.

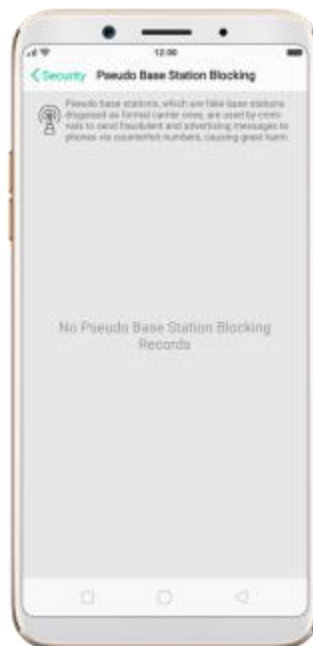

8.2. Device administration

8.2.1. Allow and install apps from unknown sources

By default, you are not allowed to install apps outside from the official Play Store on your OPPO phone - unless you have allowed your phone to do that.

If you run an APK on your phone without first enabling the feature, you will see the following on your screen.

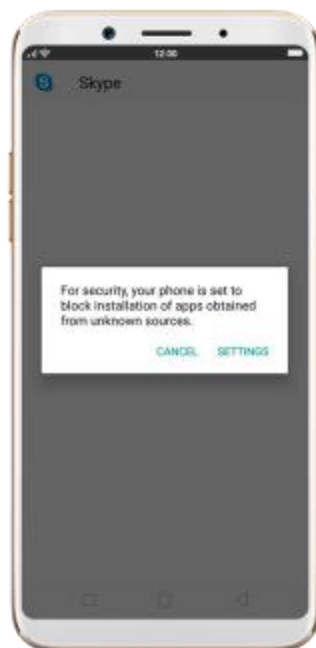

Install apps from unknown sources. Go to **[Settings]** > **[Additional Settings]** > **[Safety & Privacy]** and enable **[Install Unknown Source Apps]**.

Note: Installing apps from unknown sources means that you are now

responsible for your phone's safety. Don't ever install any app unless you are absolutely sure that it is not malware. Also, don't download an APK file from unknown sources.

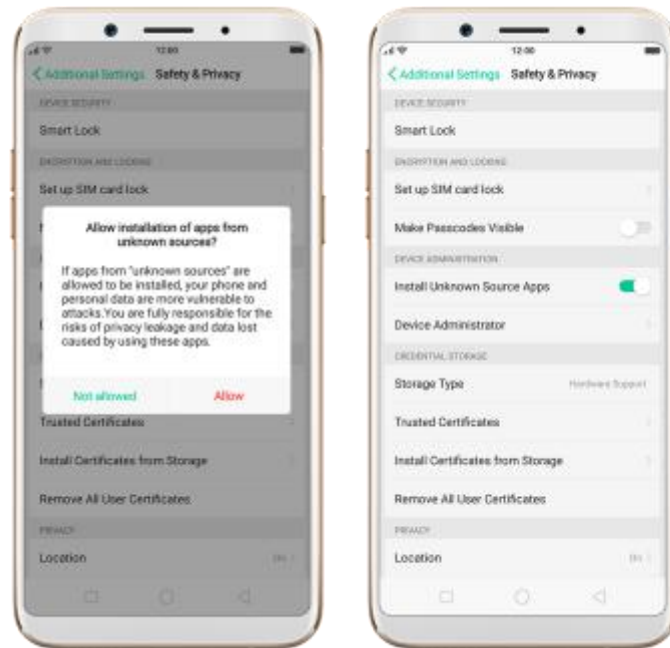

8.2.2. App Encryption

You might login and use phone applications with a wealth of privacy information including credit cards numbers and passcodes, banking data and home address. Thus, you need to encrypt apps to protect from prying eyes.

Encrypt your apps. Go to **[Settings]** > **[Security]** > **[App Encryption]**. See Encrypt applications on your OPPO smartphone.

Access the encrypted app. Every time you want to access the encrypted app on your phone, you need to enter the passcode. To use your fingerprints to unlock the app, go to **[Settings]** > **[Fingerprint & Passcode]** and enable **[APP Encryption]**. Or go to

[Settings] > [Security] > [App Encryption], click , then enable [Use fingerprints to open encrypted apps].

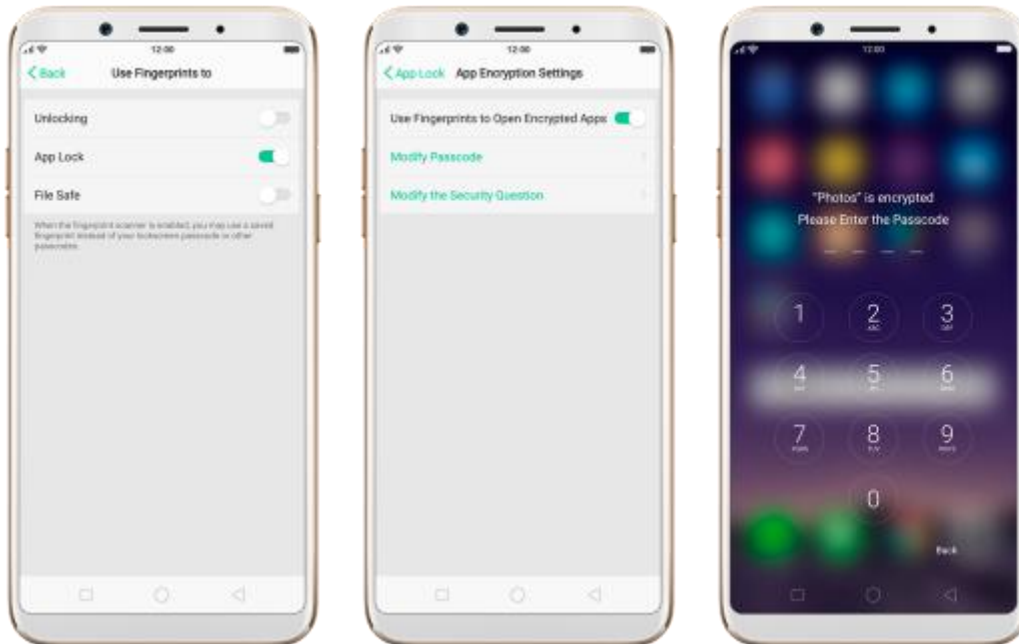

8.2.3. App permissions

Every application installed in your OPPO smartphone may require certain data or access to your phone's other features (mic, camera, etc.). To check and manage what an app is trying to access, do the following:

Check all permission details. Go to [Settings] > [Security] > [App Permissions]. You will find all the permission categories on your phone. Click "Apps" to view apps installed on your phone and the permission groups an app has.

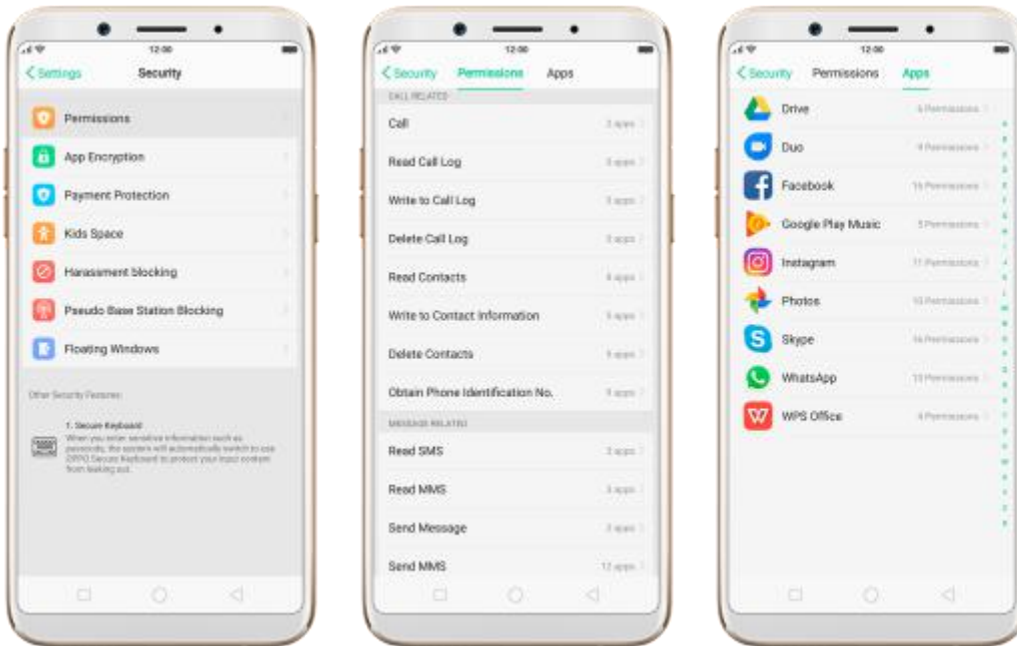

Change the permission. Click a category or an app, then choose Allow, Forbid or ask.

- **Allow:** Always allow the app to use the required permissions.
- **Forbid:** Disable the required permissions completely for the app.
- **Ask:** Every time you start the app, it asks you to grant the permissions that are required.

8.2.4. Kids Space

- With ColorOS 3.1, parents can set limits specially for children's use of the phone, such as setting up phone usage time and apps allowed to be accessed. It does a good job in charge preventing, system modification prohibiting and addiction preventing when your kids use the phone.

- Set up Kids Space. Go to **[Settings]** > **[Security]** > **[kids Space]**.

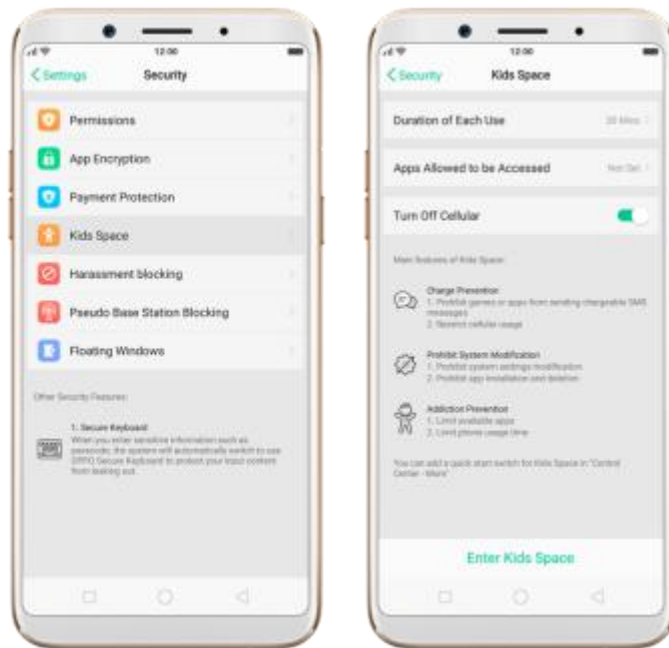

8.2.5. Block unwanted calls and messages

Block feature helps you to prevent unwanted phone calls and messages from reaching you. You can also add numbers to blacklist to block specific phone numbers.

Block calls and messages. Go to **[Settings]** > **[Security]** > **[Block]** or **[Settings]** > **[Call]** > **[Block]**



- **Block Calls:** Choose the options available for blocking incoming calls. See Block calls.
- **Block Messages:** You can block all unknown messages, or block specific spam messages by entering the keywords.

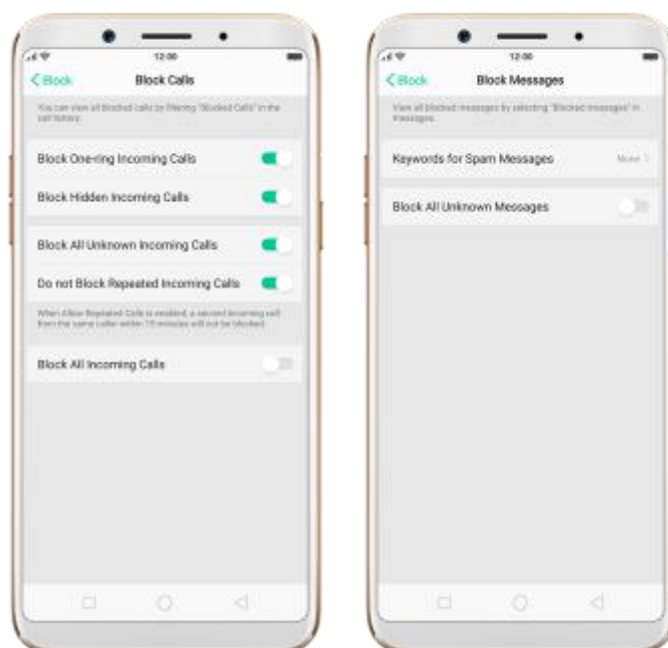

Add a contact or a phone number to the blacklist. Go to **[Settings] > [Call] > [Block]**

> **[Blacklist]**, click  , then enter the number or choose your contacts. Or open a caller's contact card in Contacts, then click Block This Contact.

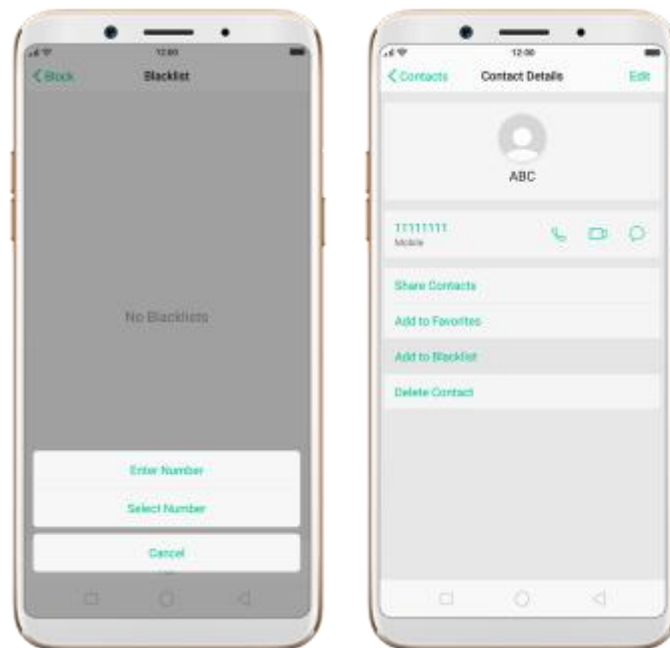

8.2.6. Find my device

In the event that your phone is lost or stolen, you can use Google's Find My Device to locate, lock or factory wipe your phone. You need to sign in your Google account and turn on Location Service on your phone.

Activate and use Find my Device. Go to **[Settings] > [Google] > [Security]** and click Find My Device. Toggle both the sliders to blue. To use Find My Device, head over to Google and search "Find my phone" on your computer.

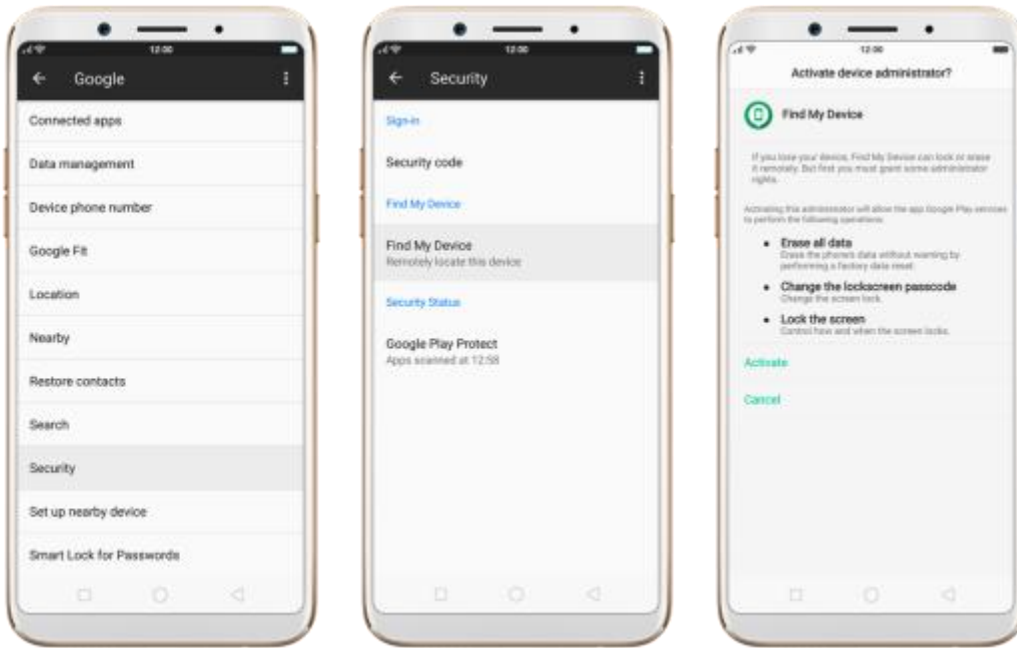

- **Remotely locate this device.** The phone's geographic location will appear in the search results, along with an option to help locate it.
- **Play sound.** Let the phone play a loud tone continuously at full volume for five minutes even if you turned the ringer off.

Allow remote lock and erase. If you believe your phone has been stolen, use this feature to remotely lock your phone and erase the entire data residing on the phone so that no one can access it.



8.3. Privacy

8.3.1. Location Service

Apps like Maps, Weather and Compass must know your exact position before it can provide accurate services and results.

Turn on Location Service. Swipe up from the bottom of the screen to open Control Center, then click . You can also go to **[Settings] > [Google] > [Location]** and toggle the slider to green.



You can choose from three types of **positioning modes**, which differ in accuracy and battery drain:

1. **High accuracy** (GPS, Wi-Fi, Bluetooth and mobile network).

2. **Battery saving** (Wi-Fi, Bluetooth and mobile network).
3. **Device only** (GPS).

A history of recent location requests. You'll see a list of apps that have requested location.

Google Location service

Use **Google Location History** to retrace your steps. Google Location History will customize search results for location and search history.

Use **Google Location Sharing** to share your locations with friends and contacts in real time.

8.3.2. Join User Experience Project

"User Experience Project" is a continuous plan to improve OPPO products, features, and services. You are free to decide whether to join the project or not. If you agree to join, we will collect the related data of your usage of OPPO products, features and services, then conduct research and analysis of these information to provide you a better user experience. We will not collect any of your privacy information in this process.

Join User Experience Project. The first time you switch your OPPO phone on, it will prompt you to join User Experience Project, or you can go to **[Settings] > [Additional Settings] > [Safety & Privacy]** and toggle **[Join**

“User Experience Project”] slider to green.

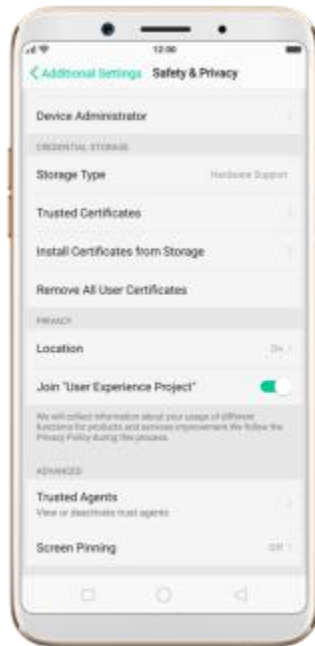

8.3.3. Security Warning

Some Android malware can spy on your activities in the background, and can take pictures or make recordings without notifying you, resulting in leaking of the information. With Security Warning function, your phone will remind you every time the malware performs these activities.

Prevent apps from taking pictures in the background. A warning window will pop up on your phone screen.



Prevent apps from making recordings in the background. If you start the sound recorder and go to another application, the status bar turns red.



8.4. Advanced--Screen pinning

Screen pinning temporarily restricts the user from leaving the task or being interrupted by notifications. Once your app activates screen pinning, your phone is restricted to only display interface of this app, you cannot see notifications, access other apps, or return to the Home screen, until your app exits the mode.

Activate screen pinning

1. Go to **[Settings]** > **[Additional Settings]** > **[Safety & Privacy]**, scroll to the bottom of the screen and turn on **[Screen Pinning]**.



2. Open the app you want to pin and click the **Overview/Menu** button to

access the multitasking tray. You can find the pushpin icon on the app preview interface. Click the icon to pin this app to your phone screen.



Unpin the screen. Touch and hold the **Overview/Menu** button until you see "Screen unpinned".

If you want to lock the phone screen directly when unpinning the screen, toggle the **[Lock device when unpinning]** slider to green.



9. Share Internet connection and files

9.1. Tether your phone's Internet connection

Using tethering you can share your phone's Internet connection with several devices, such as your computer, tablet or other gadgets. Tethering works only if your phone is connected to the Internet over the mobile data network.

Turn your phone into a personal hotspot.

1. Go to **[Settings]** > **[Other Wireless Connections]** > **[Personal Hotspot]**, then toggle the slider to green.

2. Set the hotspot name and password.

3. On another device, choose your hotspot from the list of available Wi-Fi networks.

Note: When a device is connected, a blue band appears at the top of the phone screen.

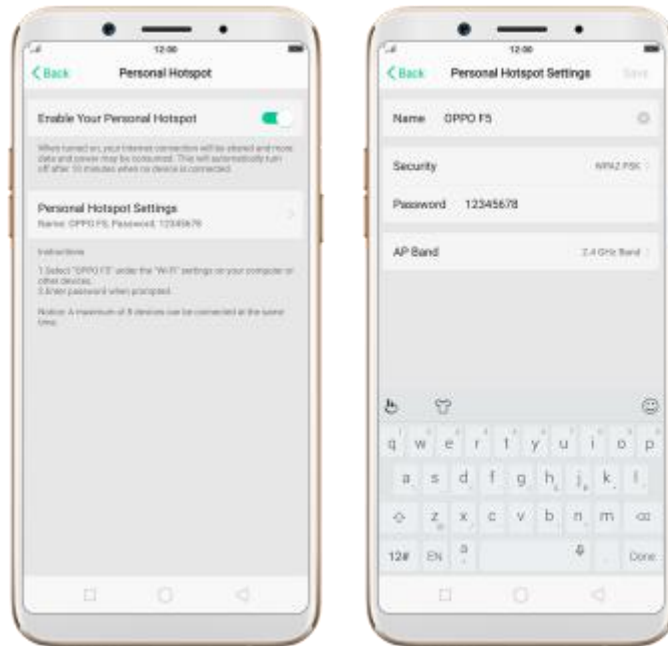

Use USB Tethering.

1. Connect your phone to your computer using the cable that came with it.
2. Go to **[Settings] > [Other Wireless Connections] > [USB Tethering]**, then toggle the slider to green.

3. In your computer's Network preferences, choose your OPPO phone, then configure the network settings.

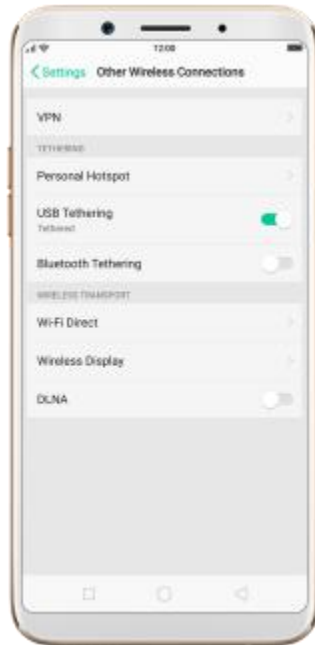

Tether via Bluetooth.

1. Go to **[Settings]** > **[Other Wireless Connections]** and enable **[Bluetooth Tethering]**.
2. In **[Settings]** > **[Bluetooth]**, pair and connect your phone with your Bluetooth device.
3. Click **(i)** next to the device's name, then click **[Internet Access]**.

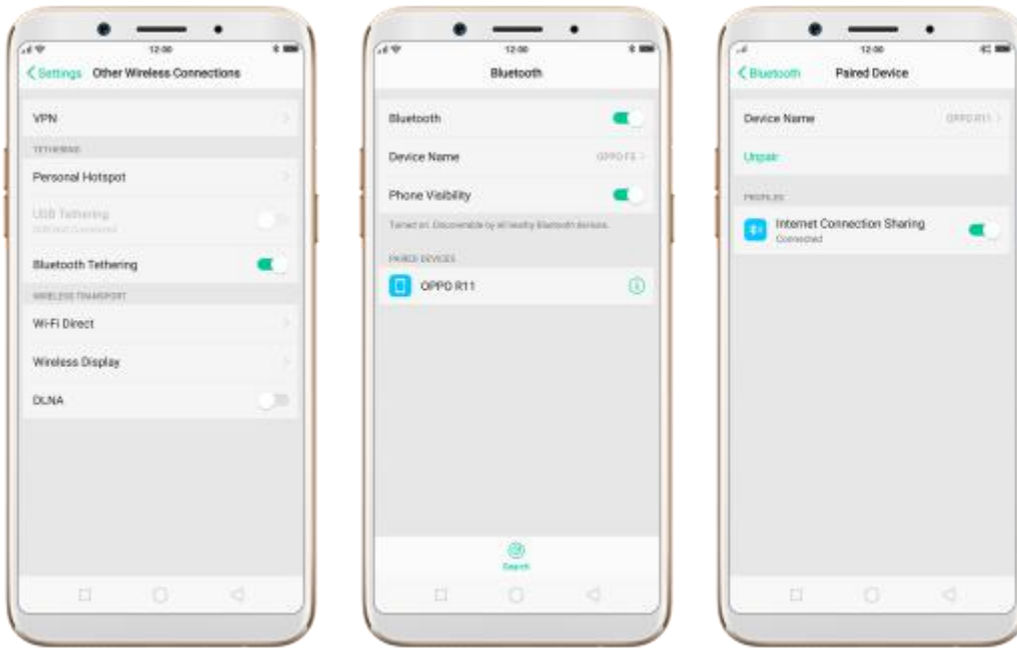

Monitor your mobile data network usage. Go to [Settings] > [Dual SIM & Cellular Data].

9.2. Share files

9.2.1. Wireless file sharing

You can share files wirelessly between wireless devices.

Use OPPO share. Share files between OPPO smartphones.

1. Open Control Center, then turn on OPPO Share on both OPPO phones.
2. Select the files to be shared and the device to share with, click Send, then click the OPPO phone's profile picture.

3. Click Receive on the other device and start sharing.



Transfer files with Clone Phone. With Clone Phone, you can transfer all the phone data from a phone to the other. See Clone Phone.

Share via Bluetooth.

1. Go to **[Settings]** > **[Bluetooth]** and enable Bluetooth. Then pair and connect your phone with your Bluetooth device.
2. Select the files to be shared, click Send, then click Bluetooth.
3. Click Accept on your Bluetooth device and start sharing.



Use Remote Management to view and download files.

1. Connect your phone and laptop to the same Wi-Fi network.
2. Click Files, click Remote Management, then click Start Service. Search the URL displayed on your phone screen with your computer, then you can view your phone's file system and download files directly to your computer. See Remote Management.

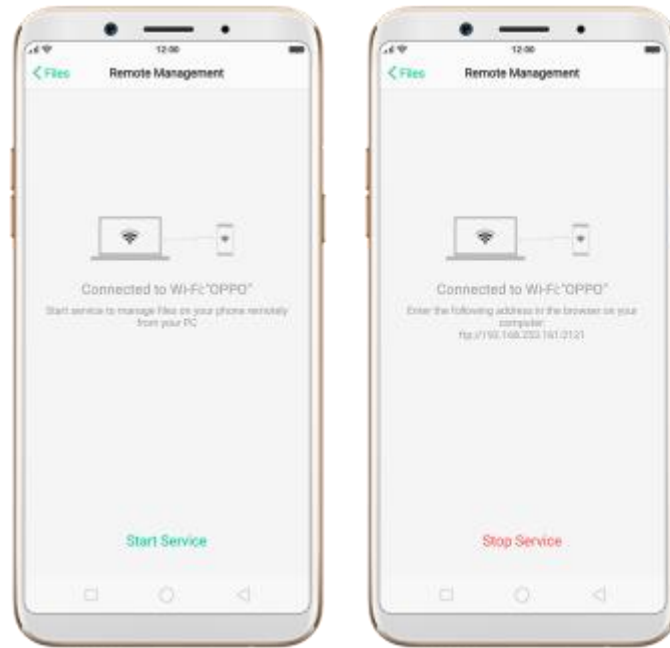

Wi-Fi Direct. Wi-Fi Direct allows devices to connect to each other directly through Wi-Fi, without a Wi-Fi network or hotspot, and without having to set up the connection. You can also use Wi-Fi Direct to share files with the help of third-party apps, such as ZAPYA.

1. Go to **[Settings] > [Wi-Fi]** and enable Wi-Fi.
2. Go to **[Settings] > [Other Wireless Connections] > [Wi-Fi Direct]**.
3. Click **Search** to start scanning for nearby Wi-Fi Direct devices. After the scan, select a device, and then follow the prompts to pair the devices.

Wireless Display. Using wireless display, you can stream your phone screen to the TV or computer which is certified with Wi-Fi Miracast technology.

Stream to computer

Notice:

1. Connect your OPPO smartphone and computer to the same Wi-Fi network.
2. The function is only supported by Win 10. For Win 8 system, you can install additional software and apps like AirServer to support.

Computer Setting

- Go to **[Settings] > [System] > [Project onto the computer]**.
- Allow projection on all locations and every time when a request comes.
- Enable the PIN code and remember your computer name.

OPPO smartphone Setting

- Go to **[Settings] > [Other Wireless Connections] > [Wireless Display]**, toggle **[Wireless Display]** to green to start searching devices.
- Select your computer name from the list and match it to your smartphone. You will see the shared screen on computer once it's connected successfully.

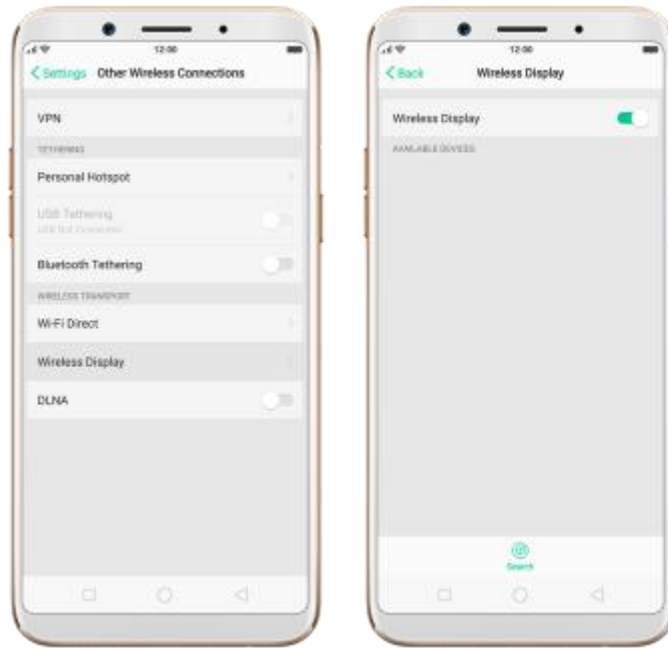

Stream to TV

- Connect your OPPO smartphone and TV to the same Wi-Fi network.
- Select your computer name from the list and match it to your smartphone. You will see the shared screen on computer once it's connected successfully.
- If you want to stream the video playing on your smartphone to your TV, you can install additional apps like IQIYI to support.

9.2.2. Wired file sharing

Transfer files between your phone and a computer.

1. Connect your phone to your computer using the cable that came with it.

2. Click phone's notification, then click File Transfer.
3. On the computer, click your phone name, click Internal shared storage, then you can copy phone files to the computer.



Transfer files with USB OTG. You can connect and add additional storage devices or USB flash drives directly to your phone using a USB OTG cable.

1. Go to **[Settings] > [Additional Settings]** and enable **[OTG Connection]**.
2. Connect a storage device to your phone using a USB OTG cable. You can directly access data on the external storage device and play movies or music without having to store them on your device.

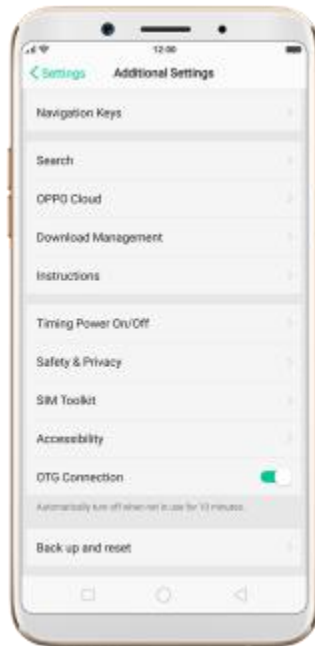

9.2.3. Share from apps

In addition to share your information from the Files app, you can also share from many other apps in your OPPO smartphone.

Share from apps. In many apps, you can click Send or  to choose how to share your information. The choices vary depending on the app you're using. Additional options may appear if you've downloaded apps with sharing options.

Take the Photos app as an example, click  and you'll see all the sharing options.



10. Restart, update, reset, and restore

10.1. Restart the phone

If something isn't working right, try restarting the phone.

Restart OPPO phone. Press and hold the Sleep/Wake button until the **Slide down to power off** message appears. Drag the power icon down to turn off the phone. To turn the phone back on, press and hold the Sleep/Wake button until you see the OPPO logo.



Force restart OPPO phone. If the phone is not responding, press and hold the Sleep/Wake and Volume Up buttons for at least 8 seconds until you see the OPPO logo.

10.2. Update your software version

You should always update your phone to the latest software. Your data and settings will not be affected.

Before you update, back up your data.

Update your OPPO phone wirelessly. Go to **[Settings] > [Software Updates]**. If an update is available, you will see **!** on the right side. Or click Software Updates to check for available software updates.

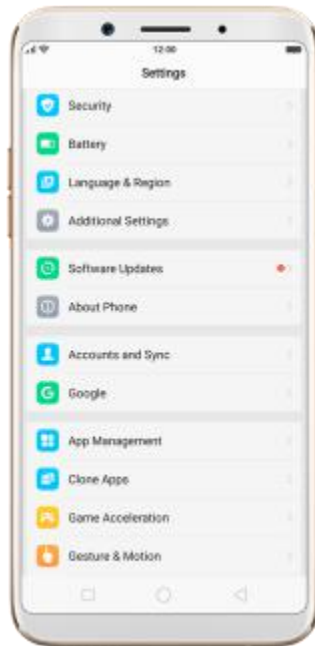

Update with SD Card (Recovery Update). Download the software to the SD card, then update your phone under the Recovery Mode.



Flash your device to update. Only used by an authorized service provider. If

your phone won't turn on or cannot enter Recovery Mode, or you forgot the lock screen passcode, go to a nearby OPPO Service Center for help.

View more details in Update the software version on your OPPO smartphone.

10.3. Backup and restore the phone

10.3.1. Back up your OPPO phone

If you use your OPPO phone on a regular basis, having a reliable backup is essential in case something goes wrong.

Use the built-in backup tool. Go to **[Settings] > [Additional Settings] > [Back up and reset]**, or click **[Tools] > [Backup and Restore]**. All your personal data, system data and applications will be backed up to phone storage.

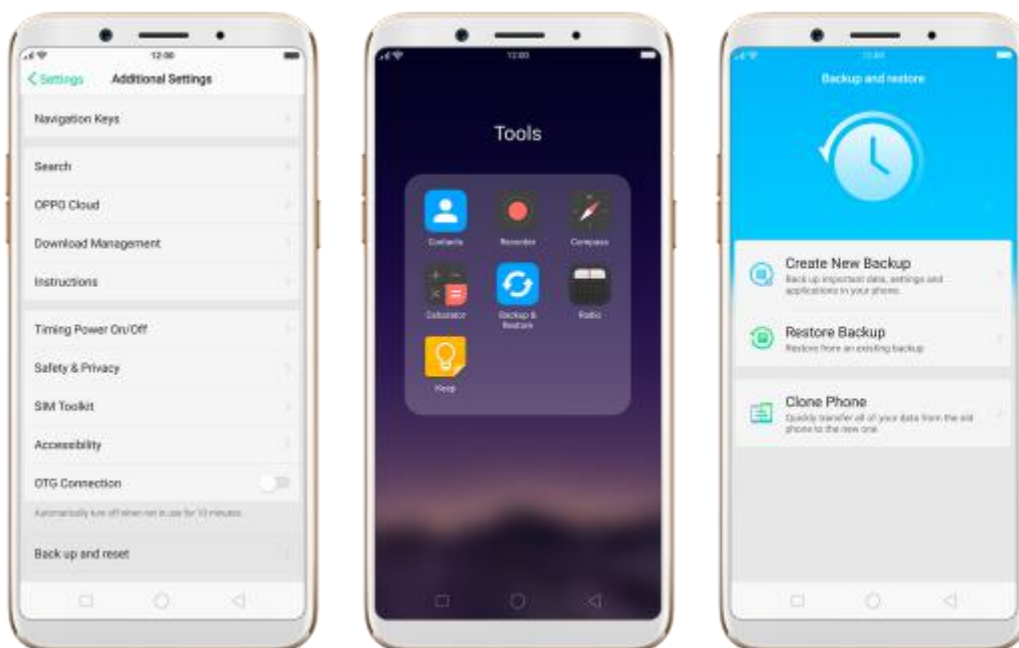

Use OPPO Cloud. OPPO Cloud allows you to back up the Contacts and SMS to the cloud drive. You need to register or sign in OPPO account first.

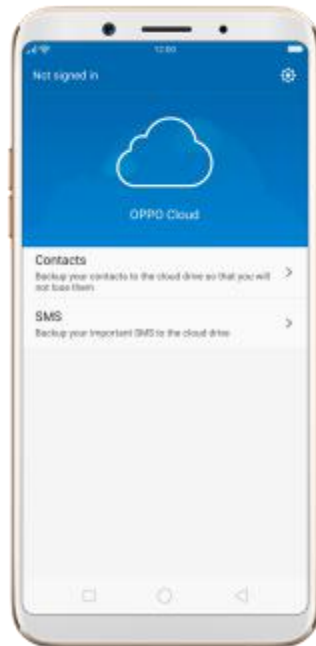

Connect your phone to a computer to create a backup on it. This is a common way to backup all your data. Don't disconnect your phone during the copy process.

View Backup your OPPO smartphone for more details.

10.3.2. Restore data on your phone

There are various methods to back up data on OPPO smartphone. Select the corresponding restoration method according to the way you make backup.

Restore your OPPO smartphone from Local backup

Before you start, make sure that you have copied and saved the data on OPPO smartphone via **[Local backup]**.

1. Go to **[Settings]** > **[Additional Settings]** > **[Back up and reset]** > **[Local backup]**, or go to **[Tools]** > **[Backup and Restore]**. You can find the data you want to restore according to its backup time.

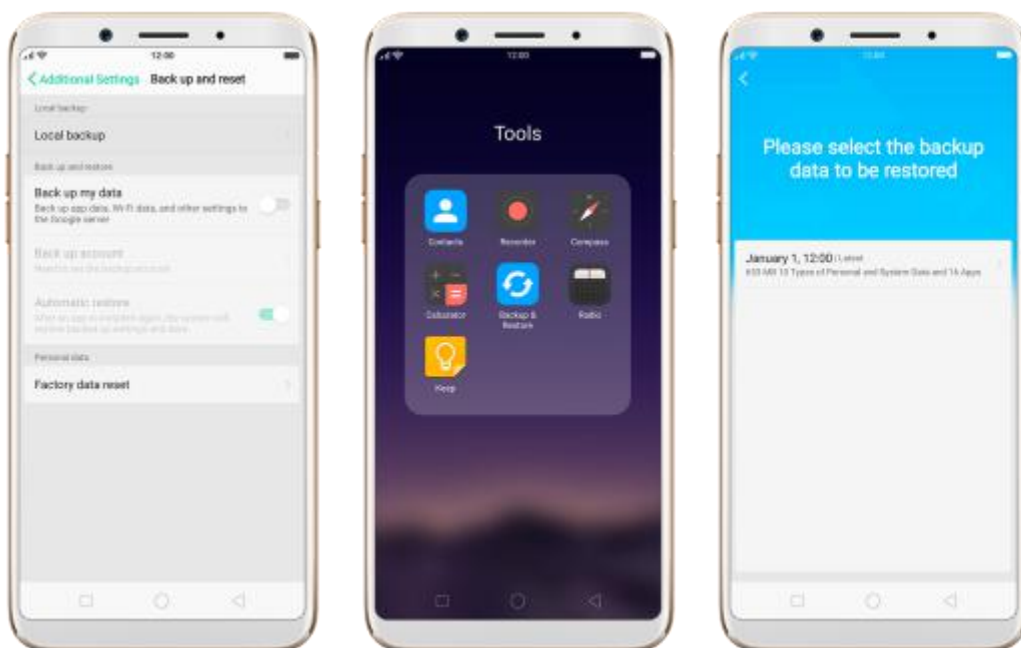

2. Select data to be restored, including Applications (Applications and Application Data), Personal Data (Contacts, Messages and more) and System Data (System Settings, Clock and more). Then start the restoration.



3. OPPO smartphone will display the progress and details till the restoration is done.

* DO NOT turn off or restart your phone during the restoration process, otherwise data may be damaged or lost.

* After restoration succeeded, you can delete the backups that are no longer needed.

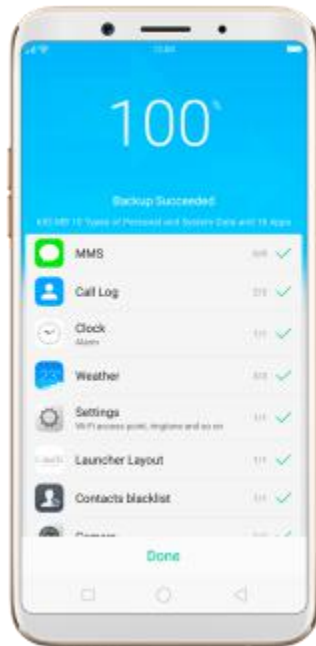

Restore your OPPO smartphone via computer

If your backup files are stored on external storage such as SD card, removable hard drive, etc., copy these files to your OPPO smartphone to complete data restoration.

Restore Contacts and SMS on OPPO smartphone from [OPPO Cloud]

If you have backed up your Contacts and SMS to OPPO Cloud, you can restore them after signing in to your OPPO account.

* To back up and restore with OPPO Cloud require network connection.



Transfer your data with [Clone Phone]

If you have switched to a new OPPO phone, you can transfer your data from old phone to your new OPPO phone through **[Clone Phone]**.

Restore your OPPO smartphone data from third-party APPs

OPPO does not recommend you to back up, transfer or restore data via third-party APPs, for they may be conflicted with OPPO system, leak personal information, or cause other safety problems.

10.4. Reset the phone

Resetting your OPPO phone will reset the phone back to its original factory

settings, and permanently erase all your personal data. You can do Factory data reset if your phone becomes lagging, has too much junk files and caches, or has issues with system or applications.

Before you do factory reset, back up all the needed data.

Reset your phone to factory settings

Go to **[Settings]** > **[Additional settings]** > **[Back up and reset]** > **[Factory data reset]**, choose an option available for factory data reset.

* Any reset option cannot be revoked once it is operated.

Reset All System Settings

This option will reset all system settings without deleting any data or media files.

Erase All App Data and Deletable Apps

This option will delete all third-party apps and app data. But the data saved by you will be kept such as photos and videos.

Erase All Content and Settings

Through this option, all data of OPPO smartphone will be cleared including contents, settings, photos and music. OPPO smartphone will be reset to inactivated initial state, which is factory state.

Erase All Contacts and Call History

By choosing this option, all the contacts and call history on the SIM card will be erased. Only the contacts on the SIM card will be preserved. Other data on OPPO smartphone will not be affected.

Erase All SMS and MMS Messages

By choosing this option, all the SMS and MMS messages on the SIM card will be erased. Only the SMS messages on the SIM card will be preserved. Other data on OPPO smartphone will not be affected.

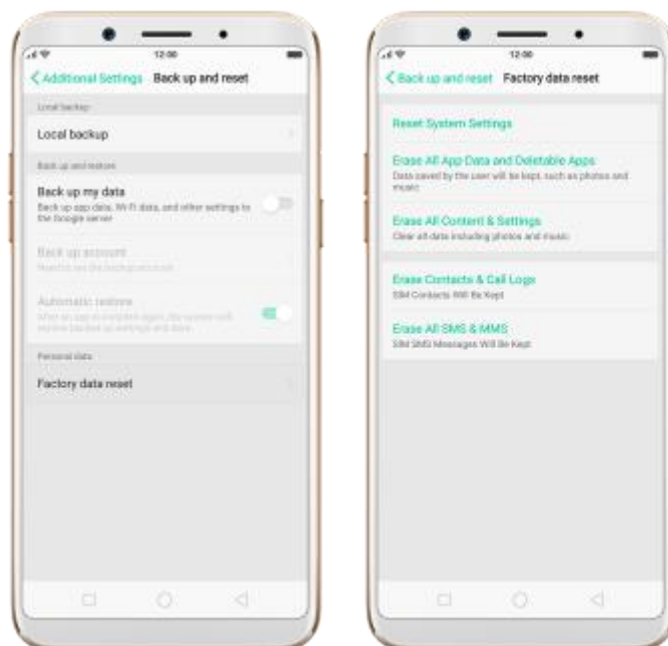

11. Accessibility

11.1. TalkBack

TalkBack helps blind and vision-impaired users to interact with the phones more easily. It uses spoken word, vibration and other audible feedback to let you know what's on your screen, what you're touching, and what you can do with it.

Turn TalkBack on. Go to **[Settings] > [Additional Settings] > [Accessibility]** and enable TalkBack.

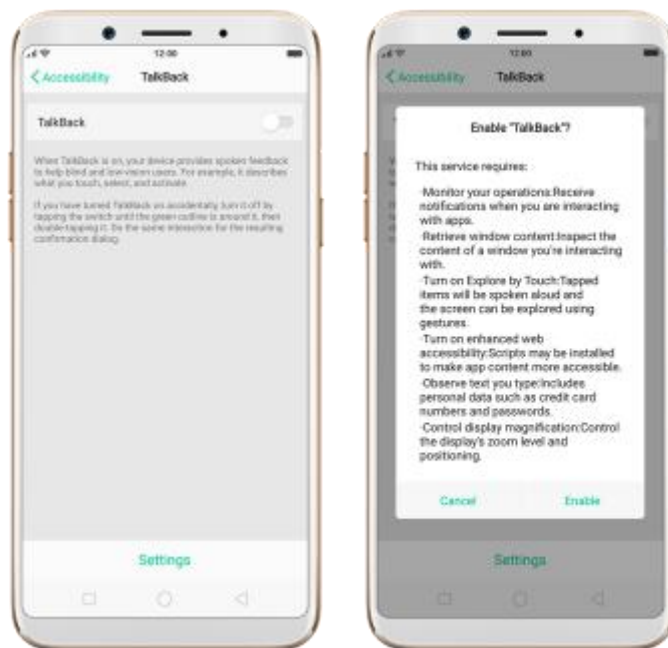

When **TalkBack** is on:

Your device provides spoken feedback to help blind and low-vision users. For example, it describes what you touch, select and activate.

You need to:

Tap the screen until you see a green outline and you can enter with double click.

Swipe upward or downward with two fingers to scroll the screen.



Turn Talkback off.

1. Press the **volume up** and **volume down** button simultaneously to suspend **TalkBack** function.
2. Turn it off in **[Settings] > [Additional Settings] > [Accessibility]**.

*You need to enter the code when you use Accessibility Features.

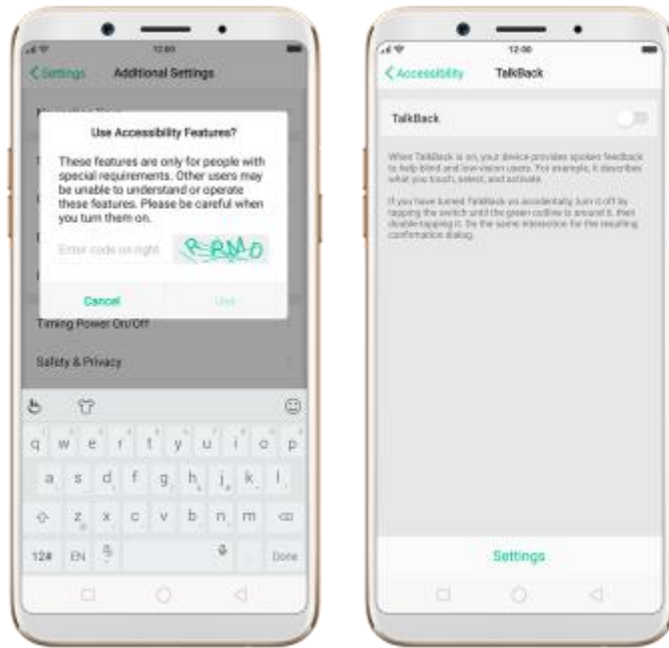

11.2. Magnification Gestures

Magnification gestures work similarly to the full screen magnifiers, which allows users to zoom in and pan the whole screen to get a closer look at screen content.

Enable magnification gestures. Go to **[Settings] > [Additional Settings] > [Accessibility]**.

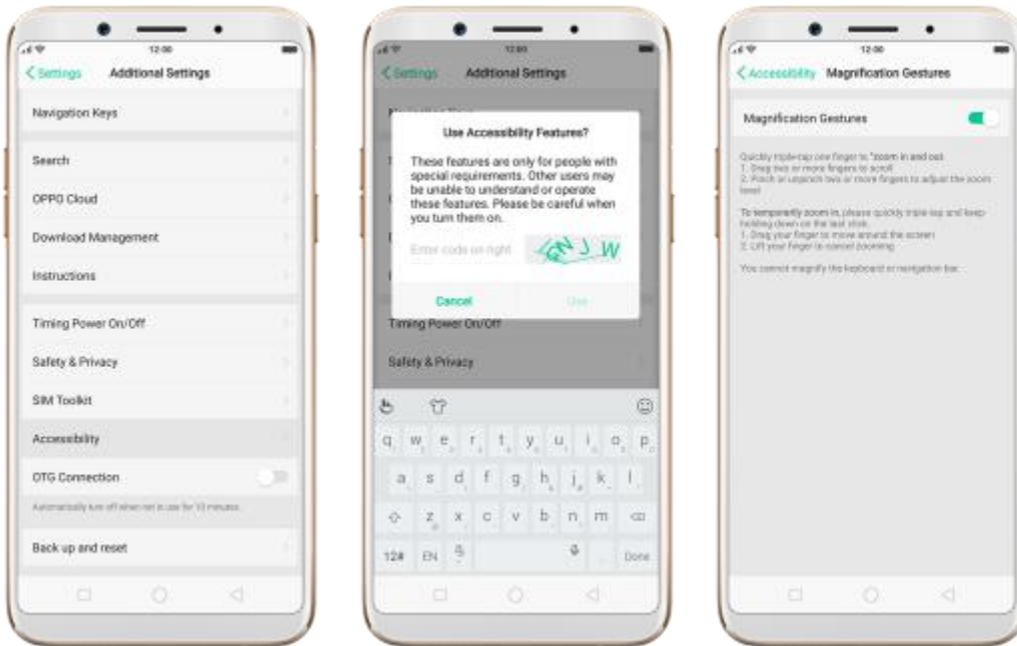

- Triple-click the screen to zoom in and out. The triple-clicking does not work well on the keyboard or on the navigation bar - if you have the magnifier running while the keyboard is shown, only the area above the keyboard will be magnified.
- Drag two or more fingers across the screen to pan across the screen.
- Pinch your fingers together or apart to adjust the zoom level.



Turn the magnifier on temporarily. Triple-click the screen and hold the third click.

- Drag one finger around the screen to move the view.
- Lift the finger to cancel zooming.
- +

11.3. End Calls with the Power Button

- In addition to end calls by clicking , you can make the Power button to take this function.
- **End Calls with the Power button.** Go to **[Settings] > [Additional Settings] > [Accessibility]**, toggle the **[Power Button Ends Call]** slider to green. Then you can end calls by clicking **Decline** or pressing the Power button.

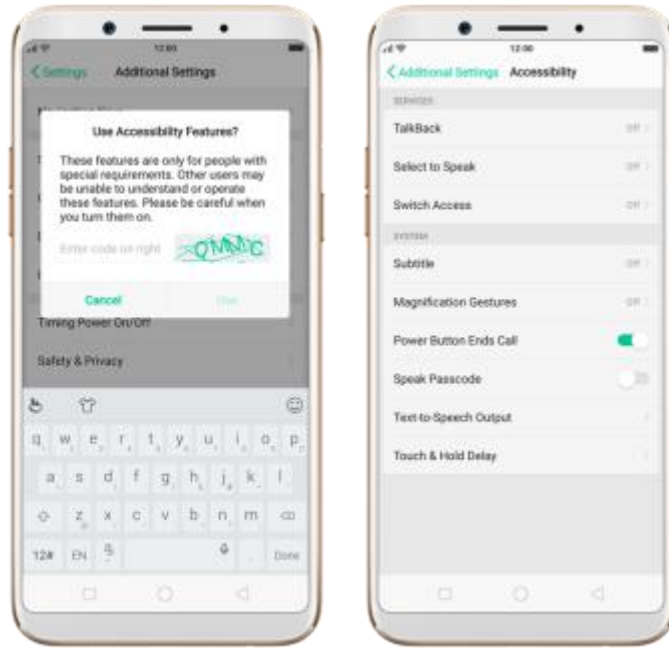

11.4. Speak password

- When you turn TalkBack on, the phone reads and tells you exactly what you are touching and typing on the screen. For your personal information safety, your password will not be read - unless you have allowed the phone to do that.
- **Allow your phone to speak password.** Go to **[Settings] > [Additional Settings] > [Accessibility]** and enable **[Speak password]**. When you turn TalkBack on and type the password, your phone will read it to you.
- **Note:** Allowing the phone to speak password means that you are now responsible for the safety of your personal information. You can turn down the speech volume to prevent password disclosure or use a headphone.

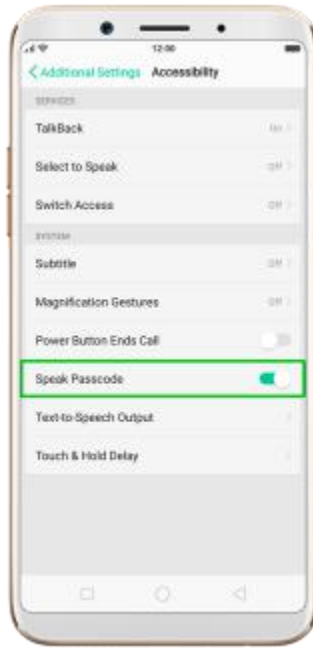

12. Safety, handling and support

12.1. Health and Safety

12.1.1. Using Environment

Keep in mind with the following rules. Switch off your phone when it is prohibited, or might cause disturbance or danger.

1. Your phone is designed to work with temperatures between 10° C to 45° C and humidity between 35% to 85%. A too high or too low temperature might affect the performance or cause damages.
2. Your phone might interfere with electronic and medical equipment. Obey the related rules and switch off your phone in these places.
3. Try not to use your phone in weak signal areas or near high-precision

electronic devices. Radio interference might lead to malfunction or other issues in electronic devices, especially pay attention when near the following devices: hearing aids, pacemakers and other medical devices, fire detectors, automatic doors and other automatic control devices.

4. In rare cases, the phone might interfere with the electronic systems in certain cars, such as the ABS anti-lock brakes and the air bag. Consult your network operator or car manufacturer before connecting the phone.

5. Before connecting to other devices, carefully read the user manual for more detailed, accurate and safety instructions. Do not connect to incompatible products.

6. Do not use your phone in rain, or near washbasins or other wet locations.

12.1.2. Battery Safety

Battery Precautions

1. Do not disassemble the built-in lithium-ion battery yourself, otherwise it might cause battery leakage, overheat, explosion and fire.

2. Do not puncture or pierce the battery with hard objects (e.g., needles and tacks) to avoid battery leakage.

3. Liquid in the battery is harmful to your skin. If liquid can be seen leaking from the battery, do not attempt to touch it. If the liquid contacts with the skin and eyes mucous accidentally, rinse immediately with water and go for a doctor if needed.

4. Do not expose the battery to extreme ambient temperatures, fire, wet locations and direct sunlight.

5. If the battery sends out strange smell, turn off your phone immediately, and send it to an authorized service provider for battery replacement. Do not attempt to disassemble or replace the battery yourself.

6. Do not charge the battery over 12 hours.

Battery Life Tips

1. **Use OPPO original accessories.** Use OPPO original charger (power adapter and USB cable) that matches your phone model. Charging with third-party or counterfeit charger accessories might impact battery lifespan or even cause security incidents.

2. **Use at a suitable temperature.** Operate your phone in a place where the temperature is always between 16° C to 25° C (61° F to 77° F). Battery life might temporarily shorten in low-temperature conditions, or irreversibly damage when temperature is higher than 45°C. The battery should be charged at a temperature range between 5° C to 40° C to avoid decreased battery performance and standby time.

3. **Do not use when charging.** Your phone might quickly get warm or even cause damage if you operate a lot during charging.

4. **Do not fully discharge your phone's battery.** Charge your phone when your battery level goes down to 10%. If phone's battery is fully discharged,

the battery could fall into a deep discharge state, which will cause it to be slightly damaged.

5. **Store the phone long term.** If you plan to store the phone for a long time, charge it to 60% or above every month.

6. **External environment.** Avoid to expose your phone battery to high or low temperature, humid environment or sun exposure.

12.1.3. Charger Usage Notes

1. Only use the charger specified by OPPO.

2. Charging voltage should be consistent with that specified on the charger.

Using mismatched voltage might cause leakage, fire and damages.

3. Do not use a power socket that is incompatible with the charger. Make sure the charger is plugged in firmly to avoid any fire hazard.

4. Do not charge your phone with a partially damaged charger, for that could result in electric shock, fire or other damages.

5. Do not charge your phone near washbasins or other water containers, or in wet locations such as bathrooms. Take care not to spill any food or liquid on your phone or charger. Do not touch chargers, cables or power socket with wet hands. In case the charger gets wet, unplug all cables, allow it to dry thoroughly before charging again.

6. Do not disassemble or modify the charger or cables yourself.

7. Do not place heavy objects on the charger, for that might cause electric

shock and fire.

8. Before cleaning the charger, unplug all cables (hold and pull the plug instead of pulling the cable, otherwise the cable will be ripped off).

9. Do not charge your phone when there is lightening or thunderstorm. Do not make phone calls while charging.

10. Avoid exposing your charger to following conditions, such as direct sunlight, temperatures lower than 5° C or higher than 40° C, damp and dusty places or that with excessive vibrations (might cause breakdowns), places near electrical appliances such as TV and radio sets (might cause interference to images and sound).

12.1.4. Traffic Safety

Use both hands when driving, and give full attention to driving and to the road. If you decide to use your phone while driving or riding a bicycle, keep in mind the following conditions:

- ▶ Safety should always come first while driving or riding a bicycle. Make sure to follow the related regulations in the area or country.
- ▶ Keep your eyes on the road. If you get an incoming call at an inconvenient time, let your voicemail answer it for you, or answer with a Bluetooth headset.
- ▶ An air bag in your vehicle inflates with great force. Do not store your phone or any of its accessories in the area over the air bag or in the air bag deployment area.

- ▶ Do not rely solemnly on the map in your phone when searching for location, buildings, directions and distance. Map routes and compass change as information provided by the service provider changes, so the map might be incorrect, incomplete or unsupported.

12.1.5. Electromagnetic (EM) Radiation

1. The Specific Absorption Rate (SAR) of this product is less than or equal to 2.0W/kg.
2. Whether you use the device close to your ears, or 2.2cm (7/8 inch) away from your body, it meets radio frequency radiation guidelines. If a phone case, belt clip or bracket is used, make sure there is no metal component, or keep yourself at the above safe distance from that. To transfer data or files, connect your device to a stable network first, or the transfer process might delay. Also keep a safe distance when transferring.
3. Under special circumstances, for example, your phone may interfere with some pacemakers, hearing aids, or cochlear implants. If persons with such implants need to use the phone, consult the manufacturer or your physician for alternatives or remedies.

12.1.6. Other Important Safety Information

1. Do not use the phone if the antenna is broken, otherwise it might cause

physical harm.

2. Keep your phone away from magnetic objects, such as magnetic cards.

Phone radiation might cause damage to floppy disks, credit cards, subway cards, phonecards, etc.

3. Keep small metal objects such as push pins away from the phone receiver.

The speaker is magnetic when used, thus can attract the small metal objects, resulting in physical injury or phone damage.

4. Do not use your phone in rain, or near washbasins or other wet locations.

A water damage is not covered in warranty service.

5. Do not puncture your phone, or hit other things with it. If your phone screen cracks, do not touch or attempt to remove the broken glass. Stop using your phone until the glass is replaced by an authorized service provider.

If the liquid leaking from the screen contacts with eyes accidentally, flush with plenty of water and go for the doctor immediately.

6. When you perform repetitive activities such as typing on your phone, you may experience occasional discomfort in your hands, arms, shoulders, neck, or other parts of your body. If you continue to have discomfort during or after such use, stop use and see a physician.

12.2. Maintenance and Repair

12.2.1. Phone Cases

Keeping your phone protected from damage should be pretty important to you. The phone case that come along with your phone can effectively mitigate your concerns.

OPPO original phone case is made of TPU material, which is lightweight and soft, and helps keep the original 'feel' of the phone, since the case is a tight-fitting overlay. It does a good job of protecting against drops and shock damage on the corners and rear of your phone, also can reduce the damage caused by extreme temperature, liquid and dust invasion, etc.

12.2.2. Screen Protector

OPPO provides you with an original HD clear screen protector made of PET material, which is a thin piece of electro-conductive film that self-adheres to your screen. It protects your screen from cracking, also does offer resistance to scratches, finger prints and abrasions. Besides, OPPO screen protector ensures high-definition and sensitiveness of the screen, which will not affect the screen display quality.

12.2.3. Maximize battery life and lifespan

Note: Rechargeable batteries have a limited number of charge cycles and

may eventually need to be replaced. It is normal for the battery to lose its capacity over time, but you can do the following to maximize its life and lifespan.

Use OPPO original accessories. Charge the phone with OPPO original power adapter and USB cable. Charging with third-party charger accessories might impact battery lifespan or even cause security incidents.

Use at a suitable temperature. OPPO smartphone battery is designed to have a good performance in a wide range of ambient temperatures, with 16° C to 25° C as the ideal comfort zone. When temperature is higher than 45°C, battery capacity will damage irreversibly, and phone might even short-circuit and burn.

Do not use when charging. Programs such as long-time calls, games or online videos will make phone get warm quickly.

Do not fully discharge your phone's battery. Charge your phone when your battery level goes down to 10%. If phone's battery is fully discharged, the battery could fall into a deep discharge state, which will cause it to be slightly damaged.

Store the phone long term. If you plan to store the phone for a long term, charge it to 60% or above every month.

External environment. Avoid exposing your phone battery to humid

environment or sun exposure.

Keep a good using habit. Some tips can help conserve the battery during daily use, such as regularly close the unneeded active apps, manage notifications and push messages, dim the screen brightness, and more.

Do not charge with a portable power bank frequently. If a power bank supplies current which is above your phone battery's capacity, then it will cause damage to your battery gradually. Make sure the power bank you buy is of good quality, and has power ratings which are suitable for your phone, basically match the current to the wall charger you use.

12.2.4. Keeping Clean

Your mobile phone could be a hotspot for bacteria, so clean your phone is of great importance. Follow these steps:

1. To clean your phone, unplug all cables and turn it off first.
2. Dip the included cleaning cloth or a soft, slightly damp, lint-free cloth in distilled water or low concentration alcohol, and shake or squeeze to remove any excess liquid.
3. Slightly wipe across your phone. Avoid getting moisture in openings.
4. Gently wipe the screen with the dry part of the microfiber cloth, but don't try to pick up all the excess water if it means pressing hard.

Do not attempt to dry your phone with an external heat source, such as a hair dryer. If impurities cannot be cleaned up, contact OPPO Service Center for

professional assistances.

12.2.5. Keeping Dry and Solving Water Damage

Do not use your phone in rain, or near washbasins or other wet locations.

Take care not to spill any food or liquid on your phone. In case your phone gets wet, follow these emergency measures:

1. Take your phone out of the liquid immediately, unplug all cables and turn off your phone.
2. If your phone has a removable battery, remove it.
3. Use a tissue or soft cloth to thoroughly adsorb water stains or liquids on the surface of your phone, and gently shake the phone in the opposite direction of liquid inflow.
4. Let your phone dry thoroughly before turning it on again. Avoid to dry your phone with an external heat source, such as a hot air hair dryer.

If your phone has a serious water damage, take your phone, warranty card and proof of purchase to a nearby OPPO Customer Center for repairs at once.

12.2.6. Use Connectors, Ports and Buttons

Never forcibly insert a connector into a port for that might cause damage, which is not covered by warranty service. Check for obstructions on the port.

If the connector and port don't join with reasonable ease, they probably don't match. Make sure that the connector matches the port and that you have

positioned the connector correctly in relation to the port.

12.2.7. Other Maintenance and Repairing Information

Mobile phones are perishable items, use with care. The following instructions might help to protect your phone:

1. Do not drop your phone or let it receive a substantial impact.
2. Do not place your phone in a microwave oven or other high voltage equipment, otherwise it might cause damages, fire or explosion.
3. Your phone contains small parts, which may present a choking hazard to small children. Keep your phone and its accessories away from small children.
4. Do not paint your phone. Paint will block the sensors and lead to phone disoperation.
5. Dirty sockets might cause poor contact or electrical leakage. Regularly clean the power socket.
6. Do not take out the SIM or SD card when transmitting or saving information, otherwise some important information might be lost.
7. Use only the supplied or approved antenna for replacement. Modified accessories might damage the phone or violate administer regulations of radio devices.

Notice

Read all safety information carefully before using the phone to ensure personal safety and proper use. Consumable parts (such as the battery and earphone) possess different warranty periods from your phone. Check with your warranty receipt for details.

12.3. OPPO Mobile Warranty Information

I. Service Terms

Thank you for using OPPO mobile phone. We will provide you with comprehensive warranty services in accordance with applicable national laws and regulations. In case of any conflict between the following policies and the National Policies, or Commissions, the national policies shall prevail.

1. Within 30 days from the purchasing date, if any performance fault listed in the Schedule "Performance Failure Table" occurs on your device, you can claim for replacement or maintenance.
2. Within 12 months from the purchasing date, if any performance fault listed in the Schedule "Performance Failure Table" occurs on your device, you can claim for maintenance. The accessories such as charger, data cable, headset and battery (including internal battery) have a 6-month warranty.
3. Make sure to fill in your phone warranty card in a complete, correct and

truthful manner. Ask the dealer to issue an invoice and keep it in a safe place.

4. Valid purchase invoice: A valid purchase invoice always indicate the serial number of the mobile phone, factory serial number (batch number) of the accessories (battery and charger), product model, sales date, seller's seal, amount and so on.

5. A valid warranty card and invoice are essential for protecting your warranty rights (Information filled in the valid warranty card and invoice shall be complete, true and correct without alteration). If you lose the valid warranty card and invoice and are unable to provide us with a photocopy of them, we will provide your phone with a 12-month warranty service beginning from the 90th day after the manufacturing date of your phone.

6. Our warranty does not cover the other accessories for the product, such as the user manual and warranty card.



Note: The above warranty is only valid for the products sold in your country. OPPO preserves the rights of final review and interpretation for the warranty policy.

II.Warranty Instructions and Conditions

1. Your warranty (refer to the Warranty Information Card) is only valid under normal use of your device. All man-made damages and any of the following conditions are out of free warranty, but a repair can be still implemented at your own cost:

- A. The warranty period has expired.
- B. Damage caused by human factors, including damages caused by operations under improper environment and the failure to the user manual.
- C. The user disassembles, repairs or modifies the device without OPPO's authorization, or has it repaired at a repair shop which is not included in OPPO's approved repair network.
- D. Damage caused by a force majeure (such as floods, fires, earthquakes and lighting).
- E. The user is unable to provide the warranty card and valid proof of purchase, or the product model and barcode do not match or are altered.
- F. Natural wear and tear parts of the product, such as casing, keypad, display screen, antenna and other accessories.
- G. Faults, damages or defects not caused by OPPO.
- H. Barcode and warranty labels are damaged or unrecognizable.
- I. Phone hardware damages caused by rooting.

2. Others

- A. External damages (including wear, tear and scratches)
- B. Faults caused by the Internet and wireless information service providers (operators) are not covered in warranty service.

C. The warranty service does not cover services verbally promised by the dealer with violate principles set forth on the warranty card. For products that can be replaced, you can go to a nearby approved warranty service center for replacement. Upon replacement, if the device fails, you will get another device of the same specification and model; if any accessory fails, you will also get a new one. Both replacements are free of charge.

3. If any of our products need to be repaired, you can take it to any warranty shop in our national warranty network.

4. If the product has water damage, or is damaged by human factors, the customer needs to sign the repair agreement form with OPPO Customer Service Center first.

5. All components, parts and accessories replaced during the warranty period shall become the property of OPPO.

III. Considerations for Sending the Device for Collection and Repair

1. When completing OPPO Mobile Phone Repair Form, the customer must fill in valid information with clear handwriting as required (name, address, phone number and fault symptoms).

2. Before sending your device for repair, back up all information and data stored on your phone (such as phone numbers, text message and

pictures) to prevent data loss. In any circumstances, OPPO Customer Service Center and its staff will not be responsible or obligated to back up or recover your information or data, or accept responsibility for any consequence arising from the loss, damage or leakage of your information and data. Ensure the legality of the information and data you have saved. To respect your privacy, we will not transmit, backup or examine your information and data (unless they are necessary for us to provide you with services), and we reserve the right to refuse to provide services for illegal contents.

3. The phone will be collected when the customer presents OPPO Mobile Phone Repair Form. In case the customer copy is lost, the customer should go through the loss reporting procedures with his/her personal ID or valid proof of identity before collecting the phone.



Note: Do not disassemble or root your phone yourself, otherwise the warranty service will be terminated immediately.