



Questo manuale d'istruzione è fornito da trovaprezzi.it. Scopri tutte le offerte per [Optoma 5752RK](#) o cerca il tuo prodotto tra le [migliori offerte di Monitor](#)



Questo manuale d'istruzione è fornito da trovaprezzi.it. Scopri tutte le offerte per [Optoma 5752RK](#) o cerca il tuo prodotto tra le [migliori offerte di Monitor](#)



Questo manuale d'istruzione è fornito da trovaprezzi.it. Scopri tutte le offerte per [Optoma 5652RK](#) o cerca il tuo prodotto tra le [migliori offerte di Monitor](#)



Interactive Flat Panel



TABLE OF CONTENTS

SAFETY	5
Safety Instructions	5
Copyright	6
Disclaimer	6
Trademark Recognition	6
FCC Statement	6
FCC Warning	6
Declaration of Conformity for EU Countries	7
WEEE	7
ENERGY STAR	7
Low Blue Light and Eye Health	7
What is Low Blue Light Technology?	7
Calculating Breaks	7
Looking at Distant Objects	7
How to Exercise Your Eyes?	7
INTRODUCTION	8
Package Contents	8
Standard Accessories	8
Optional Accessories	9
Product Overview	10
Front View	10
Rear View	11
Remote Control	12
SETUP AND INSTALLATION	14
Wall Mounting Installation	14
Wall Mount Specifications	14
Installing an External Mini Computer	17
Stand Mounting Installation (Optional)	18
Using the Remote Control	21
Installing/Replacing the Remote Control Batteries	21
Remote Control Operating Range	22
Connections	23
Connecting to Power	23
Connecting External Devices	23
USING THE DEVICE	29
Turning the Power On/Off	29
Setup Wizard	30

BASIC OPERATIONS..... 32

Home Screen Overview.....	32
OSD Menu.....	33
Shortcut Menu	34
Configuring the Image Settings	35
Configuring the Display Settings	36
Configuring the Signal Settings (for VGA input only).....	36
Configuring Audio Settings.....	37
Viewing Device Information.....	38
Android Settings Menu	39
Personalizing the System.....	39
Configuring Network Settings.....	41
Configuring Device Settings.....	43
Configuring Security Settings.....	45
Configuring System Settings	48
Side Toolbar.....	53
Viewing Recent Tasks	54
Creative Board App	55
Annotation App.....	62
Airshare	63
Screen Recorder	68
Screen Capture Tool.....	68
More Tools.....	69
Floating Annotation Toolbar	70

USING THE APPS 71

Creative Cast.....	72
Supported Operating Systems for Casting.....	72
Proprietary Sharing	72
Mobile Device.....	73
Computer.....	75
Creative Cast Settings.....	79
File Manager.....	80
Managing Files	80
Cloud Storage	82
Playing Multimedia Files.....	83
Screen Lock.....	87
Browser	87
Optoma Marketplace	88
Keeper.....	89
Joan on TV	90
Visualizer	93
Other Software	94
Reactiv Suite	94
Optoma Management Suite (OMS).....	95

ADDITIONAL INFORMATION	97
Dimensions.....	97
65-inch.....	97
75-inch.....	98
86-inch.....	99
Supported Timing List.....	100
RS232 Protocol Function List.....	102
RS232 Pin Assignments.....	102
RS232 RJ45 Control Connection	102
SET Command.....	103
GET Command	105
LED Indicator.....	107
Troubleshooting.....	108
Maintenance.....	109
Cleaning the Screen.....	109
Clean the Front Frame	109
Optoma Global Offices	110

SAFETY

Please follow all warnings, precautions and maintenance as recommended in this user manual.

Safety Instructions

- Only use attachments/accessories specified by the manufacturer.
- Do not block any ventilation openings. To ensure reliable operation of the device and to protect from overheating, it is recommended to install the device in a location that does not block ventilation. Do not put the device in an enclosure such as a book case or a cabinet that restricts air flow.
- Do not use the device near water or moisture. To reduce the risk of fire and/or electric shock, do not expose the device to rain or moisture.
- Do not install near heat sources such as radiators, heaters, stoves or any other apparatus, such as amplifiers, that emits heat.
- Do not let objects or liquids enter the device. They may touch dangerous voltage ports or short out parts that could result in fire or electric shock.
- Do not place the device on an unstable surface. The device may fall over, resulting in injury or damage to the device.
- Do not setup the device in places where it might be subject to vibration or shock.
- Do not use any hard or sharp object to operate the touch screen.
- Do not use the device if it has been physically damaged or abused. Physical damage/abuse would be (but not limited to):
 - The device has been dropped.
 - Power supply cord or plug has been damaged.
 - Liquid has been spilled on to the device.
 - The device has been exposed to rain or moisture.
 - Something has fallen in the device or something is loose inside.
- Do not attempt to service the device yourself. Opening or removing covers may expose you to dangerous voltages or other hazards. Please call Optoma before you send the device for repair.
- Disconnect the power plug from AC outlet if the device is not being used for a long period of time.
- Remove the batteries from the remote control before storage. If the batteries are left in the remote for long periods, they may leak.
- Turn off and unplug the power plug from the AC outlet before cleaning the device.
- Use a soft dry cloth with mild detergent to clean the display housing. Do not use abrasive cleaners, waxes or solvents to clean the device.
- See the device enclosure for safety related markings.
- The device should only be repaired by appropriate service personnel.

Copyright

This publication, including all photographs, illustrations and software, is protected under international copyright laws, with all rights reserved. Neither this manual, nor any of the material contained herein, may be reproduced without written consent of the author.

© Copyright 2022

Disclaimer

The information in this document is subject to change without notice. The manufacturer makes no representations or warranties with respect to the contents hereof and specifically disclaims any implied warranties of merchantability or fitness for any particular purpose. The manufacturer reserves the right to revise this publication and to make changes from time to time in the content hereof without obligation of the manufacturer to notify any person of such revision or changes.

Trademark Recognition

Kensington is a U.S. registered trademark of ACCO Brand Corporation with issued registrations and pending applications in other countries throughout the world.

HDMI, the HDMI Logo, and High-Definition Multimedia Interface are trademarks or registered trademarks of HDMI Licensing LLC in the United States and other countries.

Google, the Google logo, and Google Drive are trademarks or registered trademarks of Google LLC.

OneDrive is a trademark and brand of Microsoft Corporation.

All other product names used in this manual are the properties of their respective owners and are Acknowledged.

FCC Statement

This equipment has been tested and found to comply with the limits for a Class B digital device, pursuant to part 15 of the FCC Rules. These limits are designed to provide reasonable protection against harmful interference in a residential installation.

This equipment generates, uses and can radiate radio frequency energy and, if not installed and used in accordance with the instructions, may cause harmful interference to radio communications. However, there is no guarantee that interference will not occur in a particular installation. If this equipment does cause harmful interference to radio or television reception, which can be determined by turning the equipment off and on, the user is encouraged to try to correct the interference by one or more of the following measures:

- Reorient or relocate the receiving antenna.
- Increase the separation between the equipment and receiver.
- Connect the equipment into an outlet on a circuit different from that to which the receiver is connected.
- Consult the dealer or an experienced radio/TV technician for help.

FCC Warning

This device complies with Part 15 of the FCC Rules. Operation is subject to the following two conditions:

- (1) this device may not cause harmful interference, and
- (2) this device must accept any interference received, including interference that may cause undesired operation.

Notice: Canadian users

This Class B digital apparatus complies with Canadian CAN ICES-3 (B)/NMB-003 (B).

Remarque à l'intention des utilisateurs canadiens

Cet appareil numérique de la classe B est conforme à la norme NMB-003 du Canada.

Declaration of Conformity for EU Countries

- EMC Directive 2014/30/EU (Including amendments)
- Low Voltage Directive 2014/35/EU

WEEE



Disposal instructions

Do not throw this electronic device into the trash when discarding. To minimize pollution and ensure utmost protection of the global environment, please recycle it.

ENERGY STAR



ENERGY STAR is a U.S. Environmental Protection Agency voluntary program that helps businesses and individuals save money and protect our climate through superior energy efficiency. Products that earn the ENERGY STAR prevent greenhouse gas emissions by meeting strict energy efficiency criteria or requirements set by the U.S. Environmental Protection Agency. The following logo appears on all ENERGY STAR-certified models:

This product qualifies for ENERGY STAR in the “Standard mode” setting and this is the setting in which power savings will be achieved. Changing the Standard mode picture settings or enabling other features will increase power consumption that could exceed the limits necessary to qualify for ENERGY STAR rating. Refer to EnergyStar.gov for more information on Energy Star program.

Low Blue Light and Eye Health

What is Low Blue Light Technology?

Low Blue Light Technology reduces the blue-light component emitted by your product. The harm of blue light to human eyes is mainly manifested in the pathological harm of eyes and the harm of human body rhythm, which lead to myopia, cataract and macular disease.

Low light certification: it is a certification project to evaluate whether the display equipment meets the requirements of photobiosafety and UV free radiation safety.

Note: To meet TUV Rheinland of low blue light certificate, the display setting should be:

- Display Mode is Presentation
- Color Temperature is Standard
- Low Blue Light is 100.

Calculating Breaks

It is recommended to take a 10-minute break every hour of continuous screen use.

Note: Remember to blink your eyes often to keep them healthy and avoid dryness.

Looking at Distant Objects

During the break look at distant objects or close your eyes. This helps to relax your ciliary (focusing) muscle and avoids eye strain.

How to Exercise Your Eyes?

1. Hold your pointer finger a few inches away from your eye.
2. Focus on your finger.
3. Slowly move your finger away from your face, holding your focus.
4. Look away for a moment, into the distance.
5. Focus on your outstretched finger and slowly bring it back toward your eye.

INTRODUCTION

Package Contents

Carefully unpack and verify that you have the items listed below under standard accessories. Some of the items under optional accessories may not be available depending on the model, specification and your region of purchase. Please check with your place of purchase. Some accessories may vary from region to region.

The warranty card is only supplied in some specific regions. Please consult your dealer for detailed information.

Standard Accessories

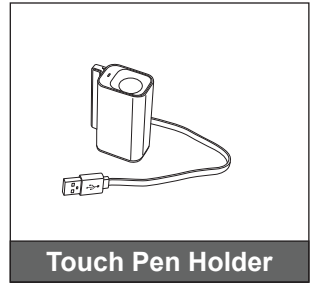
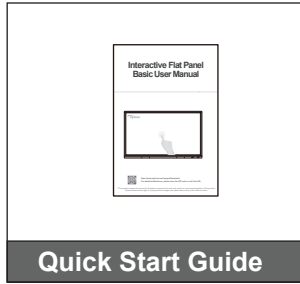
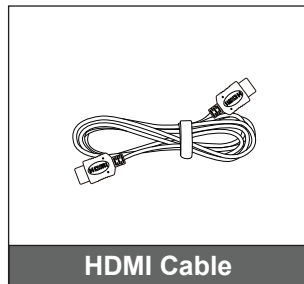
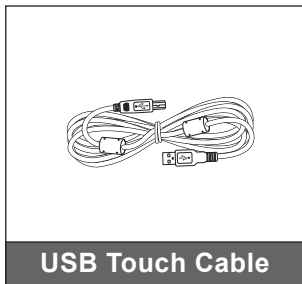
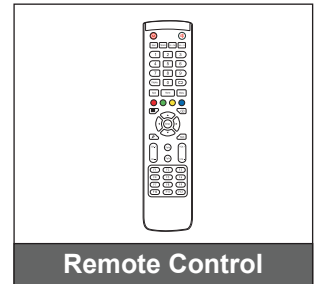
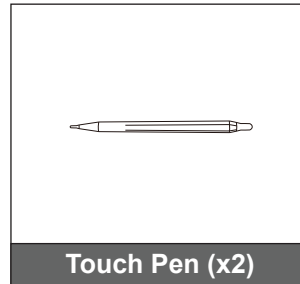
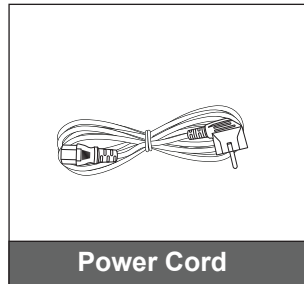
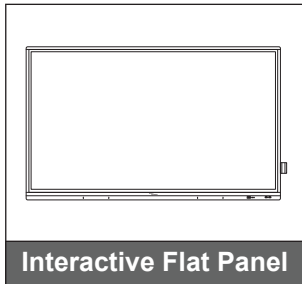

Note: For warranty information, please visit www.optoma.com.

INTRODUCTION

Optional Accessories

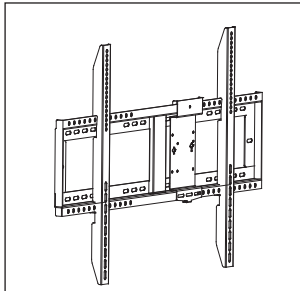

Wall Mount with
PC Vesa Bracket
(OWMFP01)

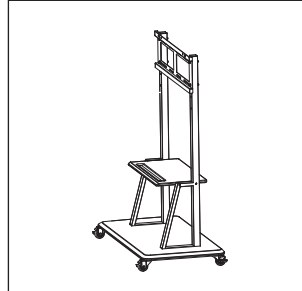

Stand Mount



Wi-Fi Dongle SI07B
(Region optional)

Note: For WiFi dongle, it varies different regions. This is for reference.

INTRODUCTION

Product Overview

Front View

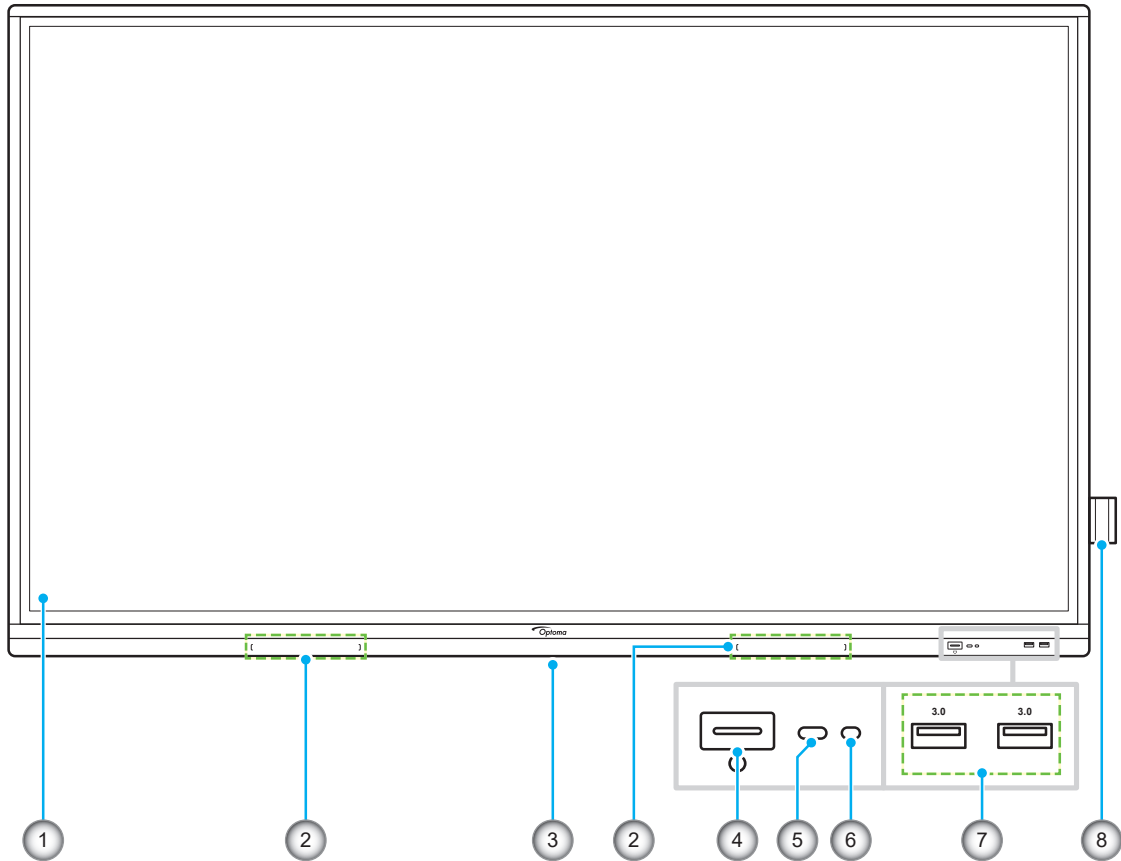

No.	Item
1.	Touch screen
2.	Touch pen placements (x2)
3.	Wi-Fi dongle slot for SI07B model only
4.	Power button with LED indicator

No.	Item
5.	IR receiver
6.	Light sensor
7.	USB 3.0 ports (x2)
8.	Touch pen holder

INTRODUCTION

Rear View

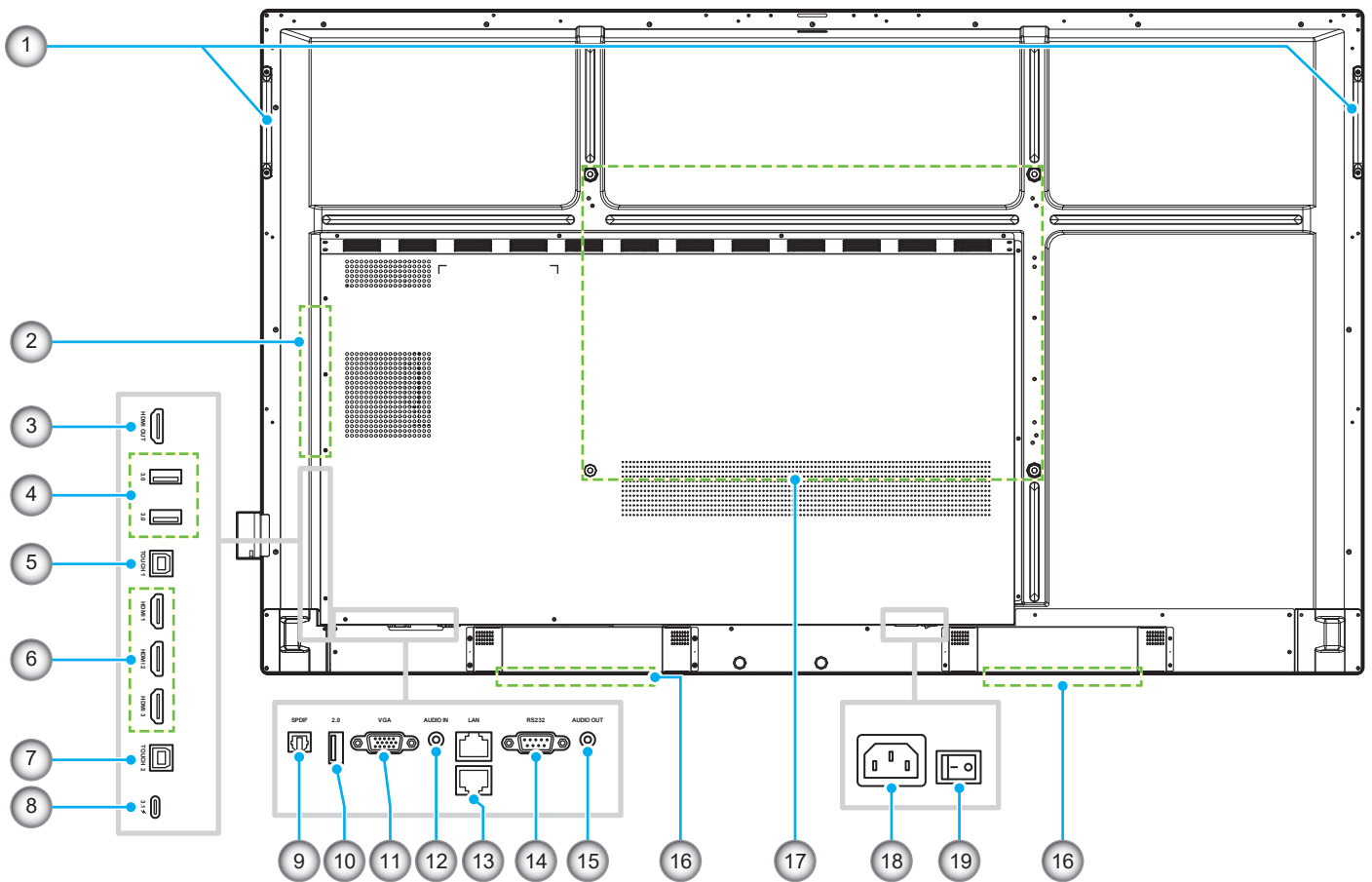

No.	Item
1.	Handles (x2)
2.	OPS slot
3.	HDMI Out port
4.	USB 3.0 ports (x2)
5.	Touch 1 USB port
6.	HDMI 1/2/3 2.0 ports (x3)
7.	Touch 2 USB port
8.	USB Type-C port
9.	SPDIF port
10.	USB 2.0 port

No.	Item
11.	VGA port
12.	Audio In port
13.	LAN port (x2)
14.	RS232 port
15.	Audio Out jack
16.	20W speakers (x2)
17.	Mounting holes for wall mount
18.	AC In socket
19.	Power switch

Note:

- Side USB 3.0 ports are full channel USB ports. USB ports can be used irrespective of the chosen input source.
- Two HDMI in ports support CEC and 1 HDMI in port supports ARC.
- USB type-C port supports DisplayPort 1.2 and power delivery (65W).
- USB 2.0 port is for firmware upgrade or for touch pen holder connection. If the touch pen holder is plugged into any of the USB 3.0 ports then the pen holder trigger function can be used only in Android mode.

INTRODUCTION

Remote Control

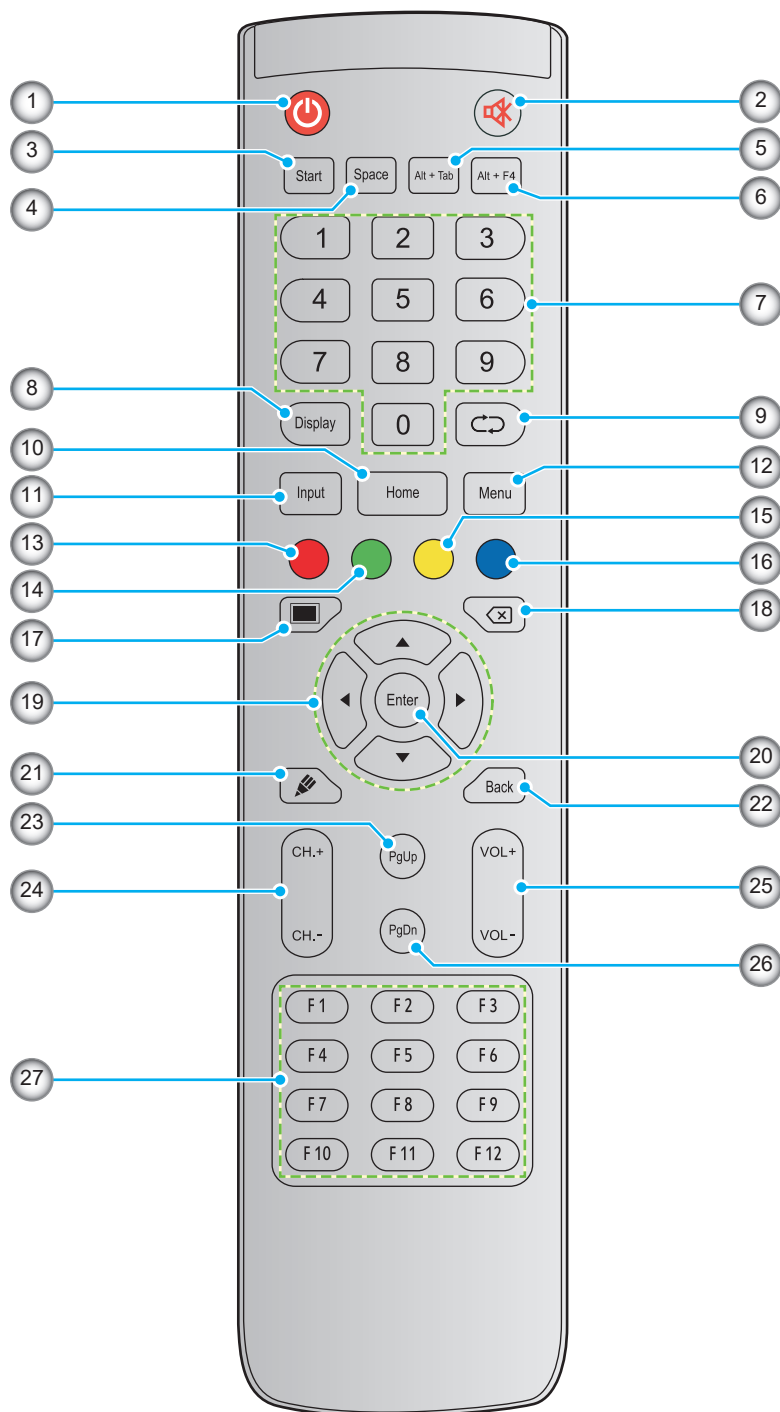

No.	Button	Description
1.	Power (🔌)	Turn on/off the interactive flat panel (IFP).
2.	Mute (🔇)	Turn off the sound temporarily.
3.	Start	Perform the same function as the Windows key on a computer keyboard.
4.	Space	Perform the same function as the Space key on a computer keyboard.
5.	Alt+Tab	Perform the same function as the Alt and Tab keys on a computer keyboard. Pressing both keys, you can switch between all open applications (windows).

INTRODUCTION

No.	Button	Description
6.	Alt+F4	Perform the same function as the Alt and F4 keys on a computer keyboard. Pressing both keys, you can close the current window.
7.	Numeric keys	Numeric input keys
8.	Display	Show the current input source and information.
9.	Repeat (↵)	No function.
10.	Home	Return to the Home screen.
11.	Input	Select the input source.
12.	Menu	Display or hide the OSD menu.
13.	Red (●)	Lock or unlock the Power button (on the IFP) and touch functions.
14.	Green (●)	Lock or unlock the Power button (on the IFP) function.
15.	Yellow (●)	Lock or unlock the touch function.
16.	Blue (●)	Freeze the screen.
17.	Blank (■)	Blank the screen.
18.	Backspace (⌫)	Perform the same function as the Backspace key on a computer keyboard.
19.	Navigation keys (▲▼◀▶)	Select an item or option.
20.	Enter	Confirm the selection.
21.	Creative Board (✎)	Launch the Creative Board app.
22.	Back	Return to the previous screen.
23.	PgUp	Perform the same function as the PgUp key on a computer keyboard.
24.	Channel keys	No function.
25.	Volume keys	Adjust the volume level.
26.	PgDn	Perform the same function as the PgDn key on a computer keyboard.
27.	Function keys (F1 ~ F12)	Perform the same function as the F1 ~ F12 function keys on a computer keyboard.

Note: If the PC module is not installed into the OPS slot, all computer-related keys will have no function.

SETUP AND INSTALLATION

Wall Mounting Installation

Use only an Optoma-approved optional wall mount kit (available separately). Kit will include the following items:

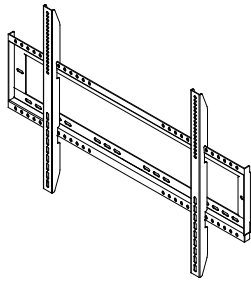

Dual mounting brackets and wall mount



Screw A (x4)



Screw B (x8)



Screw C (x2)



Anchor (x8)



Washer (x8)

Wall Mount Specifications

Model Name	VESA Grid	Screw Type & Length
65-inch	600 x 400 mm	M8*25L
75-inch	800 x 400 mm	M8*25L
86-inch	800 x 600 mm	M8*25L

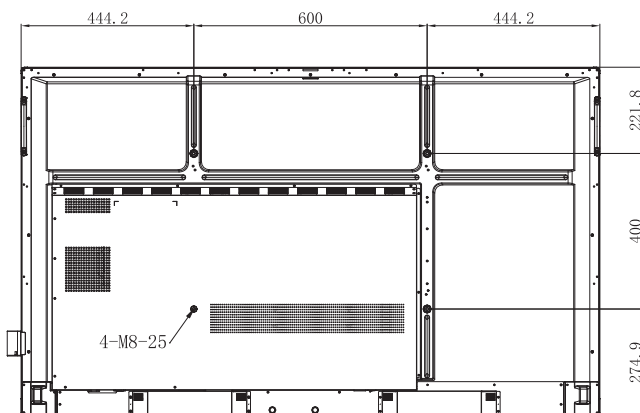

65-inch

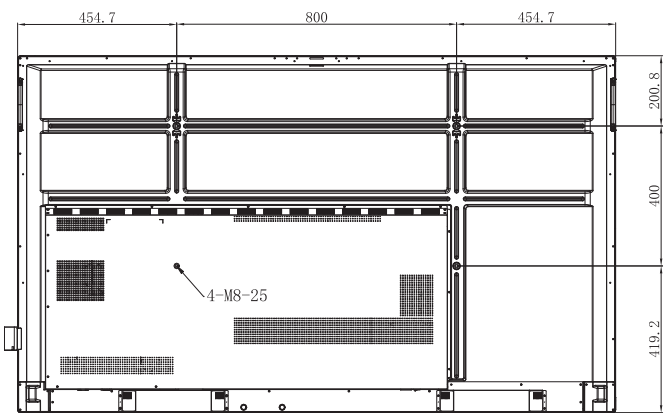

75-inch

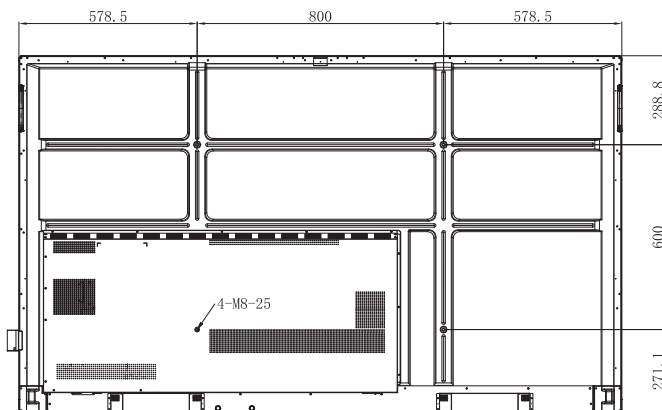

86-inch

SETUP AND INSTALLATION

To mount the IFP on the wall, complete the following steps:

1. Install the dual mounting brackets on the rear of the IFP. Then secure the brackets with four screws (A).

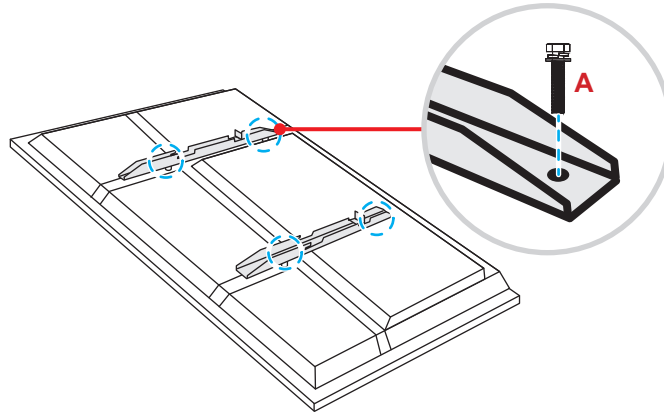

2. Drill eight small holes on the mounting location and insert the anchors into the holes.

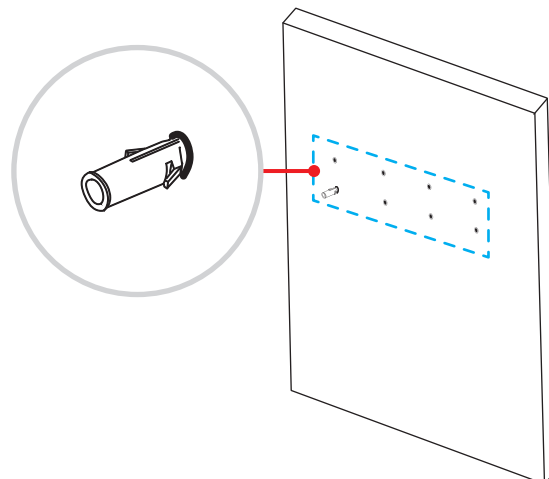

3. Position the wall mount on the wall, then secure the wall mount with eight screws (B) through the washers into the installed anchors on the wall.

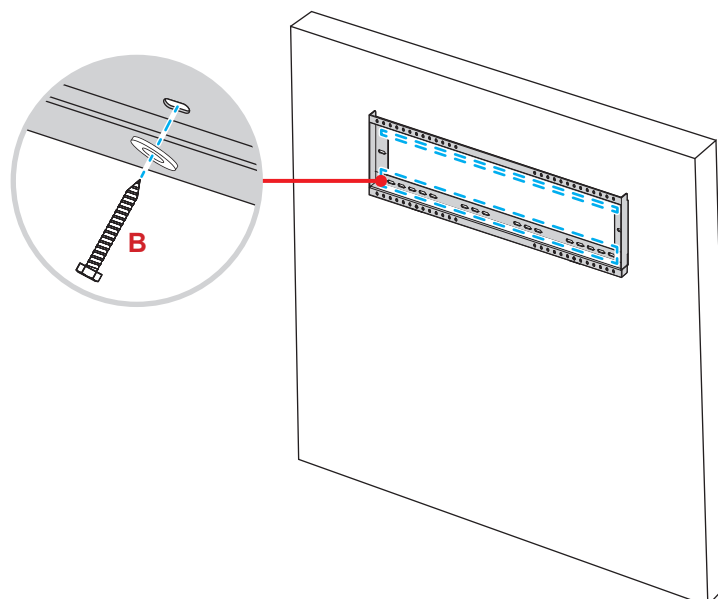

SETUP AND INSTALLATION

4. Align and hook the dual mounting brackets to the wall mount.

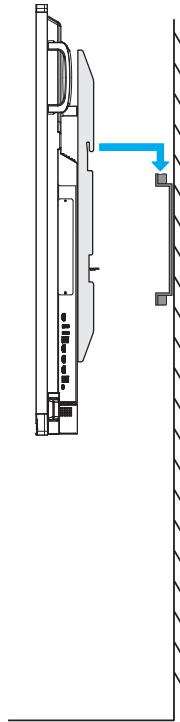

5. Secure the dual mounting brackets and the wall mount with two screws (C).

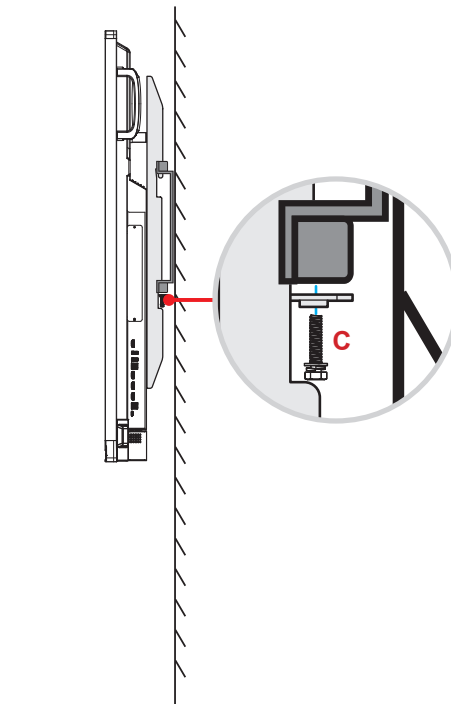

Note:

- The maximum wall mount kit load capacity: 160kg (352lbs).
- The wall mount should be installed into concrete wall to ensure installation firmness. If concrete wall is not available, we recommend to use a stand instead. Please refer to page 18.
- Screws must be tightly secured; however, to avoid damage to the mounting brackets, wall mount, or IFP, do not overtighten the screws.
- The installation should only be performed by qualified technicians. Improper installation may cause the IFP to fall or malfunction.
- Please note that damage resulting from incorrect installation will void the warranty.

SETUP AND INSTALLATION

Installing an External Mini Computer

Install the mini PC bracket on the rear side of the wall mount, then complete one of the following to install the mini computer:

- Install the screws onto the mini computer, then align and hook the mini computer to the mini PC bracket.
- Align and install the mini computer to the mini PC bracket. Then secure it with four screws.

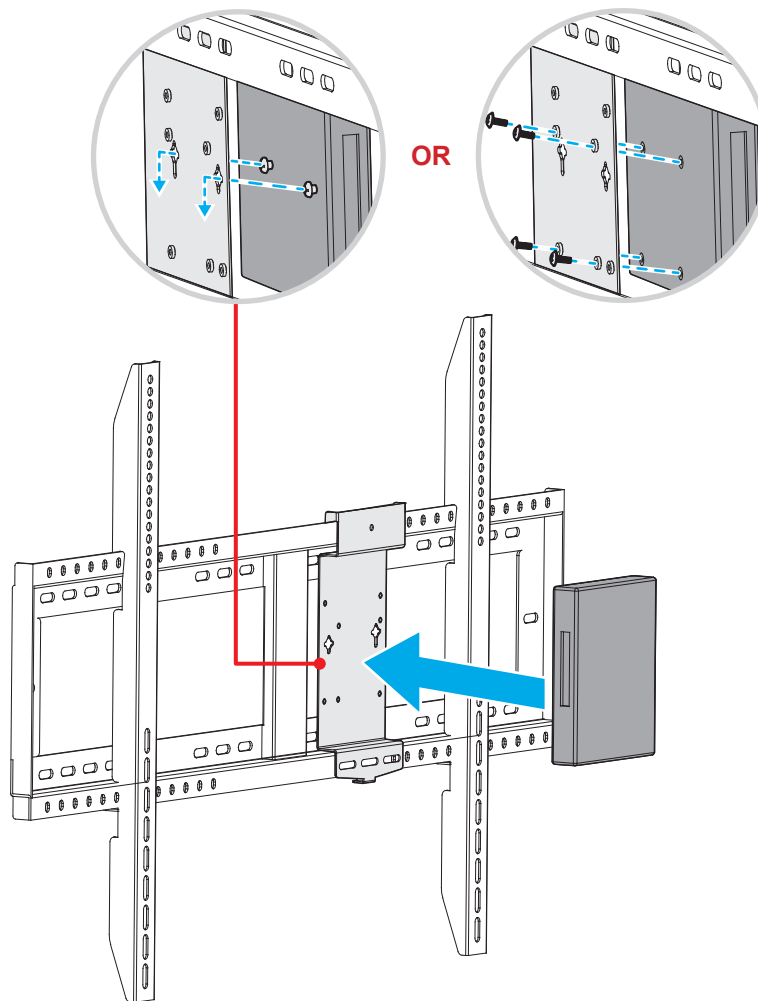

SETUP AND INSTALLATION

Stand Mounting Installation (Optional)

The stand mount kit includes the following items:

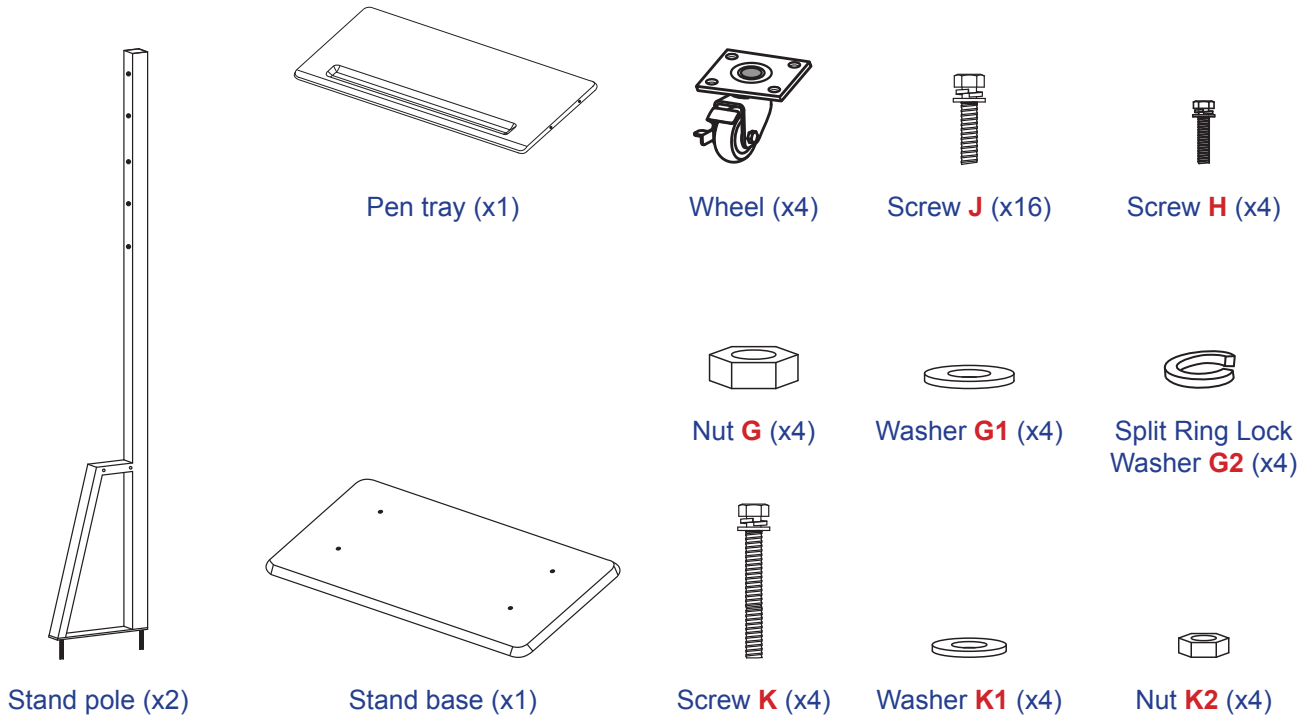

To mount the IFP on the stand, complete the following steps:

1. Install the dual mounting brackets on the rear of the IFP. Then secure the brackets with four screws (A).

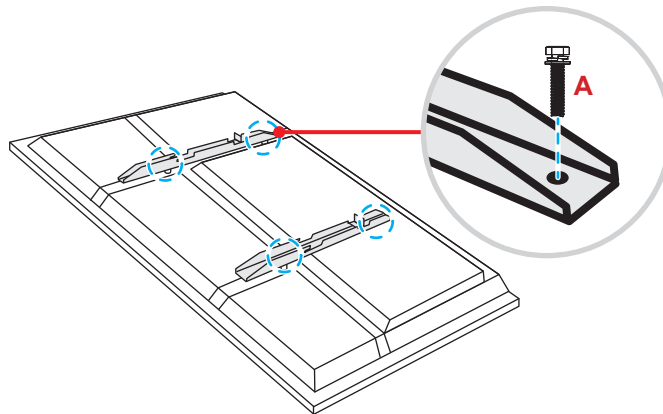

Note: Dual mounting brackets, wall mount, and screws (A) are included in the wall mount kit. Refer to “Wall Mounting Installation” on page 14.

SETUP AND INSTALLATION

2. Flip the stand base so that you can see the screw holes for the wheel, then install the wheel onto its slot and secure it with four screws (**J**).
Repeat the same procedure to install the remaining three wheels.

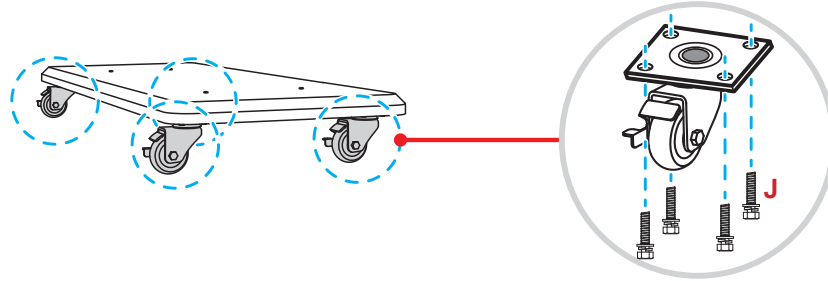

3. Place the stand base on a stable surface, then install the stand pole onto its slot and secure both standoffs with two nuts (**G**) through the washers (**G2** and **G1**).
Repeat the same procedure to install the other stand pole.

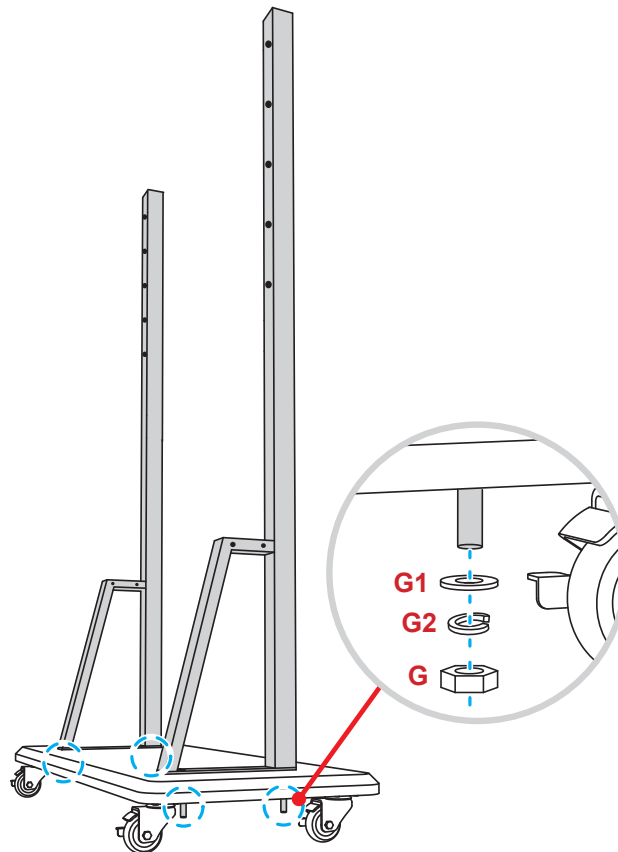

SETUP AND INSTALLATION

4. Align the pen tray with the screw holes on the middle part of the poles, then secure the pen tray with four screws (**H**).
5. Install the wall mount on the upper part of the poles, then insert the screws (**K**) through the screw holes from the rear side of the poles.
6. Place the washers (**K1**) and the nuts (**K2**) into the screws, then tighten the nuts (**K2**) to secure the wall mount in place.

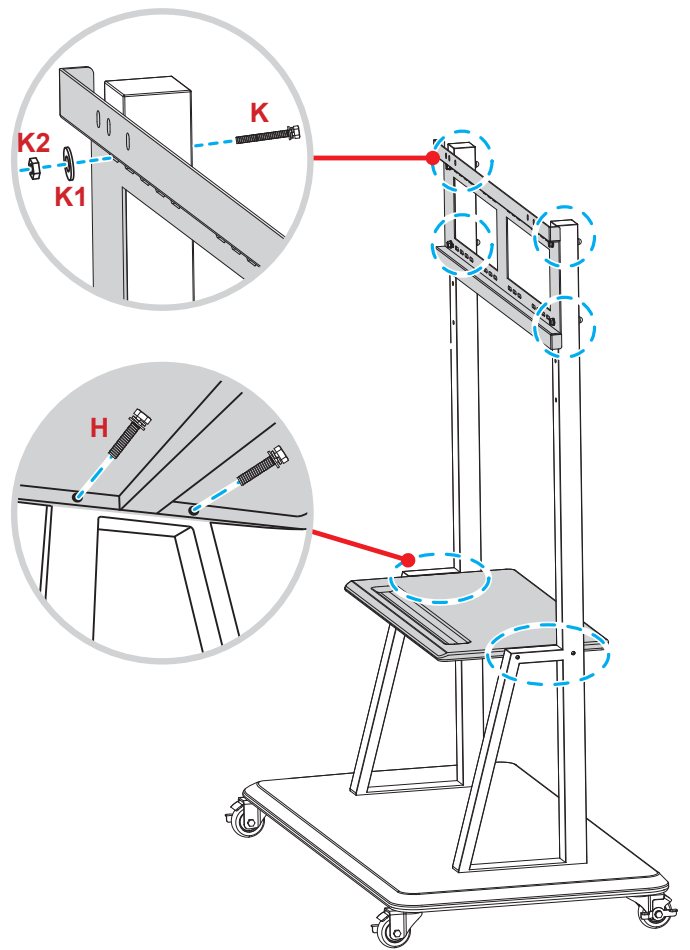

7. Align and hook the dual mounting brackets to the installed wall mount on the stand poles.

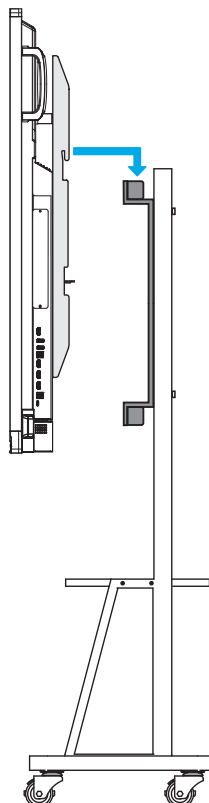

SETUP AND INSTALLATION

Using the Remote Control

Installing/Replacing the Remote Control Batteries

Two (2x) AAA size batteries are supplied for the remote control.

IMPORTANT! *Replace only with the same or equivalent type batteries.*

1. Remove the cover of the battery compartment.

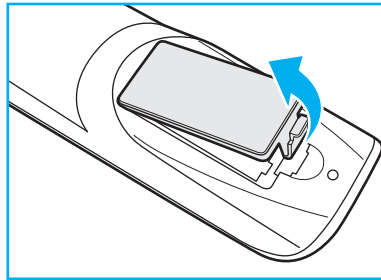

2. Insert the two batteries with correct polarity (+/-) as shown inside the battery compartment.

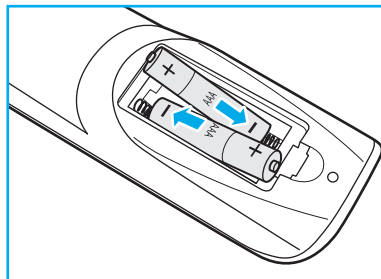

3. Replace the cover.

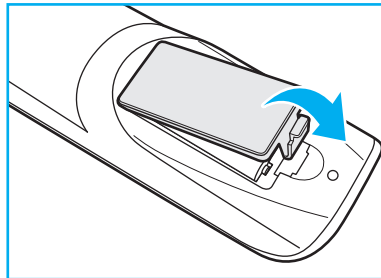

CAUTION

Improper use of batteries can result in chemical leakage or explosion. Be sure to follow the instructions below.

- Do not mix batteries of different types. Different types of batteries have different characteristics.
- Do not mix old and new batteries. Mixing old and new batteries can shorten the life of new batteries or cause chemical leakage in old batteries.
- Remove batteries as soon as they are depleted. Chemicals that leak from batteries that come in contact with skin can cause a rash. If you find any chemical leakage, wipe thoroughly with a cloth.
- The batteries supplied with this product may have a shorter life expectancy due to storage conditions.
- If you will not be using the remote control for an extended period of time, remove the batteries.
- When you dispose of the batteries, you must obey the law in the relative area or country.

SETUP AND INSTALLATION

Remote Control Operating Range

When using the remote control, make sure to point it within $\pm 30^\circ$ to the IR receiver on the IFP. The distance between the remote control and the IR sensor window should not be longer than 8 meters.

- Make sure that there are no obstacles between the remote control and the IR sensor window on the IFP that might obstruct the infra-red beam.
- Make sure the IR transmitter of the remote control is not being used in sunlight or fluorescent lamps directly.
- If the remote control is closed to Inverter-Type fluorescent lamps, it might become ineffective from time to time.
- If the remote control and the IFP are within a very short distance, the remote control might become ineffective.

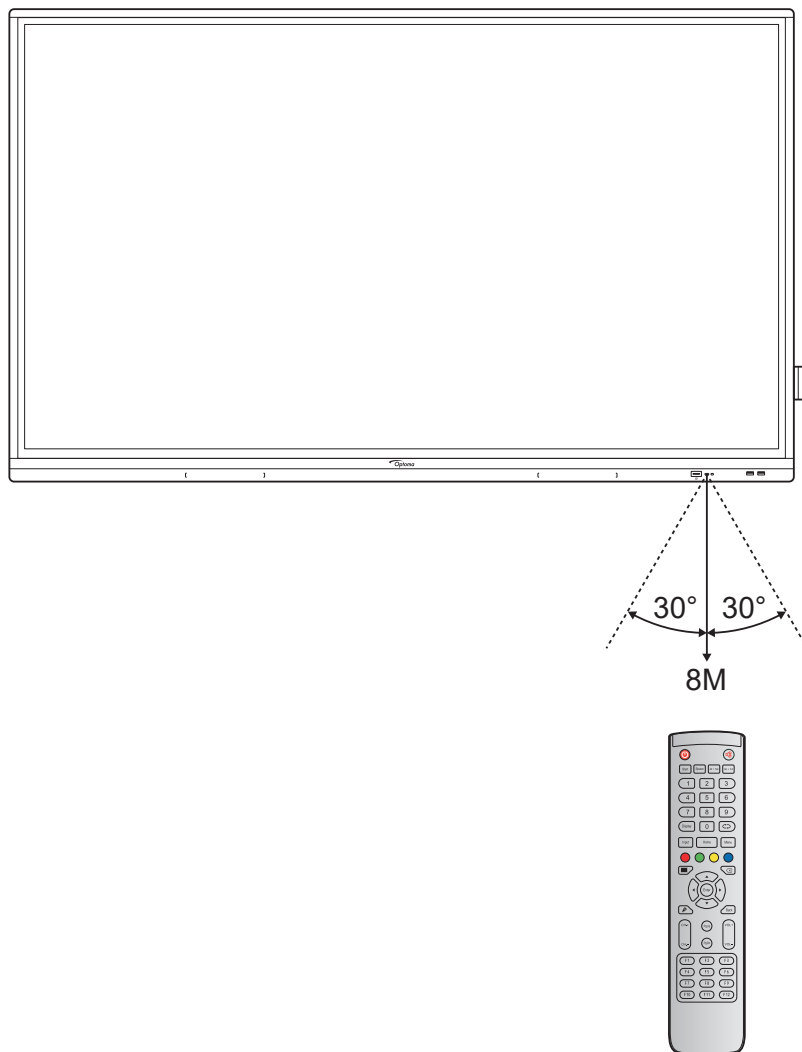

SETUP AND INSTALLATION

Connections

Connecting to Power

1. Connect one end of the power cord to the AC-in socket on the IFP.
2. Connect the other end of the power cord to a power outlet or a power supply.
3. Set the **Power** switch to ON (I). The IFP will automatically enter standby mode.



Connecting External Devices

IMPORTANT! To use the touch screen function, make sure to connect one end of the USB cable to the USB type-B TOUCH 1 or TOUCH 2 port on the IFP and the other end of the cable to the USB type-A port on your device.

HDMI input connection

- Connect your computer to the IFP using an HDMI cable.

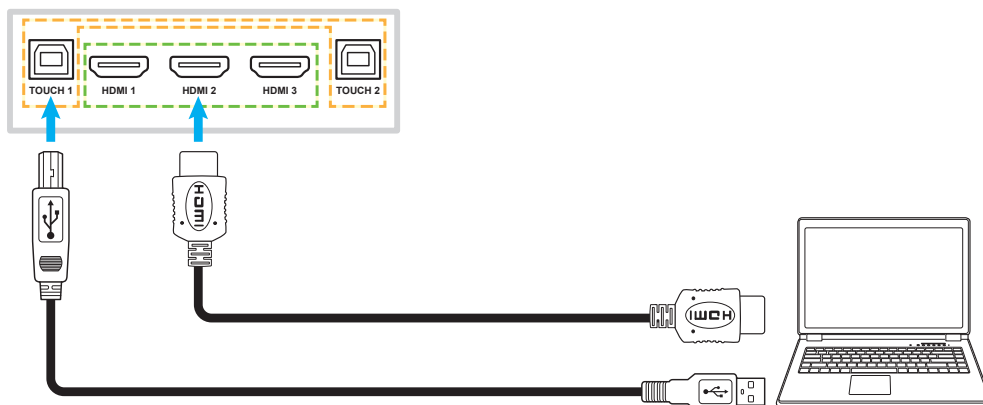

- Connect your video source to the IFP using an HDMI cable.



SETUP AND INSTALLATION

VGA input connection

Connect your computer to the IFP using a VGA cable.

Note:

- For audio input, connect one end of an audio cable to the AUDIO IN jack on the IFP and the other end of the cable to the audio jack on your computer.
- For touch function, connect one end of the USB cable to the TOUCH 2 port on the IFP and the other end to the USB port on your computer.

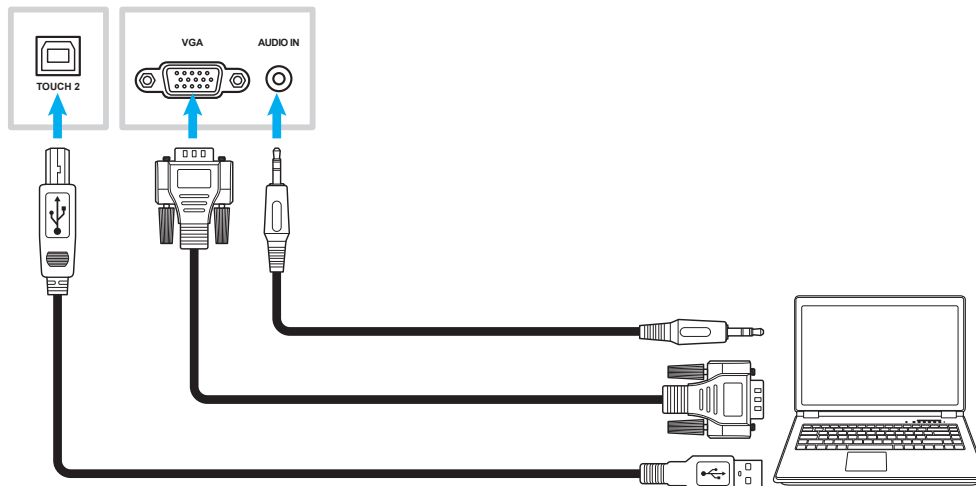

USB type-C connection

Connect your computer to the IFP using a USB type-C cable.

Note:

- USB type-C can be used to transmit audio, video and touch signals.
- The USB type-C port also supports power delivery and will output 65W.

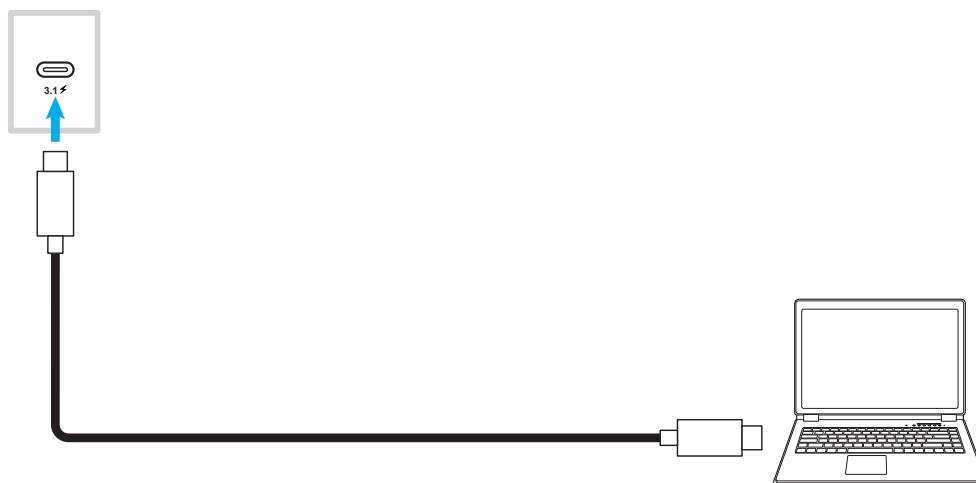

SETUP AND INSTALLATION

Audio output connection

Connect your external speakers to the Audio-out port on the IFP.



SPDIF connection

Connect your audio equipment to the IFP using a SPDIF cable.

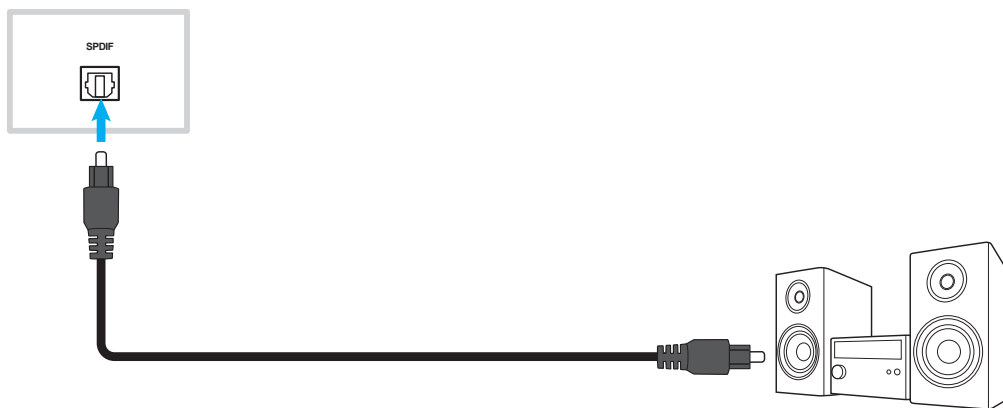

HDMI output connection

Connect your projector to the HDMI out port on the IFP.

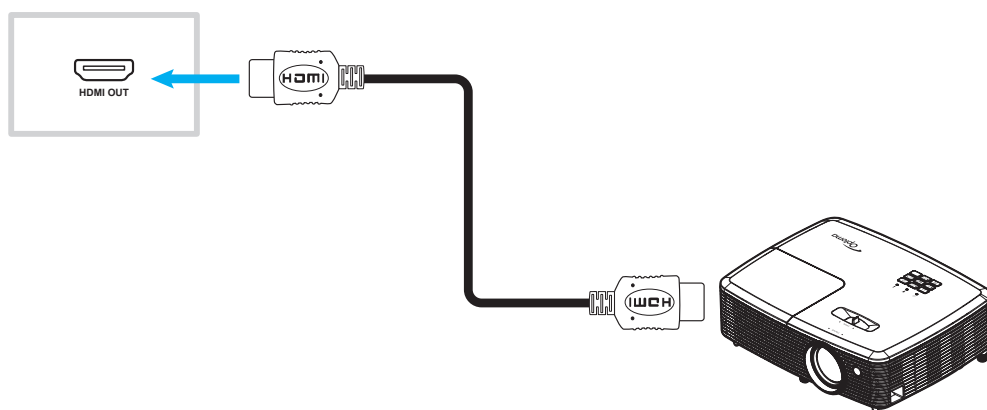

SETUP AND INSTALLATION

USB connection

Connect your USB peripheral device to the IFP using a USB cable.

Note:

- For the USB flash drive connection, simply plug it into one of the available USB ports.
- USB 2.0 port is reserved for firmware upgrades and the USB quick-draw pen holder.

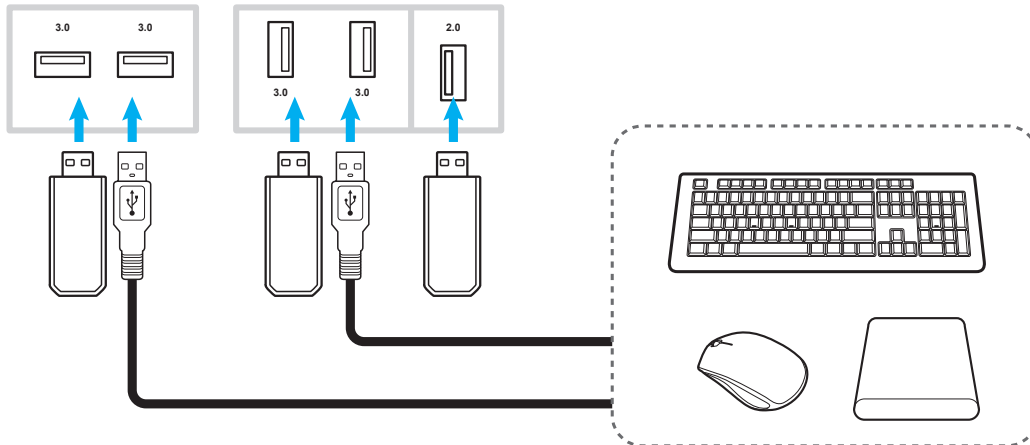

RS232 connection

Connect your computer to the IFP using a RS232 cable.

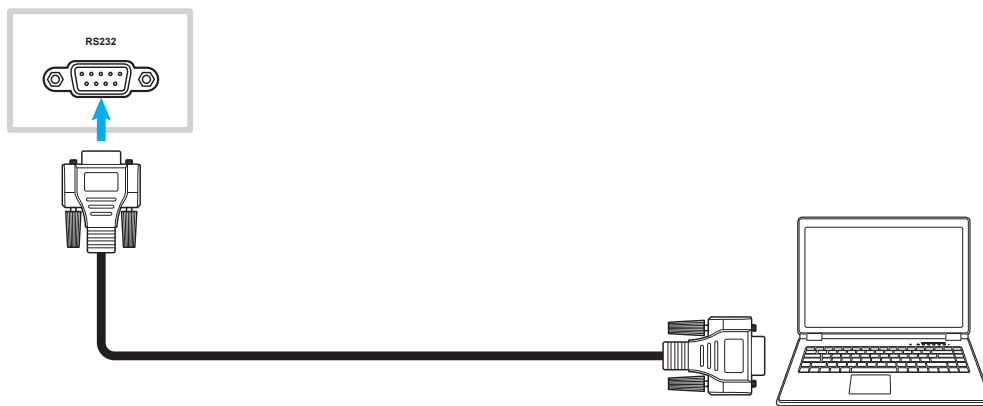

LAN connection

Connect your router to the IFP using an Ethernet cable.



Note: To configure network settings, refer to “Configuring Network Settings” on page 41.

SETUP AND INSTALLATION

Wi-Fi connection

For Wi-Fi connection, you need to install a Wi-Fi dongle to the Wi-Fi slot on the bottom of the IFP. Wi-Fi dongle can receive the signal in an area where there is a Wi-Fi network.

To install the Wi-Fi dongle (model: SI07B), complete the following steps:

1. Remove two (2) screws from the Wi-Fi slot bracket.
2. Remove the Wi-Fi slot bracket.

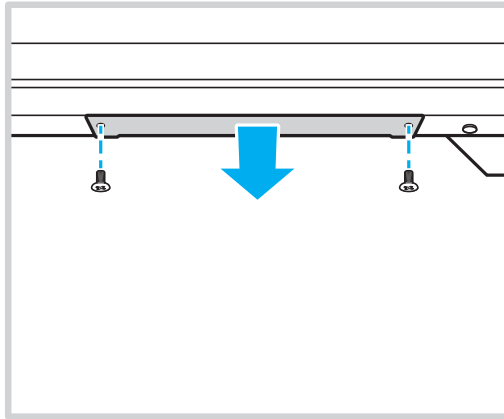

3. Insert the Wi-Fi dongle to the Wi-Fi slot on the IFP.

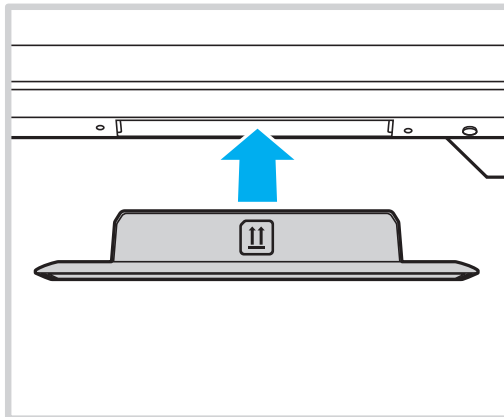

Note: To configure Wi-Fi settings, refer to “Configuring Network Settings” on page 41.

SETUP AND INSTALLATION

Touch pen holder connection

To install a holder for the touch pen, complete the following steps:

1. Attach the magnetic touch pen holder to the rear side of the screen.
1. Connect the USB cable of the touch pen holder to an available USB port on the IFP.

Note: *If the touch pen holder is plugged into the USB 2.0 port then the pen holder trigger function can be used for multiple sources. If the touch pen holder is plugged into the USB3.0 port then it can be used only with Android source.*

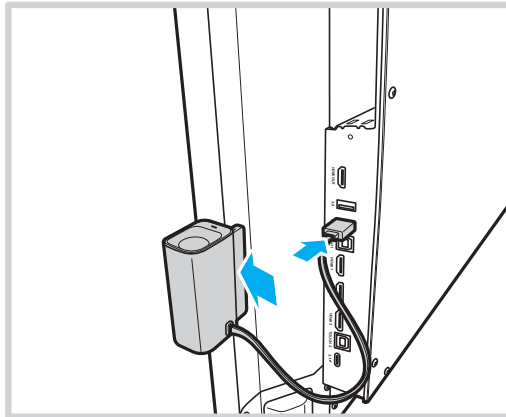

2. Insert the touch pen to its holder.

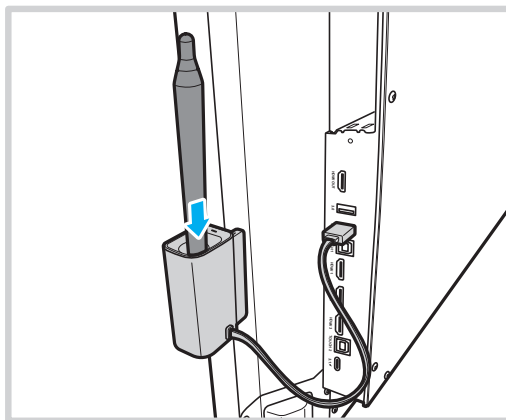

Note: *If the IFP screen is on the Home screen, then removing the touch pen from its holder launches by default the **Creative Board**. To customize the pen holder trigger action, refer to the setup instructions for this feature (page 44) under the Configuring Device Settings section.*

USING THE DEVICE

Turning the Power On/Off

Powering on

Note: After the power cord is properly connected, make sure the **Power** switch is set to ON (I).



Press the **Power** button to turn on the IFP. The LED indicator light turns white, indicating it is ready to use.

Note: You can also press the  button on the remote control to turn on the IFP.

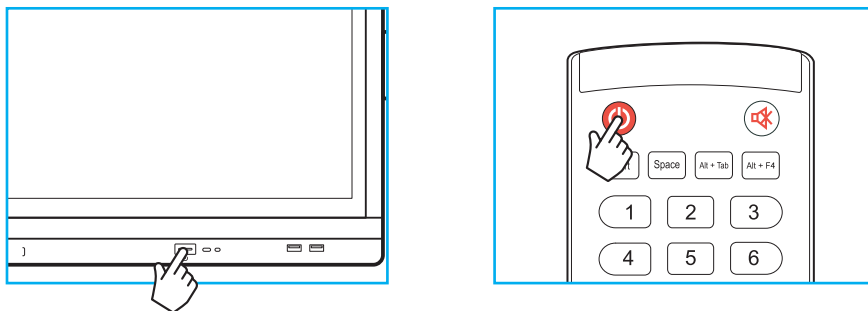

Powering off

Press the **Power** button for 3 seconds to turn off the IFP. Press **OK** at the prompt to turn it off immediately or wait for 10 seconds until the IFP turns off automatically.

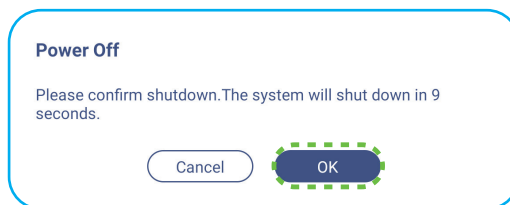

When the LED indicator light turns red, this indicates that the IFP has entered standby mode.

Note:

- You can also press the  button on the remote control to turn off the IFP.
- The IFP still consumes power when it is in standby mode. It is highly recommended to unplug the power cord from the power outlet if the IFP will not be used for an extended period of time.

USING THE DEVICE

Setup Wizard

The Setup Wizard will appear on the screen when you turn on your IFP for the first time.

Note: This IFP is equipped with a touch-sensitive screen. You can simply tap the touch screen to operate your IFP.

1. Select the language for the on-screen display (OSD) menu. Select **Next** to continue.

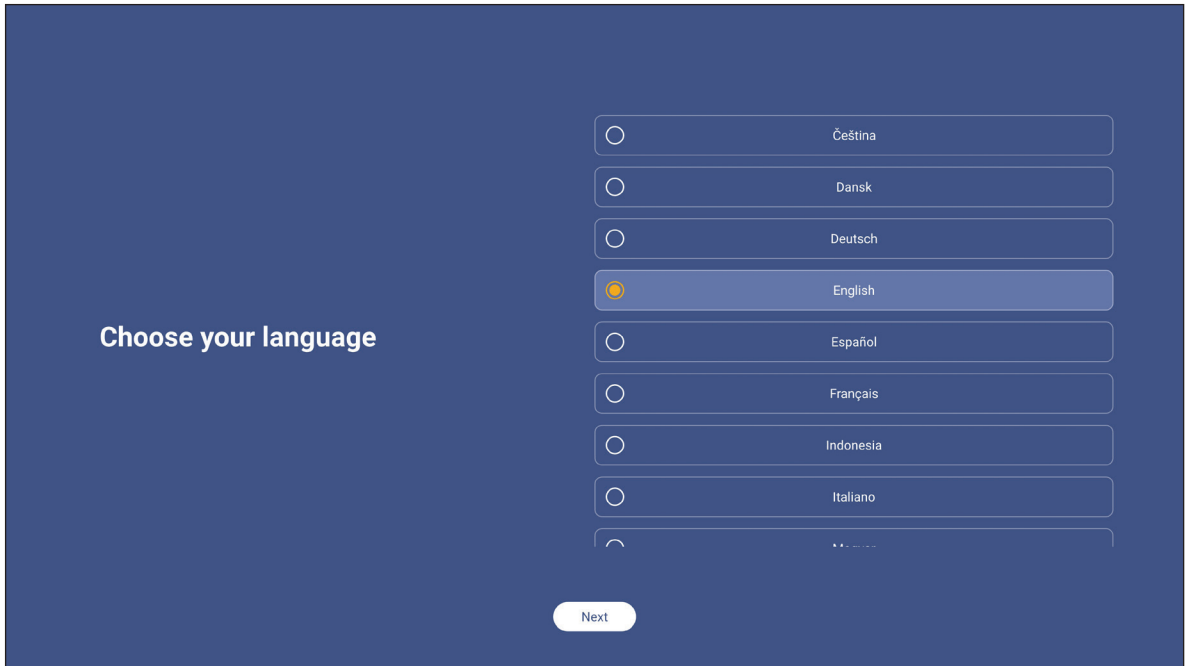

2. If you want to connect your IFP to the Internet wirelessly, select one of the available networks and tap **Connect**. Otherwise, select **Skip**.

IMPORTANT!

- To connect to a wireless network, make sure the Wi-Fi dongle is properly plugged into the Wi-Fi dongle slot. Refer to page 27.
- If you are connecting to a secure network, you will need to enter the password when connecting for the first time only.

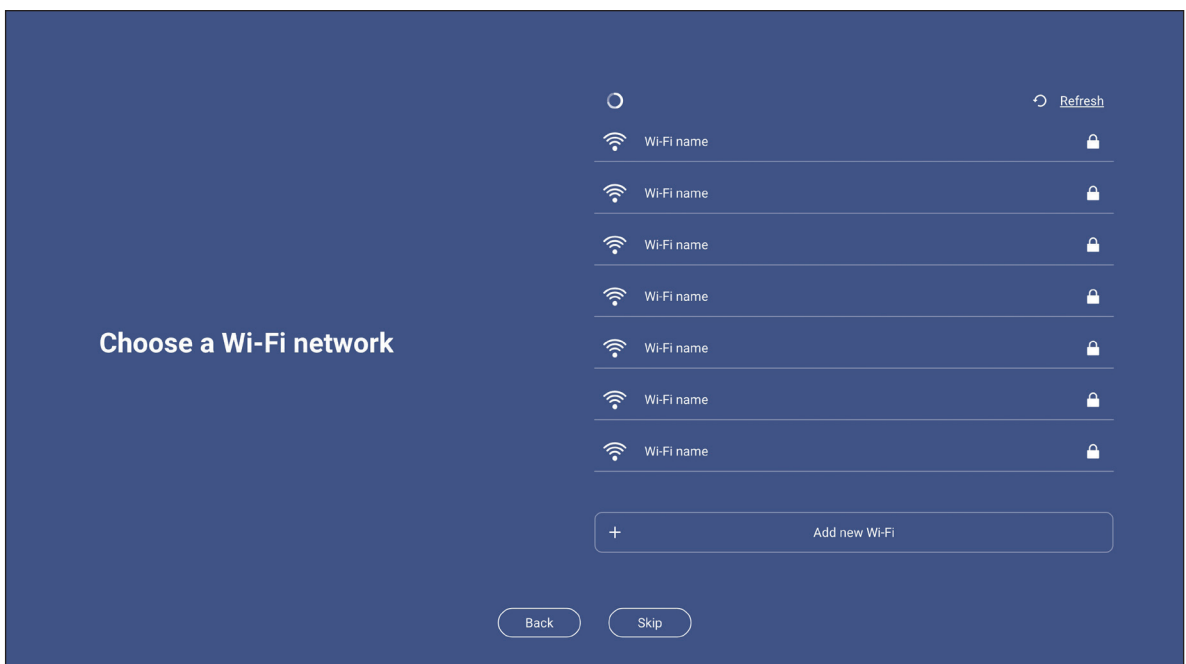

USING THE DEVICE

3. Configure the date and time related settings. Select **Next** to continue.

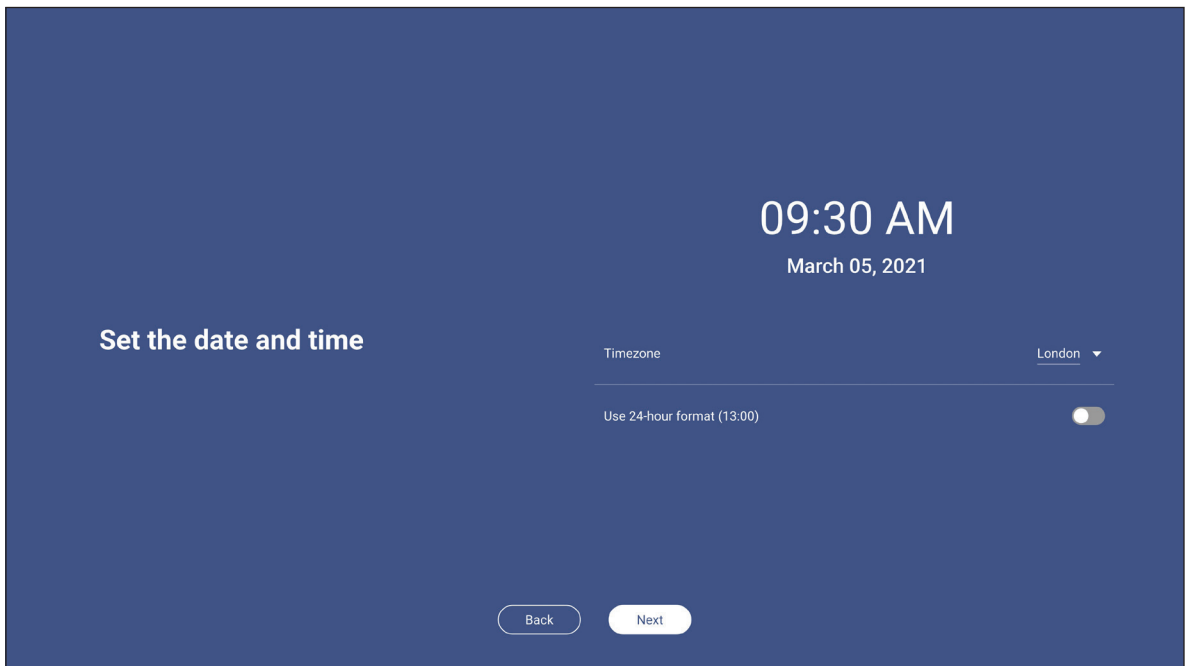

4. Read Optoma's legal policies, including Terms and conditions of use, Privacy policy, Cookie policy, and Open source. Check the **I agree to Terms and conditions, Privacy policy, Cookies policy and Open source** radio button and then select **Next** to complete the setup. The IFP is now ready to use.

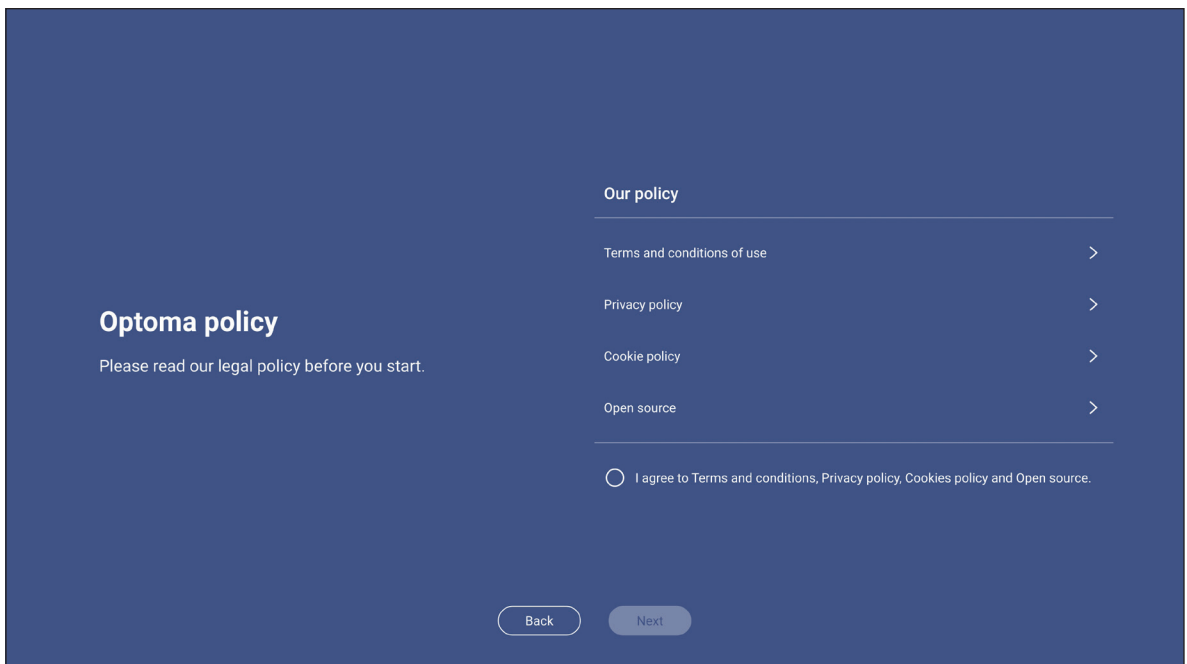

BASIC OPERATIONS

Home Screen Overview

Home screen is displayed every time you start the IFP.

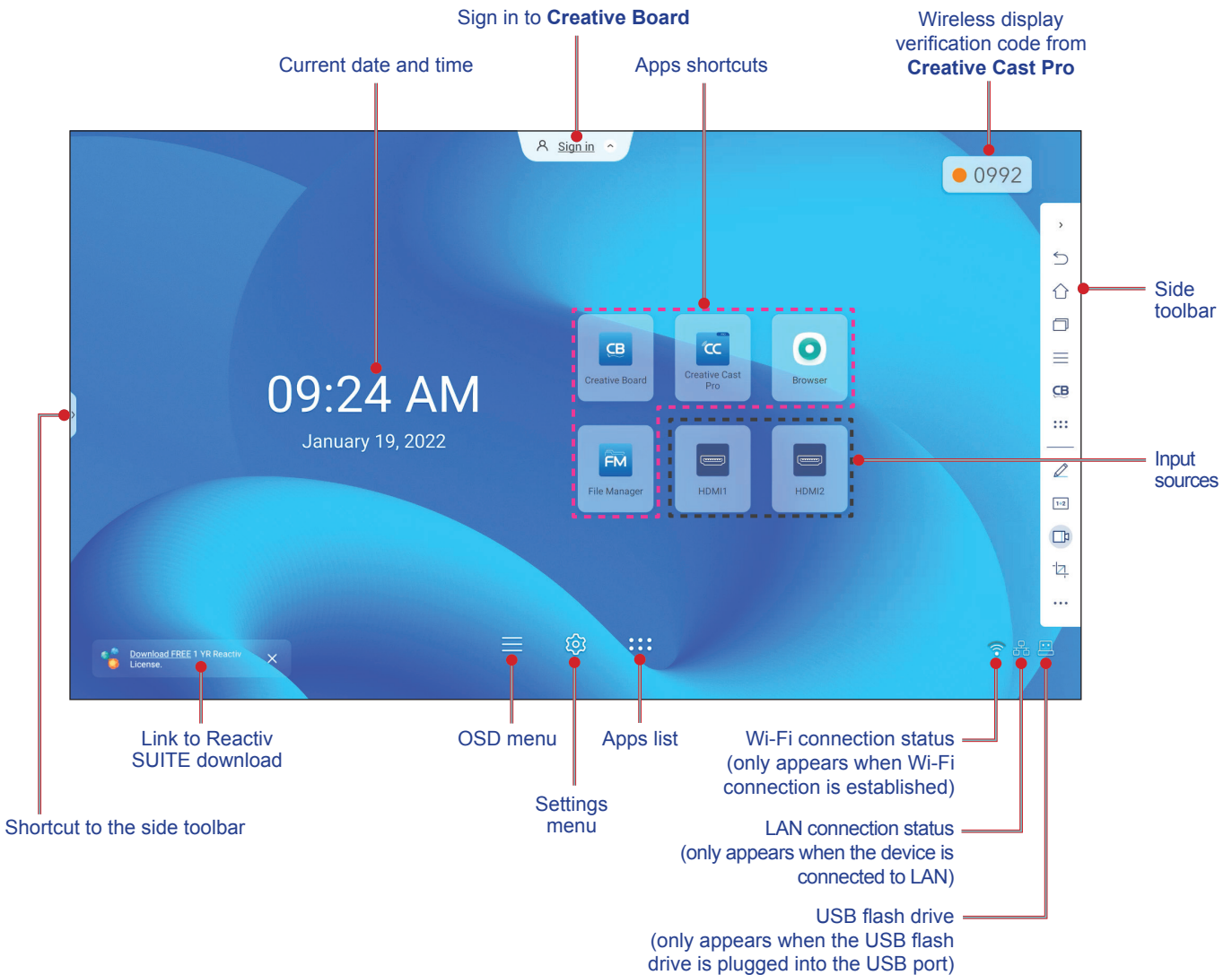

To navigate the Home screen, do any of the following:

- Select an option: simply tap on the desired item.
- Adjust the setting: drag the slider to the left or to the right.
- Open the side toolbar: tap > or < on the left or right side of the screen.

Note:

- Unless otherwise specified, this section describes IFP operations using touch gestures.
- You can also use the remote control to operate the IFP.

BASIC OPERATIONS

OSD Menu

To open the OSD menu, do any of the following:

- On any screen, drag the bottom of the screen upwards.

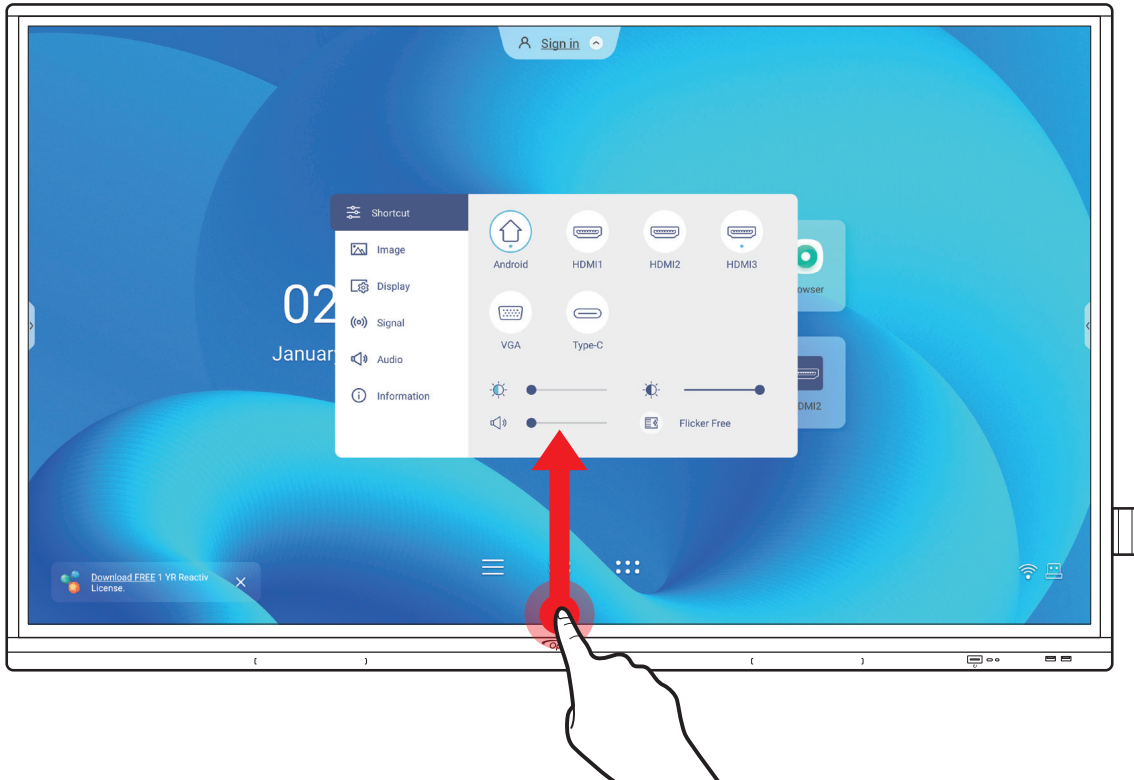

- Press the **Menu** or **Input** button on the remote control.
- Tap on the Home screen.

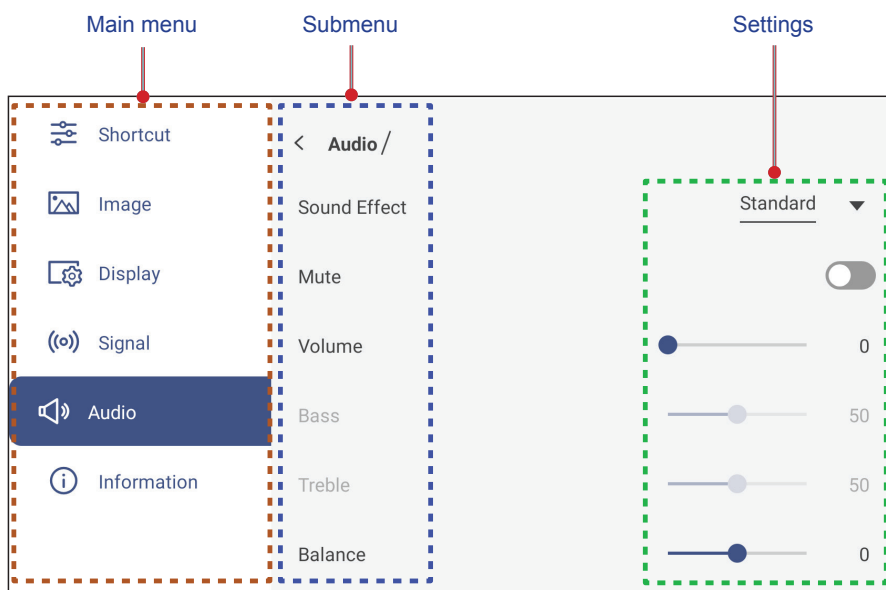

Note:

- To configure the OSD menu settings, simply touch the menu item on the screen and use the screen controls to adjust its value or set the setting. The selected menu item is highlighted in **blue**.
- To move to the previous item in the menu, tap **<** or press **Back** on the remote control.
- To close the OSD menu, touch anywhere on the screen outside the menu or press **Back** continuously (if necessary) on the remote control.

BASIC OPERATIONS

Shortcut Menu

Shortcut  menu is the first OSD menu. Complete the following steps:

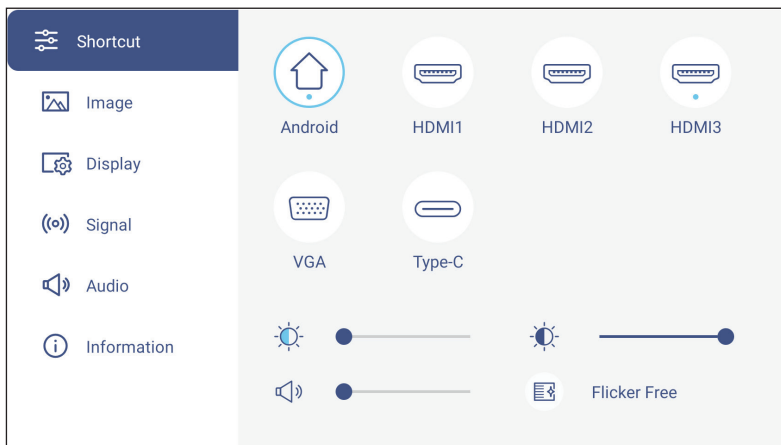

- Select the input source. Those input sources that are available are marked with the DOT  symbol.

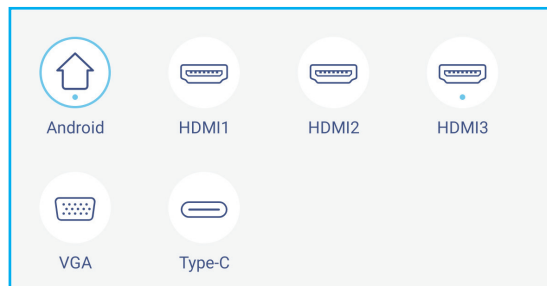

Note:

- For more information on making connections to external devices, refer to the “Connections” section.
 - The OPS option is only available if the PC module is properly installed into the OPS slot of the IFP.
- Drag the backlight slider bar to the right or to the left to adjust the backlight level.

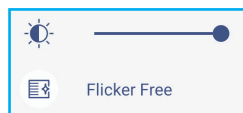

Note: For comfortable viewing experience, you can enable Flicker Free function.

- Drag the low blue light slider bar to the right or to the left to adjust the low blue light level.

IMPORTANT! Studies have shown that just as the ultra-violet rays can cause eye damage, the shortwave-length blue light rays from displays can cause eyestrain, retina damage, and affect vision over time. Optoma Low Blue Light is an eye protection feature that can reduce the blue light.



IMPORTANT! For protecting your eyes against prolonged display use, we highly recommend you to do the following:

- Let your eyes rest for 10 minutes after 2 hours of continuous use.
 - Roll your eyes upward towards your eyebrows, and then roll your eyes in a large circle every few hours.
 - For every 20 minutes of display viewing, look into the distance for 20 seconds.
 - When your eyes get sore, close your eyes for a minute.
- Drag the volume slider bar to the right or to the left to adjust the volume level.



BASIC OPERATIONS

Configuring the Image Settings

In the OSD menu, tap  to open the Image menu, then complete the following steps:

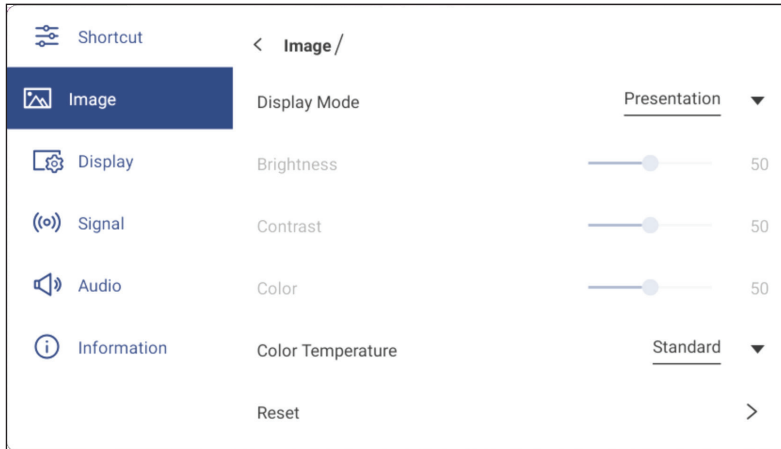

- Tap **Display Mode** and select one of the available options: Presentation, Bright, Cinema, HDR, or User.

Note:

- *Image settings can only be adjusted in HDMI, VGA, OPS, and Type-C input. It can't be adjusted and will be grayed-out in Android source.*
- *If the Display Mode setting is set to **User**, you can customize image settings by adjusting the brightness, contrast, and color settings based on your preferences.*
- Drag the **Brightness** slider bar to the right or to the left to adjust the screen brightness level.
- Drag the **Contrast** slider bar to the right or to the left to adjust the screen contrast level.
- Drag the **Color** slider bar to the right or to the left to adjust the screen color level from black and white to fully saturated color.

Note: *Brightness level, contrast level, and color level can be adjusted only if the Display Mode is set to **User**. In other display modes these parameters are preset and cannot be adjusted.*

- Tap **Color Temperature** and select one of the available options: Standard, Warm, or Cold.
- Tap **Reset** to reset all image settings to their defaults.

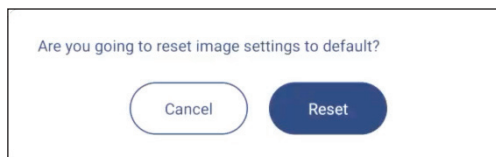

BASIC OPERATIONS

Configuring the Display Settings

In the OSD menu, tap  to open the Display menu, then complete the following steps:

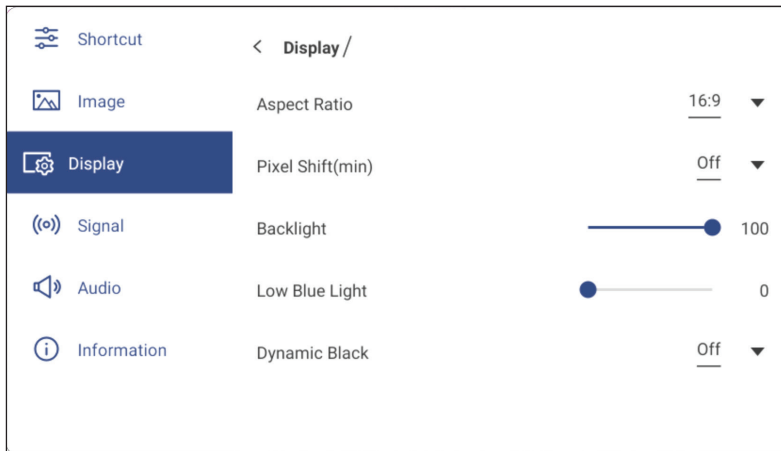

- Tap **Aspect Ratio** and select one of the available options: 16:9, 4:3, or PTP (Pixel To Pixel).
Note: For 4K input, the aspect ratio will be locked to PTP. For non-4K input, PTP will be grayed out and user can select only 4:3 or 16:9 as aspect ratio.
- Tap **Pixel Shift (min)** and select one of the available options: Off, 2, 3, 5, 30, or 60.
Note:
 - Pixel shift feature helps to prevent image retention.
 - Pixel shift is supported with all input sources except for Android.
- Drag the **Backlight** slider bar to adjust the backlight level.
Note: Backlight can be adjusted also in the Shortcut menu. Refer to page 34.
- Drag the **Low Blue Light** slider bar to adjust the blue light level.
Note: Low Blue Light can be adjusted also in the Shortcut menu. Refer to page 34.
- Tap **Dynamic Black** and select one of the available options: Off, Based on Content (not supported in Android), or Based on Ambient light.
Note: Dynamic black feature gives more depth to your image so that bright scenes appear crisp and clear, while dark scenes remain detailed with deep blacks and exceptional light and shade detail.

Configuring the Signal Settings (for VGA input only)

In the OSD menu, tap  to open the Signal menu, then complete the following steps:

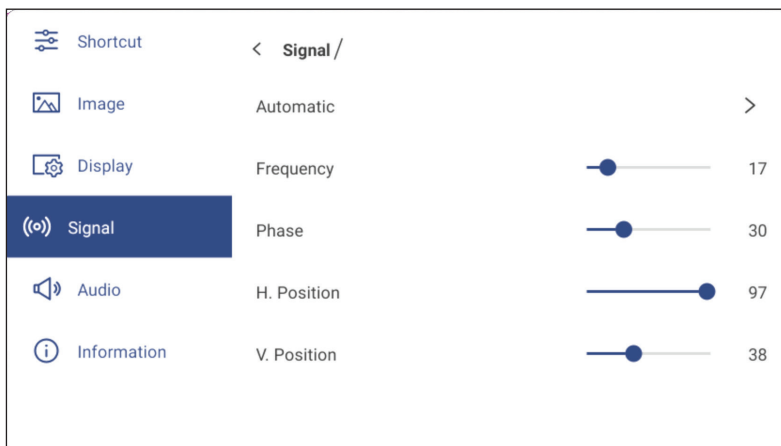



BASIC OPERATIONS

- Tap **Automatic** to automatically adjust the image to its optimized frequency, phase, and position.
- Drag the **Frequency** slider bar to adjust the vertical noise of the image.
- Drag the **Phase** slider bar to adjust the horizontal noise of the image.
- Drag the **H. Position** slider bar to adjust the image horizontal position manually.
- Drag the **V. Position** slider bar to adjust the image vertical position manually.

Configuring Audio Settings

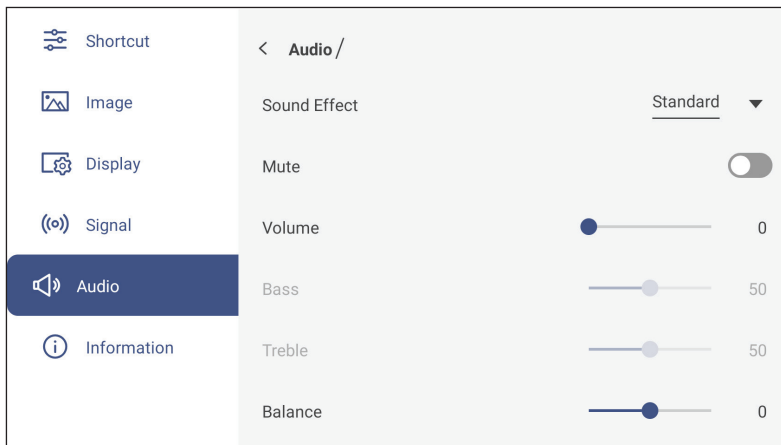
In the OSD menu, tap  to open the Audio menu, then complete the following steps:



- Tap **Sound Effect** and select one of the available options: Standard, Meeting, Class, Movie, or User.
Note: If the sound effect setting is set to **User**, you can customize audio settings by adjusting the bass and treble level according to your preference.
- Tap **Mute** to mute or unmute audio.
Note: You can also mute or unmute audio by pressing the  button on the remote control.
- Drag the **Volume** slider bar to adjust the volume level.
- Drag the **Bass** slider bar to adjust the bass level that is suitable for your room.
Note: Bass level and treble level can be adjusted only if the Sound Effect is set to **User**. In other sound effect modes this parameter is preset and cannot be adjusted.
- Drag the **Treble** slider bar to adjust the treble level that is suitable for your room.
- Drag the **Balance** slider bar to adjust the sound balance level that is suitable for your room.

BASIC OPERATIONS

Viewing Device Information

In the OSD menu, tap  to open the Information menu, then complete the following steps:

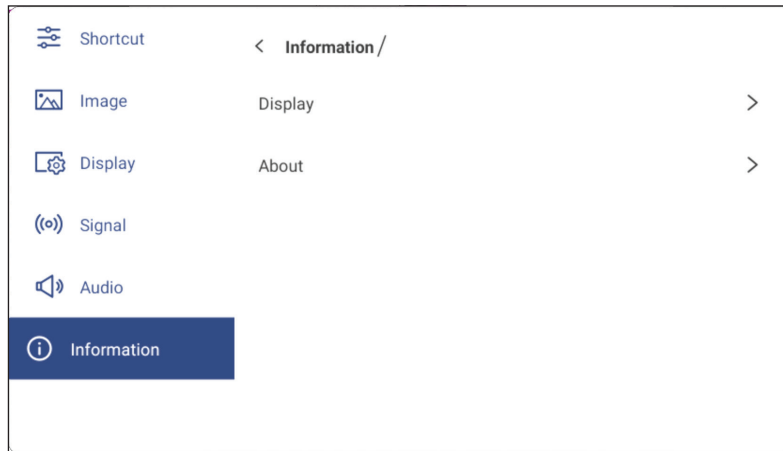

- Tap **Display** to view display mode, current input source, resolution, color depth, and color format.
- Tap **About** to view regulatory model name, serial number, firmware version, and Android version.

BASIC OPERATIONS

Android Settings Menu

To open the Settings menu, tap  on the Home screen.

Note: Settings can be modified only in Android mode.

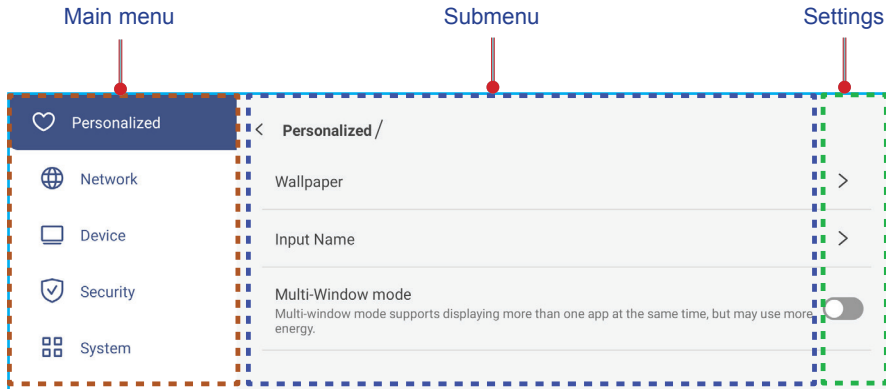

Note:

- To configure Android settings, simply touch the menu item on the screen and use the screen controls to adjust its value or set the setting. The selected menu item is highlighted in **blue**.
- To move to the previous item in the menu, tap **<** or press **Back** on the remote control.
- To close the OSD menu, touch anywhere on the screen outside the menu or press **Back** continuously (if necessary) on the remote control.

Personalizing the System

In the Settings menu, tap  to open the Personalized menu, then complete the following steps:

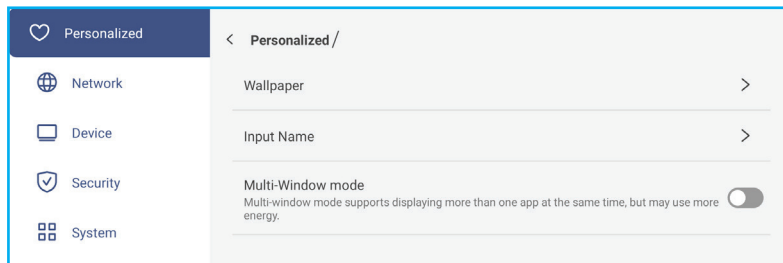

- Tap **Wallpaper** and select a pre-loaded image as a wallpaper or an image from your gallery.

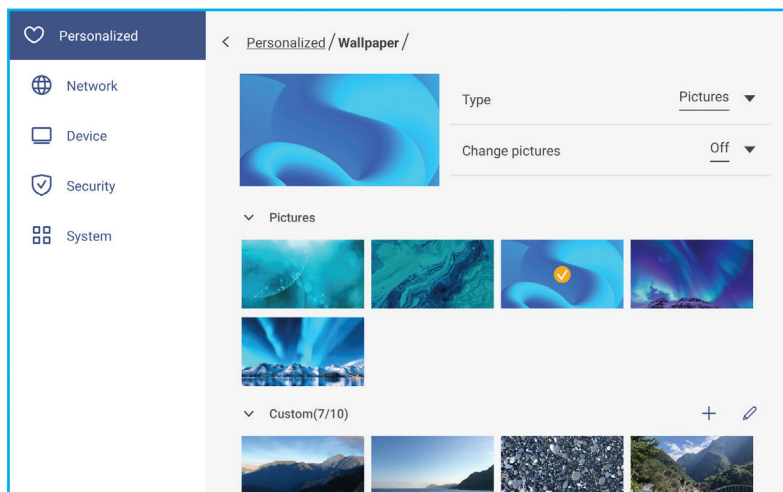

If you select a pre-loaded wallpaper from the Pictures folder, the setting will take effect immediately.

BASIC OPERATIONS

If you prefer to use a customized wallpaper, follow the steps:

- a) In the Custom folder tap **+**.
- b) Select your preferred image from the local or external storage and tap **Import**. You can import up to 10 images.
- c) In the Custom folder tap on the image you wish to use as a wallpaper. The setting takes effect immediately.
Note: To delete images in the Custom folder, tap **✎**. Then select the image and tap **Delete**.

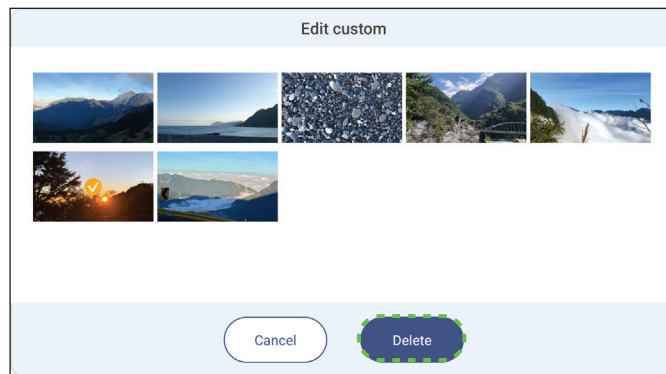

- **Type:** Select the image type.
- **Change pictures:** Select the slideshow interval from 5mins to 1 day. By default the slideshow is off.

Note: You can also set a wallpaper directly from the **File Manager** gallery. For more information on the **File Manager**, refer to page 80.

- Tap **Input Name** to rename the input. Tap on the input name you wish to change, then type a new name and confirm name modification by tapping **OK** at the prompt.

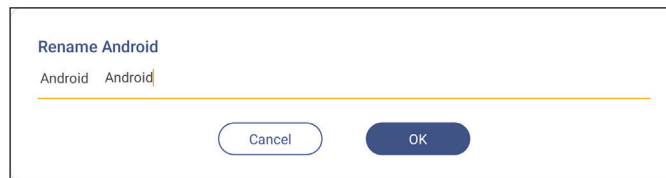

- Tap **Multi-Window mode** to enable displaying on the screen more than one app at the same time. Tap **Restart** when prompted to make the setting take effect.

Note: Multi-window mode consumes more computing power and it will increase system loading.

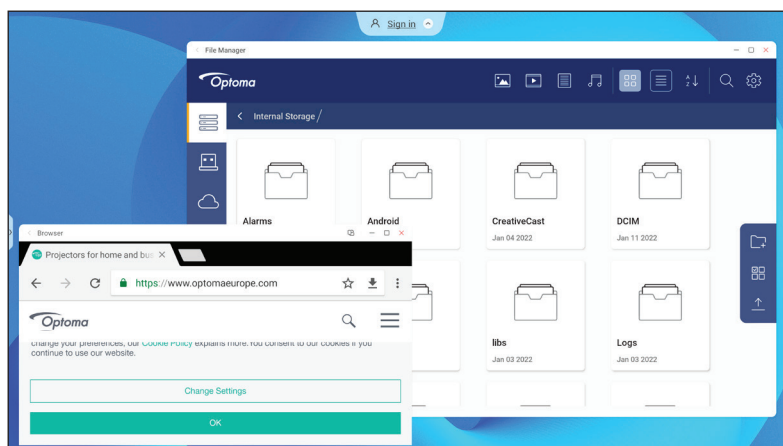

To manage app windows in multi-window mode, long press the app window and do any of the following:

- Move the app window in any of the four directions on the screen.
- Tap **↔** to switch the app window between landscape and portrait modes (if supported).
- Tap **☐** to minimize the app window.

BASIC OPERATIONS

- Tap  or drag the app window to the right or upper corner of the screen to view the app in full screen mode.

Note: When window is NOT in full screen, you can tap and hold on any of the 4 corners of a window until resizing arrow appears, then drag to the desired size and release.

- In full screen mode, drag the upper edge of the screen down and then tap  to see the app in a window.

- Tap  to close the app.

Configuring Network Settings

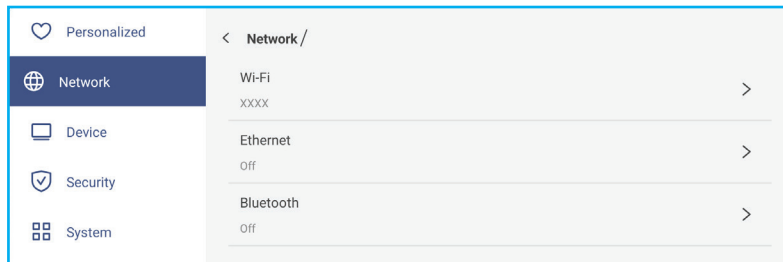

In the Settings menu, tap  to open the Network menu, then complete the following steps:

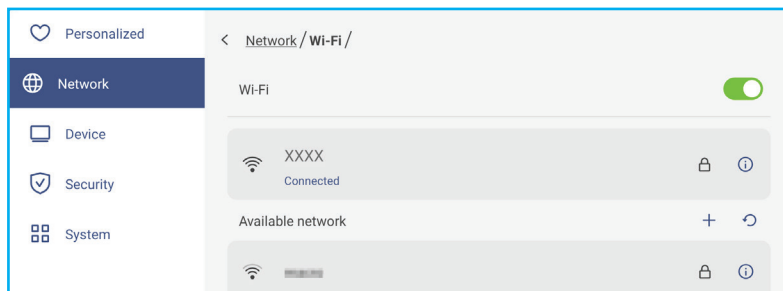

- Tap **Wi-Fi** to connect the IFP to the Wi-Fi network and view current connection status. Make sure the Wi-Fi function is enabled. In the Available network list, tap on your preferred Wi-Fi network, for example XXXX. Provide an access password if needed.

IMPORTANT! To connect to a Wi-Fi network, make sure the Wi-Fi dongle is properly installed in the Wi-Fi dongle slot. For more information, refer to page 27.



Note: If your preferred Wi-Fi network is not visible in the list, tap  to refresh the list. To enter the Wi-Fi network manually, tap .

- Enable **Portable hotspot** feature to share the Wi-Fi network to other wireless devices. Modify the network name and set an access password if necessary.

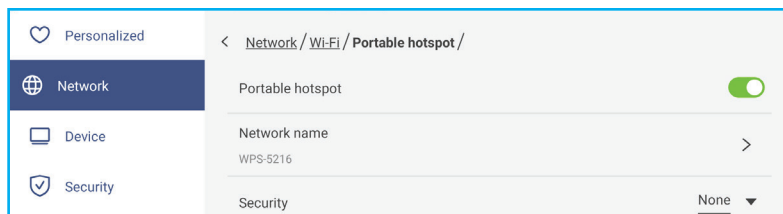

Note: For a secure connection, set the Wi-Fi encryption (Security field) as **WPA2-PSK**. Then enter the access password and tap **OK**.

- Tap **Ethernet** to configure LAN settings and view the current connection status. In the IP settings section select the network type between static and DHCP. If you set the network type as **Static** then tap  and enter the connection settings, such as IP address, gateway, network prefix length, and more.

IMPORTANT! To connect to a wired network, make sure the IFP is connected to LAN. For more information, refer to page 26.

BASIC OPERATIONS

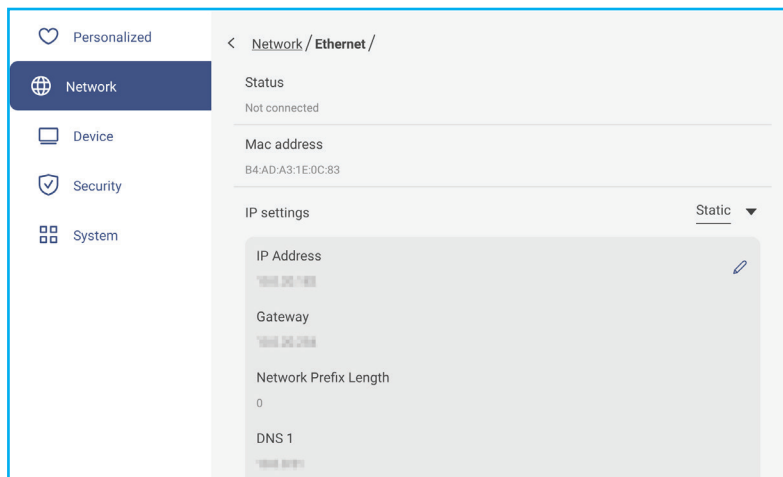

- Tap **Bluetooth** to enable Bluetooth and connect to other nearby Bluetooth devices. This interactive display supports Bluetooth version 5 and can connect for example to a Bluetooth keyboard, mouse, and speaker. Tap the following:
 - **Device Name** to enter a new device name. To confirm the modification, tap **OK** at the prompt.
 - In the list of *Available device*, select the device you want to connect to.

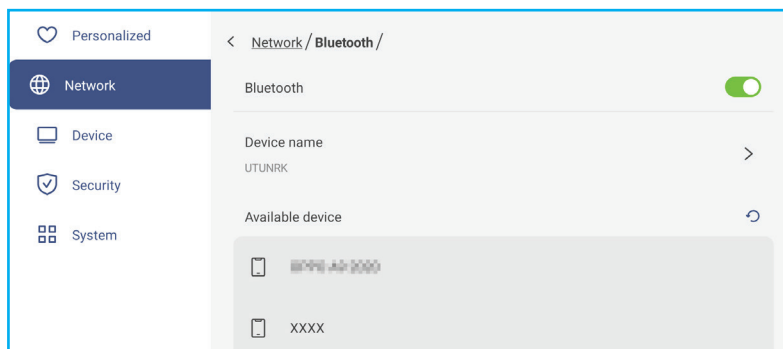

Make sure the pairing codes match on both devices and if they match, tap **Pair** to confirm.

IFP

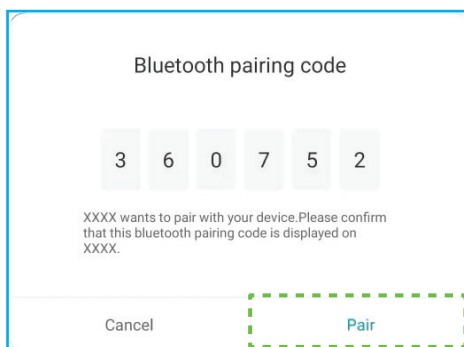

Portable Device

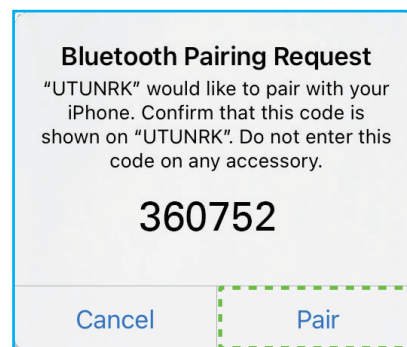

Note: If the Bluetooth device is not visible in the list of available devices, make sure the device is nearby the IFP and Bluetooth is enabled. Then tap ↻ to refresh the list.

BASIC OPERATIONS

Configuring Device Settings

In the Settings menu, tap  to open the Device menu, then complete the following steps:

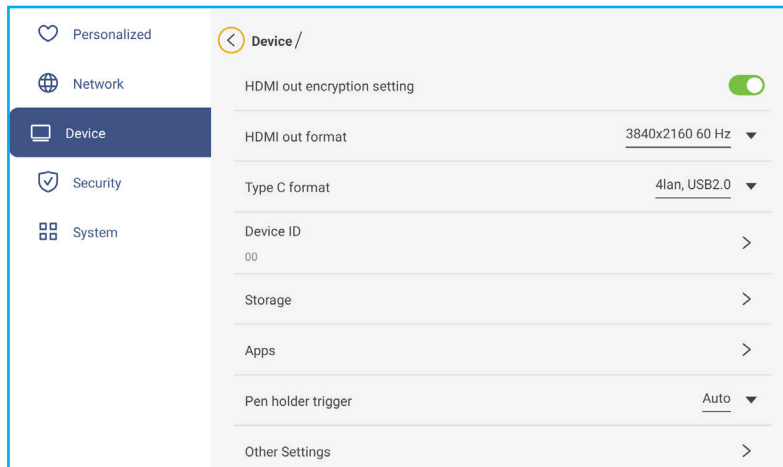

- Tap **HDMI out encryption setting** to enable or disable encrypting HDMI out signal with HDCP.
Note: If the connected monitor does not support HDCP, disable HDMI out encryption function.
- Tap **HDMI out format** and select the format that can be output from the HDMI port.
- Tap **Type C format** and select the USB type-C format.
- Tap **Device ID** to assign a new ID to the IFP. To confirm, tap **OK**.

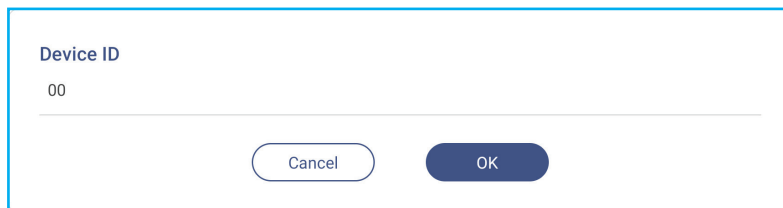

- Tap **Storage** to view storage usage.

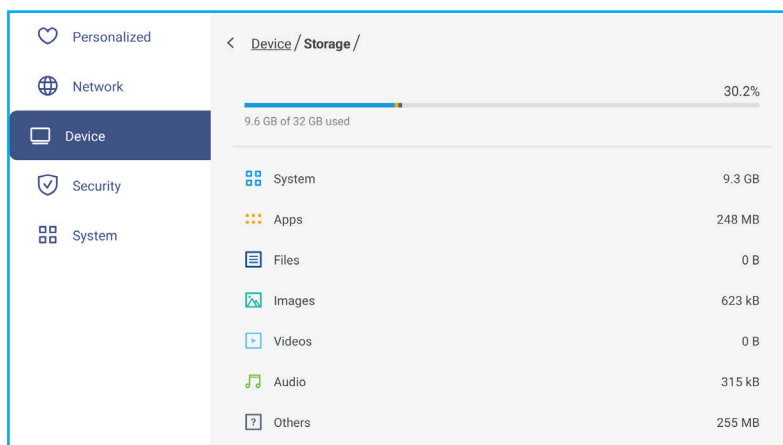

BASIC OPERATIONS

- Tap **Apps** to view apps information, clear apps data and cache, and force stop apps.

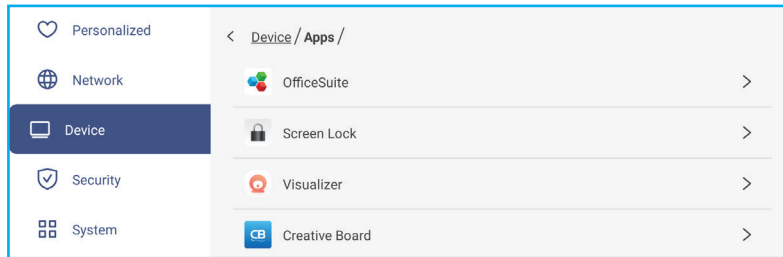

Select an app in the list to force stop it (tap **Force stop**), view its storage and clear its data (tap **Clear data**) and cache (tap **Clear cache**), view app version and set permissions.

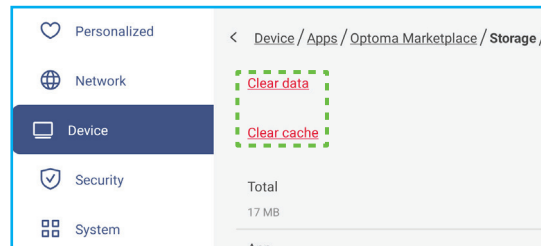
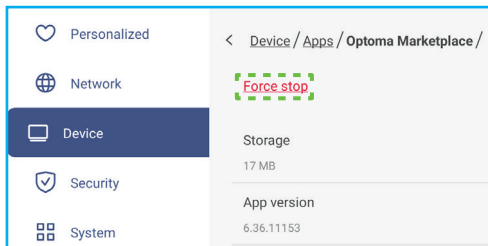

- Tap **Pen holder trigger** and select any of the following trigger actions:
 - **Auto**: When the pen is lifted, the system automatically launches the whiteboard or annotation tools. (Lifting the pen from the Home screen will open the whiteboard. Lifting the pen from any other app or input source will open the annotation tools).
 - **Whiteboard**: When the pen is lifted, the system always launches whiteboard.
 - **Annotation**: When the pen is lifted, the system always launches the annotation tools.
 - **Disabled**: Lifting the pen from the holder does NOT launch the whiteboard or annotation tools.
- Tap **Other Settings** to configure side toolbar, floating annotation toolbar, touch sound, and email settings.

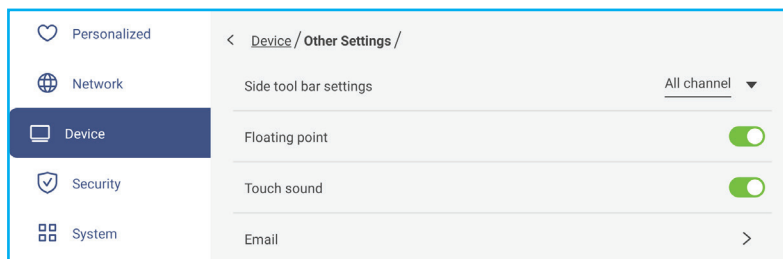

Tap any of the following:

- **Side toolbar settings** to select when the toolbar is visible: All channel, Only Android, All channels except OPS, or Disable the side toolbar.
- **Floating Point** to enable or disable floating annotation toolbar. For more information, refer to page 70.
- **Touch Sound** to enable or disable audio feedback when you tap items on the screen.
- **Email** to configure email settings. Enter the IP, ID, password, SMTP address, and other required information. Save the settings. Then tap **Confirm** to send a test email.

BASIC OPERATIONS

Configuring Security Settings

In the Settings menu, tap  to open the Security menu, then complete the following steps:

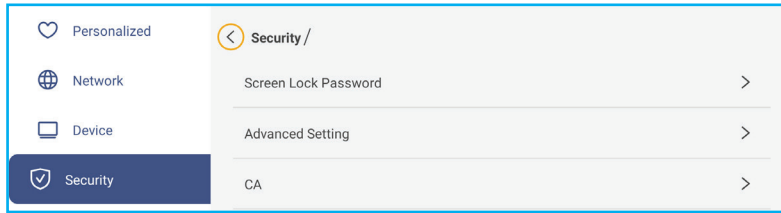

- Tap **Screen Lock Password** to set screen lock password. Enter a 4-digit password twice at the prompt and then tap **OK** to confirm.

Note: To remove the screen lock password, tap **Clear Screen Lock Password** (visible only if the password is set) and enter the current password. Then tap **OK** to confirm.

- Tap **Advanced Setting** to set or modify the Advanced Setting password and enable or disable installing third party applications. Do the following:
 - Note:** The **DEBUG MENU** advanced settings can be also accessed with the Advanced Setting password set in this menu.

a) Enter the Advanced Setting password at the prompt to access the advanced settings and then tap **OK** to confirm.

Note: The default password is **1 + 2 + 3 + 4**.

BASIC OPERATIONS

b) Select any of the following items:

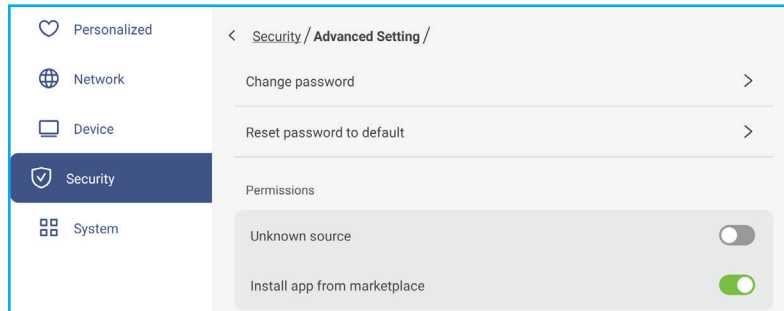

- **Change password:** Enter the current password and twice the new password. Then tap **OK** to confirm.

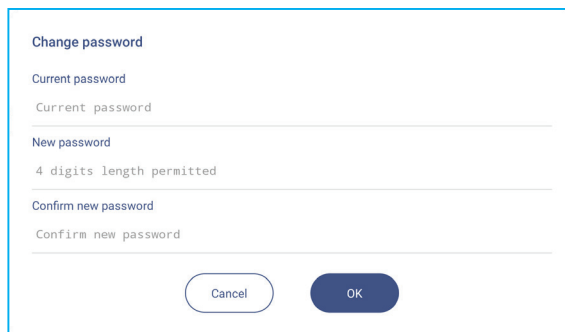

- **Reset password to default:** Enter the current password and tap **Reset** to confirm. The password is reset to **1 + 2 + 3 + 4**.

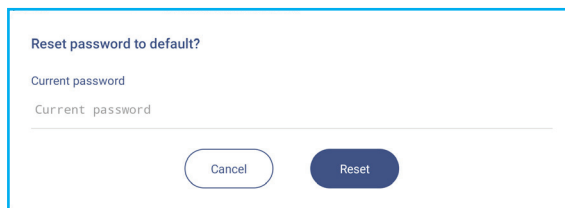

- Under Permissions, tap **Unknown source** and enable or disable installing third party software from an unknown source.

- Under Permissions, tap **Install app from marketplace** and enable or disable installing third party software from **Optoma Marketplace**.

• Tap **CA** to view and modify trusted CA certificates, user stored credentials, and more.

- Tap **Trusted credentials** to view and modify trusted CA certificates.

- Tap **User credentials** to view and modify user stored credentials.

- Tap **Install from storage** to install credentials from the storage.

- Tap **Clear all credentials** to remove all user credentials.

Tap **Clear** at the prompt to confirm.

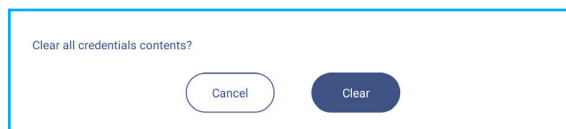

BASIC OPERATIONS

Enabling or Disabling USB Wi-Fi/USB Disk

a) Press **Input + 5 + 9 + 8 + 0** buttons on the remote control.

The DEBUG MENU opens.

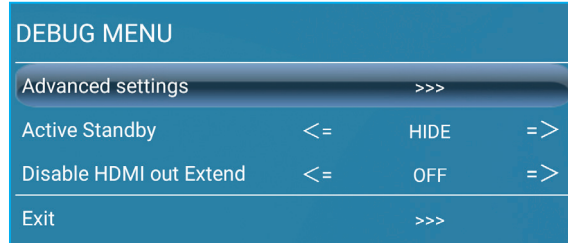

b) Tap >>> next to the Advanced settings, then enter the Advanced Setting password at the prompt and tap **Confirm**.

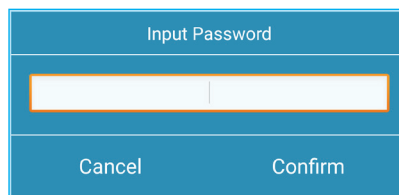

c) Tap <= or >= next to USB WIFI Enable and select OFF when prompted to disable USB WIFI. Select ON to enable USB WIFI.

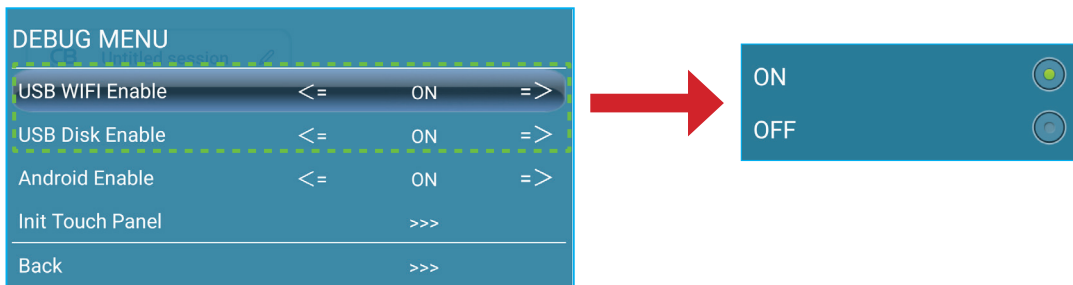

Tap **Confirm** at the prompt. After the system restarts, the setting takes effect.

BASIC OPERATIONS

Configuring System Settings

In the Settings menu, tap  to open the System menu, then complete the following steps:

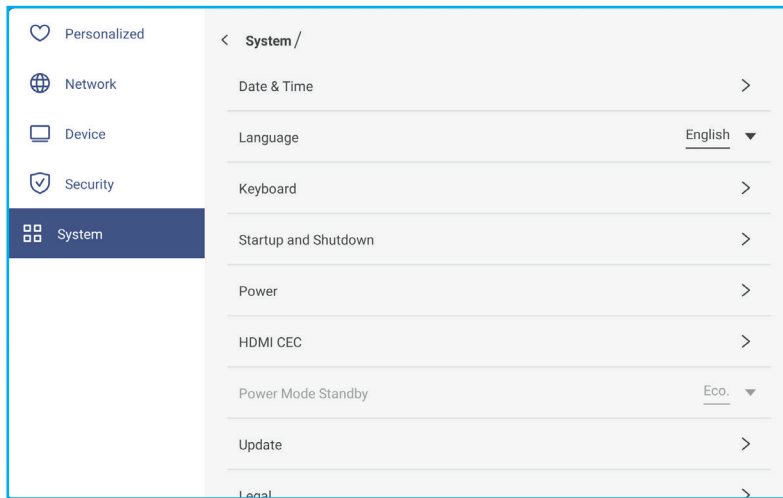

- Tap **Date and Time** to configure date and time related settings. Tap any of the following:

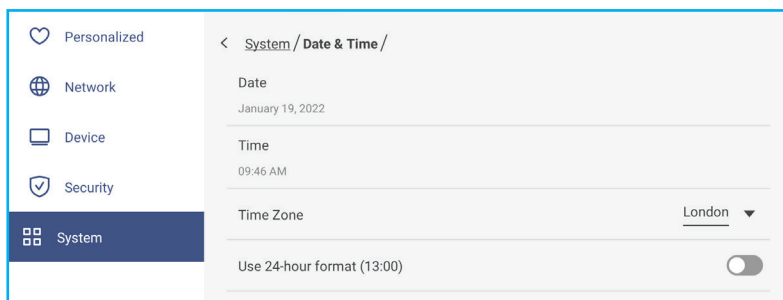

- **Time Zone** to select/change the time zone for your area.
- **Use 24-hour format (13:00)** to enable or disable displaying time in 24-hour format.
- Tap **Language** to select one of the available language options: English, French, Spanish, Traditional Chinese, Simplified Chinese, Portuguese, German, Dutch, Polish, Russian, Czech, Danish, Swedish, Italian, Turkish, Arabic, Romanian, Hungarian, Finnish, or Norwegian.
- Tap **Keyboard** to view and manage keyboards.
- Tap **Startup and Shutdown** to configure settings related to starting and shutting down the IFP. Tap any of the following:

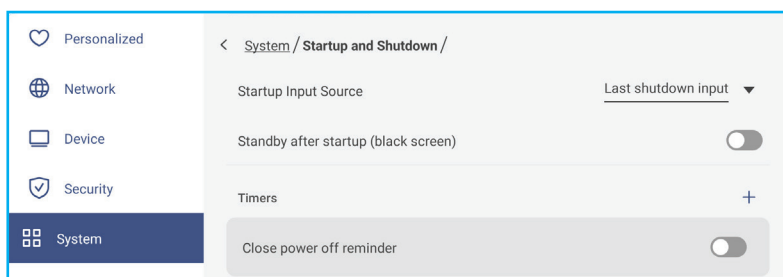

- **Startup Input Source** item to select one of the available startup input options: Last shutdown input, Android, HDMI 1, HDMI 2, HDMI 3, Type-C, or VGA.
- **Standby after startup (black screen)** to enable or disable standby after startup.
- **Close power off reminder** to enable or disable closing power off reminder when the IFP is scheduled to shut down.

BASIC OPERATIONS

- **Timers** ⇒ + to set a startup and shutdown timer. To create a schedule, do the following:
 - To enable startup timer and/or shutdown timer, select the radio button next to **Startup timer** and **Shutdown timer**.
 - Set the time and select the day(s) when you want the IFP to follow this startup or shutdown schedule.
 - Tap **Add** to save the timer.

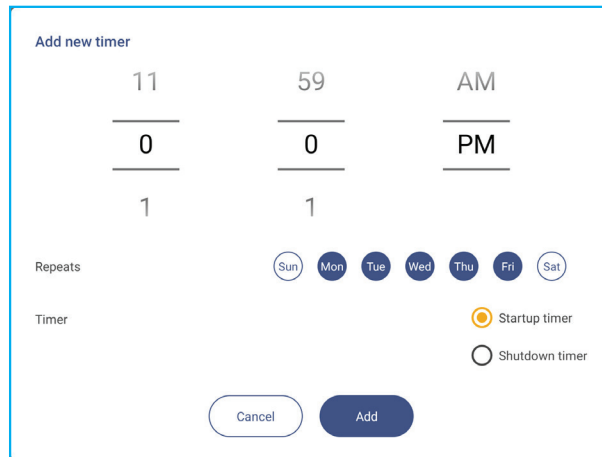

- d) Enable (or disable) the new schedule in Timers menu.

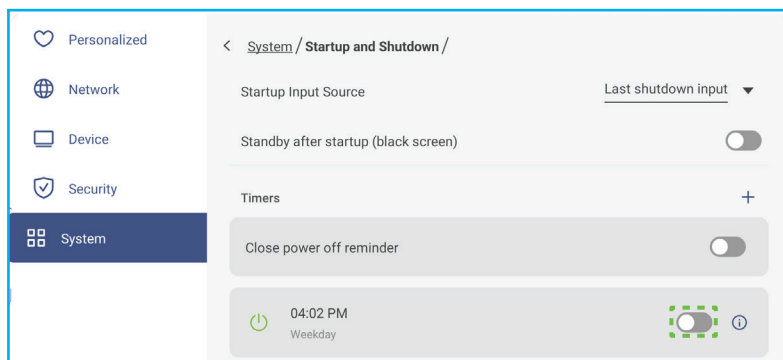

Note:

- Tap ⓘ to modify or remove the schedule.
- You can set up to 3 schedules.
- Tap **Power** to configure power settings. Tap any of the following:

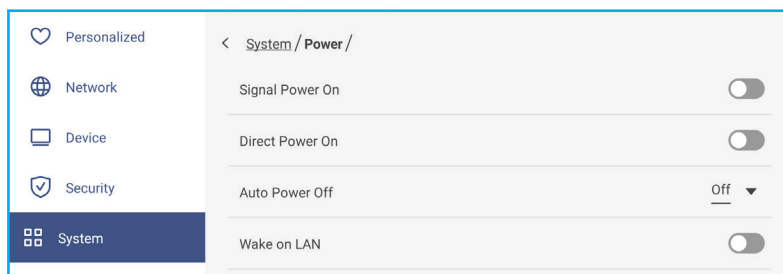

- **Signal Power On** to enable or disable starting up the IFP when an input signal is detected.
- **Direct Power On** to enable or disable starting up the IFP from the power source.
- Note:** Direct power on feature aids installations that rely on power-on timers.
- **Auto Power Off** item to select one of the available time intervals in minutes to automatically power off the IFP when there is no input source found: Off (function is disabled), 5, 10, 15, 20, 25, 30, 35, 40, 45, 50, 55, or 60.

BASIC OPERATIONS

- **Wake on LAN** to enable or disable remotely starting up the IFP over LAN.

Note: *Wake on LAN can't work and will be gray out when Power Mode (Standby) is set to **Active**.*

- Tap **HDMI CEC** to enable or disable any of the available options: Display on then player on, Display off then player off, Player on then display on, or Player off then display off.
- Tap **Power Mode (Standby)** item to select one of the available options: Eco or Active. By default, **Active** item is not visible. To enable **Active** option, do the following:

a) Press **Input + 5 + 9 + 8 + 0** buttons on the remote control.

The DEBUG MENU opens.

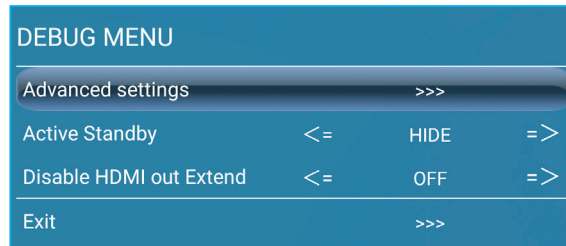

b) Tap **HIDE** next to Active Standby. Select **SHOW** at the prompt.

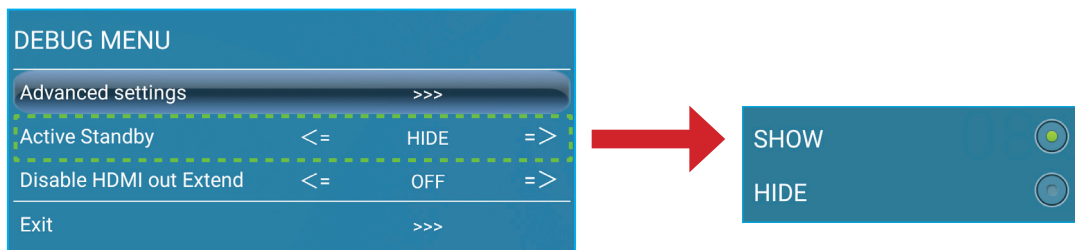

c) Tap **Exit** to exit the DEBUG MENU.

Active option is available in System ⇒ Power Mode (Standby) menu.

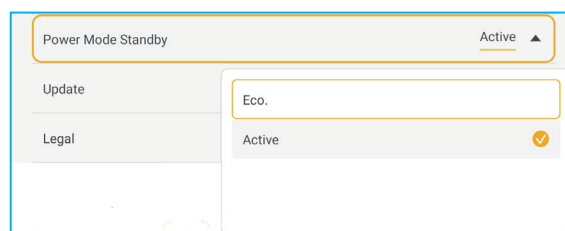

Note:

- **OMS** and LAN control remote power on functions will only work when Power Mode (Standby) is set to **Active**.
- *Active Standby mode consumes higher power since system only turns off backlight and mainboard is still working to listen for power on command from LAN and OMS. If you don't have remote power on requirement, we suggest using **Eco**. Standby mode to save more power.*
- *It is also highly recommended that you switch back to **Eco**. Standby mode and turn off the IFP for a period of time. It will help IFP system to release memory and CPU loading.*
- Tap **Update** to configure upgrading options. Tap any of the following:

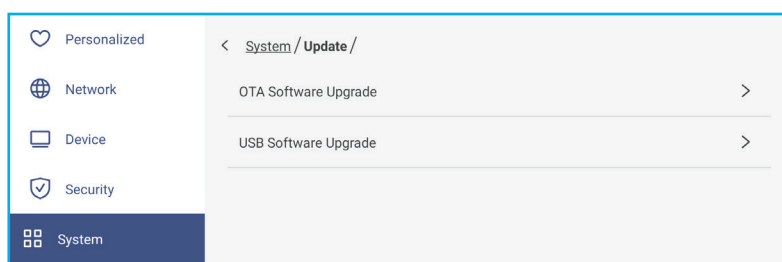

BASIC OPERATIONS

- **OTA (Over-The-Air) Software Upgrade** to enable or disable upgrading software over Internet. Tap **Auto** to enable the system to check for firmware upgrades automatically every time the IFP is powered on and connected to the Internet. If the **Auto** option is disabled, the system will not check for firmware upgrades automatically.

To update the system manually, do the following:

- a) Tap **UPDATE** at the prompt.

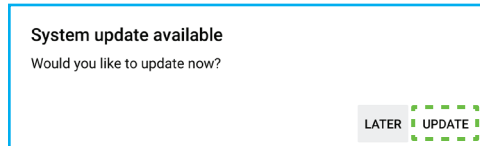

- b) Tap **DOWNLOAD** at the System Update window.

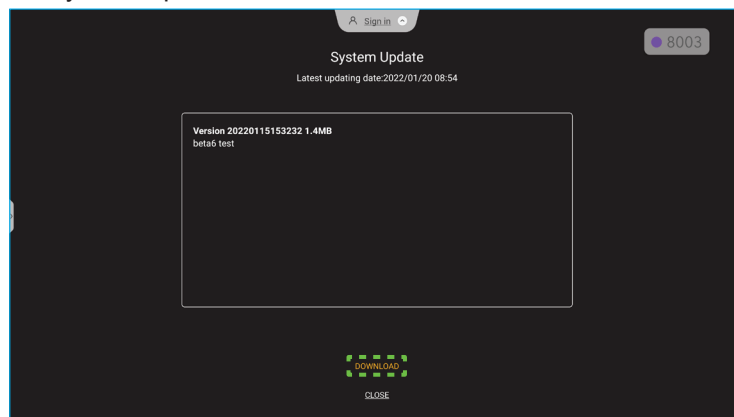

- c) Tap **UPDATE** to start the update process.

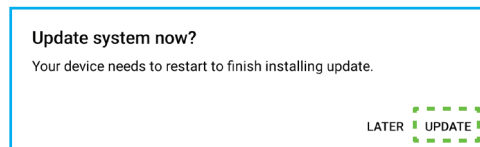

Wait until the update process is complete.

Note: *Upgrading software over Internet requires network connection.*

- **USB Software Upgrade** to update the system from a USB flash disk.

Note: *To proceed with upgrading software, save the upgrade file to the USB flash disk first, then connect the disk to a USB 2.0 port on the IFP. Open Advanced Settings ⇒ System ⇒ Update ⇒ USB Software Upgrade and tap **Start** at the prompt.*

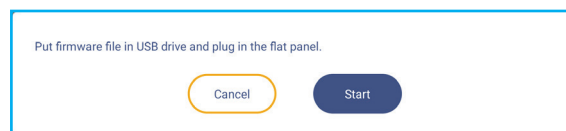

Note: *If you upgrade IFP's firmware from a USB storage, uncompress the upgrade file first and then copy the uncompressed file to the USB root directory. Make sure the USB flash disk is formatted as FAT32.*

IMPORTANT!

- *During the update process, either OTA or from a USB storage, DO NOT power off the IFP and DO NOT remove the USB dongle from the IFP. Doing so will damage the system.*
- *If you update the IFP from a USB storage then all user data saved to the USB storage will be wiped out. If you update the IFP over Internet (OTA) then all user data remains intact.*

BASIC OPERATIONS

- Tap **Legal** to view Terms and Conditions of Use, Privacy policy, Cookie policy, and Open Source Library.

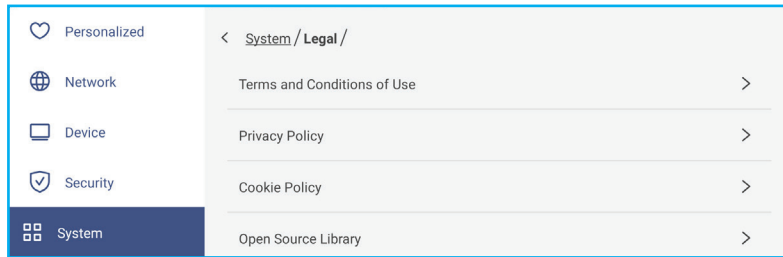

BASIC OPERATIONS

Side Toolbar

Tap > or < on the left or right side of the screen to open the side toolbar.

Note: Drag > or < up or down on the screen to relocate it.

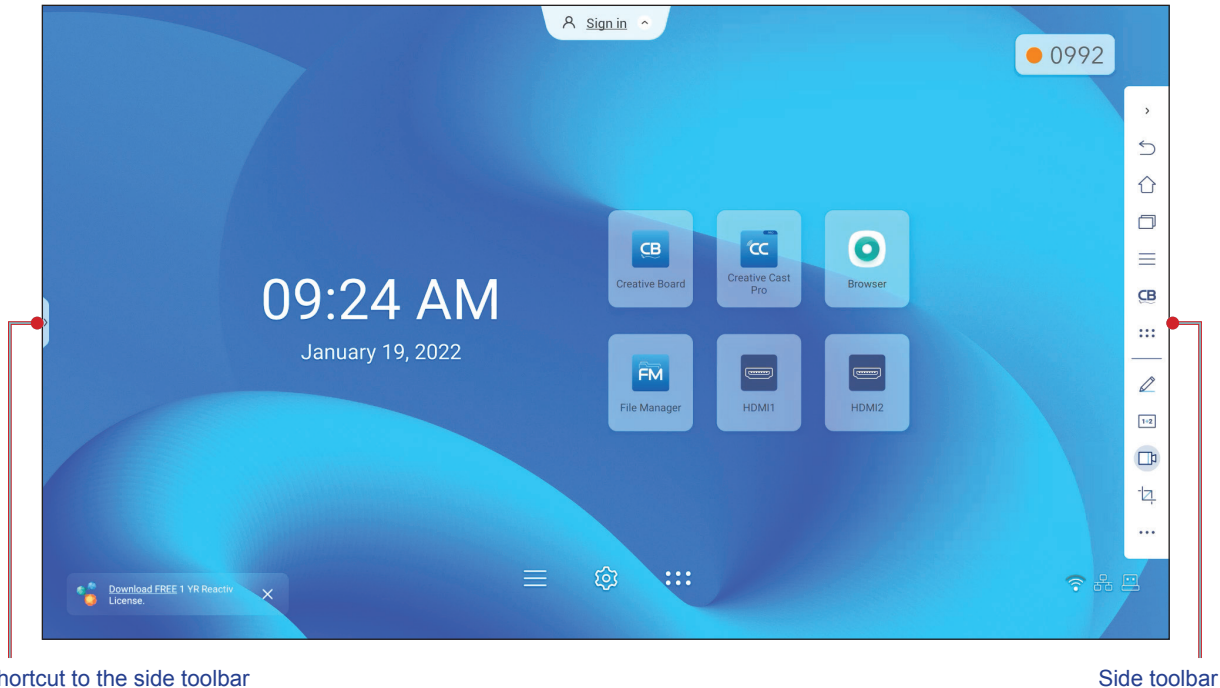

- To hide the toolbar, tap > or <.
- To return to the previous screen, tap ↶.
- To return to Home screen, tap 🏠.
- To view recent or open tasks and apps, tap 🗄️. For more information, refer to “Viewing Recent Tasks” on page 54.
- To view the OSD menu, tap ☰. For more information, refer to “OSD Menu” on page 33.
- To open **Creative Board**, tap **CB**. For more information, refer to “Creative Board App” on page 55.
- To open the apps screen, tap ⋮.
- To open the annotation app, tap ✎. For more information, refer to “Annotation App” on page 62.
- To open an online classroom, tap 1+2. For more information, refer to “Airshare” on page 63.
- To open the screen recording tool, tap 📹. For more information, refer to “Floating Annotation Toolbar” on page 70.
- To open the screen capture tool, tap 📷. Use this tool to capture the screen image and save it to the storage device or insert it into the whiteboard session. For more information, refer to “Screen Capture Tool” on page 68.
- To open more tools, such as **Freeze**, **Stopwatch**, **Timer**, **Spotlight**, **ScreenLock**, or **Calculator**, tap ⋯.

BASIC OPERATIONS

Viewing Recent Tasks

Tap > or <=>  to view and manage all opened apps.

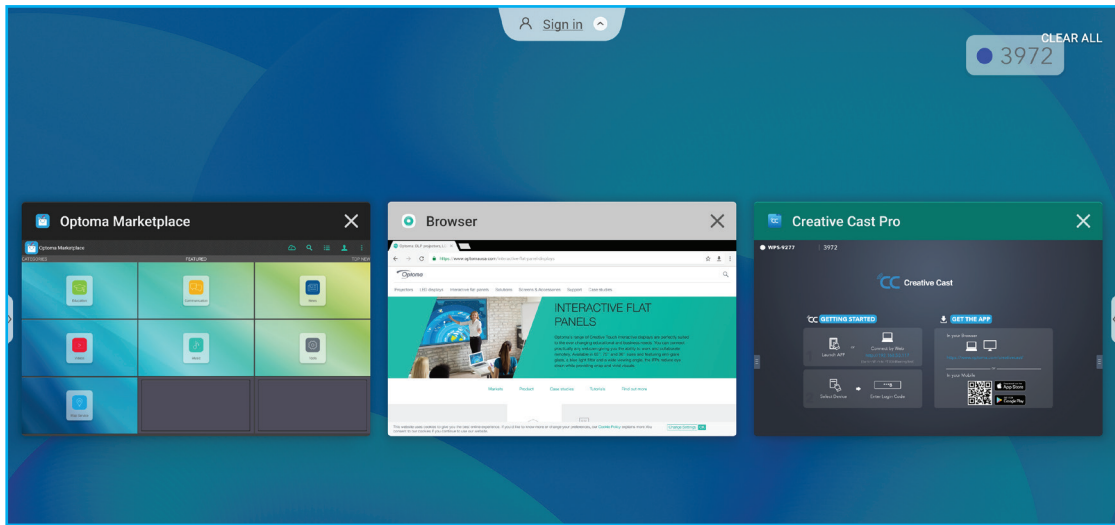

- Tap on the app you want to launch.
- To close the app, tap **X** in the app window.
 - In multi-window mode, swipe the app window to the left or to the right or tap **X** to close the app.
- To clear the list, tap **CLEAR ALL**.
 - In multi-window mode, tap **Clean All**.

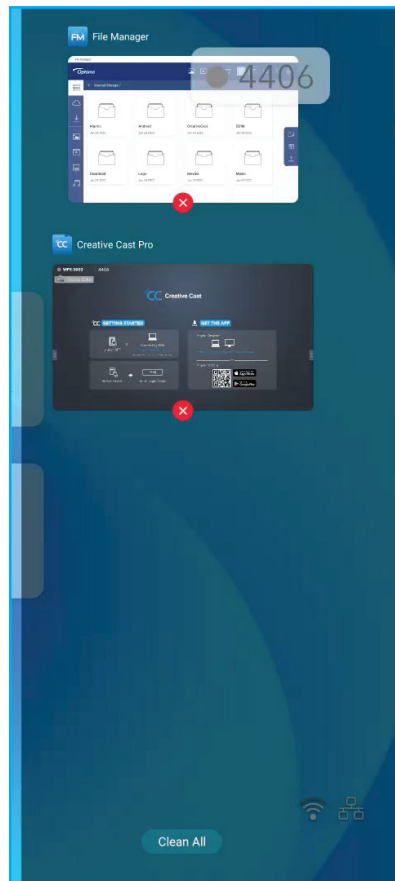

BASIC OPERATIONS

- To use split screen, tap and hold on the desired app and then drag it to the left or to the right of **Drag here to use split screen** column.

Note: Split screen is not supported in multi-window mode.

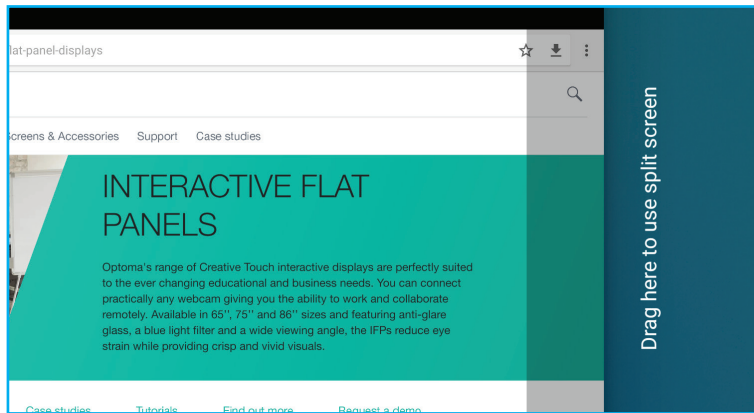

Note: You can also view recently used apps in floating annotation toolbar. Refer to "Floating Annotation Toolbar" on page 70.

Creative Board App

Creative board is an online collaborative whiteboard platform that can bring teams together to brainstorm, sketch and collaborate, anytime, anywhere.

Tap > =>  to open the **Creative Board**.

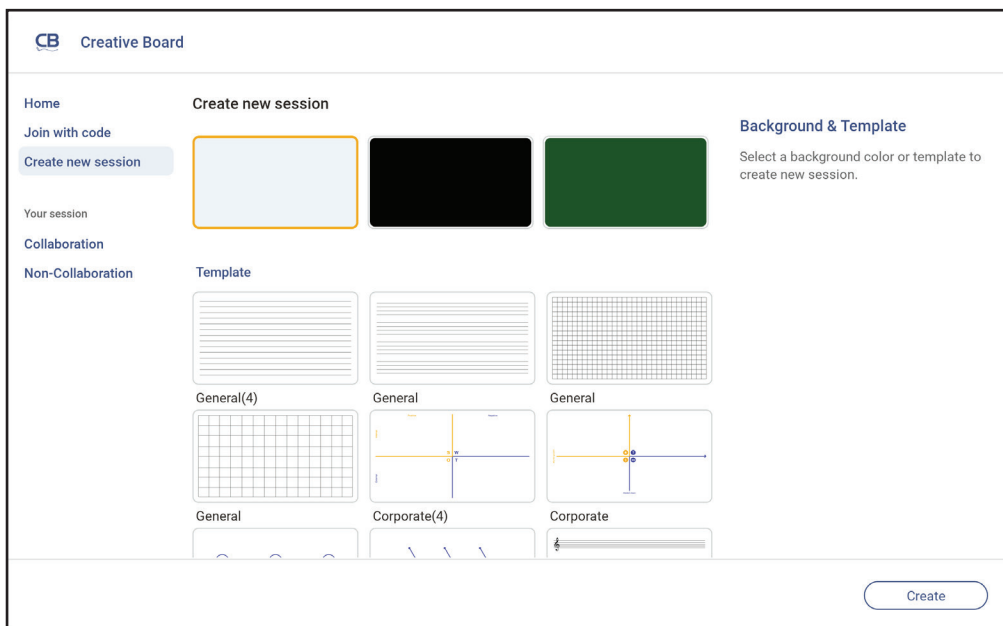

To start using the app, do the following:

1. Tap on the **Create new session** tab. Then select a background or template for your content.











Note: To access your cloud sessions, login to **Creative Board** first.

- To open a recent session, tap on the **Home** tab and under Recent category tap on the session you want to continue.
- To open a collaboration (saved to the cloud) or non-collaboration (saved locally) session, under Your session category, tap on the session you want to continue.



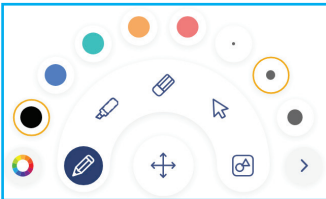

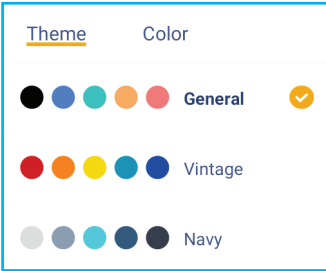

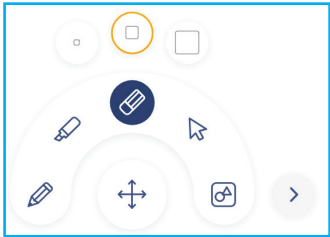
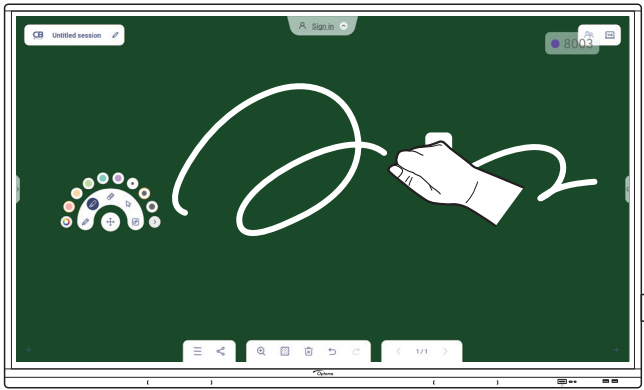

BASIC OPERATIONS

2. Tap **Create** and use any of the activities described in the table below:

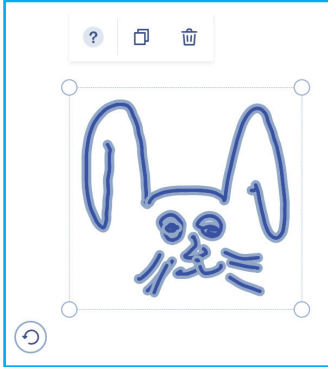





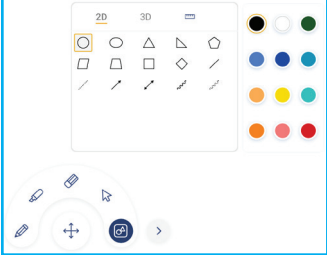

Note: The floating board is home to many of the primary features found in the **Creative Board** app, which are detailed here.

Item	Description
 Move the floating board	<p>Tap and drag or long-tap on the screen to move the floating board to your preferred location on the screen.</p> 
 Minimize the floating board	<p>Tap on the  icon to minimize the floating board. Tap  to expand the floating board.</p>
 Pen	<p>Write or draw a freeform line. Tap to select the desired line color and thickness.</p>  <p>- Tap  to modify the color palette. You can select five palette colors based on the theme or select them individually.</p>  <p>IMPORTANT! Avoid damaging the virtual whiteboard. For writing and drawing, use ONLY the supplied touch pen or your fingers.</p> <p>Note:</p> <ul style="list-style-type: none"> • Touch pen is supplied with thin tip and thick tip. Creative Board can detect automatically which tip (  accordingly) you are using and displays the options based on the tip thickness. • If you are using your fingers to write or draw on the virtual whiteboard then it is considered as using a “thick tip pen”.

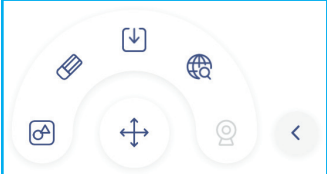

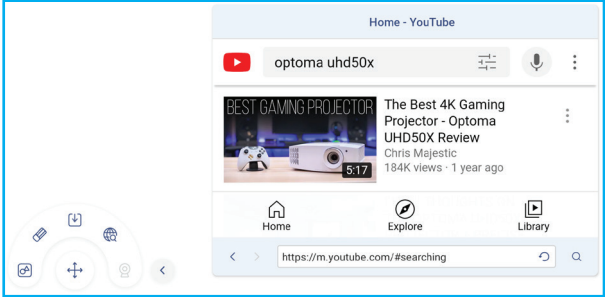





BASIC OPERATIONS

Item	Description
 Eraser	<p>Erase areas of your written texts or drawings. Select the eraser size and drag your fingers over the area you want to remove.</p>  <p>Note: You can also use the palm of your hand to erase the item on the whiteboard.</p> 
 Select	<p>Select an object on the whiteboard. Tap any of the following to alter the selected area:</p>  <ul style="list-style-type: none"> •  (boundary point) to enlarge or shrink. •  to change the color. •  to duplicate. •  to delete. •  to rotate.



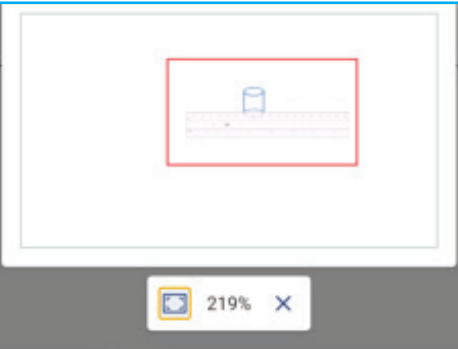









BASIC OPERATIONS

Item	Description
 Geometric shape	<p>Draw a geometric shape.</p> <p>Tap to select the desired 2D, 3D shape with several color options, use a ruler to measure distances and draw lines, or use a protractor to measure and draw angles.</p> 
 More tools	<p>Tap any of the following tools:</p>  <ul style="list-style-type: none">  import JPG, PNG, or PDF files from different storage devices, including internal storage, USB storage, or cloud drive.  embed a fully functional web browser window. You can capture screenshots, resize, relocate, duplicate, and delete the browser window.  <ul style="list-style-type: none">  embed a document camera.
 Add a page.	
 Menu	<p>Tap any of the following options:</p> <ul style="list-style-type: none"> New to create a new session. Open to open a collaboration or non-collaboration session. Save/Save As to save/save as the current content to collaboration or non-collaboration session. Import to import a JPG, PNG, or PDF file. Export to export the session as JPG, PNG, or PDF file.  to open Settings menu. Then enable or disable auto saving for non-collaboration session, eye protection writing mode, customize floating board, and update software. ? to read the Creative Board app tutorial.

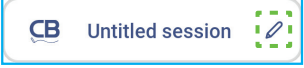













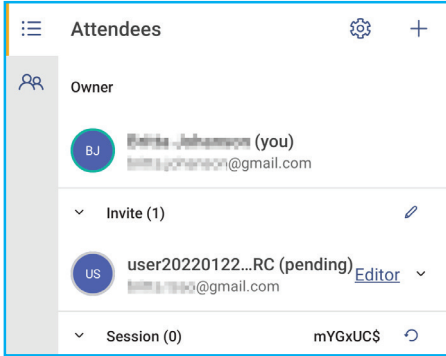

BASIC OPERATIONS

Item	Description
 Share	<p>Tap any of the following to share the file to other devices:</p> <ul style="list-style-type: none"> • QR Code to share the file with QR code. <div data-bbox="746 405 1142 819" style="border: 1px solid #00aaff; padding: 10px; margin: 10px auto; width: fit-content;"> <p>Share with QR code</p> <p>Ensure your device is connected to the same Wi-Fi network, then scan the QR code.</p>  <p style="text-align: center;">Close</p> </div> <p>Note: Before scanning the QR code to download the file, make sure the IFP and your mobile device are connected to the same Wi-Fi network.</p> <ul style="list-style-type: none"> • Email to send the file by email. <p>Note: If you want to send the file by email for the first time, you are prompted to configure email settings first. For more information, refer to page 44.</p>
 Zoom	<p>Zoom in or zoom out on the screen. Then tap  to open the zoom window. Move the red box to the area that you want to show on the screen.</p> <div data-bbox="687 1122 1201 1473" style="border: 1px solid #00aaff; padding: 10px; margin: 10px auto; width: fit-content;">  </div> <p>Tap  to close the zoom window.</p>
 Background options	<p>Select a background or template for your content. Tap Select. Then select your image from the File Manager or from the browser and set as a template for your session.</p> <div data-bbox="762 1615 1126 2056" style="border: 1px solid #00aaff; padding: 10px; margin: 10px auto; width: fit-content;"> <p>Background</p> <p>Color ○ ▾</p> <p>Image Select</p> <hr/> <p>Template</p> <div style="border: 1px solid #ccc; padding: 5px; margin: 5px auto; width: 60px; height: 40px; display: flex; align-items: center; justify-content: center;"> ⊘ </div> <p>General(4)</p> <div style="display: flex; justify-content: space-around;"> <div style="border: 1px solid #ccc; padding: 5px; width: 80px; height: 60px;">01</div> <div style="border: 1px solid #ccc; padding: 5px; width: 80px; height: 60px;">02</div> </div> </div>
 Delete a page	<p>Delete all items/objects you draw in current page.</p>

BASIC OPERATIONS

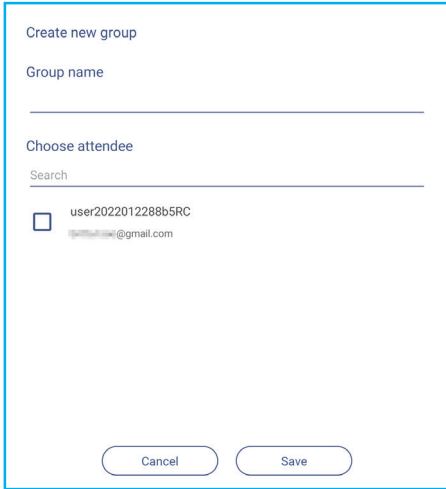
Item	Description
 Undo	Undo your last action.
 Redo	Redo your last action.
Page manager	<p>View and manage all pages that are involved in the current session. Tap any of the following:</p> <div data-bbox="794 510 1098 562" style="border: 1px solid blue; padding: 2px; display: inline-block; margin: 10px auto;">  </div> <ul style="list-style-type: none"> •  to open the previous or next page. • Page number, for example 2/3 to open the page manager: <div data-bbox="427 674 1461 913" style="border: 1px solid blue; padding: 5px; margin: 10px auto;"> <div style="display: flex; justify-content: space-between; font-size: 8px;"> 1 2 3 </div> <div style="display: flex; justify-content: space-around; align-items: center;"> <div style="border: 1px solid gray; width: 150px; height: 80px; background-color: #e0e0e0; position: relative;"> <div style="position: absolute; bottom: 5px; left: 5px; right: 5px; display: flex; justify-content: space-around;"> +  + </div> </div> <div style="border: 1px solid gray; width: 150px; height: 80px; background-color: #e0e0e0;"></div> <div style="border: 1px solid gray; width: 150px; height: 80px; background-color: #e0e0e0;"></div> </div> </div> <p>Tap  on the left side to add a page to the left or on the right side to add a page to the right.</p> <p>Tap  to delete the selected page.</p>
Session name	<p>The default session name is “Untitled session”.</p> <div data-bbox="794 1111 1098 1178" style="border: 1px solid blue; padding: 2px; display: inline-block; margin: 10px auto;">  </div> <p>To rename the session, tap  and type in a new name at the prompt. Then tap Save.</p> <div data-bbox="746 1245 1142 1440" style="border: 1px solid blue; padding: 5px; margin: 10px auto;"> <p style="font-size: 8px; margin: 0;">Rename session</p> <div style="border-bottom: 1px solid gray; padding: 2px 0;"> Untitled session </div> <div style="display: flex; justify-content: center; gap: 20px; margin-top: 5px;"> Cancel Save </div> </div> <p>Note:</p> <ul style="list-style-type: none"> • You can also rename the session on the Creative Board Home tab. Select the session and then tap ⋮ ⇒ Rename. Tap Save at the prompt to save the modifications. <div data-bbox="826 1603 1062 1821" style="border: 1px solid blue; padding: 5px; margin: 10px auto;"> <div style="display: flex; justify-content: space-between; align-items: center;">   </div> <div style="margin-top: 5px;"> <p style="font-size: 8px; margin: 0;">Untitled session</p> <p style="font-size: 8px; margin: 0;">Modified 06:02 AM</p> <p style="font-size: 8px; margin: 0;">Owned by me</p> </div> </div> <ul style="list-style-type: none"> • If the session is marked with the  icon then it means it is an active collaboration session and if the icon is  then it means it is a inactive collaboration session. All other sessions are non-collaboration sessions. To access collaboration sessions, make sure to be logged in to Creative Board.

BASIC OPERATIONS

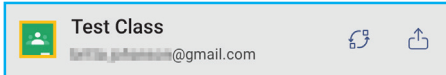
Item	Description
<p>Sign in</p>	<p>Sign in to Creative Board with your Creative Board account or with your Google account to create collaboration sessions.</p>  <p>When signed in, tap  to view account settings or tap  to log out.</p>
<p> Attendees management</p>	<p>Invite attendees to join the Google Classroom through the Creative Board. On the Attendees tab , tap  and then select any of the following options:</p>  <ul style="list-style-type: none"> • Through the Google Classroom • By sending an email invitation with the session password • By sending a session code. <p>On the Attendees tab you can assign a role to the attendee (either viewer or editor), delete ( ⇒ ) attendees, renew () the session code, and configure () attendee settings.</p> <p>Tap  to access the Group tab. Then tap  and enter the group information, such as group name and attendees. Tap Save.</p>  <p>To modify group settings, tap .</p>
<p> Google Classroom management</p>	<p>View the Google Classroom that is related to your sign in account. Tap  to change to another classroom or tap  to post session link to Google Classroom.</p> 



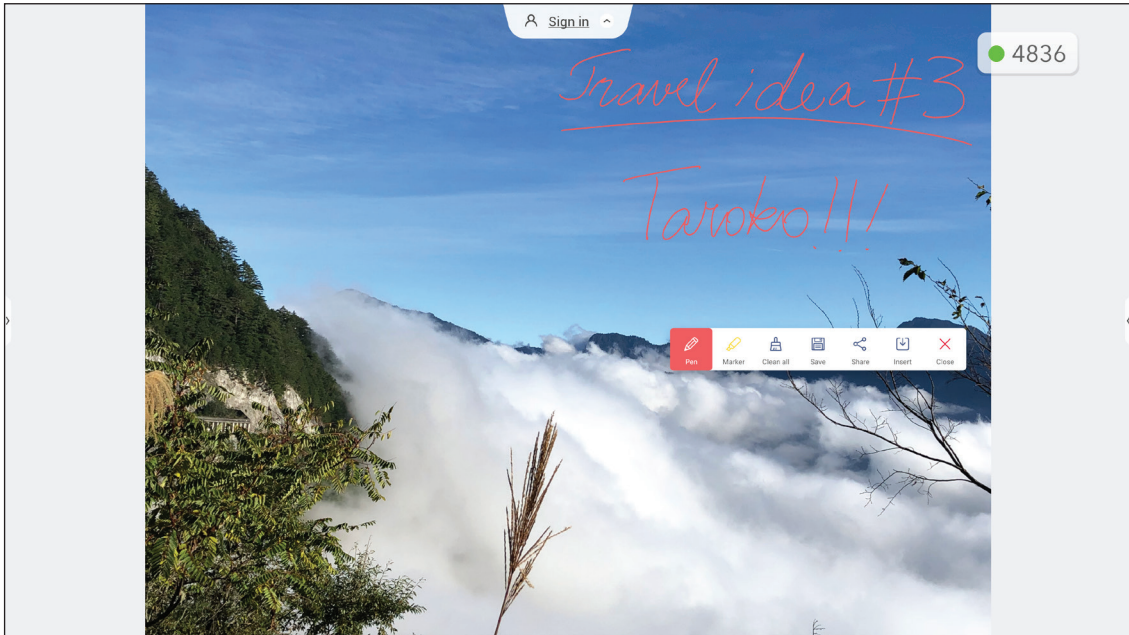

BASIC OPERATIONS

Annotation App



Tap > ⇒  to open the annotation app.



In this mode, you can do the following:

- Tap  to write and draw on the screen.
Note: You can change the pen color by tapping  repeatedly.
- Tap  to highlight the item on the screen.
Note: You can change the highlighter color by tapping  repeatedly.
- To erase all annotations on the screen, tap .
Note: You can also use the palm of your hand to erase the areas of your written texts or drawings.



- To capture a screenshot of the entire screen, tap .
- To share the annotation to other wireless devices, tap . Make sure your wireless device is connected to the same Wi-Fi network as the IFP and then scan the QR code with your wireless device.

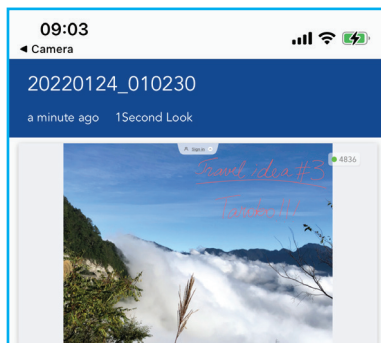



- To exit the annotation mode, tap .

BASIC OPERATIONS

Airshare

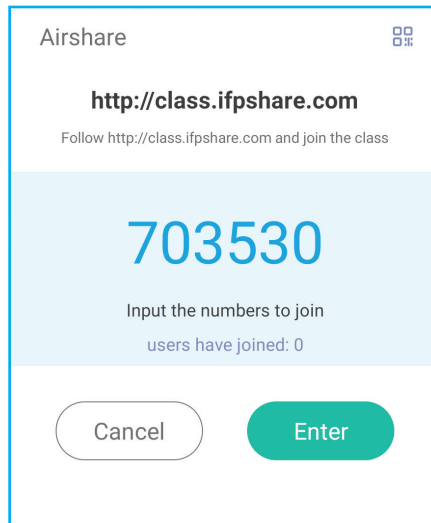
Tap > => **1+2** to open **Airshare**. The online classroom access code and URL will be displayed on the screen.



- To display the connection QR code, tap .



To join the virtual classroom remotely, complete the following steps:

1. Connect the IFP to an available network.
2. On your mobile device, enable Wi-Fi function.

IMPORTANT! Make sure you have access to the Internet throughout the entire online session.

3. Open the classroom URL in a web browser and enter the access code or scan the access QR code. Then enter your name and tap **Enter** to join the class.

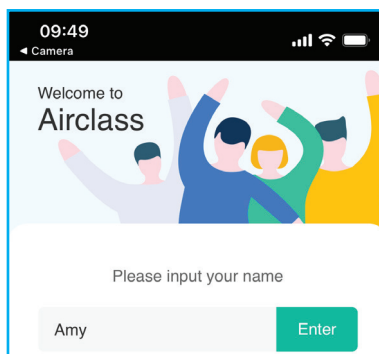

BASIC OPERATIONS

4. On the IFP, tap **Enter** to start the class session.

To participate in the class, do the following:

Launch the **Creative Board** app. Then use the following functions:

a. Voter

1. Tap  to enter the Voter interface.
2. Select **Single choice** or **Multiple choice** to define the answer type.
3. Tap **Begin** to start answering the question.

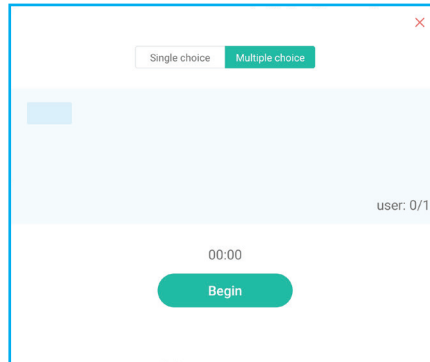

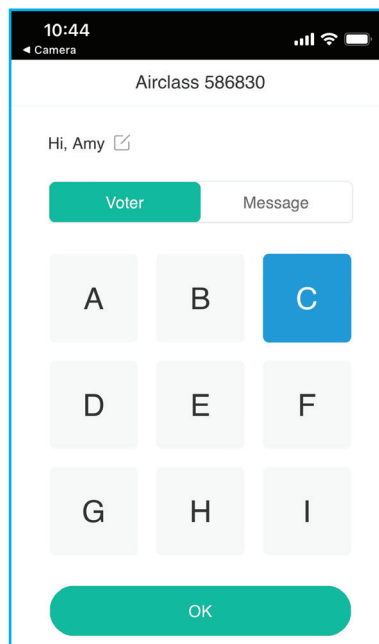

4. The participant can respond by selecting the answer on the mobile device screen and tapping **OK**.

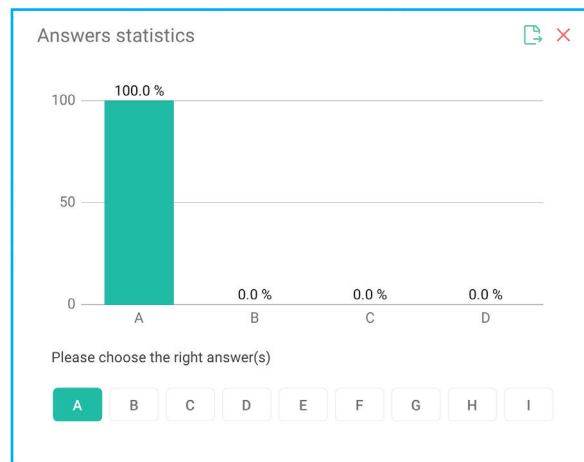

BASIC OPERATIONS

5. To close the answering session, tap **Finish**. The Answer statistics will be displayed on the screen.
6. Tap the right answer(s) on the statistics screen.



- Tap  to save and export the result.
- Tap  to close the Answer statistics page.

b. Responder

1. Tap  to enter the Responder mode. Then tap **Start** to start the answering mode.

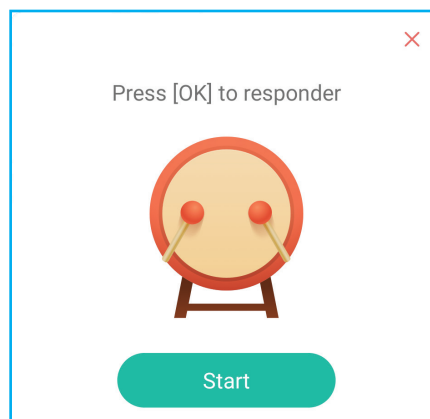

BASIC OPERATIONS

- When the function is activated, the person who taps **Be fast** first will get the right to answer. For example, if Amy first taps **Be fast**, then she will get the right to answer the question.
 - Tap **Reset** to start the answering mode again.

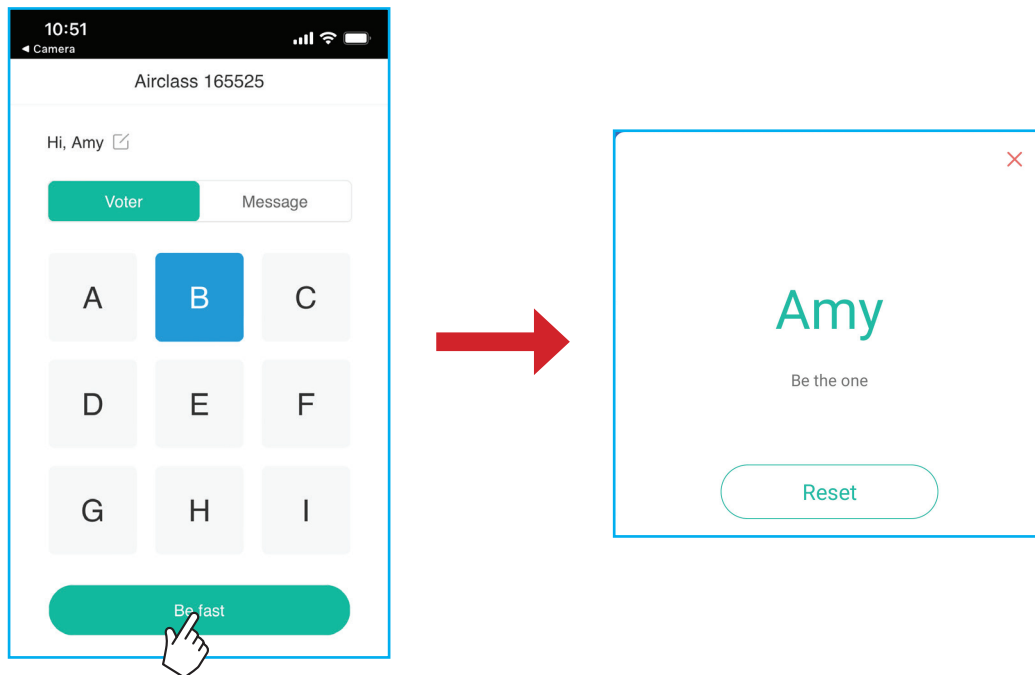

c. Selector

Tap  to enter the selector mode. Select the number of person(s) whom will be selected. Then tap **START**. The result is displayed on the screen.

- Tap **Reset** to select again.

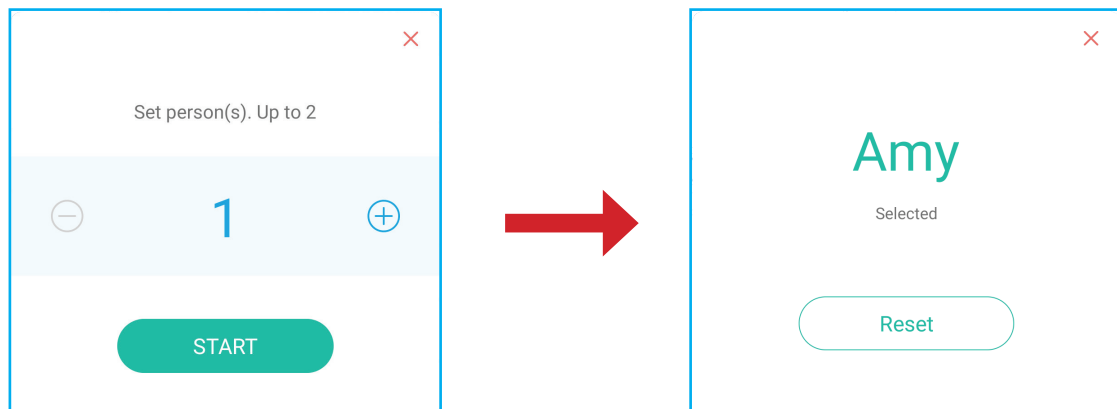

BASIC OPERATIONS

d. Message

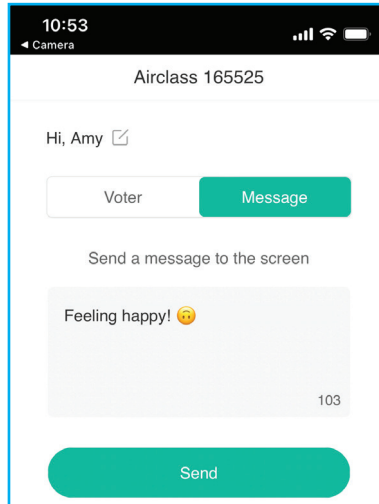

1. Make sure the message function is enabled  ⇒ .
2. On the mobile device, tap **Message** to switch to the Message screen, then enter your message in the comment text box and tap **Send**.



The broadcast message will appear on the IFP screen.



Note:

- Tap  to display the class access code, URL, QR code and allow more participants to join the class.
- Tap  to export the result.
- Tap  to exit **Airshare**. Confirm **Exit** at the prompt. All classroom users will be logged off.

BASIC OPERATIONS







Screen Recorder

Tap > ⇒  to open screen recording utility. This utility helps you to record video from the IFP's screen and connected camera screen (if enabled).

Note:

- You can drag the recording utility to your preferred location on the screen.
- The screen recording utility can be used only with Android source.





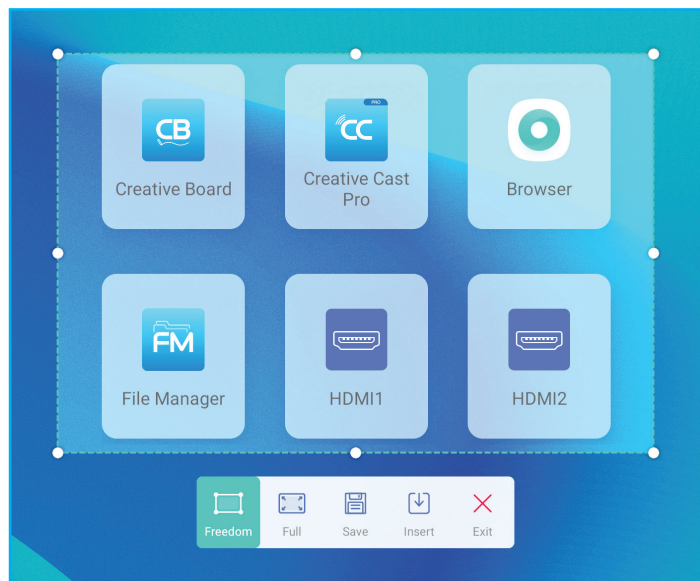

- Tap  to start recording the screen. The recording starts 3 seconds after you tap . While recording, tap  to pause recording or  to stop recording. Then tap **OK** to save the recording.
- Tap  to configure recording settings: enable or disable connected camera recording, select the preferred video resolution, and select the path where you want the recordings to be saved.
Note: By default, all recordings are saved to the Storage/Record folder.
- Tap  to close the recording tool.

Screen Capture Tool

Tap > ⇒  to open the screen capture tool.



To capture the screen, do the following:







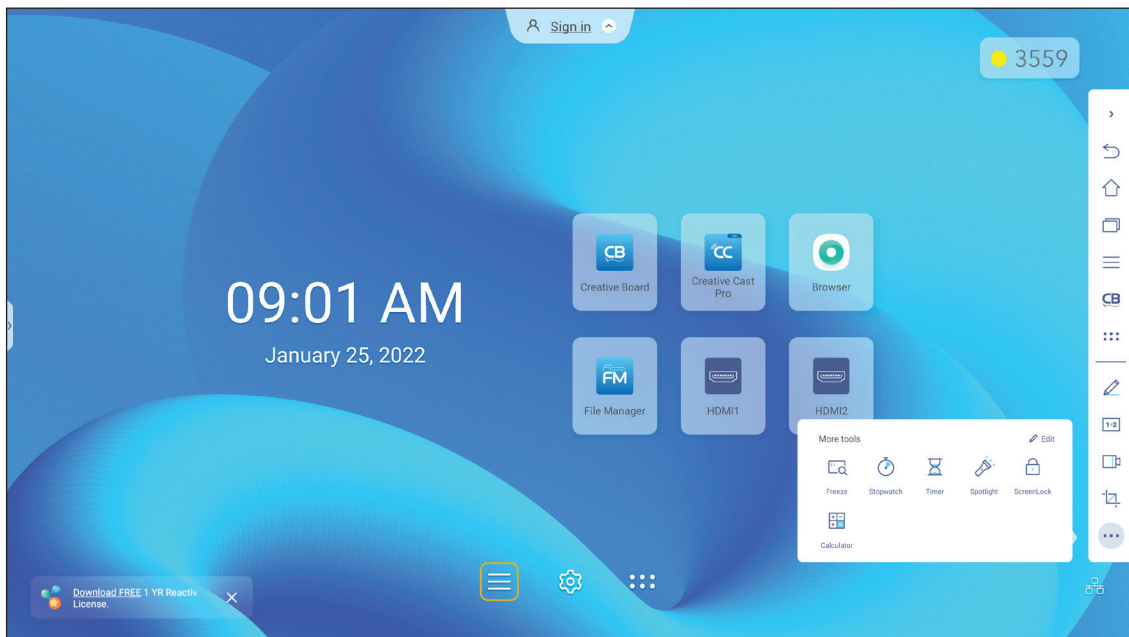

1. Tap either  or  to manually select the area or to capture the entire screen respectively.
2. Tap  to save the screenshot or tap  to insert the screenshot directly to the whiteboard session.
Note: To use this feature, please start a **Creative Board** session **FIRST**, then use this tool to capture and then insert the screenshot to the **Creative Board**.
3. Tap  to exit the tool.

BASIC OPERATIONS

More Tools

Tap > ⇒ ⋮ to access more tools such as **Freeze**, **Stopwatch**, **Timer**, **Spotlight**, **ScreenLock**, and **Calculator**.



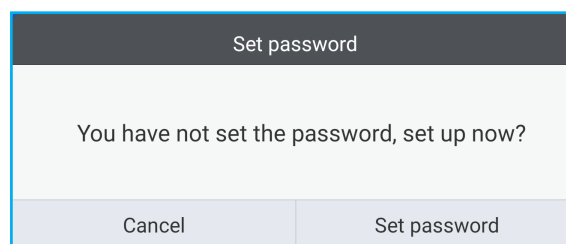

- Tap **Freeze**  to freeze the screen. Then tap  to zoom in or tap  to zoom out. To restore the screen to its original size, tap . Finally, to exit the tool, tap .
- Tap  to use the **Stopwatch**.
- Tap  to use the **Timer**.
- Tap  to activate **Spotlight**. **Spotlight** can be used to direct the audience's focus to a specific part of the board.
- Tap  to lock the screen (**ScreenLock**). If the screen lock password is not set, you are prompted to set the password. Follow the onscreen instructions to complete the procedure.



- Tap  to use the **Calculator**.

BASIC OPERATIONS







To customize More tools icons in the side toolbar, tap > => ... => **Edit**. Then tap  next to the icon you want to remove from the side toolbar and tap  next to the icon you want to add to the side toolbar. You can add up to 4 icons to the side toolbar.

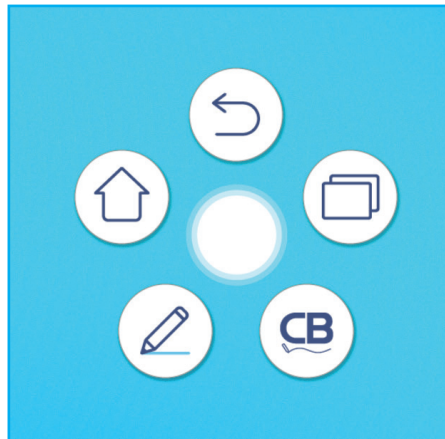

Floating Annotation Toolbar

Touch and hold the screen with your two fingertips, a centimeter apart from each other. The floating annotation toolbar opens.



- Tap  to return to the previous screen.
- Tap  to return to Home screen.
- Tap  to open annotation app.
- Tap  to open **Creative Board**.
- Tap  to view recent apps. Tap the app you want to switch to or tap  to close the annotation toolbar.

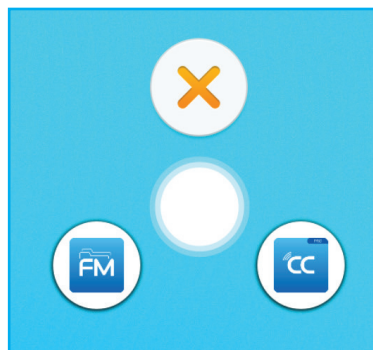

- Tap  and drag the annotation toolbar to your preferred location on the screen.

USING THE APPS

From the Home screen, tap **⋮** to view the Apps list.

Note: To install a third party application, you have to enable the **Unknown sources** setting first in the **Advanced Settings** ⇒ **Security** menu. Refer to “Configuring Security Settings” on page 45.

You can then install the downloaded APK (Android Package) file into your system.

IMPORTANT! The embedded Android 9.0 operation system is not standard Android. As such, Google Play is not available in the Apps list. The installed third party application might not work properly if it is not designed for IFP. Optoma will not guarantee that these self-installed Apps work. Optoma interactive flat panel displays run a customized Android operating system and do not support Google Play Services. The operating system may not be compatible with all third-party Android apps. Third-party Android apps can vary in quality and some even contain malicious codes, which could compromise system security and may invalidate product warranty. Optoma makes no representations regarding the quality, security or suitability of any third-party apps and their compatibility with the Optoma interactive flat panel. Optoma shall have no responsibility or liability with respect to any damage, faults, loss in functionality or security issues arising as a direct or indirect result of the installation of third-party apps on the interactive flat panel. Optoma support in rectifying any issue which may result from the installation of third-party apps will be chargeable and may be limited. Information is correct at the time of writing and is subject to change.

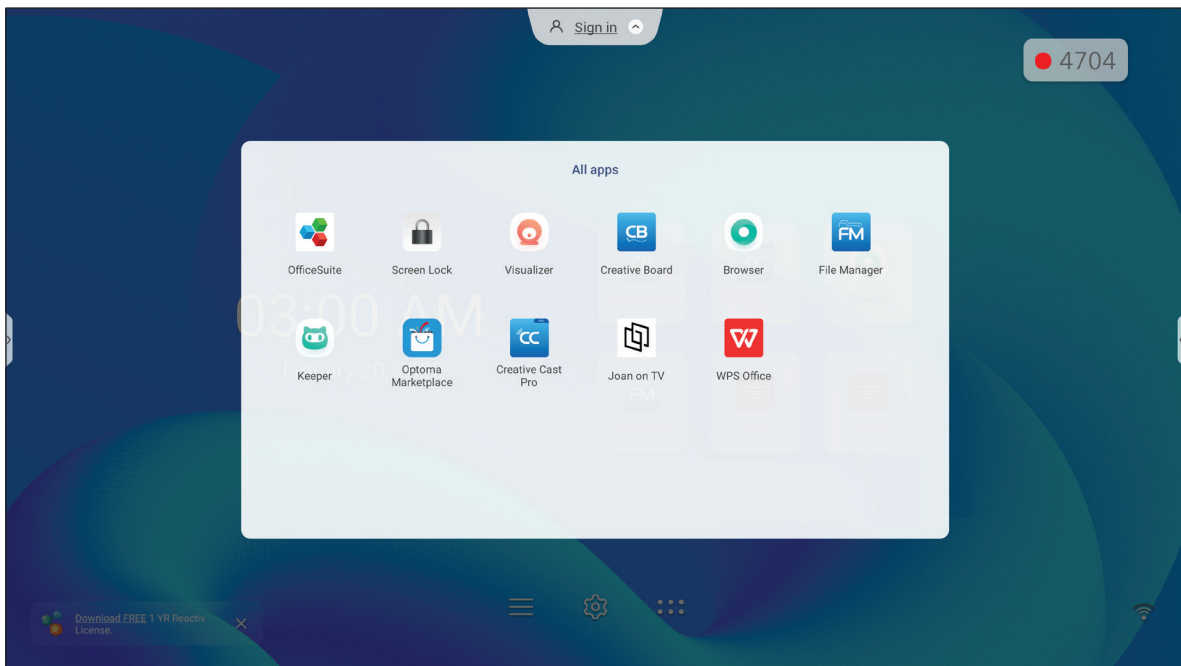

USING THE APPS





Creative Cast

Tap  **Creative Cast** to start wireless sharing and projection via Wi-Fi or LAN.

IMPORTANT!

- *The IFP and your mobile device/computer must be connected to the same Wi-Fi or LAN network.*
- *While in use, make sure that you have access to the Internet.*

Supported Operating Systems for Casting

Collavision Senders	Available Version
 Windows	Windows 10, 11 and above
 Mac	Mac OS X 10.12 and above
 iPhone	iOS 13 and above
 Android	Android 9.0 and above
 Chrome	Chromebook OS V74 and above

Proprietary Sharing

Features	Operation System
Web Sharing (Web Sender)	Chrome Browser
AirPlay Support	iOS 9 and above
ChromeCast	

USING THE APPS

Mobile Device

When the setup guide screen appears, scan the QR code to download and install the **Creative Cast** app onto your mobile device.

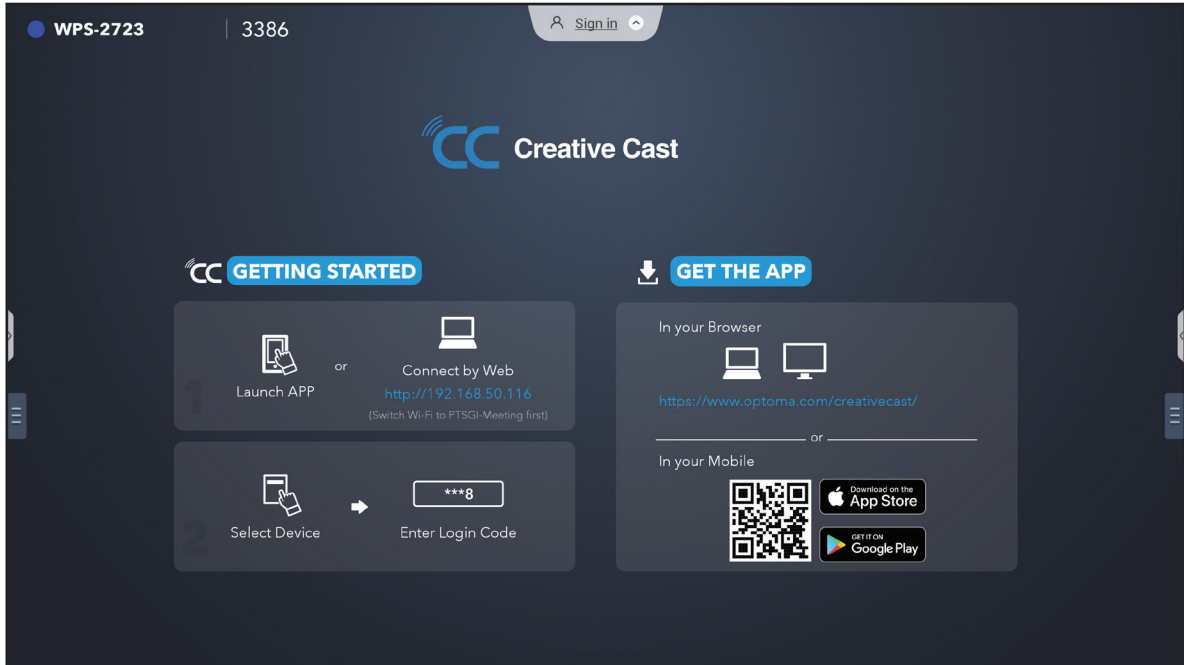

To connect to the IFP, complete the following steps:

Note: The connection steps are described based on an iOS device.

1. Launch the **Creative Cast**  app. Select the device and then tap **Start Broadcast**.

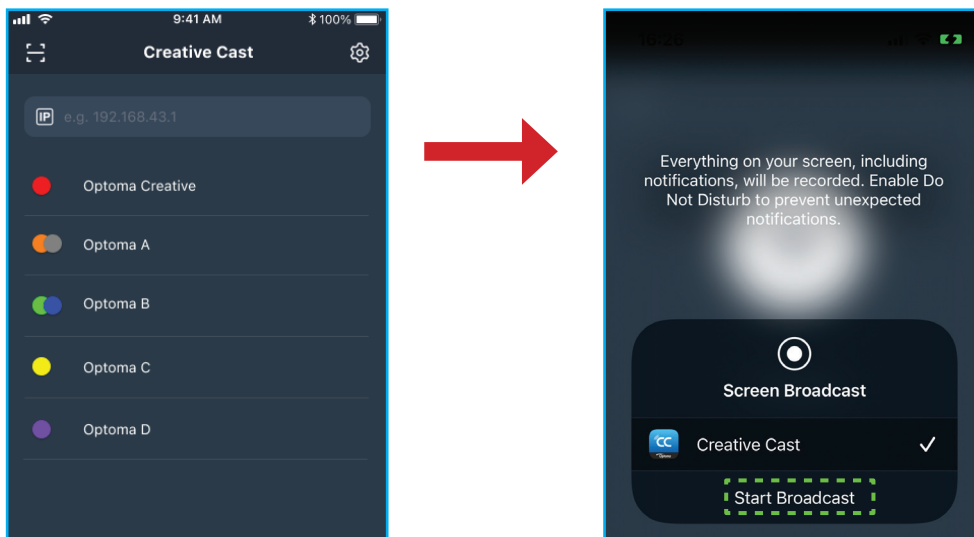

USING THE APPS

2. Enter the **Creative Cast** verification code from the launcher screen to establish the connection.

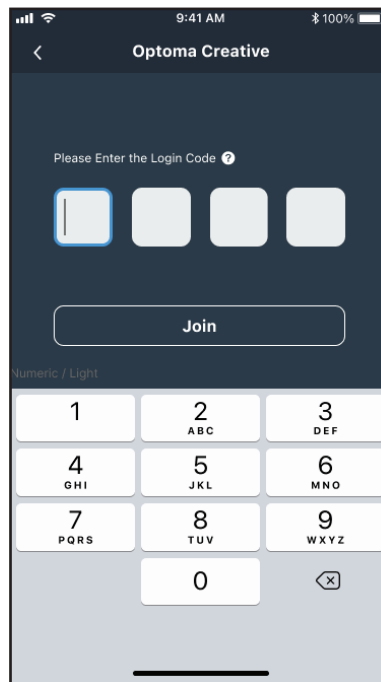

3. Tap any of the following:

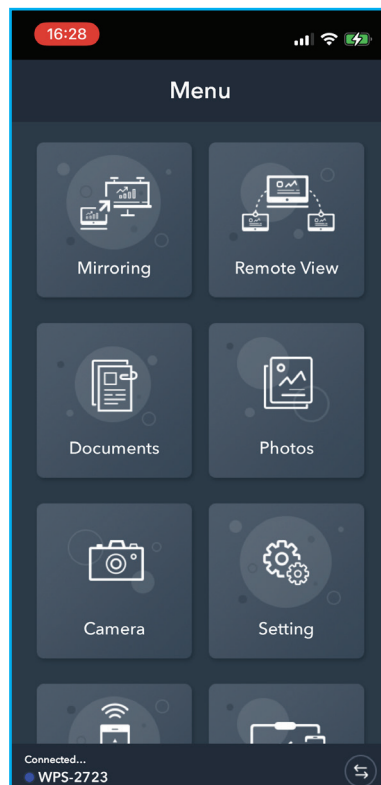

USING THE APPS

- **Mirroring** to mirror your mobile device's screen to the IFP.
 - **Remote View** to mirror the IFP screen to your mobile device with annotation and image saving feature.
 - **Document** to view and share documents.
 - **Photo** to view and share photos.
 - **Camera** to stream your mobile device's camera to the IFP.
 - **Settings** to modify your mobile device's user name and view the **Creative Cast** version.
 - **Smart Control** to use your mobile device as a remote control to control the IFP.
 - **Screen Control** to mirror the IFP screen to your mobile device. You can use your mobile device to operate the IFP.
 - **Custom Menu** to customize the **Creative Cast** menu in your mobile device.
4. To stop the screen broadcast, tap .

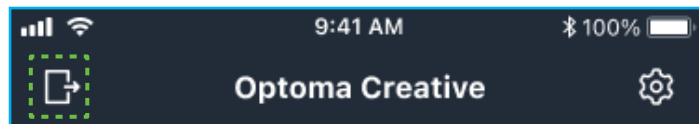

Computer

You can mirror the screen of your computer via Chrome browser or **Creative Cast**. To use either of these options, open the browser and enter to the URL field the IP address that is displayed on the launcher screen. For example, <http://10.5.13.83>.

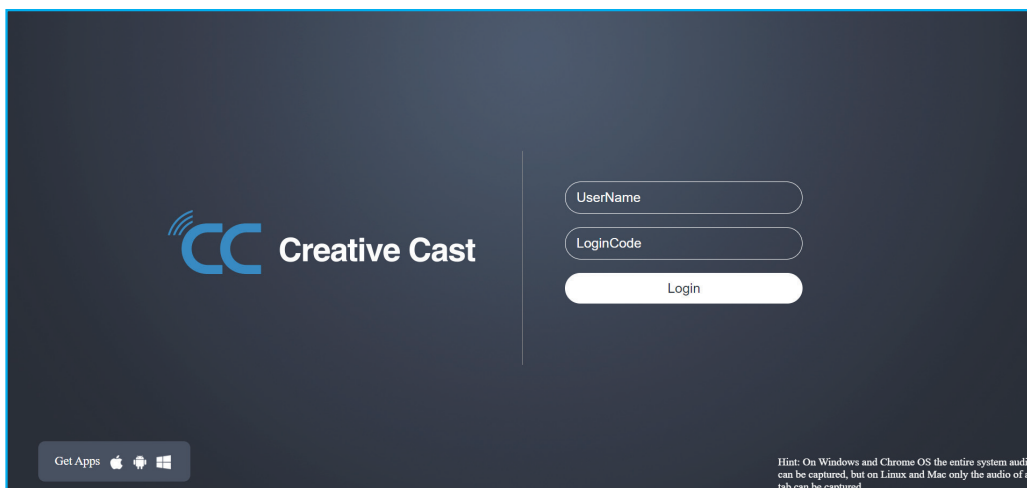

- To download **Creative Cast**, tap on the respective operating system icon next to **Get Apps** link.

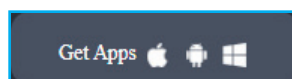

USING THE APPS

- To start screen casting from Chrome browser, enter your preferred user name (UserName), LoginCode (verification code on the launcher screen) and tap **Login**. Select what you want to share and then click **Share**.

Note:

- If you want to share audio during screen casting, tap  on the launcher screen.

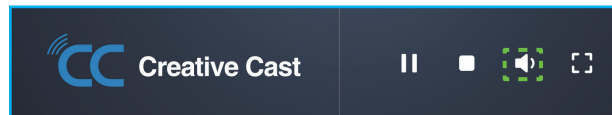

- The user name that you enter for screen casting will be used also in Moderation mode.

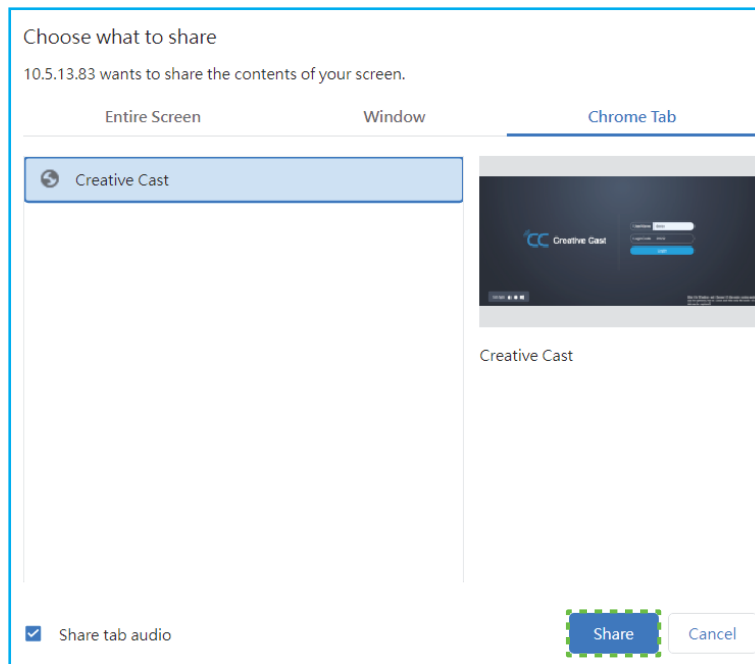

To stop sharing, do either of the following:

- Click **Stop sharing** on your browser or

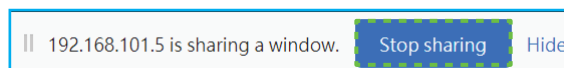

- Click  on the launcher screen.

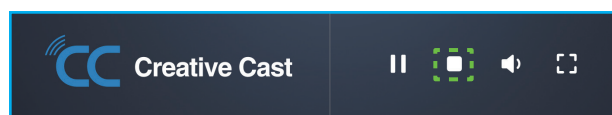

USING THE APPS

To start screen casting from desktop app, download the **Creative Cast** to your computer.

1. Launch the app and click on the device name.
 - If the IFP is not visible in the Room List, input the IFP's IP address manually to the Input IP address field. Press **Enter** to start searching for the device.

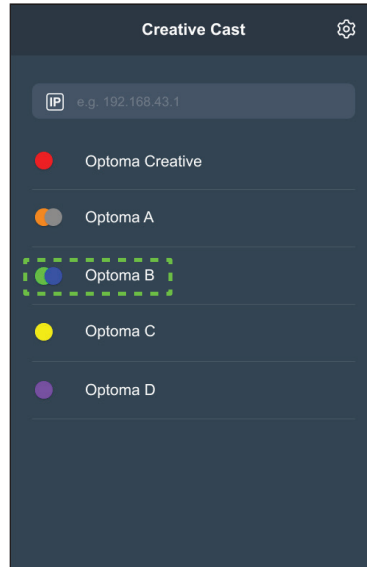

2. Enter the login code from the launcher screen and tap **Join**.

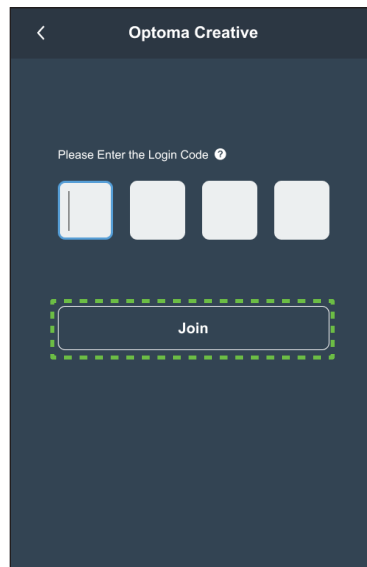

USING THE APPS

3. Click any of the following:

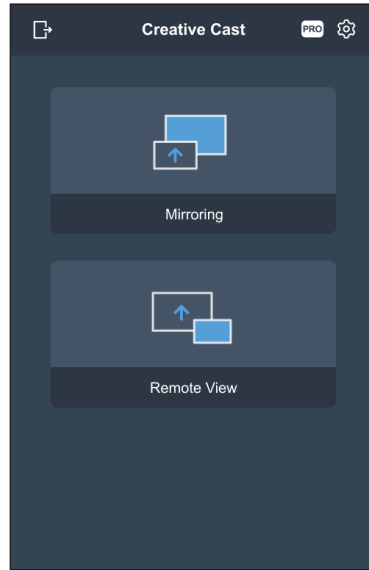

- **Mirroring** to mirror your computer's screen to the IFP.
- **Remote View** to mirror the IFP screen to your computer with annotation and image saving feature.
- **PRO (Moderation Mode)** to select up to 4 screens to display on the IFP. Enter the password (default: admin) and click **Start**.

Note: To modify the password, refer to “Creative Cast Settings” on page 79.

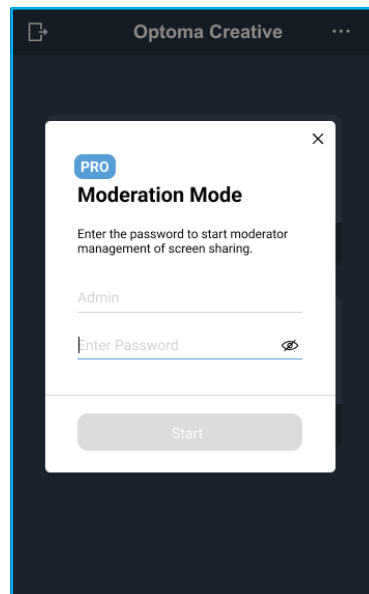

USING THE APPS

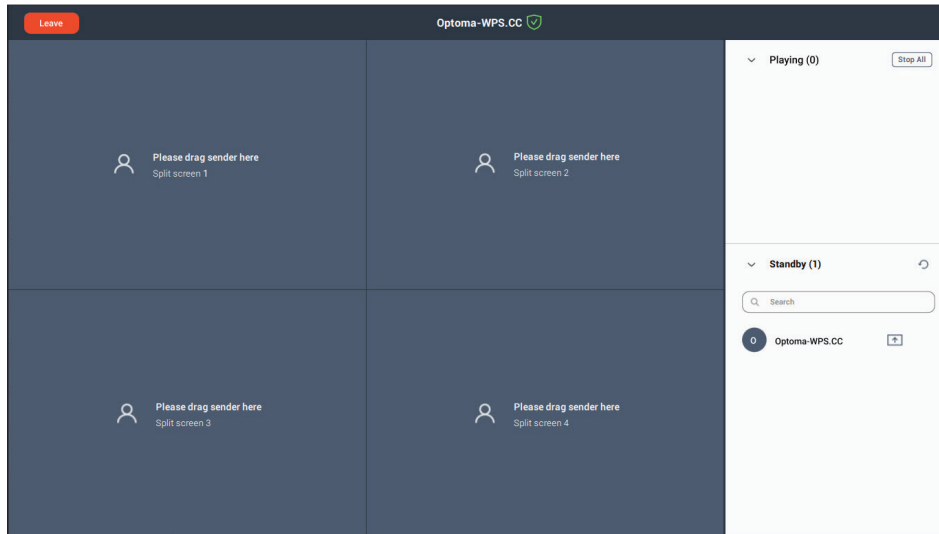

Select the screens to display.



4. To exit the moderation mode, tap **Leave** .

Creative Cast Settings

Tap  and then tap on any of the following icons to configure the **Creative Cast** launcher screen settings:

- **Grouping**  to share the screen to other devices.
- **Settings**  to manage connection settings, view **Creative Cast** version and upgrade software, configure login code settings, set the administrator password for the Moderator user, and enable or disable floating window feature.

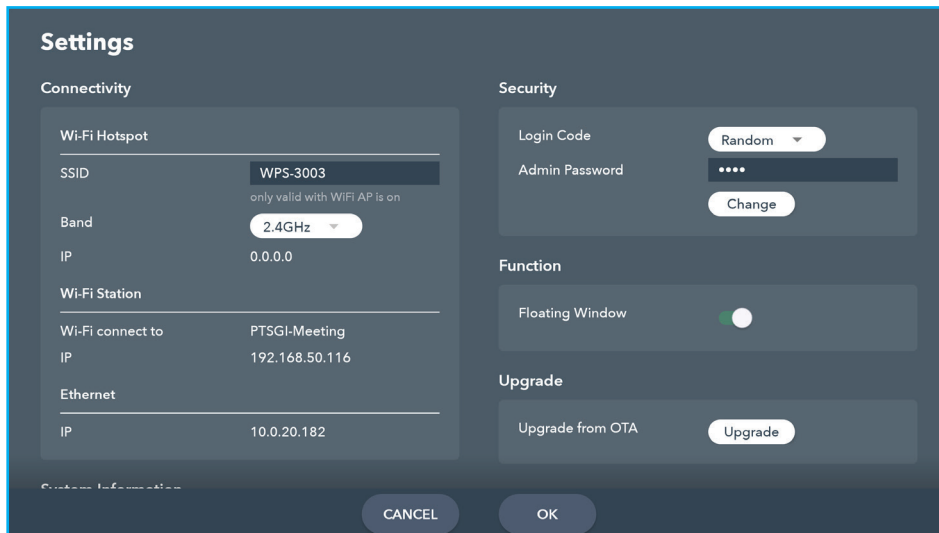

- **Minimize**  the menu bar.

USING THE APPS







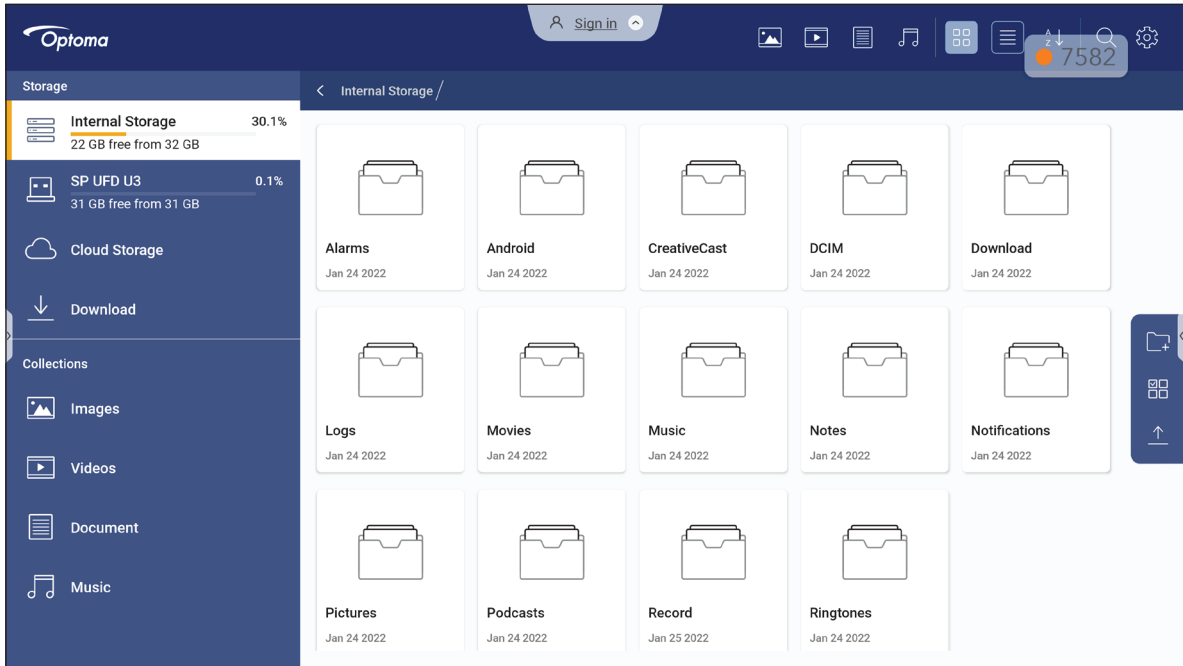



File Manager

Tap **File Manager** to manage files and folders.















Managing Files



Select a storage location and browse for a file or folder you want to view then tap twice on a file or folder to open. The table below will help you navigate **File Manager** and its included features.

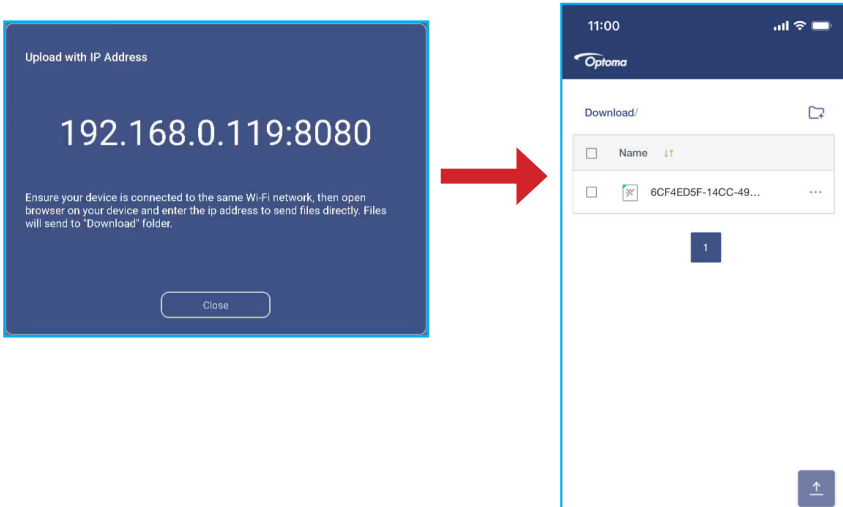

Item	Description
 Images	Display only image files in the selected storage location.
 Videos	Display only video files in the selected storage location.
 Document	Display only document files in the selected storage location.
 Music	Display only audio files in the selected storage location.
 Thumbnail view	View files and folders as thumbnails.
 List view	View files and folders as a list.
 Sort	Sort files and folders by name or by date in ascending or descending order.
 Search	Search files and folders using key words or names.
 Software version	View software version and update app (if necessary).
 New Folder	Add a new folder.

USING THE APPS

Item	Description
 <p>Select</p>	<p>Select files and folders. When selected, tap any of the following:</p> <ul style="list-style-type: none">  undo your last action.  check/uncheck all items.  cut and paste item(s).  copy and paste item(s).  delete item(s).  rename an item.  share an item with QR code. <p>Note: For file sharing with QR code, make sure your mobile device is connected to the same network as the IFP.</p> <div style="text-align: center;">  </div> <ul style="list-style-type: none">  compress item(s).  move/copy item(s) to another location or view item details.
 <p>Share item(s)</p>	<p>Share item(s) between the IFP and your mobile device over web browser.</p> <div style="text-align: center;">  </div> <p>Note:</p> <ul style="list-style-type: none"> By default, all items that you upload to the IFP are saved to Download  folder. For item(s) upload, make sure your mobile device is connected to the same network as the IFP.

USING THE APPS

Cloud Storage

Tap **File Manager**  ⇒ **Cloud Storage**  to create an account or use an existing account to access your cloud storage.

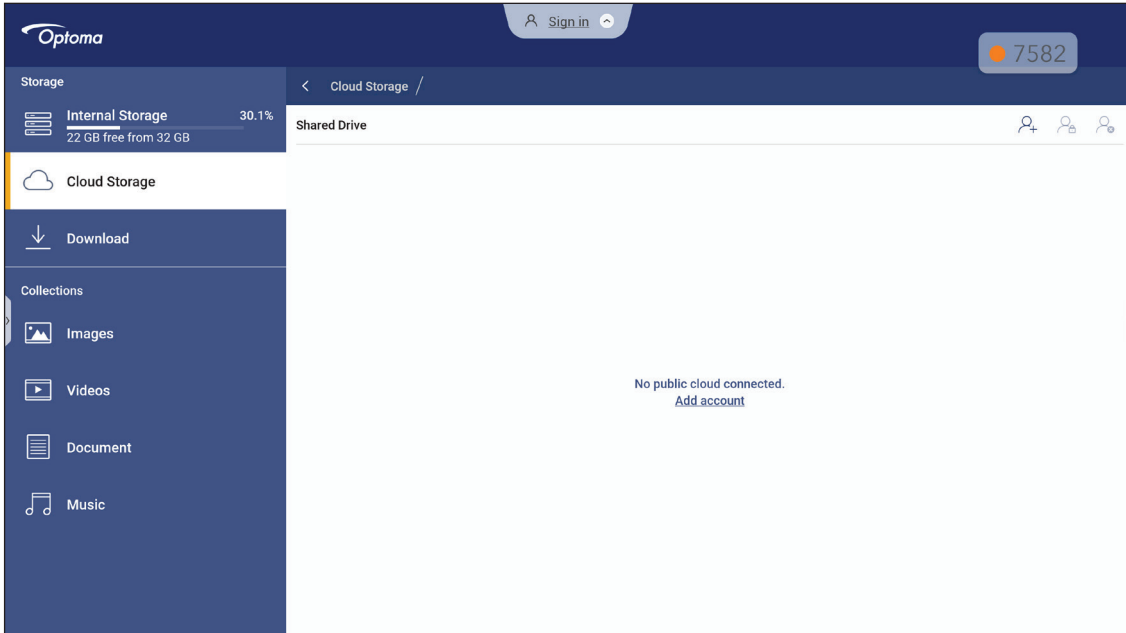

To create an account:

1. Tap  or **Add account**.
2. Select the drive type.

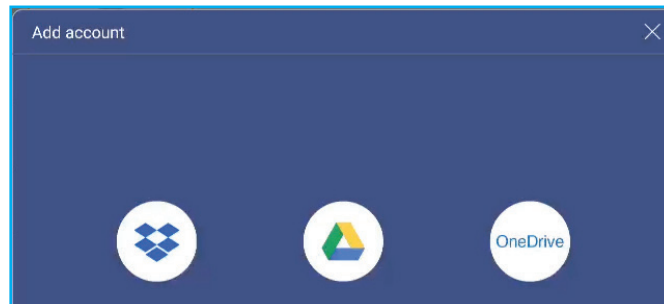

3. Follow on-screen instructions to create an account or sign in to your existing account.
4. After successful login, you are prompted to set a security PIN. Tap **Setup** to set the PIN or **Skip** to skip this step.

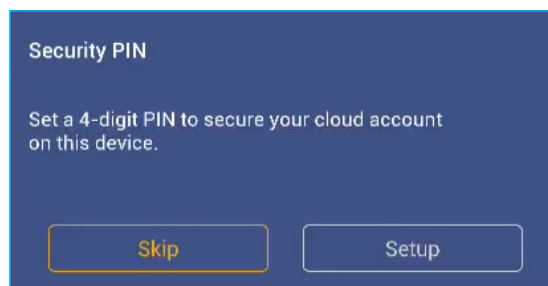



Note: PIN code is used to protect user's cloud storage from being illegally accessed. When system status changes (for example, from standby to normal, from backlight off to on), a user must key in the PIN code the set up for verification in order to access their cloud storage..

Your account will be listed in the **Cloud Storage** menu.

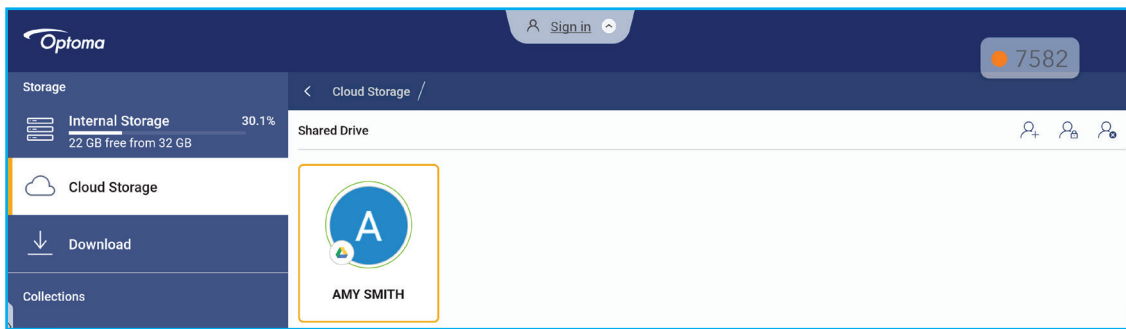
USING THE APPS



5. To manage your cloud storage account(s) in the **File Manager**, tap any of the following:

-  to add another cloud storage account.
-  to lock the cloud storage account.
-  to delete the cloud storage account.

Note: Locking and deleting the cloud storage account in the **File Manager** will only prevent or remove access to that cloud storage in the **File Manager** and will not lock or delete the cloud storage in its original location, for example in Google.

Playing Multimedia Files

Multimedia formats supported

Media Type	Supported Format
Video	<p>Video support format (codec) up to 4K resolution:</p> <ul style="list-style-type: none"> • .avi (MPEG-1, MPEG-2 MP@HL, MPEG-4 SP@L0-3, ASP@L0-5, H.264, MP, HP@Level 4.1, H263, VP6, MJPEG) • .ts (MPEG-2 MP@HL, MPEG-4 SP@L0-3, ASP@L0-5, H.264 MP, HP@Level 4.1, VC1 AP, H265) • .mpg, .mpeg (MPEG-1, MPEG-2 MP@HL, H.264 MP, HP@Level 4.1) • .mp4 (MPEG-4 SP@L0-3, ASP@L0-5, H.264 MP, HP@Level 4.1, H265) • .mov (MPEG-4 SP@L0-3, ASP@L0-5, MJPEG, H.264 MP, HP@Level 4.1, H265) • .mkv (VP9, H.265) • 3gp (H.264 MP, HP@Level 4.1, H263, MPEG-4 SP@L0-3, ASP@L0-5)
Audio	<p>Audio support format (codec):</p> <ul style="list-style-type: none"> • .wma (WMA/WMAPro: 128Kbps~320Kbps, 8KHz~48KHz sampling rate) • .mp3 (MPEG Layer 3: 32Kbps~320Kbps, 32KHz~48KHz sampling rate) • .wav (PCM: Max 320Kbps, Max 48kHz sampling rate / ADPCM: 384Kbps, 8KHz ~ 48KHz sampling rate) • .m4a (ACC: 24kbps ~ 384kbps, 16KHz~48KHz sampling rate) • .ogg (Vorbis: Max 320Kbps, 8KHz~48KHz sampling rate)
Image	<p>Supported image format (with the maximum resolution):</p> <ul style="list-style-type: none"> • .png (8k*8k) • .jpeg (baseline 8k*8k; progressive 4k*4k) • .bmp (8k*8k) • .gif (4k*4k)

USING THE APPS

Playing videos

Select the video you want play and tap twice on it to start playback.

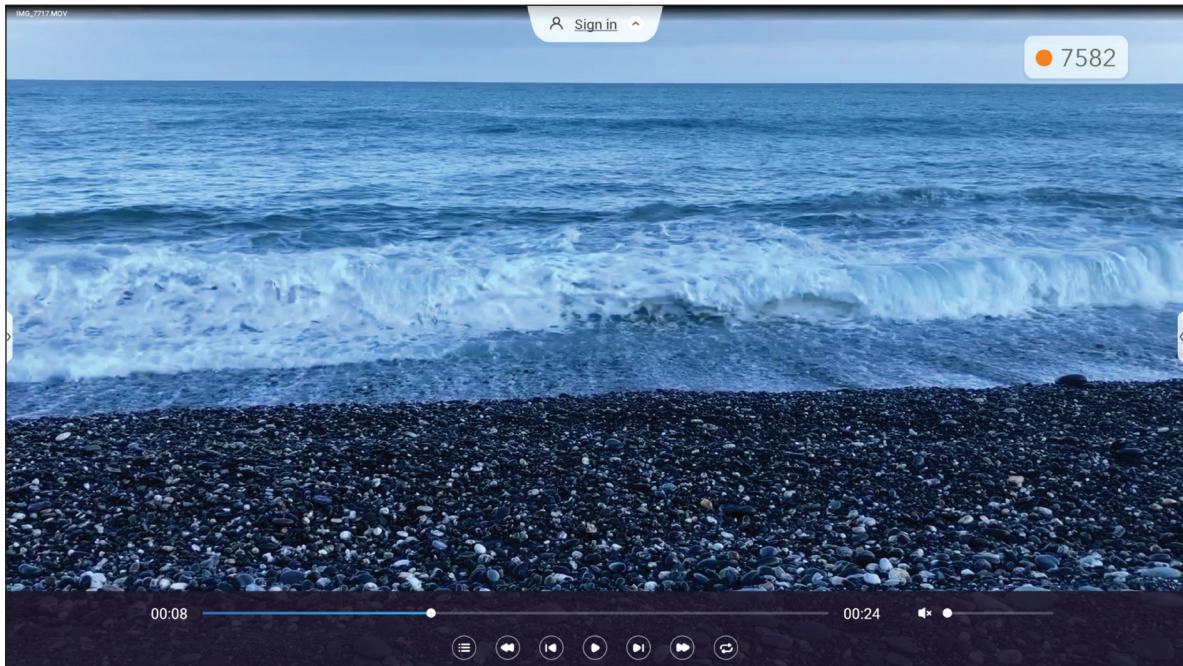

During the playback tap on the screen to open the playback control toolbar. Then tap any of the following:

Item	Description
	List Display video thumbnails.
	Rewind Rewind video.
	Previous video Skip to the previous video.
	Pause/Play toggle Tap to Pause the playback. To resume, tap .
	Next video Skip to the next video.
	Fast forward Fast forward video.
	Loop/Play once toggle Tap to play all video files in a loop or tap to play the current video file in a loop. Tap to play through all videos in the list once.
	Volume control Adjust the volume level.

Note: To stop playback, open the side toolbar and tap or press the **Back** button on the remote control.

USING THE APPS

Playing music

Select the audio track you want to play and tap twice on it to start playback.

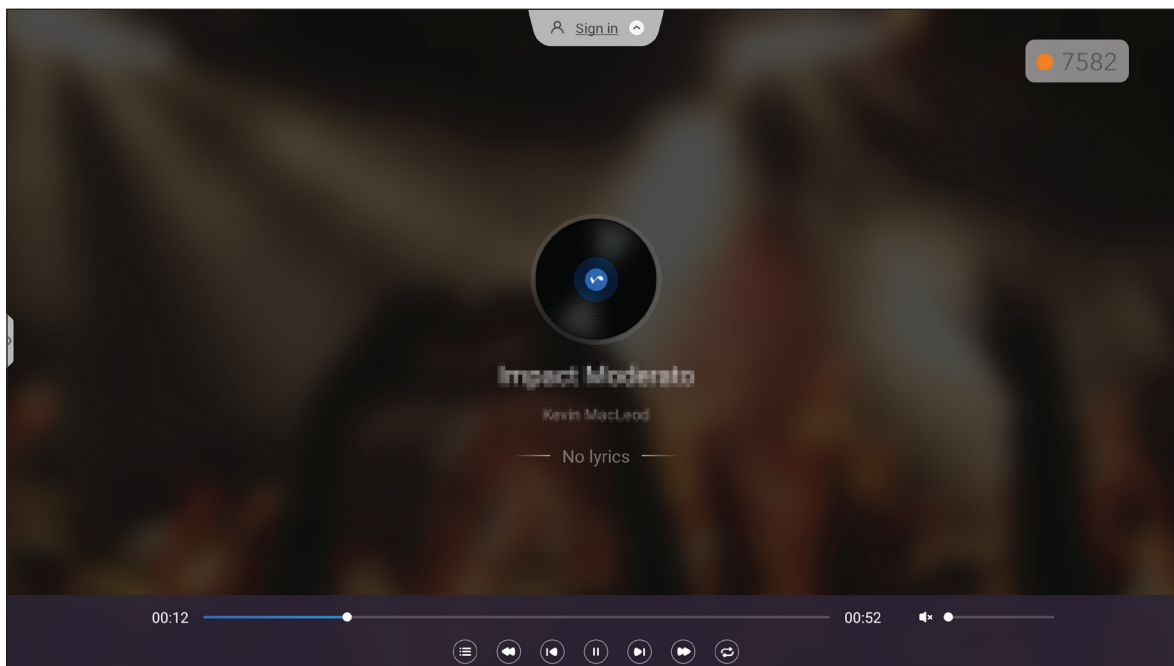

During playback tap on the screen to open the playback control toolbar. The table below explains the functions available on the playback control toolbar.

Item		Description
	List	Display track list.
	Rewind	Rewind the track.
	Previous track	Return to the previous track.
	Pause/Play toggle	Tap to Pause playback. To resume, tap .
	Next track	Skip to the next track.
	Fast forward	Fast forward the track.
	Loop/Play once toggle	Tap to play all tracks in a loop or tap to play the current track in a loop. Tap to play through all tracks in the list once.
	Volume control	Adjust the volume level.

Note: To stop playback, open the side toolbar and tap or press the **Back** button on the remote control.

USING THE APPS

Viewing images

Select the image you want to display and tap twice to open it on the screen.

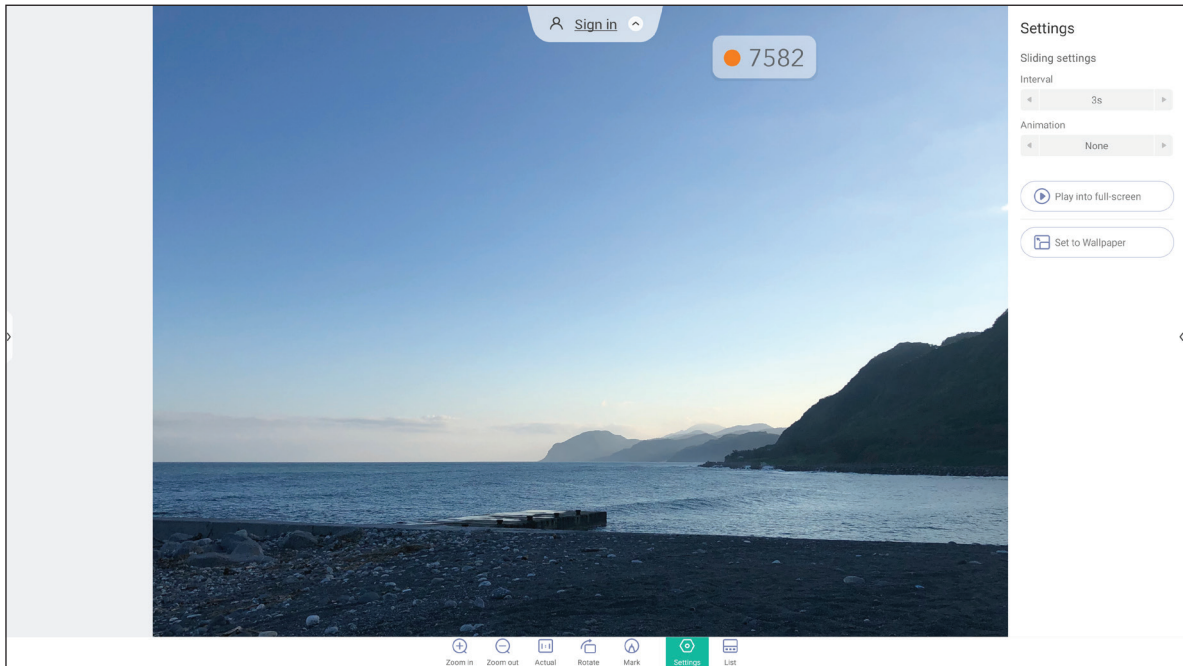

Tap on the screen to open the image control toolbar. The table below explains the functions available on the image control toolbar.

Item		Description
	Zoom in/Zoom out	Magnify the image or zoom out on the magnified image. <ul style="list-style-type: none"> As an alternative, touch the screen with your two fingers and move them apart to zoom in or together to zoom out.
	Actual	Display the image in its actual size.
	Rotate	Rotate the image clockwise.
	Mark	Annotate over the image.
	Settings	<ul style="list-style-type: none"> Configure the slideshow settings and tap Play into full-screen to start the slideshow. Tap to stop the slideshow. Tap Set to Wallpaper to set the image as the device wallpaper.
	List	Display image list.

Note: To return to the file manager, open the side toolbar and tap or press the **Back** button on the remote control.

USING THE APPS

Screen Lock

Tap **Screen Lock** to set the 4-digit pin code. Using the pin code, you can block the IFP from unauthorized use.

To set the pin code for the first time, launch the **Screen Lock** app. Then tap **Set password**.

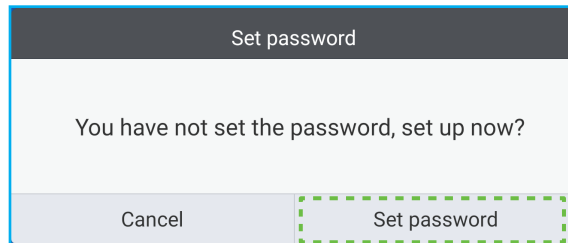

The Advanced Settings ⇒ Security menu will open. To set the password, refer to “Configuring Security Settings” on page 45.

Browser

Tap **Browser** to access web pages.

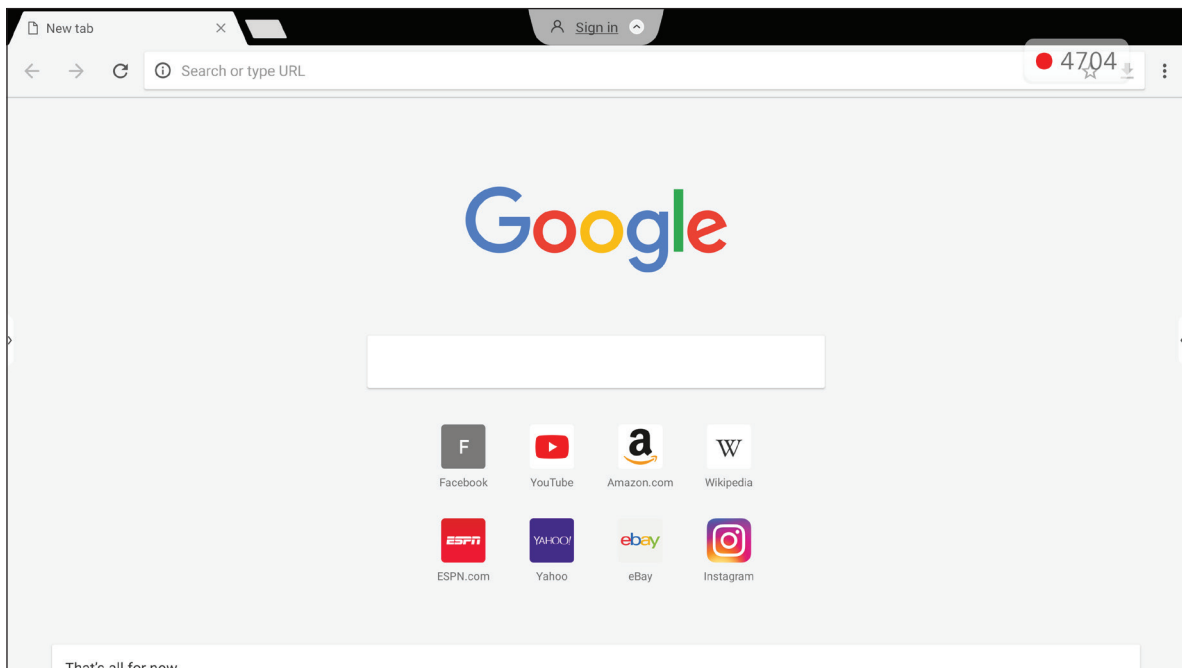

USING THE APPS

Optoma Marketplace

Tap **Optoma Marketplace** to visit the built-in app store and to download and install other third-party apps to the IFP.

Note: To install third-party apps, make sure the **Install app from marketplace** option is enabled in the Settings ⇒ Security ⇒ Advanced Setting ⇒ Permissions section. Refer to page 46.

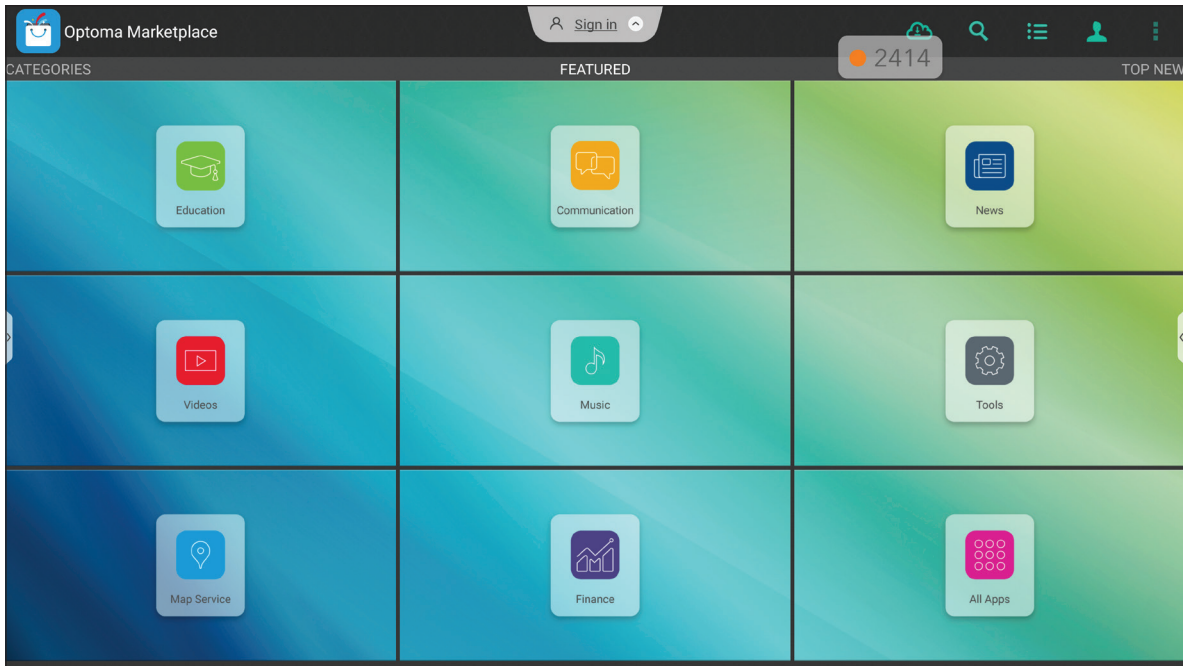

Disclaimer for unauthorized apps on Creative Touch range Android-based interactive displays



For system security, Optoma's Creative Touch interactive flat panel displays run on a customized Android operating system. Additionally, Optoma interactive flat panel displays do not support Google Play Services. Optoma has streamlined the Android operating system so only modules related to display features remain. The customized Android operating system may not be compatible with all third-party Android apps. Third-party Android apps can vary in quality and some even contain malicious codes, which could compromise system security and functionality and may invalidate your product warranty.

Optoma makes no representations regarding the quality, security or suitability of any third-party apps and their compatibility with the Optoma interactive flat panel. Optoma shall have no responsibility or liability with respect to any damage, faults, loss in functionality or security issues arising as a direct or indirect result of the installation of third-party apps on the interactive flat panel. Optoma support in rectifying any issue which may result from the installation of third-party apps will be chargeable and may be limited.

USING THE APPS

Keeper

Tap **Keeper** to open the **Keeper** app and begin cleaning and optimizing the data on the IFP.

- For automatic cleaning of the memory, deleting temporary and junk files, tap **One Key Optimize**.
- For manual cleaning of the memory, tap **Clean Memory** . For manual deleting temporary and junk files, tap **Clean Trash** .

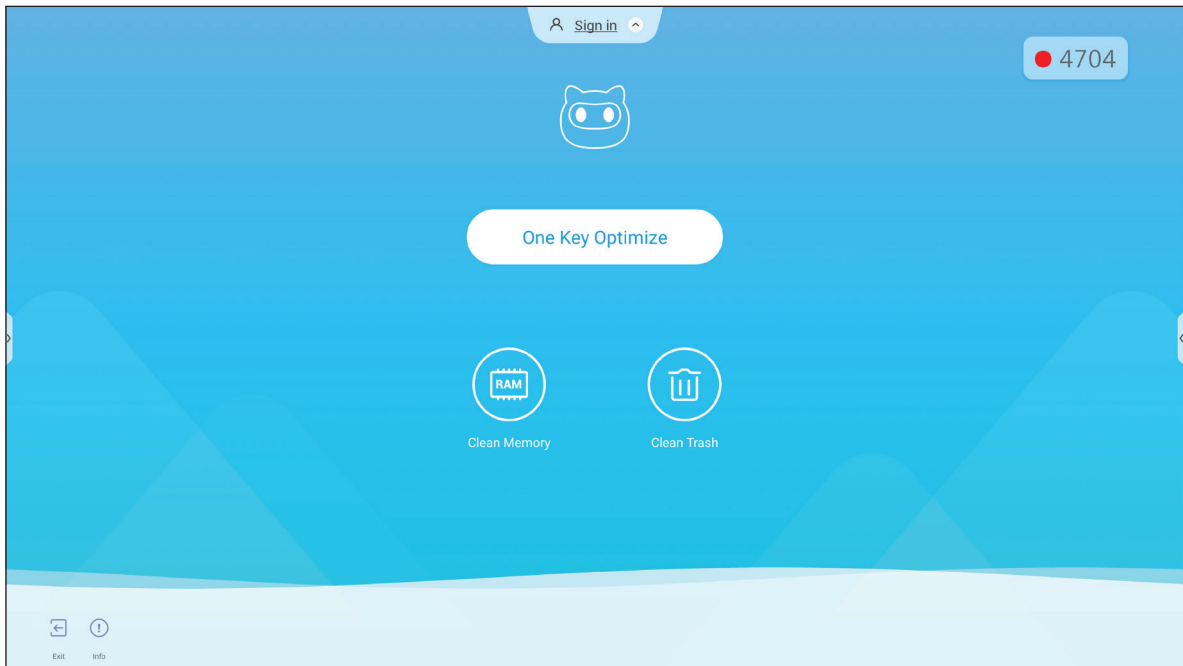

USING THE APPS

Joan on TV

Tap **Joan on TV** to get the access PIN number needed to connect the IFP to the Joan Portal.

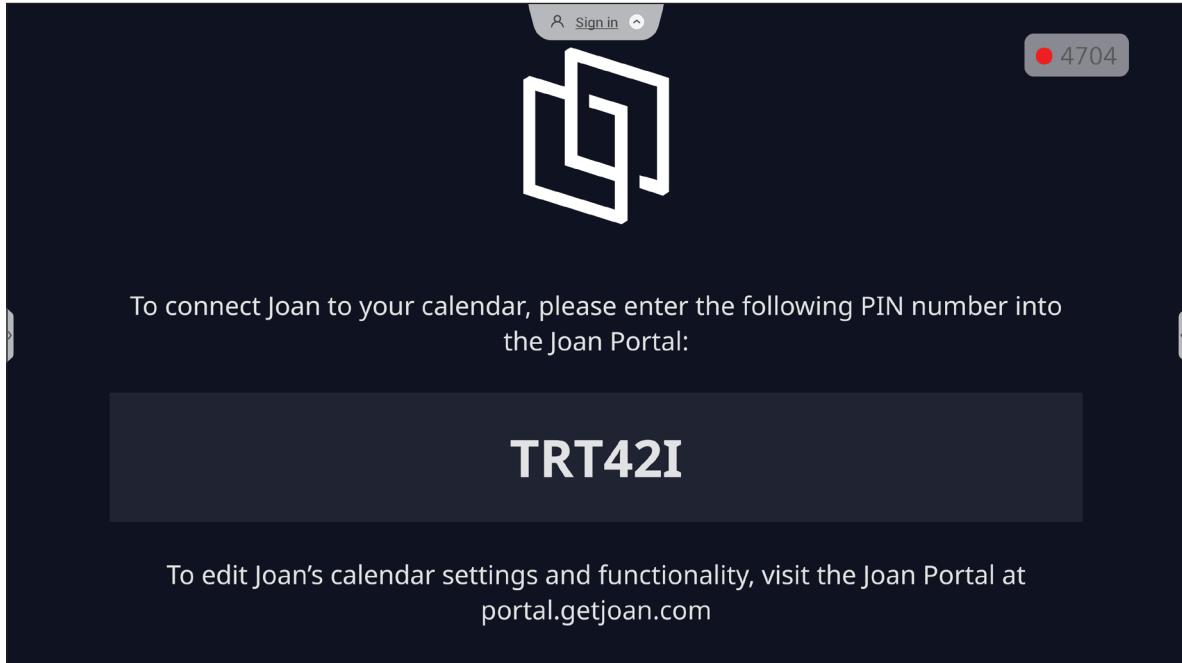

To connect the IFP to the Joan Portal, complete the following steps:

1. Open the web browser on your computer and enter <http://portal.getjoan.com> into the address bar. The Joan Portal login page will open. Sign in to the Joan Portal. If you have not yet created your Joan account, click **Sign Up** to create your account.

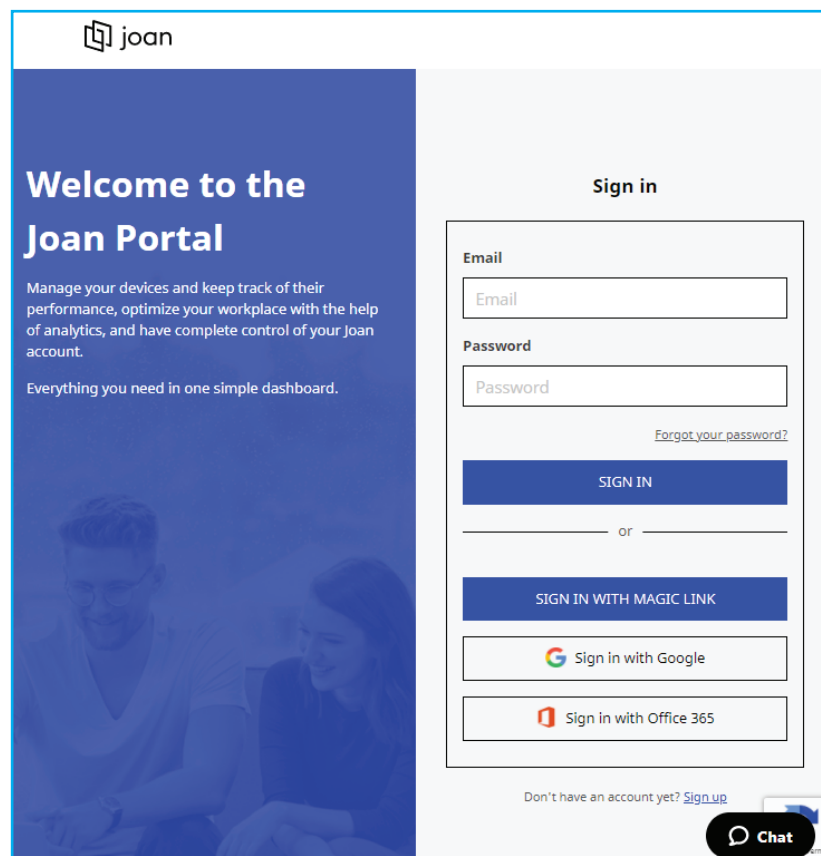

USING THE APPS

2. Click **Pair device now** to pair with IFP.

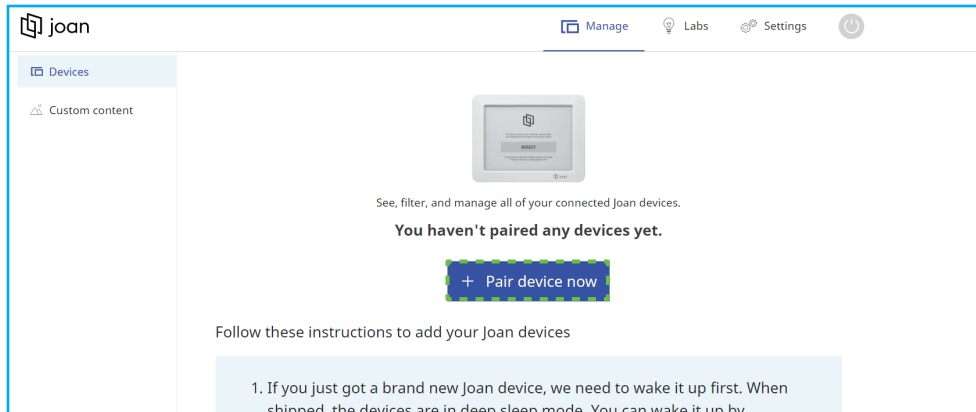

3. Or the “Let’s pair your device” page, select any of the pairing methods. For example, click **PAIR DEVICE** to pair with the IFP using the PIN number.
4. Enter the PIN number that is displayed on the IFP at the prompt and click **PAIR DEVICE**.

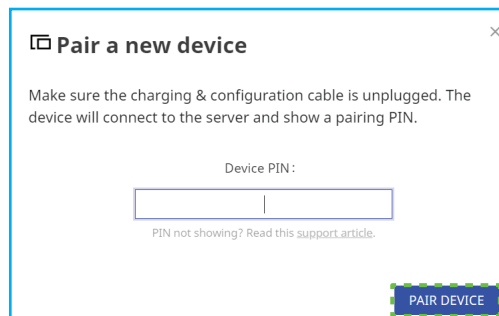

5. Enter the device name and select the calendar. Click **SAVE** to save the information.

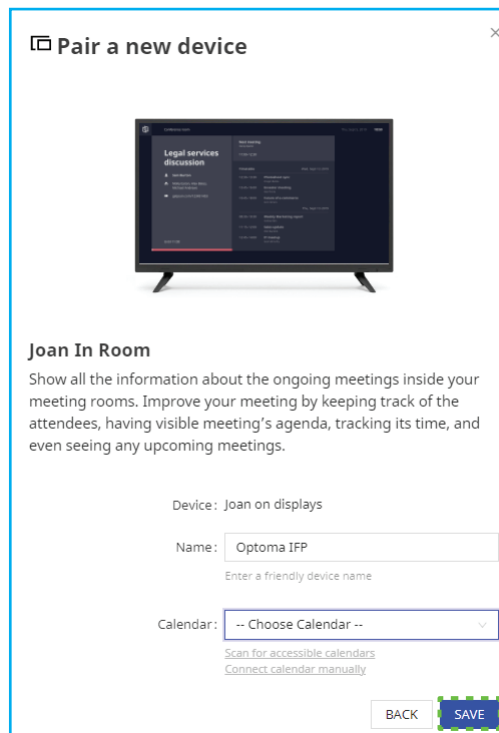

All the meetings in the selected calendar will appear on the screen of the IFP.

USING THE APPS

After successful connection, the IFP will display meeting room(s) schedule, meeting reminders, and meeting room reminders that are set in Joan Portal.

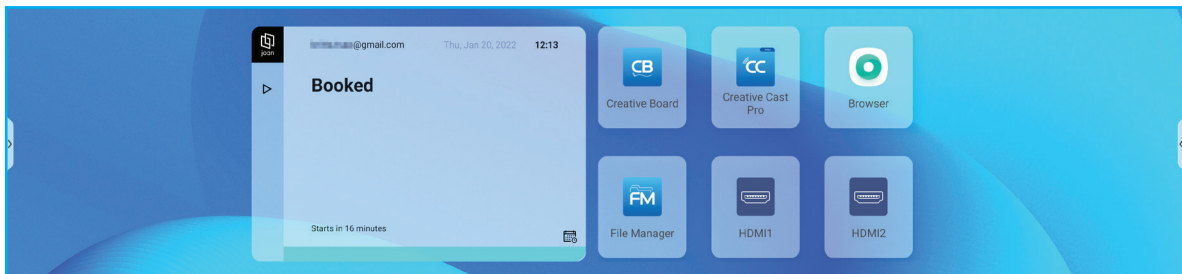
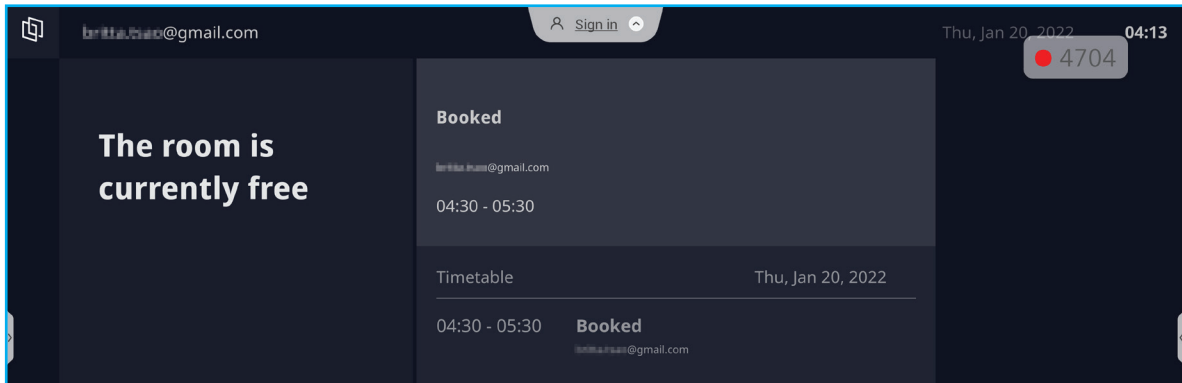

USING THE APPS





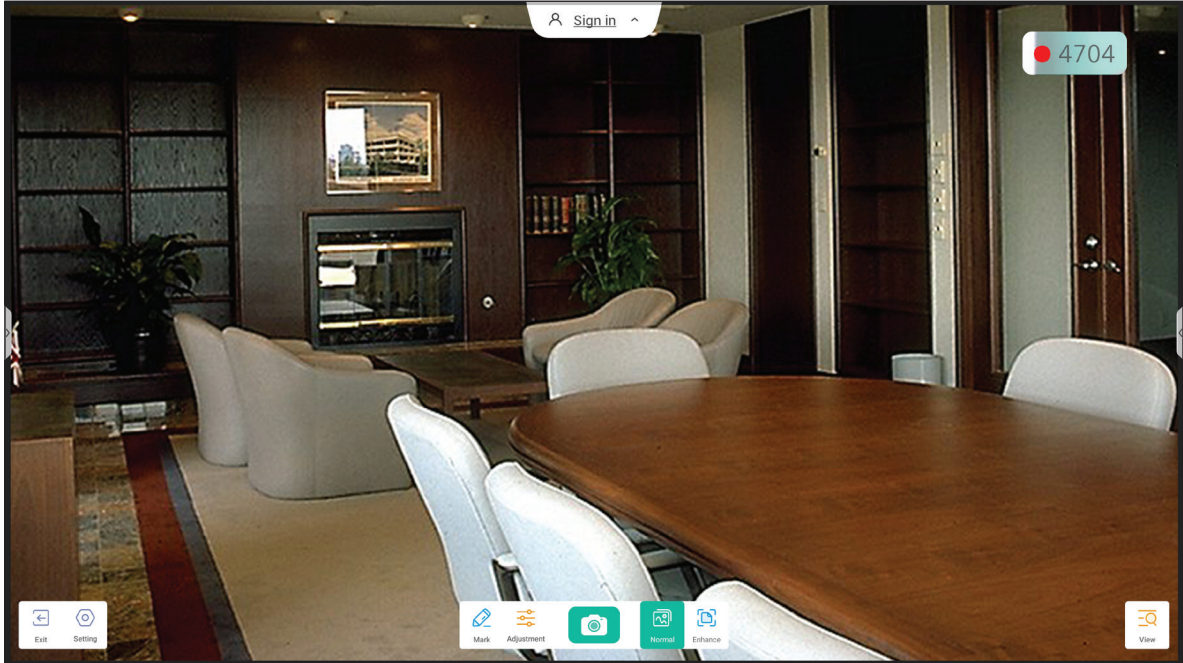



Visualizer

Visualizer is an operation app for a document camera. If you connect a document camera device, tap **Visualizer** to set it up.



To use **Visualizer**, complete the following steps:

1. Connect a USB document camera to an available USB port on the IFP.
2. Launch **Visualizer** app. The table below explains the various functions available in the **Visualizer** app.

Item	Description	
 Mark	Write and draw on the screen. For more information, refer to “Annotation App” on page 62.	
 Capture screen	Capture the screen image. Note: By default, images are saved to <i>VideoPresenter/photograph/{current date}</i> folder.	
 Normal mode	Pinch the screen to zoom in/zoom out, rotate the video image and move it around on the screen.	
 Enhance mode	Display the video image in full screen.	
 Adjustment	Adjust the video image settings: <ul style="list-style-type: none"> • Exhibition settings: size, scaling, rotation, and type • Advanced options: brightness, contrast, saturation, and sharpness. Note: Settings can be configured only in Normal mode.	
 View	Simultaneously display and customize multiple video streams or video captures. Note: View feature is available only in Normal mode.	
 Setting	View connected camera(s) and select preferred resolution.	
 Exit	Exit Visualizer .	

USING THE APPS

Other Software

Reactiv Suite **Reactiv SUITE** Making Your Meetings Memorable

Reactiv SUITE is a digital workspace where multimedia content can be displayed, organised, manipulated, and annotated as naturally as paper. Present multiple types of non-linear content and seamlessly capture feedback without the extra clicks and micro-frustrations of traditional screen sharing tools. Even pin your camera and elevate your presence to stand out.

A one-year license for **Reactiv SUITE** is included with your purchase of the IFP. To learn how to claim your one-year license, tap the **Download FREE 1 YR Reactiv License** link on the IFP Home screen.

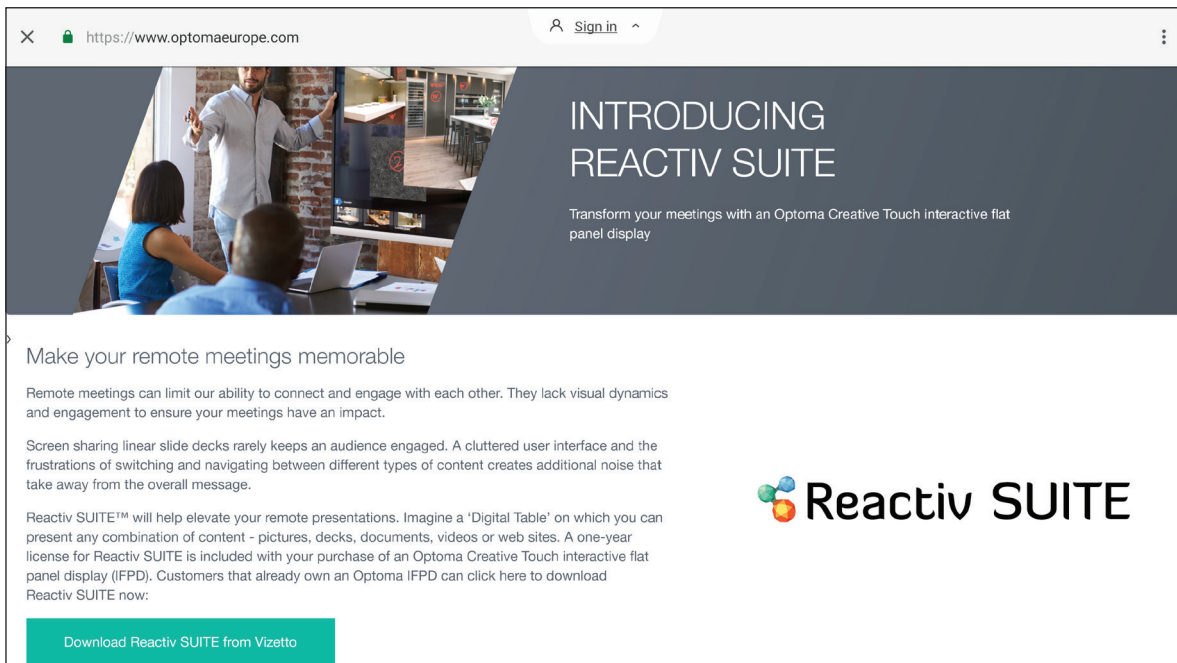
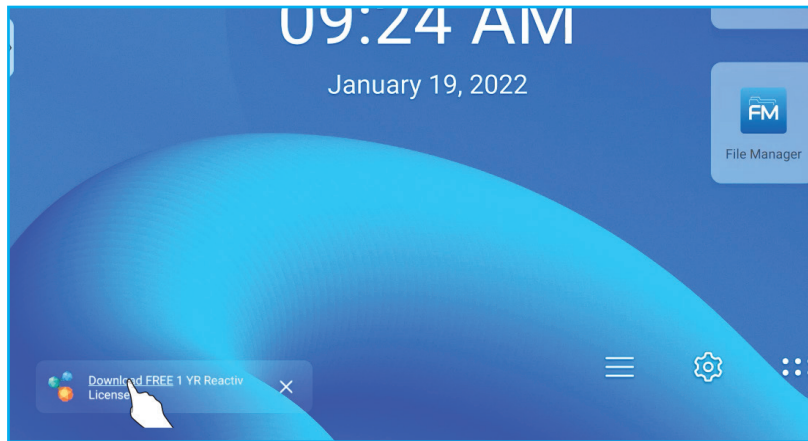

USING THE APPS

Optoma Management Suite (OMS)™

OMS is a large display management software that operates through LAN or over Internet. It simplifies the management of the IFP remotely.

OMS has the following features:

- Accessible from anywhere with Internet access at anytime (cloud solution coming soon!).
- Device monitoring, alerts, control, scheduling, broadcasting, and more.
- Over-the-air firmware updates (cloud solution coming soon!).

To start using OMS over LAN, complete the following steps:

1. Connect the IFP and your PC to the same LAN.
Open the browser and download the **OMS** app to your PC from the Optoma web page:
<https://www.optomausa.com/product-details/optoma-management-suite#downloads>

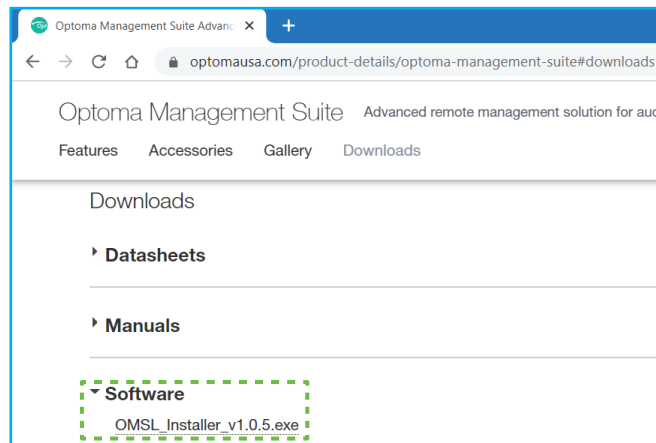

2. Install **OMS** to your PC.
3. Double-click on .
The **OMS** control page will open.

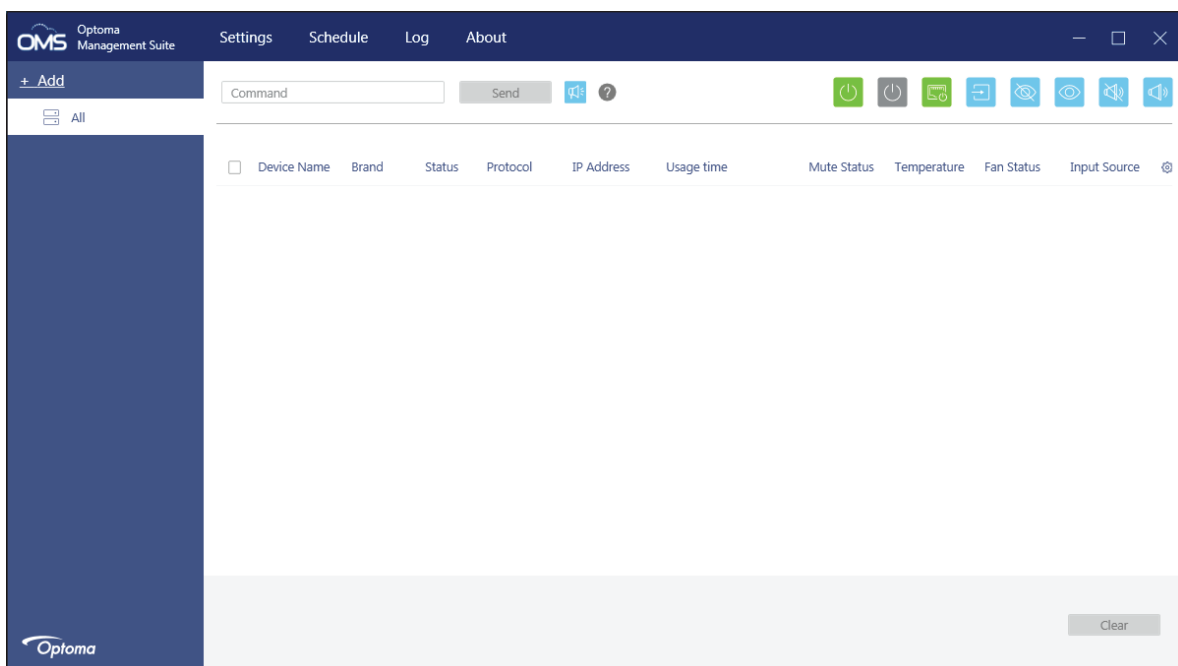

USING THE APPS

4. Click on **Add** ⇒ **Device**.
5. Select **Automatic Search** and click **Search** to search for devices automatically.
Note: If the device cannot be found automatically, then click **Manual Search** to search the device by the IP address or click **Range Search** to search the devices within the range of IP addresses.
6. Select the device and click **Add**.

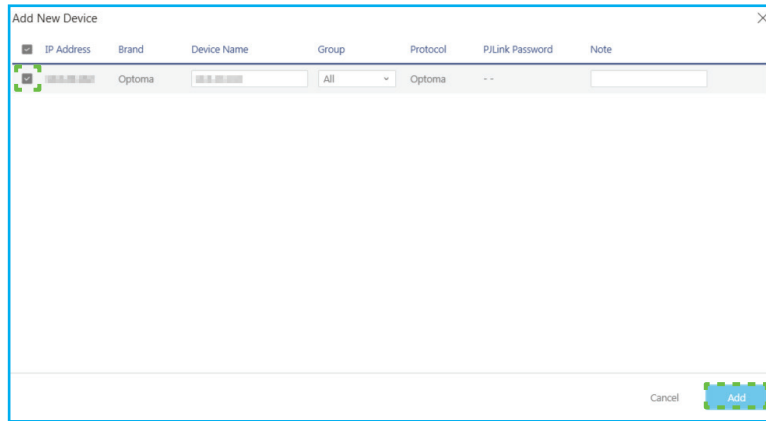

7. Select the device and then use the screen controls to display a message on the screen of the selected IFP, power on/off the IFP, enable/disable wake on LAN, select an input source, enable/disable AV mute mode, mute or unmute the IFP, monitor the device's status, usage time, mute status, temperature, and more.

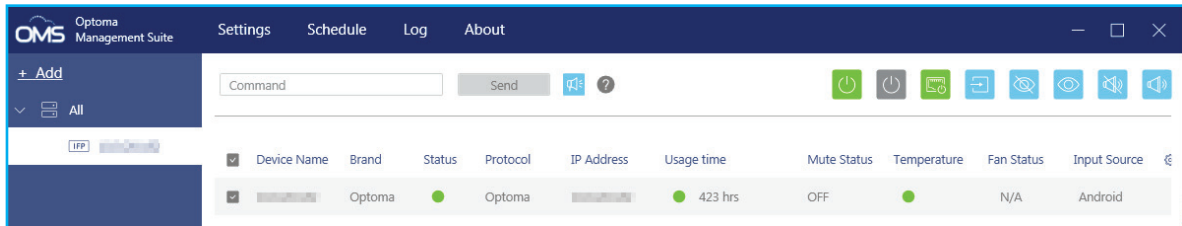

Note: For enhanced device management, you can group similar devices. To create a device group, click **Add** ⇒ **Group**. Then add the selected devices to the group.

ADDITIONAL INFORMATION

Dimensions

65-inch

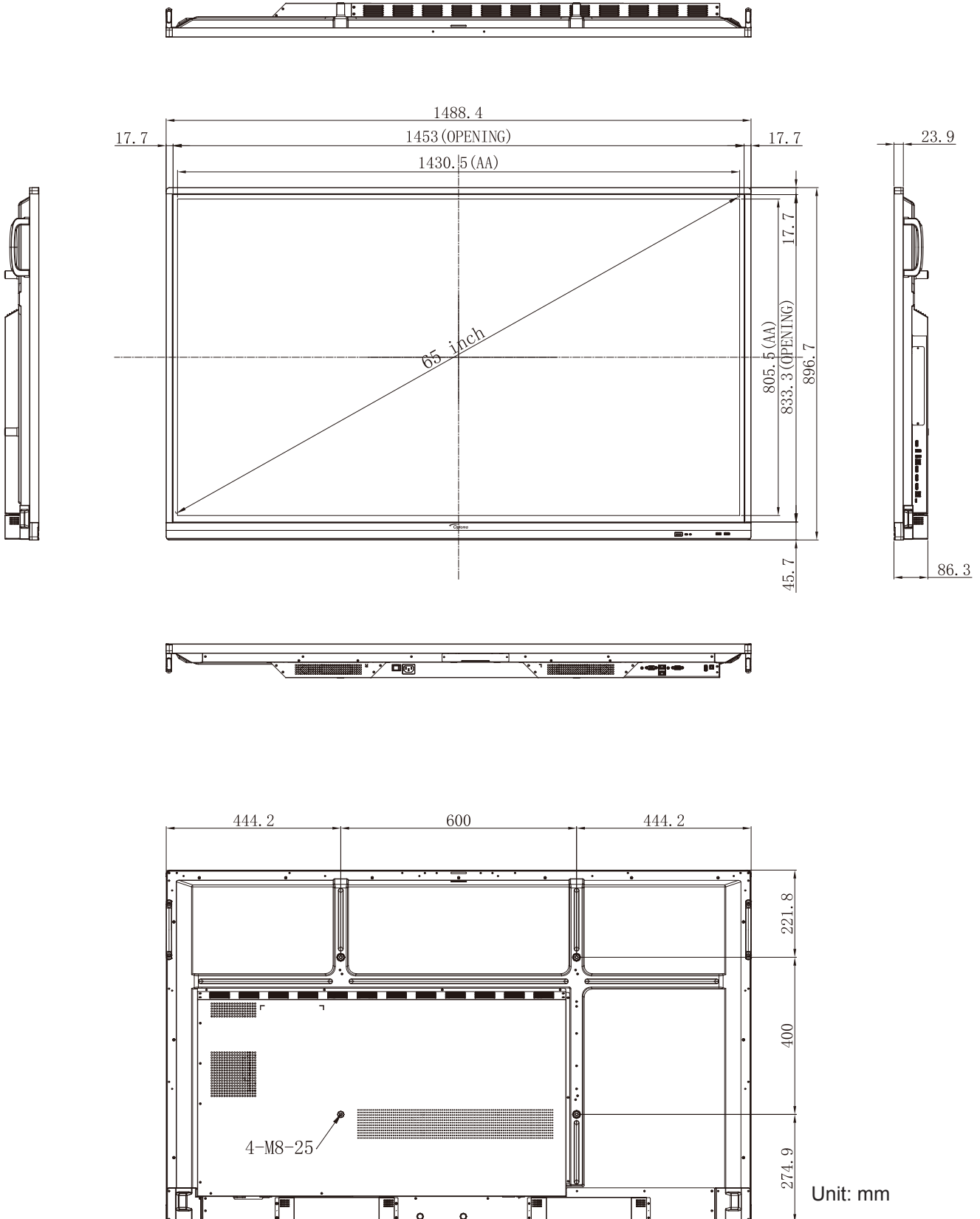

ADDITIONAL INFORMATION

75-inch

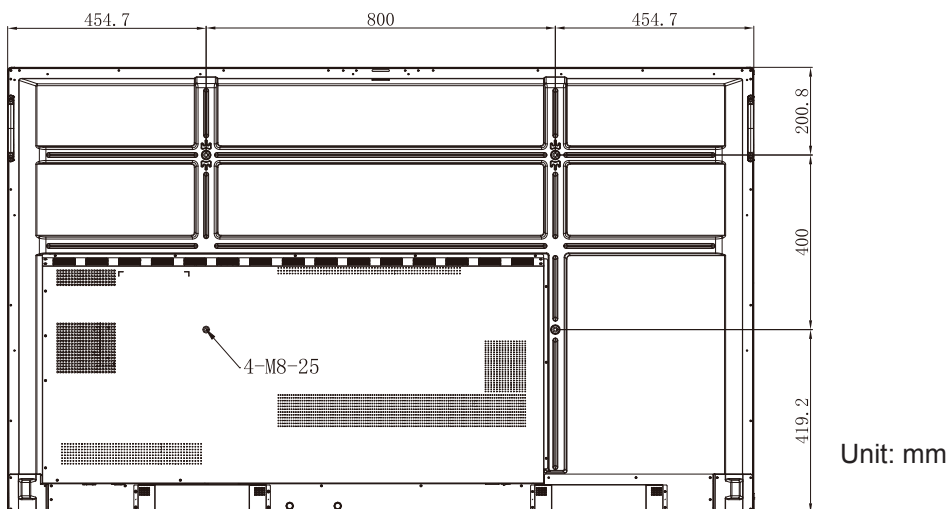
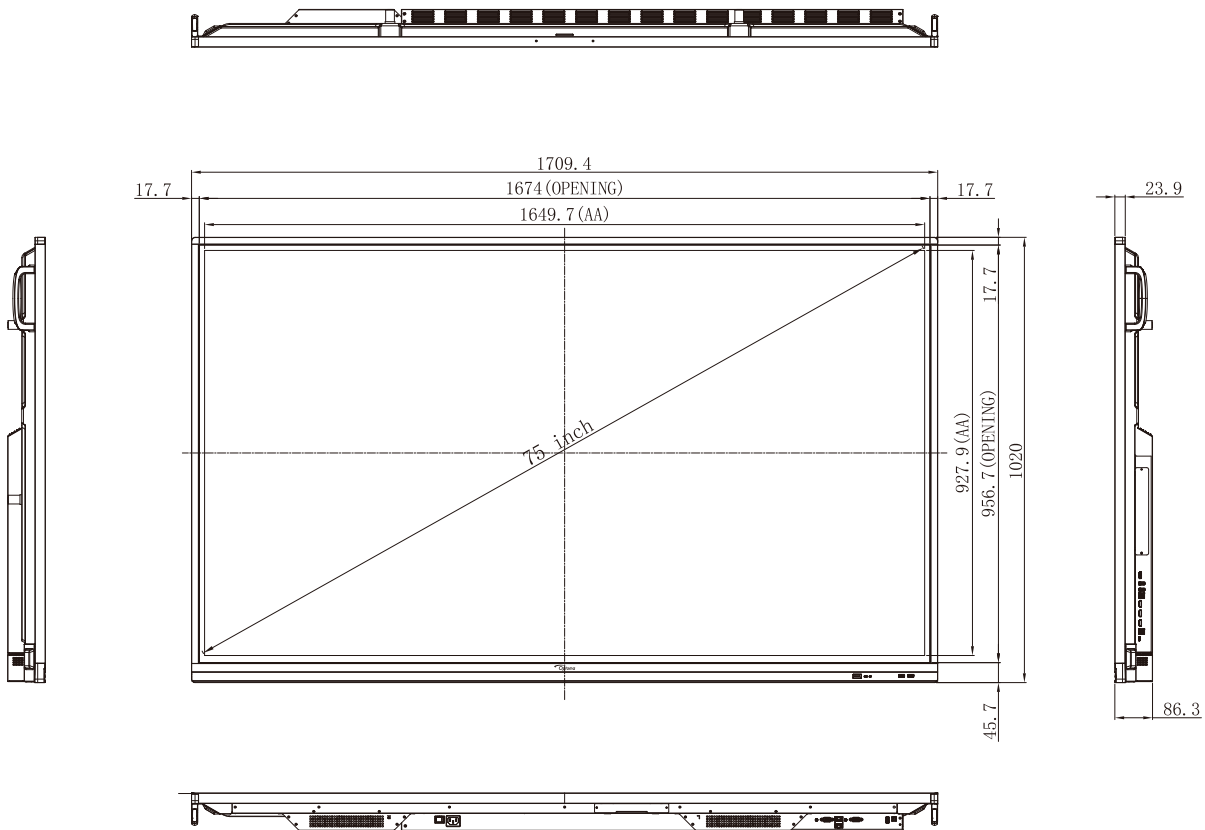

ADDITIONAL INFORMATION

86-inch

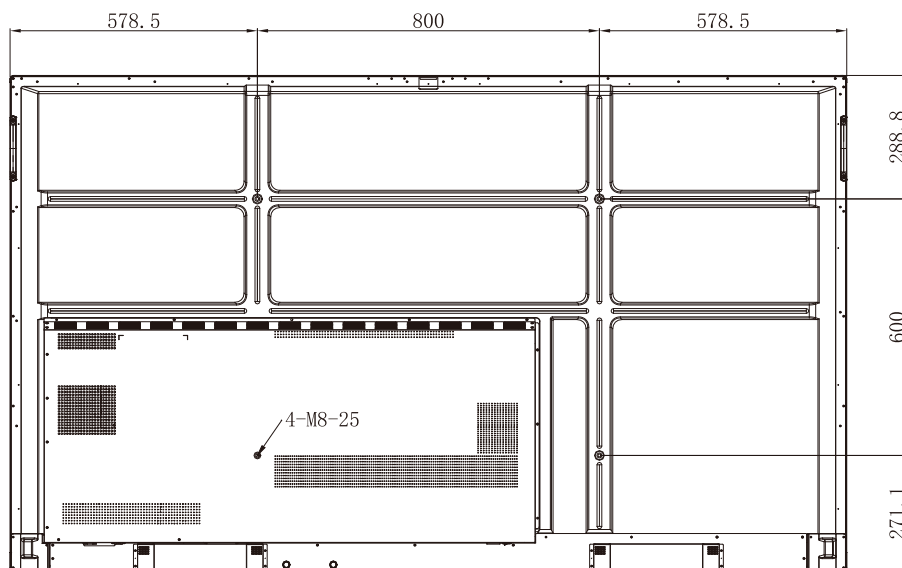
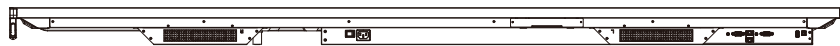
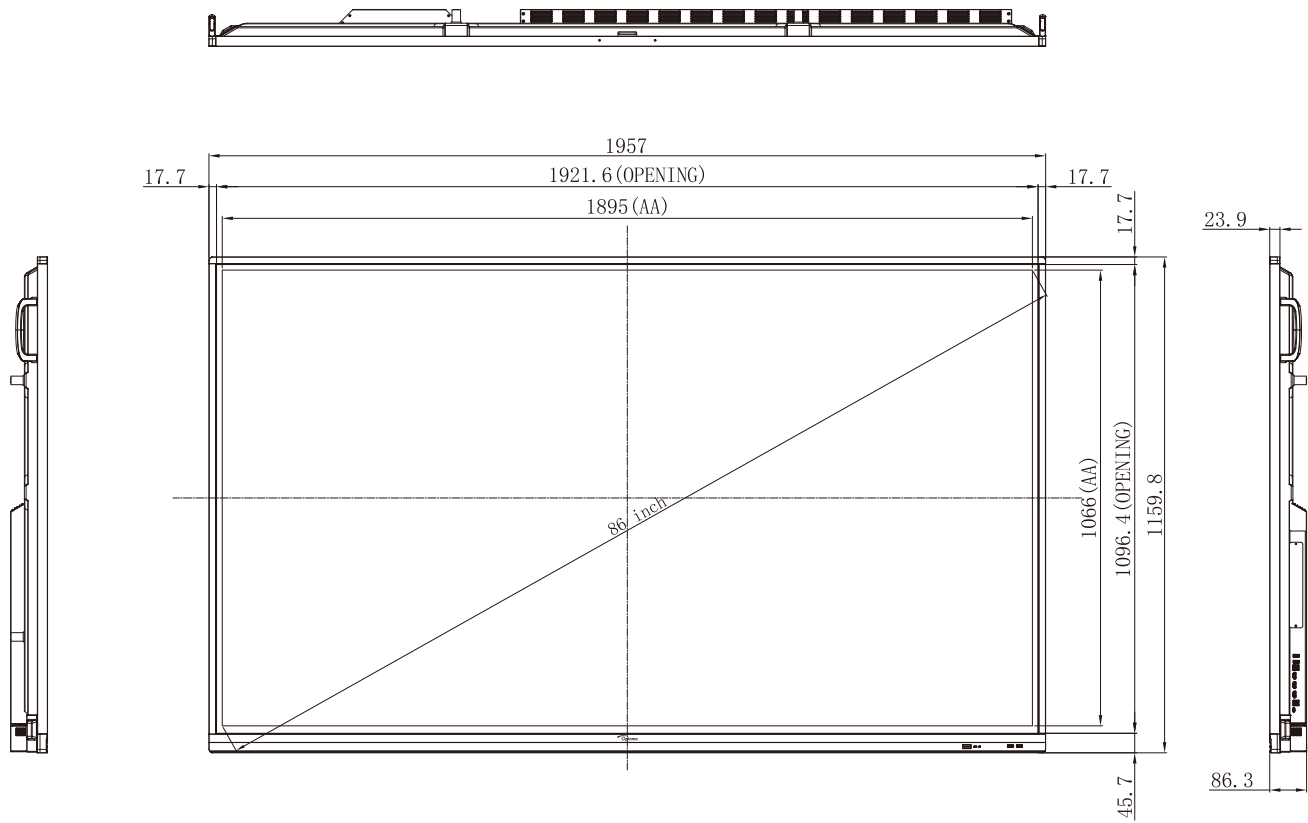

4-M8-25

Unit: mm

ADDITIONAL INFORMATION

Supported Timing List

No.	Signal Timing Name	Reference	Clock	Hf	Vf	Input Source		
			[MHz]	[KHz]	[Hz]	VGA	HDMI1/2/3 (2.0)	Type C
1	720x400 @70Hz	IBM	28.32	31.78	70.00	Y	/	Y
2	640x480 @60Hz	VESA	25.18	37.92	59.94	Y	Y	Y
3	640x480 @72Hz	VESA	31.50	37.86	72.81	Y	/	Y
4	640x480 @75Hz	VESA	31.50	37.50	75.00	Y	/	Y
5	800x600 @56Hz	VESA	36.00	35.15	56.25	Y	/	Y
6	800x600 @60Hz	VESA	40.00	37.87	60.31	Y	Y	Y
7	800x600 @72Hz	VESA	50.00	48.07	72.18	Y	/	Y
8	800x600 @75Hz	VESA	49.50	46.87	75.00	Y	/	Y
9	832x624 @75Hz	MAC	57.28	49.72	74.55	Y	/	Y
10	1024x768 @60Hz	VESA	65.00	48.36	60.00	Y	Y	Y
11	1024x768 @70Hz	VESA	75.00	56.47	70.06	Y	/	Y
12	1024x768 @75Hz	VESA	78.75	60.02	75.02	Y	/	Y
13	1152x864 @75Hz	VESA	108.00	67.50	75.00	Y	/	Y
14	1280x768 @60Hz(RB)	CVTRB	68.25	47.39	59.99	Y	Y	Y
15	1280x768 @60Hz	CVT	79.50	47.77	59.87	Y	Y	Y
16	1280x720 @60Hz	CEA-861	74.25	44.67	60.00	Y	/	Y
17	1280x800 @60Hz	CVT	83.50	49.70	59.81	Y	Y	Y
18	1280x960 @60.000Hz	VESA	108.00	60.00	60.00	Y	Y	Y
19	1280x1024 @60Hz	VESA	108.00	63.98	60.00	Y	Y	Y
20	1360x768 @60Hz	VESA	85.50	47.71	60.01	Y	Y	Y
21	1440x900 @60Hz(RB)	CVTRB	88.75	55.46	59.90	Y	Y	Y
22	1440x900 @60Hz	CVT	106.50	55.93	59.88	Y	Y	Y
23	1600x1200 @60Hz	VESA	162.00	75.00	60.00	Y	/	Y
24	1680x1050 60Hz	CVT	146.25	65.29	59.95	Y	Y	Y
25	1920x1080 60Hz	CEA-861	148.50	67.50	60.00	Y	Y	Y
26	720(1440)x480i	CEA-861	27.00	15.73	59.94	/	Y	/
27	480p 59Hz	CEA-861	27.00	31.46	59.94	/	Y	/
28	480p 60Hz	CEA-861	27.02	31.50	60.00	/	Y	/
29	720(1440)x576i	CEA-861	27.00	15.62	50.00	/	Y	/
30	576p	CEA-861	27.00	31.25	50.00	/	Y	/
31	720p 60Hz	CEA-861	74.25	45.00	60.00	/	Y	/
32	720p 59Hz	CEA-861	74.17	44.95	59.94	/	Y	/
33	720p 50Hz	CEA-861	74.25	37.50	50.00	/	Y	/
34	1080i 60Hz	CEA-861	74.25	33.75	60.00	/	Y	/

ADDITIONAL INFORMATION

No.	Signal Timing Name	Reference	Clock	Hf	Vf	Input Source		
			[MHz]	[KHz]	[Hz]	VGA	HDMI1/2/3 (2.0)	Type C
35	1080i 59Hz	CEA-861	74.17	33.71	59.94	/	Y	/
36	1080i 50Hz	CEA-861	74.25	28.12	50.00	/	Y	/
37	1080p 60Hz	CEA-861	148.25	67.50	60.00	/	Y	/
38	1080p 59Hz	CEA-861	148.35	67.44	59.94	/	Y	/
39	1080p 50Hz	CEA-861	148.50	56.25	50.00	/	Y	/
40	1080p 30Hz	CEA-861	74.25	33.75	30.00	/	Y	/
41	1080p 29Hz	CEA-861	74.17	33.71	29.97	/	Y	/
42	1080p 25Hz	CEA-861	74.25	28.12	25.00	/	Y	/
43	1080p 24Hz	CEA-861	74.25	27.00	24.00	/	Y	/
44	1080p 23Hz	CEA-861	74.17	26.97	23.97	/	Y	/
45	3840x2160 60Hz	CEA-861	594.00	135.00	60.00	/	Y	Y
46	3840x2160 50Hz	CEA-861	594.00	112.50	50.00	/	Y	Y
47	3840x2160 30Hz	CEA-861	297.00	67.50	29.97	/	Y	Y
48	3840x2160 25Hz	CEA-861	297.00	56.25	25.00	/	Y	Y
49	3840x2160 24Hz	CEA-861	297.00	54.00	23.98	/	Y	Y
50	4096x2160 24Hz	CEA-861	297.00	54.00	24.00	/	Y	Y

ADDITIONAL INFORMATION

RS232 Protocol Function List

Note: IFP supports RS232 and RJ45 (port 23) control command.

RS232 Pin Assignments

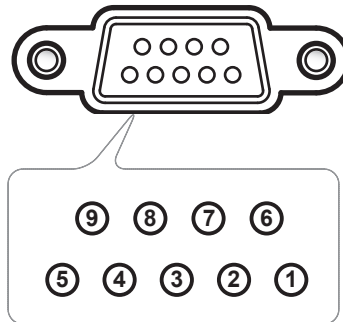

Pin No.	Spec. (from IFP side)
1	N/A
2	TXD
3	RXD
4	N/A
5	GND
6	N/A
7	N/A
8	N/A

RS232 RJ45 Control Connection

RS232 Settings	
Baud Rate	9600
Data Bits	8
Parity	None
Stop Bits	1
Flow Control	None

LAN Control Settings	
IP	Machine IP
Port	23

~	X	X	X	X	X	X	X	CR
Lead Code	Device ID (where 01 indicates Device ID = 01)		Command ID		Space	Variable	Carriage return	

ADDITIONAL INFORMATION

SET Command

Type	Category	Parameter	CMD		Hex Code CMD	Response	
						Success	Failed
SET	Power	Power off	~xx00 n	n=0	7E 30 30 30 30 20 30 0d	P	F
		Power on	~xx00 n	n=1	7E 30 30 30 30 20 31 0d	P	F
		Restart	~xx00 n	n=3	7E 30 30 30 30 20 33 0d	P	F
	Power Mode (standby)	Eco.	~xx114 n	n=0	7E 30 30 31 31 34 20 30 0d	P	F
		Active		n=1	7E 30 30 31 31 34 20 31 0d	P	F
	Treble	0 ~ 100	~xx95 n	n=0-100	7E 30 30 39 35 20 30 0d to 7E 30 30 39 35 20 31 30 30 0d	P	F
	Bass	0 ~ 100	~xx96 n	n=0-100	7E 30 30 39 36 20 30 0d to 7E 30 30 39 36 20 31 30 30 0d	P	F
	Balance	0 ~ 100	~xx99 n	n=0-100	7E 30 30 39 39 20 30 0d to 7E 30 30 39 39 20 31 30 30 0d	P	F
	Contrast	0 ~ 100	~xx22 n	n=0-100	7E 30 30 32 32 20 30 0d to 7E 30 30 32 32 20 31 30 30 0d	P	F
	Brightness	0 ~ 100	~xx21 n	n=0-100	7E 30 30 32 31 20 30 0d to 7E 30 30 32 31 20 31 30 30 0d	P	F
	Sound Mode	Standard	~xx252 n	n=1	7E 30 30 32 35 32 20 31 0d	P	F
		Meeting		n=4	7E 30 30 32 35 32 20 34 0d	P	F
		User		n=2	7E 30 30 32 35 32 20 32 0d	P	F
		Classroom		n=3	7E 30 30 32 35 32 20 33 0d	P	F
		Movie		n=5	7E 30 30 32 35 32 20 35 0d	P	F
	Volume	0 ~ 100	~xx81 n	n=0-100	7E 30 30 38 31 20 30 0d to 7E 30 30 38 31 20 31 30 30 0d	P	F
	Video Mute	Off	~xx13 n	n=0	7E 30 30 31 33 20 30 0d	P	F
		On		n=1	7E 30 30 31 33 20 31 0d	P	F
	Mute	Off	~xx80 n	n=0	7E 30 30 38 30 20 30 0d	P	F
		On		n=1	7E 30 30 38 30 20 31 0d	P	F
	Input Source	HDMI1	~xx12 n	n=1	7E 30 30 31 32 20 31 0d	P	F
		HDMI2		n=15	7E 30 30 31 32 20 31 35 0d	P	F
		HDMI3		n=16	7E 30 30 31 32 20 31 36 0d	P	F
		USB Type C		n=27	7E 30 30 31 32 20 32 37 0d	P	F
		VGA		n=5	7E 30 30 31 32 20 35 0d	P	F
		Solot in PC		n=25	7E 30 30 31 32 20 32 35 0d	P	F
		Android		n=24	7E 30 30 31 32 20 32 34 0d	P	F
	Aspect Ratio	4:3	~xx60 n	n=1	7E 30 30 36 30 20 31 0d	P	F
		16:9		n=2	7E 30 30 36 30 20 32 0d	P	F
		PTP		n=14	7E 30 30 36 30 20 31 34 0d	P	F
Language	English	~xx70 n	n=1	7E 30 30 37 30 20 31 0d	P	F	
	Français		n=3	7E 30 30 37 30 20 33 0d	P	F	

ADDITIONAL INFORMATION

Type	Category	Parameter	CMD		Hex Code CMD	Response	
						Success	Failed
SET	Language	Español	~xx70 n	n=5	7E 30 30 37 30 20 35 0d	P	F
		Traditional Chinese		n=13	7E 30 30 37 30 20 31 33 0d	P	F
		Simplified Chinese		n=14	7E 30 30 37 30 20 31 34 0d	P	F
		Português		n=6	7E 30 30 37 30 20 36 0d	P	F
		German		n=2	7E 30 30 37 30 20 32 0d	P	F
		Dutch		n=8	7E 30 30 37 30 20 38 0d	P	F
		Polish		n=7	7E 30 30 37 30 20 37 0d	P	F
		Russia		n=17	7E 30 30 37 30 20 31 37 0d	P	F
		Czech		n=19	7E 30 30 37 30 20 31 39 0d	P	F
		Danish		n=24	7E 30 30 37 30 20 32 34 0d	P	F
		Swedish		n=9	7E 30 30 37 30 20 39 0d	P	F
		Italian		n=4	7E 30 30 37 30 20 34 0d	P	F
		Turkish		n=22	7E 30 30 37 30 20 32 32 0d	P	F
		Arabic		n=20	7E 30 30 37 30 20 32 30 0d	P	F
		Romanian		n=27	7E 30 30 37 30 20 32 37 0d	P	F
		Hungarian		n=18	7E 30 30 37 30 20 31 38 0d	P	F
		Finnish		n=11	7E 30 30 37 30 20 31 31 0d	P	F
	Norge	n=10	7E 30 30 37 30 20 31 30 0d	P	F		
	Picture Mode	Presentation	~xx20 n	n=1	7E 30 30 32 30 20 31 0d	P	F
		Bright		n=2	7E 30 30 32 30 20 32 0d	P	F
		Cinema		n=3	7E 30 30 32 30 20 33 0d	P	F
		User		n=5	7E 30 30 32 30 20 35 0d	P	F
		HDR		n=21	7E 30 30 32 30 20 32 31 0d	P	F
	Color	0 ~ 100	~xx45 n	n=0-100	7E 30 30 34 35 20 30 0d to 7E 30 30 34 35 20 31 30 30 0d	P	F
	Backlight	0 ~ 100	~xx251 n	n=0-100	7E 30 30 32 35 31 20 30 0d to 7E 30 30 32 35 31 20 31 30 30 0d	P	F
	Color Temp	Cool	~xx36 n	n=2	7E 30 30 33 36 20 32 0d	P	F
		Standard		n=1	7E 30 30 33 36 20 31 0d	P	F
		Warm		n=4	7E 30 30 33 36 20 34 0d	P	F
	Freeze	Unfreeze	~xx04 n	n=0	7E 30 30 30 34 20 30 0d	P	F
		Freeze		n=1	7E 30 30 30 34 20 31 0d	P	F
	Pixel shift interval (min)	Off	~xx250 n	n=0	7E 30 30 32 35 30 20 30 0d	P	F
		2		n=2	7E 30 30 32 35 30 20 32 0d	P	F
		3		n=3	7E 30 30 32 35 30 20 33 0d	P	F
5		n=5		7E 30 30 32 35 30 20 35 0d	P	F	
30		n=30		7E 30 30 32 35 30 20 33 30 0d	P	F	
60		n=60		7E 30 30 32 35 30 20 36 30 0d	P	F	
Remote control command	Vol +	~xx140 n	n=17	7E 30 30 31 34 30 20 31 37 0d	P	F	

ADDITIONAL INFORMATION

Type	Category	Parameter	CMD		Hex Code CMD	Response	
						Success	Failed
SET	Remote control command	Vol -	~xx140 n	n=18	7E 30 30 31 34 30 20 31 38 0d	P	F
		Remote UP		n=10	7E 30 30 31 34 30 20 31 30 0d	P	F
		Remote DOWN		n=14	7E 30 30 31 34 30 20 31 34 0d	P	F
		Remote LEFT		n=11	7E 30 30 31 34 30 20 31 31 0d	P	F
		Remote RIGHT		n=13	7E 30 30 31 34 30 20 31 33 0d	P	F
		Remote OK		n=12	7E 30 30 31 34 30 20 31 32 0d	P	F
		Remote Menu Key		n=20	7E 30 30 31 34 30 20 32 30 0d	P	F
		Remote Input source		n=47	7E 30 30 31 34 30 20 34 37 0d	P	F
		Remote Exit		n=74	7E 30 30 31 34 30 20 37 34 0d	P	F
	Display message on the OSD		~xx210	nn.....n	7E 30 30 32 31 30 20 nn...n od	P	F
Reset To Default		~xx112	n=1	7E 30 30 31 31 32 20 31 od	P	F	
OSD lock	OSD lock On with password	~xx239	n=1 ~nnnn	7E 30 30 32 33 39 20 31 20 a 0d	P	F	
	OSD lock Off with password	~xx239	n=2 ~nnnn	7E 30 30 32 33 39 20 32 20 a 0d	P	F	

GET Command

Type	Category	CMD		Hex Code CMD	Response		
					Success	Parameter	Failed
GET	Power	~xx124 n	n=1	7E 30 30 31 32 34 20 31 0D	Ok0	Power off	F
					OK1	Power on	F
	Contrast	~xx126 n	n=1	7E 30 30 31 32 36 20 31 0D	OK0-100	0-100	F
	Brightness	~xx125 n	n=1	7E 30 30 31 32 35 20 31 0D	OK0-100	0-100	F
	Volume	~xx120 n	n=1	7E 30 30 31 32 30 20 31 0D	OK0-100	0-100	F
	Video Mute	~xx363 n	n=1	7E 30 30 33 36 33 20 31 0D	OK0	Off	F
					OK1	On	F
	Mute	~xx356 n	n=1	7E 30 30 33 35 36 20 31 0D	OK0	Off	F
					OK1	On	F
	Sound Mode	~xx139	n=1	7E 30 30 31 33 39 20 31 0D	OK1	Standard	F
					OK2	User	F
					OK3	Classroom	F
					OK4	Meeting	F
					OK5	Movie	F
	Input Source	~xx121 n	n=1	7E 30 30 31 32 31 20 31 0D	OK7	HDMI1	F
OK8					HDMI2	F	
OK9					HDMI3	F	
OK23					USB Type C	F	
OK2					VGA	F	
OK20					Android	F	
				OK21	Slot in PC	F	

ADDITIONAL INFORMATION

Type	Category	CMD		Hex Code CMD	Response		
					Success	Parameter	Failed
GET	Aspect Ratio	~xx127 n	n=1	7E 30 30 31 32 37 20 31 0D	OK1	4:3	F
					OK2	16:9	F
					OK14	PTP	F
	Picture Mode	~xx123 n	n=1	7E 30 30 31 32 33 20 31 0D	OK1	Presentation	F
					OK2	Bright	F
					OK3	Cinema	F
					OK5	User	F
					OK10	DICOM SIM.	F
					OK21	HDR	F
	Color Temp	~xx128 n	n=1	7E 30 30 31 32 38 20 31 0D	OK1	Cool	F
					OK0	Standard	F
					OK3	Warm	F
	WLAN status	~xx451 n	n=1	7E 30 30 34 35 31 20 31 0D	OK0	Disconnected	F
					OK1	Connected	F
	WLAN Mac address	~xx555 n	n=2	7E 30 30 35 35 35 20 32 0D	Oknn:nn:nn:nn:nn	Mac Address	F
	WLAN IP address	~xx451 n	n=2	7E 30 30 34 35 31 20 32 0D	Oknnn:nnn:nnn:nnn	IP address	F
	LAN status	~xx87 n	n=1	7E 30 30 38 37 20 31 0D	OK0	Disconnected	F
					OK1	Connected	F
	LAN Mac address	~xx555 n	n=1	7E 30 30 35 35 35 20 31 0D	Oknn:nn:nn:nn:nn	Mac Address	F
	LAN IP address	~xx87 n	n=3	7E 30 30 38 37 20 33 0D	Oknnn:nnn:nnn:nnn	IP address	F
	FW version	~xx122 n	n=1	7E 30 30 31 32 32 20 31 0D	Oknnnnnnnnnnnnnnnn (ex. 20190926164814)	FW version	F
	Usage hour	~xx108 n	n=1	7E 30 30 31 30 38 20 31 0D	Oknnnnn	Suage hours	F
	Device type	~xx149 n	n=1	7E 30 30 31 34 39 20 31 0D	OK2	Device type = IFP	F
	Information string	~xx150 n	n=1	7E 30 30 31 35 30 20 31 0D	OKabbbbccdddee (Note*1)		F
			n=2	7E 30 30 31 35 30 20 32 0D	Oknnn	Device native resolution	F
			n=3	7E 30 30 31 35 30 20 33 0D	Oknnn (ex. OKHDMI1)	Input source	F
			n=4	7E 30 30 31 35 30 20 34 0D	Oknnn (ex. OK1920x1080)	Source resolutuion	F
			n=16	7E 30 30 31 35 30 20 31 36 0D	OK0	Power mode (standby) = Eco.	F
					OK1	Power mode (standby) = Active	F
n=17			7E 30 30 31 35 30 20 31 37 0D	OK0	DHCP = Off	F	
				OK1	DHCP = On	F	
n=18			7E 30 30 31 35 30 20 31 38 0D	Oknnn (ex. OK48)	System temperature	F	
n=19	7E 30 30 31 35 30 20 31 39 0D	Oknnn (ex. OK60Hz)	Source refresh rate	F			

ADDITIONAL INFORMATION

Type	Category	CMD		Hex Code CMD	Response		
					Success	Parameter	Failed
GET	Regulatory Model name	~xx151 n	n=3	7E 30 30 31 35 31 20 33 0d	Oknnn (ex. SLUGRK)	Regulatory model name (will provide when kick off)	F
System Auto send	Standby Mode				INFO0		
	Warming up				INFO1		
	Cooling down				INFO2		
	Over temperature				INFO7		
GET	OSD lock	~xx229 n	n=1	7E 30 30 32 32 39 20 31 0D	OK0	OSD lock = Off	F
					OK1	OSD lock = On	F

Note: (*1)

Power	Running Time	Input Source	Firmware Version	Display Mode
<ul style="list-style-type: none"> a=0 Power Off a=1 Power On 	Usage hours = nnnnn	<ul style="list-style-type: none"> cc=02 VGA1 cc=08 HDMI2 cc=10 Component cc=14 HDMI3 cc=15 DisplayPort cc=18 Android cc=19 Slot in PC cc=21 USB Type C 	###	<ul style="list-style-type: none"> ee=01 Presentation ee=02 Bright ee=05 User ee=21 HDR ee=03 Cinema ee=10 DICOM SIM.





LED Indicator

Power LED Color & Behavior	Status
Solid Red	Standby mode
Solid White	Power on
Flash Red then Blue continuously	Backlight off

ADDITIONAL INFORMATION

Troubleshooting

If you experience a problem with your device, please refer to the following information. If a problem persists, please contact your local reseller or service center.

-  *No picture or sound.*
- Make sure all signal and power connections are properly connected.
 - Make sure the correct input mode is selected. Refer to the “Shortcut Menu” section.
 - Make sure the IFP is not turned off.
 - Turn off the mute function.
 - Make sure the volume is not set to the minimum level.
-  *The IFP automatically shuts down.*
- Check whether there is a sudden power outage.
 - Make sure the power cord is not disconnected.
-  *The signal is out of range*
- The signal may be incompatible. Refer to the “Supported Timing List” section.
 - For the VGA input source, try the automatic screen adjustment or adjust the **Frequency** and **Phase** settings in OSD ⇒ Signal menu.
-  *The touch panel does not respond*
- Make sure the screen is not exposed to direct sunlight or other strong light.
 - For the external device connection, make sure the USB cable is properly connected to the Touch USB port of the IFP.
-  *If the remote control does not work*
- Check that the operating angle of the remote control is pointed within $\pm 30^\circ$ to the IR receiver on the IFP.
 - Make sure there are no obstructions between the remote control and the IFP. The distance between the remote control and the IR sensor window should not be longer than 8 meters.
 - Make sure batteries are inserted correctly and replace the batteries if they are depleted. Refer to the “Installing/Replacing the Remote Control Batteries” section.

ADDITIONAL INFORMATION

Maintenance

Proper routine maintenance can help with early fault detection and keep the IFP looking like new.

IMPORTANT! *Before cleaning and performing any maintenance task, make sure to unplug the power cord from the power outlet to prevent electric shock.*

Cleaning the Screen

- When the screen requires cleaning, please unplug the power cord first.
- Please use a soft, dust-free, dry cloth to wipe the screen.
- Do not use water or a spray cleaner to clean the IFP.
- Please contact the service center for internal cleaning of the IFP.

Clean the Front Frame

Use a dry, soft, lint-free cloth to wipe the front frame.



ADDITIONAL INFORMATION

Optoma Global Offices

For service or support, please contact your local office.



USA

47697 Westinghouse Drive,
Fremont, CA 94539, USA
www.optomausa.com

 888-289-6786
 510-897-8601
 services@optoma.com



Canada

47697 Westinghouse Drive,
Fremont, CA 94539, USA
www.optomausa.com

 888-289-6786
 510-897-8601
 services@optoma.com

Latin America

47697 Westinghouse Drive,
Fremont, CA 94539, USA
www.optomausa.com

 888-289-6786
 510-897-8601
 services@optoma.com



Europe

Unit 1, Network 41, Bourne End Mills,
Hemel Hempstead, Herts,
HP1 2UJ, United Kingdom
www.optoma.eu
Service Tel : +44 (0)1923 691865

 +44 (0) 1923 691 800
 +44 (0) 1923 691 888
 service@tsc-europe.com



Benelux BV

Randstad 22-123
1316 BW Almere
The Netherlands
www.optoma.nl

 +31 (0) 36 820 0252
 +31 (0) 36 548 9052



France

Bâtiment E
81-83 avenue Edouard Vaillant
92100 Boulogne Billancourt, France

 +33 1 41 46 12 20
 +33 1 41 46 94 35
 savoptoma@optoma.fr



Spain

C/ José Hierro,36 Of. 1C
28522 Rivas VaciaMadrid,
Spain

 +34 91 499 06 06
 +34 91 670 08 32



Deutschland

Wiesenstrasse 21 W
D40549 Düsseldorf,
Germany

 +49 (0) 211 506 6670
 +49 (0) 211 506 66799
 info@optoma.de

Scandinavia



Lerpeveien 25
3040 Drammen
Norway

 +47 32 98 89 90
 +47 32 98 89 99
 info@optoma.no

PO.BOX 9515
3038 Drammen
Norway

Korea

WOOMI TECH.CO.,LTD.
4F, Minu Bldg.33-14, Kangnam-Ku,
Seoul,135-815, KOREA
korea.optoma.com

 +82+2+34430004
 +82+2+34430005



Japan

東京都足立区綾瀬3-25-18
株式会社オーエス
コンタクトセンター:0120-380-495

 info@os-worldwide.com
www.os-worldwide.com



Taiwan

12F., No.213, Sec. 3, Beixin Rd.,
Xindian Dist., New Taipei City 231,
Taiwan, R.O.C.
www.optoma.com.tw

 +886-2-8911-8600
 +886-2-8911-6550
 services@optoma.com.tw
asia.optoma.com

Hong Kong

Unit A, 27/F Dragon Centre,
79 Wing Hong Street,
Cheung Sha Wan,
Kowloon, Hong Kong

 +852-2396-8968
 +852-2370-1222
www.optoma.com.hk

China

Room 2001, 20F, Building 4,
No. 1398 Kaixuan Road,
Changning District
Shanghai, 200052, China

 +86-21-62947376
 +86-21-62947375
 servicecn@optoma.com.cn
www.optoma.com.cn

