



Questo manuale d'istruzione è fornito da trovaprezzi.it. Scopri tutte le offerte per [Panasonic SC-TMAX5](#)

o cerca il tuo prodotto tra le [migliori offerte di Personal Audio e Hi-Fi](#)



Questo manuale d'istruzione è fornito da trovaprezzi.it. Scopri tutte le offerte per [Panasonic SC-TMAX5](#)

o cerca il tuo prodotto tra le [migliori offerte di Personal Audio](#)

TMAX5EB.GN_TQBJ2228_en.fm Page 1 Monday, April 20, 2020 12:28 PM



Basic Operating Instructions

Wireless Speaker System

Model No. **SC-TMAX5**

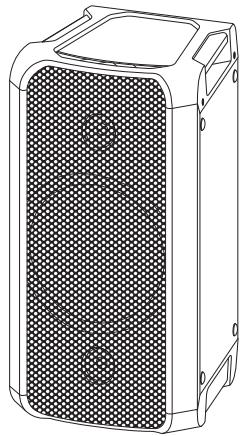

Thank you for purchasing this product.
For optimum performance and safety, please read these instructions carefully.
Please keep this manual for future reference.

This manual contains basic information. Visit website below for detailed instructions.
https://panasonic.jp/support/global/cs/audio/oi/sc_tmax5/



"EB" indicates the United Kingdom model.



Manufactured by: Panasonic Corporation
Kadoma, Osaka, Japan
Authorized Representative in Europe: Panasonic Marketing Europe GmbH
Panasonic Testing Centre
Winsbergring 15, 22525 Hamburg, Germany

Panasonic Corporation
Web Site: <http://www.panasonic.com>



© Panasonic Corporation 2020



1202-0001951

TQBJ2228
L0420CH1040

The symbols on this product (including the accessories) represent the following:

	AC
	DC
	Class II equipment (The construction of the product is double-insulated.)
	ON
	Standby

Safety precautions

WARNING!

- Unit**
- To reduce the risk of fire, electric shock or product damage,
 - Do not expose this unit to rain, moisture, dripping or splashing.
 - Do not place objects filled with liquids, such as vases, on this unit.
 - Use the recommended accessories.
 - Do not remove covers.
 - Do not repair this unit by yourself. Refer servicing to qualified service personnel.
 - Do not let metal objects fall inside this unit.
 - Do not place heavy items on this unit.

- AC mains lead**
- To reduce the risk of fire, electric shock or product damage,
 - Ensure that the power supply voltage corresponds to the voltage printed on this unit.
 - Insert the mains plug fully into the socket outlet.
 - Do not pull, bend, or place heavy items on the lead.
 - Do not handle the plug with wet hands.
 - Hold onto the mains plug body when disconnecting the plug.
 - Do not use a damaged mains plug or socket outlet.
 - The mains plug is the disconnecting device. Install this unit so that the mains plug can be unplugged from the socket outlet immediately.

- Wireless charging**
- Be sure your smartphone is Qi-compatible. Charging a non-Qi-compatible smartphone can overheat and rupture the smartphone.
 - Do not charge a smartphone using procedures other than as specified.
 - If you have an electrical device, such as an implanted cardiac pacemaker or an implanted cardioverter-defibrillator, consult a physician before using this product. Radio waves from this unit could adversely affect the operation of electronic medical devices.
 - Remove the cover of the smartphone before placing it on the wireless charging area.
 - Do not cover or wrap this unit in a blanket or other bedding during charging.
 - Do not place any metallic items, such as stickers, straps or clips that contain metal, between the surface of the charging area and the smartphone.

CAUTION!

- Unit**
- To reduce the risk of fire, electric shock or product damage,
 - Do not install or place this unit in a bookcase, built-in cabinet or in another confined space. Ensure this unit is well ventilated.
 - Do not obstruct this unit's ventilation openings with newspapers, tablecloths, curtains, and similar items.
 - Do not place sources of naked flames, such as lighted candles, on this unit.
 - This unit is intended for use in moderate climates.
 - This unit may receive radio interference caused by mobile telephones during use. If such interference occurs, please increase separation between this unit and the mobile telephone.
 - Set the unit up on an even surface away from direct sunlight, high temperatures, high humidity, and excessive vibration.
 - This system might get warm after prolonged usage. This is normal. Do not be alarmed.
 - If any abnormality, such as smoke, unusual odor or noise, or excessive heat, is noticed during use, or if the product was dropped, became wet, or is damaged, immediately unplug the product from the power source and contact the service.
 - Discoloration may occur due to the user's usage conditions or environment.

- Wireless charging**
- When using this unit, keep it as far away as possible from fixed-line telephones, televisions, radios, and similar devices. Otherwise, the devices could be adversely affected.
 - If a smartphone is used to make a telephone call or communicate while it is being charged by this unit, poor reception could result.
 - Do not place magnetic cards or similar items near this unit. The magnetic data could be deleted.
 - Do not place magnetized items near this unit. Strong magnetism near the product could cause it to malfunction.
 - Do not place RFID/NFC cards or similar items near this unit. The card may be damaged.
 - Multiple Qi-compatible smartphones cannot be charged at the same time.
 - When charging a smartphone, keep all other devices that can be charged wirelessly at least 30 cm away. Otherwise, the smartphone may not be detected correctly and cannot be charged.
 - Be careful when charging smartphone.
 - Do not place anything other than smartphone with wireless charging function on the wireless charging area.
 - Do not touch the wireless charging area and the contact area of the smartphone while charging or immediately after charging is complete. The surface may become hot.

CAUTION!

- Improper handling or transportation manner may cause the unit to fall, etc., resulting in damage and/or personal injury.
- Do not put the unit on a table or any elevated surface.
- Do not allow children to climb on the unit.
- Be careful when babies or children are near.



Accessories

- 1 AC mains lead
For the United Kingdom and Ireland (TSXX210)

Setting up

Connect the AC mains lead.

(For the AC mains plug of three pins)
READ THE "Caution for AC mains lead" BEFORE CONNECTION.

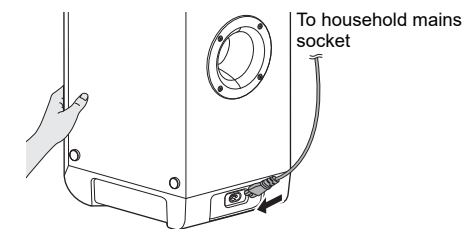

Caution for AC mains lead

(For the AC mains plug of three pins)

For your safety, please read the following text carefully.
This appliance is supplied with a moulded three pin mains plug for your safety and convenience.
A 5-ampere fuse is fitted in this plug.
Should the fuse need to be replaced please ensure that the replacement fuse has a rating of 5-ampere and that it is approved by ASTA or BSI to BS1362.

Check for the ASTA mark or the BSI mark on the body of the fuse.

If the plug contains a removable fuse cover you must ensure that it is refitted when the fuse is replaced. If you lose the fuse cover the plug must not be used until a replacement cover is obtained.
A replacement fuse cover can be purchased from your local dealer.

Before use
Remove the connector cover.

How to replace the fuse
The location of the fuse differ according to the type of AC mains plug (figures A and B). Confirm the AC mains plug fitted and follow the instructions below.
Illustrations may differ from actual AC mains plug.

- Open the fuse cover with a screwdriver.

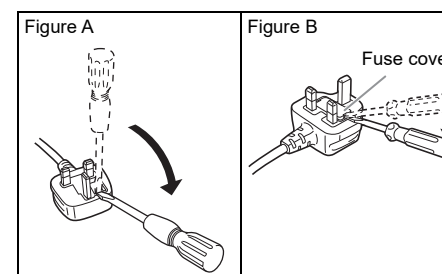

- Replace the fuse and close or attach the fuse cover.

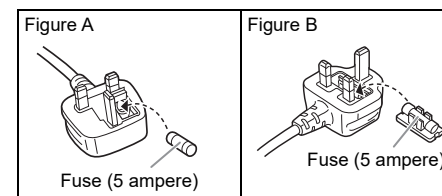

Placement

You can place this system vertically or horizontally.

Vertical placement

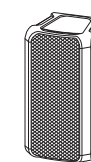

Horizontal placement

(Place the side with the rubber foot facing down.)

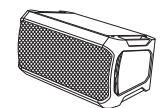

Note:

- Keep the unit at least 10 cm away from other objects for proper ventilation.
- The speakers do not have magnetic shielding. Do not put them near PCs or other equipment easily influenced by magnetism.
- You cannot use wireless charging function when the unit in horizontal placement.

Overview of controls

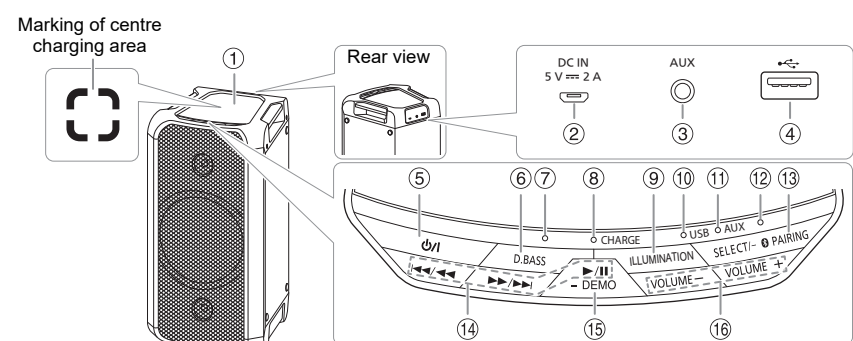

- Wireless charging area
Place the Qi-compatible smartphone on the marking.
- Micro USB port
For external power source only.
- AUX IN terminal
Connect an external music device and play the music. Hold the unit when connecting or disconnecting the device.
- USB port
- Standby/on switch
- Enhance the bass sound
- D.BASS indicator
Lights up when D.BASS effect is switched on.
- CHARGE indicator
Refer to "Wireless charging" for details.
- Select the illumination effects
You can change the illumination effect on the system. Press repeatedly to select the desired illumination effect.
- USB indicator
Lights up when USB is selected as the audio source.
- AUX indicator
Lights up when AUX is selected as the audio source.
- Bluetooth® indicator
Refer to "Bluetooth® operations" for details.
- Select the audio source
Press repeatedly to select the source:
→ USB → AUX → BLUETOOTH
- To start Bluetooth® pairing, press and hold until the Bluetooth® indicator blinks.
- Basic playback control
Refer to "Basic playback" for details.
- Select DEMO play
Press and hold for more than 2 seconds, the built-in demonstration song will be played. To cancel, press the button again.
- Adjust the volume level
D.BASS indicator blinks 2 times when the volume is set to maximum or minimum.

Using the "Panasonic MAX Juke" app
You can download and install the free app "Panasonic MAX Juke" on Google Play™ or App Store® for additional features, such as jukebox request, remote control, sound control, DJ illumination and main unit settings, etc.

Android: Google Play™

iOS: App Store®



For details on the app, refer to the site below.
<http://av.jpn.support.panasonic.com/support/global/cs/audio/app/>
(This site is in English only.)

Basic playback

You can enjoy MP3 songs in the USB device and control the content in Bluetooth® device.

Play	Press [▶/II].
Pause	Press [⏸/II]. Press again to continue playback.
Skip	Press [◀/▶] or [▶▶/▶▶].
Search	Press and hold [◀◀/▶▶] or [▶▶/▶▶].

Note:
Depending on the Bluetooth® device, some operations may not work.

Wireless charging

You can charge a Qi-compatible smartphone by placing it on the wireless charging area.

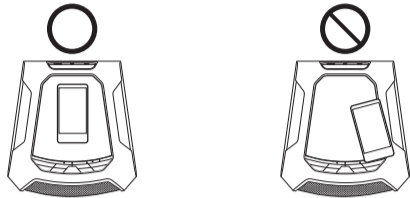

CHARGE indicator	State
Off	<ul style="list-style-type: none"> Charging is complete. The smartphone is not recognisable by this unit.
Lights up	Charging a smartphone.
Blinks quickly (at 0.25-second intervals)	A Charging error has occurred or there is a malfunction.
Blinks slowly (at one second intervals)	Temperature of Qi-compatible smartphone is too high or too low.

Using an external power bank

Connect the external power bank (not supplied) to the micro USB port at the rear of the unit
Hold the unit when connecting or disconnecting the external power bank..

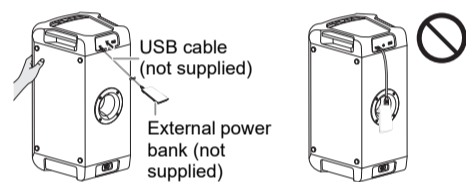

Do not hang the power bank by the USB cable, damage may occur to USB cable or the USB connector.

- Note:**
- When using power bank as the power source, wireless charging is disabled.
 - Do not use power bank that does not conform to safety standards.
 - Do not use power bank output power below 5 V, 2 A.
 - Do not use damaged power bank. This can cause fire, electric shock or product damage.

Bluetooth® operations

Preparation
Switch on the Bluetooth® feature of the device and put the device near the system.

- Press and hold [SELECT/- PAIRING] until the Bluetooth® indicator blinks.**
- Select "SC-TMAX5" from the Bluetooth® menu of the device.**
Bluetooth® indicator stops blinking and lights up.
- Start playback on the device.**

The Bluetooth® word mark and logos are registered trademarks owned by Bluetooth SIG, Inc. and any use of such marks by Panasonic Corporation is under license. Other trademarks and trade names are those of their respective owners.

Android and Google Play are trademarks of Google LLC.

App Store is a service mark of Apple Inc., registered in the U.S. and other countries.

The Qi and Qi logo are the trademarks of the Wireless Power Consortium.

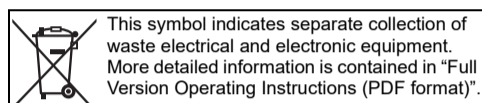

Declaration of Conformity (DoC)

Hereby, "Panasonic Corporation" declares that this product is in compliance with the essential requirements and other relevant provisions of Directive 2014/53/EU.

Customers can download a copy of the original DoC to our RE products from our DoC server:

<http://www.ptc.panasonic.eu>

Contact to Authorised Representative:

Panasonic Marketing Europe GmbH, Panasonic Testing Centre, Winsbergring 15, 22525 Hamburg, Germany

Type of wireless	Frequency band	Maximum power (dBm E.I.R.P.)
Bluetooth®	2402 – 2480 MHz	10 dBm

Sales and Support Information

For the United Kingdom and Ireland

Customer Communications Centre

- For customers within the UK: 0344 844 3899
- For customers within Ireland: 01 289 8333
- Monday – Friday 9:00am – 5:00pm (Excluding public holidays).
- For further support on your product, please visit our website: www.panasonic.co.uk

Direct Sales at Panasonic UK

- Order accessory and consumable items for your product with ease and confidence by phoning our Customer Communications Centre Monday – Friday 9:00am – 5:00pm (Excluding public holidays).
- Or go on line through our Internet Accessory ordering application at www.pas-europe.com.
- Most major credit and debit cards accepted.
- All enquiries transactions and distribution facilities are provided directly by Panasonic UK.
- It couldn't be simpler!
- Also available through our Internet is direct shopping for a wide range of finished products. Take a browse on our website for further details.

For Australia

Panasonic Warranty

- Subject to the conditions of this warranty Panasonic or its Authorised Service Centre will perform necessary service on the product, without charge for parts or labour, if in the opinion of Panasonic the product is found to have a manufacturing defect within one (1) year or (12 months) (the "warranty period") from the date of purchase appearing on your purchase receipt.
- This warranty only applies to Panasonic products purchased in Australia and sold by Panasonic Australia, it's Authorised Distributors, or Dealers, and only where the products are used and serviced within Australia or its territories. Warranty cover only applies to the services that are carried out by a Panasonic Authorised Service Centre and only if valid proof of purchase is presented when the warranty service is requested.
- This warranty only applies if the product has been installed and/or used in accordance with the manufacturer's recommendations (as noted in the operating instructions) under normal use and reasonable care (in the opinion of Panasonic). The warranty does not cover damage, malfunction or failure resulting from use of incorrect voltages, incorrect installation, accident, misuse, neglect, build-up of dirt or dust, abuse, maladjustment of customer controls, mains supply problems, thunderstorm activity, infestation by insects or vermin, tampering or repair by unauthorised persons (including unauthorised alterations), exposure to abnormally corrosive conditions, or any foreign object or matter having entered the product.
- This warranty does not cover the following items unless the fault or defect existed at the time of purchase:
 - Consumable parts
 - Cosmetic parts
 - Worn or damaged parts
 - Information stored on Hard Disk Drives, Optical Discs, USB Devices, SD Cards, Tapes
 - DTV reception issues caused by TV Aerial / Cabling / Wall socket(s)
- Some products may be supplied with Ethernet connection hardware. The warranty is limited on such products and will not cover:
 - Internet and or DLNA connection / setup related problems
 - Access fees and or charges incurred for internet connection
 - Incompatible software or software not specifically stipulated in the product operations manual; and
 - Any indirect or consequential costs associated with the incorrect use or misuse of the hardware, its connection to the internet or any other device.
- To claim warranty service, when required, you should:
 - Contact Panasonic's Customer Care Centre on 132 600 for Service Centre information.
 - Confirm the opening and acceptance times with the Authorised Service Centre that you choose.
 - Then send or take the product to a Panasonic Authorised Service Centre together with your proof of purchase receipt.
 - Any freight and insurance costs associated with the transport of the product to and/or from your nearest Authorised Service Centre must be arranged and paid for by you.
- The warranties hereby conferred do not extend to, and exclude, any costs associated with the installation, de-installation or re-installation of a product, including costs related to the mounting, de-mounting or remounting of any screen, (and any other ancillary activities), delivery, handling, freighting, transportation or insurance of the product or any part thereof or replacement of and do not extend to, and exclude, any damage or loss occurring by reason of, during, associated with, or related to such installation, de-installation, re-installation or transit.

Panasonic Authorised Service Centres are located in major metropolitan areas and most regional centres of Australia, however, coverage will vary dependant on product. For advice on exact Authorised Service Centre locations for your product, please telephone our Customer Care Centre on 132 600 or visit our website and use the Service Centre Locator.

In addition to your rights under this warranty, Panasonic products come with consumer guarantees that cannot be excluded under the Australian Consumer Law. If there is a major failure with the product, you can reject the product and elect to have a refund or to have the product replaced or if you wish you may elect to keep the goods and be compensated for the drop in value of the goods. You are also entitled to have the product repaired or replaced if the product fails to be of acceptable quality and the failure does not amount to a major failure.

If there is a major failure in regard to the product which cannot be remedied then you must notify us within a reasonable period by contacting the Panasonic Customer Care Centre. If the failure in the product is not a major failure then Panasonic may choose to repair or replace the product and will do so in a reasonable period of time from receiving notice from you.

THIS WARRANTY CARD AND THE PURCHASE DOCKET (OR SIMILAR PROOF OF PURCHASE) SHOULD BE RETAINED BY THE CUSTOMER AT ALL TIMES

If you require assistance regarding warranty conditions or any other enquiries, please visit the **Panasonic Australia** website www.panasonic.com.au or contact by phone on **132 600**
If phoning in, please ensure you have your operating instructions available.

Panasonic Australia Pty. Limited

ACN 001 592 187 ABN 83 001 592 187
1 Innovation Road, Macquarie Park NSW 2113
www.panasonic.com.au

PRO-031-F11 Issue: 5.0

23-01-2018