



Questo manuale d'istruzione è fornito da trovaprezzi.it. Scopri tutte le offerte per [Philips TAR8805](#) o cerca il tuo prodotto tra le [migliori offerte di Personal Audio e Hi-Fi](#)



Questo manuale d'istruzione è fornito da trovaprezzi.it. Scopri tutte le offerte per [Philips TAR8805](#) o cerca il tuo prodotto tra le [migliori offerte di Personal Audio e Hi-Fi](#)



User manual



Register your product and get support at www.philips.com/support

Contents

1 Important	2	8 Use system settings menu	16
Safety	2	Adjust network settings	16
<hr/>		Set time/date	16
2 Your Internet radio	3	Set system language	17
Introduction	3	Reset all the settings	17
What's in the box	3	Check software update information	17
Overview of the Internet radio	4	Know the software version	17
<hr/>		Adjust backlight settings	17
3 Get started	5	9 Use main menu	18
Prepare radio antenna	5	Set alarm	18
Connect power	5	Set sleep timer	19
Perform initial setup	6	<hr/>	
Turn on	7	10 Other features	20
Source menu	7	Play audio through Bluetooth	20
<hr/>		Adjust volume	20
4 Listen to Internet radio	8	Mute sound	20
Use menu in Internet radio mode	8	Wireless charging	20
Store Internet radio stations	9	<hr/>	
Select a preset Internet radio station	9	11 Product information	21
Show Internet radio information	9	<hr/>	
<hr/>		12 Troubleshooting	22
5 Listen to Podcasts	10	<hr/>	
<hr/>		13 Notice	23
6 Listen to Spotify	10	Compliance	23
<hr/>		Care of the environment	23
7 Listen to DAB radio	11	Trademark notice	23
Tune to DAB radio stations	11	<hr/>	
Store DAB radio stations	11		
Select a preset DAB radio station	12		
Use menu in DAB mode	12		
Show DAB information	13		
<hr/>			
7 Listen to FM radio	14		
Tune to FM radio stations	14		
Store FM radio stations	14		
Store FM radio stations automatically	14		
Select a preset FM radio station	14		
Use menu in FM mode	15		
Show RDS information	15		

I Important

Safety



Warning

- Never remove the casing of this Internet radio.
 - Never lubricate any part of this Internet radio.
 - Never place this Internet radio on other electrical equipment.
 - Keep this Internet radio away from direct sunlight naked flames or heat.
 - Make sure that you always have easy access to the power cord, plug or adaptor to disconnect the Internet radio from the power.
- Read and follow these instructions.
 - Make sure that there is enough free space around the product for ventilation.
 - Refer all servicing to qualified service personnel. Servicing is required when the Internet radio has been damaged in any way; such as power-supply cord or plug is damaged, liquid has been spilled or objects have fallen into the Internet radio, the Internet radio has been exposed to rain or moisture, does not operate normally, or has been dropped.
 - Only use attachments/accessories specified by the manufacturer.
 - Use only power supplies listed in the user manual.
 - Unplug this product during lightning storms or when unused for long periods of time.
 - The product shall not be exposed to dripping or splashing.
 - Do not place any sources of danger on the product (e.g. liquid filled objects, lighted candles).
 - Where the plug of the Direct Plug-in Adapter is used as the disconnect device, the disconnect device shall remain readily operable.
- Do not use this apparatus near water.
 - Install in accordance with the manufacturer's instructions.
 - Do not install near any heat sources such as radiators, heat registers, stoves, or other apparatus (including amplifiers) that produce heat.

2 Your Internet radio

Congratulations on your purchase, and welcome to Philips! To fully benefit from the support that Philips offers, register your product at www.philips.com/welcome.

Introduction

With this radio, you can:

- listen to Internet radio through network connection;
- listen to FM and Digital Audio Broadcasting (DAB) radio;
- play audio from Bluetooth-enabled devices.
- use your phone, tablet or computer as a remote control for Spotify.
- know the time; and set two alarms.
- charge your mobile device with the wireless phone charger or USB.

What's in the box

Check and identify the contents of your package:

- Internet radio
- Power adapter
- Short User Manual
- Safety & notice leaflet

Overview of the Internet radio

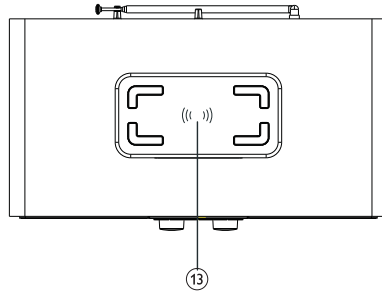
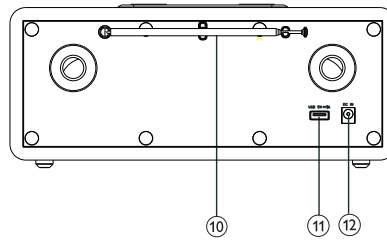
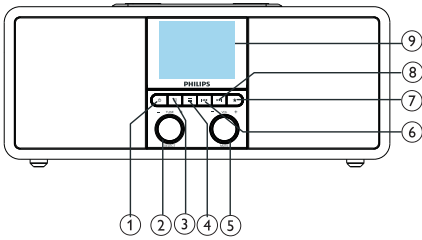

① **⏻**

- Turn on the radio.
- Switch to standby mode.

② **SELECT knob**

- Turn clockwise or anticlockwise to tune to radio stations.
- Turn clockwise or anticlockwise to navigate through the menu list.
- Press to confirm a selection.
- Press and hold to auto scanning all station in FM tuner mode.

③ **SOURCE**

- Press to enter the source menu.

④ **EMENU**

- In working mode, access the top menu.
- Press and hold to display information in FM/DAB mode.

⑤ **VOL knob/MUTE**

- Turn to adjust volume.
- Press to mute or resume sound.

⑥ **PREVIOUS**

- In Bluetooth mode: Press to skip to the previous track.
- In Tuner mode: Press to skip to the previous preset station.
- InTuner mode: Press and hold to decrease the frequency continuously till tune to a station.

⑦ **★ PRESET**

- Store radio stations.
- Display the preset station list.

⑧ **▶▶ NEXT**

- In Bluetooth mode: Press to skip to the next track.
- InTuner mode: Press to skip to the next preset station.
- InTuner mode: Press and hold to increase the frequency continuously till tune to a station.

⑨ **Display screen**

- Show current status.

⑩ **Radio antenna/Wi-Fi antenna**

- Improve radio reception.
- Improve Wi-Fi reception.

⑪ **USB slot (for charging only)**

- Charge external device(DC5V 1 A).

⑫ **DC IN**

- Connect AC power adaptor.

⑬ **Wireless Qi Charging Pad**

- Charge smart phone wirelessly.

3 Get started

Always follow the instructions in this chapter in sequence.

Prepare radio antenna

For better radio reception, fully extend and adjust the position of the antenna.

☰ Note

- To prevent interference, position the antenna as far as possible from any other radiation sources.

Connect power

! Caution

- Risk of product damage! Make sure that the power voltage corresponds to the voltage printed on the back or underside of the Internet radio.
- Risk of electric shock! When you unplug the AC plug, always pull the plug from the socket. Never pull the cord.

Connect the power adapter to:

- the **DC IN** socket on the back of the radio, and the wall socket.

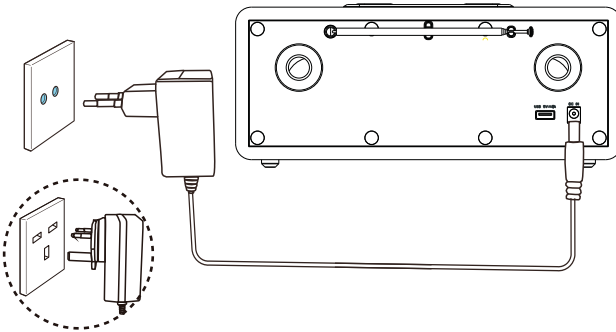

Perform initial setup

When the radio is powered on for the first time, the **[Setup wizard]** appears on the display panel. Follow the instructions below to configure some basic settings.

To listen to Internet radio, you need to set up Wi-Fi connection first. Wi-Fi Protected Setup (WPS) is a standard created by Wi-Fi Alliance for easy establishment of secure wireless home network. If your wireless router supports WPS, you can quickly and securely connect the radio to the router through one of the two setup methods: Push Button Configuration (PBC), or Personal Identification Number (PIN). For those that do not support WPS, you have another option to connect the radio to the wireless router.

Note

- Before you connect to a network, familiarize yourself with the network router.
- Make sure that your home Wi-Fi network is enabled.
- For better Wi-Fi reception, rotate and adjust the position of the Wi-Fi antenna.

When **[Setup wizard]** is displayed, turn **SELECT knob** to select **[YES]** to start the setup. If you select **[NO]**, you are asked to run the wizard next time.

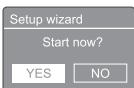

- 2 Press **SELECT knob** to confirm.
↳ **[12/24 hour format]** is displayed.
- 3 Turn **SELECT knob** to select 12 or 24 hour format.
- 4 Press **SELECT knob** to confirm.
↳ **Auto update list** is displayed
- 5 Repeat steps 3 to 4 to select whether to synchronize time with radio stations.



- **[Update from DAB]**: synchronize time with DAB stations.
- **[Update from FM]**: synchronize time with FM stations.
- **[Update from Network]**: synchronize time with Internet radio stations.
↳ If **[Update from Network]** is selected, repeat steps 3 to 4 to set time zone, and then repeat steps 3 to 4 to set daylight saving time.
- **[No update]**: deactivate time synchronization.
↳ If **[No update]** is selected, repeat steps 3 to 4 to set date and time.

6 Repeat steps 3 to 4 to select **[YES]** to keep network connected.

7 Repeat steps 3 to 4 to select the Wlan region.

↳ The radio begins to search for wireless networks automatically.

↳ A list of available Wi-Fi networks appear.

8 Repeat steps 3 to 4 to select your Wi-Fi network.

9 Press **SELECT knob** to select an option to connect your wireless router

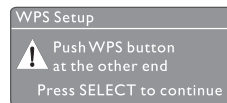

- **[Push Button]**: select this option if your wireless router supports WPS and PBC setup method. You are prompted to press the connect button on your router and then press **OK** to continue.
- **[Pin]**: select this option if your wireless router supports WPS and PIN setup method. The radio generates an 8-digit code number that you can enter into the router.

4 Listen to Internet radio

The radio can play thousands of radio stations and podcasts from around the world through the Internet connection.

Use menu in Internet radio mode

Once the Internet connection is established, you will find a list of stations displayed in the station list. Then select one to start broadcasting.



Note

- Make sure that your home Wi-Fi network is enabled.
- For better Wi-Fi reception, rotate and adjust the position of the Wi-Fi antenna.

- 1 Press **SOURCE** to select **[Internet radio]** mode.
 - ↳ The radio starts connecting to the previously connected network, and then tunes to your last listened Internet radio station.
 - ↳ If network connection has not been established before, the radio starts searching for wireless networks automatically (Refer to the section "**Get started**">"**Perform initial setup**" or "**Use system settings menu**">"**Adjust network settings**" to establish network connection).
- 2 Press **MENU** to access the menu.
- 3 Turn **SELECT knob** to scroll through the menu options:

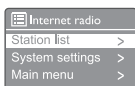

- **[Station list]**: tune to any available Internet radio stations.
- **[System settings]**: adjust system settings (the same menu option for all working modes. See the Chapter "**Use system settings menu**" for details).
- **[Main menu]**: access main menu (the same menu option for all working modes. See the Chapter "**Use main menu**" for details).

4 To select an option, press **SELECT knob**.

5 Repeat steps 3 to 4 if any sub-option is available under one option.

- To return to the previous menu, press .

[Station list]

- **[China]**: tune to any available Internet radio stations in China, such as pop music, classical music, business news, and so on.
- **[Stations]**:
 - **[History]**: browse Internet radio stations by history.
 - **[Search]**: search for Internet radio stations. To search, turn **SELECT knob** to enter a keyword by selecting characters, then press **SELECT knob** to continue.
 - **[Location:]** browse Internet radio stations by location.
 - **[Popular]**: tune to the most popular stations on the Internet.
 - **[Discover]**: tune to discover list for Internet radio.

Store Internet radio stations

 Note

- You can store a maximum of 20 preset radio stations.

- 1 In Internet radio mode, tune to an Internet radio station.
- 2 Press and hold **★ PRESET** for two seconds.
 - ↳ The preset station list is displayed.
- 3 Turn **SELECT knob** to select a preset number:
- 4 Press **SELECT knob** to confirm.
 - ↳ **[Preset stored]** is displayed.
 - ↳ The station is stored in the selected position.

Select a preset Internet radio station

In Internet radio mode:

- 1 Press **★ PRESET**.
- 2 Turn **SELECT knob** to select a number
- 3 Press **SELECT knob** to confirm.

Show Internet radio information



While listening to Internet radio, press and hold  repeatedly to scroll through the following information (if available):

- ↳ Artist and track name
- ↳ Station description
- ↳ Station genre and location
- ↳ Codec and sampling rate
- ↳ Playback buffer
- ↳ Date

 Note

- If no button is pressed within 15 seconds, the menu exits.
- Station lists and submenus may change from time to time and vary by locations.

5 Listen to Podcasts

- 1 Press  **SOURCE** to select **[Podcasts]** mode.
- 2 Press  **MENU** to access the menu.
- 3 Turn **SELECT knob** to scroll through the menu options:
- 4 To select an option, press **SELECT knob**.
- 5 Repeat steps 3 to 4 if any sub-option is available under one option.
 - ↳ To return to the previous menu, press .

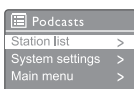

6 Listen to Spotify

Use your phone, tablet or computer as a remote control for Spotify.

Go to spotify.com/connect to learn how

The Spotify Software is subject to third party licenses found here: www.spotify.com/connect/third-party-licenses.

7 Listen to DAB radio

Tune to DAB radio stations

The first time you select DAB radio mode, or if the station list is empty, the radio performs a full scan automatically.

- Press  **SOURCE** to select **[DAB radio]** mode.
 - ↳ **[Scanning]** is displayed.
 - ↳ The radio scans and stores all the DAB radio stations automatically, and then broadcasts the first available station.
 - ↳ The station list is memorized in the radio. Next time when you turn on the radio, the station scan does not take place.

To tune to a station from the available station list:

- In DAB mode, turn **SELECT knob** to navigate through the available DAB stations.

Tip

- The stations may change from time to time. To update the station list, select the **[Scan]** menu to perform full scan.

Store DAB radio stations

Note

- You can store a maximum of 20 preset radio stations.

- 1 In DAB mode, tune to a DAB radio station.
- 2 Press and hold **★ PRESET** for two seconds.
 - ↳ The preset station list is displayed.
- 3 Turn **SELECT knob** to select a preset number
- 4 Press **SELECT knob** to confirm.
 - ↳ **[Preset stored]** is displayed.
 - ↳ The station is stored in the selected position.

Select a preset DAB radio station

In DAB mode, you have two ways to select a preset radio station.

Option A:

- 1 Press **★ PRESET**.
- 2 Turn **SELECT knob** to select a number.
- 3 Press **SELECT knob** to confirm.

Option B:

- Press **◀◀/▶▶** to skip to the previous/next preset station.

Use menu in DAB mode

- 1 In DAB mode, press **≡ MENU** to access DAB menu.
- 2 Turn **SELECT knob** to scroll through the menu options:

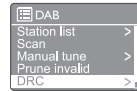

- **[Station list]**: display all DAB radio stations. If no station is found, the radio starts to scan DAB stations and add them to the station list.
 - **[Scan]**: scan and store all the available DAB radio stations.
 - **[Manual tune]**: tune to a specific channel/frequency manually and add it to the station list.
 - **[Prune invalid]**: remove all the invalid stations from the station list.
 - **[DRC]**: compress the dynamic range of a radio signal, so that the volume of quiet sounds is increased, and the volume of loud sounds is reduced.
 - **[Station order]**: enable you to define how the stations are arranged when scrolling the station list.
 - **[System settings]**: adjust system settings (see the Chapter "Use system settings menu").
 - **[Main menu]**: access main menu (see the Chapter "Use main menu").
- 3 To select an option, press **SELECT knob**.
 - 4 Repeat steps 2 to 3 if any sub-option is available under one option.
 - To return to the previous menu, press **≡**.

[Prune invalid]

- **[YES]**: remove all the invalid stations from the station list.
- **[No]**: return to the previous menu.

[DRC]

- **[DRC high]**: switch DRC on to a high level (the default option recommended for noisy environment).
- **[DRC low]**: switch DRC on to a low level.
- **[DRC off]**: switch DRC off.

[Station order]

- **[Alphanumeric]**: arrange the stations in alphabetical order (default setting).
- **[Ensemble]**: list groups of stations that are broadcast together on the same ensemble (i.e.: BBC or South Wales local).
- **[Valid]**: list valid stations first, then off-air stations.



Note

- If no button is pressed within 15 seconds, the menu exits.

Show DAB information

While listening to DAB radio, press and hold  repeatedly to scroll through the following information (if available):

- ↳ Station name
- ↳ Dynamic Label Segment (DLS)
- ↳ Signal strength
- ↳ Program type (PTY)
- ↳ Ensemble name
- ↳ Frequency
- ↳ Signal error rate
- ↳ Bit rate and audio status
- ↳ Codec
- ↳ Time and date

7 Listen to FM radio



Tip

- To remove a pre-stored station, store another station in its place.

Tune to FM radio stations

- 1 Press **SOURCE** to select **[FM radio]** mode.
- 2 Turn **SELECT knob** clockwise or anticlockwise to tune to a radio station, or Press and hold for two second to tune to the next strongest radio station.
- 3 Repeat step 2 to tune to more radio stations.

Store FM radio stations



Note

- You can store a maximum of 20 FM radio stations.

- 1 In FM mode, tune to an FM radio station.
- 2 Press and hold **PRESET** for two seconds.
 - ↳ The preset station list is displayed.
- 3 Turn **SELECT knob** to select a preset number.
- 4 Press **SELECT knob** to confirm.
 - ↳ **[Preset stored]** is displayed.
 - ↳ The station is stored in the selected position.

Store FM radio stations automatically

In FM mode, press and hold **SELECT knob**.

- ↳ The unit stores all the available FM radio stations and broadcasts the first station.

Select a preset FM radio station

In FM mode, you have two ways to select a preset radio station.

Option A:

- 1 Press **PRESET**.
- 2 Turn **SELECT knob** to select a number.
- 3 Press **SELECT knob** to confirm.

Option B:

Press to skip the previous/next preset station.

Use menu in FM mode

- 1 In FM mode, press **≡ MENU** to access FM menu.
- 2 Turn **SELECT knob** to scroll through the menu options:



- **[Scan setting]**
 - **[Audio setting]**
 - **[System settings]**: adjust system settings (see the Chapter "Use system settings menu").
 - **[Main menu]**: access main menu (see the Chapter "Use main menu").
- 3 To select an option, press **SELECT knob**.
 - 4 Repeat steps 2 to 3 if any sub-option is available under one option.
 - To return to the previous menu, press **≡**

[Scan setting]

- **[Strong stations only?]-[YES]**: scan FM radio stations with strong signals only.
- **[Strong stations only?]-[NO]**: scan all the available FM radio stations.

[Audio setting]

- **[Listen in Mono only?]-[YES]**: select mono broadcast.
- **[Listen in Mono only?]-[NO]**: select stereo broadcast.

Note

- If no button is pressed within 15 seconds, the menu exits.

Show RDS information

RDS (Radio Data System) is a service that allows FM stations to show additional information. If you listen to an FM station with RDS signal, an RDS icon and the station name are displayed.

- 1 Tune to an RDS station.
- 2 Press and hold **≡** repeatedly to scroll through the following information (if available):
 - ↳ Station name
 - ↳ Radio text messages
 - ↳ Program type
 - ↳ Frequency
 - ↳ Date

8 Use system settings menu

- 1 In working mode, press **≡** to access the menu.
- 2 Turn **SELECT knob** repeatedly to select **[System settings]**.
- 3 Press **SELECT knob** to confirm.
- 4 Repeat steps 2 to 3 to select an option.

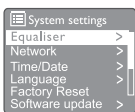

- **[Equaliser]**: select equaliser mode.
- **[Network]**: enable you to establish network connection.
- **[Time/Date]**: set time and date.
- **[Language]**: select system language.
- **[Factory Reset]**: reset the radio to factory default status.
- **[Software update]**: check the software update information.
- **[Setup wizard]**: instruct you to perform initial setup.
- **[Info]**: know software version.
- **[Privacy policy]**: view privacy notice.
- **[Backlight]**: adjust backlight settings.

≡ Note

- If no button is pressed within 15 seconds, the menu exits.

Adjust network settings

- 1 Select **[System settings]>[Network]**.
- 2 Turn **SELECT knob** to select an option or sub-option, then press **SELECT knob** to confirm.
 - **[Network wizard]**: instruct you to establish network connection.

- **[PBC Wlan setup]**: select this option if your wireless router supports WPS and PBC setup method.
- **[View settings]**: view the current network information.
- **[Manual settings]**:
 - **[DHCP enable]**: allocate IP address automatically.
 - **[DHCP disable]**: allocate IP address manually
- **[NetRemote PIN Setup]**: set up net remote enter password.
- **[Network profile]**: display a list of the networks remembered by the radio.
- **[Clear network settings]**: clear network settings selection.
- **[Keep network connected?]**: select whether to keep the network connected.

Set time/date

- 1 Select **[System settings]>[Time/Date]**.
- 2 Turn **SELECT knob** to select an option or sub-option, then press **SELECT knob** to confirm.



- **[Set Time/Date]**: set time and date.
- **[Auto update]**:
 - **[Update from DAB]**: synchronize time with DAB stations.
 - **[Update from FM]**: synchronize time with FM stations.
 - **[Update from Network]**: synchronize time with Internet radio stations.
 - **[No update]**: deactivate time synchronization.
- **[Set format]**: set 12/24 hour format.
- **[Set timezone]**: set timezone.
- **[Daylight savings]**: activate or deactivate daylight saving time.

Note

- If you are updating time from DAB or FM, the daylight savings option has no effect.
- If you are updating from the network, set your time zone.

Set system language

- 1 Select **[System settings]>[Language]**.
↳ A language list is displayed.
- 2 Turn **SELECT knob** to select a system language then press **SELECT knob** to confirm.

Reset all the settings

- 1 Select **[System settings]>[Factory Reset]**.
- 2 Turn **SELECT knob** to select an option, then press **SELECT knob** to confirm.
 - **[Yes]**: Reset the radio to factory default status.
 - **[No]**: Return to the previous menu.

Check software update information

- 1 Select **[System settings]> [Software update]**.
- 2 Turn **SELECT knob** to select an option or sub-option, then press **SELECT knob** to confirm.
 - **[Auto-check setting]**: select whether to check new software versions periodically.
 - **[Check now]**: check new software versions immediately

Note

- If the radio detects that new software is available, it asks if you want to go ahead with an update. If you agree, the new software is downloaded and installed.
- Before software upgrade, make sure that the radio is connected to a stable mains power connection. Disconnecting power during a software update may damage the product.

Know the software version

- Select **[System settings]>[Info]**.
↳ The current software version is shown.

Adjust backlight settings

- 1 Select **[System settings]>[Backlight]**.
- 2 Turn **SELECT knob** to select an option or sub- option, then press **SELECT knob** to confirm.
 - **[Timeout]**: select a timeout period for display backlight.
 - **[On level]**: select a brightness level for the backlight.
 - **[Dim level]**: select a display brightness level among Medium, Low and Off.

9 Use main menu

- 1 In working mode, press **≡** to access the top menu.
- 2 Turn **SELECT knob** repeatedly to select **[Main menu]**.
- 3 Press **SELECT knob** to confirm.
- 4 Repeat steps 2 to 3 to select an option.
 - **[Internet radio]**: select Internet radio mode.
 - **[Podcasts]**: select Podcasts radio mode.
 - **[Spotify]**: select Spotify mode.
 - **[DAB]**: select DAB mode.
 - **[FM]**: select FM mode.
 - **[Bluetooth]**: select Bluetooth mode.
 - **[Sleep]**: set sleep timer
 - **[Alarms]**: set alarm timer;
 - **[System settings]**: adjust system settings (see the chapter "Use system settings menu").

Note

- If no button is pressed within 15 seconds, the menu exits.
- You can also press **SOURCE** to select a mode: **Internet radio**, **Podcasts**, **Spotify**, **DAB radio**, **FM radio** or **Bluetooth**.

Set alarm

Note

- You can set two alarms to ring at different time.
- To make the alarm work normally, make sure that the clock is set correctly.

- 1 Select **[Main menu]>[Alarms]**.
↳ If dock is not set, a message prompts you to set clock.
- 2 Press **OK** to continue.
↳ The day digit blinks.

- 3 Turn **SELECT knob** to set the day, then press **SELECT knob** to confirm.
↳ The month digit blinks.
- 4 Repeat step 3 to set the month, year, and time respectively.
↳ The **[Alarm 1: off [00:00]]** and **[Alarm 2: off [00:00]]** options are displayed.

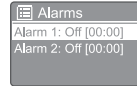

- 5 Repeat step 3 to select **[Alarm 1: off [00:00]]>[Enable:]**[Off].
- 6 Repeat step 3 to activate or deactivate the alarm timer.
 - **[Off]**: deactivate the alarm timer
 - **[Daily]**: the alarm sounds everyday.
 - **[Once]**: the alarm sounds only once.
 - **[Weekends]**: the alarm sounds on Saturdays and Sundays.
 - **[Weekdays]**: the alarm sounds each day from Monday to Friday.
- 7 Repeat step 3 to select **[time]**, and then set the alarm time.
- 8 Repeat step 3 to select **[mode]**, and then set the alarm source.
 - **[Buzzer]**: select buzzer as alarm source
 - **[Internet radio]**: select your last listened Internet radio station as alarm source.
 - **[DAB]**: select your last listened DAB radio station as alarm source.
 - **[FM]**: select your last listened FM radio station as alarm source.
- 9 Repeat step 3 to select **[preset]**, and then select your last listened station or a preset radio station as your alarm source.
- 10 Repeat step 3 to select **[Volume:]**, and then set the alarm volume.
- 11 Repeat step 3 to select **[Save]**.
↳ Alarm 1 is set.
- 12 Repeat steps 5 to 11 to set Alarm 2.

Note

- When the alarm is activated, an alarm icon for Alarm 1 or Alarm 2 is displayed.
- To stop the alarm, press Φ on the radio.
- You can also go to [System settings]>[Time/Date] to set time and date (see "Use system settings menu">"Set time/date").

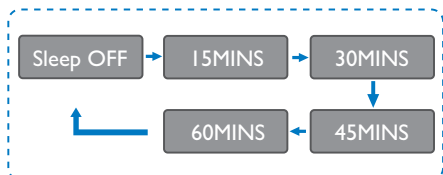

Set sleep timer



- 1 Select [Main menu]>[Sleep].
- 2 Press Turn **SELECT** knob repeatedly to select the sleep timer period (in minutes).
 - ↳ When [Sleep OFF] is displayed, the sleep timer is deactivated.

10 Other features

Play audio through Bluetooth

- 1 Press  **SOURCE** to select **[Bluetooth]** mode.
- 2 Press  **MENU** to access the menu.
- 3 Turn **SELECT knob** to scroll through the menu options:
 - Select pair menu option and press **SELECT knob**.
 - Prompt message **"Please connect with a device to: Philips TAR8805"** appears with Bluetooth icon flashing.
 - On your Bluetooth device, enable Bluetooth and search for Bluetooth devices that can be paired.
 - Select **[Philips TAR8805]** displayed on your device for pairing.
 - After successful connection, the on screen message will change to **[Connected]** and the Bluetooth icon will stop flashing.
- 4 To select an option, press **SELECT knob**.
- 5 Repeat steps 3 to 4 if any sub-option is available under one option.
 - ↳ To return to the previous menu, press .

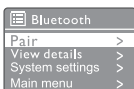

Adjust volume

- During music playback, turn **- VOL +** knob to adjust volume.

Mute sound

- During music playback, press **MUTE** to mute or resume sound

Wireless charging

- The Internet radio can charge wireless charging compatible phones by placing your phone on top of the wireless charging logo of the radio. The charging icon on display is on while charging.

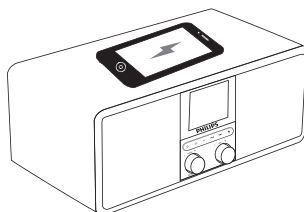

- You can also use the USB charging port at the back of the radio to charge other devices that do not support wireless charging.

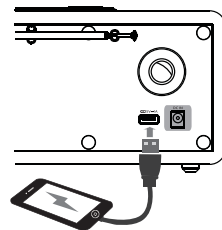

Product information

Specifications

Amplifier

Rated Output Power	3 W × 2 RMS
Frequency Response	80-20000 Hz, ±3 dB
Signal to Noise Ratio	> 65 dBA

Wi-Fi

Wi-Fi Protocol	802.11b/g/n
----------------	-------------

Tuner

Tuning Range (FM)	87.5-108 MHz
Tuning Range (DAB)	174.928-239.2 MHz (Band III)

Speaker

Speaker Impedance	4 ohm
Sensitivity	86 ± 3dB/m/W

Bluetooth

Bluetooth Version	V4.2
Bluetooth Frequency Band	2.4 Ghz ~ 2.48 GHz ISM Band
Maximum Transit Power	-4.1 dBm
Bluetooth Range	10 m (free space)

WIFI

Wi-Fi Frequency Band	2412 MHz to 2472 MHz
Maximum Transit Power	15.08 dBm

General information

AC Pbwver (Power Adapter)	Brand name: PHILIPS
	Input: 100-240 V~, 50/60 Hz, 0.8 A
	Output: 9.0 V = 2.5 A
Operation Power Consumption	≤ 24 W
Standby Power Consumption (wrthout Wi-Fi)	≤ 1 W

Dimensions

- Main Unrt (W × H × D)	268 × 113.5 × 159.3 mm
-------------------------	------------------------

Weight

- Main Unit	1.31 kg
-------------	---------

12 Troubleshooting



Warning

- Never remove the casing of this device.

To keep the warranty valid, never try to repair the system yourself.

If you encounter problems when using this device, check the following points before requesting service. If the problem remains unsolved, go to the Philips Web page (www.philips.com/support). When you contact Philips, make sure that the device is nearby and the model number and serial number are available.

No power

- Make sure that the AC power plug of the clock radio is connected properly.
- Make sure that there is power at the AC outlet.

No sound or poor sound

- Adjust the volume.
- Check whether the radio is muted or the radio station is still buffering.
- Fully extend and adjust the position of the radio antenna.
- Keep the radio away from other electronic devices to avoid radio interference.
- Check the Wi-Fi network connection.
- Rotate and adjust the position of the Wi-Fi antenna.

No response from the radio

- Disconnect and reconnect the AC power plug, then turn on the radio again.
- Check if the radio is in standby mode. If yes, turn on the radio.

Poor radio reception

- Keep the radio away from other electronic devices to avoid radio interference.
- Fully extend and adjust the position of the radio antenna.

- Check the Wi-Fi network connection.
- Rotate and adjust the position of the Wi-Fi antenna.

Insufficient Wi-Fi signal strength

- Check the distance between your router and the radio.
- Rotate and adjust the position of the Wi-Fi antenna.

Cannot connect to your Wi-Fi network

- Check if your wireless router is switched off.
- Check if your wireless router supports WPS. Use the correct setup method (PBC or PIN) to connect your WPS-supported router to the radio. If necessary, refer to the user manual of your wireless router for how to set up Wi-Fi connection.
- Configure the Wi-Fi settings again (see "Get started">"Perform initial setup" and "Use system settings menu">"Adjust network settings").

Some stations do not work sometimes

- Some stations can only support a limited number of listeners. If you try again after a few minutes, you will be able to listen to the stations.
- The station is not broadcasting. Try again later.

Some stations disappear from the station list

- When a station stops broadcasting on the Internet, it will be removed from the list. The radio will check constantly if the station is on the air. If it restarts broadcasting, it will be brought back to the station list.

Alarm does not work

- Set the clock/alarm correctly.

13 Notice

Any changes or modifications made to this device that are not expressly approved by **MMD Hong Kong Holding Limited** may void the user's authority to operate the equipment.

Compliance



Hereby **MMD Hong Kong Holding Limited** declares that this product is in compliance with the essential requirements and other relevant provisions of Directive **2014/53/EU**. You can find the Declaration of Conformity on www.philips.com/support.

Care of the environment

Disposal of your old product and battery



Your product is designed and manufactured with high quality materials and components, which can be recycled and reused.



This symbol on a product means that the product is covered by European Directive 2012/19/EU.



This symbol means that the product contains batteries covered by European Directive 2013/56/EU which cannot be disposed of with normal household waste.

Inform yourself about the local separate collection system for electrical and electronic

products and batteries. Follow local rules and never dispose of the product and batteries with normal household waste. Correct disposal of old products and batteries helps prevent negative consequences for the environment and human health.

Removing the disposable batteries

To remove the disposable batteries, see battery installation section.

Environmental information

All unnecessary packaging has been omitted. We have tried to make the packaging easy to separate into three materials: cardboard (box), polystyrene foam (buffer) and polyethylene (bags, protective foam sheet.)

Your system consists of materials which can be recycled and reused if disassembled by a specialized company. Please observe the local regulations regarding the disposal of packaging materials, exhausted batteries and old equipment.

Trademark notice



The Bluetooth® word mark and logos are registered trademarks owned by Bluetooth SIG, Inc. and any use of such marks by **MMD Hong Kong Holding Limited** is under license. Other trademarks and trade names are those of their respective owners.



Specifications are subject to change without notice.

Philips and the Philip Shield Emblem are registered trademarks of Koninklijke Philips N.V. and are used under license. This product has been manufactured by and is sold under the responsibility of MMD Hong Kong Holding Limited or one of its affiliates, and MMD Hong Kong Holding Limited is the warrantor in relation to this product.

TAR8805_I0_UM_V1.0

