



Questo manuale d'istruzione è fornito da trovaprezzi.it. Scopri tutte le offerte per [Razer DeathAdder V3 Pro](#) o cerca il tuo prodotto tra le [migliori offerte di Mouse, Tastiere, altro Input](#)



Questo manuale d'istruzione è fornito da trovaprezzi.it. Scopri tutte le offerte per [Razer DeathAdder V3 Pro](#) o cerca il tuo prodotto tra le [migliori offerte di Mouse, Tastiere, altro Input](#)



RAZER DEATHADDER V3 PRO

MASTER GUIDE

With the **Razer DeathAdder V3 Pro**, victory takes on a new shape. Refined and reforged with the aid of top esports pros, its iconic ergonomic form is now 28% lighter than its predecessor, backed by a set of cutting-edge upgrades to push the limits of competitive play.

CONTENTS

1. WHAT'S INSIDE	3
2. WHAT'S NEEDED	4
3. LET'S GET YOU COVERED	4
4. TECHNICAL SPECIFICATIONS.....	5
5. SETTING UP YOUR RAZER DEATHADDER V3 PRO	6
6. USING YOUR RAZER DEATHADDER V3 PRO.....	8
7. CONFIGURING YOUR RAZER DEATHADDER V3 PRO VIA RAZER SYNAPSE	10
8. SAFETY AND MAINTENANCE	26
9. LEGALESE	28

1. WHAT'S INSIDE

- Razer DeathAdder V3 Pro

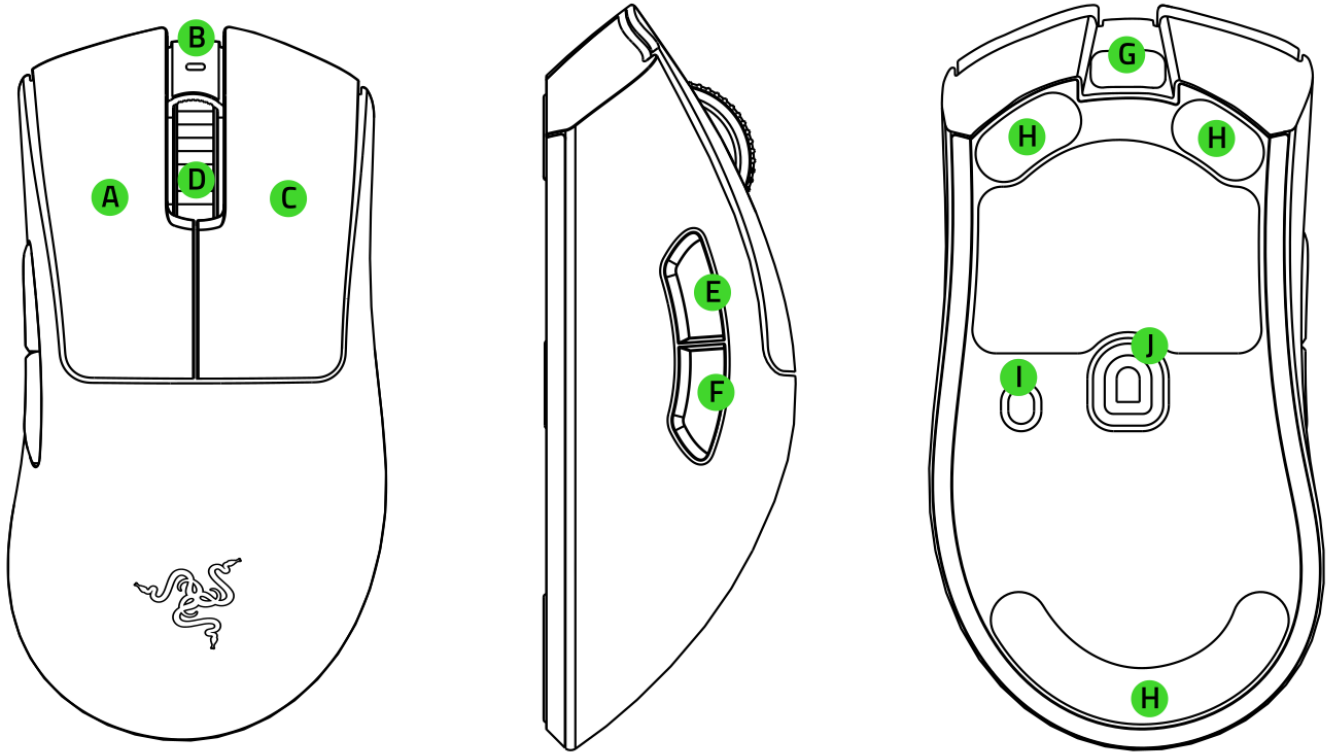

- A. Left mouse button
- B. Status indicator
- C. Right mouse button
- D. Scroll wheel
- E. Mouse button 5
- F. Mouse button 4

- G. USB Type C port
- H. PTFE mouse feet
- I. Power / DPI cycle button*
- J. Razer™ Focus Pro 30K Optical Sensor

**The DPI stages are: 400, 800, 1600 (default), 3200, and 6400; and can be customized using Razer Synapse.*

- Wireless USB dongle + USB dongle adapter

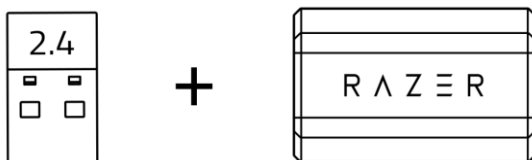

- USB Type A to USB Type C Speedflex cable

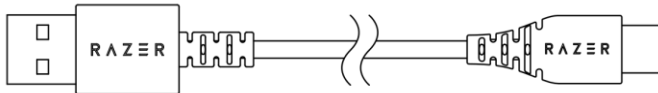

- Important Product Information Guide

2. WHAT'S NEEDED

PRODUCT REQUIREMENTS

- USB Type A port

RAZER SYNAPSE REQUIREMENTS

- Windows® 10 64-bit (or higher)
- Internet connection for software installation

3. LET'S GET YOU COVERED



Register your product and score exclusive benefits
razerid.razer.com/warranty

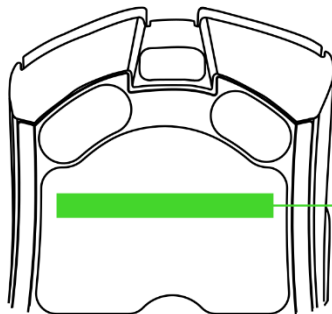

*Your product's serial number
can be found here.*

4. TECHNICAL SPECIFICATIONS

- Form factor: Right-handed
- Connectivity: Razer HyperSpeed Wireless
- Battery life: Up to 90 hours (constant motion at 1000Hz)
- RGB lighting: None
- Polling rate / interval :
 - 1000Hz with Razer HyperSpeed Wireless Dongle (included)
 - 4000Hz with Razer HyperPolling Wireless Dongle (sold separately)
- Sensor: Focus Pro
- Max sensitivity (DPI): 30000
- Max speed (IPS): 750
- Max acceleration (G): 70
- Programmable buttons: 5
- Switch type: Optical
- Switch lifecycle: 90 million
- On-board memory profiles: 1
- Mouse feet: 100% PTFE
- Cable: SpeedFlex USB Type C
- Tilt scroll wheel: No

5. SETTING UP YOUR RAZER DEATHADDER V3 PRO

CHARGING YOUR MOUSE

Plug the charging cable from your PC's USB port to the Razer DeathAdder V3 Pro. For best results, please fully charge the mouse before using it for the first time. A depleted battery will be fully charged in approximately 4 hours.

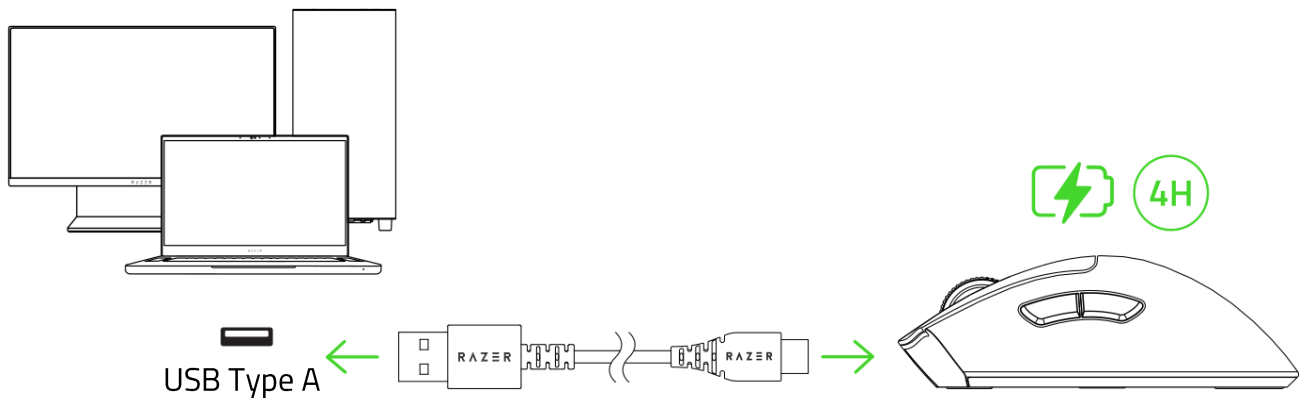

i Install Razer Synapse when prompted or download the installer from razer.com/synapse

CONNECTING YOUR MOUSE

A. Via wired mode

Connect the mouse to any of your PC's USB ports using the charging cable to use it in wired mode.

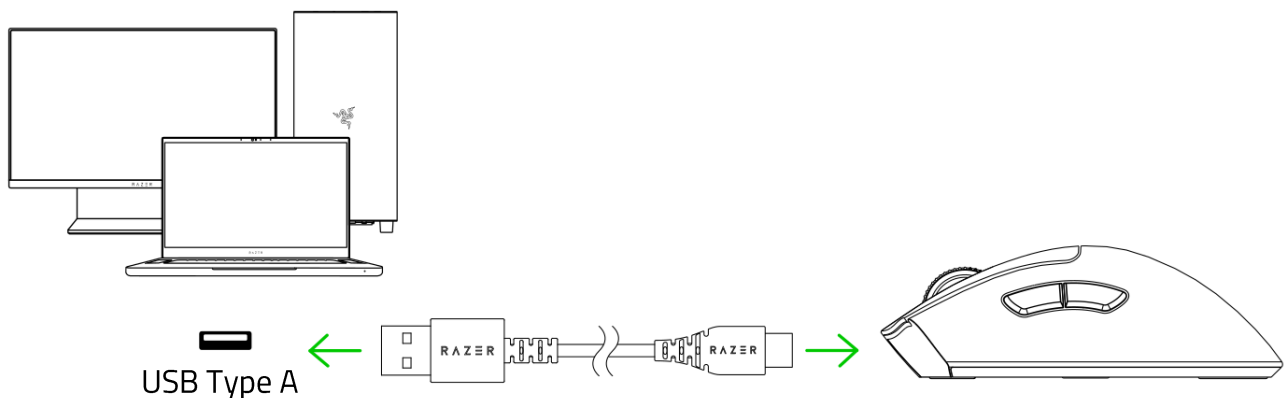

B. Via Razer™ HyperSpeed Wireless (2.4GHz) mode

1. Plug the wireless USB dongle into your PC.

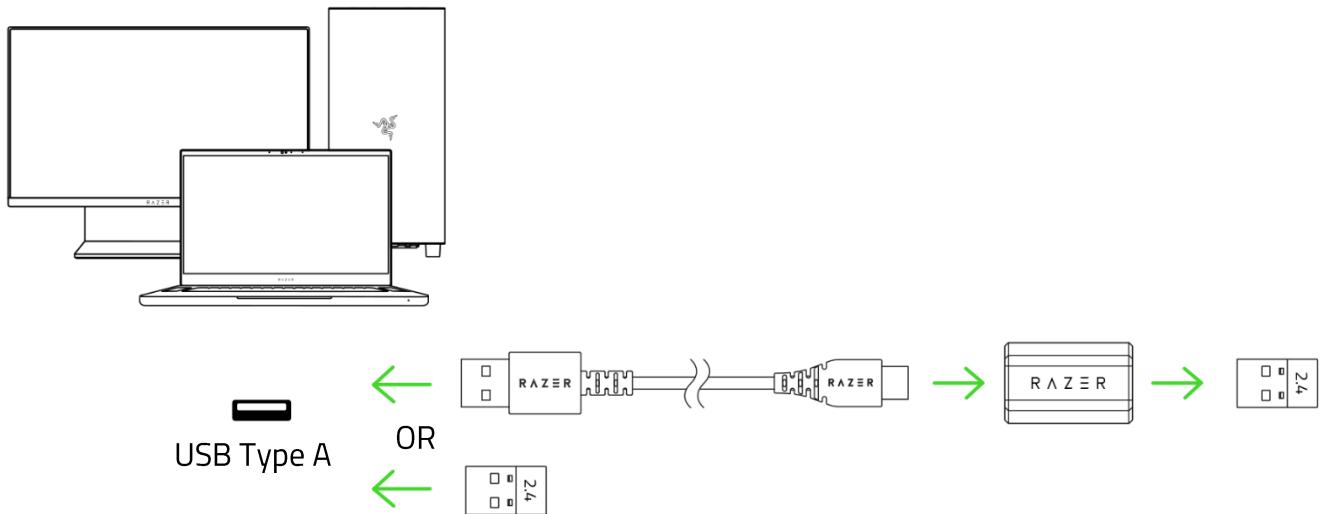

2. Press and hold the power / DPI cycle button for 3 seconds to power on the mouse.

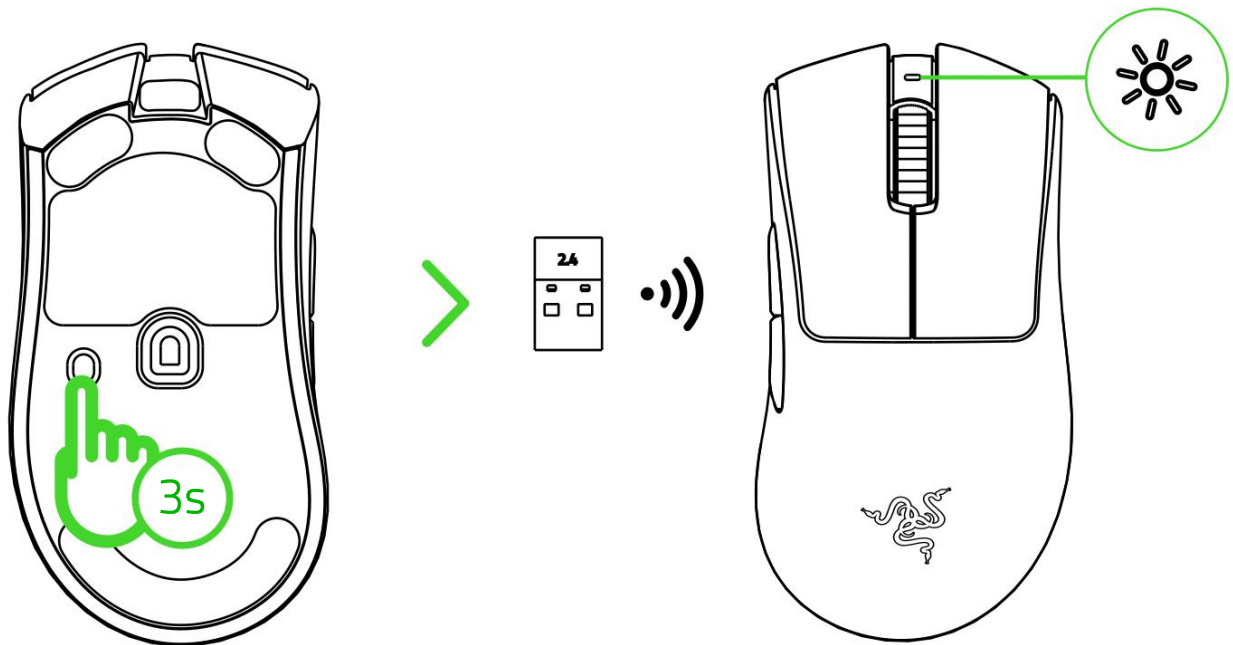

The Razer DeathAdder V3 Pro is now ready for use in 2.4GHz wireless mode.

6. USING YOUR RAZER DEATHADDER V3 PRO

LOW BATTERY NOTIFICATION

The status indicator will blink red twice in repeated intervals to indicate that its battery's power is less than 5%. This lighting sequence will repeat until the battery is drained or the mouse is connected to a PC via the charging cable.

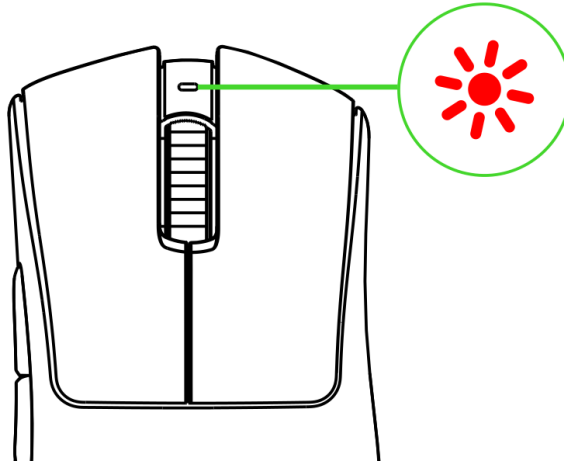

POWER ON / OFF

Press and hold the power / DPI button for 3 seconds to power on or off the mouse.

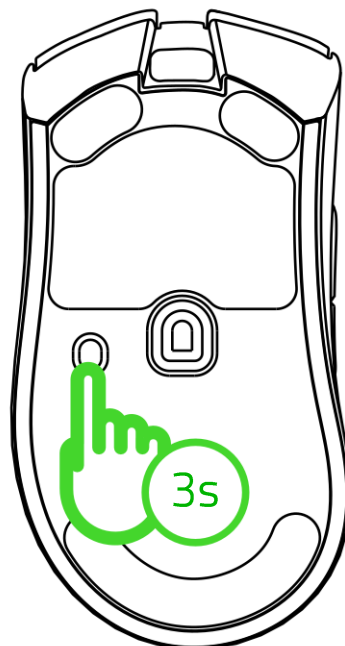

PERSONALIZING YOUR MOUSE WITH RAZER SYNAPSE

Change the mouse's DPI to match your playstyle with a press of the Power / DPI cycle button or fine-tune your own sensitivity setting using the Razer Synapse app. The status indicator will briefly change its color to show which DPI stage is currently active.

DPI	Designated color
400	Red
800	Green
1600 (Default)	Blue
3200	Cyan
6400	Yellow

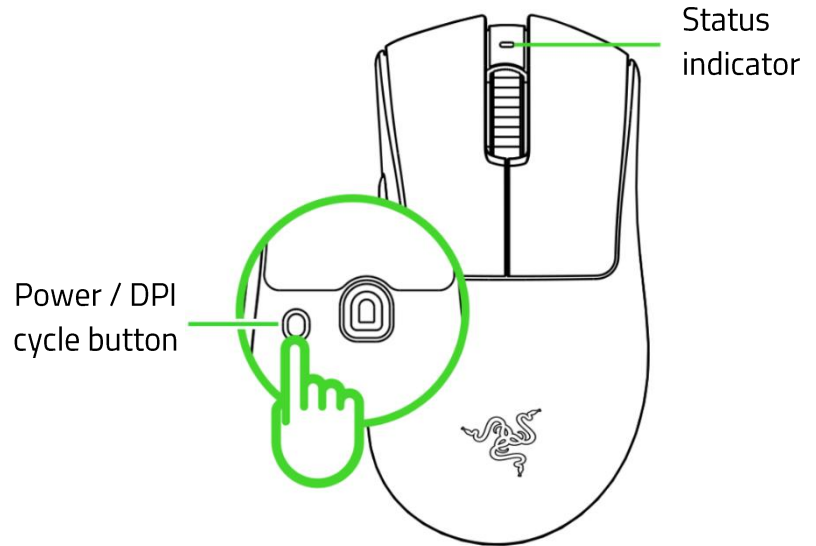

7. CONFIGURING YOUR RAZER DEATHADDER V3 PRO VIA RAZER SYNAPSE

i *Internet connection is required for installation, updates, and cloud-based features. Registering for a Razer ID account is recommended but optional. All listed features are subject to change based on the current software version, the connected device(s), and supported apps and software.*

SYNAPSE TAB

The Synapse tab is your default tab when you first launch Razer Synapse. This tab allows you to navigate the Dashboard subtab.

Dashboard

The Dashboard subtab is an overview of your Razer Synapse, where you can access all your Razer devices, modules, and online services.

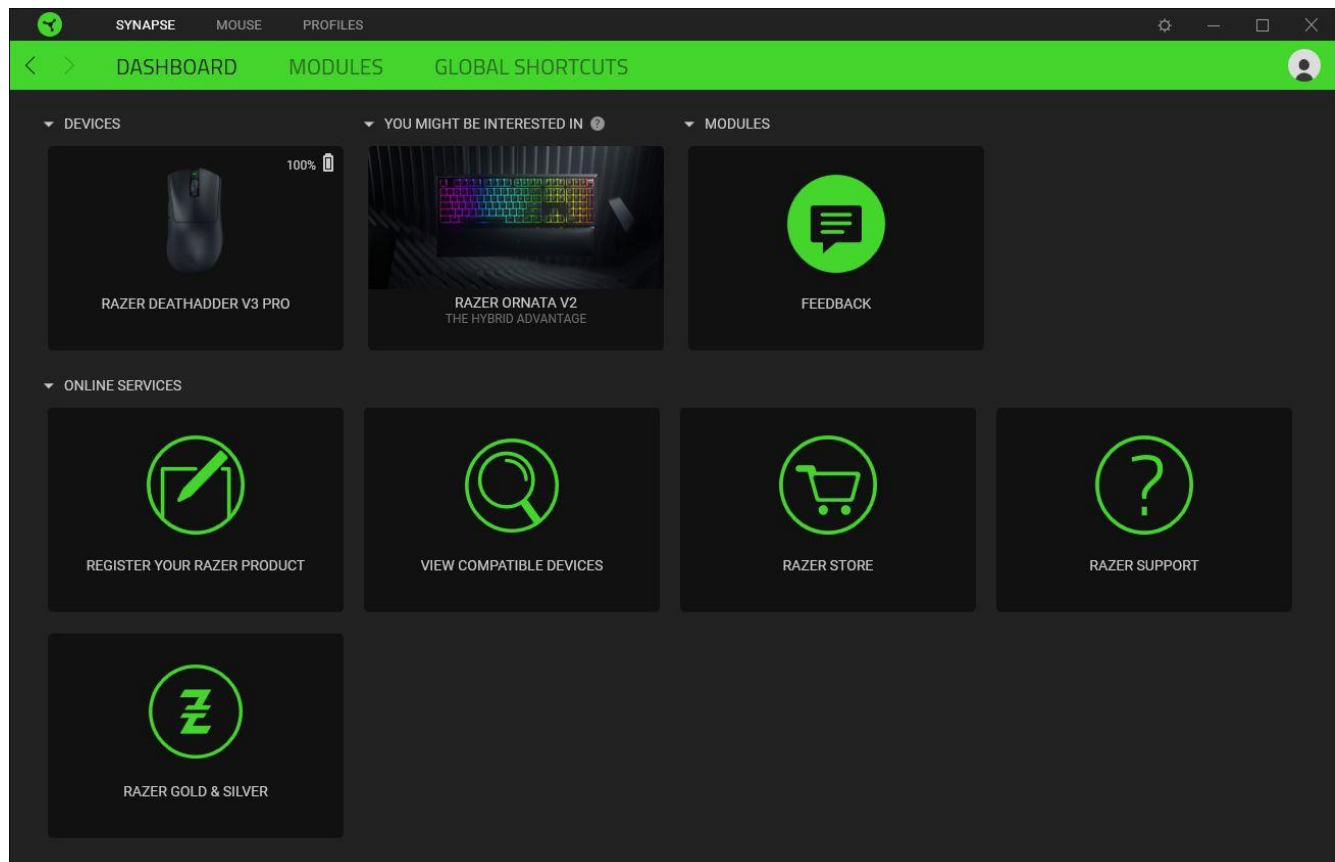

Modules

The Modules subtab displays all installed and available modules for installation.

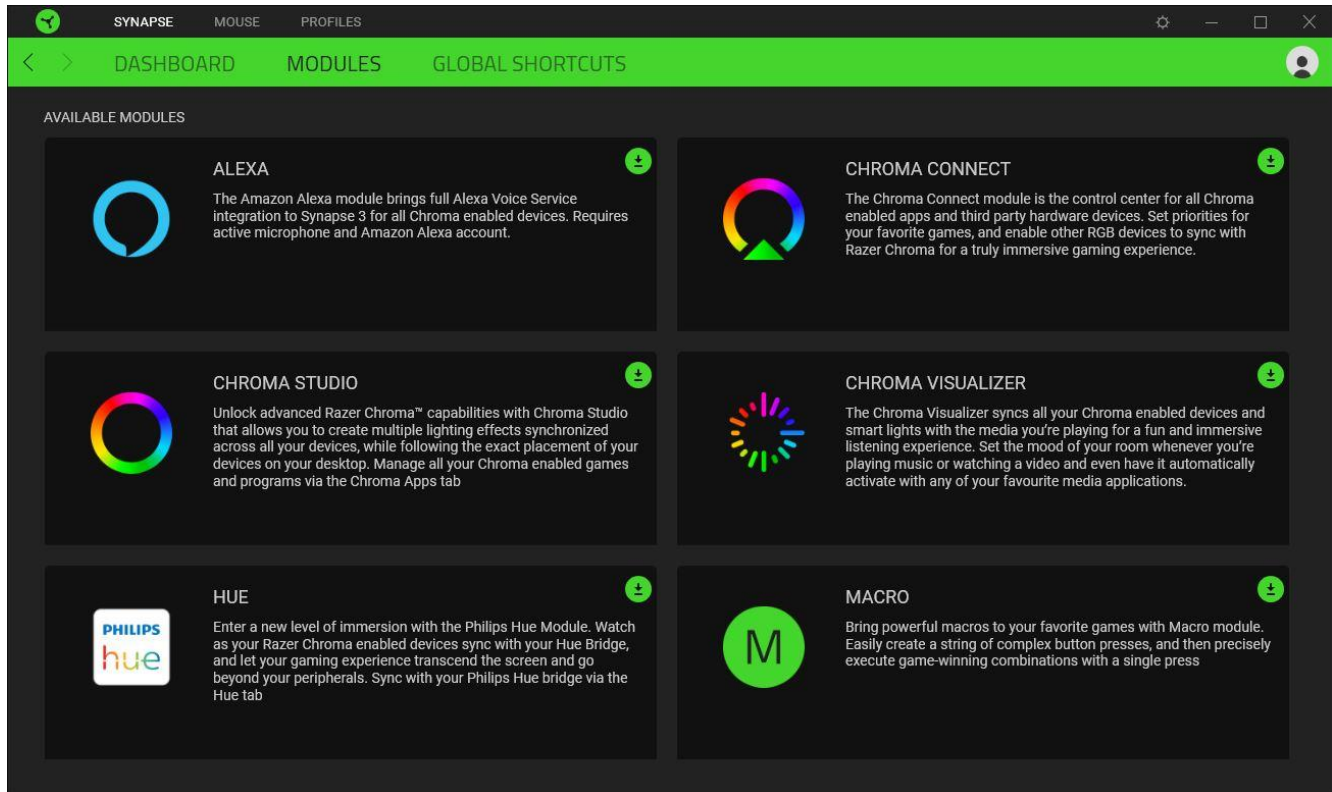

Global Shortcuts

Bind operations or Razer Synapse functions to custom key-combinations from any Razer Synapse-enabled device inputs, which apply across all device profiles. [Learn more about Profiles](#)

! *Only Razer Synapse-enabled device inputs will be recognized.*

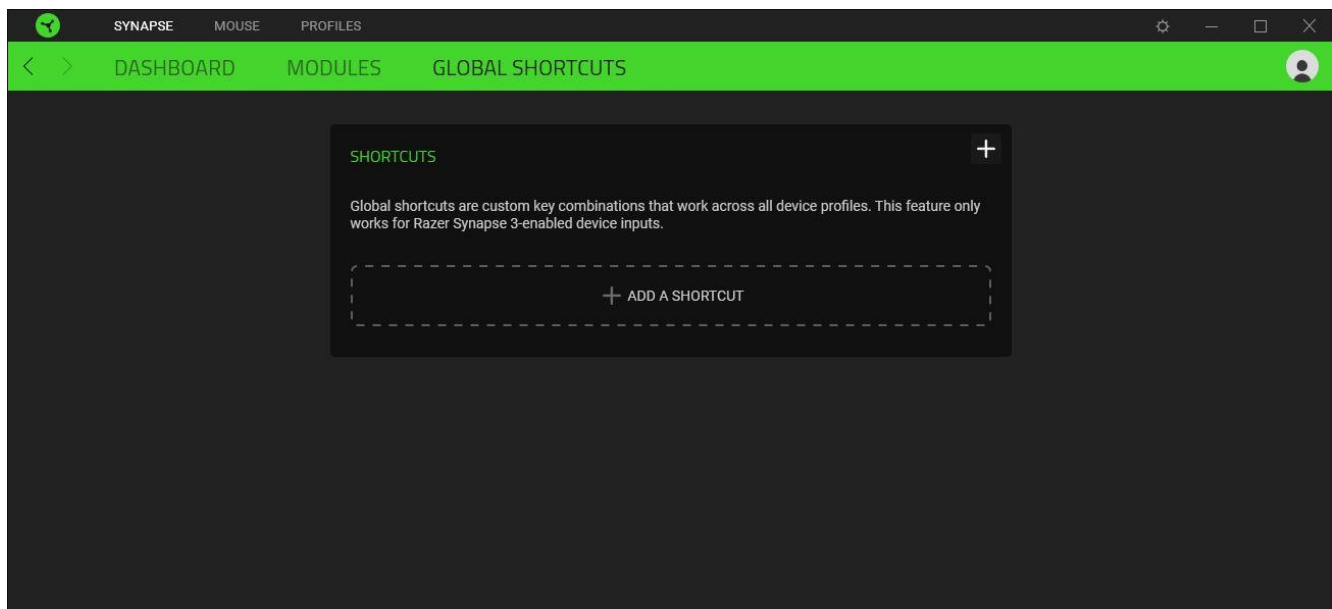

MOUSE TAB

The Mouse tab is the main tab for your Razer DeathAdder V3 Pro. From here, you can change your device's settings, such as button assignment and DPI sensitivity. Changes made under this tab are automatically saved to your system and cloud storage.

Customize

The Customize subtab is for modifying your mouse's button assignments.

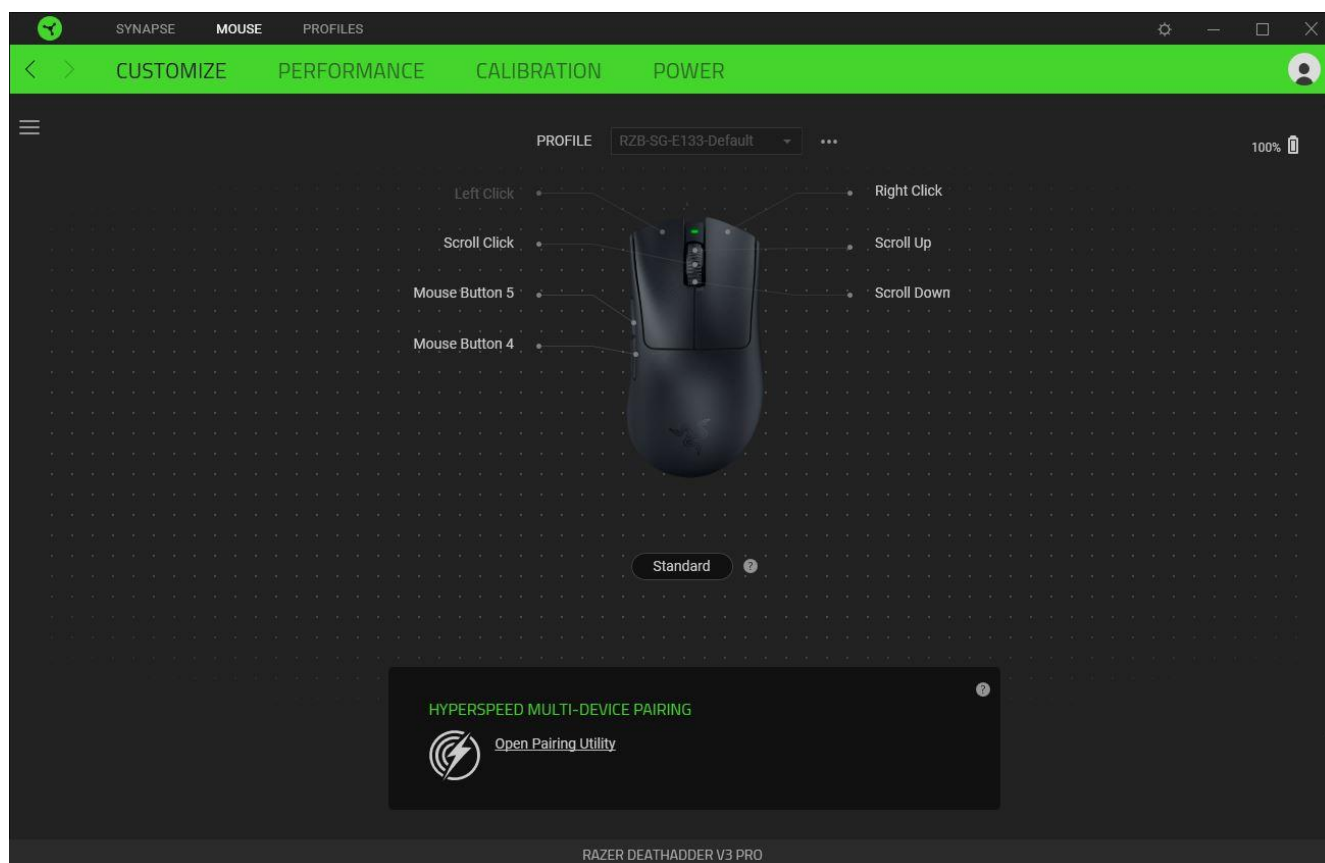

Profile

Profile is a data storage for keeping all your Razer peripheral's settings. By default, the profile name is based on your system's name. To add, rename, duplicate, or delete a profile, simply press the Miscellaneous button (●●●).

Standard / Hypershift

Hypershift mode is a secondary set of button assignments activated when the Hypershift key is held down. By default, the Hypershift key is assigned to the fn key of your Razer Synapse-supported keyboard. However, you can also set any mouse button as a Hypershift key.

HyperSpeed Multi-Device Pairing

Use this feature to pair an additional HyperSpeed-compatible device with the wireless USB dongle of your Razer DeathAdder V3 Pro. As its wireless USB dongle can support a keyboard and mouse simultaneously, you'll be able to remove the usage of separate dongles for each peripheral.



To use this feature, your Razer DeathAdder V3 Pro must be connected via HyperSpeed (2.4GHz) wireless mode. Each peripheral can only connect to one dongle at a time.

Sidebar

Clicking the Sidebar button (☰) will reveal all current button assignments for your Razer DeathAdder V3 Pro.

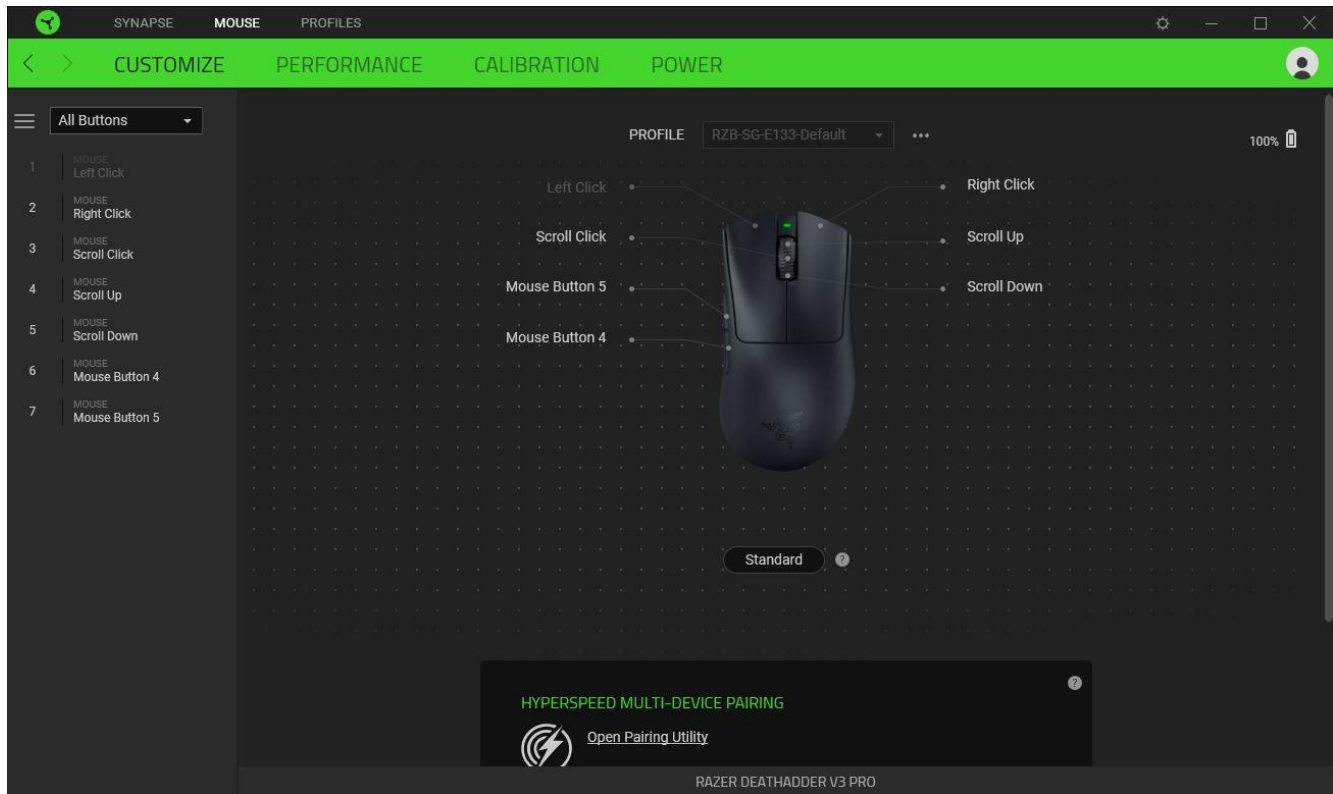

Alternatively, you can skip to a specific button assignment by selecting it on the Customize tab.

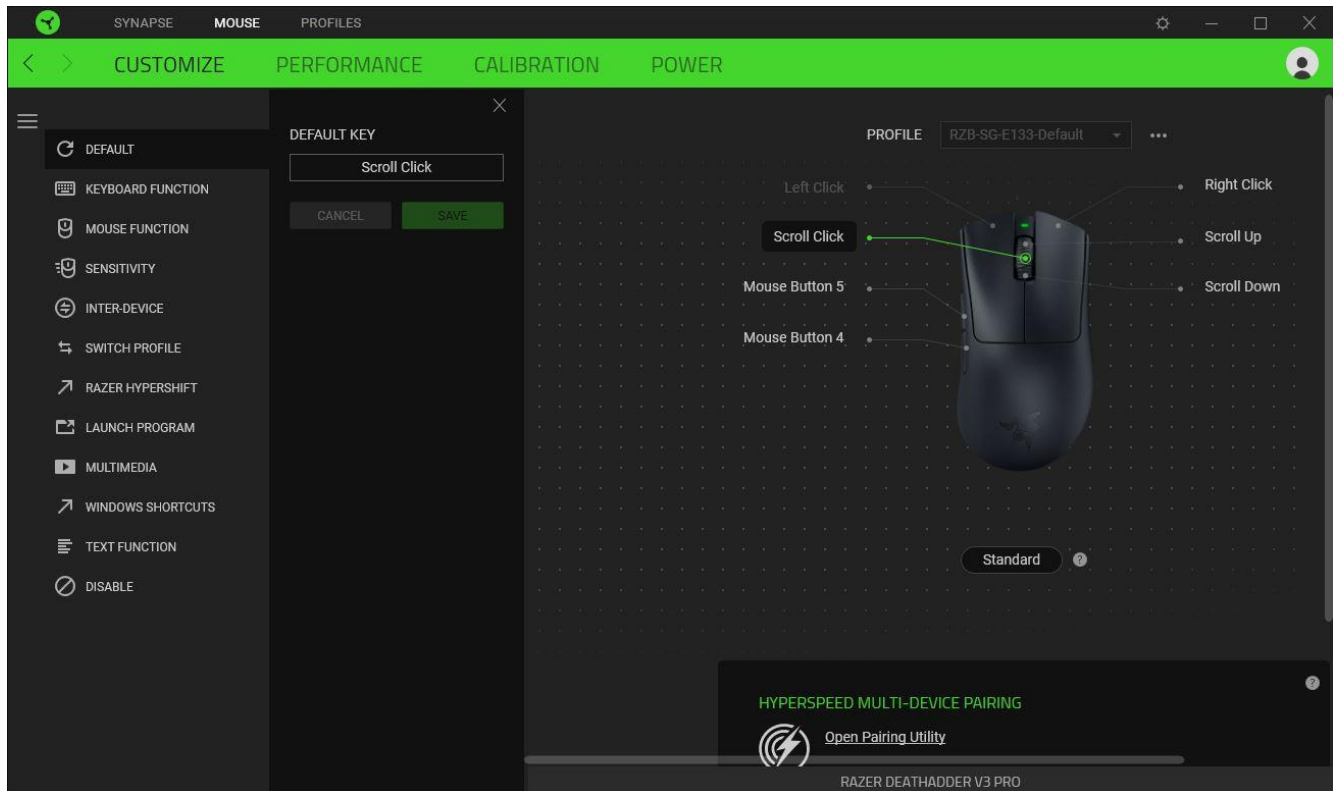

Upon selecting a button assignment, you may then change it to one of the following functions:

Default

This option enables you to return the mouse button to its original setting.

Keyboard Function

This option changes the button assignment into a keyboard function. You can also enable Turbo mode, which allows you to emulate a repeated keyboard function while the button is held down.

Mouse Function

This option substitutes the current button assignment for another mouse function. Listed below are the functions which you can choose from:

- Left Click - Performs a left mouse click using the assigned button.
- Right Click - Performs a right mouse click using the assigned button.
- Scroll Click - Activates the universal scrolling function.
- Double Click - Performs a double left click using the assigned button.
- Mouse Button 4 - Performs a "Backward" command for most internet browsers.
- Mouse Button 5 - Performs a "Forward" command for most internet browsers.
- Scroll Up - Performs a "Scroll Up" command using the assigned button.
- Scroll Down - Performs a "Scroll Down" command using the assigned button.
- Scroll Left - Performs a "Scroll Left" command using the assigned button.
- Scroll Right - Performs a "Scroll Right" command using the assigned button.

You can also choose to enable Turbo mode in some of the mouse functions, which allows you to emulate repeatedly pressing and releasing said function while the button is held down.

Sensitivity

This function allows you to manipulate the DPI setting of your Razer DeathAdder V3 Pro with a touch of a button. Listed below are the Sensitivity options and their description:

- Sensitivity Clutch - Changes the sensitivity to a predefined DPI while the designated button is held down. Releasing the button will return it to the previous sensitivity.
- Sensitivity Stage Up - Increases the current sensitivity by one stage.
- Sensitivity Stage Down - Decreases the current sensitivity by one stage.

- On-The-Fly Sensitivity - Pressing the designated button and moving the scroll wheel either up or down will increase or decrease the current DPI.
- Cycle Up Sensitivity Stages - Increases the current sensitivity stage by one. Once it reaches the highest sensitivity stage, it will return to stage 1 when the button is pressed again.
- Cycle Down Sensitivity Stages - Decreases the current sensitivity stage by one. Once it reaches stage 1, it will return to the highest sensitivity stage when the button is pressed again. [Learn more about Sensitivity Stages](#)

M Macro

A Macro is a prerecorded sequence of keystrokes and button presses that is executed with precise timing. You can conveniently execute a chain of commands by setting the button function to Macro. This function will only be visible when the Macro module is installed.

Inter-device

Inter-device allows you to change the functionality of other Razer Synapse-enabled devices. Some of these functionalities are device-specific such as using your Razer gaming keyboard to change the Sensitivity Stage of your Razer gaming mouse.

Switch Profile

Switch Profile lets you quickly change profiles and load a new set of button assignments. An on-screen notification will appear whenever you switch profiles.

Switch Lighting

Switch Lighting allows you to switch between all advanced lighting effects easily. This function will only be visible when the Chroma Studio module is installed.

Razer Hypershift

Setting the button to Razer Hypershift will allow you to activate Hypershift mode as long as the button is held down.

Launch Program

Launch Program lets you open an app or a website using the assigned button. When you select Launch Program, two choices will appear, which require you to search for a specific app you want to open or write the website address you want to visit.

Multimedia

This option allows you to assign multimedia controls to your Razer device. Listed below are the multimedia controls you can choose from:

- Volume Down - Decreases the audio output.
- Volume Up - Increases the audio output.
- Mute Volume - Mutes the audio.
- Mic Volume Up - Increases the microphone volume.
- Mic Volume Down - Decreases the microphone volume.
- Mute Mic - Mutes the microphone.
- Mute All - Mutes both microphone and audio output.
- Play / Pause - Play, pause, or resume playback of the current media.
- Previous Track - Play the previous media track.
- Next Track - Play the next media track.

Windows Shortcuts

This option allows you to assign your preferred button to a Windows Operating System shortcut command. For more information, please visit: support.microsoft.com/kb/126449

Text Function

Text Function enables you to type a prewritten text with a touch of a button. Simply write your desired text on the given field, and your text will be typed whenever the assigned button is pressed. This function has full Unicode support, and you can also insert special symbols from character maps.

Disable

This option renders the assigned button unusable. Use Disable if you do not want to use the selected button or if it interferes with your gaming.

Performance

The Performance subtab allows you to modify the sensitivity, acceleration, and polling rate.

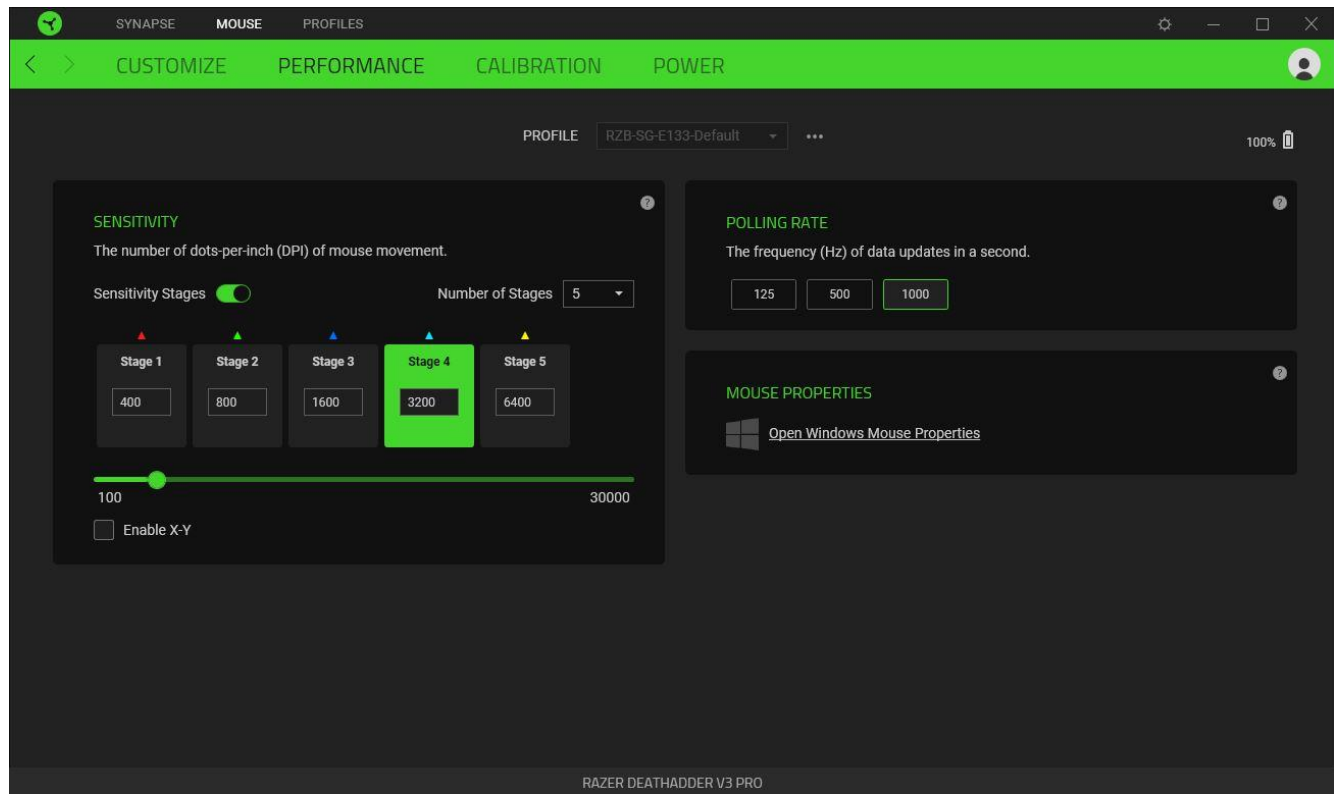

Sensitivity

Sensitivity refers to the distance the cursor will travel based on how far the mouse moved. The higher the DPI, the farther the cursor will travel, given the same mouse movement distance.

Sensitivity Stages

A sensitivity stage is a preset sensitivity value. You can create up to 5 different sensitivity stages, which you can cycle through using the sensitivity stage up/down buttons. You may use the Enable X-Y Sensitivity concurrently with this option.

Enable X-Y Sensitivity

By default, the X-axis (horizontal) and Y-axis (vertical) use the same sensitivity values. However, you may set different sensitivity values to each of the axes by selecting the Enable X-Y Sensitivity option.

Polling Rate

The higher the polling rate, the more often the computer receives information about the status of your mouse, effectively reducing input latency and improving your mouse pointer's reaction time. You can switch between 125Hz, 500Hz, and 1000Hz by selecting your desired polling rate from the options provided.

Mouse Properties

From here, you can access the Windows Mouse Properties, where you modify operating system settings that can directly affect your Razer DeathAdder V3 Pro.

Calibration

The Calibration subtab allows you to optimize your Razer Precision Sensor to any surface for better tracking.

Smart Tracking

Smart Tracking lets you set the distance at which the sensor stops tracking when it is lifted from its surface to avoid unwanted cursor movement. You may assign different values to the lift-off and landing distances by selecting the Enable Asymmetric Cut-Off.

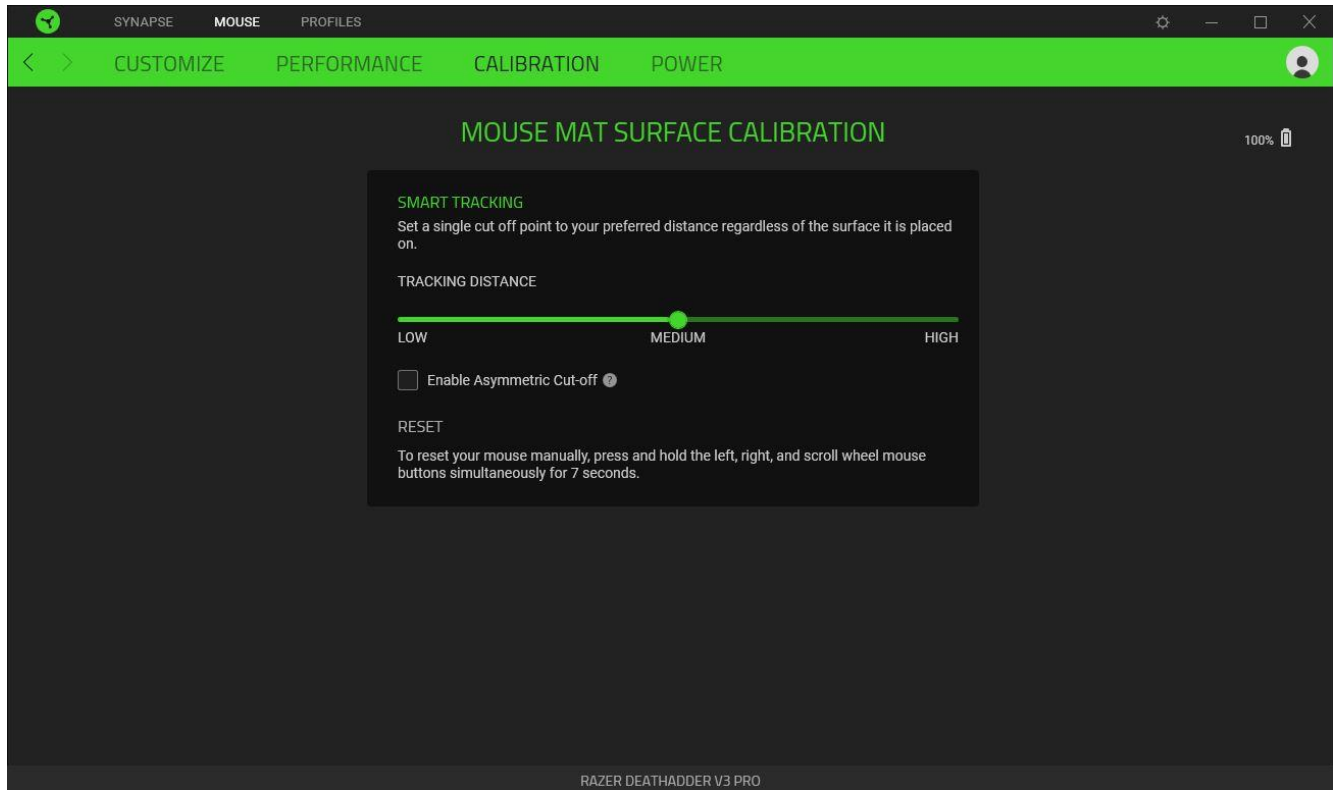

Power

The Power subtab allows you to manage your device's energy consumption when running on batteries. You can also set your device to enter sleep mode when it has been idle for a certain amount of time.

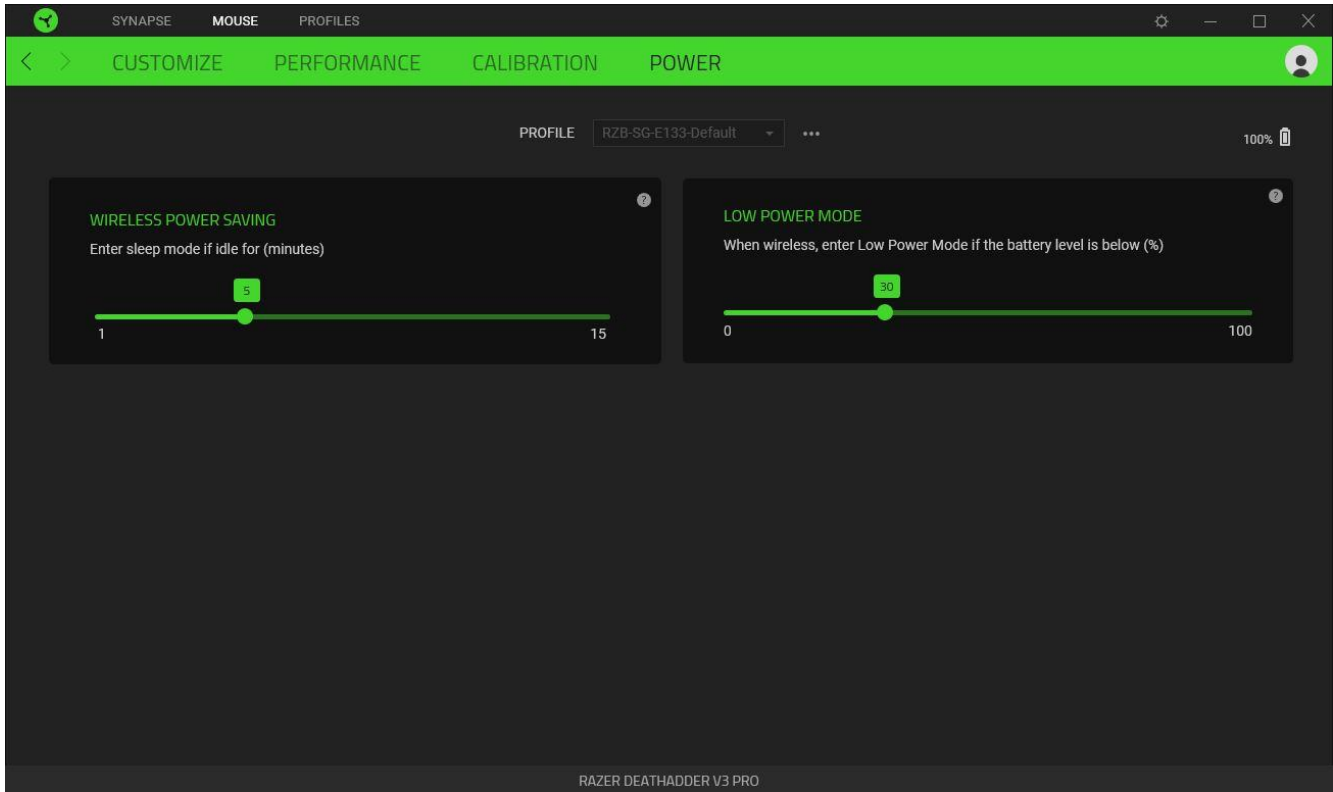

PROFILES TAB

The Profiles tab is a convenient way to manage all your profiles and link them to your games and applications.

Devices

View which games are linked to each device's profiles or which Chroma Effect is linked to specific games using the Devices subtab.

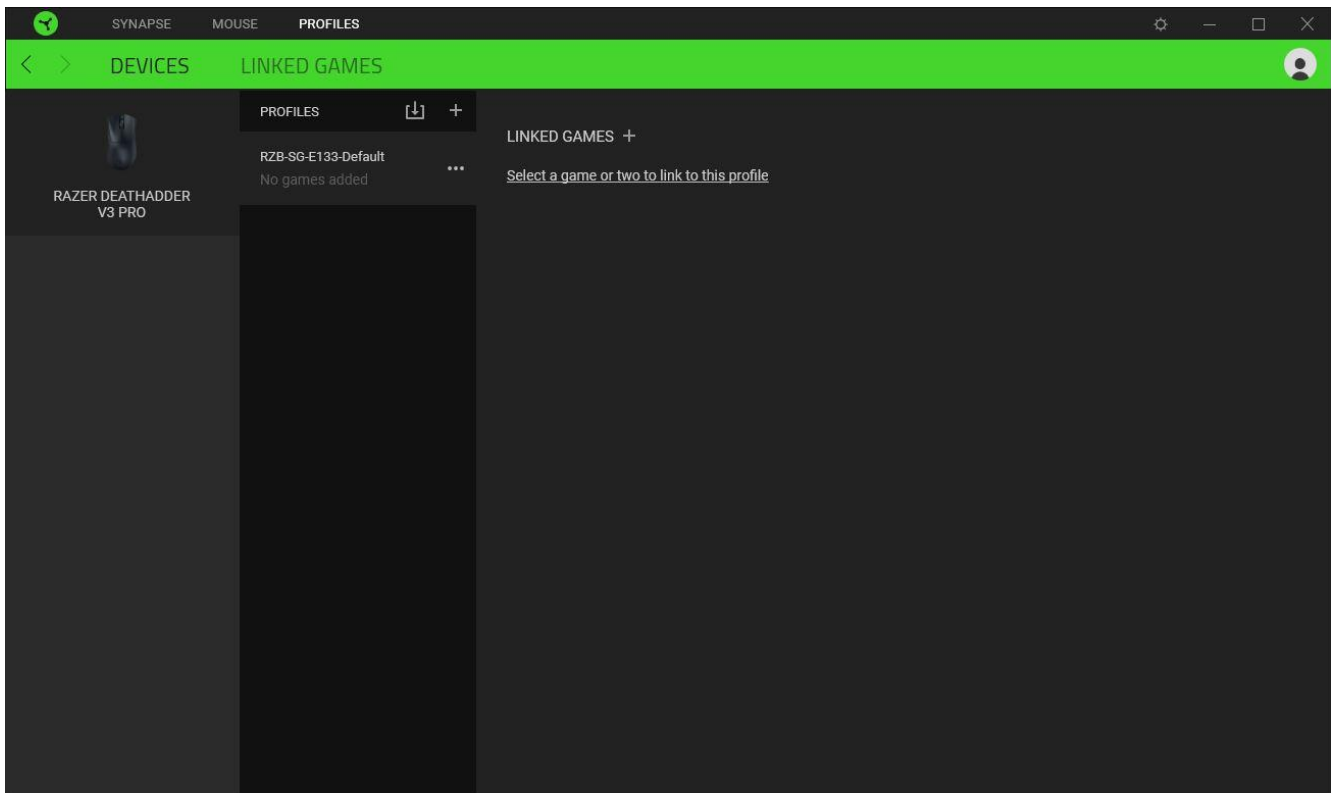

You can import Profiles from your computer or the cloud through the import button (⏏) or create new profiles within the selected device using the add button (+). To rename, duplicate, export, or delete a profile, simply press the Miscellaneous button (⋮). Each profile can be set to activate when you run an application using the Linked Games option.

Linked Games

The Linked Games subtab allows you to add games, view devices linked to games, or search for added games. You can also sort games based on alphabetical order, last played, or most played. Added games will still be listed here, even if they are not linked to a Razer device.

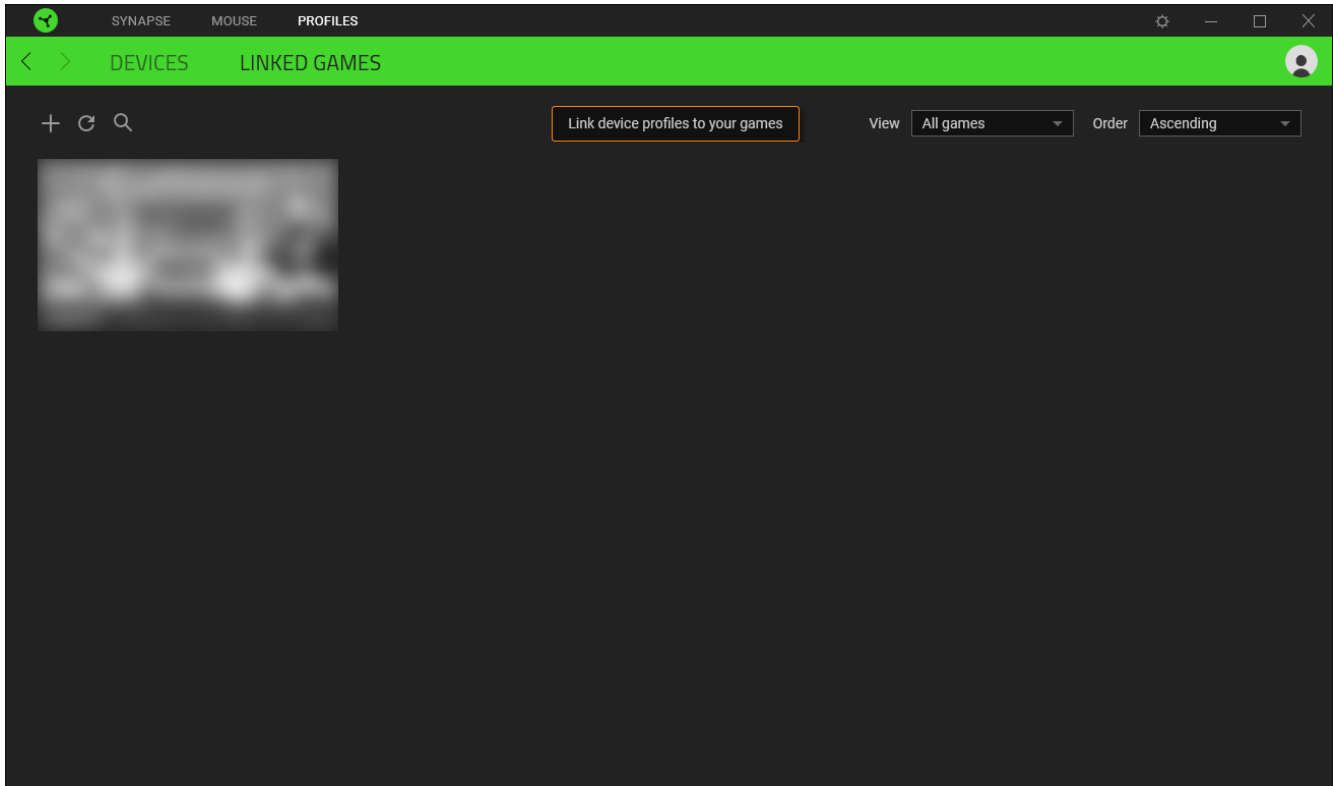

To link games to connected Razer devices or Chroma Effects, simply click on any game from the list, and then click **Select a device and its profile to launch automatically during gameplay** to select the Razer device or Chroma Effect it will link with. Once connected, you may click the Miscellaneous button (●●●) of the corresponding Chroma Effect or device to select a specific Chroma Effect or profile.

SETTINGS WINDOW

The Settings window, accessible by clicking the (⚙️) button on Razer Synapse, enables you to configure the startup behavior and display language of Razer Synapse, view the master guides of each connected Razer device, or perform a factory reset on any connected Razer device.

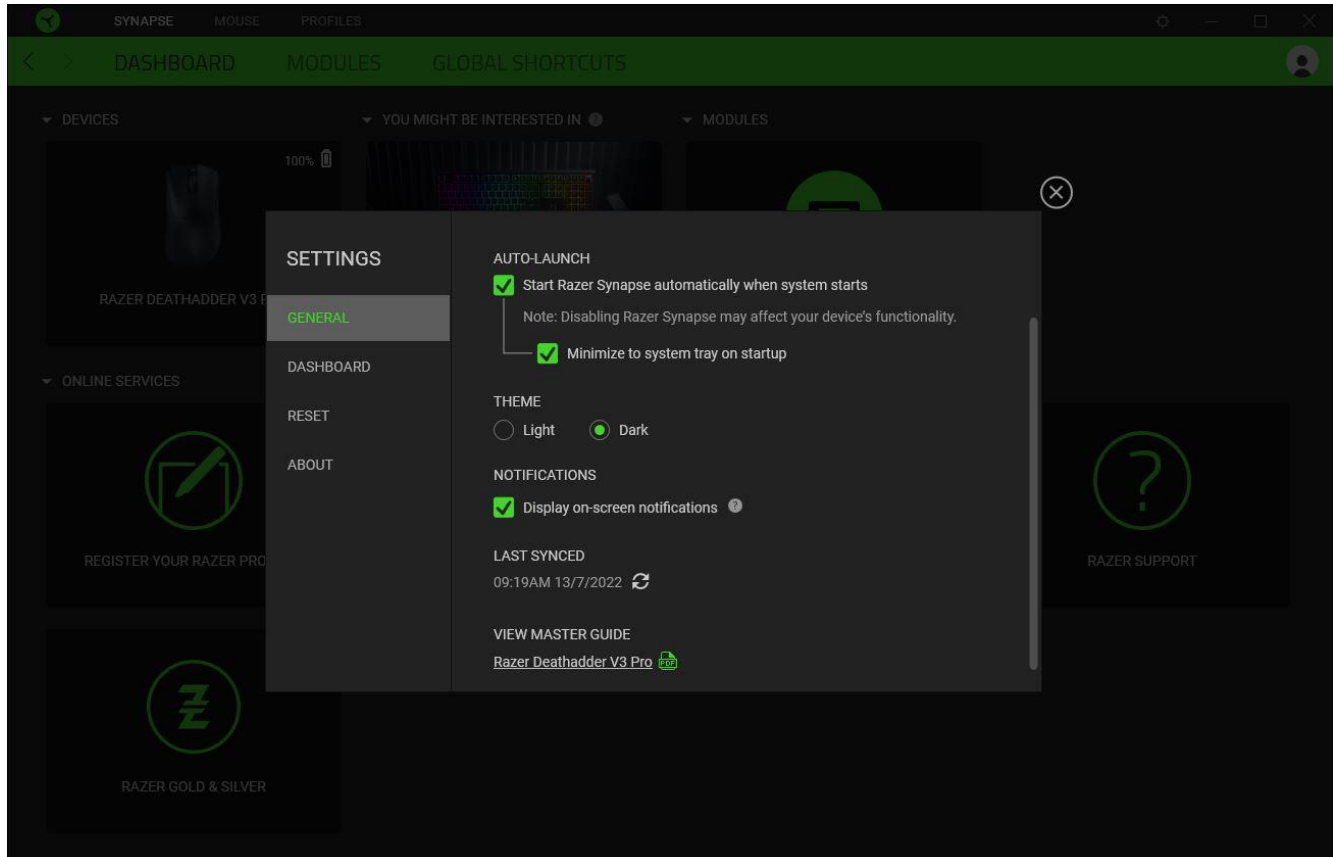

General tab

The General tab lets you change the software's display language, startup behavior, theme, and on-screen notifications display. You may also manually sync your profiles to the cloud (↻) or view the master guide of all connected Razer devices and installed modules.

Dashboard tab

Use the Dashboard tab to customize which Razer device recommendations based on your setup, and the games you play will appear on the Dashboard.

Reset tab

The Reset tab allows you to perform a factory reset on all connected Razer devices with on-board memory and/or reset Razer Synapse tutorials to acquaint yourself again with Razer Synapse's new features on its next launch.

 *All profiles stored on the selected device's on-board memory will be erased when you reset a Razer device.*

About tab

The About tab displays brief software information and copyright statement, and provides relevant links for its terms of use. You may also use this tab to check for software updates, or as quick access to Razer's social communities.

8. SAFETY AND MAINTENANCE

SAFETY GUIDELINES

To achieve maximum safety while using your Razer DeathAdder V3 Pro, we suggest that you adopt the following guidelines:

Should you have trouble operating the device properly and troubleshooting does not work, unplug the device and contact the Razer hotline or go to support.razer.com for support.

Do not take apart the device and do not attempt to operate it under abnormal current loads. Doing so will void your warranty.

The Razer DeathAdder V3 Pro requires a USB connection that can supply sufficient power to charge the device. The charging process may be affected when connecting to a non-powered USB hub or non-powered USB, mostly found on keyboards and peripherals.

Keep the device away from liquid, humidity, or moisture. Operate the device only within the specific temperature range of 0°C (32°F) to 40°C (104°F). Should the temperature exceed this range, unplug and/or switch off the device in order to let the temperature stabilize to an optimal level.

COMFORT

Research has shown that long periods of repetitive motion, improper positioning of your computer peripherals, incorrect body position, and poor habits may be associated with physical discomfort and injury to nerves, tendons, and muscles. Below are some guidelines to avoid injury and ensure optimum comfort while using your Razer DeathAdder V3 Pro.

- Position your keyboard and monitor directly in front of you with your mouse next to it. Place your elbows next to your side, not too far away, and your keyboard within easy reach.
- Adjust the height of your chair and table so that the keyboard and mouse are at or below elbow-height.
- Keep your feet well supported, posture straight, and your shoulders relaxed.
- During gameplay, relax your wrist and keep it straight. If you do the same tasks with your hands repeatedly, try not to bend, extend or twist your hands for long periods.
- Do not rest your wrists on hard surfaces for long periods. Use a wrist rest to support your wrist while gaming.
- Do not sit in the same position all day. Get up, step away from your desk and do exercises to stretch your arms, shoulders, neck, and legs.

If you experience any physical discomfort while using your mouse, such as pain, numbness, or tingling in your hands, wrists, elbows, shoulders, neck, or back, please consult a qualified medical doctor immediately.

MAINTENANCE AND USE

The Razer DeathAdder V3 Pro requires minimum maintenance to keep it in optimum condition. Once a month, we recommend you unplug the device from the computer and clean it using a soft cloth or cotton swab to prevent dirt buildup. Do not use soap or harsh cleaning agents.

To get the ultimate experience in movement and control, we highly recommend a premium mouse mat from Razer. Some surfaces will cause undue wear on the feet requiring constant care and eventual replacement.

Do note that the sensor of the Razer DeathAdder V3 Pro is 'tuned' or optimized, especially for the Razer mouse mats. This means that the sensor has been tested extensively to confirm that the Razer DeathAdder V3 Pro reads and tracks best on Razer mouse mats.

BATTERY WARNING

The Razer DeathAdder V3 Pro contains a Li-ion rechargeable battery. In general, the life expectancy of such batteries is dependent upon usage. If you suspect that the Li-ion rechargeable battery inside the Razer DeathAdder V3 Pro may be drained (has a low charge), try charging it.

Caution: Do not open, mutilate, or expose to conducting materials (metal), moisture, liquid, fire, or heat. Doing so may cause batteries to leak or explode, resulting in personal injury. Battery life varies with usage.

9. LEGALESE

COPYRIGHT AND INTELLECTUAL PROPERTY INFORMATION

©2022 Razer Inc. All rights reserved. Razer, the triple-headed snake logo, Razer logo, "For Gamers. By Gamers.", and "Razer Chroma" logo are trademarks or registered trademarks of Razer Inc. or affiliated companies in the United States and other countries. All other trademarks are the property of their respective owners.

Windows and the Windows logo are trademarks of the Microsoft group of companies.

Razer Inc. ("Razer") may have copyright, trademarks, trade secrets, patents, patent applications, or other intellectual property rights (whether registered or unregistered) concerning the product in this guide. Furnishing of this guide does not give you a license to any such copyright, trademark, patent or other intellectual property right. The Razer DeathAdder V3 Pro (the "Product") may differ from pictures whether on packaging or otherwise. Razer assumes no responsibility for such differences or for any errors that may appear. Information contained herein is subject to change without notice.

LIMITED PRODUCT WARRANTY

For the latest and current terms of the Limited Product Warranty, please visit [razer.com/warranty](https://www.razer.com/warranty).

LIMITATION OF LIABILITY

Razer shall in no event be liable for any lost profits, loss of information or data, special, incidental, indirect, punitive or consequential or incidental damages, arising in any way out of distribution of, sale of, resale of, use of, or inability to use the Product. In no event shall Razer's liability exceed the retail purchase price of the Product.

GENERAL

These terms shall be governed by and construed under the laws of the jurisdiction in which the Product was purchased. If any term herein is held to be invalid or unenforceable, then such term (in so far as it is invalid or unenforceable) shall be given no effect and deemed to be excluded without invalidating any of the remaining terms. Razer reserves the right to amend any term at any time without notice.