



Questo manuale d'istruzione è fornito da trovaprezzi.it. Scopri tutte le offerte per [Razer Nommo V2 X](#) o cerca il tuo prodotto tra le [migliori offerte di Diffusori Audio](#)



Questo manuale d'istruzione è fornito da trovaprezzi.it. Scopri tutte le offerte per [Razer Nommo V2 X](#) o cerca il tuo prodotto tra le [migliori offerte di Diffusori Audio](#)



RAZER NOMMO V2 X

MASTER GUIDE

Unleash the power of positional audio with the **Razer Nommo V2 X**—a 2.0 PC gaming speaker system that harnesses the full audio spectrum to deliver room-filling sound. Enhanced with full-range drivers and powered by THX Spatial Audio, prepare for an experience that immerses you in your entertainment.

CONTENTS

1. WHAT'S INSIDE	3
2. WHAT'S NEEDED	4
3. LET'S GET YOU COVERED.....	5
4. TECHNICAL SPECIFICATIONS	6
5. SETTING UP YOUR RAZER NOMMO V2 X.....	7
6. CONNECTING TO YOUR GAMING SPEAKERS	8
7. USING YOUR GAMING SPEAKERS.....	12
8. CONFIGURING YOUR RAZER NOMMO V2 X VIA RAZER SYNAPSE	16
9. SAFETY AND MAINTENANCE	26
10. LEGALESE.....	27

1. WHAT'S INSIDE

- Razer Nommo V2 X

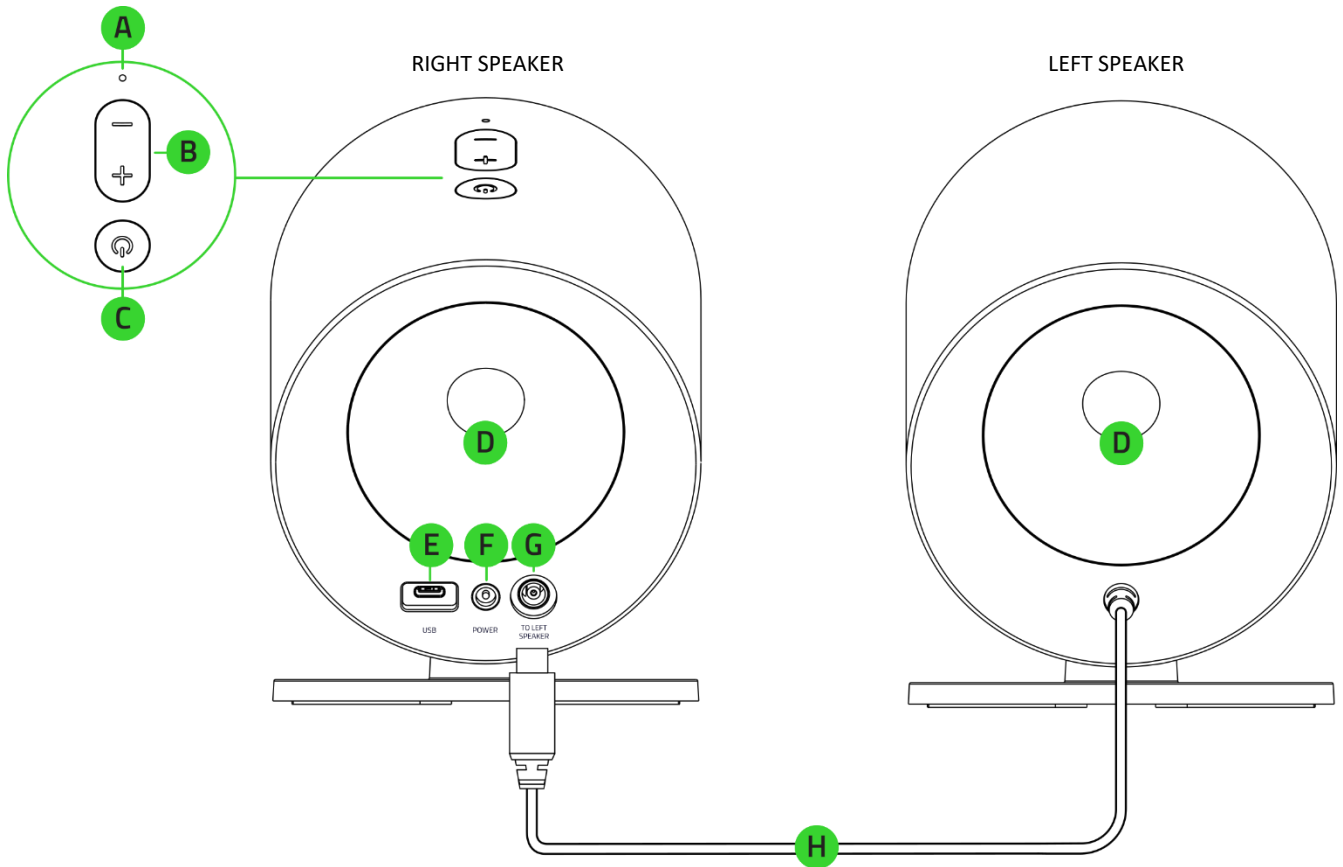

- A. Status indicator
- B. Volume control buttons
- C. Power / Multi-function button
- D. Rear-facing bass ports
- E. USB Type C port
- F. Power port
- G. Left speaker port
- H. Left speaker connector

- USB Type A to USB Type C cable

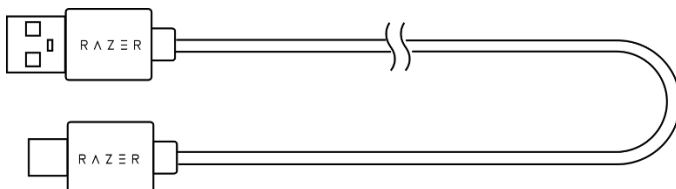

- Power adapter + regional plugs*

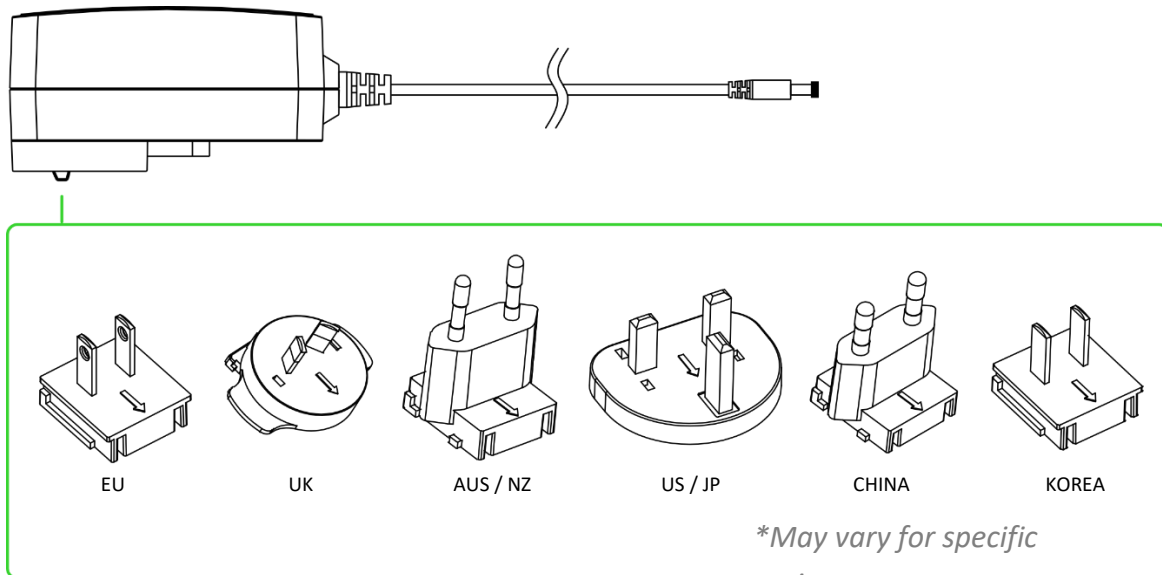

- Important Product Information Guide

2. WHAT'S NEEDED

PRODUCT REQUIREMENTS

- USB Type A port or devices with Bluetooth connectivity

RAZER SYNAPSE REQUIREMENTS

- Windows® 10 64-bit (or higher)
- Internet connection for software installation

3. LET'S GET YOU COVERED



Register your product and score exclusive benefits

razerid.razer.com/warranty

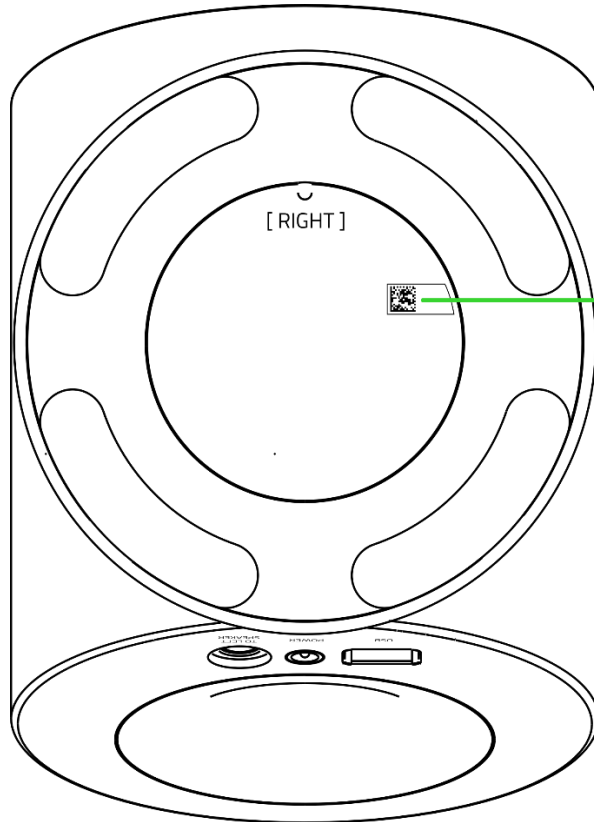

Your product's serial number can be found here.

4. TECHNICAL SPECIFICATIONS

TECHNICAL SPECIFICATIONS

- Bluetooth 5.0
- THX Spatial Audio
- USB audio input
- Customizable EQ
- Frequency response: 75 Hz – 20 kHz
- Max SPL: 96 dB at 1 meter
- Input power: External power adapter
- Driver specifications:
 - Full range drivers: 3.2" / 83 mm
 - Driver type: Full-range drivers

CONNECTIVITY

- Bluetooth connection
- USB Type C to USB Type A
- Toggle PC audio devices (supported via Razer Synapse)
- Cable lengths:
 - USB Type C to USB Type A cable: 2 m
 - Speaker cable: 2 m
 - AC power cord: 2 m

5. SETTING UP YOUR RAZER NOMMO V2 X

1. Connect the left speaker connector to the left speaker port on the right speaker.

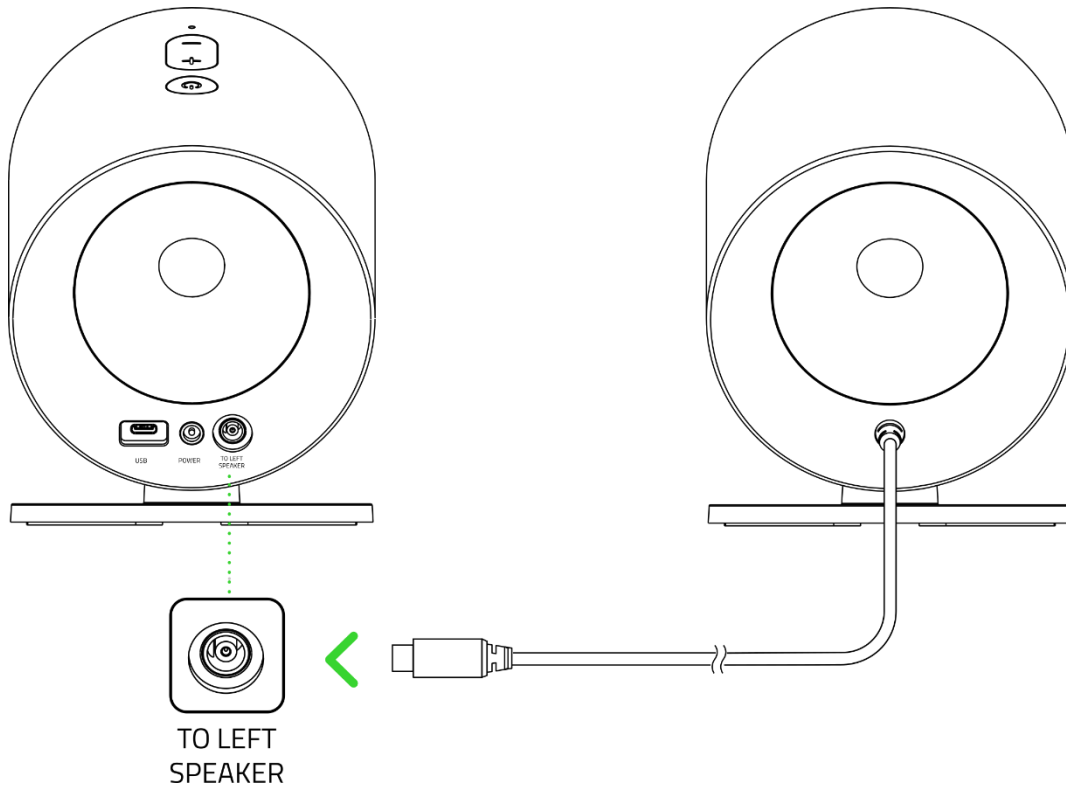

2. With the appropriate AC plug for your region attached to the power adapter, connect it to the right speaker's power port and plug it into a power outlet.

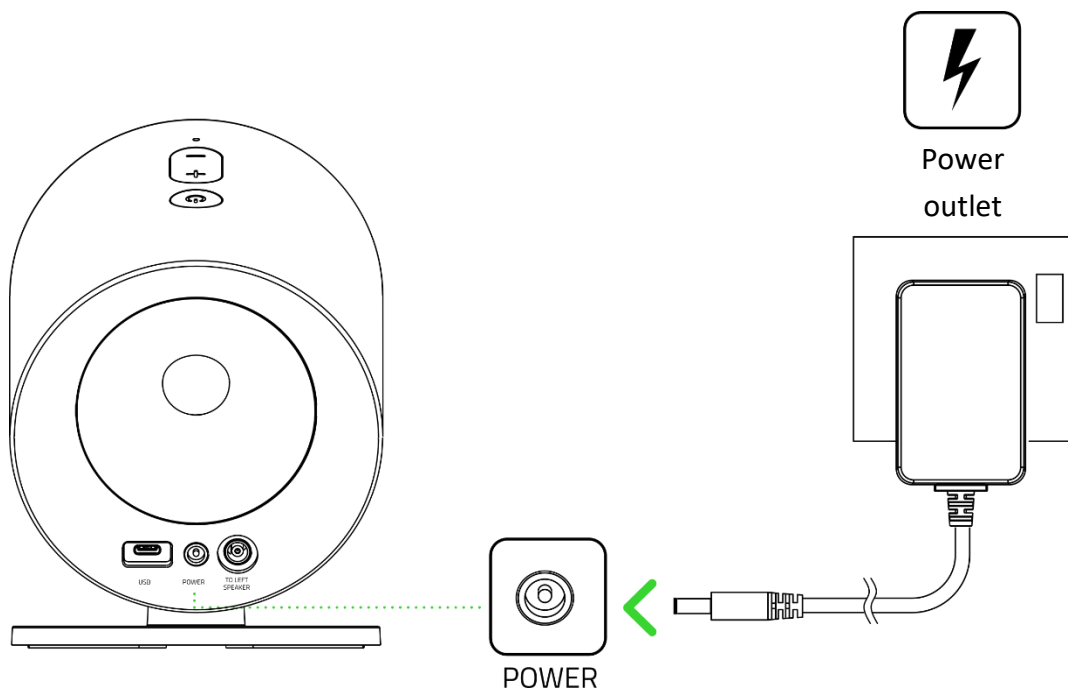

6. CONNECTING TO YOUR GAMING SPEAKERS

A. VIA PC MODE

1. Connect the gaming speakers to any of the USB Type A ports on your PC.

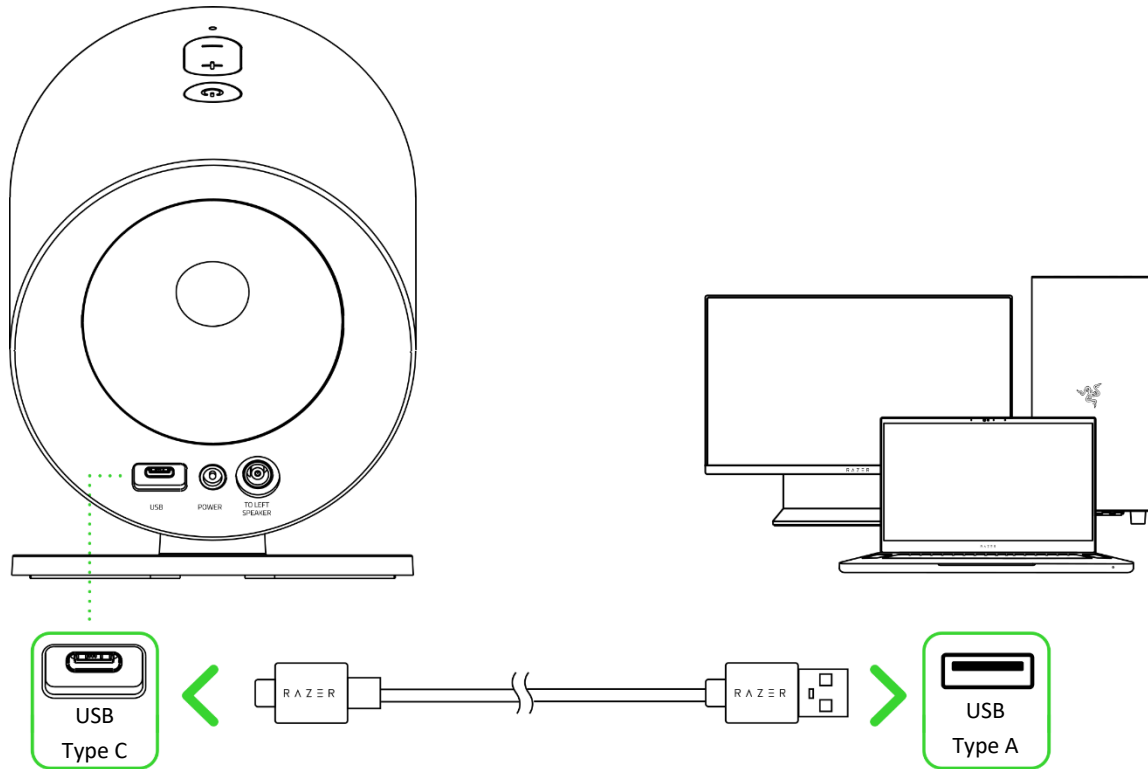

2. Press the Power / Multi-function button to power on the gaming speakers. The status indicator will turn solid green, indicating that the gaming speakers are in PC mode.

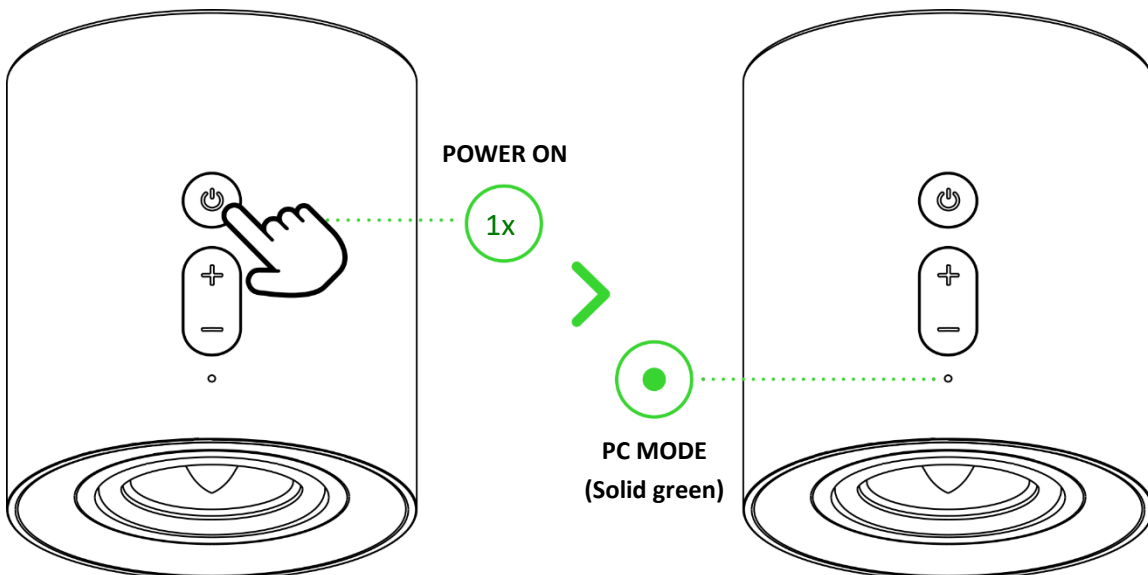

3. Set the **Razer Nommo V2 X** as the default **Output** device on your PC.

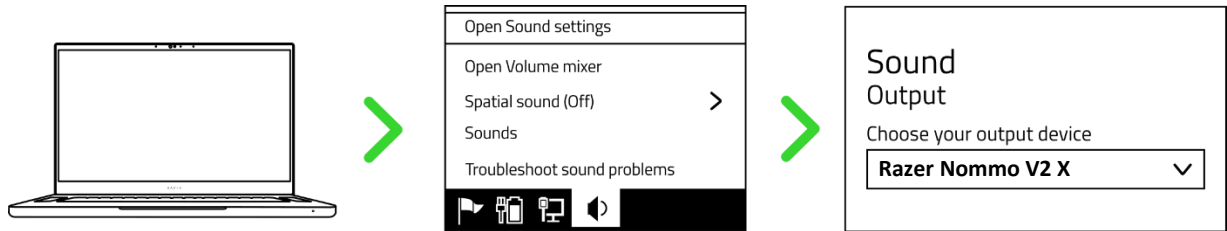

i *When using the gaming speakers with compatible devices, set the Razer Nommo V2 X as its default output device (if applicable).*

The Razer Nommo V2 X is now ready for use in PC mode.

B. VIA BLUETOOTH MODE

1. While powered on and in PC mode, double press the Power / Multi-function button to switch to Bluetooth mode. The status indicator will blink in blue, and an audio prompt will be heard to indicate that the gaming speakers are in pairing mode.

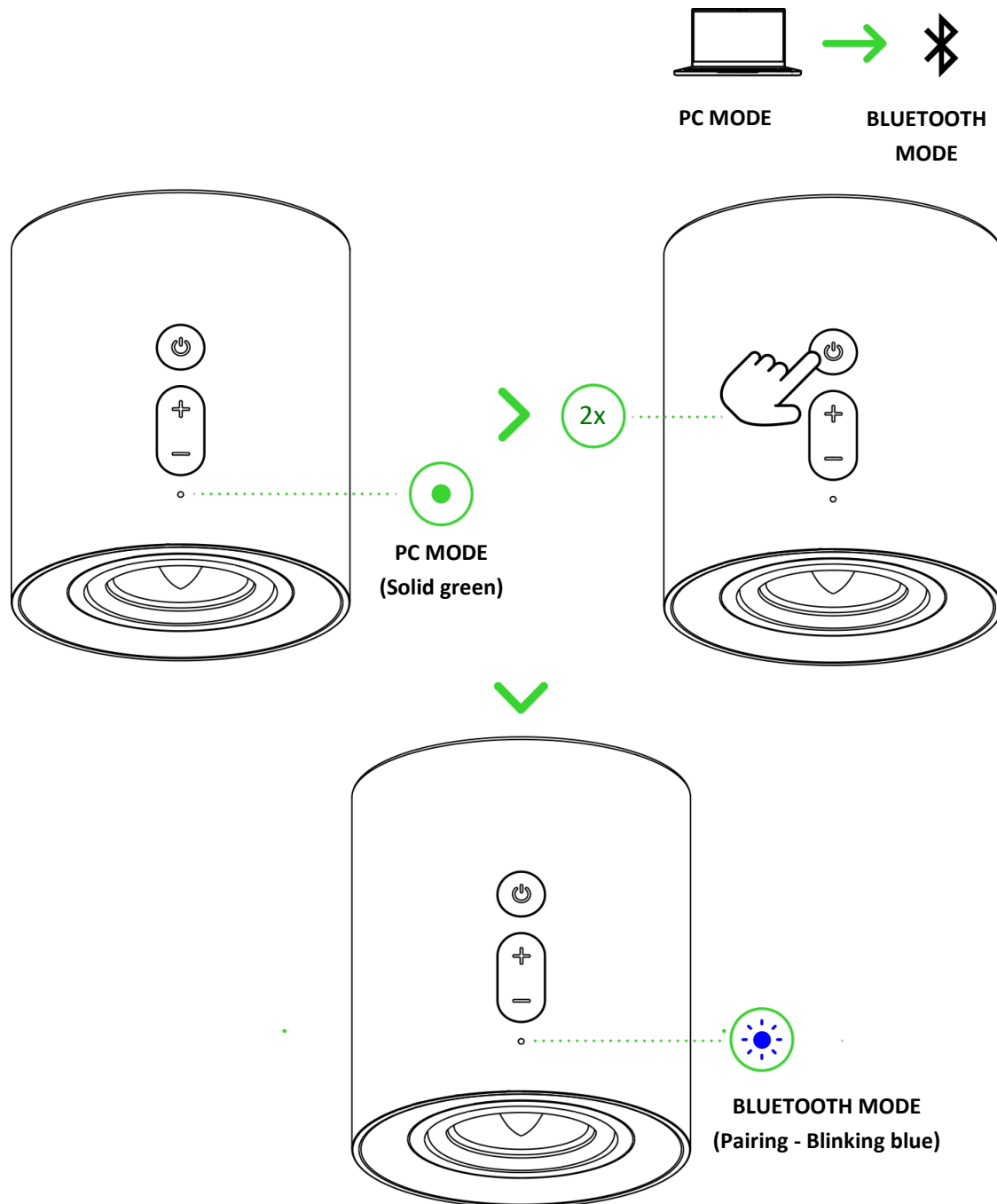

2. Activate Bluetooth on your device and select "Razer Nommo V2 X (BT)" from the list of devices found.

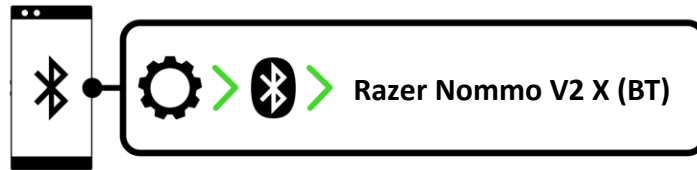

3. Wait until both devices are connected. The status indicator will turn solid blue, and an audio prompt will be heard to indicate that the gaming speakers are now connected to your device.

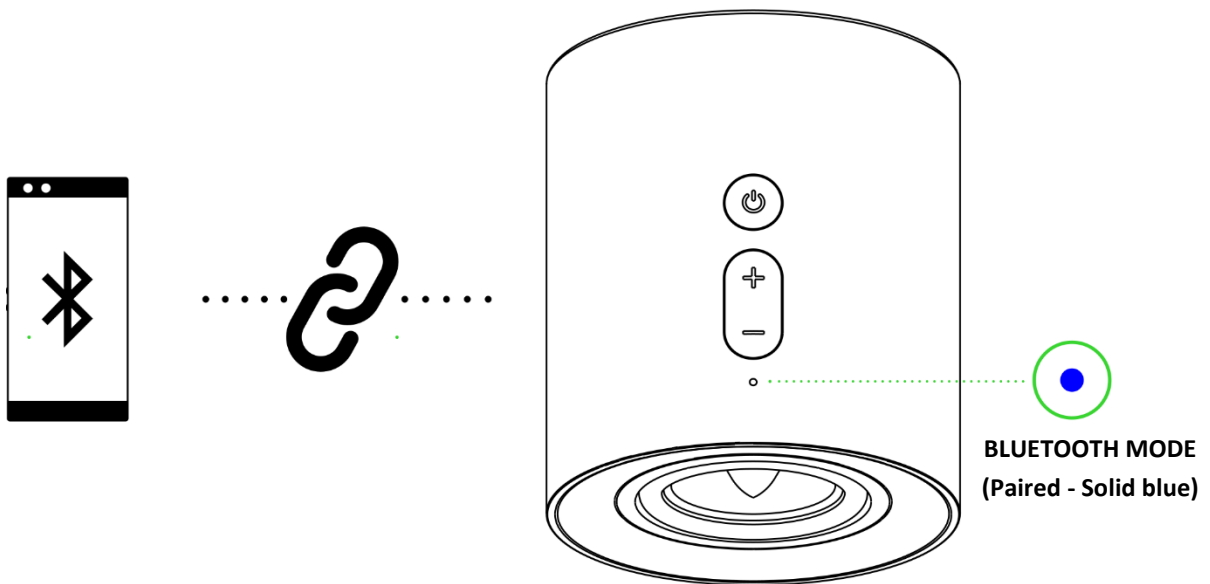

! *Instructions are for first-time pairing only. Remember to keep the gaming speakers within 1 meter of your mobile device when connecting to the gaming speakers. Once paired, the gaming speakers will automatically reconnect to your mobile device whenever you switch to Bluetooth mode. [Learn more about switching between audio sources](#)*

The Razer Nommo V2 X is now ready for use in Bluetooth mode.

7. USING YOUR GAMING SPEAKERS

POWER ON / OFF

Press the Power / Multi-function button to power on or off the gaming speakers. A tone will be heard when you power on or off the gaming speakers.

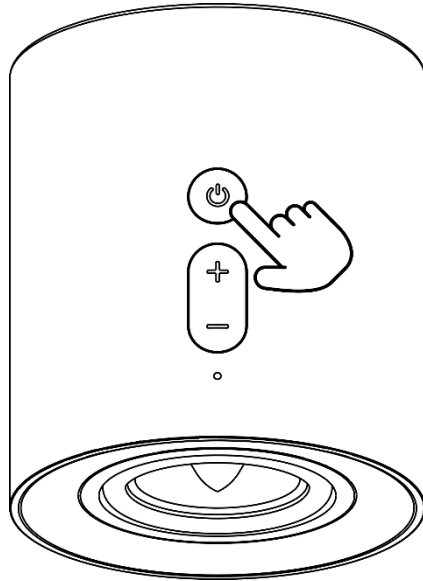

ADJUSTING THE VOLUME

Press the volume control buttons to adjust the volume of the current audio mode. The status indicator will briefly light up in white as you increase or decrease its volume.

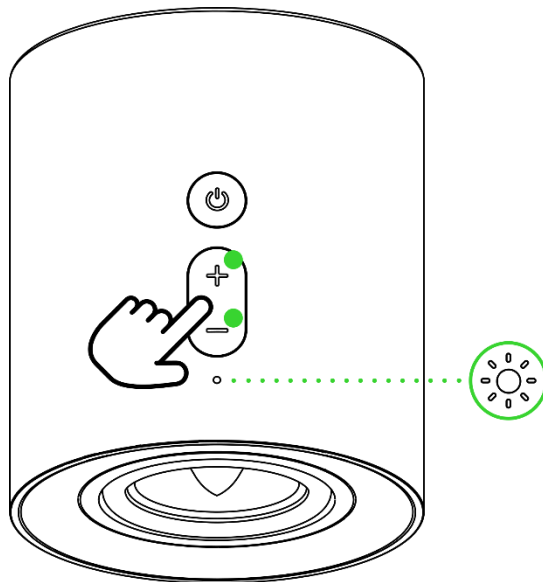

i The status indicator will continuously blink in white when the gaming speakers' are set to minimum or maximum volume.

SWITCHING BETWEEN AUDIO SOURCES

While powered on, double press the Power / Multi-function button to switch between PC mode and Bluetooth mode.

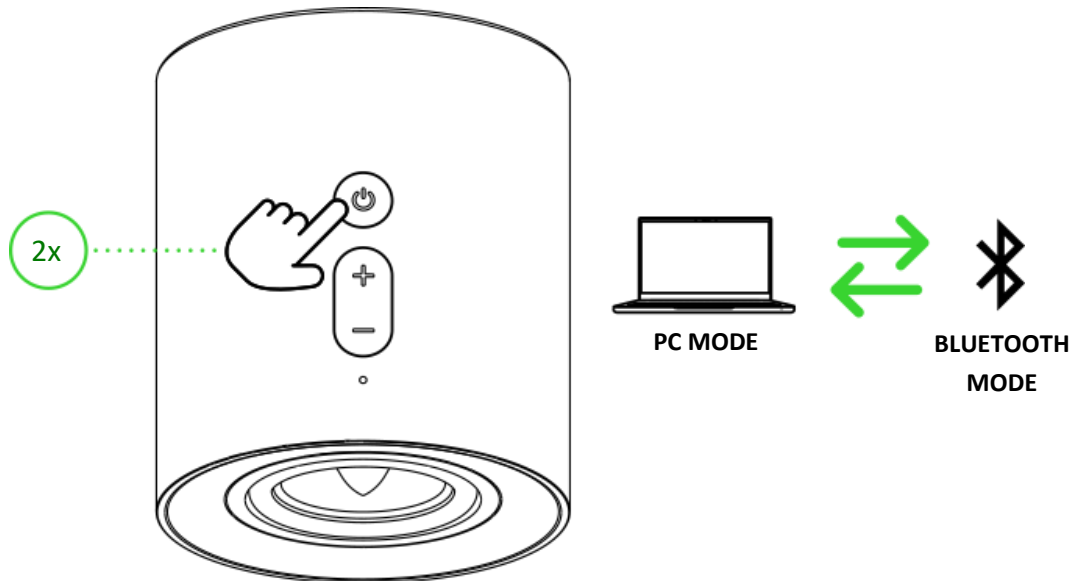

TOGGLING BETWEEN PC AUDIO DEVICES

While powered on and in PC mode, press both Volume control buttons (- and +) simultaneously to switch between the gaming speakers and a selected secondary PC playback device on Razer Synapse. The status indicator will briefly blink in yellow to indicate that the gaming speakers toggled to a secondary PC playback device and vice versa. [Learn more about PC audio device toggling](#)

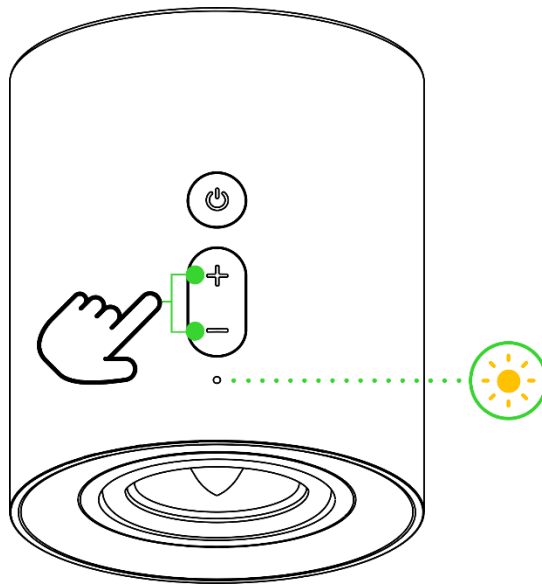

REACTIVATING BLUETOOTH PAIRING MODE (FOR NEW DEVICES)

1. While in Bluetooth mode, press and hold the Power / Multi-function button for 4 seconds to activate pairing mode. The status indicator will blink in blue, and an audio prompt will be heard to indicate that the gaming speakers are in pairing mode.

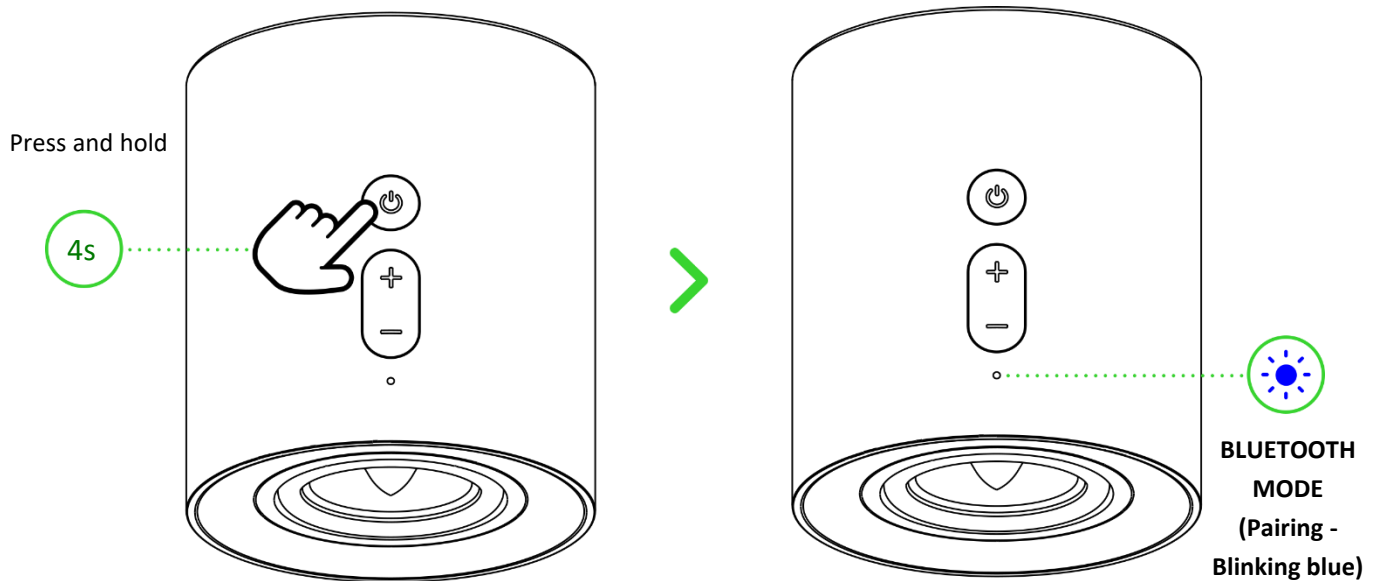

i Bluetooth pairing mode can only be activated from Bluetooth mode.

2. Activate Bluetooth on your device and select "**Razer Nommo V2 X (BT)**" from the list of devices found.

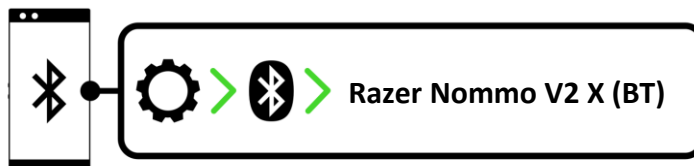

3. Wait until both devices are connected. The status indicator will turn solid blue, and an audio prompt will be heard to indicate that the gaming speakers are now connected to your device.

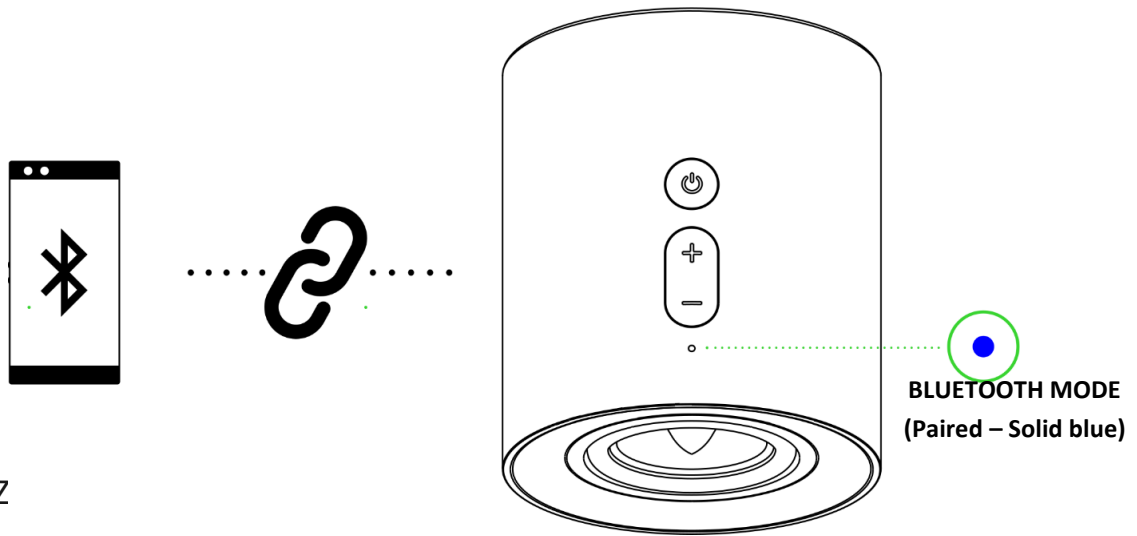

PERSONALIZ

Razer Synapse (PC)

Use the Razer Synapse app to tweak your speakers' audio settings to best suit your entertainment needs.

i *Install Razer Synapse when prompted, or download the installer from [razer.com/synapse](https://www.razer.com/synapse)*

THX® Spatial Audio (PC)

Unleash the full potential of the Razer Nommo V2 X by enabling 360° positional audio for a natural and lifelike experience through Razer Synapse.



**BLUETOOTH MODE
(Paired - Solid blue)**

**Only available on Windows® 10 64-bit (or higher).*

8. CONFIGURING YOUR RAZER NOMMO V2 X VIA RAZER SYNAPSE

i *Internet connection is required for installation, updates, and cloud-based features. Registering for a Razer ID account is recommended but optional. All listed features are subject to change based on the current software version, the connected device(s), and supported apps and software.*

SYNAPSE TAB

The Synapse tab is your default tab when you first launch Razer Synapse. This tab allows you to navigate the Dashboard subtab.

Dashboard

The Dashboard subtab is an overview of your Razer Synapse, where you can access all your Razer devices, modules, and online services.

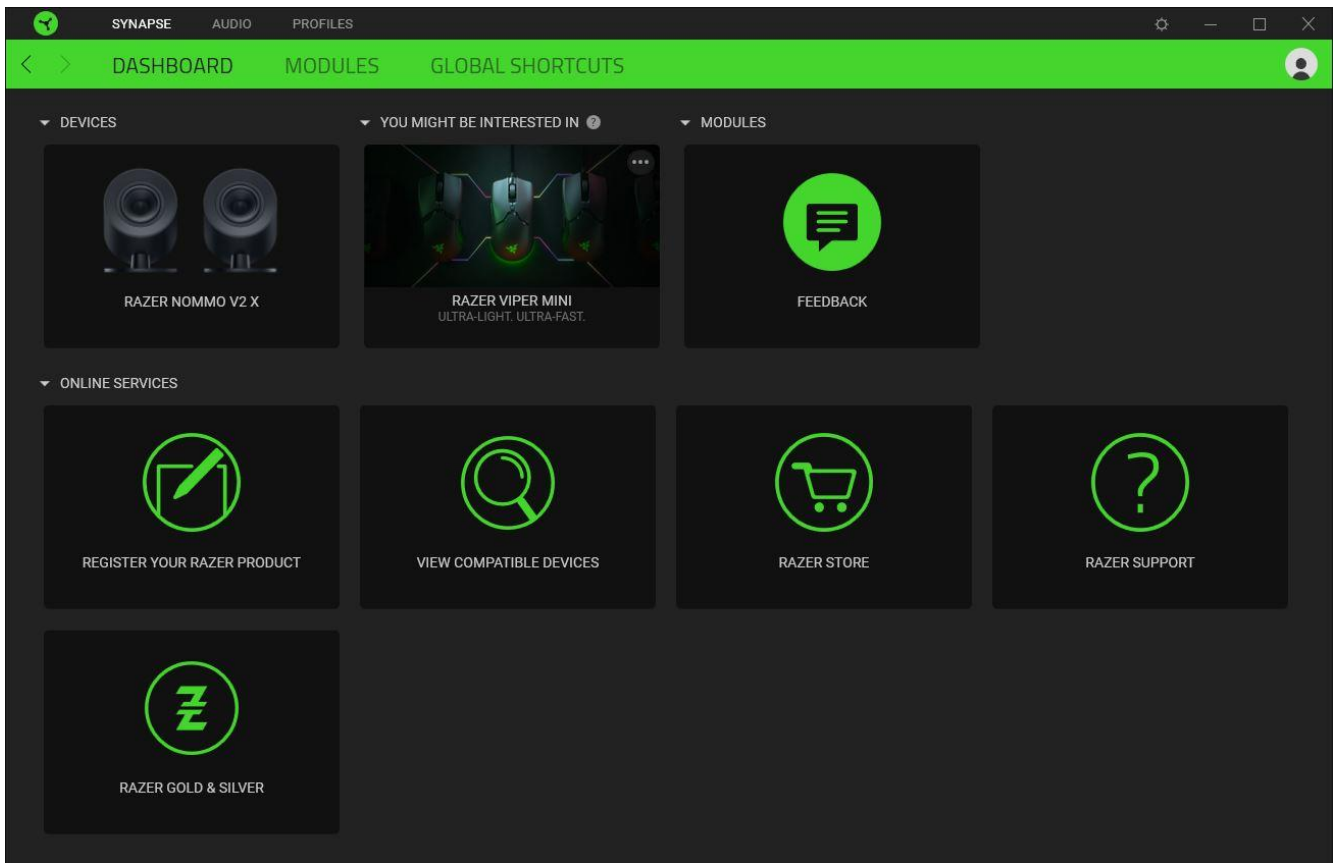

Modules

The Modules subtab displays all installed and available modules for installation.

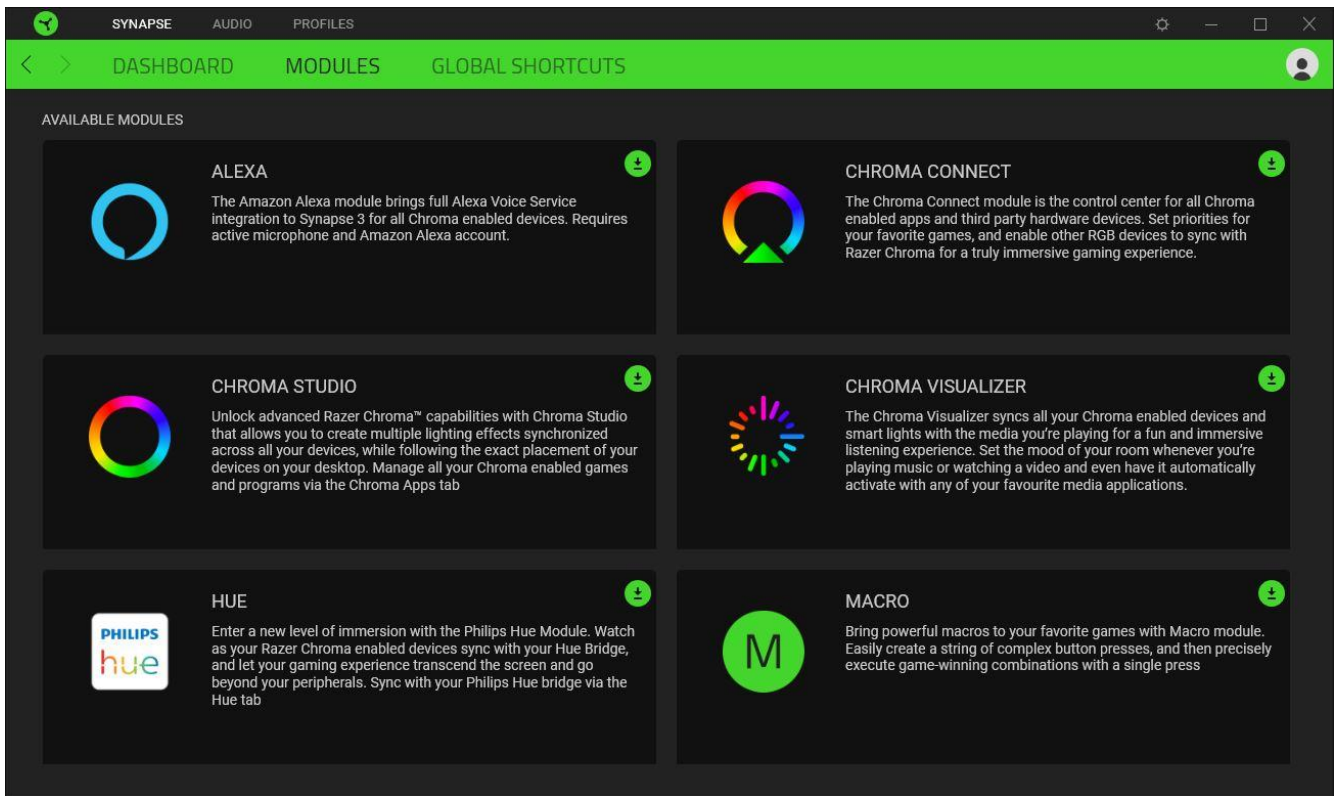

Global Shortcuts

Bind operations or Razer Synapse functions to custom key-combinations from any Razer Synapse-enabled device inputs, which apply across all device profiles. [Learn more about Profiles](#)

 *Only Razer Synapse-enabled device inputs will be recognized.*

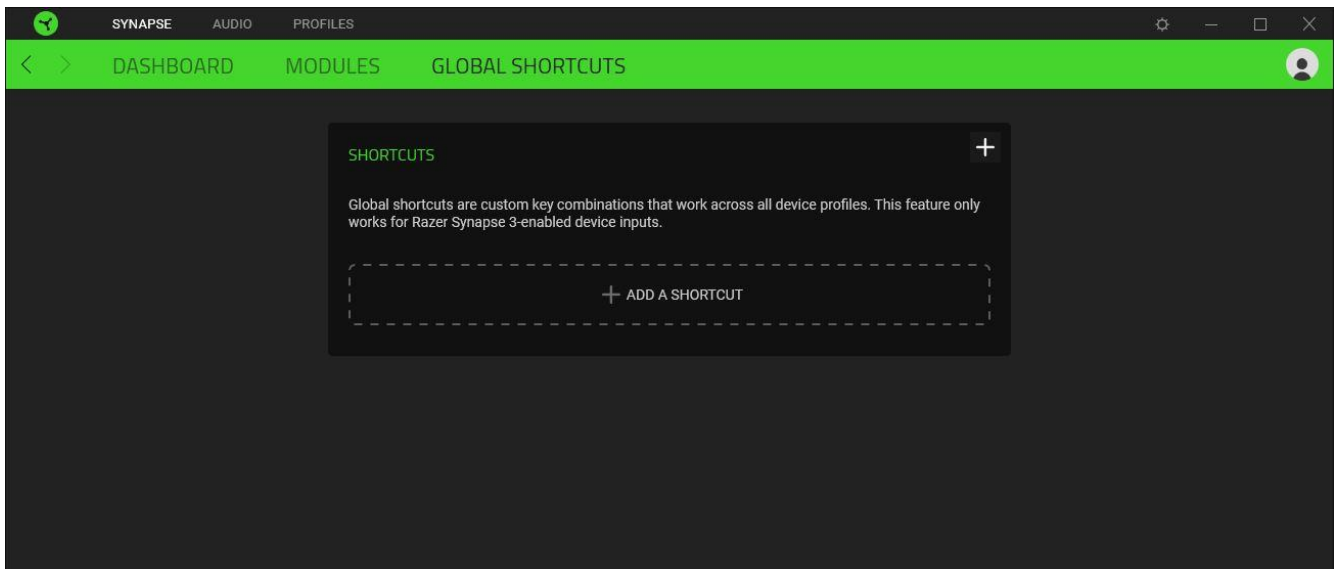

AUDIO TAB

The Audio tab is the main tab for your Razer Nommo V2 X, where you can customize your gaming speakers' settings to unleash their full potential. Changes made under this tab are automatically saved to your system and cloud storage.

Sound

The Sound subtab is for switching between Stereo audio and THX Spatial Audio, adjusting the gaming speakers' volume, setting a secondary playback device, switching to Bluetooth audio source, and changing its audio equalizer using presets or your own setting.

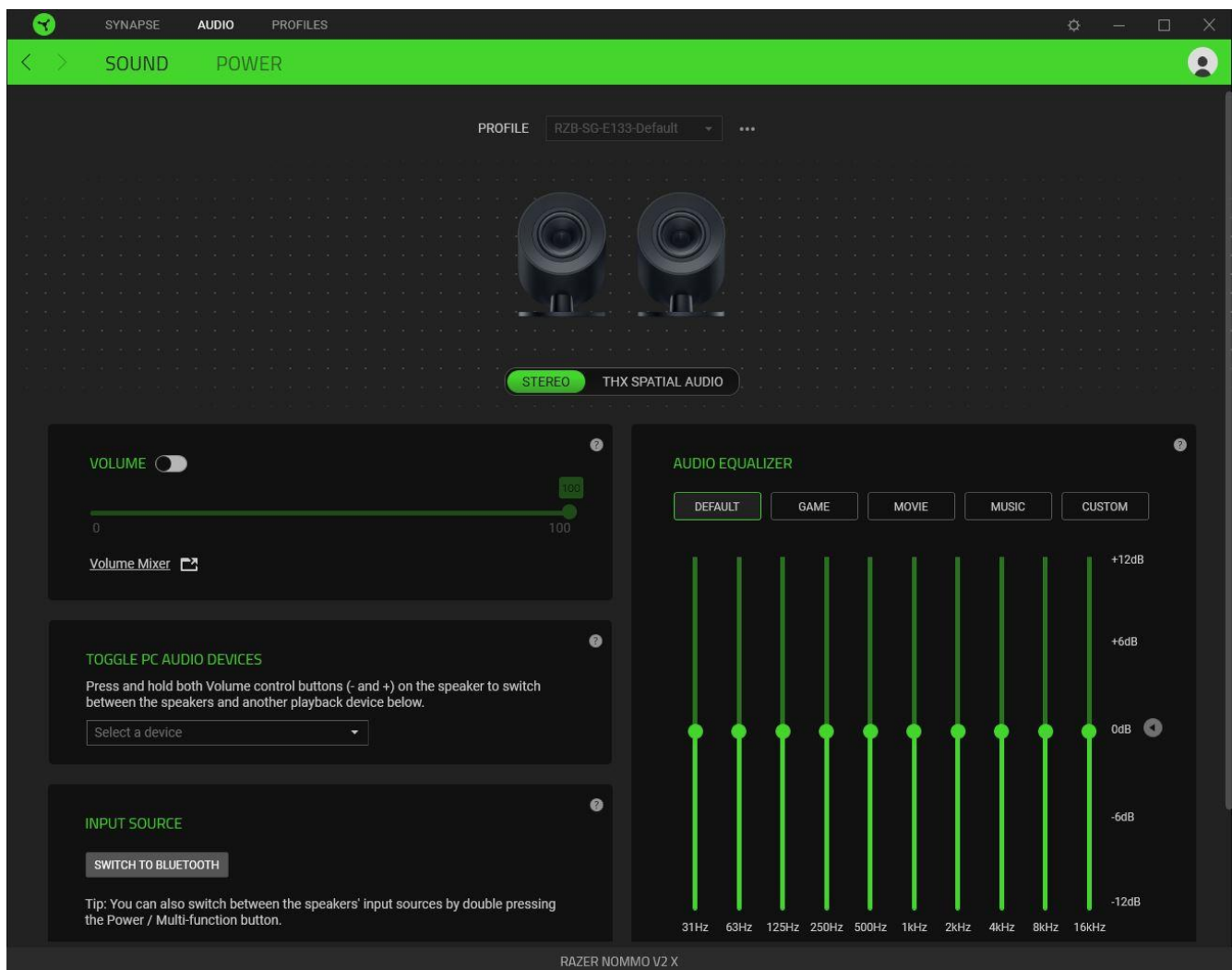

Profile

A Profile is a data storage for keeping all your Razer peripherals' settings. By default, the profile name is based on your system's name. To add, rename, duplicate, or delete a profile, simply press the Miscellaneous button (●●●).

Stereo / THX Spatial Audio

Toggle between Stereo audio and THX Spatial Audio.

Volume

Adjust the audio volume of the gaming speakers. You may also access the Windows volume mixer of the current playback device, where you can proportionally adjust the overall volume of the system or individually adjust the volume of each active application.

Toggle PC audio devices

Set a secondary PC playback device that you can immediately switch to upon pressing both Volume control buttons (- and +) simultaneously.

Input source

Allows you to switch the gaming speakers to Bluetooth mode using Razer Synapse.

 *Razer Synapse won't be able to revert to PC mode when the gaming speakers have been set to Bluetooth mode. To set the gaming speakers to PC mode, double press the Power / Multi-function button.*

Audio equalizer

Select any available equalizer preset created for the best audio experience designed for balance, gaming immersion, movie viewing, or enjoying your favorite music. Manually adjusting any equalizer preset will automatically set it to Custom.

Sound Properties

Launches the Windows Sound Properties window where you can manage your system's sound settings, such as modifying the playback and recording device settings, sound scheme, and default communications activity.

Power

Use the Power subtab to enable the gaming speakers to enter standby mode when left idle for a certain period.

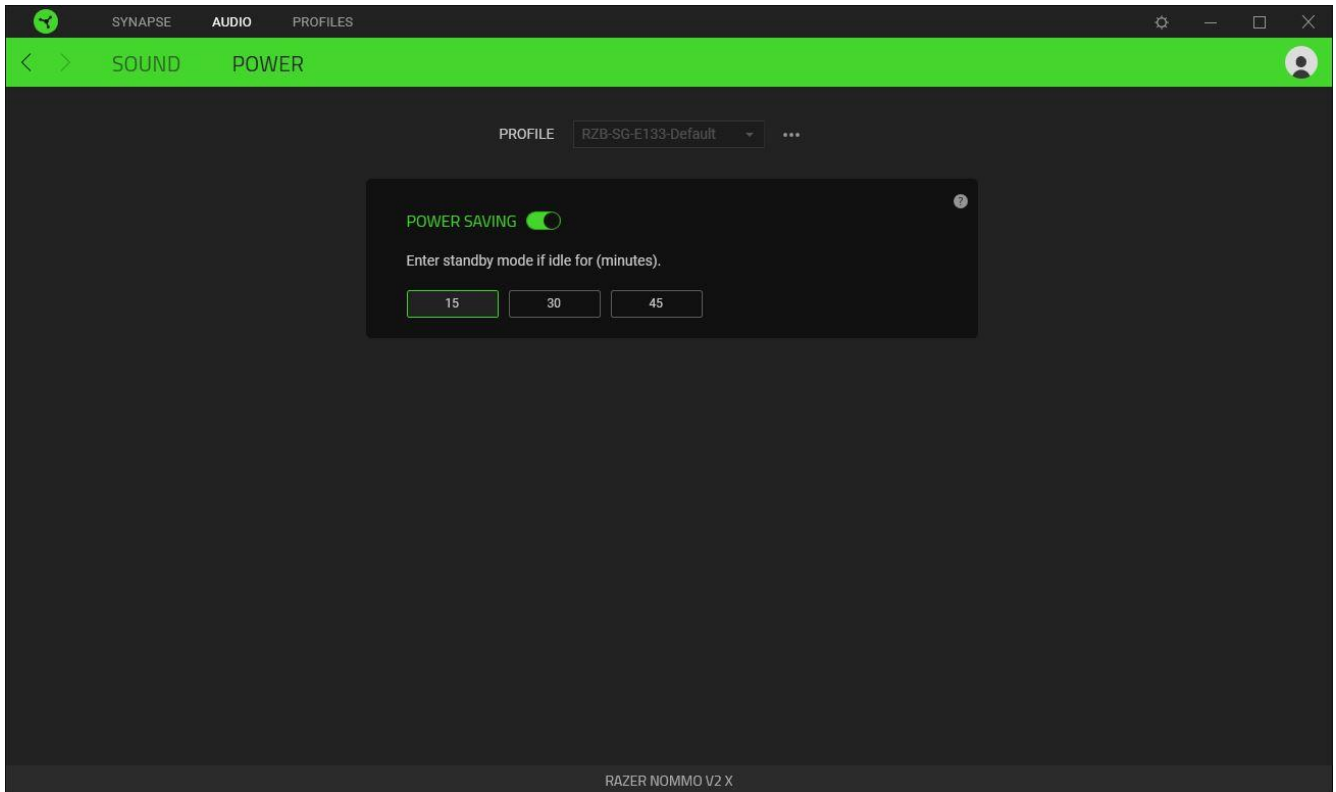





PROFILES TAB

The Profiles tab is a convenient way to manage all your profiles and link them to your games and applications.

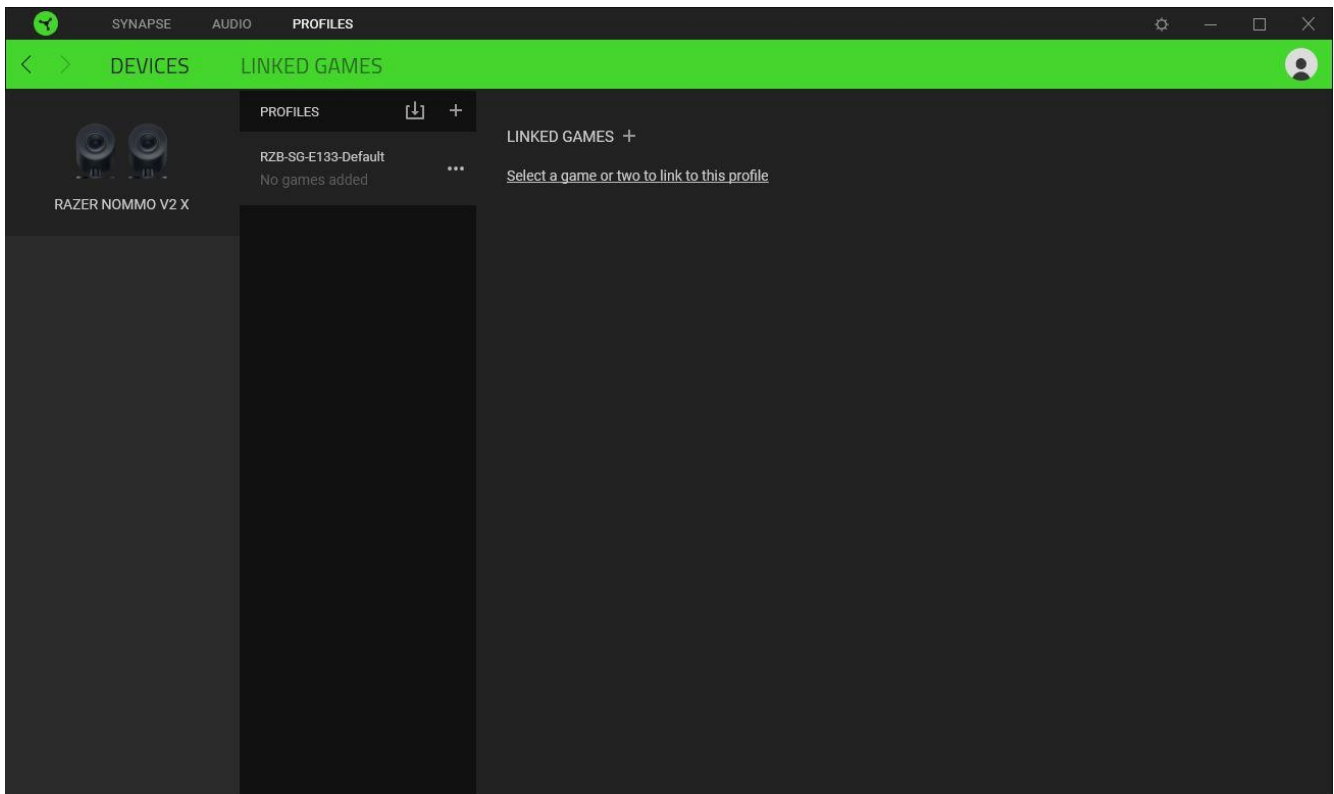
Devices

View which games are linked to each device's profiles or which Chroma Effect is linked to specific games using the Devices subtab.



You can import Profiles from your computer or the cloud through the import button () or create new profiles within the selected device using the add button (). To rename, duplicate, export, or delete a profile, simply press the Miscellaneous button (). Each profile can be set to activate when you run an application using the Linked Games option.

Linked Games

The Linked Games subtab allows you to add games, view devices linked to games, or search for added games. You can also sort games based on alphabetical order, last played, or most played. Added games will still be listed here, even if they are not linked to a Razer device.

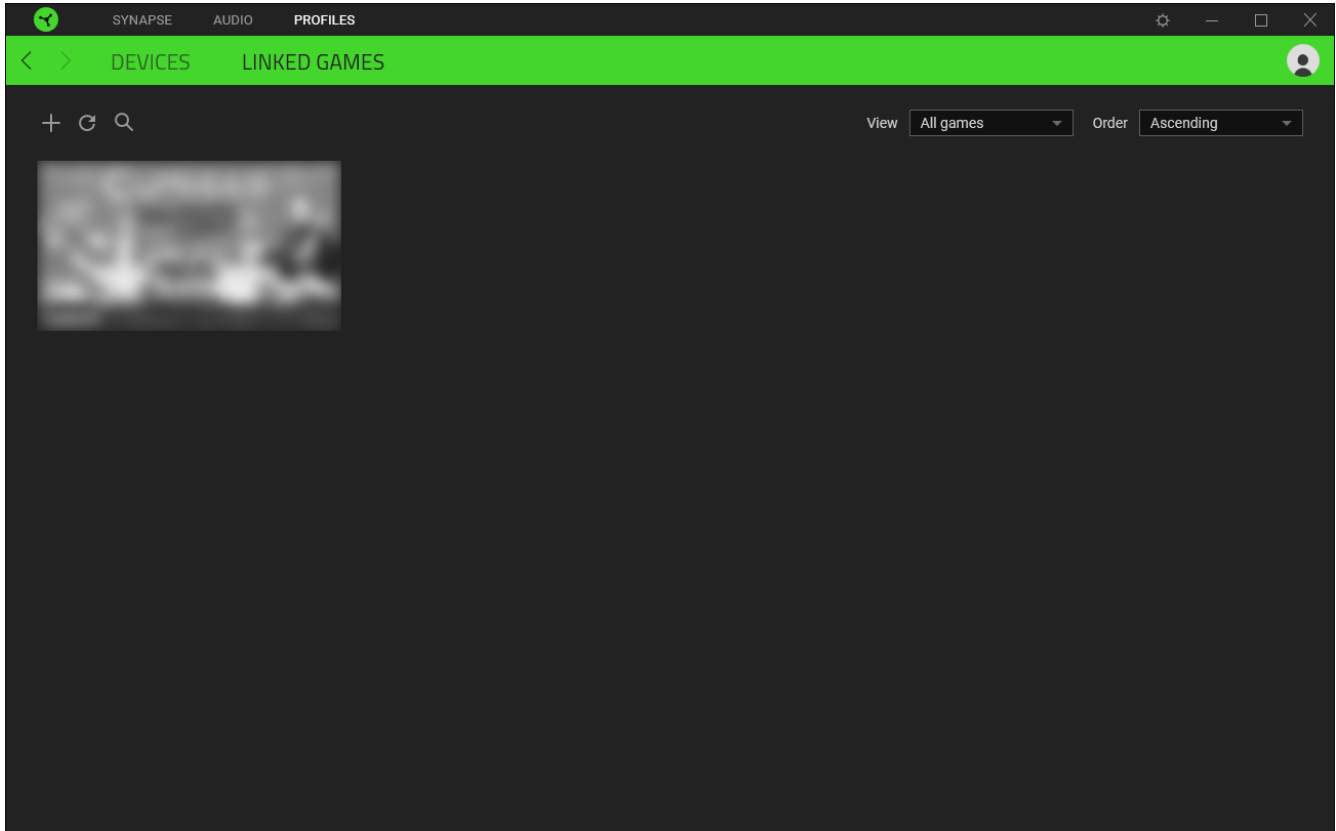

To link games to connected Razer devices or Chroma Effects, simply click on any game from the list, and then click **Select a device and its profile to launch automatically during gameplay** to select the Razer device or Chroma Effect it will link with. Once connected, you may click the Miscellaneous button (●●●) of the corresponding Chroma Effect or device to select a specific Chroma Effect or profile.

SETTINGS WINDOW

The Settings window, accessible by clicking the (⚙) button on Razer Synapse, enables you to configure the startup behavior and display language of Razer Synapse, view the master guides of each connected Razer device, or perform a factory reset on any connected Razer device.

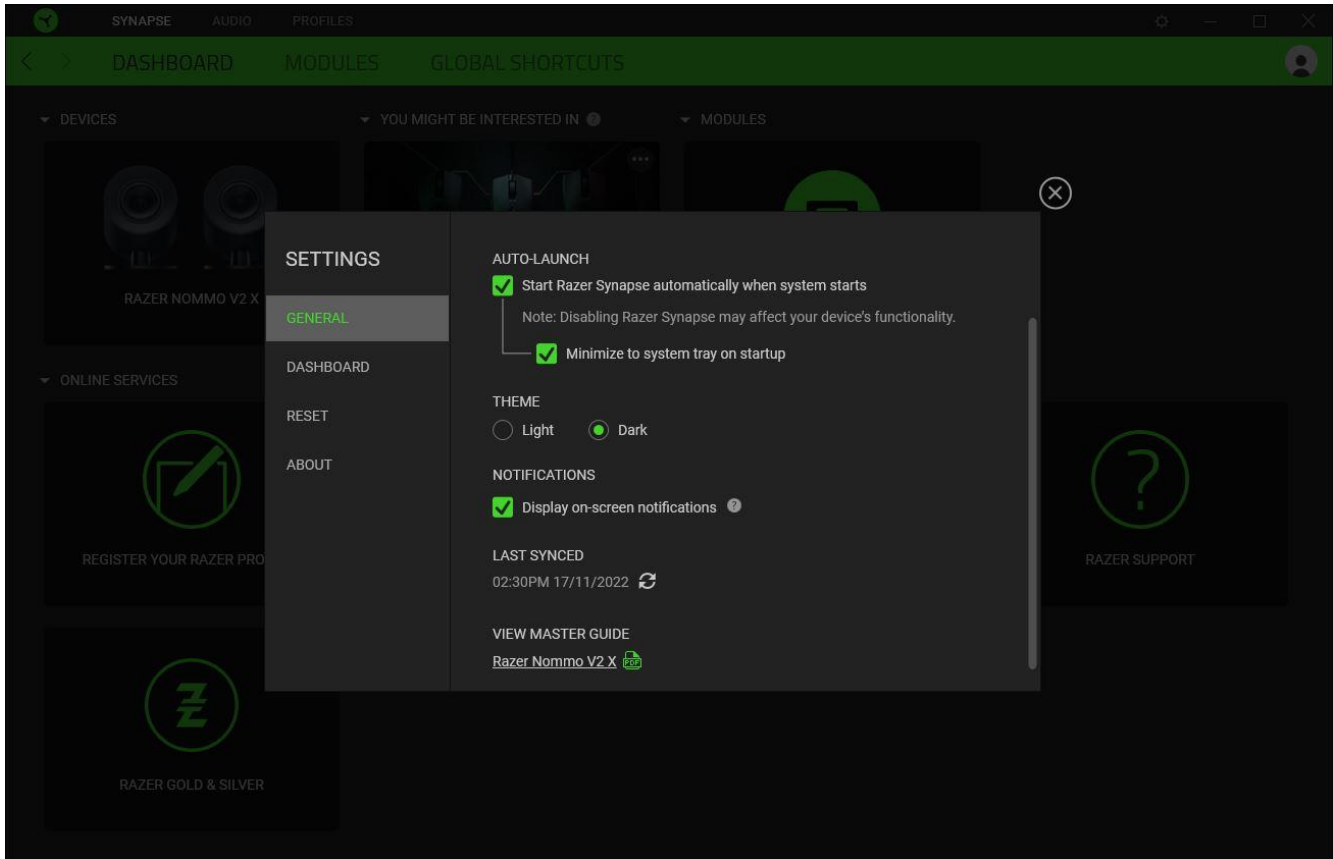

General tab

The General tab lets you change the software's display language, startup behavior, theme, and on-screen notifications display. You may also manually sync your profiles to the cloud (↻) or view the master guide of all connected Razer devices and installed modules.

Dashboard tab

Use the Dashboard tab to customize which Razer device recommendations based on your setup, and the games you play will appear on the Dashboard.

Reset tab

The Reset tab allows you to perform a factory reset on all connected Razer devices with on-board memory and/or reset Razer Synapse tutorials to acquaint yourself again with Razer Synapse's new features on its next launch.



All profiles stored on the selected device's on-board memory will be erased when you reset a Razer device.

About tab

The About tab displays brief software information and copyright statement, and provides relevant links for its terms of use. You may also use this tab to check for software updates, or as quick access to Razer's social communities.

9. SAFETY AND MAINTENANCE

SAFETY GUIDELINES

To achieve maximum safety while using your Razer Nommo V2 X, we suggest that you adopt the following guidelines:

Should you have trouble operating the device properly and troubleshooting does not work, unplug the device and contact the Razer hotline or go to support.razer.com for assistance.

Don't take apart the device, and don't attempt to operate it under abnormal current loads. Doing so will void your warranty.

Keep the device away from liquid, humidity, or moisture. Operate the device only within the specific temperature range of 0°C (32°F) to 40°C (104°F). Should the temperature exceed this range, unplug and/or switch off the device to stabilize the temperature to an optimal level.

Listening to excessively loud volumes over extended periods can damage your hearing. Furthermore, legislation of certain countries permits a maximum sound level of 86db to affect your hearing for 8 hours a day. We, therefore, recommend that you reduce the volume to a comfortable level when listening for prolonged periods. Please, take good care of your hearing.

MAINTENANCE AND USE

The Razer Nommo V2 X requires minimum maintenance to keep it in optimum condition. Once a month, we recommend you clean each speaker using a soft cloth or cotton swab to prevent dirt buildup. Don't use soap or harsh cleaning agents.

10. LEGALESE

COPYRIGHT AND INTELLECTUAL PROPERTY INFORMATION

©2023 Razer Inc. All rights reserved. Razer, the triple-headed snake logo, Razer logo, "For Gamers. By Gamers.", and "Razer Chroma" logo are trademarks or registered trademarks of Razer Inc. or affiliated companies in the United States and other countries. All other trademarks are the property of their respective owners.

The Bluetooth® word mark and logos are registered trademarks owned by Bluetooth SIG, Inc., and any use of such marks by Razer is under license.

Windows and the Windows logo are trademarks of the Microsoft group of companies.

Razer Inc. ("Razer") may have copyright, trademarks, trade secrets, patents, patent applications, or other intellectual property rights (whether registered or unregistered) concerning the Product in this guide. Furnishing of this guide does not give you a license to any such copyright, trademark, patent or other intellectual property right. The Razer Nommo V2 X (the "Product") may differ from pictures whether on packaging or otherwise. Razer assumes no responsibility for such differences or for any errors that may appear. Information contained herein is subject to change without notice.

LIMITED PRODUCT WARRANTY

For the latest and current terms of the Limited Product Warranty, please visit [razer.com/warranty](https://www.razer.com/warranty).

LIMITATION OF LIABILITY

Razer shall in no event be liable for any lost profits, loss of information or data, special, incidental, indirect, punitive or consequential or incidental damages, arising in any way out of distribution of, sale of, resale of, use of, or inability to use the Product. In no event shall Razer's liability exceed the retail purchase price of the Product.

GENERAL

These terms shall be governed by and construed under the laws of the jurisdiction in which the Product was purchased. If any term herein is held to be invalid or unenforceable, then such term (in so far as it is invalid or unenforceable) shall be given no effect and deemed to be excluded without invalidating any of the remaining terms. Razer reserves the right to amend any term at any time without notice.