



Questo manuale d'istruzione è fornito da [trovaprezzi.it](http://trovaprezzi.it). Scopri tutte le offerte per [Sony SARS5](#) o cerca il tuo prodotto tra le [migliori offerte di Diffusori Audio](#)

Questo manuale d'istruzione è fornito da [trovaprezzi.it](http://trovaprezzi.it). Scopri tutte le offerte per [Sony SARS5](#) o cerca il tuo prodotto tra le [migliori offerte di Diffusori Audio](#)

**SONY**

## Rear Speaker

### Operating Instructions

SA-RSS



\* 5 0 3 4 5 0 0 1 1 \* (1)

#### Owner's Record

The model and serial numbers are located on the bottom of the speakers.  
Record the serial numbers in the space provided below. Refer to them whenever you call upon your Sony dealer regarding the speakers.

Model No. SA-RSS  
Serial No.

#### WARNING

The AC adaptor is not disconnected from the mains as long as it is connected to the AC outlet, even if the speakers themselves have been turned off.

To reduce the risk of fire, do not cover the ventilation opening of the speakers with newspapers, tablecloths, curtains, etc.  
Do not expose the speakers to naked flame sources (for example, lighted candles).

To reduce the risk of fire or electric shock, do not expose these speakers to dripping or splashing, and do not place objects filled with liquids, such as vases, on the speakers.

As the mains plug of AC power adaptor is used to disconnect the AC power adaptor from the mains, connect it to an easily accessible AC outlet. Should you notice an abnormality in it, disconnect it from the AC outlet immediately.

Do not install the speakers in a confined space, such as a bookcase or built-in cabinet.

Do not expose batteries or appliances with battery-installed to excessive heat, such as sunshine and fire.

**Do not place this product close to medical devices.**

This product (including accessories) has magnet(s) which may interfere with pacemakers, programmable shunt valves for hydrocephalus treatment, or other medical devices. Do not place this product close to persons who use such medical devices. Consult your doctor before using this product if you use any such medical device.

#### RECYCLING RECHARGEABLE BATTERIES

Rechargeable batteries are recyclable.  
You can help preserve our environment by returning your used rechargeable batteries to the collection and recycling location nearest you.

For more information regarding recycling of rechargeable batteries, visit <https://www.sony.com/electronics/eco/environmental-management>

Caution: Do not handle damaged or leaking rechargeable batteries.

Indoor use only.

#### For the speakers

The nameplates are located on the bottom of the speakers.

#### For the AC adaptor

Labels for AC adaptor model No. and Serial No. are located at the bottom of the AC adaptor.

- Do not dismantle, open or shred secondary cells or batteries.
- In the event of a cell leaking, do not allow the liquid to come in contact with the skin or eyes. If contact has been made, wash the affected area with copious amounts of water and seek medical advice.
- Do not use any charger other than that specifically provided for use with the equipment.
- Secondary cells and batteries need to be charged before use. Always use the correct charger and refer to the manufacturer's instructions or equipment manual for proper charging instructions.
- After extended periods of storage, it may be necessary to charge and discharge the cells batteries several times to obtain maximum performance.
- Dispose of properly.

- Retain the original product literature for future reference.

- Do not expose the batteries (battery pack or batteries installed) to excessive heat such as sunshine, fire or the like for a long time.
- Do not subject the batteries to extreme low temperature conditions that may result in overheating and thermal runaway.

#### For customers in the U.S.A.

**NOTE:**  
These speakers have been tested and found to comply with the limits for a Class B digital device, pursuant to Part 15 of the FCC Rules. These limits are designed to provide reasonable protection against harmful interference in a residential installation. These speakers generate, use and can radiate radio frequency energy and, if not installed and used in accordance with the instructions, may cause harmful interference to radio communications. However, there is no guarantee that interference will not occur in a particular installation. If these speakers do cause harmful interference to radio or television reception, which can be determined by turning the speakers off and on, the user is encouraged to try to correct the interference by one or more of the following measures:  
- Reorient or relocate the receiving antenna.  
- Increase the separation between the speakers and receiver.  
- Connect the speakers into outlets on a circuit different from that to which the receiver is connected.  
- Consult the dealer or an experienced radio/TV technician for help.

If you have any questions about this rear speaker: Visit: <https://www.sony.com/electronics/support>  
Trade Name: SONY  
Model No.: SA-RSS  
Responsible Party: Sony Electronics Inc.  
Address: 16535 Via Esprillo, San Diego, CA 92127 U.S.A.  
Telephone No.: 858-942-2230  
This device complies with part 15 of the FCC rules. Operation is subject to the following two conditions: (1) This device may not cause harmful interference, and (2) this device must accept any interference received, including interference that may cause undesired operation.

#### Supplier's Declaration of Conformity

Trade Name: SONY  
Model No.: SA-RSS  
Responsible Party: Sony Electronics Inc.  
Address: 16535 Via Esprillo, San Diego, CA 92127 U.S.A.  
Telephone No.: 858-942-2230  
This device complies with part 15 of the FCC rules. Operation is subject to the following two conditions: (1) This device may not cause harmful interference, and (2) this device must accept any interference received, including interference that may cause undesired operation.

#### CAUTION

You are cautioned that any changes or modifications not expressly approved in this manual could void your authority to operate these speakers.

These speakers must not be co-located or operated in conjunction with any other antenna or transmitter.

These speakers comply with FCC radiation exposure limits set forth for an uncontrolled environment and meet the FCC radio frequency (RF) Exposure Guidelines. These speakers should be installed and operated keeping the radiator at least 20cm or more away from person's body.

Compliance with FCC requirement 15.407(c)  
Data transmission is always initiated by software, which is the passed down through the MAC, through the digital and analog baseband, and finally to the RF chip. Several special packets are initiated by the MAC. These are the only ways the digital baseband portion will turn on the RF transmitter, which it then turns off at the end of the packet. Therefore, the transmitter will be on only while one of the aforementioned packets is being transmitted. In other words, this device automatically discontinues transmission in case of either absence of information to transmit or operational failure.

Frequency Tolerance: ±20 ppm or less

#### For customers in Canada

These speakers contain licence-exempt transmitter(s)/receiver(s) that comply with Innovation, Science and Economic Development Canada's license-exempt RSS(s).  
Operation is subject to the following two conditions: (1) These speakers may not cause interference; and (2) These speakers must accept any interference, including interference that may cause undesired operation of the speakers.

These speakers complies with ISED radiation exposure limits set forth for an uncontrolled environment and meets RSS-102 of the ISED radio frequency (RF) Exposure rules. These speakers should be installed and operated keeping the radiator at least 20cm or more away from person's body.

5.15 - 5.35 GHz band is restricted to indoor operations only.

Data transmission is always initiated by software, which is the passed down through the MAC, through the digital and analog baseband, and finally to the RF chip. Several special packets are initiated by the MAC. These are the only ways the digital baseband portion will turn on the RF transmitter, which it then turns off at the end of the packet. Therefore, the transmitter will be on only while one of the aforementioned packets is being transmitted. In other words, this device automatically discontinues transmission in case of either absence of information to transmit or operational failure.

## Precautions

#### On safety

- Should any solid object or liquid fall into the rear speaker, unplug the rear speaker and have it checked by qualified personnel before operating it any further.
- Do not climb on the rear speaker, as you may fall down and injure yourself, or the rear speaker damage may result.

#### On the AC adaptor

Use only the supplied AC adaptor. To avoid damaging the unit, do not use any other AC adaptor.

#### On power sources

- Before operating the rear speaker, check that the operating voltage is identical to your local power supply. The operating voltage is indicated on the nameplate at the bottom of the rear speaker.
- If you are not going to use the rear speaker for a long time, be sure to disconnect the rear speaker from the wall outlet (mains). To disconnect the AC power cord (mains lead), grasp the plug itself; never pull the cord.
- One blade of the plug is wider than the other for the purpose of safety and will fit into the wall outlet (mains) in only one way. If you are unable to insert the plug fully into the wall outlet, contact your dealer.
- The AC power cord (mains lead) must be changed only at a qualified service shop.

#### On heat buildup

- Although the rear speaker heats up during operation, this is not a malfunction. If you continuously use this rear speaker at high volume, the rear speaker temperature at the rear and bottom rises considerably. To avoid burning yourself, do not touch the rear speaker.

#### On placement

- Do not place the rear speaker near heat sources or in a place subject to direct sunlight, excessive dust, or mechanical shock.
- Do not place metal objects other than a TV around the rear speaker. Wireless functions may be unstable.
- If the rear speaker is being used in combination with a TV, the heat and noise may cause picture quality may suffer. In such a case, place the rear speaker away from the TV, VCR, or tape deck.
- Use caution when placing the rear speaker on a surface that has been specially treated (with wax, oil, polish, etc.), as staining or discoloration of the surface may result.
- The speakers of this rear speaker are not of magnetically shielded type. Do not place magnetic cards on the rear speaker or near it.

#### If you encounter color irregularity on a nearby TV screen

Color irregularities may be observed on certain types of TV sets.

#### On cleaning

Clean the rear speaker with a soft, dry cloth. Do not use any type of abrasive pad, scouring powder, or solvent such as alcohol or benzene.

#### Others

- At high temperature, the charging may stop or the volume may reduce to protect the battery.
- Even if you do not intend to use the rear speaker for a long time, charge the battery to its full capacity once every 6 months to maintain its performance.
- When the amount of time that the built-in battery can be used seems significantly shorter, it could mean that the rechargeable built-in battery has expired.

If you have any question or problem concerning your rear speaker, please consult your nearest Sony dealer.

## About Compatible Models for the Rear Speaker

The SA-RSS rear speaker works only with the standard model. For information about compatible models, visit Sony's website.  
In these Operating Instructions, the operations are described for speakers used with the compatible model HT-A7000.

#### Note

You may need to update the software depending on the connected device. To update the rear speaker, you need to connect the rear speaker to the AC outlet (mains) using the AC adaptor (supplied). For details about updating, refer to Operating Instructions of the compatible model.

## Parts and Controls

#### Top, front, and bottom

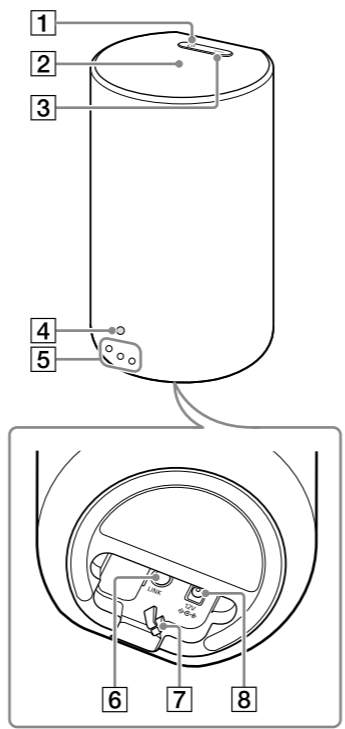

- ⏻ (power) button  
Turns on or off the rear speaker.
- Up-firing speaker
- OPTIMIZE button  
You can perform Sound Field Optimization of a connected device. When both of the rear speakers turn on, you can perform Sound Field Optimization by pressing OPTIMIZE on either rear speaker without operation on the connected device.  
Sound Field Optimization may not be performed depending on the status of the connected device. This function works only with specified models. For information about compatible models, confirm on the Sony website.
- Power indicator  
- Flashes slowly (green): The rear speaker is attempting to automatically connect to a compatible model.  
- Lights up (green): The rear speaker is connected to a compatible model.  
- Flashes twice repeatedly (green): The rear speaker is attempting to manually connect to a compatible model.  
- Flashes/lights up (amber): The software is updating.  
- Lights up (red): The rear speaker is in standby mode.  
- Turns off: The rear speaker is turned off.
- Battery indicators  
During charging  
- Flash slowly: The built-in battery is charging.  
- Turn off: Charging is completed.  
During use (without power source connection)  
- Light up: The remaining battery level is indicated.  
- The left most indicator flashes: The remaining battery level is low. Charge the built-in battery.

- LINK button
- Cable holder
- DC IN terminal

#### Note

- Do not put anything on the up-firing speaker or touch the up-firing speaker carelessly.
- The brightness of the power and battery indicators sync with the DIMMER settings of a compatible model.

#### Rear

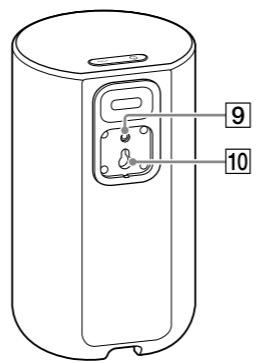

- Mounting hole for the general speaker stand
- Wall mounting hole

#### Note

When using the mounting hole for the general speaker stand (9) or wall mounting hole (10), peel off the cover on the rear of the speaker by inserting a flathead screwdriver, etc. into a groove on the lower side of the cover.

## Charging the Rear Speaker

- Connect the AC adaptor (supplied) to the rear speaker, then connect the AC adaptor to the AC outlet (mains).

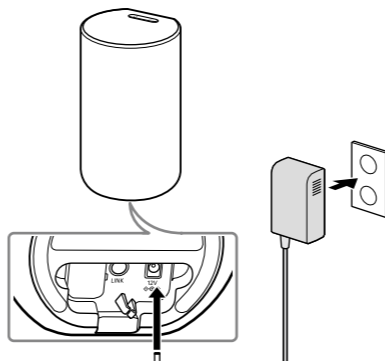

The battery indicators flash during charging. The battery indicators turn off after completion of charging.

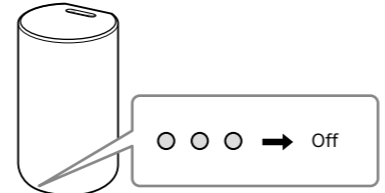

#### Note

Do not remove the plug part from the AC adaptor and connect the plug to the AC outlet (mains) alone. There may be a risk of electric shock or fire.

- After completion of charging, disconnect the AC adaptor from the AC outlet (mains), then disconnect the AC adaptor from the rear speaker.

#### Tip

You can use the rear speaker during charging. In this case, it may take longer to charge the built-in battery compared to when the speaker is turned off depending on the conditions of use. Therefore, it is recommended to turn off the speaker when charging.

## Installation

To enjoy the surround sound effectively, install the rear speakers so that their height positions match the position of your ear.

- Do not install the rear speakers in a shelf or right below a ceiling.
- Do not install the rear speakers in an inclined state or unstable place.

#### Installing on a Shelf/Stand

The following illustration is an installation example to use the rear speakers with the compatible model HT-A7000 and an optional subwoofer.

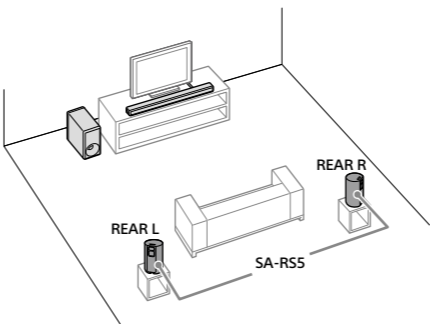

- Check the right and left rear speakers using the labels on the bottom.  
"REAR R" is for right, "REAR L" is for left.
- Install the rear speakers behind your listening position.  
Install the rear speakers by turning them to your listening position.

#### Note

Lay the bottom (the face on which there is a label) down to install the rear speaker. Installations other than the above are not supported.

#### Tip

To obtain a good surround sound, perform Sound Field Optimization or speaker distance setting. The function/operation differs depending on compatible models. For details, refer to the operating instructions or Help Guide of the compatible model.

#### Mounting on the Wall

The following illustration is an installation example to use the rear speakers with the compatible model HT-A7000 and an optional subwoofer.

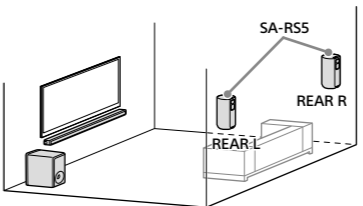

#### Note

- Have the installation done by a Sony dealer or licensed contractor and pay special attention to safety during the installation.
- Sony shall not be held responsible for accidents or damage caused by improper installation, insufficient wall strength, improper screw installation or natural disaster, etc.

- Prepare a screw (not supplied) that is suitable for the wall mounting hole on the rear of the speakers.

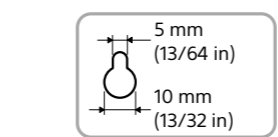
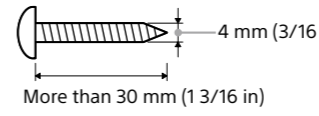

Wall mounting hole on the rear of the rear speaker

- Decide the wall mounting position of the speaker and fasten the screw there.

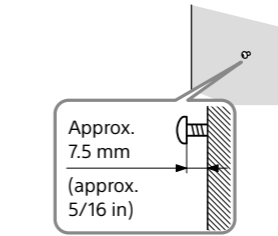

- Peel off the cover on the rear of the speaker by inserting a flathead screwdriver, etc. into a groove on the lower side of the cover.

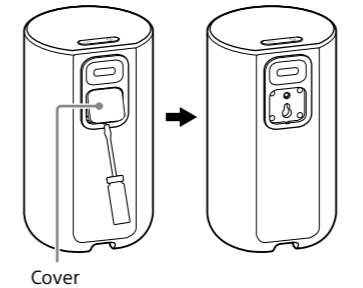

- Hang the wall mounting hole on the screw.  
Check the labels on the bottom of the speakers. "REAR R" is for right, "REAR L" is for left.

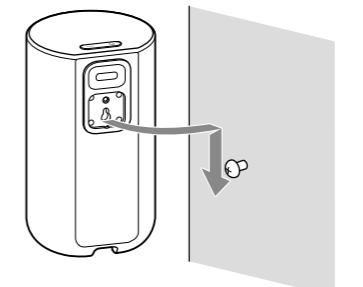

- When mounting the rear speaker on the wall with the AC adaptor connected, fix the cable of the AC adaptor in the cable holder on the bottom of the rear speaker.

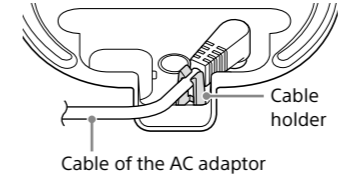

#### Note

- Prepare screws (not supplied) that are suitable for the wall material and strength. As a plasterboard wall is especially fragile, attach the screws securely in the wall beam. Mount the speakers onto a reinforced wall making sure that the heights of the right and left speakers are equal.
- Keep the cover that was peeled off in step 3 for use when you do not mount the rear speaker on a wall.

#### Tip

You can store the cable of the AC adaptor compactly with the cable guide (supplied).  
Store the cable and DC plug of the AC adaptor in the cable guide, attach the cable guide to the bottom of the rear speaker while connecting the DC plug to the DC IN terminal, then fix the cable in the cable holder.

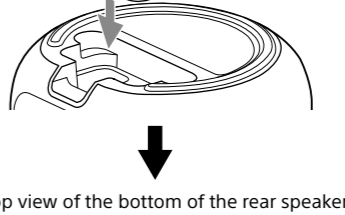
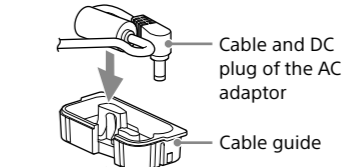

Top view of the bottom of the rear speaker

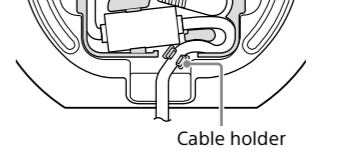

- Attach the cable guide and cable of the AC adaptor firmly by inserting it deeply when using the cable guide.
- When pressing LINK on the bottom of the rear speaker, remove the cable guide.
- To remove the cable guide, remove the cable from the cable holder, then pull the cable guide out by inserting your finger into the hollows.

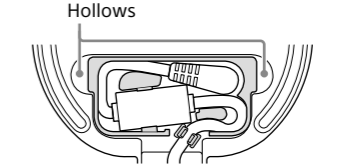

## Connection

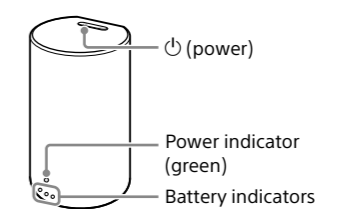

#### Tip

You can connect the optional subwoofer with compatible models in the following way when installing it too.

- Turn on the compatible model.
- Press ⏻ (power) to turn the rear speaker on.  
The power indicator lights or flashes when the rear speaker turns on.  
Turn on both left and right rear speakers. You can use the rear speaker during charging.

- Make sure that the power indicators on the rear speakers light in green.  
When the power indicators light in green, the connection between the rear speakers and a compatible model is established.  
If the connection is not established, connect the rear speakers to the compatible model manually. For details, see "If the Connection is not Established Automatically."

#### Note

If a compatible model is in standby mode while the AC adaptor is not connected to the rear speaker, the rear speaker turns off automatically after 5 minutes. In this case, turn on both left and right rear speakers to use the rear speakers.

#### If the Connection is not Established Automatically

If you cannot connect the rear speakers to the compatible model automatically or you use multiple compatible models and want to specify the compatible model for connecting the rear speakers, perform manual connection.  
The following operation is described for rear speakers used with the compatible model HT-A7000. Use the remote control supplied with this operation. If you use other compatible models, refer to their Operating Instructions.

- Press HOME.  
The home menu appears on the TV screen.
- Select [Setup] - [Advanced Settings] on the home menu.
- Select [Speaker Settings] - [Wireless Speaker Settings] - [Start manual linking].  
The [Start manual linking] screen appears on the TV screen.

- Press LINK on the rear speaker.

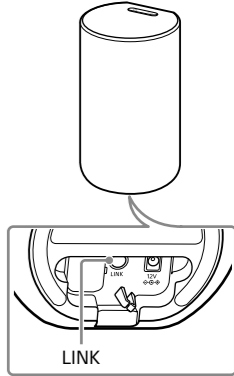

The power indicator of the rear speaker that had LINK pressed flashes twice repeatedly in green.

- Select [Start].  
The manual link starts.  
The connecting process appears on the TV screen. To cancel the manual link, select [Cancel].

- When [Rear Speaker (R)] and [Rear Speaker (L)] display [Connected], select [Finish].

- Press ⏻ (enter).  
The link is established and the power indicator of the rear speaker lights in green.

#### Note

- If you perform [Start manual linking], [Link mode] of [Wireless Speaker Settings] is set to [Manual] automatically.
- Only the rear speakers for which [Connected] has been displayed in Step 6 connect to a compatible model. If the connection of the rear speakers cannot be established, perform the manual connection again.

#### If Wireless Transmission is Unstable

If you use multiple wireless systems, such as a wireless LAN, the wireless signals may become unstable. In this case, the transmission may be improved by changing the following setting.  
The following operation is described for rear speakers used with the compatible model HT-A7000. Use the remote control supplied with the compatible model HT-A7000 when performing this operation. If you use other compatible models, refer to their Operating Instructions.

- Press HOME.  
The home menu appears on the TV screen.
- Select [Setup] - [Advanced Settings] on the home menu.
- Select [Speaker Settings] - [Wireless Speaker Settings] - [RF Channel].
- Select the setting you want.  
• [On] (default setting): Normally select this. The compatible model automatically selects the better channel for transmission. Stronger mode for wireless interference.  
• [Off]: The compatible model selects a channel from the limited frequency band to prevent external wireless interference. If sound dropping occurs while [On] is selected, it may be improved by selecting [Off].

#### Note

- If you change the [RF Channel] setting from [Off] to [On], it may take 1 minute to reconnect.
- Some compatible models may not meet this setting depending on the countries/regions where you purchased it.

## Troubleshooting

If you experience any of the following difficulties while using the rear speakers, use this troubleshooting guide to help remedy the problem before requesting repairs. Should any problem persist, consult your nearest Sony dealer. Be sure to bring all of your rear speakers, the compatible model, and optional subwoofer even if it seems as though only one has a problem when you request a repair.  
The following solutions are described for speakers used with the compatible model HT-A7000. If you use other compatible models, refer to their Operating Instructions.

- No sound is heard from the rear speakers.**
  - Make sure the AC adaptor is connected properly or the built-in battery is charged.
  - If the power indicator on the rear speaker does not light, try the following.
    - Make sure the AC adaptor is connected properly or the built-in battery is charged.
    - Press ⏻ (power) of the rear speaker to turn on the power.
  - If the power indicator of the rear speaker flashes slowly in green or lights in red, try the following.
    - Move the rear speaker to a location near the compatible model so that the power indicator on the rear speaker lights in green.
    - Follow the steps in "If the Connection is not Established Automatically."
    - Check the wireless connection status. For details, refer to the Operating Instructions of the compatible model.
  - Press REAR ⏻ (rear speakers volume) + on the remote control of the compatible model to increase the volume of the rear speakers.
- If you change the [RF Channel] setting of the compatible model from [Off] to [On], it may take 1 minute for the sound to be output.

Continued on back page



- If the power indicator on the rear speaker flashes in red, disconnect the AC adaptor from the AC outlet (mains), press ⏻ (power) to turn off the rear speaker, reconnect the AC adaptor to the AC outlet (mains), then turn on the rear speaker again.
- The rear speaker may not output sound depending on the music source or sound field. For details, refer to the operating instructions or Help Guide of the compatible model.

**Sound skips or has noise.**

- If there is a device nearby that generates electromagnetic waves, such as a wireless LAN or a microwave oven in use, locate the rear speakers and compatible model apart from that device.
- If there is an obstacle between the compatible model and rear speakers, move or remove the obstacle.
- Locate the compatible model and rear speakers as close as possible.
- Switch the network connection of the TV or Blu-ray Disc player from wireless to wired.

**The rear speaker cannot be charged.**

- In an extremely cold or hot environment, charging stops for safety. If charging takes a long time, it also makes charging of the rear speaker stop. To resolve these issues, disconnect the AC adaptor, and then connect it again within an operating temperature between 5 °C and 35 °C (41 °F and 95 °F).

**Sound is not output from some speakers.**

- Some speakers may not output sound depending on the music source, sound field, or compatible model. For details, refer to the operating instructions or Help Guide of the compatible model.

**Sound Field Optimization failed.**

- Speakers may not be correctly located. Check the installation location on the labels on the bottom of the two speakers and install them in the correct location.
- Install the speakers upright so that the labels on the bottom of the speakers are directed downwards.
  - If the speaker is installed sideways, Sound Field Optimization cannot be performed properly.
  - If the speaker is installed in an inclined state, the microphone for measurement of the speaker is also inclined and the sound for measurement ceiling distance is output in an inclined state. These may be the cause that the Sound Field Optimization failed.
- Perform Sound Field Optimization again in a situation where the surrounding is quiet.
- Install the speakers with a distance of more than 50 cm (19 3/4 in). If the distance between speakers is too close, Sound Field Optimization cannot be performed properly.
- Bring the speakers closer if the speakers are installed at a distance far away from each other.
- If there is any obstacle between speakers or the microphone for measurement of the speaker is blocked by an obstacle, Sound Field Optimization cannot be performed properly. Remove it if there is any obstacle between speakers or in front of the speakers.

## Resetting the Rear Speaker

If the rear speaker still does not operate properly, reset the rear speaker as follows.

- Disconnect the AC adaptor from the AC outlet (mains).**

- Press and hold OPTIMIZE for more than 10 seconds.**

The rear speaker is reset.

**Note**

Turn on the rear speaker by pressing ⏻ (power) of the rear speaker after resetting.

**Tip**

Resetting is the operation that turns off the rear speaker forcibly. The settings of the rear speaker remain.

# Specifications

**Amplifier section**

**U.S. models:**

POWER OUTPUT AND TOTAL HARMONIC DISTORTION: (FTC)

Up-firing speaker:

With 6 ohms loads, both channels driven, from 200 - 20 k Hz; rated 20 W per channel minimum RMS power, with no more than 1% total harmonic distortion from 250 mW to rated output.

Tweeter:

With 6 ohms loads, both channels driven, from 3,000 - 20 k Hz; rated 5 W per channel minimum RMS power, with no more than 1% total harmonic distortion from 250 mW to rated output.

Woofers:

With 6 ohms loads, both channels driven, from 200 - 3,000 Hz; rated 20 W per channel minimum RMS power, with no more than 1% total harmonic distortion from 250 mW to rated output.

POWER OUTPUT (reference)

Up-firing speaker: 40 W (at 6 ohms, 1 kHz)

Tweeter: 10 W (at 6 ohms, 10 kHz)

Woofers: 40 W (at 6 ohms, 100 Hz)

**Canadian models:**

POWER OUTPUT (rated)

Up-firing speaker: 28 W (at 6 ohms, 1 kHz, 1% THD)

Tweeter: 7 W (at 6 ohms, 10 kHz, 1% THD)

Woofers: 28 W (at 6 ohms, 100 Hz, 1% THD)

POWER OUTPUT (reference)

Up-firing speaker: 40 W (at 6 ohms, 1 kHz)

Tweeter: 10 W (at 6 ohms, 10 kHz)

Woofers: 40 W (at 6 ohms, 100 Hz)

**Front speaker section**

Speaker system

2way speaker system passive radiator type

Woofers

70 mm × 82 mm (2 7/8 in × 3 1/4 in) cone type

Tweeter

14 mm (9/16 in) soft dome type

**Up-firing speaker section**

Speaker system

Full range speaker system acoustic suspension type

Speaker

46 mm × 54 mm (1 13/16 in × 2 1/4 in) cone type

**Power supply section**

**Power requirements**

DC 12 V (using the supplied AC adaptor connected to AC 100 V - 240 V, 50 Hz/60 Hz power supply) or, using built-in lithium-ion battery

**Power consumption**

On: 45.6 W (during charging the built-in battery)

Standby mode: 1 W or less

Turned off: 0.5 W or less

**Built-in battery life**

Up to 10 hours (in normal playback)<sup>\*1+2</sup>

Up to 3 hours (in full volume playback)<sup>\*1+3</sup>

Up to 10 hours<sup>\*4</sup>

<sup>\*1</sup> Actual performance time may vary from the listed time due to the volume, music source, and usage conditions.

<sup>\*2</sup> Measured value acquired by using our specified music source, connecting to the compatible model HT-A7000, setting the volume level of the compatible model HT-A7000 to 38, with the factory default settings.

<sup>\*3</sup> Measured value acquired by using our specified music source, connecting to the compatible model HT-A7000, setting the volume level of the compatible model HT-A7000 to maximum, setting the volume level of the rear speaker to maximum, setting the voice mode to on, with the factory default settings.

<sup>\*4</sup> Measured value acquired by using our specified test signal and playing with its volume adjusted so that the sound pressure of 70 dB is obtained at a distance of 1 meter (39 3/8 in) from the rear speakers.

**Built-in battery charging time**

About 4 hours (when using with the supplied AC adaptor)\*

(10 minutes of charging; playable for up to 90 minutes)\*

\* Actual charging time may vary from the time above due to the surrounding temperature and usage conditions.

**Wireless transmitter/receiver section**

**Communication system**

Wireless Sound Specification Version 4.0

**Frequency band**

5 GHz

**Modulation method**

OFDM

**Other information**

**Operating temperature**

Between 5 °C and 35 °C (41 °F and 95 °F).

**Dimensions (w/h/d) (approx.)**

145 mm × 250 mm × 134 mm (5 3/4 in × 9 7/8 in × 5 3/8 in) (projecting parts not included)

**Mass (approx.)**

2.4 kg (5 lb 5 oz)

**Included items**

- Rear speaker R (1), Rear speaker L (1)
- AC adaptor (AC-045R55E) (2)
- Cable guide (2)
- Operating Instructions (1)

# Important information on software

This product contains software that is subject to the GNU General Public License ("GPL") or GNU Lesser General Public License ("LGPL"). These establish that customers have the right to acquire, modify, and redistribute the source code of said software in accordance with the terms of the GPL or the LGPL.

For the method to confirm the GPL, LGPL and other software licenses contained in the rear speakers, please refer to the Operating Instructions of a compatible model.

When you use the compatible model HT-A7000, please refer to [Software License Information] under  [Setup] - [Advanced Settings] - [System Settings] on the home menu.

You may find a copy of the relevant source code as required under the GPL/LGPL (and other licenses) at the following URL.

You may obtain the source code as required by the GPL/LGPL on a physical medium from us for a period of three years after our last shipment of this product by applying through the form at the following URL. This offer is valid to anyone in receipt of this information.

https://oss.sony.net/Products/Linux/

Please note that Sony cannot answer or respond to any inquiries regarding the content of this source code.

All other trademarks are trademarks of their respective owners.