



Questo manuale d'istruzione è fornito da trovaprezzi.it. Scopri tutte le offerte per [Strong SRT 7040](#) o cerca il tuo prodotto tra le [migliori offerte di Decoder](#)



Questo manuale d'istruzione è fornito da trovaprezzi.it. Scopri tutte le offerte per [Strong SRT 7040](#) o cerca il tuo prodotto tra le [migliori offerte di Decoder](#)

STRONG

DIGITAL HD SATELLITE RECEIVER SRT 7040



Picture similar

Bedienungsanleitung
Manuel d'utilisation
Manuale utente
Manual del usuario
Manual do utilizador
Használati útmutató
Užívateľský manuál

Brugervejledning
Brukerveiledning
Gebruiksaanwijzing
Användarhandbok
Korisnički priručnik
Ръководство на потребителя
Посібник користувача

SERVICE CENTER

AT	 support_at@strong-eu.com  0820 400 150 (€ 0,12/Min. österr. Festnetz)	HU	 support_hu@strong-eu.com  +36 1 445 26 10
BG	 support_bg@strong-eu.com  +359 32 634451	IT	 support_it@strong-eu.com  199 404 032 Da rete fissa 24,8 cent. al min. 12,5 cent. scatto alla risposta Da rete mobile max 49 cent. al min. 15,6 cent. scatto allo risposta
CZ	 support_cz@strong-eu.com  844 44 44 90	NL	 support_nl@strong-eu.com
DE	 support_de@strong-eu.com  0180 501 49 91 (€ 0,14/Min. deutsches Festnetz) (€ 0,42/Min. max. Mobilfunknetze)	PL	 support_pl@strong-eu.com  801 702 017
DK	 support_dk@strong-eu.com	PT	 support_pt@strong-eu.com  +351 2 100 06 125
ES	 support_es@strong-eu.com  +34 91 119 61 76	SK	 support_sk@strong-eu.com  0850 15 05 50
FR	 support_fr@strong-eu.com	SL	 +386 1 828 08 58
HR	 +385 1 344 57 66	UA	 support_ua@strong-eu.com  +380 (44) 238 61 50

Supplied by STRONG Austria
 Represented by STRONG Ges.m.b.H.
 Teinfaltstraße 8/4. Stock
 1010 Vienna, Austria
 Email: support_at@strong-eu.com

Licenses

This product contains one or more programs protected under international and U.S. copyright laws as unpublished works. They are confidential and proprietary to **Dolby Laboratories**. Their reproduction or disclosure, in whole or in part, or the production of derivative works therefrom without the express permission of Dolby Laboratories is prohibited. Copyright 2003-2009 by Dolby Laboratories. All rights reserved.

SIMPLIFIED EU DECLARATION OF CONFORMITY

Hereby, STRONG declares that the SRT 7040 is in compliance with Directive 2014/53/EU.

The full text of the EU declaration of conformity is available at the following internet address: <https://eu.strong-eu.com/downloads/>

Subject to alterations. In consequence of continuous research and development technical specifications, design and appearance of products may change. Manufactured under license from Dolby Laboratories. Dolby, Dolby Audio and the double-D symbol are trademarks of Dolby Laboratories. The terms HDMI, HDMI High-Definition Multimedia Interface, and the HDMI Logo are trademarks or registered trademarks of HDMI Licensing Administrator, Inc. All product names are trademarks or registered trademarks of their respective owners.

© STRONG 2023. All rights reserved.

TABLE OF CONTENT

1. INSTRUCTION	6
1.1 Safety Instructions	6
1.2 Storage	6
1.3 Equipment Set-up	6
1.4 Accessories	7
1.5 Usage of external USB devices	7
2. YOUR RECEIVER	7
2.1 PIN code default: 0000	7
2.2 Front and side panel	7
2.3 Rear panel	8
2.4 Remote Control	8
2.5 Installing the batteries	10
2.6 Using the remote control	10
3. CONNECTIONS	11
3.1 Basic connection using an HDMI cable	11
3.2 Basic connection using a Scart cable	11
3.3 Connecting multiple fixed LNBs using a DiSEqC switch	12
3.4 Connecting to digital audio amplifier	12
3.5 Connecting a USB storage device	13
4. FIRST TIME INSTALLATION	13
4.1 Dish setup	13
4.1.1 Installation	13
4.1.2 Antenna Connection	14
4.1.3 Satellite List	14
4.1.4 Antenna Setup	14
4.1.5 Single Satellite Search	14
4.1.6 Multi Satellite Search	14
4.1.7 Transponder List	14
4.1.8 Signal Adjust	14
4.1.9 Search	15
5. QUICK GUIDE FOR USING YOUR RECEIVER	15
6. OPERATION	15
6.1 Changing channels	15
6.1.1 Direct access	15
6.1.2 Channel list	15
6.1.3 Using the ▲▼ buttons	15
6.1.4 Using the CH+/CH- buttons	16
6.1.5 Using the ⏪ button	16
6.2 Info Banner	16

6.3 Selection of audio language	16
6.4 Teletext	16
6.5 Subtitles	16
6.6 EPG (Electronic Programme Guide)	16
6.7 Favourite channels	17
7. MAIN MENU	17
7.1 Installation menu	17
7.1.1 Installation	17
7.1.2 DiSEqC 1.2	18
7.1.3 SatCR	19
7.1.4 Single satellite search	20
7.1.5 Transponder Edit Options	21
7.1.5.1 Transponder List	21
7.1.5.2 Satellite Edit options	21
7.2 TV Channel List and Radio Channel List	21
7.3 Multimedia	23
7.3.1 Media Player	23
7.3.2 System Setup	24
7.3.3 Language	25
7.3.4 TV System	25
7.3.5 Local Time Setting	25
7.3.5.1 Timer Setting	26
7.3.6 Dump channel list	28
7.3.6.1 DB Management	28
7.3.6.2 Load from USB Update channel List	28
8. A.1 TROUBLESHOOTING	28
9. A.2 SPECIFICATIONS	29

1. INSTRUCTION

1.1 Safety Instructions

DO NOT INSTALL YOUR RECEIVER:

- In a closed or poorly ventilated cabinet; directly on top of or under any other equipment; on a surface which might obstruct the ventilation slots.

DO NOT EXPOSE THE RECEIVER OR ITS ACCESSORIES:

- To direct sunlight or any other equipment that generates heat; to rain or intense moisture; to intense vibration and to any shock which may cause permanent damage to your receiver or to any magnetic objects, such as loudspeakers, transformers, etc.
- Do not use a damaged power cord. It may cause a fire or an electric shock. Do not touch a power cord with wet hands. It may cause an electric shock.
- When the receiver is not used for a long period of time, you should unplug the power cord from the wall socket.
- Do not use alcohol or ammonia based liquids to clean the receiver. If you wish, you may clean your receiver with a soft lint-free cloth slightly made damp with a mild soap solution, and only after disconnecting from the mains voltage supply. Make sure no foreign objects fall through the ventilation slots because this could cause fire or an electric shock.
- Do not place any objects on top of the receiver because this might prevent proper cooling of the components inside.

Safety Precautions

- Never try to open the receiver. It is dangerous to touch the inside of the receiver due to high voltages and possible electrical hazards. Opening the receiver will void the warranty of the product. Refer all maintenance or servicing to suitably qualified personnel.
- When you are connecting cables, be sure that the receiver is disconnected from the mains supply voltage. Wait a few seconds after switching off the receiver before you move the receiver or disconnect any equipment.
- It is a necessity that you only use an approved extension and compatible wiring that is suitable for the electrical power consumption of the installed equipment. Please ensure that the electrical power supply corresponds with the voltage on the electrical identification plate at the back of the receiver.

If the receiver does not operate normally even after strictly following the instructions in this user manual, it is recommended to consult your dealer.

1.2 Storage

Your receiver and its accessories are stored and delivered in a packaging designed to protect against mechanical shocks and moisture. When unpacking it, make sure that all the parts are included and keep the packaging away from children. When transporting the receiver from one place to another or if you are returning it under warranty conditions, make sure to repack the receiver in its original packaging with its accessories. Failing to comply with such packaging procedures could damage the product and void your warranty.

1.3 Equipment Set-up

We recommend you consult a professional installer to set up your equipment. Otherwise, please follow the instructions below:

- Refer to the user manual of your TV and your antenna.
- Make sure that the SCART/HDMI cable and outdoor components are in a good condition and the SCART/HDMI connections are well shielded and from good quality.

This manual provides complete instructions for installing and using this receiver. The symbols serve as follows.

WARNING Indicates warning information.

NOTE Indicates any other additional important or helpful information.

MENU Represents a button on the remote control or the receiver.

Move to Represents a menu item within a window.

1.4 Accessories

- 1x installation instructions
- 1x Safety and guarantee instructions
- 1x remote control
- 2x batteries (AAA type)

NOTE: The batteries should not be recharged, disassembled, electrically short-circuited or be mixed or used with other types of batteries. If rechargeable accumulators instead of batteries are going to be used, we recommend using (e.g. NiMH) types with low self-discharge to ensure long time operation of remote control.

1.5 Usage of external USB devices

- It is recommended to use USB 2.0 storage devices. If your device is not compatible to USB 2.0 specifications, multimedia, functions of the receiver might not work properly.*
- If you are going to use an external USB HDD (Hard Disk Drive), please consider that the power specifications may exceed the supported output of your receiver (5 V/800 mA). If so, please connect your USB HDD to an according external power adapter.
- STRONG cannot guarantee compatibility with all types of USB storage devices.
- It is advised not to store important information on USB storage devices used with the receiver. Always make backups of data on your USB storage device before using it with this receiver. STRONG will not take responsibility for any loss of information or circumstances caused by loss of information.
- STRONG cannot guarantee the playback of all files although extensions are listed, as it depends on file size, codec, bit rate and resolution.

Please ensure that either the USB device is already formatted to FAT/FAT32.

2. YOUR RECEIVER

2.1 PIN code default: 0000

2.2 Front and side panel

- | | |
|-----------------------|--|
| 1. LED display: | Shows channel number in operation and time in Standby |
| 2. Standby indicator: | Shows power state of the receiver: RED LED - receiver is in standby mode |
| 3. IR Sensor: | Receives commands from the remote control |
| 4. Power button: | Switch the receiver to Standby or On. |
| 5. USB: | For connection of USB device for Multimedia use |

Fig. 1

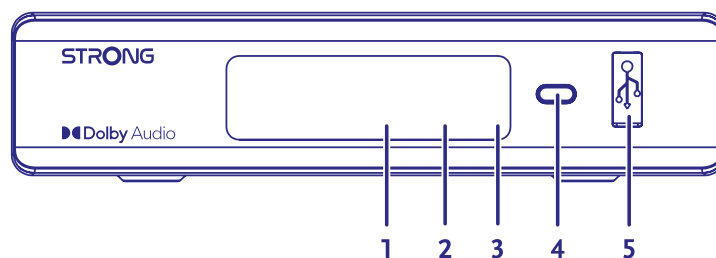

2.3 Rear panel

Fig. 2

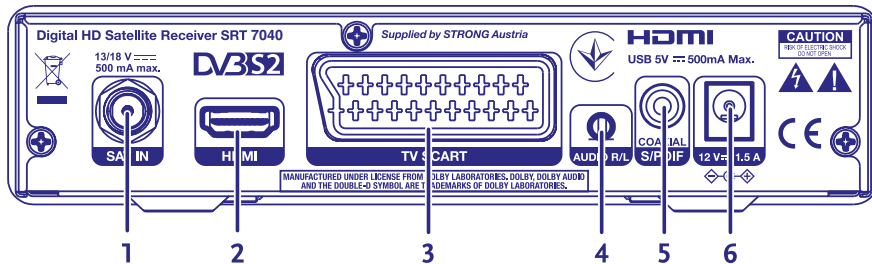

1. SAT IN

To connect to the LNB of your satellite dish for reception of satellite broadcast signal

2. HDMI

To connect to the HDMI input of your TV using a good quality HDMI cable

3. TV SCART

To connect to TV using a SCART cable

4. Audio L/R

To connect to an analogue amplifier for stereo audio

5. S/PDIF coaxial

To connect to a digital or home cinema audio amplifier









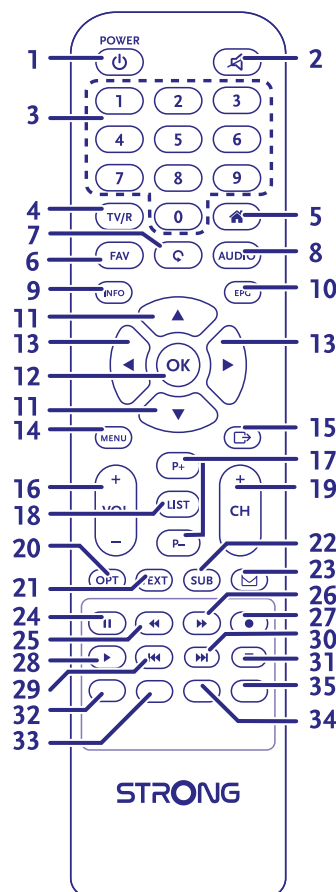





6. Power connector

The receiver requires a wall adapter, mains voltage input 100~240V AC 50~60Hz 12V, 1.5A DC output. Please check the local power conditions before connecting the receiver to the mains supply.

2.4 Remote Control

Fig. 3



1.  Turns the receiver ON/Standby
2.  To turn the sound on or off
3. 0-9 Channel number and numeric value input
4. TV/R Toggles between TV and radio mode
5.  Same as **MENU**
6. FAV To access your favourite channels. Toggles between available favourite groups
7.  To switch between the last viewed channels
8. **AUDIO** Displays the audio selection menu with selections for available languages and audio modes
9. **INFO** Press once to display channel number/name and current/coming information. Press twice to display detailed event information. Press again to view some technical details about the current channel.
10. **EPG** Viewing mode: Displays the EPG (Electronic Programme Guide)
11.  Switches to the next/previous channel in viewing mode, Menu: moving the highlight up/down Teletext: Page up or down.
12. **OK** Viewing mode: Displays the channel list. Menu: activation of the highlighted item
13.  Decreasing/increasing the volume level in viewing mode/navigating through the menus/changing values of settings in a menu. Media player: make steps in program banner. Teletext: Scroll through subpages.
14. **MENU** To open the main menu in viewing mode or to go one step back in the menu
15.  Cancellation of current process/exit from main menu to viewing mode
16. **VOL+/-** Increases/decreases the volume level in TV mode
17. **P+/P-** Jumps 10 places up or down in channel list or any other list.
18. **LIST** Displays the channel list.
19. **CH+/-** Channel up/down
20. **OPT** No function.
21. **TEXT** To open or close Teletext if available on the current channel.
22. **SUB** To select subtitles language out of available ones on the current channel
23.  No function
24. **II** Hold play during playback
25.  Searches backwards during playback. Each pressing increases the speed (x2 – x24)
26.  Searches forwards during playback/. Each pressing increases the speed (x2 – x24)
27.  No function
28.  Starts/resumes the playback in media player
29.  Jumps to the previous file during playback.
30.  Jumps to the next file during playback.
31.  Stops playback of multimedia files
32. **RED** Flexible functions in OSD menu.
33. **GREEN** Flexible functions in OSD menu. Changes the picture resolution in viewing mode.
34. **YELLOW** Flexible functions in OSD menu.Changes the picture Aspect Ratio in viewing mode.
35. **BLUE** Flexible functions in OSD menu.

2.5 Installing the batteries

Fig. 4

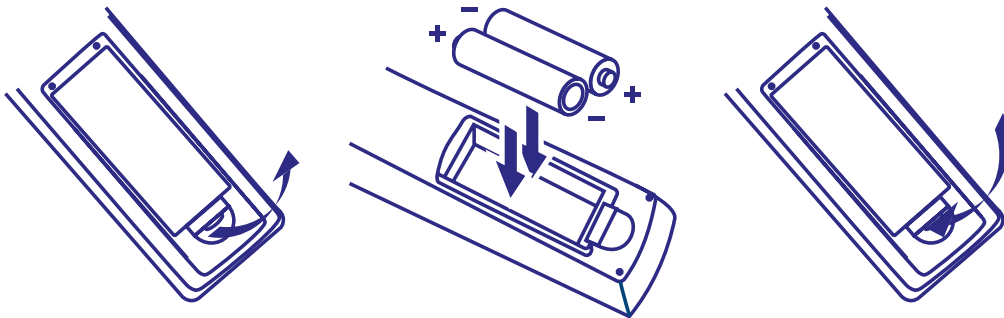

Remove the battery cover from the remote control and put 2x AAA size batteries inside the compartment. The diagram inside the battery compartment shows the correct way to install the batteries.

1. Open the cover
2. Install batteries
3. Close the cover

NOTE: The batteries should not be recharged, disassembled, electrically short-circuited, be mixed or used with other types of batteries.

2.6 Using the remote control

Fig. 5

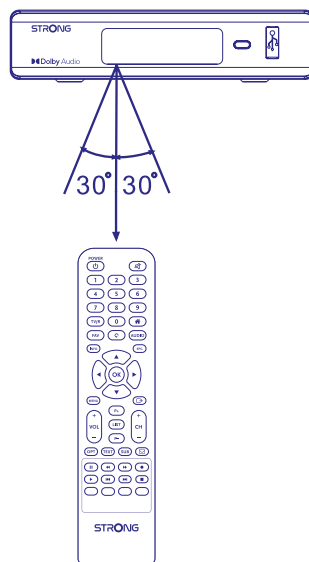

To use the remote control, point it towards the front of the digital receiver. The remote control has a range of up to 7 metres from the receiver, if properly aligned towards the IR eye on the front panel. The remote control will not operate if its path is blocked.

NOTE: Sunlight or very bright light might decrease the sensitivity of the remote control.

3. CONNECTIONS

3.1 Basic connection using an HDMI cable

Fig. 6

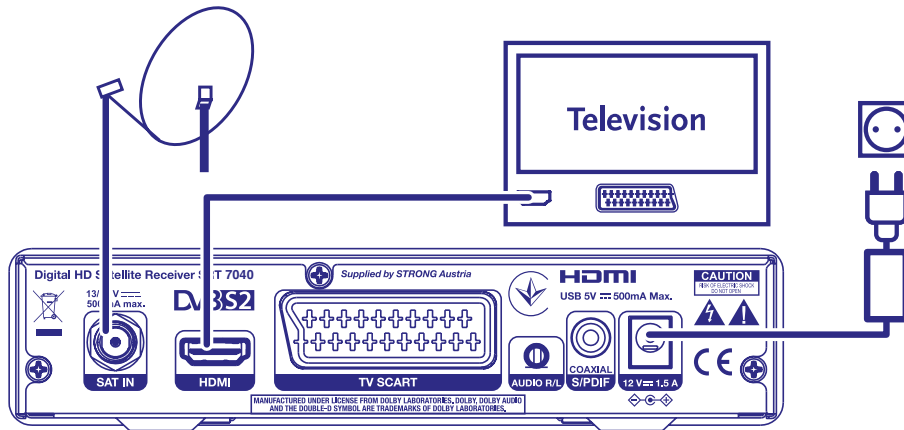

- Connect the LNB of your satellite antenna to the SAT IN connector of your receiver using a good quality coax cable and suitable 'F-connector' plugs.
- Connect one end of a good quality HDMI cable to the HDMI output on your receiver and the other end to the HDMI input of your TV.
- Plug the power adapter to a suitable wall outlet.

3.2 Basic connection using a Scart cable

Fig. 7

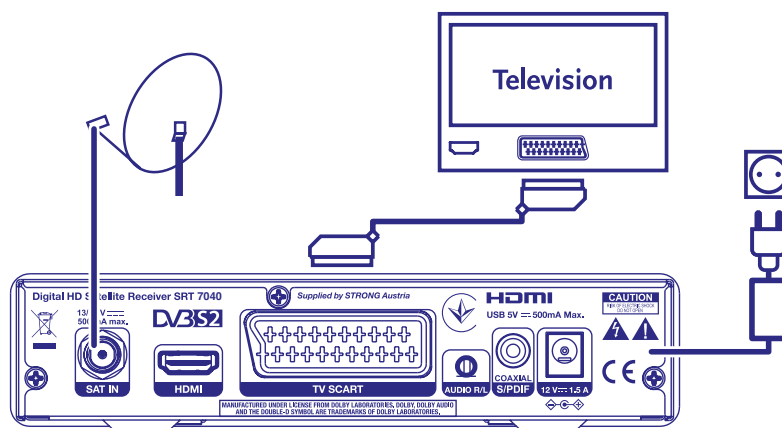

- Connect the LNB of your satellite antenna to the SAT IN connector of your receiver using a good quality coax cable and suitable 'F-connector' plugs.
- Connect one end of a good quality Scart cable to the TV SCART connector on your receiver and the other end to the SCART input of your TV.
- Plug the power adapter to a suitable wall outlet.

3.3 Connecting multiple fixed LNBS using a DiSEqC switch

Fig. 8

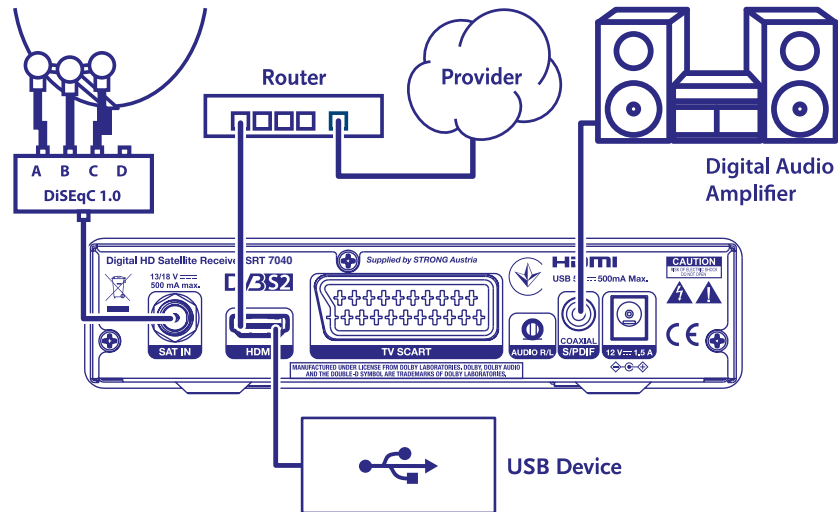

- Connect the LNBS of your fixed antenna to the inputs of a DiSEqC switch
- Connect the output or "to receiver" connector of the DiSEqC switch to the SAT IN connector on your receiver.
- Refer to section 3.1 or 3.2 for TV and mains connections.

3.4 Connecting to digital audio amplifier

Fig. 8

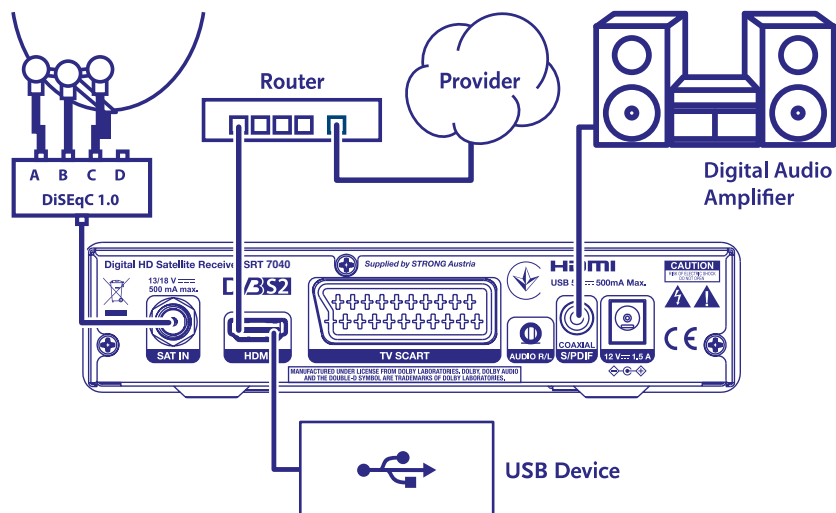

Connect one end of a good quality coaxial audio cable to the S/PDIF output of your receiver and the other end to the coaxial audio input of your home theatre, amplifier or any other device supporting digital audio.

3.5 Connecting a USB storage device

Fig. 8

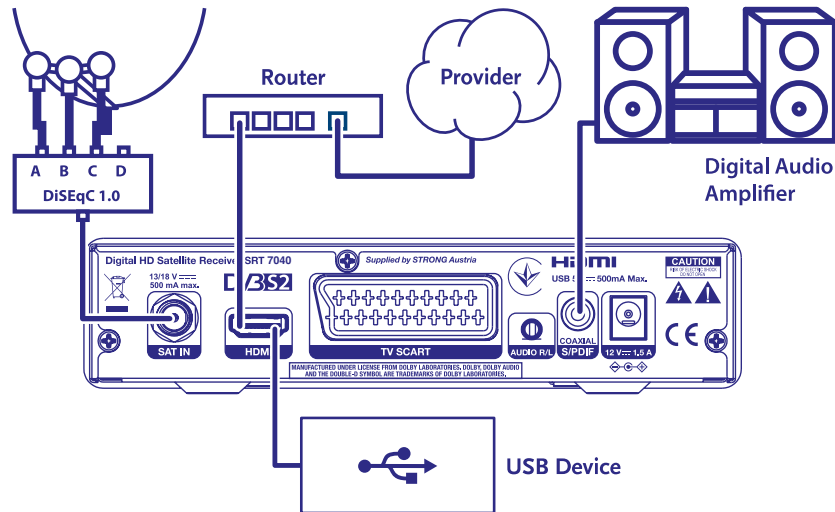

This port can be used for USB storage devices such as USB pen drives or HDD with a maximum peak current of 500 mA. It is recommended to use USB 2.0 storage devices for playback of video files or HD movies.

4. FIRST TIME INSTALLATION

After all connections have been made properly, switch on your TV and make sure the receiver is connected to the main power. If you are using the receiver for the first time or restored to factory default, the *Installation guide* menu will appear on your TV screen. Use ◀▶ to select the *OSD Language* of your preference. Set the other options as are appropriate for your situation. HDMI output is always available. TV format with HDMI connection is 16:9 Wide screen.

NOTE: If Germany is selected as country, a pre-installed channel list is available. German channels from ASTRA 19.2E will be installed. A pop-up list will show for selection of the preferred regional channel.

You can continue to *Channel search* and install further channels assumed your dish is pointed at Astra 19° East and/or uses DiSEqC port 1. Or go directly to viewing mode by pressing **OK** to start enjoying the pre-installed German channels immediately.

4.1 Dish setup

NOTE: This chapter gives an overview of the possibilities for a quick setup.

In depth explanations you will find in **Chapter 7**.

4.1.1 Installation

The *Installation* menu provides the satellite dish setup.

The menu allows you to set up *Antenna Connection*, *Satellite List*, *Antenna Setup*, *Single Satellite search*, *Multi Satellite Search* and *TP List*.

Press the **MENU** button to enter main menu.

Press ▲▼ button to highlight "Installation", press

▶ button to enter the "Installation" menu.

Press ▲ or ▼ button to select the desired item and press **OK** button to enter the sub-menu.

Press ⏪ button to exit.

4.1.2 Antenna Connection

Press ◀▶ button to select LNB. LNB includes *Fixed Antenna* and *Motor Antenna*.

4.1.3 Satellite List

Press ▲ or ▼ button to highlight satellite, press **OK** button select a satellite. A heart symbol will mark the selected satellite(s).

RED button: Edit satellite

GREEN button: Add satellite

BLUE button: Delete satellite

4.1.4 Antenna Setup

Motor Antenna:

If you selected *Motor Antenna* in Antenna Connection menu, this menu allows you to change settings like LNB frequency, motor type, local longitude/local latitude, delete all, motor setting and limit setup.

Fixed Antenna:

If you selected *Fixed Antenna* in *antenna connection* menu, this menu allows you to change settings like satellite, LNB frequency, transponder, DiSEqC 1.0, DiSEqC 1.1, 22kHz, and polarity.

When settings are correct, press ⏪ to return to DVBS installation menu.

4.1.5 Single Satellite Search

To scan 1 satellite:

Select *Satellite*, *FTA only*, *Scan Channel*, *Network Search*, *Scan Mode* and *Tuner* to your requirements.

Highlight *Search* and press **OK** button to start search on the selected satellite.

4.1.6 Multi Satellite Search

To scan more than 1 satellite:

Adjust *FTA Only*, *Scan Channel*, *Network Search*, *Scan mode* and *Tuner* to your requirements.

All satellites selected in the satellite list are shown in the top line.

Highlight *Search* and press **OK** button to start searching on all satellites selected in the satellite list.

4.1.7 Transponder List

If needed, transponders can be edited, added, deleted, or individually searched. Parameter of satellite transponders can be changed by broadcasters over time.

RED button: *Edit TP*

GREEN button: *Add TP*

YELLOW button: *Delete TP*

BLUE button: *Search Channels*

Press ◀▶ button to change satellite.

Press ▲ or ▼ button to select Transponder.

Select the *Search* option, press **OK** button to enter the auto scan menu.

Press the cursor button to set FTA only *Yes* or *No*. (FTA = Free to Air, Free to watch.)

NOTE: Scrambled channels cannot be watched with this receiver. Select if you want to store TV and radio channels, only TV or only radio. Select network search *Yes* if you only want to store channels which belong to one provider. These channels are usually scrambled.

4.1.8 Signal Adjust

The signal strength and quality bar on the bottom of the screen allows you to fine tune the alignment of your antenna for optimum reception. Adjust your antenna for maximum possible signal strength and quality. When the signal cannot be improved anymore, fix the dish on this position, and press the **BLUE** button for *Search* options and scan.

Highlight *Search*, press the **OK** button to start channel scan automatically.

4.1.9 Search



Your receiver will now perform an automatic channel search. When the process has been completed, all found channels will be stored and the receiver will switch to the first found channel. You are now ready to enjoy your new receiver.

NOTE: If no channels were found during the automatic channel scan, the receiver will return to *Installation guide* menu. Please select your language again and refer to chapter 7.1 for further instructions.

5. QUICK GUIDE FOR USING YOUR RECEIVER

We at STRONG understand that you can't wait to enjoy your new HD receiver. The following quick guide will make you familiar with the basic operation of this device. We do, however, advise you to read the full manual to get the best performance from your STRONG HD receiver.

To turn your receiver ON or to Standby, press  on the remote control.

Choose channels with  . Alternatively, you can also enter the channel number with the 0~9 buttons on the remote control or press **OK** in viewing mode to display the channel list.

The volume can be adjusted with   or with the dedicated **VOL+/VOL-** buttons.

6. OPERATION

In viewing mode, several features are available to make watching TV a true pleasure. This paragraph describes these features. Please also read chapter 7 to get familiar with the menu of your new receiver.

6.1 Changing channels







There are different ways to change channels with your new receiver.

- Via direct access
- Via the channel list
- Via the   buttons
- Via the  button
- Via the **CH+/CH-** buttons



6.1.1 Direct access

To gain direct access to a certain channel, simply enter its number with the 0~9 keys on the remote control. Channel numbers can be up to four digits long. Entering a number with less than four digits is possible. Just wait a few seconds and your receiver will switch to the selected channel.



6.1.2 Channel list

Press **OK** in viewing mode to display the channel list. Use   to highlight your channel of choice and press **OK** once to select the highlighted channel. The channel list is equipped with a *Find* function to make it easier to find channels. In the channel list, press **RED** and an alphabet banner will be displayed. Use     to select the first letter (or letters) of your channel of choice and select **OK** to confirm or just press . All channels beginning with the chosen letter(s) will now be displayed. Select the channel in the filtered list.

The following buttons are available in the channel list and in viewing mode:

-   If you have installed more than one satellite, toggle between their channel list. *All TV* will show all channels of all satellites in one long list.
- RED:** Opens an alphabet banner to quickly find a channel
- TV/R:** Toggles between TV and radio channels

6.1.3 Using the buttons

-  will switch to a higher channel.
-  will switch to a lower channel.

6.1.4 Using the CH+/CH- buttons

CH+ will switch to a higher channel.

CH- will switch a lower channel.

6.1.5 Using the button

Use the  button for switching between the two last viewed channels





6.2 Info Banner

At any time during viewing mode you can press the **INFO** button to get information about the current channel as well as the current and following programme*. Press **INFO** twice to view detailed info of current and following programmes and technical details about the current channel. Press **INFO** again or  to close the information.



You can change the on-screen duration of the info banner in the *System Setup* menu. Please refer to section **7.3.6.1 OSD Setting** for more details.

* Programme information is displayed when available. Availability depends on broadcast.

6.3 Selection of audio language

Some channels support a choice of different audio formats and/or languages. To select another audio stream, press **AUDIO** in viewing mode. A list with available audio streams will now be displayed. Use   to select a stream and confirm with **OK**. With the   buttons you can choose between *Mono, Mono left, Mono right* or *Stereo*









6.4 Teletext

Your receiver includes a fully featured Teletext. To access Teletext, press the **TEXT** button in viewing mode and use the **0~9** or buttons to select the number of the page you wish to see. Subpages (if loaded and available) can be selected with the   buttons. With *Auto* selected, the pages will rotate automatically. Press **TEXT** again or  to go back to viewing mode.

6.5 Subtitles

Some programmes support a choice of different DVB subtitle languages. Press the **SUB** button in viewing mode to display a list of available subtitle languages. Use   to select a subtitle language and confirm with **OK**.

6.6 EPG (Electronic Programme Guide)

The Electronic Programme Guide is a very useful function that allows you to watch programme schedules and information on screen. Press the **EPG** button to activate this guide. Use   to select a channel. In the programme list, use   to select or scroll through programmes to display programme information for the next/previous days. Press **OK** to read programme information. Press **GREEN timer** to book the selected programme for a wake-up timer. To change *time* or *day* in bigger steps, press **RED time** and use   to highlight the step options and **OK** to speed up selection. Options are: Step one by one, Steps in hours, steps in 24 hours.   will still control the channels. Press  to return to the main window.

NOTE: Availability of EPG data depends on broadcast.

Booking a programme from EPG reminder/wake-up on start time of program

Select a programme as described above. Press **GREEN** when you have selected a programme. This will lead you to the Timer (*Schedule*) menu. All details are already filled in for you. Save the timer by selecting *Save* and press **OK**. To display the list of booked events go to the main menu, system setup, Timer setting. You can also edit timers here. Please refer to section **7.3.6.1 Timer Setting** for more details.

6.7 Favourite channels

Use the **FAV** button to access your favourite channels lists and use ◀▶ to toggle between available favourite groups and general channel lists. Please refer to section 7.3 for details on how to create favourite lists.

7. MAIN MENU

Throughout the menu: Press **MENU** and select items by using the ▲▼ buttons. Press **OK** or the ▶ button to enter the items.

7.1 Installation menu

7.1.1 Installation

Here you can setup your dish and satellite parameters. Enter the menu via the *Installation* In this menu setting will be automatically stored upon exit without the need of confirming.

NOTE 1: If Germany is chosen as Region in the Welcome page for the first time installation, then a German channels pre-set list is available, it is Default set to *On*, assuming the satellite dish is pointed at Astra 19 East. Then select *Channel Search* and press **OK**, the next page will ask you to *Select your local channel*, which then will be stored on program number 3 in the pre-set list. The Local program becomes active only on certain times, at other moments the Main program is running. The receiver will automatically switch between the select number 3 program and the main program.

NOTE 2: Because the receiver does not know which program of the number 3 channel is active (Main or Local) at the moment of installation for the first time, it must probe shortly if there are automatic switching channels active or not. This may cause for a short time a black screen, while the pre-set channel list is updated accordingly. This will only happen 1x a group ("transponder") of channels is reached.

Antenna Connection

Enter here to select the type of satellite dish or antenna you have: Either a *fixed antenna* or a *motor antenna*

Satellite List

In this menu you can select the satellites for which you have a particular interest, like if they carry programmes which are especially aiming at your country. In the *satellite search* menu's, these satellites can be searched to obtain programs.

Select one or more satellite from the list to search with **OK**. A heart symbol will appear behind the name.

To deselect, press **OK** again.

In case you need to make manual changes to the satellites present in the default list:

To Edit the Satellite name and position press **RED**. Use the *numeric* buttons to enter characters. Confirm with **YELLOW**.

To Add a Satellite, press **GREEN**. Use the *numeric* buttons to enter characters to enter a new Satellite's name and position. Confirm with **YELLOW**.

To Delete a Satellite, select the Satellite from the list and press **BLUE**. Confirm the pop-up screen.

Antenna Setup

In this menu you can enter the Dish parameters, depending on the selection in **Antenna Connection** for *Fixed Antenna* or *Motor Antenna* and Satellites selected in the **Satellite List**

Satellite

Shows the Satellites selected in the **Satellite List**

Press **OK** to view a pull down list with the selected satellites

LNB Press ◀▶ or **OK** to show the list of LNB Types. The Universal LNB frequencies (09750/10600 MHz) are supported – the most used on the market.

SatCR LNB's are used for SatCR systems, mainly in apartment blocks. Enter the IF channel number according to the assigned (user band), then the corresponding centre frequency. If the system only supports one satellite, sat position is 1. The version of SatCR is either 1.0 or 2.0. Version 1.0 can have up to 8 different users, version 2.0 can have up to 32, it depends on the LNB used.

SatCR systems are usually installed by professional experts. An optional satellite splitter is required for multi-users.

NOTE: For SatCR use, DiSEqC and polarity should be disabled.

<i>Transponder</i>	Select a known transponder to help you find a satellite, or to check if the settings you've entered are correct. Use the signal intensity and signal quality bars to fine tune your dish, if needed.
<i>DiSEqC1.0:</i>	To select the correct port from up to 4 (if available) for the corresponding LNB. For committed DiSEqC switches only.
<i>DiSEqC1.1:</i>	To select the correct port from up to 16 (if available) for the corresponding LNB. Uncommitted DiSEqC switches in cascade can be used with this protocol.
<i>22KHz:</i>	<i>Auto</i> is the setting for a Universal LNB
<i>Polarity</i>	Options are: <i>Auto</i> , <i>H</i> for horizontal and <i>V</i> for vertical. It will switch the LNB power as required by the transponder list.

For universal and SatCR LNB's, the setting is best left on *Auto*

For Motor Dish only:

<i>LNB Freq:</i>	Press ◀▶ or OK to show the list of LNB types. Normal use for a motorized dish is the universal LNB (09750/10600 MHz) – the most used on the market. Select with ▲▼ and OK the LNB you are using
<i>Motor Type</i>	Options are DiSEqC 1.2 and GOTOX (Also known as USALS or DiSEqC 1.3). Depending on your motor drive, select the correct setting.

7.1.2 DiSEqC 1.2

DiSEqC 1.2 is a protocol for motor-driven dishes, the dish/motor-combination itself needs to be aligned due South (North for Southern hemisphere) at its reference position at 0°. It requires to manually search and store every satellite individually.

Refer to the manual of your motor-drive for more detailed information. Modern motor drives have usually also the capability of the enhanced DiSEqC 1.3 protocol, which would be preferred, since it can find satellite positions automatically, relative to a geographical location.

Move the motor to the right position for locking the signal like explained below.

<i>Satellite</i>	Select the Satellite you want to search for.
<i>Transponder</i>	Select a known transponder on the satellite to help you find it. Also use the signal intensity and signal quality bars to find the satellite.
<i>Position No.&Save Go to X</i>	Select on which memory position the found satellite should be stored. When just setting up the dish, move the motor to its reference point, at 0 degrees. Select <i>Reference</i> and press OK to move. Select and press OK to see a list with already stored satellites. Select a number from the list and press OK to move the dish to that position.
<i>Save</i>	Select <i>Save</i> and press continuously either ◀ or ▶, to move the dish to the position where you suspect the Satellite is. When found (for example, confirmed by a Signal on the bars), let go of the ◀ or ▶ button. With short presses on the ◀ or ▶ buttons, you can peak the dish. Then Press OK (while still on <i>save</i>). Confirm the position (already selected in <i>Go to X</i> to be stored.

NOTE: The movement of the Dish can be stopped by pressing **OK** or ⏪ on the RCU.

NOTE: The dish might get misaligned over time. Move the dish to its reference point at 0 degrees and select *Recalculation*. Confirm the pop-up to recalculate positions.

Limit Setup

To setup the limits the dish should not exceed when moving, in case of physical obstructions. Default is disable limit (not active). If needed, the motor can physically be brought to its 0° reference position, to align the dish south when in the northern hemisphere (or north for southern hemisphere) first.

To set the **West Limit**, use ◀▶ to select *West Limit*, then press shortly ◀ to move the dish West. Press ◀ again or **OK** when the limit is reached.

Press **OK** again. A pop-up message will confirm: West Limit is set.

To set the **East Limit**, use ◀▶ to select *East Limit*, then press shortly ▶ to move the dish East. Press ▶ again or **OK** when the limit is reached. Press **OK** again. A pop-up message will confirm: East Limit is set.

To disable the limits, select *disable limit*, then *limit setup* and press **OK**. A pop-up message will confirm: disable limit is set.

When all settings have been made, press ↵ to save the data and leave the window.

GotoX

(also known as DiSEqC 1.3 or USALS)

GotoX is an automated system for finding satellites with a motor driven dish. It is an enhancement of the DiSEqC 1.2 protocol, where it was still needed to manually search and store every satellite individually. With DiSEqC 1.3 every satellite position is automatically calculated for a defined geographical location on earth. Only this location is needed to be entered and stored in to the box, in conjunction with a GotoX capable motor drive, all (pre-installed) satellites can easily be found. The dish/motor-combination itself needs to be aligned due South (North for Southern hemisphere) at its reference position at 0°. Refer to the manual of your motor-drive for more detailed information.

LNB Frequency

Select the correct LNB which is placed in your Satellite Dish.

Motor Type

Select *GotoX* with the ◀▶ buttons.

Local Longitude

Find out the coordinates of the location where the dish is installed. Consisting of degrees on northern or southern hemisphere and eastern or western hemisphere.

When you first enter, choose *E* or *W* with the ◀▶ buttons.

Then use the 0 ~ 9 buttons to enter the coordinate.

Local Latitude

When you first enter, choose *N* or *S* with the ◀▶ buttons.

Then use the 0 ~ 9 buttons to enter the coordinate.

NOTE: The location setting only needs to be entered once and is valid for all satellites.

Delete All

Turns the entered Longitude and Latitude to 0.00

Motor Setting

To make a test with the moving dish if the selected satellites in the satellite list indeed can be found.

Limit Setup

To setup the limits the dish should not exceed when moving, in case of physical obstructions. Default is disable limit (not active). If needed, the motor can physically be brought to its 0° reference position, to align the dish South when in the northern hemisphere (or north for southern hemisphere) first.

To set the **West Limit**, use ◀▶ to select *West Limit*, then press shortly ◀ to move the dish West. Press ◀ again or **OK** when the limit is reached.

Press **OK** again. A pop-up message will confirm: West limit is set.

To set the **East Limit**, use ◀▶ to select *East Limit*, then press shortly ▶ to move the dish East. Press ▶ again or **OK** when the limit is reached.

Press **OK** again. A pop-up message will confirm: East Limit is set.

To disable the limits, select *Disable Limit*, then *Limit Setup* and press **OK**. A pop-up message will confirm: Disable Limit is set.

When all settings have been made, press ↵ to save the data and leave the window.

7.1.3 SatCR

SatCR LNB's are used for SatCR systems, mainly in apartment blocks. Enter the IF channel number according the assigned (user band), then the corresponding Centre Frequency. If the system only supports one

satellite, sat position is 1. The version of SatCR is either 1.0 or 2.0. Version 1.0 can have up to 8 different users, version 2.0 can have up to 32, it depends on the LNB and splitter used. SatCR systems are usually installed by professional experts. An optional satellite splitter is required for multi-users.

For SatCR use, DiSEqC and polarity should be disabled.

If a SatCR LNB is used, please refer to the manual of that LNB to obtain the technical data about User Bands numbers and corresponding frequencies.

NOTE: SatCR can only work in combination with an optional multi-output satellite splitter and a SatCR LNB, example STRONG type SRT L780 (max. 4 users). Note: SatCR cannot be combined with any other DiSEqC function. SatCR systems are mainly installed by professional experts.

<i>IF Channel</i>	Manual select: Select the User band ID number according to the specifications of your SatCR LNB. NOTE: Any SatCR LNB user in the chain needs a different Channel ID number.
<i>Centre Freq</i>	Manual select: Select the Centre Frequency according to the specifications of your SatCR LNB, corresponding with the correct IF Channel. NOTE: Any SatCR LNB user in the chain needs a different Centre Frequency.
<i>Sat Position</i>	Select the number assigned to the satellite by the installer. If you only use only one SatCR LNB, (for one satellite) then the number is 1.
<i>Version</i>	The version of SatCR is either 1.0 or 2.0. Version 1.0 can have up to 8 different users, version 2.0 can have up to 32, it depends on the LNB and signal splitter used.

Select **SAVE** to store the settings.

7.1.4 Single satellite search

To search just one satellite, selected before in the *Satellite List*.

Satellite: Select a satellite with ◀▶ to be scanned. You may have selected more than one satellite in the *satellite list*.

FTA Only: Press ◀▶ to select *No* to search for scrambled and free channels or *Yes* to search for Free to Air channels only.

NOTE: Scrambled channels can not be watched with this receiver.

<i>Scan Channel:</i>	Press ◀▶ to select <i>TV+Radio</i> , <i>TV Channel</i> or <i>Radio</i>
<i>Scan Mode:</i>	Use ◀▶ to select mode <i>auto scan</i> , <i>pre-set scan</i> or accurate <i>Scan</i> . This the default mode and should be used first.
<i>Auto Scan</i>	All stored transponders in the memory will be scanned.
<i>Pre-set Scan</i>	A few satellites carry a list with transponder parameters of all transponders on that satellite. It can be useful if the <i>auto scan</i> does not find an expected channel.
<i>Accurate scan</i>	This is a blind scan mode, in which the scan process probes certain frequencies to find unknow parameters of a Satellite.
<i>Network Search</i>	Use ◀▶ to select <i>Yes</i> or <i>No</i> . Some providers use more than one transponder to transmit their Pay-TV programmes. Select <i>Yes</i> and one of those transponders and it will find the corresponding transponders as well. Note: This is only applicable for scrambled channels, which can not be seen with this receiver.
<i>Tuner</i>	Not applicable for this receiver.

After configuring, select *Search* and press **OK** to start scanning with the selected settings.

Your receiver will now perform an (automatic) channel search with the scanning progress shown on screen. During the channel search you can quit the scan process with ⏏. When the process has been completed, all found channels will be stored. Press **OK** to confirm and leave the menu by pressing with ⏏ several times, or proceed to editing parameters by pressing ⏏ only once.

Multi-Satellites Search:

To scan more than one satellite in one go.

These must have selected before in the *Satellite List*.

The procedure is the same as for *Single Satellite Search*, except for the *Satellites* mentioned in the top line. All those will be scanned one after the other.

7.1.5 Transponder Edit Options

Scanning by transponder (Manual Scan)

Select *TP List* in the Installation menu.

The transponder list is shown for the in the top line selected satellite.

Search

Use the ▲▼ buttons to highlight the transponder you want to scan and press **OK** or **BLUE** for *Search*. A window with scanning settings will be displayed.

After configuring the settings press **OK** to start the scanning of the highlighted transponder. When the scan process has been completed, all new found channels will be added to the end of the channel list.

Options are:

FTA Only:

Press ◀▶ to select *No* to search for (scrambled and free) channels or {Yes to search for Free to Air channels only.

NOTE: Scrambled channels can not be watched with this receiver.

Scan Channel:

Press ◀▶ to select *TV+Radio*, *TV Channel* or *Radio*

Network Search

Use ◀▶ to select *Yes* or *No*. Some providers use more than one transponder to transmit their Pay-TV programmes. Select *Yes* and one of those transponders and it will find the corresponding transponders as well. Note: This is only applicable for scrambled channels, which can not be seen with this receiver.

7.1.5.1 Transponder List

Transponder Edit options

While in the *TP list* menu, you can use the coloured buttons to make changes.

The options below are now available.

Edit:

Press **RED** to edit the highlighted transponder. In the pop-up banner, change the transponder's parameters by using the ▲▼◀▶ and numeric buttons. Confirm changes with **OK** or cancel with ↵.

Add:

Press to add a new transponder. In the pop-up banner, enter the transponder's parameters by using the ▲▼◀▶ and the numeric buttons. Confirm the settings with **OK** or cancel with ↵. An existing TP cannot be stored again under the same satellite. A pop-up message will inform you if the transponder already exists in the list.

Delete transponder:

Press **YELLOW** to delete the highlighted transponder. Select *Yes* and press **OK** to confirm or ↵ to cancel.

7.1.5.2 Satellite Edit options

While in the *Satellite List* menu.

Edit:

Press **RED** to edit the focused satellite.

Edit the Satellite name and/or position. Use the *numeric* buttons to enter characters. Confirm with **YELLOW**.

Add:

Press **GREEN** to add a new satellite.

Use the *numeric* buttons to enter characters for a new Satellite's name and position. Confirm with **YELLOW**.

Delete:

To Delete a Satellite, select the Satellite from the list and press **BLUE**. Confirm the popup pop-up screen.

To Delete a Satellite, select the Satellite from the list and press **BLUE**. Confirm the popup pop-up screen.

7.2 TV Channel List and Radio Channel List

The procedure in the *Edit Channel* menus is equal for both the TV and Radio Channel List.

The description below assumes you're in the *TV Channel List*. However, you can use, **TV/R** to toggle between TV and Radio channel lists.

To edit your TV programme preferences (move, skip, lock, delete, sort, favourite or rename), please go to the *TV Channel List* menu. Use ▲▼ to highlight a channel and ◀▶ to select a satellite (if more than one available). Press ↵ repeatedly to leave the menu.

Set favourite programme

Your receiver allows you to store channels in up to 8 favourite lists. Due to the large number of channels available on satellite nowadays, this can be a very useful function.

1. Press the **FAV** button, then highlight the preferred programme and press **OK**

A *Favourite Group* window will pop up on screen with 8 possibilities. Please select one (or more) of them. A heart shaped symbol will appear and the programme is marked as a favourite. Press ↵ to return to the channel list for further selection.

2. Repeat the previous steps to select more favourite programmes.

3. To confirm and exit the menu, press ↵ twice.

Disable favourite TV or radio programme

Repeat step 1 described above and deselect the channel in its Favourite List. Save upon Exit.

View favourite programme

1. In normal viewing mode (no menu mode) press the **FAV** button to display a list of favourite programmes. In the favourite list, use ◀▶ to switch between available favourite lists.

2. Select your favourite programme by ▲▼ and press **OK** to switch to it.

3. Now in viewing mode you can select channels from the chosen favourite group only by pressing ▲▼. If you want to change to the main channel list, press **OK** in viewing mode and then press ◀▶ and select *All TV*.

Delete a TV or radio programme

1. To delete a programme in the *TV Channel List* menu press the **BLUE** button. A new window opens with options: *Sort, Edit, Delete*.

2. Select the programme you want to delete and press the **BLUE** button. A Cross sign will appear behind the channel selected for deletion. Press ↵ twice to and select *Yes* to confirm or select *No* to cancel.

3. More than one channel can be deleted in one go.

Skip TV or radio programme

1. Select the programme you want to skip and press the **GREEN** button.

2. Press **OK** to mark the programme to skip. The receiver will skip this programme while zapping between programmes in normal viewing mode (in channel list mode the skipped channels remain selectable).

3. Repeat the previous step to skip more programmes.

4. To confirm and exit the menu, press ↵ several times.

Disable skipping a TV or radio programme

Press the **GREEN** button and select the programme marked with the skip symbol, then use **OK** to unmark it. Confirm upon exit.

Move a TV or radio programme

1. Select the programme you want to move, then press the **YELLOW** button and press **OK** to mark the selected program. A move symbol will appear.

2. Press ▲▼ to move the programme to another position in the list.

3. Press **OK** again to confirm the new position.

4. Repeat the above steps to move more channels.

Locking programmes

You can lock selected programmes for restricted view.

1. Select the programme you want to lock, then press the **RED** button and press **OK**. The programme is now marked as locked.
 2. Repeat the previous step to select more programmes
 3. To confirm and exit the menu, press **↵** several times.
- To view the locked programme, you need to enter either the default password '0000' or your last set password. We recommend changing of the default password to one of your preferences. Please refer to chapter **7.3.6.1 Timer Setting Parental Lock** for more details.

Disable a locked TV or radio programme

Press the **RED** button on to select the programme marked with the lock symbol. Enter your password to enter the program. Enter your password again to remove the lock symbol. To store the changes and exit the menu, press **↵** several times.

Rename a TV or radio programme

1. Select the programme you want to rename and press **BLUE** to enter the Edit section. Then use **GREEN** and then select the programme you want rename. A pop-up appears.
2. In the pop-up select a character by using the **◀ ▶** buttons. Use the *numeric* buttons to enter characters. When you have entered the new name press **YELLOW** on the remote control to confirm the new name.
3. To store the changes and exit the menu, press **↵** several times.

Sort a TV or radio programme list

1. Press the **BLUE Edit** button and select the list you want to sort with the **◀ ▶** buttons.
2. Press **RED Sort** and select the option in which order the list should be sorted.

Options are:

<i>Name A-Z</i>	Sort on alphabetical order, beginning with A.
<i>Name Z-A</i>	Sort on alphabetical order, beginning with Z.
<i>Free/Scrambled</i>	Sort on type of channel, Free to Air first in list or scrambled channels first.
<i>Lock</i>	Put the locked channels first in the list.

Delete All channels

To delete all stored channels, select the *Delete All* function.

NOTE: To obtain channels again, you must search the satellites again from the *Installation* menu.

Channel Play Type while zapping in normal viewing mode:

<i>All</i>	All channels in the channel list Free and Scrambled will be accessible.
<i>Free</i>	Only the Free channels in the channel list will be accessible, scrambled channels will be ignored (skipped).
<i>Scrambled</i>	Only the Scrambled channels in the channel list will be accessible, free channels will be ignored.

NOTE: Scrambled channels cannot be watched with this receiver.

7.3 Multimedia

7.3.1 Media Player

Press **MENU** and select *Media Player* The menu provides the options, *Video Music* and *Image*. The unit supports USB devices with FAT and FAT32 format. Make sure your USB device is formatted correctly on a PC.

NOTE: STRONG cannot guarantee compatibility (operation and/or bus power) with all USB mass storage devices and assumes no responsibility for any loss of data that may occur when connected to this unit. With large amounts of data, it may take longer for the system to read the contents of a USB device. Some USB devices may not be properly recognized. Even when they are in a supported format, some files may not play or display depending on the content.

If there is no USB device plugged in, the options in the menu will be greyed-out. Only when a USB device is detected you can select between, *Video Music* and *Image*.

Select one of them, press **OK** to enter the file browser and select the file you want to play.

Video – supported video files in various formats and containers (MPG, MPEG, TS, VOB, MP4, H264 (no H265) max 1080x1920...)**

Music – supported file formats are MP3 and WMA*

Picture – supported file formats are JPG and BMP*

* STRONG cannot guarantee the playback of video files although extensions are listed here, as the correct playback depends on codec used, data bit rate and resolution as well. Please consult the STRONG Hotline in your country to get more details.

Video

Your receiver allows you to watch videos in the chosen folder. Choose a folder with video files for playing them. Not all video files can be played.

During playback you can use the playback control buttons, such as **II**, **▶** **◀** (while progress banner on screen), **■**, **◀◀**, **▶▶**, **◀◀◀** and **▶▶▶**. You can check the file details by pressing the **INFO** button in full screen mode.

To close the banner, press **INFO** again or **↵**. Use the **YELLOW]** button and select a chapter with **▲▼** you want to jump to, then press **OK** to confirm. With the **◀◀▶▶** buttons you can rewind or forward playback in x2, x4, x8, x16 and x24 speed. With the **◀◀▶▶▶** buttons you can jump to the previous/next video file.

This subtitle function with the **SUB** button only works for movies which have embedded subtitles

During playback, press (repeatedly) **SUB** to select a audio track.

Press **↵** to remove the pop-up.

For external subtitle files in.srt format, select those with the **GREEN** button.

Music

Select a music file (or file in a folder) and press **OK** to start playback.

During playback, following functions are available:

◀▶: Change the Audio volume

OK: Start playback of the selected file.

II: To pause/resume playback

■: To stop playback

◀◀▶▶: To rewind or forward playback. Press and hold the button. Release the button when you have reached the wanted position.

◀◀▶▶▶: Start playback of the previous/next file. Press repeatedly to step

↵: Press **↵** once if you want to leave the current folder. To get back to the *Multimedia* menu, press **↵** repeatedly

MENU: To go back to the main menu

Image

Your receiver allows you to watch a slide show with all available photos in the chosen folder. Choose a folder with photo files for the slide show.

In the *Image* mode following functions are available:

II To pause/resume slide show.

◀▶ During the slideshow, the orientation of the image can be rotated. **◀**To turn the photo counter clockwise.

↻ To turn the photo clockwise.

▶ To continue slideshow after **II** or rotation of image.

↵ To stop the slide show and return to the folder view.

↵ To get back to the *Multimedia* menu. Press **↵** again if you want to leave the *Multimedia* menu.

MENU To go back to the *Multimedia* menu, to select another media type.

Use the coloured buttons to build a playlist with preferred images to show and to edit image list.

7.3.2 System Setup

Press **MENU** and select *System Setup*. The menu provides options to adjust the system settings.

Press ▲▼ to select an option and press ► or OK to adjust the setting. Press ⏪ several times to exit the menu. Some menu items can only be entered by entering the password. Default is 0000.

7.3.3 Language

Press MENU and select *Option*. In this menu you can adjust the *Language, First Audio, Second Audio* and *Teletext*

Select an option and press ◀▶ to adjust the setting. Press ⏪ to exit the menu.

<i>Language:</i>	Select the preferred language for the On Screen Display.
<i>First Audio:</i>	Select the first preferred audio language for watching TV channels. If the language is not available, the <i>Second Audio</i> language will be used
<i>Second Audio:</i>	Select the second preferred audio language for watching TV channels. If the preferred <i>Second Audio</i> language is also not available, another available language will be used
<i>Teletext:</i>	Select the preferred Teletext letter character set.

7.3.4 TV System

Press MENU, then select *TV System*. The menu provides options to adjust the video settings. Press ▲▼ to select an option and ◀▶ to adjust the setting. Press ⏪ to exit the menu.

Video Resolution

If the video does not appear correctly, change the setting. These settings match the most common settings for HDMI.

480i	for NTSC system TV.
480p	for NTSC system TV.
576i	for PAL system TV.
576p	for PAL system TV.
720p_50 or 60:	for PAL or NTSC system TV.
1080i_25 or 30	for PAL or NTSC system TV.
1080p_50 or 60	for PAL or NTSC system TV.

NOTE: Some brands of TV's do not support 576p.

Aspect Mode

You can set the display format to available settings *Auto, 16:9, 4:3PS, (Pan&Scan)* and *4:3LB (Letterbox)*

<i>Auto</i>	With <i>Auto</i> select the TV connected with HDMI will auto-negotiate the optimal setting.
<i>16:9</i>	For 16:9 TV screens. All programmes will fill the full screen. Content formatted in 4:3 will be stretched.

4:3 Letterbox 4:3LB (Letterbox)

For 4:3 TV screens. The unit will display all content in its original aspect ratio. Programmes formatted in 16:9 will be presented with black bars on the top and bottom.

4:3 Pan&Scan 4:3PS (Pan&Scan)

For 4:3 TV screens. 16:9 content will have the extreme left and right portions cut off and presented full screen.

Digital Audio Output Select digital audio output mode. Settings affect both S/PDIF and HDMI outputs.

PCM – audio from any format will be converted to PCM Stereo format

RAW – audio from receiver will be send out in the original format

Using PCM mode is the best option if you do not have a TV or Digital Amplifier that are not able to process Multi audio.

7.3.5 Local Time Setting

Press MENU and select *Local Time Setting* The menu provides options to adjust the time and date settings. Press ▲▼ to select an option and ◀▶ to adjust the setting. Press ⏪ to exit the menu.

<i>Region</i>	Select the region or country in which you live. This will set the time offset from UTC automatically.
<i>UTC Usage</i>	Select <i>By Region</i> (the <i>Region</i> selection is valid), <i>User Define</i> (You may select your UTC Offset yourself) or <i>Off</i> (Time and Date setting are free to adapt.) However, the default <i>By Region</i> setting and the correct <i>Region</i> setting are usually sufficient. In case the Daylight Saving Time should not be delivered by the broadcaster, you can adapt it here.
<i>UTC Offset :</i>	Select the correct Time Zone in which you live.
<i>Summer Time</i>	You may adapt <i>On</i> or <i>Off</i> for Daylight Saving Time, should it not be delivered by the broadcaster.
<i>Date:</i>	Enter the date when <i>UTC Usage</i> is set to <i>Off</i> .
<i>Time:</i>	Enter the time when <i>UTC Usage</i> is set to <i>Off</i> .

7.3.5.1 Timer Setting

In this menu you can setup the schedule for automatic switching to the defined channels at a particular date/time.

Timers can be set directly from the EPG window or manually from this screen. Not set timers will be default *Off*

To enter a new timer manually, select an *Off* marked timer in the list and press **OK**.

Timer Mode Select *Once* for a onetime event, select *Daily* for each day, same time event. A free timer is default *Off*.

Timer Service Select *Channel* to wake up the receiver to view the channel.

Wakeup Channel Select the channel for this event. Use ◀▶ or **OK** for a pull down list to select.

Wakeup Date Select the date for the event.

On Time Enter the time to start the event.

Duration Enter the length of the event.

After all settings have been made, select *Save* to store the settings. Select *Cancel* to discard the settings.

To edit an already existing timer entry, select the entry in the list and press **OK**, then select and edit the item which you wish to change.

To delete an already existing timer entry, select the entry in the list and press **OK**, then select and set *Timer Mode* to *Off* and select *Save* to store.

Exit the screens with **↵**.

Parental Lock Set the age limit for a viewer if the viewer is underage. These only functions if a broadcaster sends an age-signalling for the current programme. You can only enter the Parental Lock menu by entering your password. The default password **0000**

Menu Lock Select either *On* or *Off*. When *On* many menu items can only be accessed after entering the password.

Channel Lock Set to *Off*, channels selected as *Lock* in the *Edit Channel* menu, are all accessible without entering the password. When selected *On*, these channels are blocked and need the password to be entered.

New Password To change the default password from **0000** to another password like you wish, select this option. Enter the new password.

Confirm Password Re-enter your new password to confirm.
Make a note off the new password.

OSD Setting OSD means On Screen Display, all the graphics you will see on screen.

OSD Timeout Set the time (in seconds) the program banner will be shown on screen, when switching channels.

OSD Transparency Set the amount of transparency the OSD (banners and menu) will have, superimposed on the running program. 40% is the most transparent option.

Favourite

Here you can rename the default names of the Favourite lists. For example: Movies or Music. Or even the names of users of the unit with their own dedicated channels. Select the list name you want to edit and press **OK**. Use the pop-up keyboard to change the name and select **BLUE (OK)** to confirm.

Audio Description setting

AD. For the visually impaired, a narrator can describe the actions happening on screen with a dedicated additional audio track, mixed with the original audio track. This service is provided by some broadcasters and is therefore subject to availability.

AD Service Select *On* if you wish to use the service by default on all channels which may carry an AD track.

Use AD as default Select *On* if you wish to use the service by default on all channels which may carry an AD track.

AD Volume Offset Set the balance of volume the AD audio track will have, mixed with the original audio track.

Auto Standby

This feature is implemented for power saving. The receiver will turn to Standby automatically if no command from the remote is received for the selected time period. Default is 3 hours. It can also be turned *Off*. **NOTE:** If there are timers running, the auto standby function will be disabled for the booked time.

Tools

This menu provides some technical options for the working of the unit.

Information Read the technical details of your receiver, like model number, Software/Hardware version and serial number. This information could be asked during a service call or repair request.

Factory Setting

Reset your receiver to the default factory settings.

Enter your password or the default password **0000**, select *Yes* and press **OK** to confirm.

The receiver will reboot and start with the *First Installation* menu.

WARNING: A factory reset will permanently delete all your personal settings, timers and stored channels. Please consider this before you perform a factory reset.

Upgrade by USB

Download the required update file for your receiver model from the support page on our website www.strong-eu.com or contact your local dealer.

Unzip the file on your computer, if necessary, and copy it to root folder of your USB storage device. The USB device must have been formatted in FAT32 on a PC.

Connect the USB storage device to the USB port of the receiver. Press **MENU** and select *Tools*, then *Upgrade By USB* to update the software select at *Upgrade Mode* the option *Allcode*. At *Upgrade File* select the correct upgrade file, the file has the extension *abs*.

Then select *Start*, and press **OK** to initiate the upgrade process. An attention banner will now be displayed. Press **OK** to confirm *Yes* the update (or *No* to cancel it). The update process will take some time. After the update process has been completed the receiver will restart and then show the first channel in the TV list. You can now safely remove the USB device, and then remove the update software from the device (at the PC), to prevent accidental updating again.

WARNING: NEVER power off the receiver or remove the USB device during the software update process. Doing so might cause irreparable damage to your receiver and will void your warranty.

NOTE: In certain instances it can be advised on the website to upgrade the unit with the *Maincode* option in stead of *Allcode*.

The *bootlogo* and *Radioback* are for Strong internal use.

7.3.6 Dump channel list

7.3.6.1 DB Management

This menu allows you to save and reload the channel Data Base of your receiver from/to a USB-device. This very convenient feature enables you to save your personal settings like Channel-, Favourite-, Sat- and TP-lists on an USB storage device and load them back to the receiver later.

Write to USB Dump Channel list

Select *Update Mode*, then *Dump channel list* and *Start* and press **OK** to make a backup of the data base, including channels and user set data. An.udf file with the current time, date (day, month, year), will be created on the USB device. When the database has been successfully stored a message will be displayed on screen. Press **↵** to leave the menu.

7.3.6.2 Load from USB Update channel List

Select *Update Mode*, then *Update channel list*. Select the file at *Upgrade File* you want to restore to. Use **◀▶** for displaying the available database files (if any stored before). The.udf files are shown with their built time, date (day, month, year) Select the file you want to load and then select *Start* to load the file. When the database has been successfully loaded the receiver will reboot and switch automatically to the first stored channel.

Remove USB safely Use this option to safely remove your USB device from the unit. It will prevent loss of data and prevent hardware damage to such a device. This procedure is comparable working with a personal computer.

8. A.1 TROUBLESHOOTING

There may be various reasons for abnormal operation of the receiver. Please check the receiver according to the procedures shown below. If the receiver does not work properly after checking it, please contact your local Service line or STRONG dealer. Alternatively, you can send a support mail via our website: www.strong-eu.com . NEVER open or disassemble your receiver. This may cause a dangerous situation and will void the warranty.

Problem	Possible cause	What to do
The standby indicator does not light up	The mains lead is unplugged/the multipoint connector is switched off.	Check the mains lead/switch the multipoint connector on.
No picture	The receiver can't receive signal.	Check the antenna cable, replace the cable, or connect the cable to the receiver tightly.
	Incorrect values of some tuner parameters.	Set the values of tuner parameters correctly in the Installation menu.
	Wrong direction of the dish.	Check signal strength and adjust your dish correctly.

Problem	Possible cause	What to do
No picture or sound on TV	The input is not selected on your TV.	Switch to the correct TV input.
	The TV is not connected to the mains. Bad cable connection.	Check the mains lead. Firmly plug in the cables between the receiver and TV.
	Audio muting.	Press the ! button.
	TV power off.	Turn the TV on.
Scrambled channel message	The channel is scrambled.	Select an alternative channel.
No response to remote control	The receiver is off.	Plug in and turn on the plug.
	The handset is not aimed correctly.	Aim the handset at the IR sensor.
	The IR sensor is obstructed.	Check for obstructions.
	The handset batteries are exhausted.	Replace the handset batteries.
Password forgotten	The default password is 0000	Contact the local Service Hotline or send an email to our support via www.strong-eu.com
The external USB HDD does not start.	The power consumption is too high.	Connect an extra power supply adapter to your USB HDD device.
The receiver switches to standby automatically.	The Auto Standby function is activated and has reached the set time (default 3h).	Set the power down time or disable it in the System Setup > Auto Standby menu.

9. A.2 SPECIFICATIONS

Demodulator

Demodulation:

QPSK, 8PSK

Input symbol rate:

DVB-S QPSK: 2 ~ 45 Ms/s

DVB-S2 8PSK/QPSK: 2 ~45 Ms/s

FEC decoder:

Auto, 1/2, 2/3, 3/4, 5/6, 7/8 in DVB-S mode

1/2, 3/5, 2/3, 3/4, 4/5, 5/6, 8/9, 9/10 in DVB-S2 mode

3/5, 2/3, 3/4, 5/6, 8/9, 9/10 in 8PSK mode

Video Decoder

Video Format

Mpeg1/2, H264 max 1080x1920...)

Input rate:

Max. 20 Mbit/s

Aspect ratio:

16:9, 4:3 Pan&Scan, Letterbox, Auto.

Video resolution:

480i, 480p, 576i, 576p, 720, 1080i, 1080p, 50/60Hz.

Audio Decoder

Audio decoding:

MPEG-1/2 Layer 1 & 2, AC3, Dolby and Dolby Plus

Audio mode:

Mono L/R, Stereo,

Audio Support:

E-AC3, Dolby Digital, Dolby Digital Plus*

Sampling rate:

32, 44.1, 48 kHz

* Dolby Digital, Dolby Digital Plus and the double-D symbol are registered trademarks of Dolby Laboratories

Tuner

Type1:

F Type, IEC169-24, Female

Input frequency range:

950 – 2150 MHz

RF impedance:

75 Ohm unbalanced

Signal level:

-65 to -25 dBm

LNB power:	13/18 V DC (+/- 5%), max. 0.5 A, overload protected
Switch versions:	DiSEqC 1.0, 1.1
LNB options:	Universal, SatCR (max. 8 users)
Motor drive options:	DiSEqC 1.2, GotoX (DiSEqC 1.3)

System & Memory

Main processor:	Ali M3510G
Flash memory:	8 MB
System memory:	64 MB

Multimedia

Video playback:	Supported in various formats and containers (MPG, MPEG, TS, VOB, MP4, H264 (no H265) max 1080x1920.)*
Audio playback:	MP3, Flac*
Picture view:	JPG, BMP*

* STRONG cannot guarantee the playback of files although extensions are listed, as it depends on codec used, data bit rate and resolution (all MPEG codec formats are supported).

Connectors

SAT IN
USB 2.0 port: 5 V/500 mA (max.) supported
HDMI
TV SCART (CVBS, Audio L/R)
mm Audio L/R
S/PDIF (coax.)
Power adapter (12 V, 1.5 A)

General Data

Power supply:	AC 100 – 240 V ~ 50/60 Hz (wall adapter)
Input voltage:	DC 12 V 1.5 A
Power consumption:	< 18 W
Power consumption in standby:	max. 0.65 W
Operating temperature:	0 ~ +40 °C
Storage temperature:	-10 ~ +70 °C
Operating humidity range:	10 ~ 95% RH, Non-condensing
Size (W x D x H) in mm:	164 x 86 x 35 incl. feet + connectors
Weight in kg:	260g