



Questo manuale d'istruzione è fornito da [trovaprezzi.it](https://trovaprezzi.it). Scopri tutte le offerte per [TCL 30E](#) o cerca il tuo prodotto tra le [migliori offerte di Cellulari e Smartphone](#)

**DISPL <sup>AY</sup>  
GREATNESS**

**TCL30<sub>E</sub>**

## Note:

This is a user manual for 61271.

There may be certain differences between the user manual description and the phone's operation, depending on the software release of your phone or specific operator services.

## Help

Refer to the following resources to get more FAQ, software, and service information:

### Consulting FAQ

Go to [www.tcl.com/global/en/service-support-mobile/faq.html](http://www.tcl.com/global/en/service-support-mobile/faq.html)

### Finding your serial number or IMEI

You can find your serial number or International Mobile Equipment Identity (IMEI) on the packaging materials. Alternatively, choose **Settings > System > About phone > Status > IMEI information & Device serial number** on the phone itself.

### Obtaining warranty service

First follow the advice in this guide or go to [www.tcl.com/global/en/service-support-mobile.html](http://www.tcl.com/global/en/service-support-mobile.html). Then check hotlines and repair centre information through [www.tcl.com/global/en/service-support-mobile/hotline&service-center.html](http://www.tcl.com/global/en/service-support-mobile/hotline&service-center.html)

### Viewing legal information

On the phone, go to **Settings > System > About phone > Legal information**.

# Table of Contents

<b>1</b>	<b>Basics .....</b>	<b>4</b>
1.1	Device overview .....	4
1.2	Getting started.....	7
1.3	Home screen.....	9
1.4	Text input.....	17
<b>2</b>	<b>Multimedia applications .....</b>	<b>19</b>
2.1	Camera .....	19
2.2	Gallery.....	23
2.3	Music.....	27
<b>3</b>	<b>Apps and features .....</b>	<b>28</b>
3.1	Phone.....	28
3.2	Contacts.....	33
3.3	Messages.....	36
3.4	Calendar.....	38
3.5	Clock .....	39
3.6	Calculator .....	42
3.7	TCL apps.....	43
3.8	Other applications .....	43
3.9	Google applications.....	43
<b>4</b>	<b>Settings.....</b>	<b>45</b>
4.1	Wi-Fi.....	45
4.2	Bluetooth .....	46
4.3	SIM card & mobile network.....	47
4.4	Connections .....	47

4.5	Home screen & lock screen.....	51
4.6	Display .....	51
4.7	Sound & vibration.....	52
4.8	Notifications.....	53
4.9	Button & gestures .....	53
4.10	Advanced features .....	54
4.11	Smart Manager .....	54
4.12	Security & biometrics .....	55
4.13	Location.....	55
4.14	Privacy .....	56
4.15	Safety & emergency.....	56
4.16	Apps .....	56
4.17	Storage.....	56
4.18	Accounts .....	56
4.19	Digital Wellbeing & parental controls.....	57
4.20	Google.....	57
4.21	Accessibility.....	57
4.22	System .....	57
<b>5</b>	<b>Making the most of your phone.....</b>	<b>59</b>
<b>6</b>	<b>Troubleshooting.....</b>	<b>60</b>
<b>7</b>	<b>Specifications .....</b>	<b>67</b>
<b>8</b>	<b>Accessories.....</b>	<b>69</b>
<b>9</b>	<b>Licences .....</b>	<b>70</b>
<b>10</b>	<b>Disclaimer.....</b>	<b>70</b>

# 1 Basics

## 1.1 Device overview



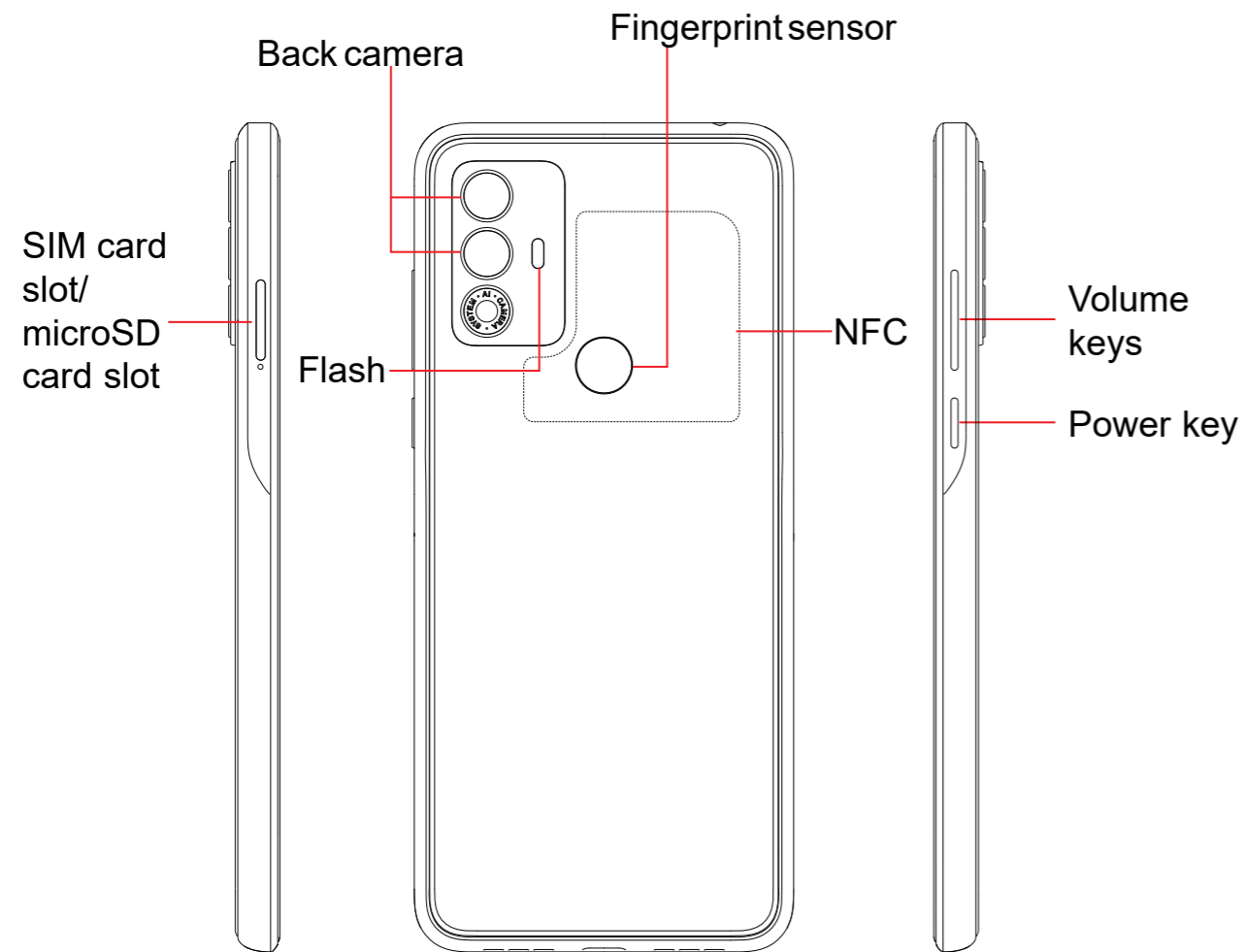

### < Back button

- Touch to go back to the previous screen, or to close a dialog box, options menu, the notification panel, etc.

### ○ Home button

- From any application or screen, touch to return to the Home screen.
- Touch and hold to turn on Google Assistant. You can get help such as getting directions and restaurant information based on the content detected on the screen.

### ≡ Recent apps

- Touch to view applications you've recently accessed

### ○ Power key

- Press: Lock the screen/Light up the screen.
- Press and hold: Show the popup menu to select from **Power off/Restart/Aeroplane mode/Cast**.
- Press and hold the **Power** key and **Volume down** key to take a screenshot.
- Press and hold the **Power** key for at least 10 seconds to force reboot.
- Double-press the **Power** key to open the camera.

### ○ Volume Keys

- In call mode, adjusts the earpiece or headset volume.
- In Music/Video/Streaming mode, adjusts the media volume.
- In general mode, adjusts the media volume.
- Mutes the ringtone of an incoming call.
- In camera preview mode, press the **Volume up** or **down** key to take a photo or press and hold to take burst shots.

## 1.2 Getting started

### Setting up

#### Inserting or removing the SIM/microSD card

- 1 Insert the provided SIM pin into the hole.
- 2 Pull out the SIM tray.
- 3 Place the SIM card or microSD card into the tray slot and carefully close the SIM tray.

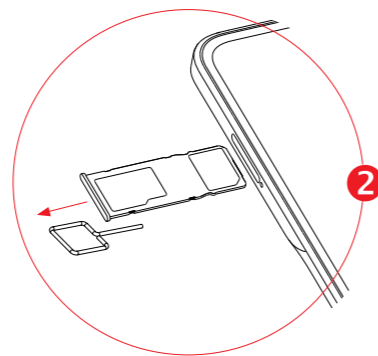
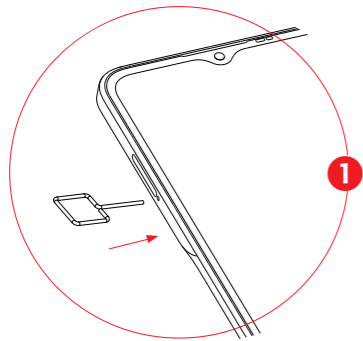

Single-SIM devices only

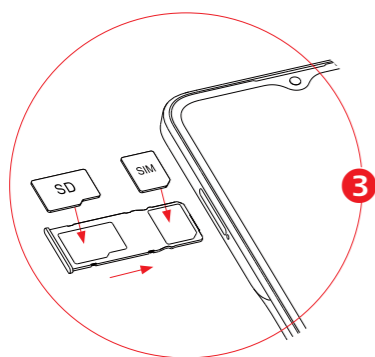

Dual-SIM devices only

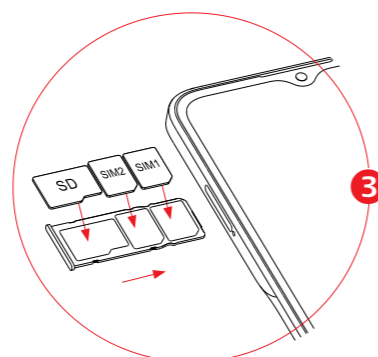



You must insert your SIM card to make phone calls. You do not need to power off your phone before inserting or removing the SIM card as this phone supports hot swap.

 Your phone only supports nano-SIM cards. Do not attempt to insert other SIM types; otherwise this may cause damage to your phone.

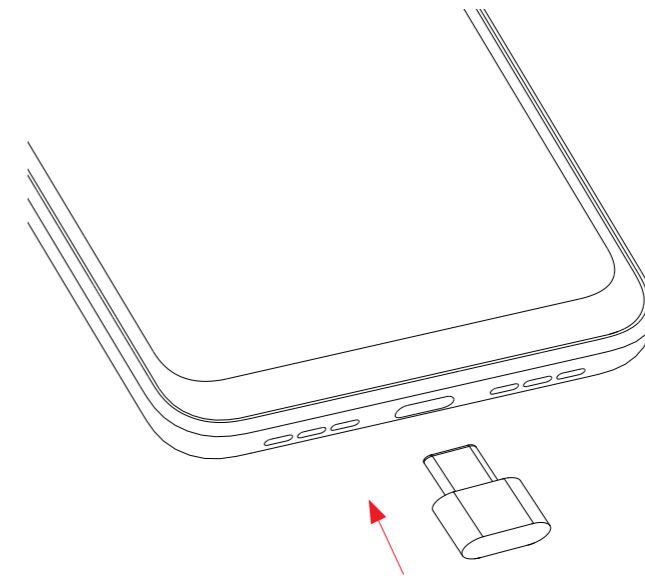
### Charging the battery



You are advised to fully charge the battery (  ). Charging status is indicated by a percentage displayed on screen while the phone is powered off. The percentage increases as the phone is charged.

 To reduce power consumption and energy waste when the battery is fully charged, disconnect your charger from the plug; switch off Wi-Fi, GPS, Bluetooth or background-running applications when not in use; reduce the backlight time, etc.

### Powering on your phone

Hold down the **Power** key until the phone powers on, unlock your phone (Swipe, PIN, Password, Pattern, Fingerprint or Face unlock) if necessary and confirm. The Home screen is displayed.

If you do not know your PIN code or forget it, contact your network operator. Be sure to keep your PIN code secure.

### Powering off your phone

Press and hold the **Power** key until options appear, then select **Power off**.

## 1.3 Home screen

You can bring all the items (applications, shortcuts, folders and widgets) you love or use most frequently to your Home screen for quick access. Touch the **Home** button to switch to the Home screen.

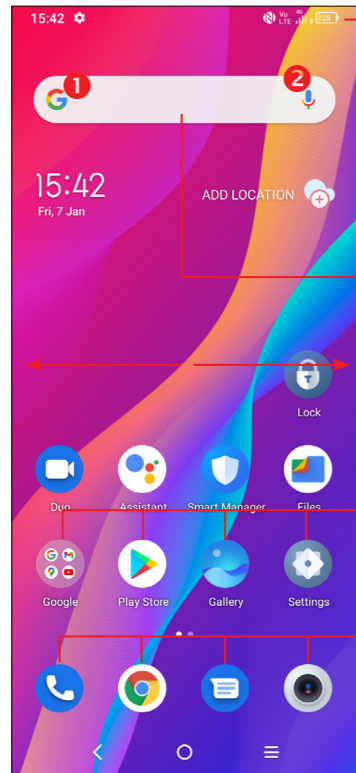

### Status bar

- Status/Notification indicators
- Touch and drag down to open the notification panel

### Search bar

- Touch 1 to enter text search screen
- Touch 2 to enter voice search screen

Touch an icon to open an application, folder, etc.

### Favourite tray applications

- Touch to enter the application.
- Touch and hold to move or remove applications.

The Home screen is provided in an extended format to allow more space for adding applications, shortcuts etc. Slide the Home screen horizontally left and right to get a complete view.

## Using the touchscreen

**Touch**

To access an application, touch it with your finger.

**Touch and hold**

To enter the available options for an item, touch and hold the item. For example. Select a contact in Contacts and touch and hold it. An options list will then appear.

**Drag**

Place your finger on the screen to drag an object to another location.

**Slide/Swipe**

Slide the screen to scroll up and down the applications, images, and web pages. You can slide the screen horizontally too.

**Flick**

Similar to swiping, but flicking makes it move quicker.

**Pinch/Spread**

Place two fingers on the screen surface and draw them apart or together to scale an element on the screen.

**Rotate**

Automatically change the screen orientation from portrait to landscape by turning the phone sideways to have a better screen view.

## Status bar

From the status bar, you can view both phone status and notification information.

Drag down the status bar to view notifications and drag again to enter the quick settings panel.

Touch and drag up to close it. When there are notifications, they can be accessed by touching them.

## Notification panel

When there are notifications, touch and drag down the Status bar to open the Notification panel to read more detailed information.

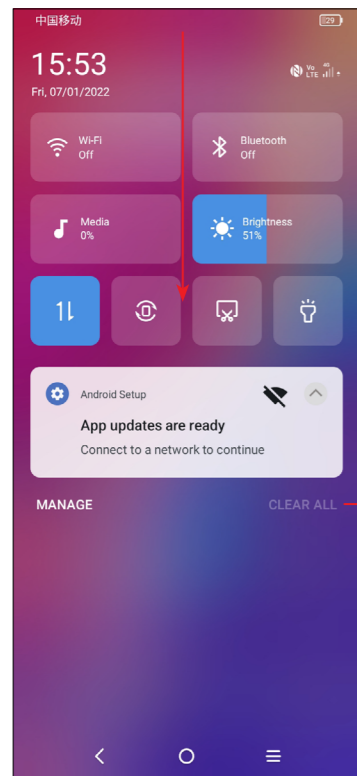

Touch to clear all event-based notifications (other ongoing notifications will remain).

## Quick settings panel

Touch and drag down from the top of the screen to open the Quick settings panel.

You can enable or disable functions or change modes by touching the icons.

Touch the **Edit** icon  to customise your Quick settings panel.

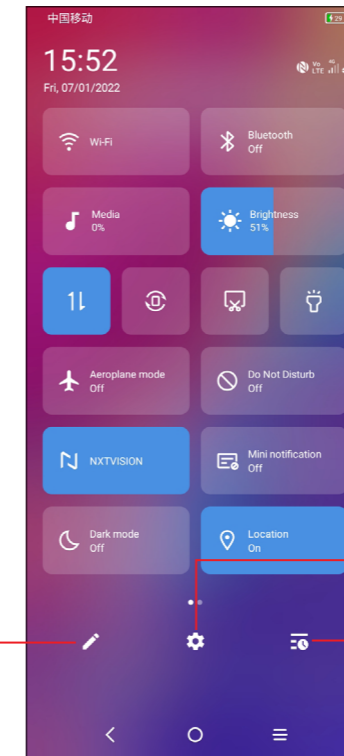

Touch to customise your Quick settings panel.

Touch to access Settings, where you can set more items.

Touch to see notification history.

## Lock/Unlock your screen

To protect your phone and privacy, you can lock the screen with a pattern, PIN, password, fingerprint or face.

To create a screen unlock pattern, touch **Settings > Security & biometrics > Screen lock, Fingerprint or Face unlock**.

## To lock the phone screen

- If your phone remains inactive for a period of time, it will automatically lock the screen and enter sleep mode to save power. Go to **Settings > Display > Sleep** and select a screen timeout period.
- You can also manually lock the screen by pressing the **Power** key once.

## To unlock the phone screen

Press the **Power** key once to light up the screen, swipe up and unlock the screen with the method you have set.



## Enter a password to unlock the screen

Once the screen is turned on, swipe up from any position on the screen to display the password input panel. Then enter your lock screen password.

## Use pattern unlock

Draw the same pattern you have set to unlock the screen.

## Use Face unlock

- From the app list, touch **Settings > Security & biometrics > Face unlock**. Before using the face key, you need to set a pattern/PIN/password.
- Hold your phone 20-50 cm from your face. Position your face in the square shown on the screen. For best results, we suggest that the face key is enrolled indoors and away from direct sunlight.
- Enable Face unlock when your screen turns on, otherwise you will have to swipe up on the screen first of all.

## Use Fingerprint unlock

Touch the fingerprint sensor (**Settings > Security & biometrics > Fingerprint**) with an enrolled finger to unlock the screen.

## Personalising your Home screen

### Add

You can touch and hold a folder, an application or a widget and drag the item to your preferred Home screen.

### Reposition

Touch and hold an item and drag it to the desired position and then release. You can move items both on the Home screen and the Favourite tray. Hold the icon on the left or right edge of the screen to drag the item to another Home screen.

### Remove

Touch and hold the item and drag it up to the top of the ⊖ remove icon, and release after it turns red.

### Create folders

To improve the organisation of shortcuts or applications on the Home screen and the Favourite tray, you can add them to a folder by stacking one item on top of another. To rename a folder, open it and touch the folder's title bar to input the new name.

### Wallpaper customisation

Touch and hold an empty area on the Home screen, then touch **Wallpapers** to customise wallpaper.

## Widgets and recently used applications

### Consult widgets

Touch and hold the empty area in the Home screen, then touch **Widgets** to display all widgets.

Touch the selected widget and slide it to move to your preferred screen.

### Consult recently used applications

To consult recently used applications, touch the **Recent apps** button. Touch a thumbnail in the window to open the application.

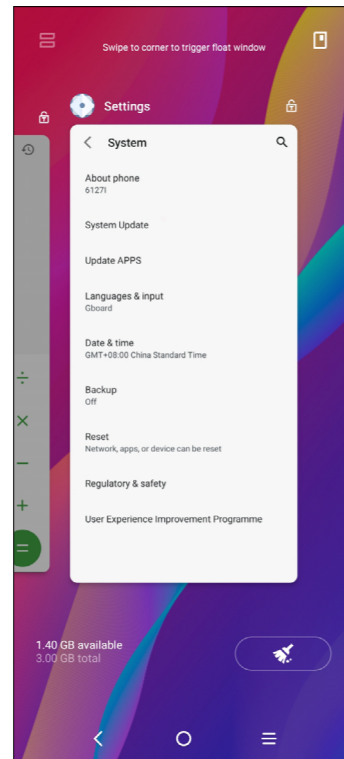

Touch one thumbnail and slide it up to close the application, slide it right/left to switch between the applications.

Touch  at the bottom of the screen to close all the running applications.

## Volume adjustment

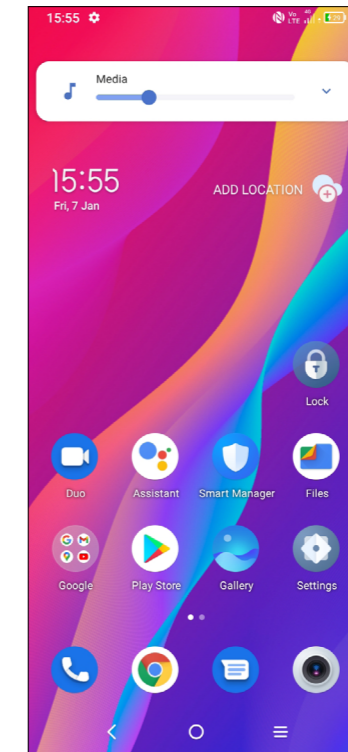

Press the **Volume** key to adjust the Media volume.

Touch the  icon to adjust Media, Ring, Alarm and Notification volume.

## 1.4 Text input

### Using the Onscreen Keyboard

#### Onscreen Keyboard settings

Touch **Settings > System > Languages & input**, touch the Virtual keyboard you want to set up and a series of settings will become available.

#### Adjust the Onscreen Keyboard orientation

Turn the phone sideways or upright to adjust the onscreen keyboard orientation. You can adjust it by changing the settings (Touch on/off **Settings > Display > Auto-rotate screen**).

- **Android keyboard**

Touch to switch between "abc/Abc" mode; Touch and hold to switch to "abc/ABC" mode.

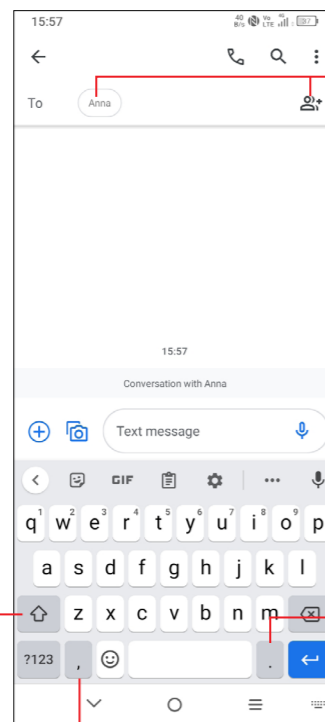

Enter numbers or select from contacts.

Touch and hold to select symbols.

Touch and hold to show more options.

### Text editing

You can edit text which you have entered.

- Touch and hold or double touch within the text you want to edit.
- Drag the tabs to change the amount of text to edit.

You can also insert new texts if preferred

- Touch where you want to type, or touch and hold a blank area. The cursor will blink and the tab will appear. Drag the tab to move the cursor.
- If you have cut or copied any text, touch the tab to show the **Paste** and **Select all** option which allows you to complete pasting immediately.

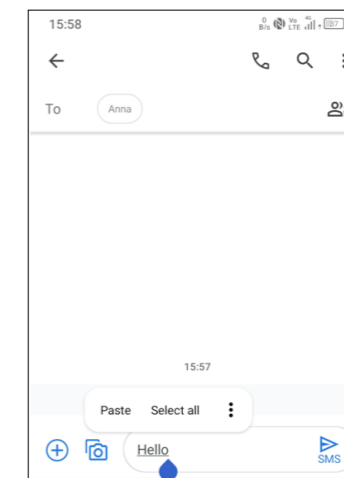

## 2 Multimedia applications

### 2.1 Camera .....



Before using the camera, make sure that you remove the protective lens cover to avoid it affecting your picture quality.

#### Launch Camera

There are multiple ways to open the Camera app.

##### From the Home Screen

From the home screen, touch **Camera** .

##### From the Lock Screen

When the screen is locked, press the Power key once to light up the screen, then swipe left on the camera icon in the lower right corner to open the camera.

##### Using a shortcut key

Simply double-press the **Power** key to open the camera.

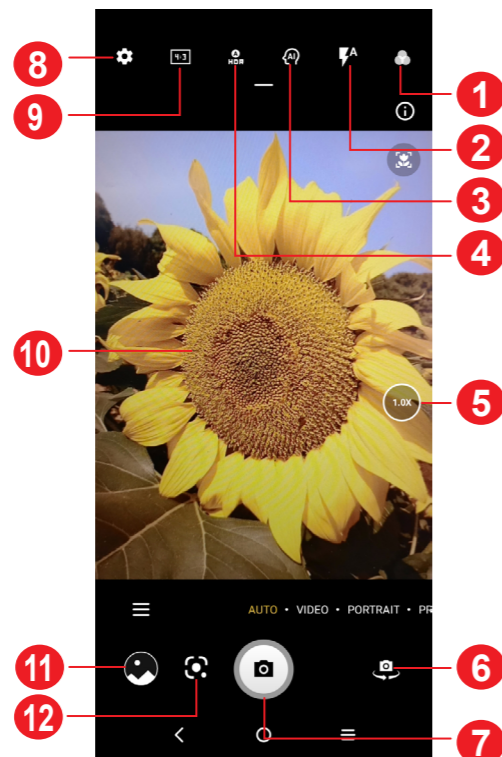

1 Select filter

2 Flash mode

Touch to turn on/off the camera flash

**WARNING:** Keep a safe distance when using the flash. Do not point the flash toward people's or animals' eyes.

3 AI scene detection

4 Take HDR photos

5 Zoom in/out

6 Switch between front/back camera

7 Take a photo

8 Touch to access settings

9 Picture size

10 Pinch fingers together to zoom out, or spread fingers apart to zoom in

11 View the photos or videos you have taken

12 Google Lens

#### Google Lens<sup>(1)</sup>



Google Lens is a free tool that can help you to:

- Copy text
- Search for similar products
- Identity plants and animals
- Discover books & media
- Scan codes



...and more.



<sup>(1)</sup> Your phone must also be connected to a network.

## To take a photo



The screen acts as the viewfinder. First, position the object or landscape in the viewfinder, touch the screen to focus if necessary. Touch  to capture. The photo will be automatically saved. You can also touch and hold  to take burst shots.

## To take a video

Touch **VIDEO** to change the camera mode to video. Touch  to start video recording. Touch the left part of this icon  to take a picture during video recording.

Touch the right part of this icon  to pause video recording and touch  to continue. Touch  to stop recording. The video will be automatically saved.

### Further operations when viewing a photo/video you have taken



- Slide left or right to view the photos or videos you have taken.
- Touch , then Gmail/Bluetooth/MMS/etc. to share the photo or video.
- Touch **Back button**  to return to **Camera**.

## Modes and settings



### Modes

Slide left or right to switch between modes.

- **AUTO:** Auto is the default mode for Camera.
- **VIDEO:** Touch to access video mode.
- **PORTRAIT:** Touch to create a depth of field effect. You can compose an image that highlights your subject while producing a gorgeously blurred background.
- **PRO:** Pro camera mode lets you fine-tune parameters and gives you full control over ISO, WB exposure time, aperture, shutter speed and so on.
- **PANO:** Touch to turn on the panorama function. Touch the shutter button to start taking a panoramic photo and move the phone steadily along in the direction indicated by the onscreen line. Once the slots are filled, the photo will be automatically saved. If the slots are not fully filled, touch the shutter button again to save the photo.

- **MORE:** By selecting , you can access more modes. These modes can be moved to the main screen by touching . **Settings**

Touch  to set more options:

- **Photo size:** Touch to select photo size.
- **Video quality:** Touch to select video progressive scan output and definition.
- **Calorie detection** <sup>(1)</sup>: Turn on  to detect the calorie content of a captured object.
- **Smart guideline** <sup>(1)</sup>: Touch to turn on/off. This feature provides AI-powered facial detection and composition guides for portrait shots. It only works when using the main camera.
- **Volume button function:** Touch to customise the Volume button to either Shutter, Zoom or Volume when using camera.
- **Gesture to capture:** Touch to turn on/off. Once the palm gesture feature is activated, show your palm to the front camera and the device will automatically take a photo or video after few seconds.
- **Storage:** Touch to choose between phone and SD card storage when an SD card is inserted. The default is phone storage.
- **Save location information:** Turn on  to tag photos and videos with your location. This option is available when the GPS location service is enabled.
- **Shutter sound:** Touch to turn on/off shutter sound when capturing.
- **Watermark:** Touch to turn on/off Watermark.
- **Reset settings:** Touch to reset the camera to its factory default settings.

<sup>(1)</sup> Only available when the AI scene detection is turned on.

## 2.2 Gallery .....



Gallery acts as a media player for you to view photos and play videos. In addition, a set of further operations to pictures and videos are available for selection.

To view the photos you have taken, touch  from the Home screen.

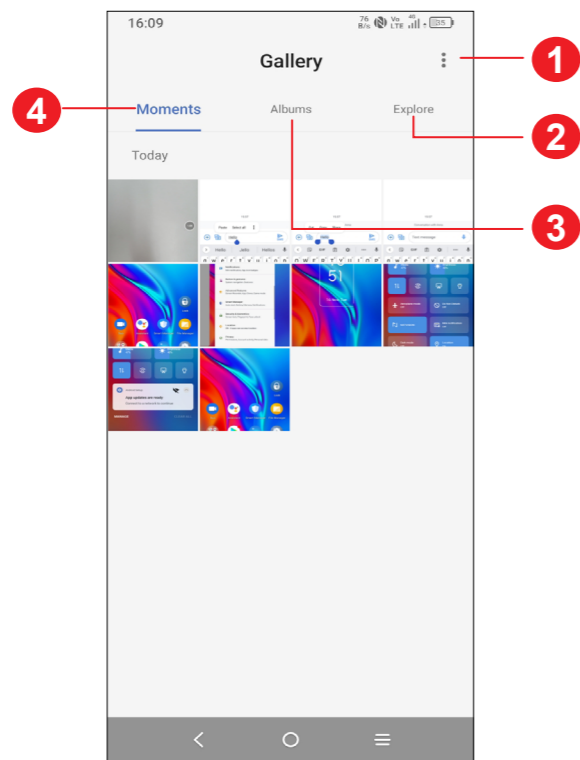

1 Touch to access more options

2 **Explore**

Explore collects photos into groups making them more easy to find

3 **Albums**

Photos, videos, screenshots, etc. are all automatically grouped in Albums

4 **Moments**

View the photos/videos you have just taken

## Working with pictures

You can work with pictures by rotating or cropping them, sharing them with friends, setting them as a contact photo or wallpaper, etc.

Find the picture you want to work on, and touch the picture in the full-screen picture view.





• Touch  to share the picture.

• Touch  to edit the picture.

 Choose picture effect.

 **Crop, Rotate, or Mirror** the picture.

 Draw the picture.

 Add text.

 Adjust the picture colour.

• Touch  to set the picture as your favourite.

• Touch  to delete the picture.

• Touch  **Set as** to set the picture as a Contact photo or Wallpaper.

## Album management

When there are many pictures and videos, you can manage your albums for convenient viewing.

- Create an album

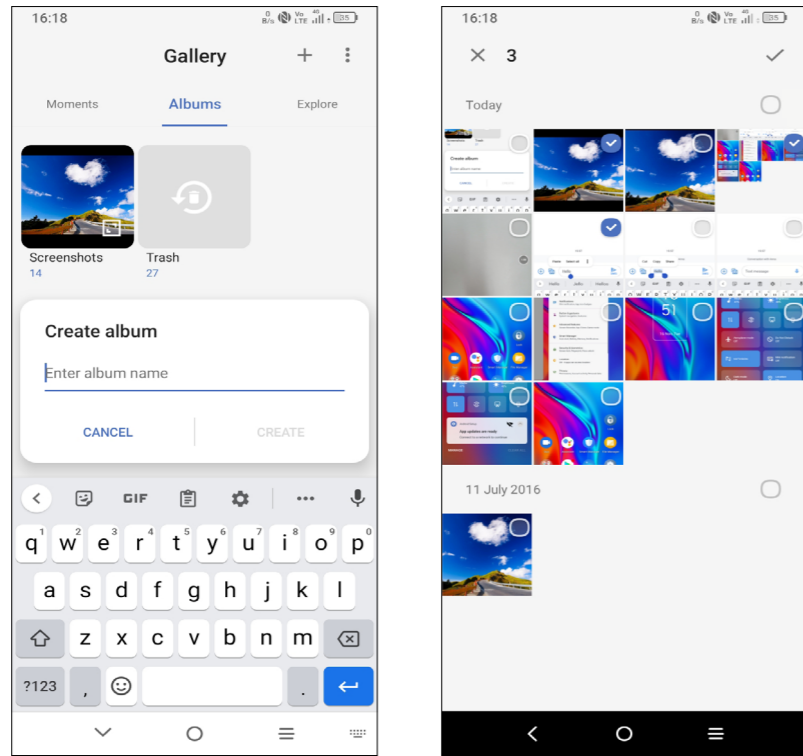

Touch **+** to create and name a new album. Select the pictures or videos you want to include in it by touching **✓** to copy or move them.

- Move/copy pictures or videos

Touch and hold the picture(s) or video(s) you want to move/copy. Touch **⋮** > **Copy to album/Move to album**, then select the album that you want to move to/copy to.

- Delete or recover pictures or videos

Touch and hold the picture(s) or video(s) you want to delete, touch **🗑️**.

Deleted items will be retained in the **Trash** album for 30 days, after which they will be permanently deleted. To permanently delete them within this period, find the picture(s) or video(s) in **Trash** and touch and hold to delete.

To recover the picture(s) or video(s) within this period, touch and hold the picture(s) or video(s) in **Trash** and touch **↶** to recover.

- Hide album <sup>(1)</sup>

Touch and hold the album you want to hide, touch **📁** > **MOVE**. The album contents will be hidden from **Moments**.

<sup>(1)</sup> Default albums such as **Camera**, **Videos**, **Screenshots**, etc. can't be hidden or moved.

## 2.3 Music



You can play music files stored on your phone or microSD card.

To play a music file, swipe up on the Home screen, then touch Music .

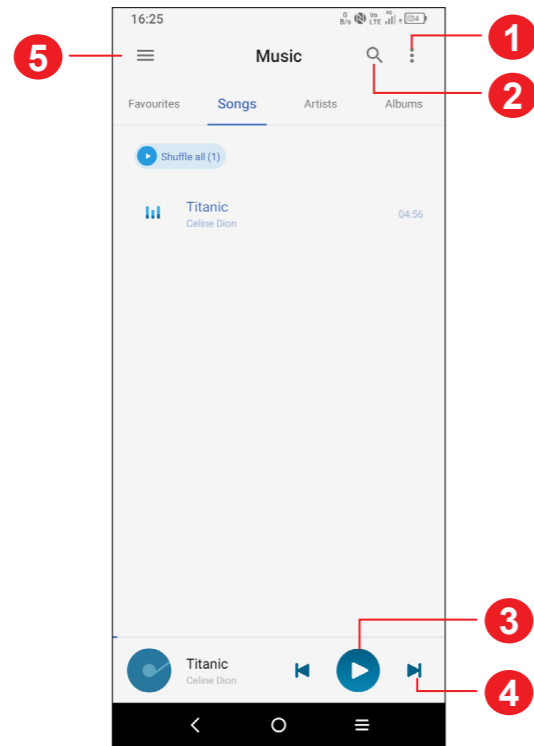

- 1 More options
- 2 Search for a song
- 3 Play or pause
- 4 Play the next song
- 5 Music settings

 While playing songs with Music, the operation of pause, play or skip is still available even if the screen is locked.

## 3 Apps and features

### 3.1 Phone



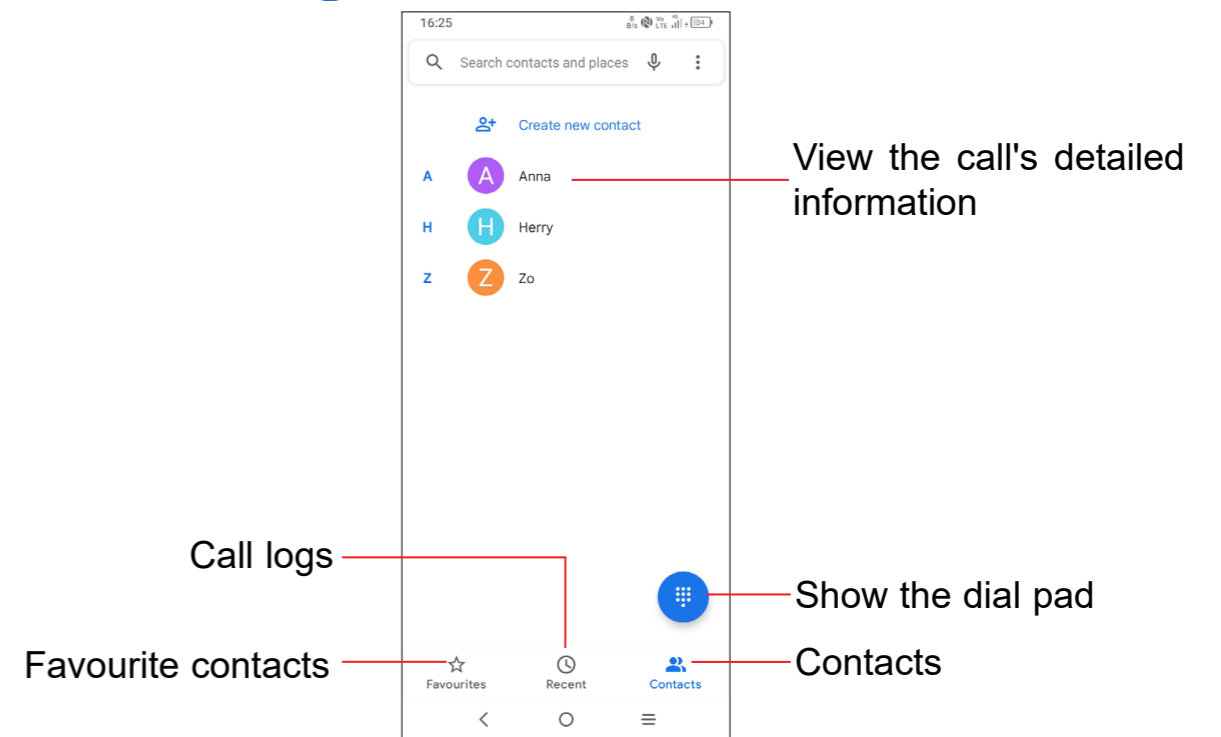

#### Making a call

To make a call, touch  in the Favourites tray.

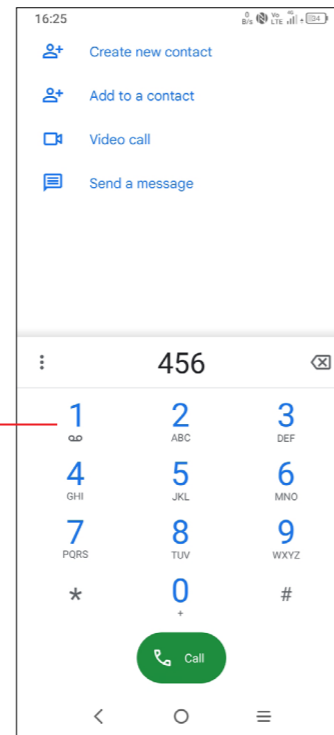

Touch and hold to access voicemail





Enter the desired number from the dial pad and touch  to place the call or select a contact from **Contacts** or **Call logs** by sliding or touching tabs, then make the call.

The number you entered can be saved to **Contacts** by touching **Create new contact** or **Add to a contact**.

If you make a mistake, you can delete the incorrect digits by touching .

To hang up a call, touch .

### International call

To dial an international call, touch and hold  to enter "+", then enter the international country prefix followed by the full phone number and touch .



### Emergency call

If your phone has network coverage, dial the emergency number and touch  to make an emergency call. Depending on your network and country this could even work without a SIM card and without typing in the SIM PIN code.

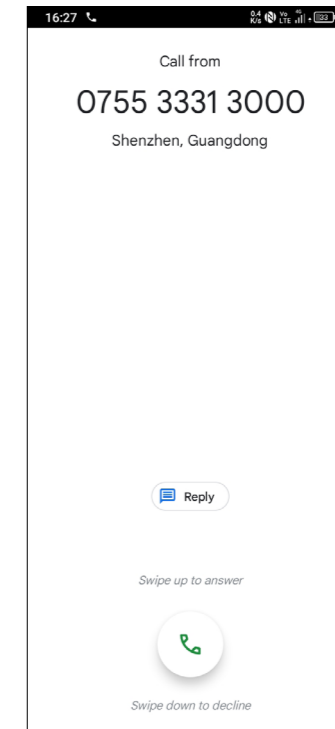
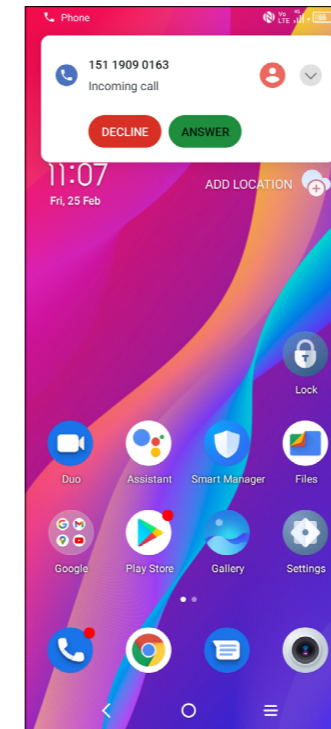
## Answering or rejecting a call





When you receive a call:

- Touch **ANSWER**, or swipe up the icon  to answer;
- Touch **DECLINE**, or swipe down the icon  to reject;
- Touch  **Reply** to reject the call by sending a preset message.

## Calling your voicemail

Your voicemail is provided by your network to avoid missing calls. It works like an answering machine that you can consult at any time.

To access your voicemail, touch and hold .

If you receive a voicemail,  appears on the Status bar. Open the Notification panel and touch **New voicemail**.

## During a call

To adjust the volume during a call, press the **Volume up/down** key.

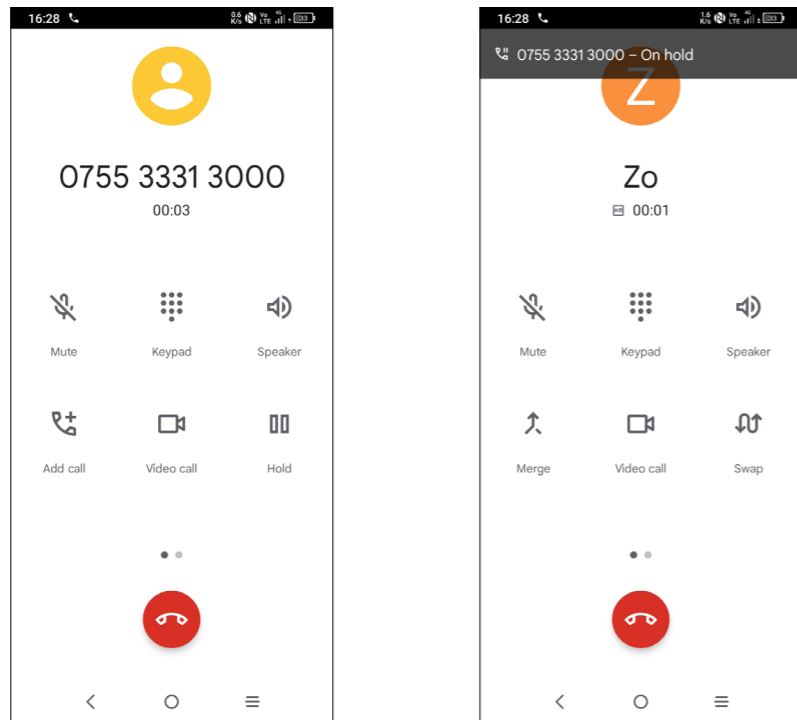

End the current call.



Touch to mute the current call. Touch this icon again to unmute the call.



Display the dial pad.



Touch to activate the speaker during the current call. Touch this icon again to deactivate the speaker.



Make another call.



Switch to video call.



Put a call on hold.



Merge calls to start a conference call.



Split a conference call into multiple calls.



Swap the calls.



Touch to add my camera.



To avoid accidental operation of the touchscreen during a call, the screen will be locked automatically when you put the cellphone close to your ear; and it will be unlocked when the cellphone is taken away from your ear.

## Managing multiple calls





With this phone you can handle multiple calls at the same time.

### Swap calls

When you accept two calls, touch the  icon to switch between two lines. The current call will be put on hold and you are able to join the other call.

### Conference calls<sup>(1)</sup>

You can set up a conference call as follows.

- Place a call to the first participant of the conference call.
- Touch  to add another call.
- Enter the phone number of the person you want to add to the conference and touch . You can also add participants from **Call logs** or **Contacts**.
- Touch  to start the conference.
- Touch  to end the conference call and disconnect all callers.

## Call settings

Touch  from the **Phone** screen, then touch **Settings** to set phone and contact settings.

## Call log

You can access your call logs by touching  from the **Phone** screen to view missed calls, outgoing calls and incoming calls.

Touch one call to view information or further operations. You can launch a new call, send a message to the contact or number, or view detailed information of the call.

To delete the call history of a selected contact or number, touch and hold the contact and choose **Delete**.

<sup>(1)</sup> Depending on your network operator.

## 3.2 Contacts



**Contacts** enables quick and easy access to the contact you want to reach.

You can view and create contacts on your phone and synchronise these with your Gmail contacts or other applications on the web or on your phone.

### Consult your Contacts

To see your contacts, touch  from the App drawer.

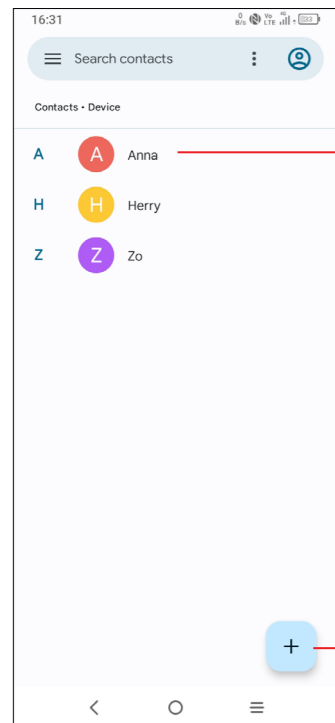

- Touch to open the Quick contact panel
- Touch and hold to share or delete the selected contact

• Add new contact



Deleted contacts will also be removed from other applications on the phone or web the next time you synchronise your phone.

### Adding a contact

Touch  in the contact list to create a new contact.

You are required to enter the contact's name and other contact information. By scrolling up and down the screen, you can move from one field to another.

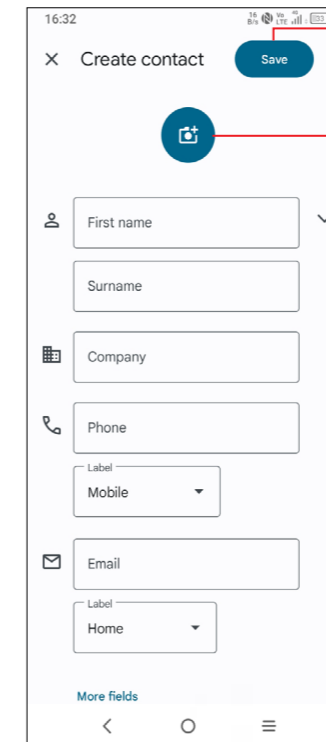

• Touch to save

• Select a picture or take a photo for the Phone contact

• Touch to open available labels

### Add to/remove from Favourites <sup>(1)</sup>

To add a contact to favourites, you can enter **Phone** app > **Favourites screen**, click **Add** to add contact to favourites.

To remove a contact from favourites, touch  on the contact details screen.

### Editing your contacts

To edit contact information, touch  in the contact details screen.



When finished, touch **Save**.

<sup>(1)</sup> Phone and Gmail contacts can be added to favourites.

## Using the Quick contact panel

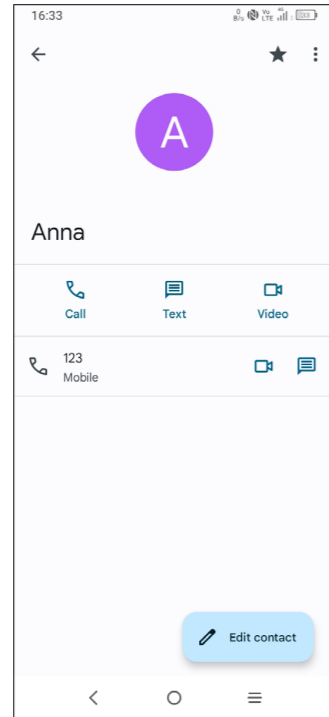
Touch a contact to open the Quick contact panel.



- Touch  or the number to make a call.
- Touch  to send a message.
- Touch  to make a video call.

The icons available on the Quick contact panel depend on the information you have for the contact and the applications and accounts on your phone.

## Sharing contacts

You can share a single contact or contacts with others by sending the contact's vCard to them via Bluetooth, Gmail, etc.

- From the Contacts screen, touch and hold a contact and touch .
- Select the application to perform this action.

## Accounts

Contacts, data or other information can be synchronised from multiple accounts, depending on the applications installed on your phone.

To add an account, touch  from the contacts list and touch **Sign in**, or from the home screen, touch **Settings > Accounts > Add account**.

You are required to select the kind of account you are adding, like Google, etc.

As with any other account setup, you need to enter detailed information, like username, password, etc.

You can remove an account and all associated information from the phone. Touch the account you want to delete, touch **Remove account**, then confirm.

## Auto-sync

On the **Accounts** screen, turn on **Automatically sync data** . When activated, all changes to information on the phone or online will be automatically synchronised with each other.

## 3.3 Messages



### Writing a new message

You can create, edit, send and receive SMS and MMS with this phone.

To access Messages, touch  from the App drawer.

On the message list screen, touch  to write text/multimedia messages.

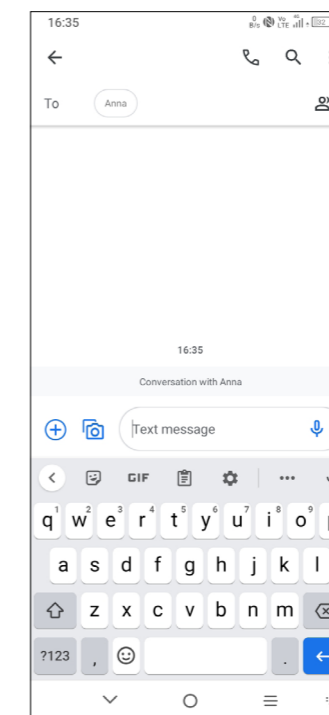

## Sending a text message

- To add recipients, enter a mobile phone number or select a contact in the **To** bar.
- Touch the **Text message** bar to enter the text of the message.
- When finished, touch  to send the text message.





Specific letters (accented) will also increase the size of the SMS. This may cause multiple SMS to be sent to your recipient.

## Sending a multimedia message

MMS enables you to send video clips, images, photos, animations, slides and sounds to other compatible mobiles and e-mail addresses.

An SMS will be converted to MMS automatically when media files (image, video, audio, slides, etc.) are attached or subject or email addresses are added.

- To send a multimedia message, enter the recipient's phone number in the **To** bar.
- Write the text of the message in the **Text message** bar.
- Touch  to give access to your location, send a voice message or attach files.
- Touch  to take a photo/video or attach a photo/video you have taken.
- When finished, touch  to send the multimedia message.

## Manage messages

When receiving a message,  will appear on the Status bar as a notification. Drag down the Status bar to open the Notification panel. Touch the new message to open and read it. You can also access the **Messages** application and touch the message to open it.

Messages are displayed as a conversation.

Touch a message to enter the message composing screen:

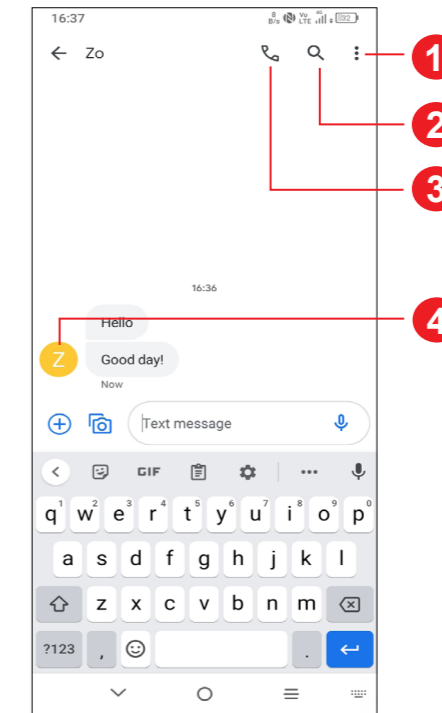

- 1 Touch for more options
- 2 Touch to search within a conversation
- 3 Touch to call the number
- 4 Touch to save the number to Contacts or view the contact details if the number has been saved

To adjust message settings, touch  and select **Settings** on the message list screen.

## 3.4 Calendar .....



Use **Calendar** to keep track of important meetings, appointments, etc.



To view the calendar and create events, open the Google apps folder from the Home screen, then touch **Calendar**.

### Multimode view



You can display the Calendar by **Schedule**, **Day**, **3 days**, **Week**, or **Month**, touch  to select.

## To create new events

You can add new events from any Calendar view.

- Touch .
- Fill in all required information for this new event. If it is a whole-day event, you can turn on **All-day** .
- Invite guests to the event. Enter the email addresses of the guests you want to invite. The guests will receive an invitation from Calendar and Email.
- When finished, touch **Save** at the top of the screen.

To quickly create an event from the **Week** view screens, touch an empty spot to select a target area which will then turn into , then touch the icon to create the new event. To delete or edit an event

To delete or edit an event, touch the event to enter its details screen. Touch  to edit the event, or touch  > **Delete** to delete.

## Event reminder

If a reminder is set for an event, the upcoming event icon  will appear on the Status bar as a notification when the reminder time arrives.

Touch and drag down the Status bar to open the notification panel, touch an event name to view the Calendar notification list. Touch the **Back** button to close and exit.



## 3.5 Clock.....

Your mobile phone has a built-in clock.

To view the current time, swipe up the Home screen, then touch **Clock**.

## Alarm

From the Clock screen, touch **Alarm** to enter.

- Turn on  to enable the alarm.
- Touch  to add a new alarm, touch  to save.
- Touch a currently existing alarm to enter the alarm editing screen.
- Touch **DELETE** to delete the selected alarm.

## Clock



To view the date and time, touch **Clock**.

- Touch  to add a city from the list.

## Timer

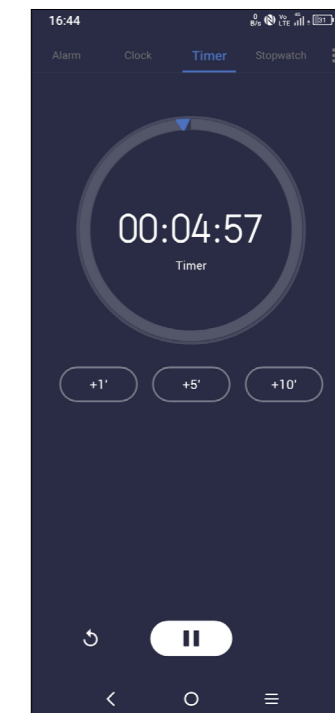
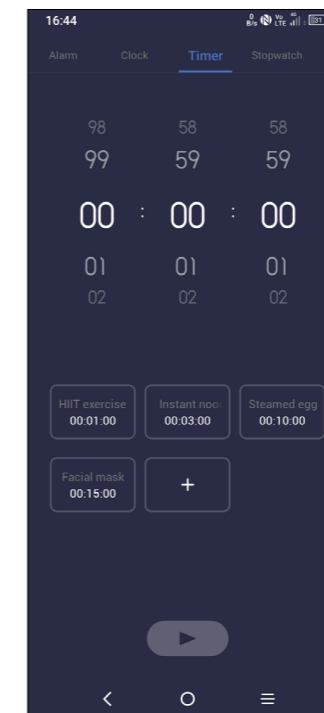
From the Clock screen, touch **Timer** to enter.





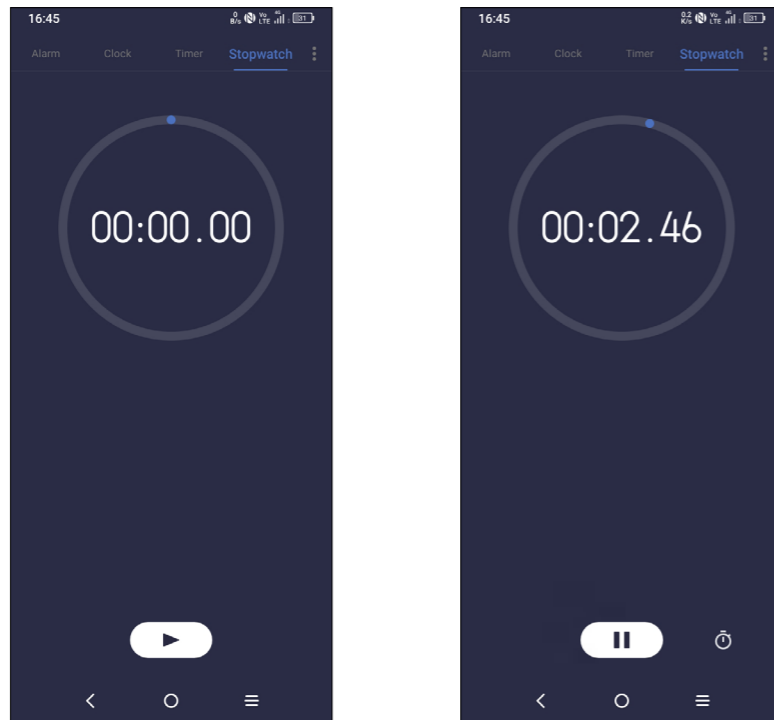

- Set the time.
- Touch  to start the countdown.
- Touch  to pause.
- Touch  to reset.

## Stopwatch

From the Clock screen, touch **Stopwatch** to enter.





- Touch  to start the Stopwatch.
- Touch  to show a list of records according to the updated time.
- Touch  to pause.
- Touch  to reset.
- Touch  to share.

## Adjust Clock settings

Touch  to access Clock and Alarm settings.

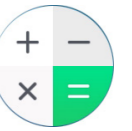
## 3.6 Calculator.....



To solve mathematical problems with **Calculator**, swipe up from the home screen, then touch .

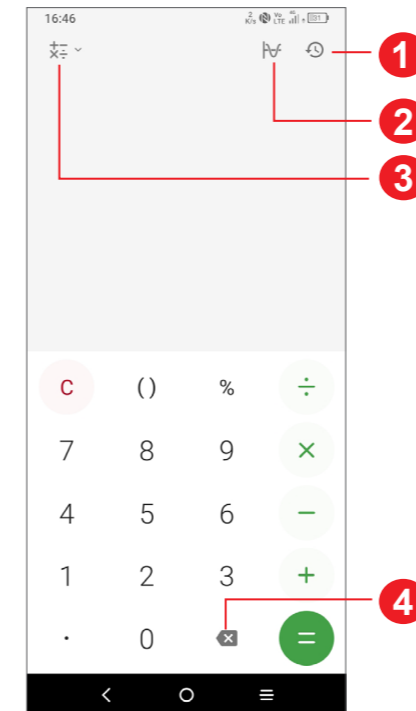

- 1 Calculation history
- 2 Touch to switch between Basic calculation and Scientific calculation
- 3 For more options about **Currency** and **Unit** conversion
- 4 Touch to delete digits one by one

## 3.7 TCL apps

### NXTVISION .....



**NXTVISION** provides image enhancement, video & game enhancement and other screen functions, helping your screen to come alive with a wonderful visually enhanced experience.

## 3.8 Other applications <sup>(1)</sup>

The previous applications in this section are preinstalled on your phone. To download and install more 3rd party applications, use the Google Play Store application.

## 3.9 Google applications

Google apps are preinstalled on your phone to improve work efficiency and help you enjoy life.

This manual briefly introduces the apps. For detailed features and user guides, refer to the related websites or the introduction provided in the apps.

You are recommended to register with a Google account to enjoy all the functions.

### Chrome

A web browser with which you can surf the internet.

Your bookmarks, browsing history, and settings across all devices with the browser installed can be synchronised with your Google account.

### Gmail

As Google's web-based email service, Gmail is configured when you first set up your phone. With this application you can send and receive emails, manage emails by labels, archive emails, etc. Emails can be automatically synchronised with your Gmail account.

### Maps

Google Maps offers satellite imagery, street maps, 360° panoramic views of streets, real-time traffic conditions, and route planning for travelling by foot, car, or public transportation. By using this application, you can find your own location, search for a place, and get suggested route planning for your trips.

### YouTube

YouTube is an online video-sharing application where users can upload, view, and share videos. Available content includes video clips, TV clips, music videos, and other content such as video blogging, short original videos, and educational videos. It supports a streaming function that allows you to start watching videos almost as soon as they begin downloading from the internet.

### Play Store

Serves as the official app store for the Android operating system, allowing users to browse and download applications and games. Applications are either free of charge or at a cost.

In Play Store, search for the app you need, download it and then follow the installation guide to install the app. You can also uninstall, update an app, and manage your downloads.

### Duo

A video chat mobile app.



With phone numbers verified, users can easily video call people from their contact list.

### Photos

Google Photos stores and backs up your photos and videos. It also automatically analyses photos and organises them into groups, so that you can quickly find the photos you need.

<sup>(1)</sup> Application availability depends on country and operator.

## 4 Settings

To go to **Settings**, touch  from the Home screen or swipe up from the Home screen and then touch .

You can also swipe down from the notification panel and touch .

### 4.1 Wi-Fi

You can connect to the internet when your phone is within range of a wireless network. Wi-Fi can be used on your phone even without a SIM card inserted.

#### To turn Wi-Fi on and connect to a wireless network

- Touch **Settings > Wi-Fi**.
- Turn on .
- Once Wi-Fi is turned on, detected Wi-Fi networks are listed.
- Touch a Wi-Fi network to connect to it. If the network you selected is secured, you are required to enter a password or other credentials (you should contact the network operator for details). When finished, touch **CONNECT**.

#### To add a Wi-Fi network

When Wi-Fi is on, you can add new Wi-Fi networks according to your preference.

- Touch **Settings > Wi-Fi > Add network**.
- Enter the name of the network and any required network information.
- Touch **CONNECT**.

#### To forget a Wi-Fi network

The following steps prevent automatic connection to networks which you no longer wish to use.

- Turn on Wi-Fi, if it's not already on.
- On the Wi-Fi screen, touch the name of the saved network.
- Touch **FORGET** in the dialog that opens.

## 4.2 Bluetooth <sup>(1)</sup>

### Bluetooth

Bluetooth is a short-range wireless communication technology that you can use to exchange data, or connect to other Bluetooth devices for various uses.

#### To turn on Bluetooth

- Touch **Settings > Bluetooth**.
- Turn on .

Your device name will appear on screen.

#### To rename your device

- Touch **Settings > Bluetooth**.
- Touch **Device name**.
- Enter a name, and touch **RENAME** to confirm.

#### To pair/connect your phone with a Bluetooth device

To exchange data with another device, you need to turn Bluetooth on and pair your phone with the Bluetooth device with which you want to exchange data.

- Touch **Settings > Bluetooth > + Pair new device**.
- Touch a Bluetooth device you want to pair your phone with in the list.
- In the dialog that pops up, touch **PAIR** to confirm.
- If the pairing is successful, your phone will be connected to the device.

#### To unpair from a Bluetooth device

- Touch  beside the device you want to unpair from.
- Touch **FORGET** to confirm.

<sup>(1)</sup> You are recommended to use TCL Bluetooth headsets, which have been tested and proved compatible with your phone. You can go to <https://www.tcl.com> for more information about the TCL Bluetooth headset.

## 4.3 SIM card & mobile network

Go to **Settings > SIM card & mobile network > SIM 1 > Roaming Mode** to enable data roaming, set your preferred network type, check the network connection you are using or create a new access point, etc.

### SIM cards <sup>(1)</sup>

Touch to choose SIM 1 or SIM 2 for connecting to the network, making calls and sending SMS messages.

## 4.4 Connections

### Aeroplane mode

Turn on **Aeroplane mode**  to simultaneously disable all wireless connections including Wi-Fi, Bluetooth and more.

### Hotspot & tethering

To share your phone's data connection via Wi-Fi, Bluetooth and USB, or as a mobile hotspot, go to **Settings > Connections > Hotspot & tethering** to activate these functions.

#### To rename or secure your mobile hotspot

When your mobile hotspot is activated, you can rename your phone's Wi-Fi network (SSID) and secure its Wi-Fi network.

- Touch **Settings > Connections > Hotspot & tethering > Mobile hotspot**.
- Touch **Hotspot name** to rename the network SSID or touch **Security** to set your network security.
- Touch **OK**.

 The functions above may incur additional network charges from your network operator. Extra fees may also be charged in roaming areas.

<sup>(1)</sup> Dual SIM only.

## Data usage

The first time you turn on your phone with your SIM card inserted, it will automatically configure your network service: 2G, 3G or 4G.

If the network is not connected, you can turn on mobile data in **Settings > Connections > Data usage**.

### Data saver

By enabling Data saver, you can reduce data usage by preventing some apps from sending or receiving data in the background.

### Mobile data

If you do not need to transmit data on mobile networks, turn off **Mobile data** to avoid incurring significant charges for data use on local operator mobile networks, particularly if you do not have a mobile data agreement.

 Data usage is measured by your phone, and your operator may count differently.

### Mobile data usage

Touch to review the data usage of each app.

 Operator data accounting may differ from device accounting.

### Billing cycle

Touch to set the mobile data usage cycle.

### Wi-Fi data usage

Touch to review Wi-Fi data usage.

### Network restrictions

You can set metered Wi-Fi networks.

Metered networks are treated like mobile networks when background data is restricted. Apps may warn before using these networks for large downloads.

## VPN

Virtual private networks (VPNs) allow you to connect to the resources inside a secured local network from outside that network. VPNs are commonly deployed by corporations, schools, and other institutions so that their users can access local network resources when not inside that network, or when connected to a wireless network.

### To add a VPN

- Touch **Settings > Connections > VPN** and then touch .
- On the screen that opens, follow your network administrator's instructions to configure each component of the VPN settings.
- Touch **SAVE**.

The VPN is added to the list on the VPN settings screen.



Before adding a VPN, you should set a screen lock for your phone.

### To connect to/disconnect from VPN

To connect to a VPN:

- Touch **Settings > Connections > VPN**.
- The VPNs you have added are listed. Touch the VPN you want to connect with.
- In the dialog that opens, enter any requested credentials and touch **CONNECT**.

To disconnect from a VPN:

- Touch the VPN you want to disconnect from. In the dialog that opens, touch **DISCONNECT**.

### To edit/delete a VPN

To edit a VPN:

- Touch **Settings > Connections > VPN**.
- The VPNs you have added are listed. Touch the  icon next to the VPN you want to edit.
- After editing, touch **SAVE**.

To delete a VPN:

- Touch the  icon next to the selected VPN, then touch **FORGET** to delete it.

## Private DNS

Touch to select private DNS mode.

## NFC

Turn on  to enable NFC.

The function allows data exchange when the phone touches another device.

## Cast

You can use Cast to display your device's screen on your TV, and display content like TV shows, movies, photos, games, and websites from supported apps.

## USB

With a USB cable, you can charge your device, transfer files or photos (MTP/PTP) between your phone and a computer.

### To connect your phone to the computer

- Use the USB cable that came with your phone to connect the phone to a USB port on your computer. You will receive a notification that the USB is connected.
- Open the Notification panel and choose the way which you want to transfer files or touch **Settings > Connections > USB** to select. By default, **Charge this device** is selected.



Before using MTP, make sure that the driver (Windows Media Player 11 or higher version) has been installed.

## Printing

Touch **Printing** to activate **Print services**. You can select your **Default print service**.

## Nearby Share

The device location setting need to be on for Bluetooth and Wi-Fi to detect nearby devices.

## 4.5 Home screen & lock screen

With this menu, set your home apps, choose your favourite wallpapers and theme styles, etc.

## 4.6 Display

### Brightness level

Adjust screen brightness manually.

### Adaptive brightness

Adjust screen brightness automatically.

### Darker display mode

Adjust dark light mode brightness manually.

### Dark mode

Empty screen space will become black in this mode, making it easier to look at your screen or read in dim light.

### Eye comfort mode

**Eye comfort mode** can effectively reduce blue light radiation and adjust the colour temperature to relieve eye fatigue. You can also create a custom schedule to turn it on.

### Sleep

Set screen timeout.

### Colour mode & temperature

Change the display gamut to vivid, natural or advanced based on content.

### Font size

Adjust font size manually.

## Font Style

Adjust font style manually.

## Auto-rotate screen

Select whether the screen rotates automatically or not.

## Status bar & notch

With this menu, you can set the style of the status bar, turn on/off to show network speed, select whether notification icons are folded and how the battery percentage is displayed

Turn on the notch for full screen apps to get the best experience on the phone.

## More display setting

Most applications installed on the phone will automatically adapt to the full screen display without setting them manually.

For the applications which do not automatically adapt to the full screen display, you can go to **Settings > Display > More display settings > Full screen apps** to set.

## 4.7 Sound & vibration

Use the Sound settings to configure many aspects of call ringtones, music, and other audio settings.

### Silent mode

Touch  to turn on silent mode.

### Phone ringtone & vibrate

Set your incoming call ringtone or opt for the phone to also vibrate for calls.

### Notification ringtone

Set the default sound for notifications.

## Alarm ringtone

Set your alarm ringtone.

## Do Not Disturb

If you do not want to be disturbed by your phone or information ringtones during work or rest, you can set the **Do Not Disturb** mode.

Swipe down the Status bar twice to access the Quick Settings panel and touch  to turn on Do Not Disturb.

## Headset mode

Ringtone will only be heard from headset if it is plugged in.

## More sound settings

Set dial pad tones, screen locking sounds, touch sounds, etc.

## 4.8 Notifications

In the **Notifications** menu, you can configure whether to block the notifications from this app, hide sensitive content, etc.

## 4.9 Button & gestures

### System navigation

Select your favourite navigation button layout.

### Gestures

To set some gestures for convenient use, such as flip to mute, 3-finger screenshot, 3-finger regional screenshot, split-screen, etc.

### Power key

Touch to set **Quick launch camera** and **Power button ends call**.

## 4.10 Advanced features

### Smart App Recommend

After connecting headset or speakers, recommend suitable applications on the launcher according to your habits.

### App lock

**Apps lock** can effectively protect your privacy by locking some apps with a pattern or fingerprint. Go to **Settings > Advanced features > App lock** to set the lock format, lock time and choose the apps you want to lock.

### Game mode

In this mode, you can enable DO NOT DISTURB mode while playing, prevent accidental touches, and optimise game performance.

### App Cloner

App Cloner will duplicate one app on your Home screen and you can enjoy both of them respectively at the same time.

### Screen Recorder

Set the video resolution, Sound and Record touch interactions.

To activate Screen Recorder, touch the  icon in the Quick Settings panel.

## 4.11 Smart Manager

**Smart Manager** ensures your phone is operating in top form by automatically scanning and optimising data usage to preserve battery levels, manage storage and protect against security threats.

Restricting auto-start apps can make the system run faster and extend battery life.

You can also do some options manually for further optimisation.

## 4.12 Security & biometrics

### Screen lock

Select one method such as **Swipe**, **Pattern**, **PIN**, or **Password** to unlock the screen.

### Fingerprint

Use your Fingerprint to unlock the screen.

Access **Settings > Security & biometrics > Fingerprint** to activate these functions.

### Face unlock

**Face unlock** allows you to unlock your device with your facial data. Set it according to the on-screen steps.

Ensure that you are facing the phone screen when using face recognition.

**NOTE:** you need to set a pattern, PIN, or password before using face key.

### Smart Lock

**Smart Lock** keeps your device unlocked when it's safe with you and locked when it detects that it's been put down.

### Others

You can also set **Device admin apps**, **SIM card lock**, **Encryption & credentials**, **Trust agents**, **Screen pinning**, etc. in **Settings > Security & biometrics**.

## 4.13 Location

Touch to set whether to allow an app to access your device's location. You can set to allow continual access, or only while the app is in use.

## 4.14 Privacy

To protect your privacy, you can set an app to be allowed or forbidden access to your location, SMS, phone, etc. Also whether or not to show passwords, choose the activities and info that you want Google to save.

## 4.15 Safety & emergency

To protect yourself in emergency, you can set emergency information such as medical information, emergency contacts in advance. You can also use SOS or turn on location and wireless emergency alerts.

## 4.16 Apps

Touch to view details about the applications installed on your phone, to manage their data usage or force them to stop.

In the **Permission manager** menu of an application, you can grant permissions for the app, such as allowing the app to access your **Camera**, **Contacts**, **Location**, etc.

In the **Special app access** menu, you can set **Device admin apps**, **Do Not Disturb access**, **Notification access**, **Picture-in-picture**, **Usage access**, **Wi-Fi control**, etc.

## 4.17 Storage

Enter **Settings > Storage** to check the usage of storage space and free up more when necessary.

## 4.18 Accounts

Touch to add, remove, and manage your email and other supported accounts. You can also use these settings to control the options for how all applications send, receive and synchronise data; i.e. if this is done automatically, according to a schedule for each app, or not at all.

Touch **Add account** to add an account for the selected app.

## 4.19 Digital Wellbeing & parental controls

In this menu you can find how much time you have spent on the phone and even on each app. You can customise the time limit for using the phone to ensure a healthy and balanced life.

In addition, parents are able to restrict their children's usage time to manage their browsing habits.

## 4.20 Google

Touch to configure your Google account and service settings.

## 4.21 Accessibility

Use the Accessibility settings to configure any accessibility plug-ins you have installed on your phone.

## 4.22 System

### About phone

View basic information for your phone such as model name, CPU, camera, resolution, etc.

You can also check legal information, build number, status and other specs.

### System Update

If you want to update the system, touch **CHECK FOR UPDATES** (refer to "5 Making the most of your phone > FOTA upgrade").

### Update Apps

Check app update information.

### Languages & input

Touch to configure language settings, the on-screen keyboard, voice input settings, pointer speed, etc.

## Date & time

Use Date & time settings to customise your preferences for how date and time are displayed.

## Backup

Turn on  to back up your phone's settings and other application data to Google servers. If you replace your phone, the settings and data you've backed up will be restored onto the new phone when you sign in with your Google account.

## Developer options

To enable this function, go to **Settings > System > About phone**, then touch **Build number** 7 times. Now **Developer options** is available. The developer options contain settings that are useful for developing Android applications.

## Reset

Touch to reset all network settings and app preferences, you won't lose your data with these settings.

If **Factory data reset** is selected, all data in your phone's internal storage will be erased, please back up your data before reset.

## Regulatory & safety

Touch to view product information such as **Product model, Manufacturer name, Manufacturer address, IMEI, CU reference, Bluetooth Declaration ID**, etc.

## User Experience Improvement Programme

Touch to join the User Experience Improvement Programme so we can continue to improve our product design and overall user experience.

## 5 Making the most of your phone

### FOTA upgrade

Use the FOTA (Firmware Over The Air) upgrade to update your phone's software.

To access updates, from the app list, touch **Settings > System > System Update**. Turn on data connection or Wi-Fi before searching for updates.

With Wi-Fi turned on, the system is able to discover if a new firmware version is available and if so, begin to download it automatically. Once finished, a pop up dialog will give you the option of updating your phone now or later.

If **Settings > System > System Update > ⋮ > Update settings > Automatically update** is turned off, you will only receive a notification which will appear in the Status bar.

During FOTA downloading or updating, to avoid errors in locating the correct update packages, do not change your default storage location.

After FOTA update completely, it need restart device, it will prompt tips to restart device

## 6 Troubleshooting

Before contacting the service centre, here are some instructions to help you troubleshoot your device:

- For optimal operation, fully charge the battery.
- To improve the phone's performance, remove unnecessary files or apps on your phone.
- Update your phone's software via **Settings > System > System Update**.
- Reset your phone via **Settings > System > Reset > Erase all data (factory reset)**. Another method is to hold down the **Power** key and the **Volume up** key at the same time when your phone is powered off. Release the power button and then the volume button after the vibration, then select **Wipe data / factory reset > Factory data reset** to reset. All your phone data will be lost permanently. It is strongly advised to fully back up your phone data before resetting.

and carry out the following checks:

### My phone can't be switched on or is frozen

- When the phone can't be switched on, charge for at least 20 minutes to ensure the minimum battery power needed. Then switch it on again.
- When the phone falls into a loop during power on animation and the user interface can't be accessed, press and hold the **Power** key to reset. This eliminates any abnormal OS booting issues caused by third party applications.
- If neither method is effective, reset the phone by pressing the **Power** key and the **Volume up** key at the same time. Release the power key when the device vibrates, then select **Wipe data / factory reset > Factory data reset** to reset.

### My phone has not responded for several minutes

- If your phone doesn't respond, turn off your phone by pressing and holding the **Power** key until it turns off and then restart it again.
- If it still doesn't work, reset the phone.

### My phone turns off by itself

- Check that your screen is locked when you are not using your phone, and make sure that the **Power** key is not accidentally pressed while the screen is unlocked.
- Check the battery charge level.

- If it still doesn't work, reset the phone or update software.

### **My phone can't charge properly**

- Make sure that you are using the TCL charger that comes with the phone.
- Make sure that your battery is not completely discharged; if the battery power has been empty for a long time, it may take around 20 minutes to display the battery charging indicator on the screen.
- Make sure that charging is carried out under normal conditions 0°C (32°F) to 45°C (113°F).
- When abroad, check that the voltage input is compatible.

### **My phone can't connect to a network or "No service" is displayed**

- Try connecting to the network by moving to another physical location.
- Verify the network coverage with your operator.
- Check with your operator that your SIM card is valid.
- Try connecting at a later time if the network is overloaded.

### **My phone can't connect to the internet**

- Make sure that the internet access service of your SIM card is available.
- Check your phone's internet connection settings.
- Make sure that you are in a place with network coverage.
- Try connecting at a later time or another location.

### **Invalid SIM card**

- Make sure that the SIM card has been correctly inserted.
- Make sure that the chip on your SIM card is not damaged.
- Make sure that the service of your SIM card is available.

### **My phone can't make outgoing calls**

- Make sure that you have dialled a valid number and have touched .
- For international calls, check the country and area codes.

- Make sure that your phone is connected to a network, and the network is not overloaded or unavailable.
- Check your subscription status with your operator (credit, SIM card valid, etc.).
- Make sure that you have not barred outgoing calls.
- Make sure that your phone is not in aeroplane mode.

### **My phone can't receive incoming calls**

- Make sure that your phone is switched on and connected to a network (check for overloaded or unavailable network).
- Check your subscription status with your operator (credit, SIM card valid, etc.).
- Make sure that you have not forwarded incoming calls.
- Make sure that you have not barred certain calls.
- Make sure that your phone is not in aeroplane mode.

### **The caller's name/number doesn't appear when a call is received**

- Check that you have subscribed to this service with your operator.
- Your caller may have concealed his name or number.

### **The sound quality of the calls is poor**

- Adjust the volume during a call by pressing the **Volume** key.
- Check the network strength. Move to a location with stronger signal strength.
- Make sure that the receiver, connector and speaker on your phone are clean.

### **I can't use the features described in the manual**

- Check with your operator to make sure that your subscription includes this service.
- Make sure that this feature doesn't require a TCL accessory.

### **When I select a number from my contacts, the number can't be dialled**

- Make sure that you have correctly recorded the number in your contacts.
- Make sure that you have selected the country code when calling an international number.

### **I can't add a contact**

- Make sure that your phone storage is not full.

### **My callers can't leave messages on my voicemail**

- Contact your network operator to check service availability.

### **I can't access my voicemail**

- Make sure that your operator's voicemail number is correctly entered in "Voicemail number".
- Try later if the network is busy.

### **I can't send and receive MMS**

- Check your phone storage as it might be full.
- Contact your network operator to check service availability and MMS parameters.
- Verify the server centre number or your MMS profile with your operator.
- The server centre may be swamped. Try again later.

### **SIM card PIN locked**

- Contact your network operator to obtain the PUK (Personal Unblocking Key) code.

### **I can't connect my phone to my computer**

- Check to make sure the USB port is not broken. If it's not working, try another USB port on your computer.
- Make sure USB drivers are properly installed.
- If you are using a Windows computer, make sure it supports MTP mode. If you are using a Mac, make sure to install Android File Transfer from [www.android.com/filetransfer/](http://www.android.com/filetransfer/).

### **I can't download new files**

- Make sure that there is sufficient phone storage space for your download.
- Select the microSD card as the location to store downloaded files.
- Check your subscription status with your operator.

### **The phone can't be detected by others via Bluetooth**

- Make sure that Bluetooth is turned on and your phone is visible to other users.
- Make sure that the two phones are within Bluetooth's detection range.

### **The battery drains too fast**

- Make sure that you follow the complete charge time (minimum 120 minutes).
- After a partial charge, the battery level indicator may not be exact. Wait for at least 20 minutes after removing the charger to obtain an exact indication.
- Adjust the brightness of screen as appropriate.
- Extend the email auto-check interval for as long as possible.
- Update news and weather information on manual demand, or increase their auto-check interval.
- Exit background-running applications if they are not being used for extended periods of time.
- Turn off Bluetooth, Wi-Fi, or GPS when not in use.

### **The phone becomes warm following prolonged calls, game playing, internet surfing or running other complex applications**

- This heating is a normal consequence of the CPU handling excessive data. Ending the above actions will make your phone return to normal temperature.

### **After a factory data reset is performed, I can't use my phone without entering Google account credentials**

- After a reset is performed, you must enter the original Google account credentials that were used on this phone.
- If you don't remember your Google account credentials, complete Google account recovery procedures.
- If you still cannot access your phone, apply to the authorised repair centre, but remember that it will not be regarded as a warranty case.

### **I forgot some passwords/codes/keys on my phone**

- Perform a factory data reset.
- If you still cannot access your phone, apply to the authorised repair centre, but remember that it will not be regarded as a warranty case.

### No action after touching the touch screen

- Check whether there is any damage to the screen. If yes, please back up your data and take your device and proof of purchase to our repair centre to get more professional technical assistance.
- If the issue occurs while using a third-party app, make sure the app is compatible with your device and Android version. Try uninstalling the third-party app.
- Check if the issue occurs during charging. If yes, we recommend trying the official charger and data cable.

(Note: The voltage instability of non-standard chargers and data cables may cause the touchscreen to become unresponsive).

- Make sure the temperature where the device is being used is neither too hot nor too cold. The standard working temperature of the capacitive touchscreen is -10°C~60°C. Excessively high or low temperatures will cause the touchscreen to become unresponsive.
- If there is a screen protector on the screen, see if the touchscreen works after removing it.
- Make sure there are no stains such as water or sweat on the touchscreen. If there are, wipe the screen and try again.
- If it still doesn't work, reset the phone or update software

### Cannot turn on camera flash mode

- Charge your device until the battery level is at least 30%. Camera flash cannot be used when the battery is running low.
- Clear the cache of the **Camera** app.
- To clear an app's cache: go to the main menu, select **Settings > Apps > View all apps > Camera > Storage & cache > CLEAR DATA** and **CLEAR CACHE**.
- Drag down the quick settings bar in any interface, touch the flashlight icon to check whether the flash on your device works.
- Check whether the camera is set to the special shooting mode. In order to achieve a certain effect, the program will prohibit the use of the flash. Please revert to normal camera shooting mode.

### How to back up my device data

- Go to **Settings > System > Backup** (refer to “4.22 System > Backup” )
- You can also back up your data to another phone via the **Switch Phone** app. Swipe up the home screen to find the search bar and enter **Switch Phone**, transfer data by following the instructions.

# 7 Specifications

## Platform:

- Helio G25

## OS:

- Android 12

## Memory:

- 64GB ROM + 3GB RAM<sup>(1)</sup>

## Dimensions (LxWxT):

- 165.2 x 75.5 x 8.9 mm

## Weight:

- 190g

## Display:

- 6.52"HD + 720X1600

## Network:

- GSM 850/900/1800/1900
- UMTS B1/2/5/8
- LTE B1/3/5/7/8/20/28/38/40/41 (2496-2690MHz)

## GPS:

- BDS/GPS/Glonass/Galileo, with A-GPS

## Connectivity:

- Bluetooth 5.0
- Wi-Fi 802.11 b/g/n, 2.4GHz
- 3.5 mm audio jack
- Type-C

<sup>(1)</sup> Depending on the device you purchased.

## Camera:

- Rear Camera: 50MP+2MP(D)
- Front camera: 5MP

## Audio & Video supported formats:

- AAC, AMR, AWB, MP3, AAC+, Vorbis, FLAC, APE, eAAC+, PCM playback
- 1080P @ 30fps, H.263, H.264 AVC, H.265 HEVC, VP8, VP9, MPEG-4

## Battery <sup>(1)</sup>:

- Capacity: 5000 mAh

## Expansion Slot:

- microSD™ memory card  
(Availability of microSD card up to 512GB)

## Sensors:

- G-sensor
- Light Sensor
- Proximity Sensor
- E-Compass

**Note:** Specifications are subject to change without prior notice.

<sup>(1)</sup> The original battery has undergone rigorous safety inspections to meet qualification standards, the use of non-original batteries may be dangerous.

## 8 Accessories

Standard accessories

- Charger
- Type C Cable
- SIM card pin
- LCD sticker
- Quick Start Guide
- Product safety information leaflet



- Accessories depend on countries.
- Only use the TCL batteries, chargers, and accessories included along with your device.

## 9 Licences



microSD logo is a trademark.



Bluetooth SIG, Inc. licensed and certificated **TCL 61271** Bluetooth Declaration ID D048576



Wi-Fi Alliance certificated

## 10 Disclaimer

There may be certain differences between the user manual description and the phone's operation, depending on the software release of your phone or specific carrier services.

TCL Communication Ltd. shall not be held legally responsible for such differences, if any, nor for their potential consequences, which responsibility shall be borne by the carrier exclusively.