



Questo manuale d'istruzione è fornito da trovaprezzi.it. Scopri tutte le offerte per [TCL 3189](#) o cerca il tuo prodotto tra le [migliori offerte di Cellulari e Smartphone](#)



Questo manuale d'istruzione è fornito da trovaprezzi.it. Scopri tutte le offerte per [TCL 3189](#) o cerca il tuo prodotto tra le [migliori offerte di Cellulari e Smartphone](#)

**DISPL ¹AY
GREATNESS**

TCL 3189

Note:

This is a user manual for TCL 3189D

There may be certain differences between the user manual description and the phone's operation, depending on the software release of your phone or specific operator services.

Help

Refer to the following resources to get more FAQ, software, and service information.

Consulting FAQ

Go to www.tcl.com/global/en/service-support-mobile/faq.html

Finding your serial number or IMEI

You can find your serial number or International Mobile Equipment Identity (IMEI) on the packaging materials. Or, on the phone, press *#06#. or **Settings > Regulatory & safety > IMEI**.

Obtaining warranty service

First follow the advice in this guide or go to www.tcl.com/global/en/service-support-mobile.html. Then check hotlines and repair centre information through www.tcl.com/global/en/service-support-mobile/hotline&service-center.html

Viewing legal information

On the phone, go to **Settings > About > Privacy and User Terms**

1 Table of Contents

1	Your mobile.....	5
1.1	Keys and connectors	5
1.2	Getting started.....	8
1.3	Home screen.....	12
1.4	App list	13
2	Call logs	15
2.1	Making a call	15
2.2	Answer or decline a call.....	16
2.3	Accessing voicemail	16
3	Contacts	17
3.1	Consult your Contacts.....	17
3.2	Adding a contact	18
3.3	Editing your contacts.....	18
3.4	Deleting a contact	19
3.5	Available options	19
4	Calendar	20
4.1	Multimode view	20
4.2	Add a new event	21
4.3	Event reminder.....	22
5	Tools	22
5.1	Alarm.....	22

5.2	Calculator	22
5.3	Bluetooth	22
5.4	Converter	22
5.5	Fake call	23
5.6	Voice alarm	23
5.7	World clock	23
5.8	SIM Toolkit	23
5.9	Call Filter	23
5.10	Torch	24
5.11	Browser	24
6	Message	25
6.1	Write messages	25
6.2	Send a multimedia message	26
6.3	How to type a message	26
6.4	Settings	27
7	Multimedia	29
7.1	Image	29
7.2	Video gallery	32
7.3	Recorder	32
8	Files	32
9	Camera	33
9.1	Camera	33
9.2	Video	33

10	Settings	34
10.1	Phone settings	34
10.2	Call settings	35
10.3	Profiles	36
10.4	Network selection	37
10.5	Connections	37
10.6	Security	38
10.7	Assistance (SOS)	39
10.8	Update	40
10.9	Regulatory & Safety	40
10.10	Restore factory settings	40
10.11	About	40
11	Troubleshooting	41
12	Specifications	47
13	Accessories	49
14	Licences	49

1 Your mobile.....

1.1 Keys and connectors

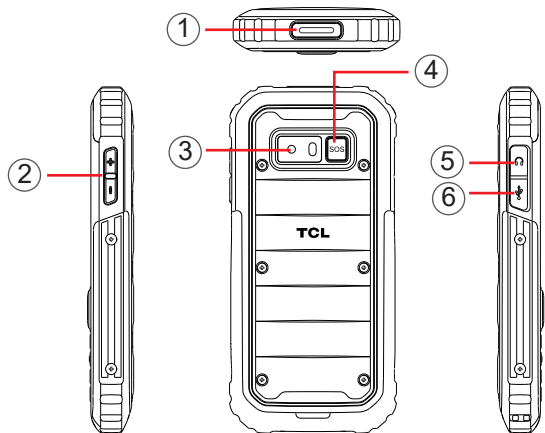

1. Torch
2. Volume key
3. Camera
4. Assistant (SOS) key
5. Headset connector
6. USB port

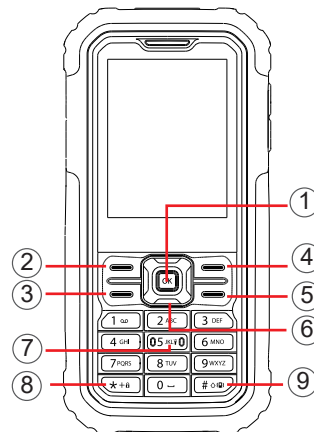

1. OK key
 - Confirm an option (press the middle of the key)
 - Press: access to the app list (Home screen)
2. Left soft key
3. Call key
 - Pick up/send a call
 - Press: enter call log (from Idle screen)
4. Right soft key
5. End key
 - Return to the previous screen, or close a dialog box.

- Press: end a call
6. Navigation key
- Move to top, bottom, left or right menus.
 - Press (from Idle screen):
 - Up: to access Profiles
 - Down: to access Alarm
 - Right: to access Camera
 - Left: to access Messages

7. "5" key

- In idle screen:
- Press: Input "5"
- Long press: switch on/off the torch

8. "*" key

- In idle screen
- Press: Input "*"
- Long press: lock screen
- In Edit mode:
- Press: insert symbols

9. "#" key

- Idle screen
- Press: Input "#"
- Long press: Vibrate mode on/off

- In edit mode
- Press: change the input method

1.2 Getting started

1.2.1 Set up

Removing the back cover and installing the battery

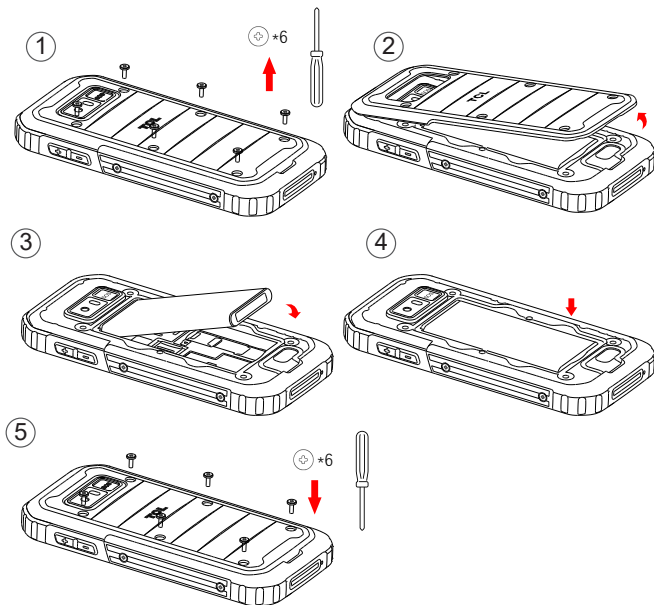

Removing and installing the frame deco

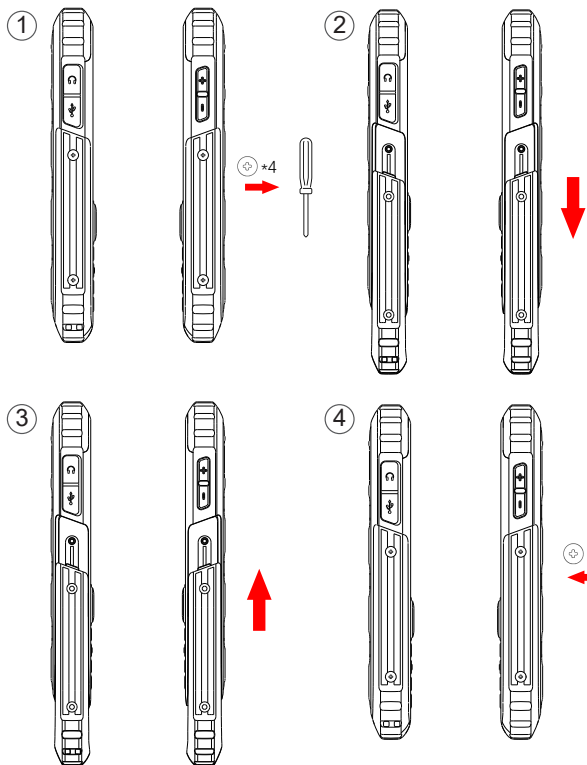

Inserting or removing the SIM/micro SD card

Place the SIM card with the chip facing downwards and slide it into its housing. Make sure that it is correctly inserted. To remove the card, press it and slide it out.

Power off your phone before inserting or removing the SIM/micro SD card.

Charging the battery

Connect the battery charger to your phone and plug into the socket.

- Be careful not to force the plug into the socket.
- Make sure the battery is correctly inserted before connecting the charger.
- The mains socket must be near to the phone and easily accessible (avoid electric extension cables).

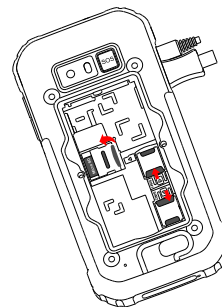



To reduce power consumption and energy waste, disconnect your charger when the battery is fully charged; switch off Bluetooth. In Settings you can also lower the brightness of the screen, and shorten the length of time before the screen goes to sleep.

IMPORTANT: IP68 means this phone is “dust-resistant” and can be “immersed in 1.5 meters of freshwater for up to 30 minutes. However it is emphasized to end users to tighten the screws on the battery cover and properly fit the rubber protections for USB port and headphone jack close to keep your phone from dust and water damage as this may cause the IP68 protection is not guaranteed.

1.2.2 Power on your phone

To turn your phone on, hold down the **End** key until the phone powers on. It will take a few seconds before the screen lights up. Press **Left soft key** to unlock your phone.

Set up your phone for the first time

The first time you power on the phone, you should set the following options:

- Select the phone's language, then press the Right soft key to continue.

Even if no SIM card is installed, your phone will still power on and you will be able to use some of the phone's features.

1.2.3 Power off your phone

To turn your phone off, hold down the **End** key.

1.3 Home screen

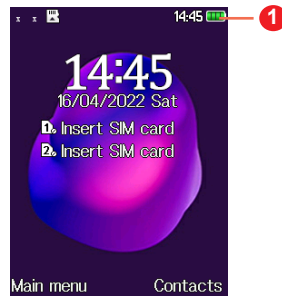

1 Status bar

- Status/Notifications





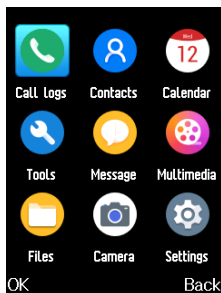





1.4 App list

Press the **Left soft key** or **OK key** from the Home screen to access the App list.



1.4.1 Status bar ⁽¹⁾

The Status bar appears at the top of your Home screen. Icons indicate your phone's status and new notification alerts appear in the Status bar.

	New message or multimedia message		No SIM card installed
	Silent mode		Alarm is set
	SD card installed		Bluetooth is on
	Level of network reception		Headset connected
	Flight mode		New voicemail

1.4.2 Change Home screen wallpaper

- From the Home screen, press the **OK key**, select the **Settings** icon , and then press the **Navigation key** to select **Phone settings > Display > Wallpaper settings > Static wallpaper** or **More pictures**.

⁽¹⁾ The icons and illustrations in this guide are provided for information purposes only.

- Select a new image and press the **Left soft key** to save. Exit and the new image will then be displayed on your Home screen.

2 Call logs

2.1 Making a call

Dial the desired number, press the **Call key** to place the call, or press the **Right soft key** to select a contact from **Contacts**. Use the up or down action of the **Navigation key** to select the desired contact and press the **Call key**. If you make a mistake, you can delete the incorrect digits by pressing the **Left soft key**. To hang up the call, press the **End key**.

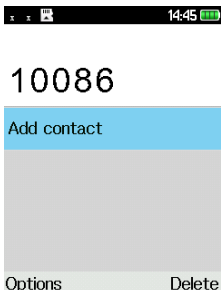

International call

To dial an international call, press  twice to enter

“+”, then enter the international country prefix followed by the full phone number and finally press the **Call key**.

Emergency call

If your phone has network coverage, dial the emergency number and press the **Call key** to make an emergency call.

2.2 Answer or decline a call

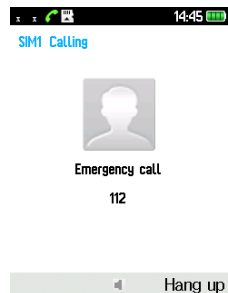

When you receive a call:

- Press the **Left soft key** or **Call key** to answer.
- Press the **Right soft key** or **End key** to decline.

2.3 Accessing voicemail ⁽¹⁾

- Press and hold  to call voicemail.

⁽¹⁾ Contact your network operator to check service availability.

- Follow the prompts to set up your voicemail account.

3 Contacts

3.1 Consult your Contacts

Contacts enables quick and easy access to the contact you want to reach.

You can access this function by:

- pressing the **OK** key from the Home screen and select **Contacts**.
- pressing the **Right soft key** from the Home screen.

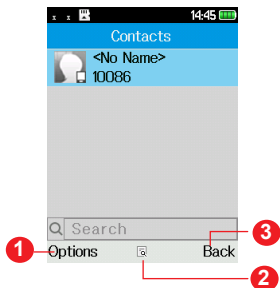

- 1 Press the **Left soft key** to access more options.
- 2 Press the **OK** key to enter contact details.
- 3 Press the **Right soft key** to return to the Home screen.

3.2 Adding a contact

In your contacts list screen, select **Add contacts**, or press the **Left soft key** to select **Options > New** to add new contacts with detailed information.

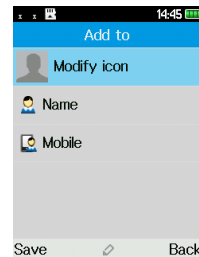

When finished, press the **Left soft key** to save.

3.3 Editing your contacts

Select a contact, press the **OK** key to access **Details**, select **Options > Edit**, and press the **OK** key to edit.

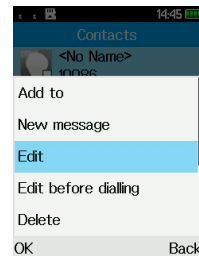

3.4 Deleting a contact

In your contacts list screen, press the **Left soft key** to access **Options**, select **Delete**, and press the **OK key** to delete.

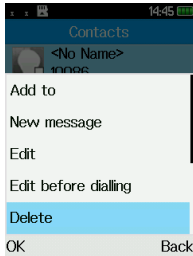

3.5 Available options

From the contact list, you can access the following options:

New message

Send an SMS/MMS to a contact you've selected from **Contacts**.

Import/Export

- **Import contacts**

Import contacts to your phone.

- **Export contacts**

Export contacts from your phone or SIM card.

Others

- **Set speed dial contacts**

Set one or more speed dial contacts at a time.

4 Calendar 12

Use the Calendar to keep track of important meetings, appointments, etc.

To access this function, press the **OK key** from the Home screen and select **Calendar**.

4.1 Multimode view

You can display the Calendar in Day, Week or Month view. Press the **Left soft key** and select **Options** to change your Calendar view.

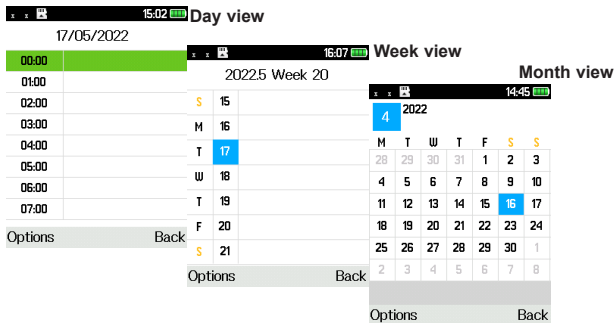

4.2 Add a new event

Press the **Left soft key** to add a new event from any Calendar view.

- Fill in all the required information for this new event. If it is a whole-day event, you can select **All-day event**.
- When finished, press the **Left soft key** to save.

More important options are available by pressing the **Left soft key** from the Calendar main screen:

- **Go to date**

To go to whatever date you want.

- **View events**

Press the **OK key** to view the events you've added to the **Calendar**.

4.3 Event reminder

If a reminder is set for an event, the upcoming event will appear on the screen when the reminder time arrives.

5 Tools

5.1 Alarm

Your phone has a built-in alarm clock with snooze feature. You can set up to five alarms with different wake-up times.

5.2 Calculator

Press the up, down, left, right and OK key to select "+, -, ×, ÷" and "=" respectively.

5.3 Bluetooth

You can exchange data, such as video, images, and audio, with other Bluetooth supported devices within a limited range after pairing.

5.4 Converter

Convert supports weight conversion and length conversion.

5.5 Fake call

You can create a fake call through this function. It helps you to politely escape from social situations at any time you wish.

5.6 Voice alarm

With this menu, you can create a voice file and set it as the alarm.

5.7 World clock

The first clock displays the time based on your location when you set up your phone. You can add other cities to show the time in their time zones.

5.8 SIM Toolkit

This phone supports various service functions. The specific items depend on your SIM card and network. The Service menu will be automatically added to the phone menu when supported by your network and SIM card.

Note: Consult the local network operator for related fees and set-up details.

5.9 Call Filter

You can create a call blacklist using this function.

From the **Call Filter** screen, the following options are available:

Blacklist

You can add contacts to the blacklist by using the following methods:

1. From **Blacklist > Options > New**

- Enter a name and number or press **OK** to select one contact from the **Contacts** list at a time, then press **Left soft key** to save.

2. From **Blacklist > Options > Import contacts**

- Select the contacts you want to add to the blacklist, then press **OK > Save**

Settings

Enable/disable the call and message functions for contacts on your blacklist.

5.10 Torch

Turn on/off the torch.

5.11 Browser

This function enables you to surf the Internet with your phone and customise your preferences.

Note: Consult with your service provider for related fees and specific setup information.

6 Message

Use the messaging feature to send and receive text (SMS) and multimedia (MMS) messages.

6.1 Write messages

- From the Home screen, press the **OK key** and select **Message**.
- Press the **OK key** to write text messages.
- Enter the phone number of the recipient in the **To** bar or press the **OK key** to add recipients.
- Press the **Message** bar to enter the text of the message.
- Press the **OK key** or **Left soft key** to send your messages.

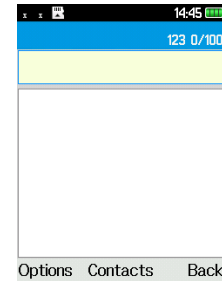

6.2 Send a multimedia message

MMS enables you to send video clips, images, photos, contacts and sounds. From the Message screen, select **Options > Add to** and select the attachment.

An SMS will be converted to MMS automatically when media files (image, video, audio, etc.) are attached.

6.3 How to type a message

When in edit mode, the default input method is English. You can press the Keypad to change the input method to access numbers 1,2,3... or long press the corresponding key to get the number you want.

You can enter text using predictive text input, or press # to set your desired text input.

- For normal text input, press a number key, 2-9, repeatedly until the desired character is displayed. If

the next letter you want is located on the same key as the present one, press the key repeatedly until the next cursor is displayed.

- Press the **#** key to switch between "abc--> ABC-> 123" modes.
- To insert a punctuation mark or special character, press the ***** key.
- If you want to delete any previously typed letters or symbols, press the **Right soft key** to delete them one by one.

6.4 Settings

SMS settings

- Message centre

You can view your message centre number here.

- Message validity period

You can set your message validity period as 1 hour, 6 hours, 24 hours, 72 hours, 1 week or Maximum.

- Status report

You can choose to enable or disable status reports.

- Reply path

Mark the checkbox to enable reply path.

- Preferred storage

Set the path for the location of your saved messages.

- Export SMS

Set the SMS path you want to export from.

- Auto signature

Select to apply an auto signature to your messages.

- Signature

Input your signature.

MMS settings

- MMS account

Select your data account for multimedia messages.

- Receive options

You can set receive settings.

- Send options

You can set send settings.

- File storage

You can set the path for the location of saved MMS files.

- Play audio

You can set whether or not to play audio files.

- Restore default.

Restore your phone to its default settings.

WAP Push messages

- WAP Push messages

Mark / unmark the checkbox to accept / reject WAP Push messages.

- Service loading operation

You can set **Service loading operation** as **Always**, **Alert** or **Never**.

7 Multimedia.....



7.1 Image

Image acts as a media player for you to view photos. In addition, a set of further picture operations are available for you to choose from.

To access this function, press the **OK key** from the Home screen and select **Multimedia > Image**.

You can select **Camera** to take a photo or select a picture from **Photos**.

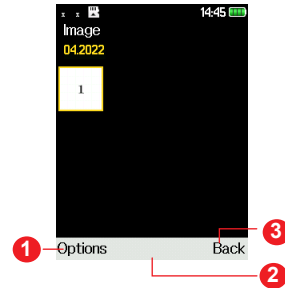

- 1 Press the **Left soft key** to access more options.
- 2 Press the **OK key** to view the selected picture.
- 3 Press the **Right soft key** to return to Multimedia.

Modifying your picture



More options are available by pressing the **Left soft key** from the picture screen.

- **Set as wallpaper**

Enables you to set the picture as wallpaper.

- **Screen saver**

Enables you to set the picture as screen saver.

- **Set as contact icon**

Enables you to set the picture as contact icon.

- **Delete**

Delete the selected picture.

- **Share**

Share the picture via MMS or Bluetooth.

- **Mark**

Mark the selected picture.

- **Rename**

Enables you to rename the picture.

- **Slideshow**

Press to view your **Gallery** pictures as a slideshow.

- **Details**

View picture information, such as name, size, image type, etc.

7.2 Video gallery

Use this function to play video files. Press **OK key** to play/pause the video player, short press up or down of **Navigation key** to tune volume, press left or right Navigation key to last or next video.

7.3 Recorder

Use this function to record audio files. The phone supports AMR. When completed, the file will be stored in Audio automatically.

8 Files

To access this function, press the **OK key** from the Home screen and select **Files**.

Your phone provides internal storage space for you to manage files and also supports a micro SD card. The contents of the micro SD card are editable. You can create a new folder and delete, edit, search, mark, and view the details and files it contains.

9 Camera

Your mobile phone is equipped with a camera for taking photos and shooting videos.

9.1 Camera

To access this function, press the **OK key** from the Home screen and select **Camera**.

To take a picture

The screen acts as the viewfinder. Position the object or landscape in the viewfinder, and press the **OK key** to take pictures, it will be automatically saved, or press **Left soft key**  to save.

9.2 Video

To shoot a video

- Press the **Left soft key** to switch to Video mode from Camera mode.
- Press the **OK key** to shoot a video.
- When finished, press the **Left soft key** to save. You can view the file by selecting **Options > View video directory**.

10 Settings

To access this function, press the **OK key** from the Home screen and select **Settings**.

10.1 Phone settings

To modify the Phone settings, select Phone settings and you will see **Display**, **Time & date**, **Language settings**, **Shortcut settings** and **Auto power on/off**.

- **Display**

This function allows you to select Wallpaper settings, Idle display settings, Set screensavers, Contrast, Backlight and Keypad backlight time.

- **Time & date**

It allows you to modify date and time settings, including 12/24h format and date format (Year-Mon-Day/Mon-Day-Year/Day-Mon-Year). You can also choose to update the time display automatically by selecting **Update settings > Auto update time**.

- **Language settings**

Choose the display language for messages here. You can choose **display language** and **input language** in this menu.

- **Shortcut settings**

Set shortcuts for Up, Down, Left and Right key.

- **Auto power on/off**

You can set the power on/off times using this function.

10.2 Call settings

- **Dual-SIM**

You can set **Standby mode**, **Reply by original SIM**, and **Set SIM name**.

- **Call divert**

You can activate, cancel or verify the status of call forwarding to voicemail or to a specified number. The following configurations are possible:

Call forwarding unconditional: systematic forwarding of all your calls.

Call forwarding on busy: if your line is busy, if you don't answer or if you are outside the network range.

Call forwarding on no reply: if you do not want to reply.

Divert if unreachable

Cancel all divers

- **Call waiting**

Activate/Deactivate the notification of a second incoming call by a beep. You can also check the status of waiting calls.

- **Call barring**

The following configurations are possible:

All outgoing calls

All outgoing calls are barred.

All incoming calls

All incoming calls are barred.

Incoming calls when roaming

All incoming calls are barred when roaming.

- **ISD calling**

All ISD calls are barred.

Outgoing calls when roaming

Outgoing international calls except those to your country of subscription are barred.

Cancel all barring

Deactivate all call barring.

- **Hide ID**

You can choose to hide ID, show your number or display ID by network.

- **Others**

You can activate/deactivate **Call time minute reminder**, **Vibration when connected**, **Reply SMS after reject** and **Auto record voice calls** in this menu.

10.3 Profiles

With this menu, you can set the sound mode to **Normal**, **Silent**, **Meeting**, **Flight mode**, **Indoor** or **outdoor**.

10.4 Network selection

Network connection can be switched between **Auto select** and **Manual select**.

10.5 Connections

- **Network account**

You can set your network account.

- **GPRS service**

You can turn on/off GPRS service according to your need.

- **Data roaming**

Data services can be used while roaming overseas.

- **Prefer SIM**

Select SIM1 or SIM2 as your preferred SIM.

- **Preferred network type**

You can select **4G/3G/2G Multi mode**, **3G/2G Dual mode**, **2G Only mode** as your preferred network type.

- **VoLTE**

Your device supports VoLTE function, mark the checkbox to activate it. Consult with the operator to get more details.

10.6 Security

You can protect your phone by activating and changing the PIN and password, its initial one is 1234. This feature also allows you to lock your phone by activating the **PIN2** for **Fixed dial number**.

- **PIN**

The SIM card protection code is requested each time the phone is powered on.

- **Modify PIN2**

A protection code for certain SIM card features (FDN) will be requested if you attempt to access the card when the code is activated. Select to update it with a new one (between 4 and 8 digits).

- **Phone locked**

An unlock code is requested each time the phone is powered on.

- **Modify the phone password**

Change the phone's password (the initial one is 1234).

- **Privacy**

This allows applications to be locked. Enter the password, (the initial one is 1234) and mark the checkbox to activate the lock for **Call logs**, **Messages**, **Camera**, **Contacts**, **Files**, **Ebook**,

Calendar, USB, Audio player and Video player.

- **Auto keypad lock**

You can activate/deactivate the Auto keypad lock and set a time for it.

- **Lock screen by end-key**

After enabling this function, you can press **End Key** to lock the screen.

- **Fixed Dialling Number**

This allows the phone to be "locked" so that it can only dial certain numbers, or numbers with certain prefixes. To activate this function, a PIN2 code is mandatory.

10.7 Assistance (SOS)

To configure SOS functions, please go to the menu **Settings > Assistance(SOS)**.

- **Contact list**

To add an SOS number to your SOS contacts, select **Settings\Assistance (SOS) \Contacts list** and press **Options\Edit**, then you can edit your SOS numbers.

- **Message**

From the main menu select **Settings\Assistance (SOS)\Message** to create an SOS message.

- **SOS settings**

Mark/unmark the checkbox to enable/disable Assistance (SOS)

- **Help**

Read **Help** for more information.

10.8 Update

If you want to update the system, select **check for updates** and when that's finished, your phone will have the latest version of the software.

10.9 Regulatory & Safety

View information about your phone, such as **Product Model, Manufacturer Name, IMEI, CU Reference**, etc.

10.10 Restore factory settings

Make the phone's settings return to their default values. End-user data will be erased. Enter the default password 1234 to confirm restore and reboot.

10.11 About

You can view **Privacy and User Terms**.

11 Troubleshooting

Before contacting the service centre, you are advised to follow the instructions below:

- You are advised to fully charge the battery for optimal operation.
- Avoid storing large amounts of data in your phone as this may affect its performance.
- Use the FOTA (Firmware Over The Air) Upgrade tool to update your phone's software. To access Update phone, press Settings\Update\Check for updates.

and carry out the following checks:

My phone can't be switched on or is frozen

- Check the battery contacts, remove and reinstall your battery, then turn your phone on.
- Check the battery power level, charge for at least 20 minutes.

My phone has not responded for several minutes

- Restart your phone by pressing and holding the **End key**.
- Remove the battery and re-insert it, then restart the phone.

My phone turns off by itself

- Check whether your phone is locked when not in

use, and make sure you don't accidentally turn off your phone when locking it by pressing the **End key**.

- Check the battery charge level.

My phone can't charge properly

- Make sure you are using an **TCL** battery and the charger from the box.
- Make sure your battery is inserted properly and clean the battery contact if it's dirty. It must be inserted before plugging in the charger.
- Make sure that your battery is not completely discharged; if battery power is empty for a long time, it may take around 20 minutes to display the battery charger indicator on the screen.
- Make sure charging is carried out under normal conditions (0°C to +40°C).
- When abroad, check that the voltage input is compatible.

My phone can't connect to a network or "No service" is displayed

- Try connecting in another location.
- Verify the network coverage with your operator.
- Check with your operator that your SIM card is valid.
- Try selecting the available network(s) manually.
- Try connecting at a later time if the network is overloaded.

My phone can't connect to the Internet

- Check that the IMEI number (press *#06#) is the same as the one printed on your warranty card or box.
- Make sure that the internet access service of your SIM card is available.
- Check your phone's Internet connection settings.
- Make sure you are in a place with network coverage.
- Try connecting at a later time or another location.

Invalid SIM card

- Make sure the SIM card has been correctly inserted.
- Make sure the chip on your SIM card is not damaged or scratched.
- Make sure the service of your SIM card is available.

Unable to make outgoing calls

- Make sure you have dialled a valid number and have pressed the **call key**.
- For international calls, check the country and area codes.
- Make sure your phone is connected to a network, and the network is not overloaded or unavailable.
- Check your subscription status with your operator (credit, SIM card valid, etc.).
- Make sure you have not barred outgoing calls.
- Make sure that your phone is not in flight mode.

Unable to receive incoming calls

- Make sure your phone is switched on and connected to a network (check if the network is overloaded or unavailable).
- Check your subscription status with your operator (credit, SIM card valid, etc.).
- Make sure you have not forwarded incoming calls.
- Make sure that you have not barred certain calls.
- Make sure that your phone is not in flight mode.

The caller's name/number does not appear when a call is received

- Check that you have subscribed to this service with your operator.
- Your caller has concealed his/her name or number.

I can't find my contacts

- Make sure your SIM card is not broken.
- Make sure your SIM card is inserted properly.
- Import all contacts stored in SIM card to phone.

The sound quality of the calls is poor

- You can adjust the volume during a call by pressing the **Volume Up/down** key.
- Check the network strength .
- Make sure that the receiver, connector or speaker on your phone is clean.

I am unable to use the features described in the

manual

- Check with your operator to make sure that your subscription includes this service.
- Make sure this feature does not require an **TCL** accessory.

When I select a number from my contacts, the number can't be dialled

- Make sure that you have correctly recorded the number in your file.
- Make sure that you have selected the country prefix when calling a foreign country.

I am unable to add a contact to my contacts

- Make sure that your SIM card contacts are not full; delete some files or save the files in the phone contacts.

My callers are unable to leave messages on my voicemail

- Contact your network operator to check service availability.

I can't access my voicemail

- Make sure your operator's voicemail number is correctly entered.
- Try later if the network is busy.

I am unable to send and receive MMS

- Check your phone memory availability as it might

be full.

- Contact your network operator to check service availability and check MMS parameters.
- Verify the server centre number or your MMS profile with your operator.
- The server centre may be busy, try again later.

SIM card PIN locked

- Contact your network operator to obtain the PUK code (Personal Unblocking Key).

The phone can't be detected by others via Bluetooth

- Make sure that Bluetooth is turned on and your phone is visible to other users.
- Make sure that the two phones are within Bluetooth's detection range.

How to ensure water resistance of the device?

- **Battery Cover Waterproof Ring:** before installing the provided battery cover, make sure that the waterproof ring is flat and secure within the cover so that it does not easily fall out.
- **Battery Cover Screws:** ensure that the screws cannot be tightened any further.
- **Waterproof Silicone Stopper:** make sure that this is pressed tightly against the device.

How can I transfer data between my phone and

PC?

- If you want to transfer data between a memory card/ SD card and your PC, connect your phone to the PC via the user data cable and select "USB" on your phone. You will then be able to transfer data between the two locations.

12 Specifications

Processor	UMS 9117
Platform	Thread X
Memory	128MB ROM + 64MB RAM
Dimensions (LxWxT)	133.2x64.9x16.15mm
Weight	134g
Display	2.4 inch main LCD screen
Network	GSM 900/1800 UMTS B1/8 LTE B1/3/7/8/20/28(full) (Band frequency and data speed are operator dependent.)

Connectivity	<ul style="list-style-type: none">• Bluetooth 5.1• 3.5 mm audio jack• micro-USB
Camera	<ul style="list-style-type: none">• 2 MP
Audio supported formats	AMR-NB, AMR-WB, PCM, ADPCM, WMA, EVS, MID.
Video supported formats	H263, H264
Battery ⁽¹⁾	Capacity: 2200 mAh
Expansion Slot	microSD [™] memory card (Availability of microSD card depends on market)

Note: Specifications are subject to change without prior notice.

⁽¹⁾ The original battery has undergone rigorous safety inspections to meet qualification standards, the use of non-original batteries may be dangerous.

13 Accessories

Standard accessories

- Battery
- Charger
- Quick Start Guide
- Product Safety Information leaflet



Only use the TCL batteries, chargers, and accessories along with your device.

14 Licences



The Bluetooth word mark and logos are owned by the Bluetooth SIG, Inc. and any use of such marks by TCL Communication Ltd. and its affiliates is under licence. Other trademarks and trade names are those of their respective owners.

**TCL 3189D Bluetooth Declaration ID
D049911**