



Questo manuale d'istruzione è fornito da trovaprezzi.it. Scopri tutte le offerte per [Tefal FR3140 Super Uno](#) o cerca il tuo prodotto tra le [migliori offerte di Friggitrici](#)

 **trovaprezzi.it**

Questo manuale d'istruzione è fornito da trovaprezzi.it. Scopri tutte le offerte per [Tefal FR3140 Super Uno](#) o cerca il tuo prodotto tra le [migliori offerte di Friggitrici](#)

# super uno



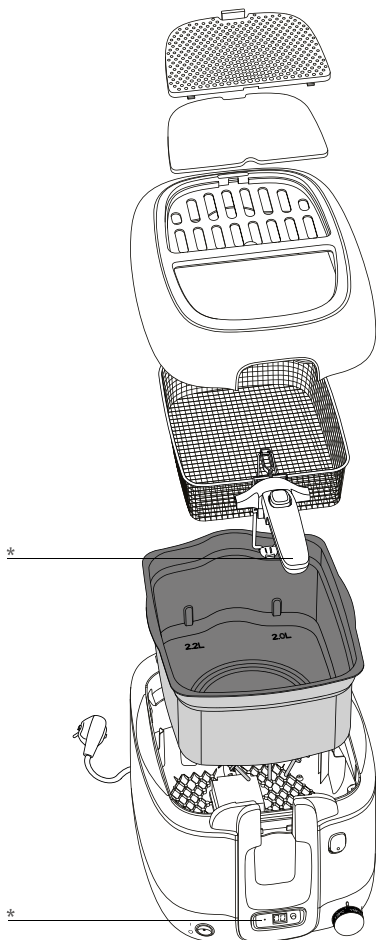

\* Selon modèle • Afhankelijk van het model • Je nach Modell • Depending on model • Secondo i modelli • Según modelo • Consoante o modelo • ανάλογα με το μοντέλο • Modele göre • Afhængig af model • Beroende på modell • Avhenger av modell • Mallista riippuen • Ovisno o modelu • Zavisno od modela • в зависимости от модели • Odvisno od modela • W zależności od typu • Podle modelu • V závislosti od modelu • Modelltöl fúggþen • В зависимости от модели • Залежно від моделі • Ovisno o modelu • Söltuvalt mudelist • Atbilstoši modelim • Pagal modelį • حسب العوديل • بر حسب مدل • afhængig af modellen • beroende på modell • avhengig av modell • mallista riippuen • Залежно від моделі • үлгіге байланысты • vastavalt mudelitele • atkarībā no modela • pagal modelių • zależnie od modelu • у зависимости од модела • glede na model • zavisno od modela • в зависимости от модели • în funcție de model • 視乎型號而定 • 모델에 따라 다름 • မကွဲကွဲအတိုင်းပေါ်မူတည်သည် • bergantung pada model

2

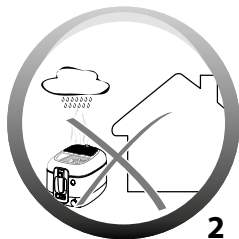

2

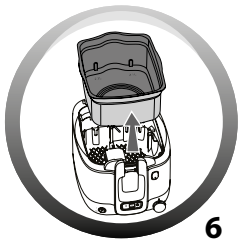
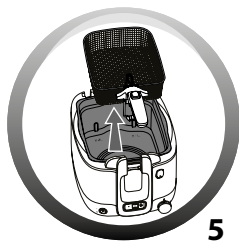
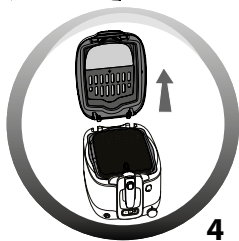
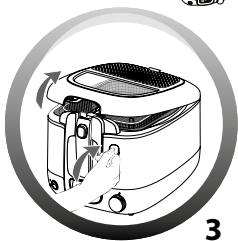

2

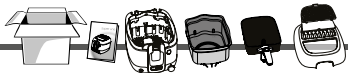

9

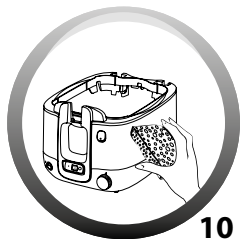

10

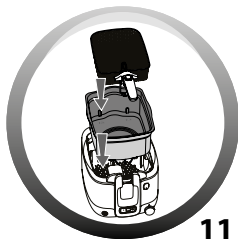

11

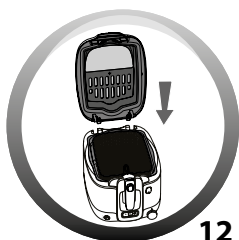

12

3

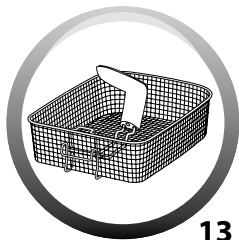

13

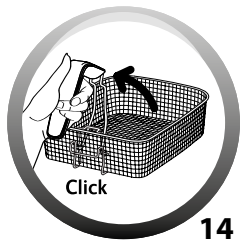

Click

14

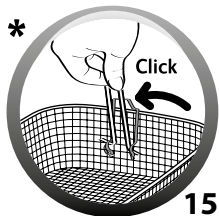

Click

15

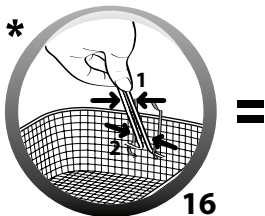

16

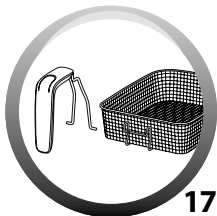

17

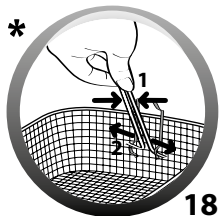

18

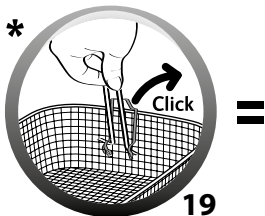

Click

19

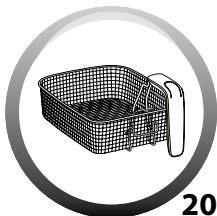

20

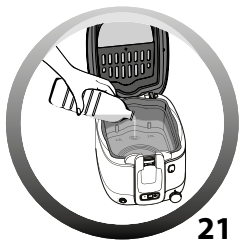
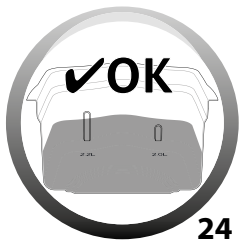
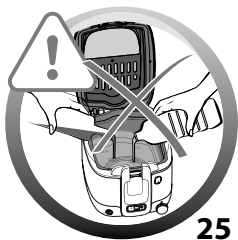
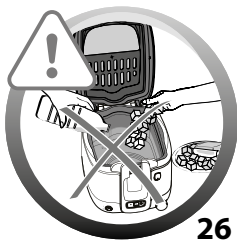
**4****Min. 2 L / Max. 2,2 L****21****22****23****24****25****26**

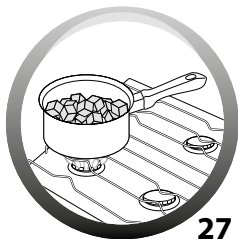
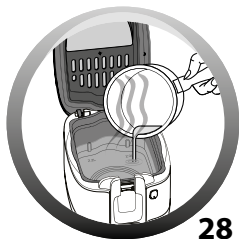
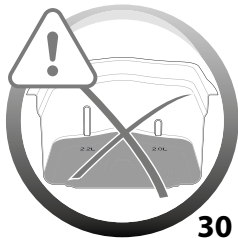
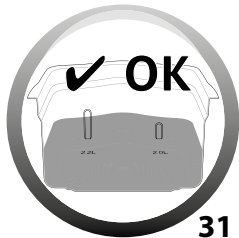
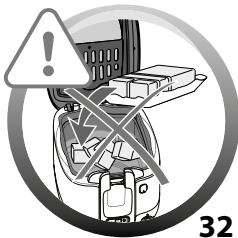
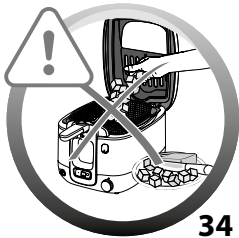
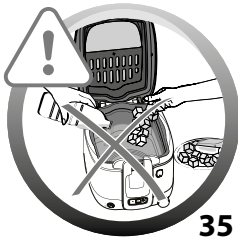
**5****Min. 1,75 Kg / Max. 2 Kg****27****28****29****30****31****32****33****34****35**

6



Max 1,4 Kg

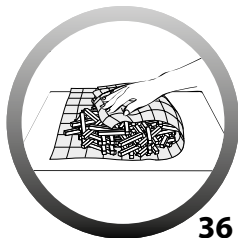

36

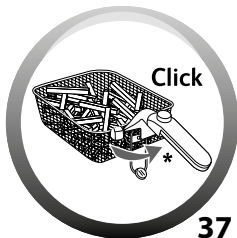

37



38



Max 1 Kg

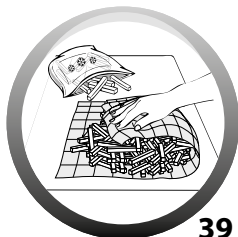

39

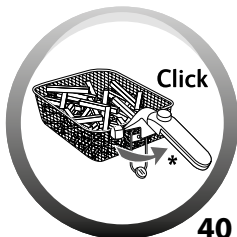

40



41

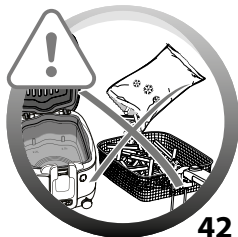

42

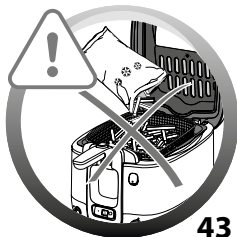

43

7

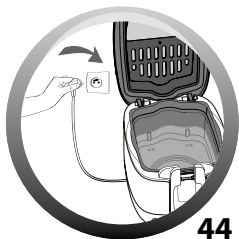

44

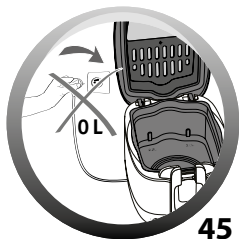

45

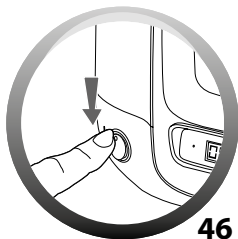

46

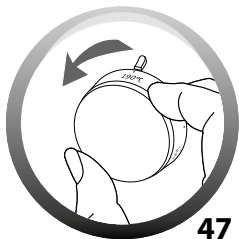

47

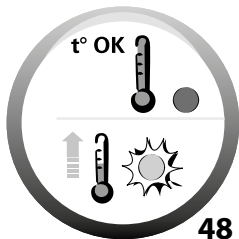

48

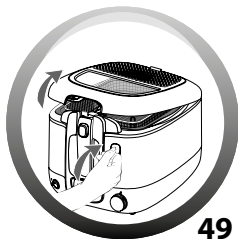

49

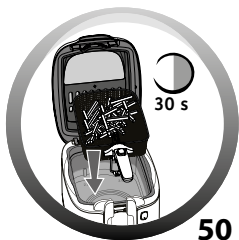

50

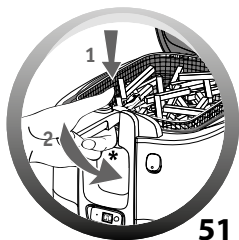

51

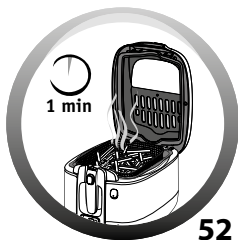

52

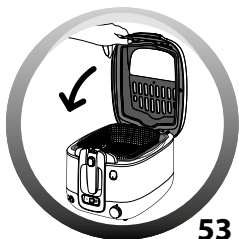

53

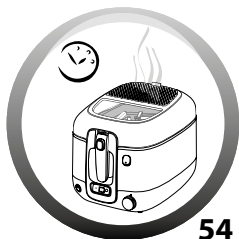

54

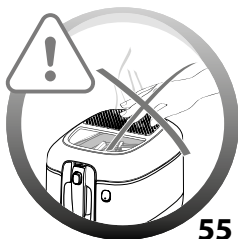

55

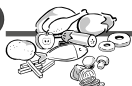

	Nb			
		1400 g	1) 170°C	10-12 min
			2) 190°C	8-10 min
		1300 g	190°C	19-22 min
	5		180°C	14-16 min
	2		170°C	4-6 min
	8-10		190°C	4-5 min
	7		170°C	2-4 min
	8		170°C	2-3 min
	6		180°C	2 x 2 min
	Nb			
		1000 g	190°C	14-17 min
		1500 g	190°C	9-11 min
		150 g	180°C	4-5 min
	8		180°C	3-5 min
	11		190°C	4-5 min
	10		180°C	2-3 min
	5		180°C	4-5 min

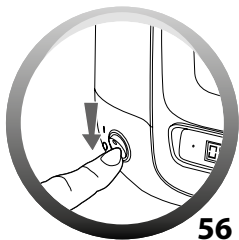

56

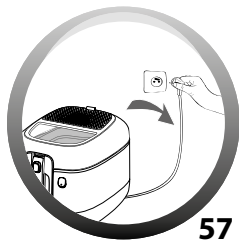

57

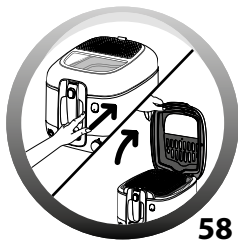

58

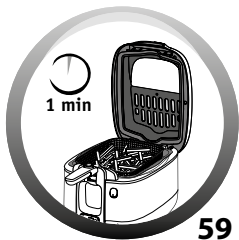

59

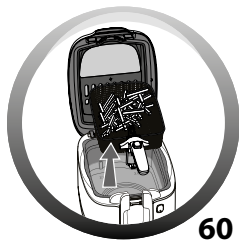

60

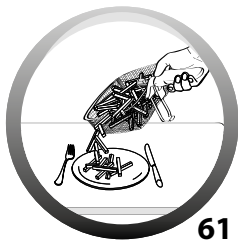

61

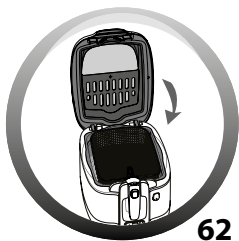

62

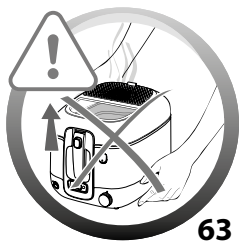

63

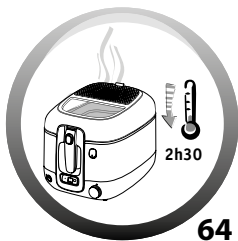

64

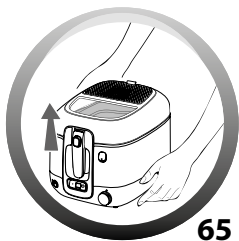

65

10

\*

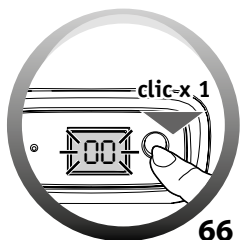
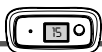

66

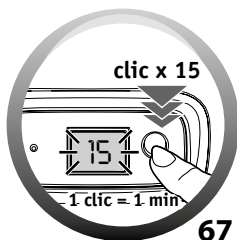

67

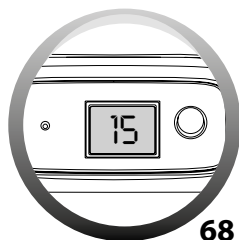

68

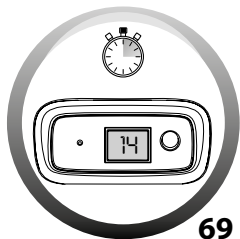

69

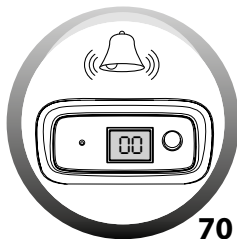

70

11

\*

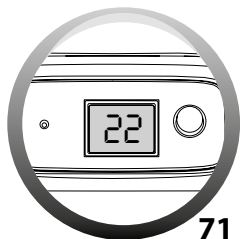
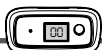

71

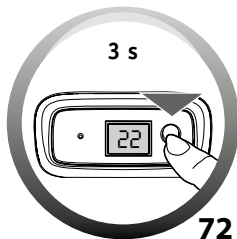

72

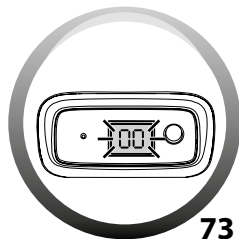

73

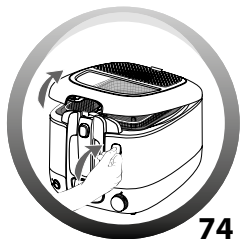

74

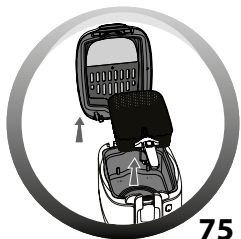

75

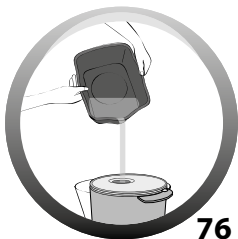

76

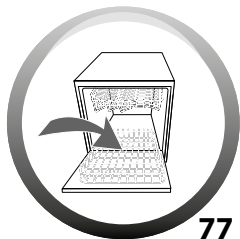

77

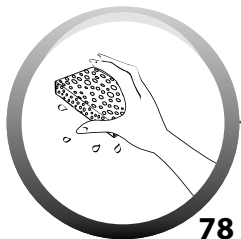

78

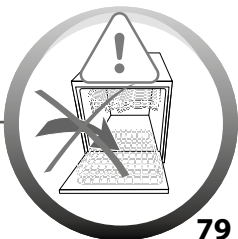

79

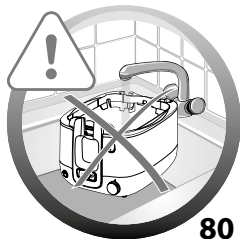
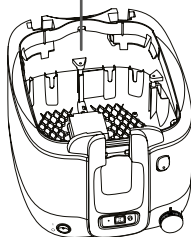
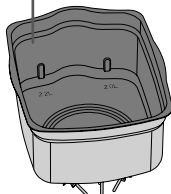
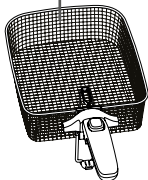
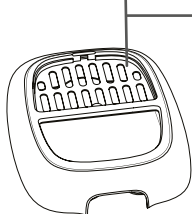

80

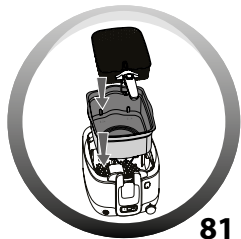

81

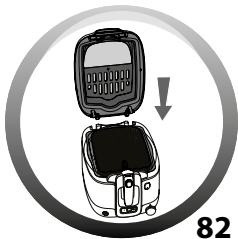

82

13



12 x

Max



83

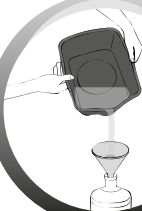

84



85

14



80 x

Max



86



87



88



89



Ref : XA005000

90



91

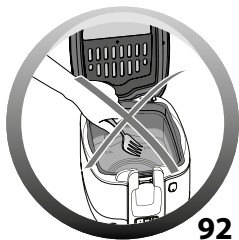

92



93

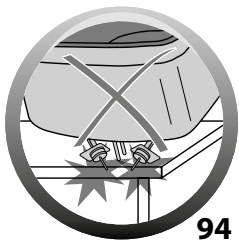



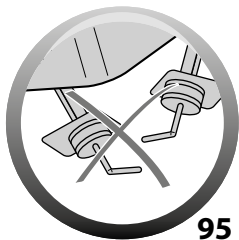

94



95

# INTERNATIONAL GUARANTEE COUNTRY LIST

## SMALL HOUSEHOLD APPLIANCES

			
<b>ARGENTINA</b>	0800-122-2732	2 años 2 years	GRUPE SEB ARGENTINA S.A. Billinghurst 1833 3° C1425DTK Capital Federal Buenos Aires
<b>ՀԱՅԱՍՏԱՆ ARMENIA</b>	010 55-76-07	2 տարի 2 years	SEB Ուկրաինիա խումբը ընկերություն Խարկովի խճուղի, 175, Կիև, 02121 Ուկրաինա
<b>AUSTRALIA</b>	1300307824	1 year	Groupe SEB Australia PO Box 404 North Ryde, NSW, 1670
<b>ÖSTERREICH AUSTRIA</b>	01 890 3476	2 Jahre 2 years	GRUPE SEB DEUTSCHLAND GmbH Theodor-Stern-Kai 1 60596 Frankfurt
<b>البحرين BAHRAIN</b>	17716666	1 year	www.tefal-me.com
<b>БЕЛАРУСЬ BELARUS</b>	017 3164208	2 года 2 years	ЗАО «Группа СЕБ-Восток», Москва, 125171, Ленинградское шоссе, д.16А, строение 3, помещение XII
<b>BELGIQUE BELGIE BELGIUM</b>	070 23 31 59	2 ans 2 jaar 2 years	GRUPE SEB BELGIUM SA NV 25 avenue de l'Espérance - ZI 6220 Fleurus
<b>BOSNA I HERCEGOVINA</b>	Info-linija za potrošače 033 551 220	2 godine 2 years	SEB Developpement Predstavništvo u BiH Valtera Perića 6/I 71000 Sarajevo
<b>BRASIL BRAZIL</b>	11 2060 9777	1 ano 1 year	Seb Comercial gAv Jornalista Roberto Marinho, 85, 19º andar 04576 – 010 São Paulo - SP
<b>БЪЛГАРИЯ BULGARIA</b>	0700 10 330	2 години 2 years	Груп Себ България ЕООД бул. България 58 С, ет 9, офис 30 1680 София
<b>CANADA</b>	1-800-418-3325	1 an 1 year	Groupe SEB Canada Inc. 36 Newmill Gate, Unit 2 Scarborough, ON M1V 0E2
<b>CHILE</b>	02 2 884 46 06	2 años 2 years	GRUPE SEB CHILE Comercial y Servicios Plus Service Ltda Avenida Santa María 0858, Providencia - Santiago
<b>COLOMBIA</b>	018000520022	2 años 2 years	GRUPE SEB COLOMBIA Apartado Aereo 172, Kilometro 1 Via Zipaquirá Cajica Cundinamarca
<b>HRVATSKA CROATIA</b>	01 30 15 294	2 godine 2 years	SEB mku & p d.o.o. Sarajevska 29, 10000 Zagreb

<b>ČESKÁ REPUBLIKA CZECH REPUBLIC</b>	731 010 111	2 roky 2 years	Groupe SEB ČR s.r.o. Futurama Business Park (budova A) Sokolovská 651/136a 186 00 Praha 8
<b>DANMARK DENMARK</b>	43 350 350	2 år 2 years	Groupe SEB Denmark A/S Delta Park 37, 3. sal 2665 Vallensbæk Strand
<b>مصر EGYPT</b>	16622	سنة واحدة 1 year	جروب سب ايجيبت القاهرة: ١٢١ شارع الحجاز، مصر الجديدة الإسكندرية: طريق أمبو، سموحة
<b>EESTI ESTONIA</b>	668 1286	2 aastat 2 years	Groupe SEB Polska Sp. z o.o. Gdański Business Center II D ul. Inflancka 4C 00-189 Warsaw
<b>SUOMI FINLAND</b>	09 8946 150	2 vuotta 2 years	Groupe SEB Finland OY Pakkalankuja 6 01510 Vantaa
<b>FRANCE Continentale + Guadeloupe, Martinique, Réunion, St-Martin</b>	09 74 50 47 74	2 ans 2 years	GRUPE SEB France Service Consommateur Tefal 112 Ch. Moulin Carron, TSA 92002 69134 ECULLY Cedex
<b>DEUTSCHLAND GERMANY</b>	0212 387 400	2 Jahre 2 years	GRUPE SEB DEUTSCHLAND GmbH Theodor-Stern-Kai 1 60596 Frankfurt
<b>ELLADA GREECE</b>	2106371251	2 χρόνια 2 years	SEB GROUPE ΕΛΛΑΔΟΣ Α.Ε. Καβαλιεράτου 7 Τ.Κ. 145 64 Κ. Κηφισιά
<b>香港 HONG KONG</b>	8130 8998	1 year	SEB ASIA Ltd. 9/F, South Block, Skyway House 3 Sham Mong Road, Tai Kok Tsui, Kowloon Hong-Kong
<b>MAGYARORSZÁG HUNGARY</b>	06 1 801 8434	2 év 2 years	GRUPE SEB CENTRAL-EUROPE Kft. 2040 Budaörs, Puskás Tivadar út 14
<b>INDONESIA</b>	+62 21 5793 7007	1 year	PT GROUPE SEB INDONESIA MSD TCC Batavia Bld, Jl. K.H. Mas Mansyur No. 126, Karet Tengsin, Tanah Abang, Kota Jakarta Pusat, Daerah Khusus Ibukota Jakarta 10250, Indonesia
<b>ITALIA ITALY</b>	1 99 207 354	2 anni 2 years	GRUPE SEB ITALIA S.p.A. Via Montefeltro, 4 20156 Milano
<b>日本 JAPAN</b>	0570-077772	1年 1 year	株式会社 グループセブ ジャパン 〒107-0062 東京都港区南青山 1-1-1 新青山ビル 東館 4階
<b>الأردن JORDAN</b>	5665505	1 year	www.tefal-me.com

<b>ҚАЗАҚСТАН KAZAKHSTAN</b>	727 378 39 39	2 жыл 2 years	ЖАҚ "ГРУППА СЕБ-ВОСТОК", Мәскеу, 125171, Ленинград тас жолы, 16А үй, 3- құрылыс, XII-ғимарат
<b>한국 KOREA</b>	080-733-7878	1 year	(유)그룹 세브 코리아 서울특별시 종로구 종로1길 50, 더케이타워 B동 14층 03142
<b>الكويت KUWAIT</b>	1807777 Ext :2104	1 year	www.tefal-me.com
<b>LATVJA LATVIA</b>	6 616 3403	2 gadi 2 years	Groupe SEB Polska Sp. z o.o. Gdański Business Center II D ul. Inflancka 4C 00-189 Warsaw
<b>لبنان LEBANON</b>	4414727	1 year	www.tefal-me.com
<b>LIETUVA LITHUANIA</b>	5 214 0057	2 metai 2 years	Groupe SEB Polska Sp. z o.o. Gdański Business Center II D ul. Inflancka 4C 00-189 Warsaw
<b>LUXEMBOURG</b>	0032 70 23 31 59	2 ans 2 years	GRUPE SEB BELGIUM SA NV 25 avenue de l'Espérance - ZI 6220 Fleurus
<b>МАКЕДОНИЈА MACEDONIA</b>	(02) 20 50 319	2 години 2 years	Груп Себ България ЕООД бул. България 58 С, ет 9, офис 30 1680 София
<b>MALAYSIA</b>	603 7802 3000	2 years	GRUPE SEB MALAYSIA SDN. BHD Unit No. 402-403, Level 4, Uptown 2, No. 2, Jalan SS21/37, Damansara Uptown, 47400, Petaling Jaya, Selangor D.E Malaysia
<b>MEXICO</b>	(55) 52839354	1 año 1 year	Groupe Seb México S.A. de C.V. Calle Boulevard Miguel de Cervantes, Saavedra No 169 Piso 9, Col Ampliación Granada, C.P. 11520, Ciudad de México
<b>MOLDOVA</b>	22 224035	2 роки 2 years	ТОВ «Груп СЕБ Україна», Харківське шосе, 175, Київ, 02121, Україна
<b>NEDERLAND The Netherlands</b>	0318 58 24 24	2 jaar 2 years	GRUPE SEB NEDERLAND B.V. De Schutterij 27 3905 PK Veenendaal
<b>سلطنة عُمان OMAN</b>	24703471	1 year	www.tefal-me.com
<b>POLSKA POLAND</b>	801 300 420 koszt jak za połączenie lokalne	2 lata 2 years	Groupe SEB Polska Sp. z o.o. Gdański Business Center II D ul. Inflancka 4C 00-189 Warsaw

<b>PORTUGAL</b>	808 284 735	2 anos 2 years	GRUPE SEB IBÉRICA SA Urb. da Matinha Rua Projectada à Rua 3 Bloco1 - 3º B/D 1950 - 327 Lisboa
قطر <b>QATAR</b>	44485555	1 year	www.tefal-me.com
<b>REPUBLIC OF IRELAND</b>	01 677 4003	2 years	GRUPE SEB IRELAND Unit B3 Aerodrome Business Park, College Road, Rathcoole, Co. Dublin
<b>ROMANIA</b>	0 21 316 87 84	2 ani 2 years	GRUPE SEB ROMÂNIA Str. Ernil Pangratti nr. 13 011881 București
РОССИЯ <b>RUSSIA</b>	495 213 32 30	2 года 2 years	ЗАО «Группа СЕБ-Восток», Москва, 125171, Ленинградское шоссе, д.16А, строение 3, помещение XII
المملكة العربية السعودية <b>SAUDI ARABIA</b>	920023701	2 years	www.tefal-me.com
<b>SRBIJA SERBIA</b>	060 0 732 000	2 godine 2 years	SEB Developpement Đorđa Stanojevića 11b 11070 Novi Beograd
<b>SINGAPORE</b>	6550 8900	2 years	GRUPE SEB (Singapore) Pte. Ltd. 3A International Business Park #12-04/05, ICON@IBP Singapore 609935
<b>SLOVENSKO SLOVAKIA</b>	232 199 930	2 roky 2 years	GRUPE SEB Slovensko, spol. s r.o. Cesta na Senec 2/A 821 04 Bratislava
<b>SLOVENIJA SLOVENIA</b>	02 234 94 90	2 leti 2 years	GRUPE SEB Slovensko, spol. s r.o. Cesta na Senec 2/A 821 04 Bratislava
<b>ESPAÑA SPAIN</b>	933 06 37 65	2 años 2 years	GRUPE SEB IBÉRICA S.A. C/ Almogàvers, 119-123, Complejo Ecurban 08018 Barcelona
<b>SVERIGE SWEDEN</b>	08 629 25 00	2 år 2 years	TEFAL - OBH Nordica Group AB Löfströms Allé 5 172 66 Sundbyberg
<b>SUISSE SCHWEIZ SWITZERLAND</b>	044 837 18 40	2 ans 2 Jahre 2 years	GRUPE SEB SCHWEIZ GmbH Thurgauerstrasse 105 8152 Glattpark
ประเทศไทย <b>THAILAND</b>	02 765 6565	2 years	GRUPE SEB THAILAND 2034/66 Italthai Tower, 14th Floor, n° 14-02, New Phetchburi Road, Bangkapi, Huaykwang, Bangkok, 10320
<b>TÜRKIYE TURKEY</b>	444 40 50	2 YIL 2 years	GRUPE SEB ISTANBUL AS Dereboyu Cd. Bilim Sk. Sun Plaza No:5 K:2 Maslak 34398 Istanbul
الإمارات العربية المتحدة <b>UAE</b>	8002272	1 year	www.tefal-me.com

<b>Україна UKRAINE</b>	044 300 13 04	2 роки 2 years	ТОВ «Груп СЕБ Україна», Харківське шосе, 175, Київ, 02121, Україна
<b>UNITED KINGDOM</b>	0345 602 1454	2 years	GRUPE SEB UK LTD Riverside House, Riverside Walk Windsor, Berkshire, SL4 1NA
<b>U.S.A.</b>	800-395-8325	1 year	GRUPE SEB USA 2121 Eden Road Millville, NJ 08332
<b>VIETNAM</b>	1800-555521	2 năm 2 years	Vietnam Fan Joint Stock Company 25 Nguyen Thi Nho Str, Ward 9, Tan Binh Dist, HCM city

24/09/2019

## INTERNATIONAL GUARANTEE

**Date of purchase** / Date d'achat / Fecha de compra / Købsdato / Ostopäivä / Kjøpsdato / Inköpsdatum / Ostukuupäev / Pirkuma datums / Įsigijimo data / Data zakupu / Datum izročitve blaga / Datum kupovine / Vásárlás dátuma / Data achiziției / Дата на закупуване / Дата продажи / Чашбурһи ор. / Дата продажн / Сатылган күні / 購入日 / วันที่ซื้อ / 구입일자 / Датум на купување :

**Product reference** / Référence produit / Referencia del producto / Referencenummer / Tuotenumero / Artikelnummer / Produktreferens / Toote viitenumber / Produkta atsauces numurs / Gaminio numeris / Referența produktu / Oznaka proizvoda / Tip aparata / Készülék típusa / Cod produs / Модел / Модель / Униќа. / Модель / Үлгісі / 製品リファレンス番号 / **รุ่นผลิตภัณฑ์** / 제품명 / Податоци за производот:

**Retailer name and address** / Nom et adresse du revendeur / Nombre y dirección del minorista / Forhandler navn & adresse / Jälleenmyyjän nimi ja osoite / Forhandler navn og adresse / Återförsäljarens namn och adress / Müüja kauplus ja aadress / Veikala nosaukums un adrese / Parduotuvės pavadinimas ir adresas / Nazwa i adres sprzedawcy / Naziv i adresa prodajnog mjesta / Naziv in naslov trgovine / Forgalmazó neve és címe / Numele și adresa vânzătorului / Търговки обект / Назва та адреса продавця / Чашбурһи рәжуи ын чашбурһи и хууги. / Название и адрес продавца / Сатушының атауы мен мекен-жайы / 販売店名、住所 / **ชื่อและที่อยู่ของห้าง/วันที่ซื้อ** / 소매점 이름과 주소 / Име и адреса на продавач :

**Distributor stamp** / Cachet / Sello del distribuidor / Forhandler stempel / Jälleenmyyjän leima / Forhandler stempel / Återförsäljarens stämpel / Tempel / Zimogs / Antspaudas / Pieczęć sprzedawcy / Pečat distributera / Pečat trgovine / Forgalmazó pecsétje / Ștampila vânzătorului / Печат на търговския обект / Печатка продавця / Чашр. / Печать продавца / Сатушының мөрі / 販売店印 / **ตราประทับของห้าง/วันที่ซื้อ** / 소매점 직인 / Печат на дистрибутер :



