



Questo manuale d'istruzione è fornito da trovaprezzi.it. Scopri tutte le offerte per [TP-Link Archer VR2100v](#) o cerca il tuo prodotto tra le [migliori offerte di Modem e Router](#)



Questo manuale d'istruzione è fornito da trovaprezzi.it. Scopri tutte le offerte per [TP-Link Archer VR2100v](#) o cerca il tuo prodotto tra le [migliori offerte di Modem e Router](#)



User Guide

AC2100 Wireless MU-MIMO VDSL/ADSL Modem Router
Archer VR2100

Contents

About This Guide	1
Chapter 1. Get to Know Your Modem Router	3
1. 1. Product Overview	4
1. 2. Physical Appearance	4
1. 2. 1. Top Panel	4
1. 2. 2. Back Panel	6
1. 2. 3. Side Panel	7
Chapter 2. Connect the Hardware	8
2. 1. Position Your Modem Router	9
2. 2. Connect Your Modem Router	9
Chapter 3. Log In to Your Modem Router	12
Chapter 4. Set Up Internet Connections	14
4. 1. Use Quick Setup Wizard	15
4. 2. Manually Set Up an Internet Connection	15
4. 3. Test Internet Connectivity	16
4. 4. Set Up an IPv6 Connection	17
4. 5. More Operation Modes	18
4. 5. 1. Wireless Router Mode	18
4. 5. 2. 3G/4G Router Mode	19
Chapter 5. TP-Link Cloud Service	20
5. 1. Register a TP-Link ID	21
5. 2. Change Your TP-Link ID Information	21
5. 3. Manage the User TP-Link IDs	22
5. 3. 1. Add an TP-Link ID to Manage the Router	23
5. 3. 2. Remove TP-Link ID(s) From Managing the Router	23
5. 4. Manage the Router via TP-Link Tether App	24
5. 4. 1. Install the Tether App on Your Smartphones or Tablets	24
Chapter 6. OneMesh™ with Seamless Roaming	25
6. 1. Set Up a OneMesh™ Network	26
6. 2. Manage Devices in the OneMesh™ Network	27

Chapter 7. IPTV	30
Chapter 8. Guest Network	32
8.1. Create a Network for Guests	33
8.2. Customize Guest Network Options	33
Chapter 9. USB Settings	35
9.1. Access the USB Storage Device	36
9.1.1. Access the USB Device Locally	36
9.1.2. Access the USB Device Remotely	37
9.1.3. Customize the Access Settings	39
9.2. Media Sharing	42
9.3. 3G/4G Settings	43
9.3.1. As a Backup Solution for Internet Access	43
9.3.2. As the Only Way to Access the Internet	45
Chapter 10. Parental Controls	47
Chapter 11. QoS	51
11.1. Prioritize Internet Traffic with QoS	52
11.2. Update the Database	53
Chapter 12. Network Security	55
12.1. Firewall & DoS Protection	56
12.2. Service Filtering	57
12.3. Access Control	58
12.4. IP & MAC Binding	60
12.5. IPv6 Firewall	61
Chapter 13. NAT Forwarding	63
13.1. Translate Address and Port by ALG	64
13.2. Share Local Resources over the Internet by Virtual Server	65
13.3. Open Ports Dynamically by Port Triggering	66
13.4. Make Applications Free from Port Restriction by DMZ	67
13.5. Make Xbox Online Games Run Smoothly by UPnP	68
Chapter 14. VPN Server	70
14.1. Use OpenVPN to Access Your Home Network	71
14.2. Use PPTP VPN to Access Your Home Network	72

14.3. Use IPSec VPN to Access Your Home Network	76
---	----

Chapter 15.Specify Your Network Settings..... 80

15.1. LAN Settings	81
15.1.1. Change the LAN IP Address.....	81
15.1.2. Use the Modem Router as a DHCP Server.....	82
15.1.3. Reserve LAN IP Addresses.....	83
15.2. IPv6 LAN Settings	83
15.2.1. Configure the RADVD Address Type	84
15.2.2. Configure the DHCPv6 Server Address Type.....	84
15.3. Wireless Settings.....	85
15.3.1. Specify Basic Wireless Settings.....	85
15.3.2. Use WPS for Wireless Connection	88
15.3.3. Schedule Your Wireless Function	90
15.3.4. View Wireless Information	91
15.3.5. Advanced Wireless Settings	91
15.4. Set Up a Dynamic DNS Service Account	92
15.5. Create Static Routes.....	93
15.6. Set Up the IPv6 Tunnel.....	95
15.6.1. Use the Public IPv6 Tunnel Service-6to4	96
15.6.2. Specify the 6rd Tunnel with Parameters Provided by Your ISP.....	97

Chapter 16.Administrate Your Network 98

16.1. Set System Time	99
16.2. Control LEDs	100
16.3. Update the Firmware.....	101
16.3.1. Online Upgrade.....	101
16.3.2. Local Upgrade	102
16.4. Back up and Restore Configuration Settings	102
16.5. Reboot the Modem Router.....	103
16.6. Change the Administrator Account.....	104
16.7. Local Management	105
16.8. Remote Management.....	105
16.9. System Log.....	107
16.10. Monitor the Internet Traffic Statistics.....	108
16.11. CWMP Settings.....	109
16.12. SNMP Settings	111

Appendix: Troubleshooting 113







About This Guide

This guide is a complement to Quick Installation Guide. The Quick Installation Guide provides instructions for quick internet setup, while this guide contains details of each function and demonstrates how to configure them in typical scenarios.

Features available in the modem router may vary by model and software version. Modem router availability may also vary by region or ISP. All images, steps, and descriptions in this guide are only examples and may not reflect your actual modem router experience.

Conventions

In this guide, the following conventions are used:

Convention	Description
<u>Underline</u>	Hyperlinks are in teal and underlined. You can click to redirect to a website or a specific section.
Teal	Key information appears in teal, including management page text such as menus, items, buttons and so on.
>	The menu structures to show the path to load the corresponding page. For example, Advanced > Wireless > MAC Filtering means the MAC Filtering function page is under the Wireless menu that is located in the Advanced tab.
 Note:	Ignoring this type of note might result in a malfunction or damage to the device.
 Tips:	Indicates important information that helps you make better use of your device.
Symbols on the web page	<ul style="list-style-type: none"> click to edit the corresponding entry. click to delete the corresponding entry. click to enable or disable the corresponding entry. click to view more information about items on the page.

Speed/Coverage Disclaimer

Maximum wireless signal rates are the physical rates derived from IEEE Standard 802.11 specifications. Range, coverage, and maximum quantity of connected devices are based on test results under normal usage conditions. Actual wireless data throughput, wireless coverage, and quantity of connected devices are not guaranteed and will vary as a result of 1) environmental factors, including building materials, physical objects, and obstacles, 2) network conditions, including local interference, volume and density of traffic, product location, network complexity, and network overhead, and 3) client limitations, including rated performance, location, connection quality, and client condition.

*Use of MU-MIMO requires clients to also support MU-MIMO.

More Info

- The latest firmware and management app are available from the [Download Center](#) at <https://www.tp-link.com/support/download/>.
- The Quick Installation Guide (QIG) can be found where you find this guide or inside the product packaging.
- Specifications can be found on the product page at <https://www.tp-link.com>.
- TP-Link Community is provided for you to share knowledge and discuss our products at <https://community.tp-link.com>.
- Our Technical Support contact information can be found at the [Contact Technical Support](#) page at <https://www.tp-link.com/support>.

Chapter 1

Get to Know Your Modem Router

This chapter introduces the modem router by detailing its main features and appearance.

It contains the following sections:

- [Product Overview](#)
- [Physical Appearance](#)

1.1. Product Overview

TP-Link's modem router is a combined wired/wireless network connection device with wireless router and DSL modem capabilities.

With DSL and LAN/WAN ports, the modem router is compatible with DSL connections and fiber/cable access.

Ethernet ports and adjustable antennas enable the modem router to provide wired and wireless access for multiple computers and mobile devices.

With an array of additional features, the modem router is the perfect hub for your home or business network.

1.2. Physical Appearance







1.2.1. Top Panel

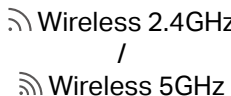

The modem router's LEDs are located on the top panel. You can check the modem router's working status by following the LED Explanation table.

It also provides the LED On/Off button. You can press the button to turn on/off the LEDs without affecting the modem router's function.

LED Explanation

Name	Status	Indication
 Power	On	The system has started up successfully.
	Flashing	The system is starting up or firmware is being upgraded. Do not disconnect or power off your modem router.
	Off	Power is off. Please ensure that the power adapter is connected correctly.
 DSL	On	DSL synchronization is complete.
	Flashing	DSL synchronization is in progress.
	Off	DSL synchronization failed. Please refer to Note 1 for troubleshooting.
 Internet	On	Internet service is available.
	Orange	Internet connection is correct but internet service is unavailable. Please refer to Note 2 for troubleshooting.
	Off	Internet connection is incorrect, DSL synchronization failed, or the modem router is operating in Bridge mode. Please refer to Note 3 for troubleshooting.
 Wireless 2.4GHz / Wireless 5GHz	On	The wireless 2.4GHz/5GHz band is working properly.
	Off	The wireless 2.4GHz/5GHz band is disabled.
 LAN	On	At least one LAN port is connected to a powered-on device.
	Off	No LAN port is connected to a powered-on device.
 USB	On	The USB device is ready to use.
	Flashing	The USB device is being identified.
	Off	No USB device is plugged into the USB port.
 WPS	On	A wireless device has been successfully added to the network by WPS.
	Flashing	WPS handshaking is in process and will continue for about 2 minutes. Please press the WPS button on other wireless devices that you want to add to the network while the LED is flashing.
	Off	A wireless device has failed to be added to the network by WPS.

■ Note:

1. If the DSL LED is off, please check your internet connection. Refer to [Connect Your Modem Router](#) for more information about how to connect to the internet correctly. If you have already made a successful connection, please contact your ISP to make sure your internet service is available now.
2. If the Internet LED is orange, please check your internet configuration. You may need to check this information with your ISP and make sure everything has been input correctly.

3. If the Internet LED is off, please check your DSL LED first. If your DSL LED is also off, please refer to [Note 1](#). If your DSL LED is ON, reconnect your modem router correctly by referring to related guide.

1.2.2. Back Panel



The modem router's back panel shows the ports, buttons and antennas. Refer to the following for detailed instructions.

Item	Description
Power Port	For connecting the modem router to a power socket via the provided power adapter.
LAN1, LAN2, LAN3, LAN4/WAN Port	For connecting the modem router to your PC or other Ethernet network devices. In wireless router mode, the LAN4/WAN port is used for connecting to a Cable/FTTH/VDSL/ADSL device.
Reset Button	Press and hold down for 8 seconds to reset the modem router into factory default settings.
DSL Port	For connecting the modem router to the internet. Connect the port to the splitter or directly connect the port to the phone jack via a phone cable. For details, please refer to Connect Your Modem Router .
Antennas	Used for wireless data transmission. Position them upright for the best performance.

1.2.3. Side Panel



The modem router's side panel shows the buttons and ports. Refer to the following for detailed instructions.

Item	Description
USB Port	For connecting to a USB storage device.
Wi-Fi Button	Press to turn both 2.4GHz and 5GHz Wi-Fi on or off.
WPS Button	Press to start a WPS synchronization.
Power On/Off Button	The switch for the power. Press it to power on or off the modem router.

Chapter 2

Connect the Hardware

This chapter contains the following sections:

- [Position Your Modem Router](#)
- [Connect Your Modem Router](#)

2.1. Position Your Modem Router

With the modem router, you can access your network from anywhere within the wireless network coverage. However, the wireless signal strength and coverage varies depending on the environment your modem router is in. Obstacles may limit the range of the wireless signal, for example, concrete structures, thick walls.

For best Wi-Fi performance, and to keep your network secure:

- Do not locate the modem router in a place where it will be exposed to moisture or excessive heat.
- Keep the product away from strong electromagnetic radiation and devices that emit electromagnetic waves.
- Place the modem router in a location where it can be connected to the various devices as well as to a power source.
- Make sure the cables and power cord are safely placed out of the way so they do not create a tripping hazard.

Generally, the modem router is placed on a horizontal surface, such as a shelf or desktop. The device also can be mounted on the wall as shown below.

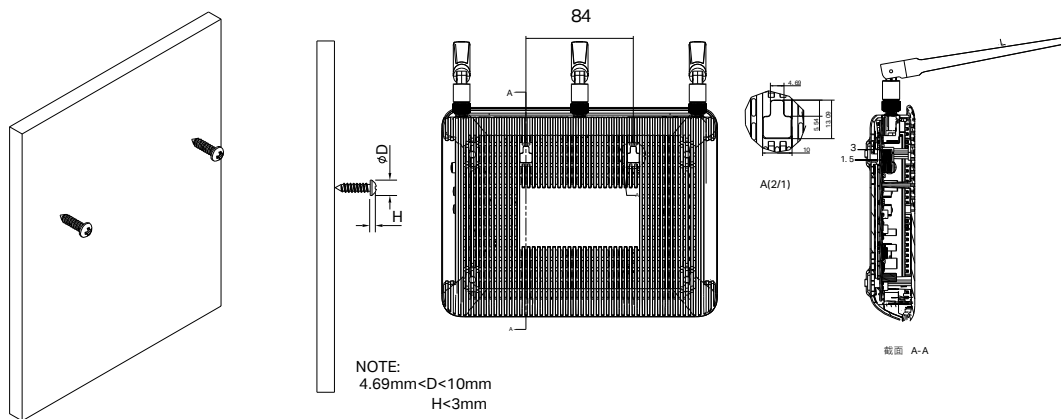

Note:

The diameter of the screw is 4.69mm < D < 10mm, and the distance of two screws is 84mm. The screw that project from the wall need around 8mm based, and the length of the screw need to be at least 20mm to withstand the weight of the product.

2.2. Connect Your Modem Router

Follow the steps below to connect your modem router.

1. Connect the DSL line and power adapter. The electrical outlet shall be installed near the device and shall be easily accessible.

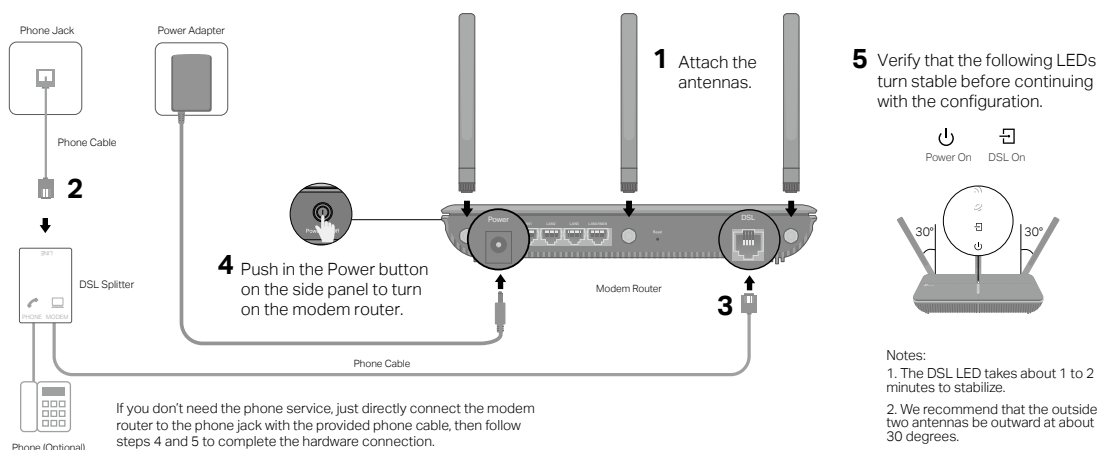

2. Connect your computer to the modem router.

Method 1: Wired

Connect your computer's Ethernet port to the LAN port on the modem router via the Ethernet cable.

Method 2: Wirelessly

Use the default SSID (Wireless Network Name) and Wireless Password printed on the included Wi-Fi Info Card or on the product label of the modem router to connect wirelessly.

Method 3: Use the WPS button

Wireless devices that support WPS, including Android phones, tablets, most USB network cards, can be connected to your router through this method. (WPS is not supported by iOS devices.)

Note:

The WPS function cannot be configured if the wireless function of the router is disabled. Also, the WPS function will be disabled if your wireless encryption is WEP. Please make sure the wireless function is enabled and is configured with the appropriate encryption before configuring the WPS.

- 1) Tap the WPS icon on the device's screen.
- 2) Immediately press the WPS button on your modem router.
- 3) The WPS LED flashes for about two minutes during the WPS process.
- 4) When the WPS LED stabilizes and remains on, the client device has successfully connected to the modem router.

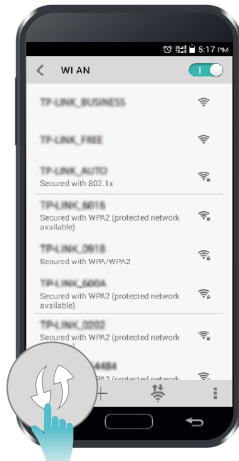

Chapter 3

Log In to Your Modem Router

With the web management page, it is easy to configure and manage the modem router. The web management page can be used on any Windows, Macintosh or UNIX OS with a Web browser, such as Microsoft Internet Explorer, Mozilla Firefox or Apple Safari.

Follow the steps below to log in to your modem router.

1. If the TCP/IP Protocol on your computer is set to the static (fixed) IP address, you need to change its settings to obtain an IP address automatically. Refer to [Appendix: Troubleshooting](#) to configure your computer.
2. Launch a web browser and go to <http://tplinkmodem.net> or <http://192.168.1.1>. Create a strong password and click **Let's Get Started** to log in.

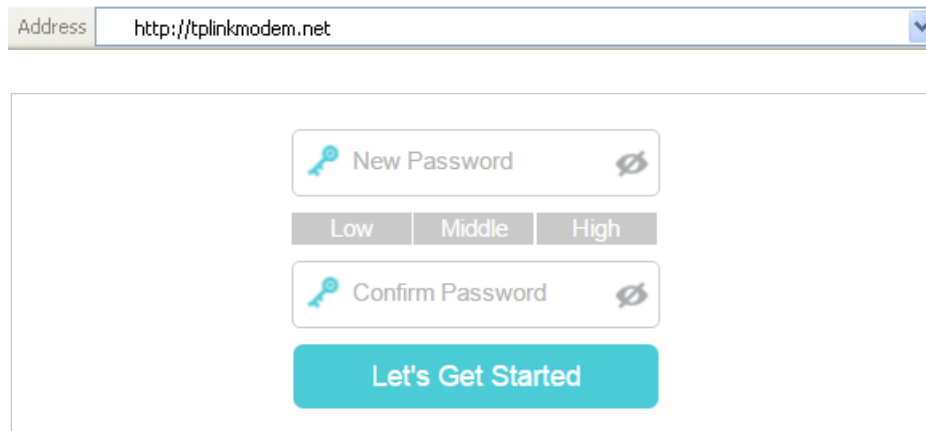

The screenshot shows a web browser address bar with the URL `http://tplinkmodem.net`. Below the address bar is a form for creating a new password. It includes a text input field labeled "New Password" with a key icon and a toggle for visibility. Below this field are three buttons labeled "Low", "Middle", and "High" for password strength selection. Below the strength buttons is another text input field labeled "Confirm Password" with a key icon and a toggle for visibility. At the bottom of the form is a large teal button labeled "Let's Get Started".

Note:

If you have registered a TP-Link ID and bind your cloud router to it, the login password you created here should be ineffective. Please log in to the cloud router using your TP-Link ID.

Chapter 4

Set Up Internet Connections

This chapter introduces how to connect your modem router to the internet. The modem router is equipped with a web-based Quick Setup wizard. It has many ISP information built in, automates many of the steps and verifies that those steps have been successfully completed. Furthermore, you can also set up an IPv6 connection if your ISP provides IPv6 service.

This chapter includes the following sections:

- [Use Quick Setup Wizard](#)
- [Manually Set Up an Internet Connection](#)
- [Test Internet Connectivity](#)
- [Set Up an IPv6 Connection](#)
- [More Operation Modes](#)

4.1. Use Quick Setup Wizard

1. Visit <http://tplinkmodem.net>, and log in with the password you set for the modem router.
2. Click **Quick Setup** on the top of the page. Then follow the step-by-step instructions to connect your router to the internet.
3. To enjoy a more complete service from TP-Link (remote management, TP-Link DDNS, etc.), log in with your TP-Link ID or click **Register Now** to get one. Then follow the instructions to bind the modem router to your TP-Link ID.

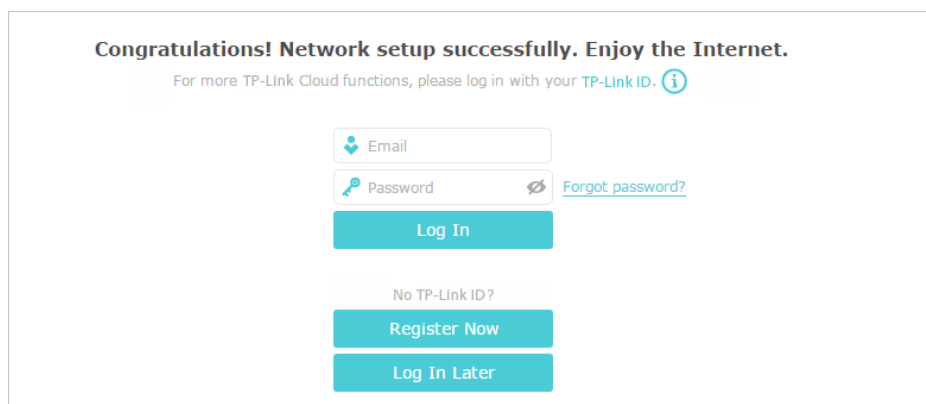

Congratulations! Network setup successfully. Enjoy the Internet.

For more TP-Link Cloud functions, please log in with your TP-Link ID. [i](#)

Email

Password [Forgot password?](#)

Log In

No TP-Link ID?

Register Now

Log In Later

Note:

1. To learn more about the TP-Link Cloud service, please refer to the [TP-Link Cloud](#) section.
2. If you do not want to register a TP-Link ID for now, you may click **Log In Later** to proceed.
3. If you have changed the preset wireless network name (SSID) and wireless password during the Quick Setup process, all your wireless devices must use the new SSID and password to connect to the router.

4.2. Manually Set Up an Internet Connection

1. Visit <http://tplinkmodem.net>, and log in with your TP-Link ID or the password you set for the modem router.
2. Go to **Basic > Internet** page. Select your ISP, and related information will be automatically filled in. For some ISPs, you may need to manually specify some information provided. If you can't find your ISP in the [ISP List](#), select **Other** and then enter the information provided by your ISP.

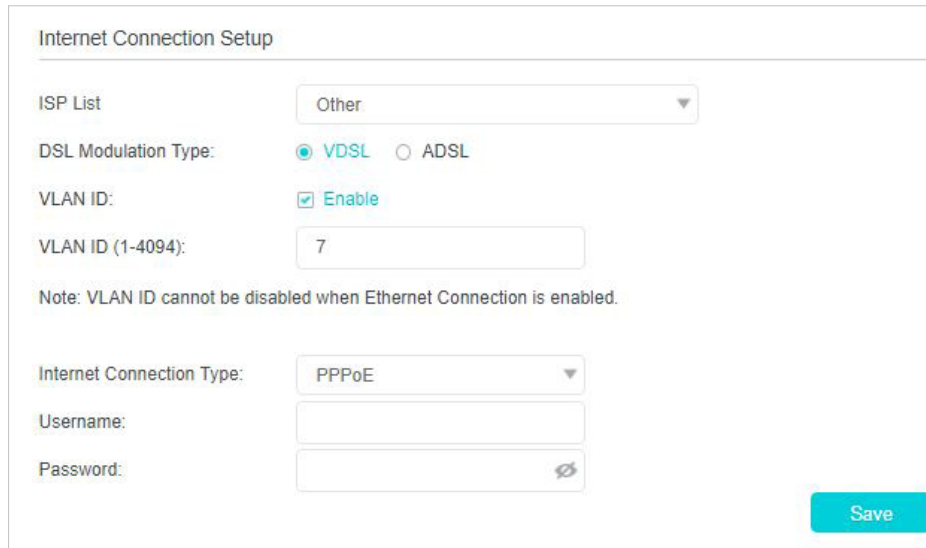

The screenshot shows the 'Internet Connection Setup' page. It includes the following fields and options:

- ISP List:** A dropdown menu with 'Other' selected.
- DSL Modulation Type:** Radio buttons for 'VDSL' (selected) and 'ADSL'.
- VLAN ID:** A checkbox labeled 'Enable' which is checked.
- VLAN ID (1-4094):** A text input field containing the number '7'.
- Note:** 'VLAN ID cannot be disabled when Ethernet Connection is enabled.'
- Internet Connection Type:** A dropdown menu with 'PPPoE' selected.
- Username:** An empty text input field.
- Password:** An empty password input field with a toggle icon for visibility.
- Save:** A blue button located at the bottom right of the form.

3. Click [Save](#) to make the settings effective, and you can refer to [Test Internet Connectivity](#) to test the internet connection.

 **Tips:** You can view and edit all internet connection settings on the [Advanced > Network > Internet](#) page.

4.3. Test Internet Connectivity

After manually setting up the internet connection, you need to test the internet connectivity. The modem router provides a diagnostic tool to help you locate the source of any problems.

1. Visit <http://tplinkmodem.net>, and log in with your TP-Link ID or the password you set for the modem router.
2. Go to [Advanced > System Tools > Diagnostics](#) page.

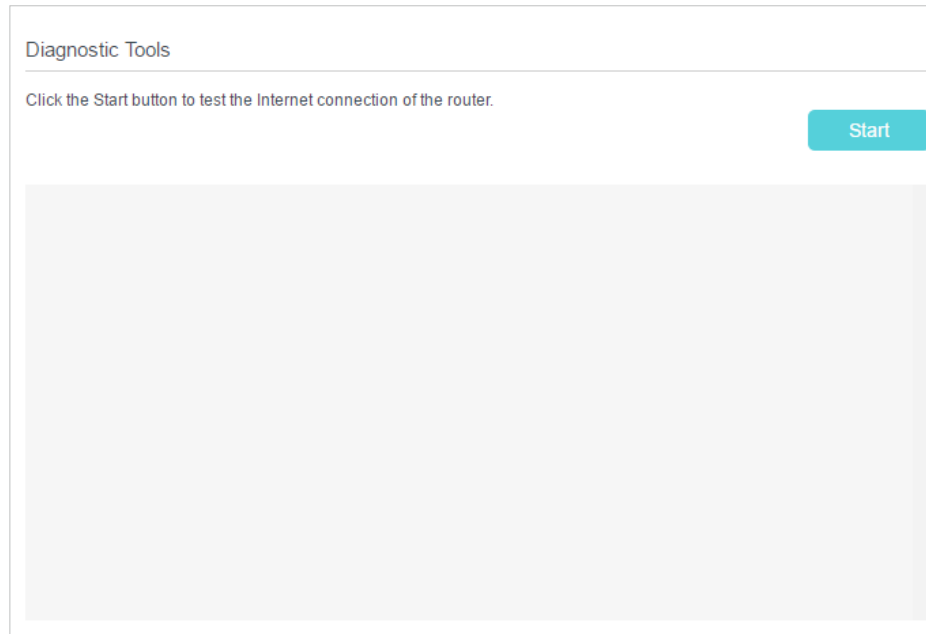

3. Click [Start](#) to test the internet connectivity and you will see the test result in the gray box.

4.4. Set Up an IPv6 Connection

If your ISP has provided a DSL line that supports IPv6 connection as well as some detailed IPv6 parameters, you can manually set up an IPv6 connection.

If your ISP provides an IPv4-only connection or IPv6 tunnel service, permit IPv6 connection by referring to [Set Up the IPv6 Tunnel](#).

Follow the steps below to set up an IPv6 connection:

1. Make sure you have set up an IPv4 connection either manually or by using the Quick Setup wizard before setting up an IPv6 connection.
2. Visit <http://tplinkmodem.net>, and log in with your TP-Link ID or the password you set for the modem router.
3. Go to [Advanced](#) > [Network](#) > [Internet](#) page.

WAN Interface Name	VPI/VCI or VID	Status	Operation	Modify
pppoe_ptm_0_0_d	N/A	DSL Disconnected	Connect	

4. Select your WAN Interface Name ([Status](#) should be [Connect](#)) and click the (Edit) icon.

5. Scroll down the page, enable **IPv6**, and configure the IPv6 parameters.

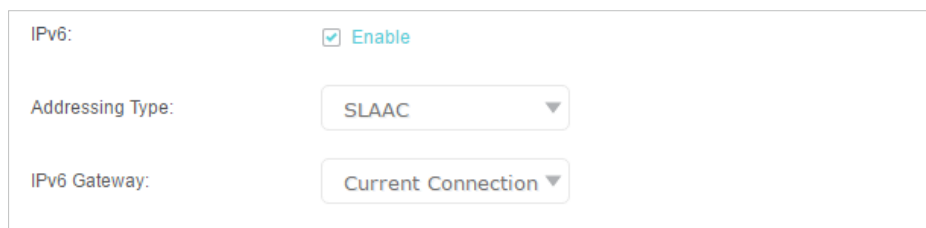

IPv6: Enable

Addressing Type: SLAAC ▼

IPv6 Gateway: Current Connection ▼

- **Addressing Type:** Consult your ISP for the addressing type (DHCP or SLAAC). SLAAC is the most commonly used addressing type.
- **IPv6 Gateway:** Keep the default setting as **Current Connection**.

Note: If your ISP has provided the IPv6 address, click **Advanced** to reveal more settings. Check to use IPv6 specified by ISP and enter the parameters provided by your ISP.

6. Click **Save** to make the settings effective. Now IPv6 service is available for your network.

4. 5. More Operation Modes

The modem router supports two more operation modes: Wireless Router mode and 3G/4G Router mode. You can change the mode according to your needs.

4. 5. 1. Wireless Router Mode

If you already have a modem or your internet comes via an Ethernet jack on the wall, you can set up the modem router as a regular wireless router to share the internet.

1. Find the WAN port (labeled as LAN4/WAN) on the modem router, and connect it to your existing modem or the Ethernet jack on the wall. Then connect the power adapter and turn on the modem router. If you connect an existing modem, reboot it to get the modem router connected to the internet.
2. Connect your computer to the modem router. For details, refer to [Connect Your Modem Router](#).
3. Visit <http://tplinkmodem.net>, and log in with your TP-Link ID or the password you set for the modem router.
4. Go to **Advanced > Operation Mode**, select the **Wireless Router Mode**, and click **Save**. The modem router will reboot.

5. Go to **Basic** > **Internet**, select the **Connection Type**, and enter the information provided by your ISP.

6. Click **Save** to make the settings effective.

 **Tips:**

1. You can view and edit all internet connections on [Advanced](#) > [Network](#) > [Internet](#) page.
2. In the Wireless Router Mode, you can also permit IPv6 connection by setting up an IPv6 connection or the IPv6 tunnel just as in the DSL Modem Router Mode. For details, refer to [Set Up an IPv6 Connection](#) and [Set Up the IPv6 Tunnel](#).

4.5.2. 3G/4G Router Mode

The modem router can be used as a 3G/4G wireless router if you have a 3G/4G USB modem. There are two ways to use your 3G/4G network:

- As a backup solution for internet access

Use this way if you have set up an internet connection successfully and want to use the 3G/4G network as a backup network. Your modem router will be directly connected to the 3G/4G network when the original network service fails. For detailed instructions, refer to [As a Backup Solution for Internet Access](#).

- As the only way to access the internet

Use this way if wired internet access is not available and you can only use the 3G/4G network to access the internet. For detailed instructions, refer to [As the Only Way to Access the Internet](#).

 **Tips:**

In the 3G/4G Router Mode, you can also permit IPv6 connection by setting up the IPv6 tunnel just as in the DSL Modem Router Mode. For details, refer to [Set Up the IPv6 Tunnel](#).

Chapter 5

TP-Link Cloud Service

TP-Link Cloud service provides a better way to manage your cloud devices. Log in to your router with a TP-Link ID, and you can easily monitor and manage your home network when you are out and about via the Tether app on your smartphone or tablet. To ensure that your router stays new and gets better over time, the TP-Link Cloud will notify you when an important firmware upgrade is available. Surely you can also manage multiple TP-Link Cloud devices with a single TP-Link ID.

This chapter introduces how to register a new TP-Link ID, bind or unbind TP-Link IDs to manage your router, and the Tether app with which you can manage your home network no matter where you may find yourself.

It contains the following sections:

- [Register a TP-Link ID](#)
- [Change Your TP-Link ID Information](#)
- [Manage the User TP-Link IDs](#)
- [Manage the Router via TP-Link Tether App](#)

5.1. Register a TP-Link ID

If you have skipped the registration during the Quick Setup process, you can:

1. Visit <http://tplinkmodem.net>, and log in with the password you set for the router.
2. Go to [Basic > TP-Link Cloud](#).
3. Click [Register Now](#) and follow the instructions to register a TP-Link ID.

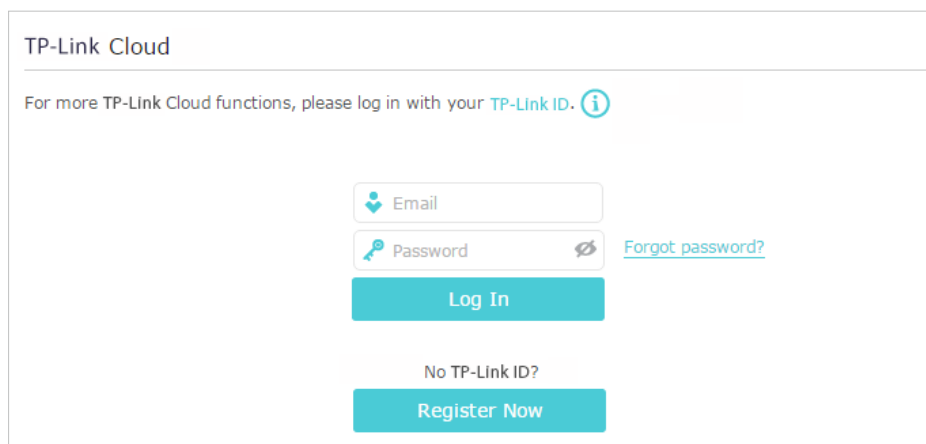

TP-Link Cloud

For more TP-Link Cloud functions, please log in with your TP-Link ID. ⓘ

Email

Password [Forgot password?](#)

Log In

No TP-Link ID?

Register Now

4. After activating your TP-Link ID, come back to the TP-Link Cloud page to log in. The first-time login TP-Link ID will be bound automatically to your cloud router as an [Admin](#).

■ Note:

- The TP-Link ID also can be registered via the TP-Link Tether app. Please refer to [Install the Tether App on Your Smartphones or Tablets](#) to install the app. Launch the app, tap  in the top-left corner of the screen and tap [Login](#), and then click [New User](#) to register a new one.
- If you want to unbind the admin TP-Link ID from your router, please go to [Basic > TP-Link Cloud](#), click [Unbind](#) in the [Device Information](#) section.

5.2. Change Your TP-Link ID Information

Follow the steps below to change your email address and password of your TP-Link ID as needed.

1. Visit <http://tplinkmodem.net>, and log in with your TP-Link ID.
2. Go to [Basic > TP-Link Cloud](#), and focus on the [Account Information](#) section.
 - **Change your email address**
 1. Click  behind the Email.
 2. Enter the password of your TP-Link ID, then the new email address. And click [Save](#).

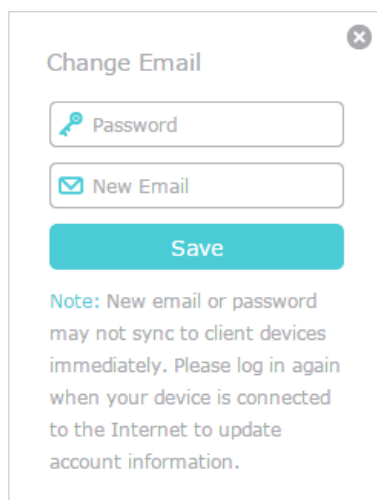

The image shows a 'Change Email' dialog box with a close button (X) in the top right corner. It contains two input fields: 'Password' with a key icon and 'New Email' with an envelope icon. Below the fields is a teal 'Save' button. A note at the bottom states: 'Note: New email or password may not sync to client devices immediately. Please log in again when your device is connected to the Internet to update account information.'

- **Change your password**

1. Click  behind the Password.
2. Enter the current password, then a new password twice. And click [Save](#).

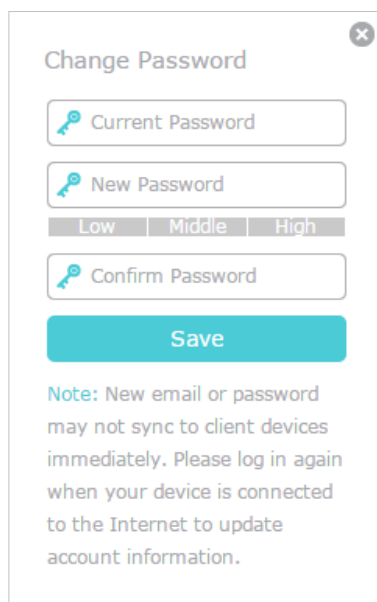

The image shows a 'Change Password' dialog box with a close button (X) in the top right corner. It contains three input fields: 'Current Password', 'New Password', and 'Confirm Password', each with a key icon. Below the 'New Password' field is a strength indicator with three segments labeled 'Low', 'Middle', and 'High'. Below the fields is a teal 'Save' button. A note at the bottom states: 'Note: New email or password may not sync to client devices immediately. Please log in again when your device is connected to the Internet to update account information.'

5.3. Manage the User TP-Link IDs

The first-time login TP-Link ID will be bound automatically to your router as an [Admin](#) account. An admin account can add or remove other TP-Link IDs to the same router as [Users](#). Admin account and User accounts both can monitor and manage the router locally or remotely, except that user accounts cannot:

- Reset the router to factory default settings from the web management page or Tether app.
- Add/remove other TP-Link IDs to/from the router.

5.3.1. Add an TP-Link ID to Manage the Router

1. Visit <http://tplinkmodem.net>, and log in with your TP-Link ID.
2. Go to **Basic > TP-Link Cloud**, and focus on the **Bound Accounts** section.
3. Click **+ Bind**, enter another TP-Link ID as needed and click **Save**.

Note:

If you need another TP-Link ID, please refer to [Install the Tether App on Your Smartphones or Tablets](#) to install the app. Launch the app, tap  in the top-left corner of the screen and tap **Login**, and then click **New User** to register a new one.

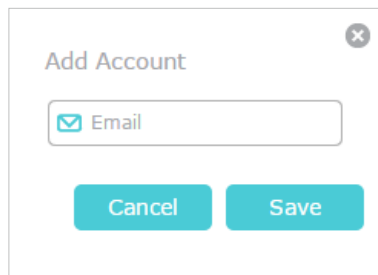

4. The new TP-Link ID will be displayed in the **Bound Accounts** table as a **User**.

Bound Accounts				
+ Bind - Unbind				
<input type="checkbox"/>	ID	Email	Binding Date	Role
<input type="checkbox"/>	1	*****@****.com	16/11/2016	Admin
<input type="checkbox"/>	2	*****@****.com	16/11/2016	User

5.3.2. Remove TP-Link ID(s) From Managing the Router

1. Visit <http://tplinkmodem.net>, and log in with your TP-Link ID.
2. Go to **Basic > TP-Link Cloud**, and focus on the **Bound Accounts** section.
3. Check the box(es) of the TP-Link ID(s) you want to remove and click **Unbind**.

Bound Accounts				
+ Bind - Unbind				
<input type="checkbox"/>	ID	Email	Binding Date	Role
<input type="checkbox"/>	1	*****@****.com	16/11/2016	Admin
<input checked="" type="checkbox"/>	2	*****@****.com	16/11/2016	User

5.4. Manage the Router via TP-Link Tether App

5.4.1. Install the Tether App on Your Smartphones or Tablets

The Tether app runs on iOS and Android devices like smartphones and tablets.

1. Open the Apple App Store or Google Play and search the key word **TP-Link Tether** or simply scan the QR code to download and install the app.



2. Launch the Tether app and log in with your TP-Link ID. If you don't have a TP-Link ID, create one first.
3. Connect your device to the modem router's wireless network.
4. Go back to the Tether app, select the model of your router and log in with the password you set for the modem router.
5. Manage your modem router as needed.



Chapter 6

OneMesh™ with Seamless Roaming

This chapter introduces the TP-Link OneMesh™ feature.

It contains the following sections:

- [Set Up a OneMesh™ Network](#)
- [Manage Devices in the OneMesh™ Network](#)

TP-Link OneMesh™  router and TP-Link OneMesh™  extenders work together to form one unified Wi-Fi network. Walk through your home and stay connected with the fastest possible speeds thanks to OneMesh's seamless coverage.

Unified Wi-Fi Network

Router and extenders share the same wireless settings, including network name, password, access control settings and more.

Seamless Roaming

Devices automatically switch between your router and extenders as you move through your home for the fastest possible speeds.

Easy Setup and Management

Set up a OneMesh™ network with a push of WPS buttons. Manage all network devices on the Tether app or at your router's web management page.

Unified OneMesh™ Network

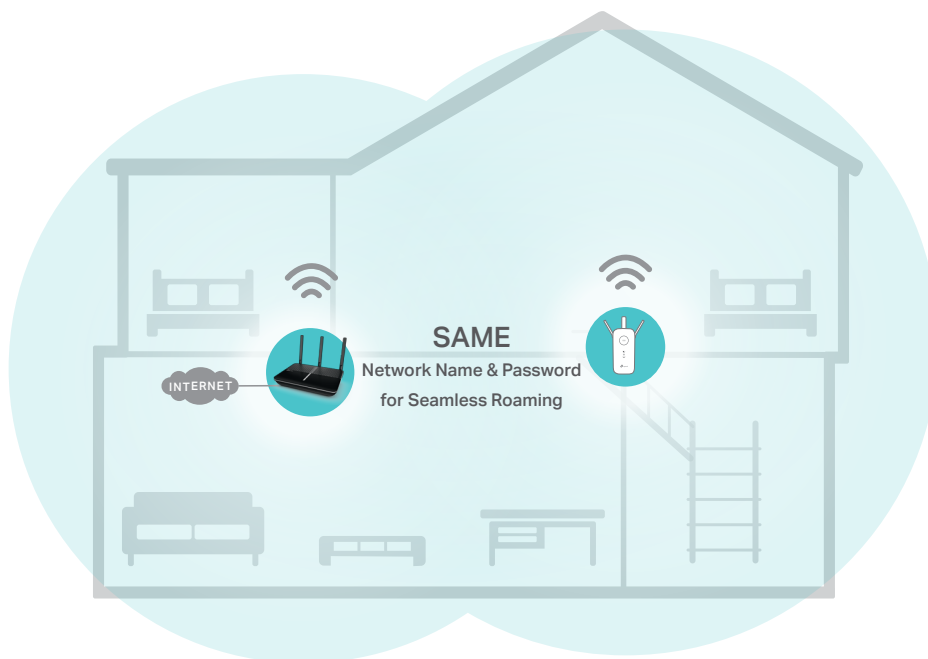

6.1. Set Up a OneMesh™ Network

1. Visit <http://tplinkmodem.net>, and log in with your TP-Link ID or the password you set for the router.
2. Go to **Basic > OneMesh** or **Advanced > Wireless > OneMesh**.

Note:

Early firmware versions may not support OneMesh™. If you can't find the OneMesh page, please upgrade your router to the latest firmware version. For upgrade instructions, refer to [Update the Firmware](#).

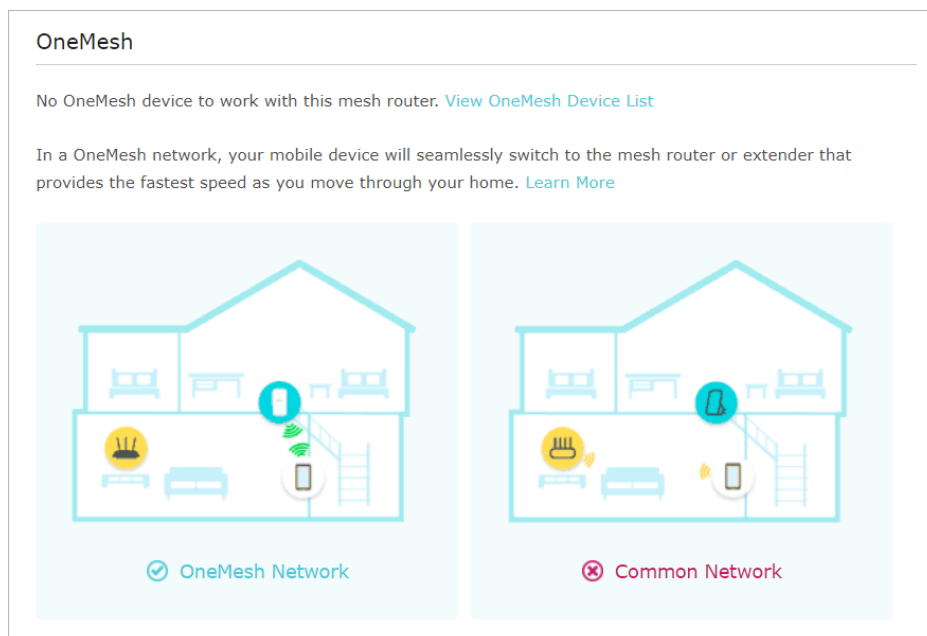

3. Connect one or more OneMesh™ extenders to this router by following the setup instructions in the extenders' manuals.

Note:

To check full list of TP-Link OneMesh™ devices, visit <https://www.tp-link.com/onemesh/compatibility>.

4. If you have set up an extender to join the OneMesh™ network, it will be listed in the [Devices in OneMesh Network](#) list. Otherwise, you need to find it in the [Available OneMesh Devices](#) list and click [Add](#) to add it to the OneMesh™ network.

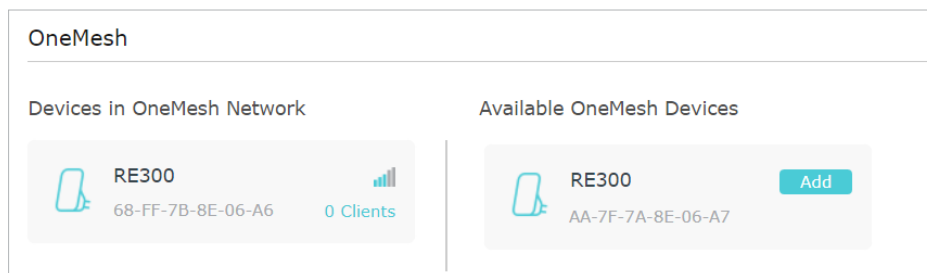

Now your router and extenders successfully form one OneMesh™ network!

6.2. Manage Devices in the OneMesh™ Network

In a OneMesh™ network, you can manage all mesh devices and clients on your router's web page.

- **To view all mesh devices and clients in the OneMesh™ network:**

1. Visit <http://tplinkmodem.net>, and log in with your TP-Link ID or the password you set for the router.
2. Go to [Basic > Network Map](#).
3. Click the [Mesh Devices](#), [Wired Clients](#), or [Wireless Clients](#) icon to view the related device or client list.

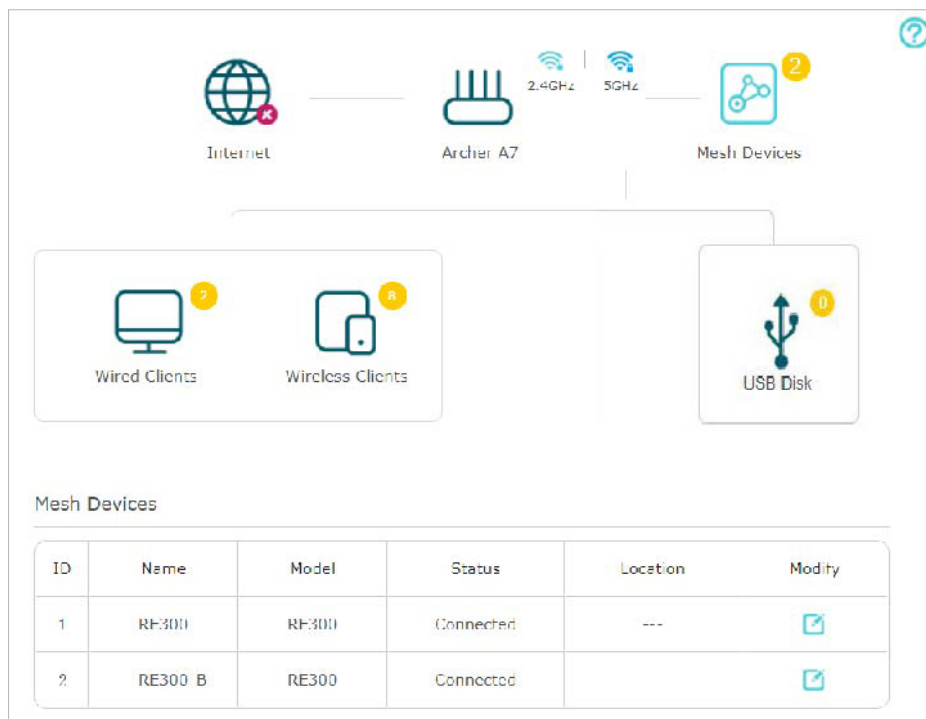

The screenshot displays the TP-Link OneMesh Network Map. At the top, it shows the Internet connection, the Archer A7 router, and the Mesh Devices section. Below the map, there are sections for Wired Clients, Wireless Clients, and USB Disk. A table titled 'Mesh Devices' lists two devices:

ID	Name	Model	Status	Location	Modify
1	RE300	RE300	Connected	---	
2	RE300 B	RE300	Connected	---	

- **To manage each OneMesh™ device in the network:**

1. Visit <http://tplinkmodem.net>, and log in with your TP-Link ID or the password you set for the router.
2. Go to [Basic > OneMesh](#) or [Advanced > Wireless > OneMesh](#).

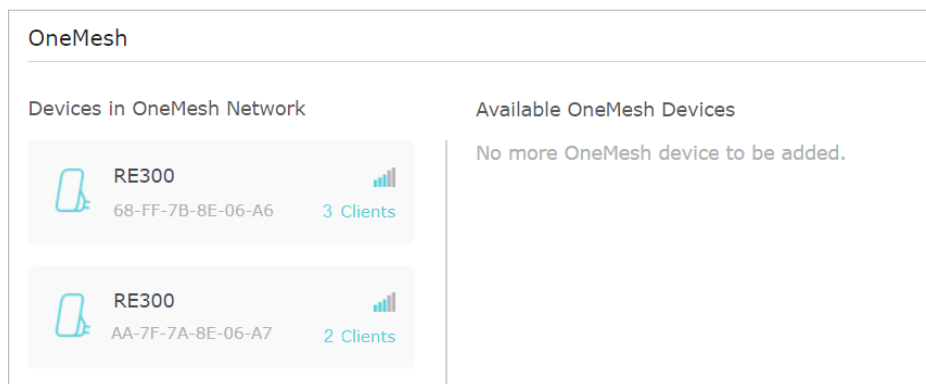

The screenshot displays the TP-Link OneMesh management interface. It shows two devices in the OneMesh Network:

- RE300 (68-FF-7B-8E-06-A6) with 3 Clients
- RE300 (AA-7F-7A-8E-06-A7) with 2 Clients

The Available OneMesh Devices section shows "No more OneMesh device to be added."

3. Click a OneMesh™ device to view the device information, or click [<number> Clients](#) to view the clients connected to this device.

On the [Device Info](#) page, you can:

- Click [Manage Device](#) to redirect to the web management page of this OneMesh™ device.
- Click [Leave OneMesh](#) to delete this device from the OneMesh™ network.

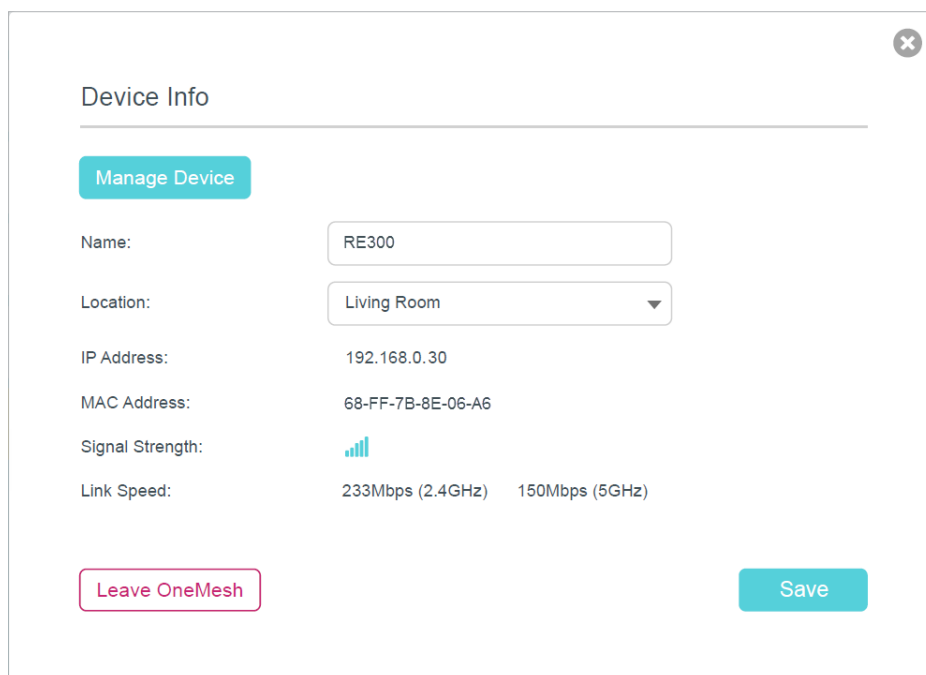

The screenshot shows a 'Device Info' modal window with a close button in the top right corner. The window contains the following information:

- Manage Device** button (teal)
- Name:** RE300 (text input)
- Location:** Living Room (dropdown menu)
- IP Address:** 192.168.0.30
- MAC Address:** 68-FF-7B-8E-06-A6
- Signal Strength:** Represented by a blue signal strength icon.
- Link Speed:** 233Mbps (2.4GHz) and 150Mbps (5GHz)
- Leave OneMesh** button (pink)
- Save** button (teal)

Chapter 7

IPTV

IPTV is the abbreviation of Internet Protocol Television. The service can only be delivered through the Internet, and our modem router provides a specific LAN port for IPTV.

By automatically separating IPTV from Internet surfing, you can enjoy a high quality of video streaming and fast browsing speeds at the same time.

I want to:

Configure the modem router to enable Internet Protocol Television (IPTV) Services.

For example, I already bought IPTV service, but this service can only be delivered through the Internet. Therefore, I need to configure my modem router first.

How can I do that?

1. Visit <http://tplinkmodem.net>, and log in with your TP-Link ID or the password you set for the router.
2. Go to **Advanced** > **IPTV** to open the configuration page.

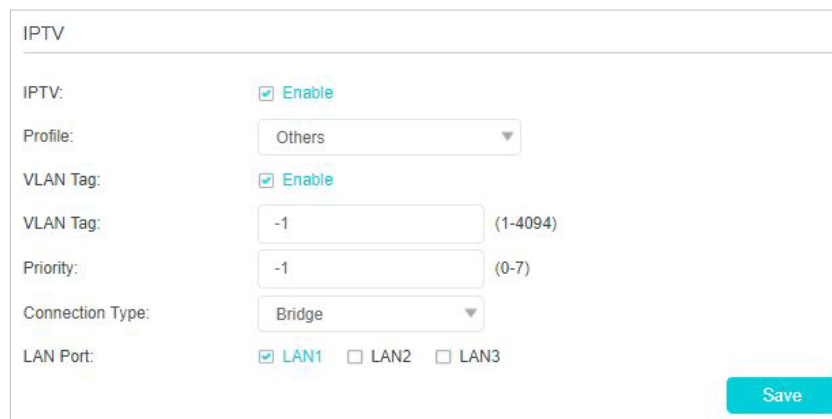

The screenshot shows the IPTV configuration page. It includes the following settings:

- IPTV:** Enable
- Profile:** Others (dropdown menu)
- VLAN Tag:** Enable
- VLAN Tag:** -1 (range: 1-4094)
- Priority:** -1 (range: 0-7)
- Connection Type:** Bridge (dropdown menu)
- LAN Port:** LAN1 LAN2 LAN3

A **Save** button is located at the bottom right of the configuration area.

3. Check **Enable** to enable IPTV function.
4. Select your ISP from the **Profile** drop-down list and then the VLAN ID will be automatically filled in. If your ISP is not listed, select **Others** and then configure your VLAN ID using the parameters provided by your IPTV service provider.
5. Select a connection type from the **Profile** drop-down list according to your IPTV connection. If you select Bridge, specify a LAN port for the IPTV connection and connect the set-top box to this port.
6. Click **Save** to make the settings effective.

Done!

Modem router configuration is complete! You may still need to configure settings on your set-top box before enjoying your IPTV service.

Chapter 8

Guest Network

This function allows you to provide Wi-Fi access for guests without disclosing your main network. When you have guests in your house, apartment, or workplace, you can create a guest network for them. In addition, you can assign network authorities and bandwidth for guests to ensure network security, privacy, and fluency.

- [Create a Network for Guests](#)
- [Customize Guest Network Options](#)

8.1. Create a Network for Guests

1. Visit <http://tplinkmodem.net>, and log in with your TP-Link ID or the password you set for the router.
2. Go to [Advanced](#) > [Guest Network](#). Locate the [Wireless Settings](#) section.
3. Create 2.4GHz and 5GHz guest network according to your needs.

Wireless

2.4GHz Wireless: Enable Guest Network

Network Name (SSID): Hide SSID

5GHz Wireless: Enable Guest Network

Network Name (SSID): Hide SSID

Security: No Security WPA/WPA2 Personal

Version: Auto WPA2-PSK

Encryption: Auto TKIP AES

Password:

- 1) Enable [2.4GHz Wireless](#) or [5GHz Wireless](#) or enable both according to your needs.
- 2) Set an easy-to-identify SSID. Don't select [Hide SSID](#) unless you want your guests and other people to manually input this SSID for Wi-Fi access.
- 3) Set [Security](#) to [WPA/WPA2 Personal](#), keep the default [Version](#) and [Encryption](#) values, and set an easy-to-remember password. 2.4GHz and 5GHz guest networks share the same password.
4. Click [Save](#). Now your guests can access your guest network using the SSID and password you set!

Tips:

To view guest network information, go to [Advanced](#) > [Status](#) and find the [Guest Network](#) section.

8.2. Customize Guest Network Options

1. Visit <http://tplinkmodem.net>, and log in with your TP-Link ID or the password you set for the router.
2. Go to [Advanced](#) > [Guest Network](#).

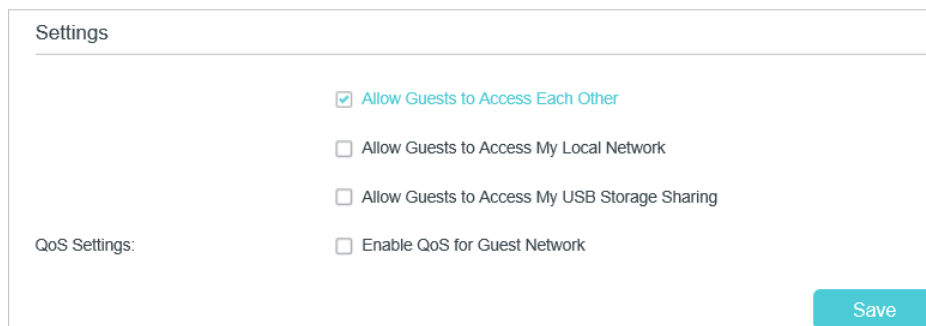

Settings

Allow Guests to Access Each Other

Allow Guests to Access My Local Network

Allow Guests to Access My USB Storage Sharing

QoS Settings:

Enable QoS for Guest Network

Save

3. Assign network authorities and bandwidth according to your needs.

- [Allow Guests to Access Each Other](#)

Select this check box to allow the clients in your guest network to access each other's files.

- [Allow Guests to Access My Local Network](#)

Select this check box to allow the clients in your guest network to access your local network, not just the internet.

- [Allow Guests to Access My USB Storage Sharing](#)

Select this check box to allow the clients in your guest network to access your router's USB storage sharing.

- [Enable QoS for Guest Network](#)

Select this check box to set the [QoS Priority](#) of the guest network. This option is available only when QoS is enabled on the [Advanced > QoS](#) page.

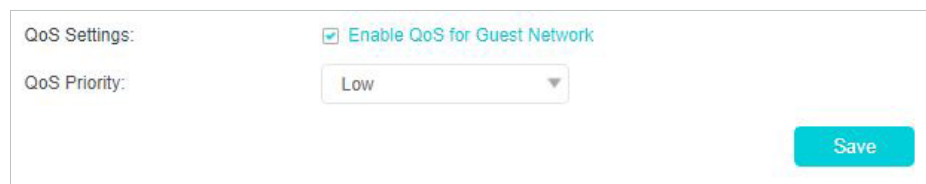

QoS Settings:

Enable QoS for Guest Network

QoS Priority: Low

Save

4. Click [Save](#). Now users in your guest network can enjoy only the network authorities at the priority you assigned!

 **Tips:**

To view guest network information, go to [Advanced > Status](#) and find the [Guest Network](#) section.

Chapter 9

USB Settings

This chapter describes how to use the USB ports to share files, and media from the USB storage devices over your home network locally, or remotely through the internet.

The modem router supports USB external flash drives, and hard drives.

This chapter contains the following sections:

- [Access the USB Storage Device](#)
- [Media Sharing](#)
- [3G/4G Settings](#)

9.1. Access the USB Storage Device

Insert your USB storage device into the modem router's USB port and then access files stored there locally or remotely.

🔗 Tips:

- If you use USB hubs, make sure no more than 4 devices are connected to the modem router.
- If the USB storage device requires using bundled external power, make sure the external power has been connected.
- If you use a USB hard drive, make sure its file system is FAT32 or NTFS. Some modem routers also support the HFS+ and exFAT file systems.
- Before you physically disconnect a USB device from the modem router, safely remove it to avoid data damage: Go to [Advanced](#) > [USB Sharing](#) > [USB Storage Device](#) and click [Remove](#).

9.1.1. Access the USB Device Locally

Insert your USB storage device into the modem router's USB port and then refer to the following table to access files stored on your USB storage device:

Windows computer

- **Method 1:**



Go to [Computer](#) > [Network](#), then click the Network Server Name ([ARCHER_model number](#) by default) in the [Computer](#) section.

📌 Note:

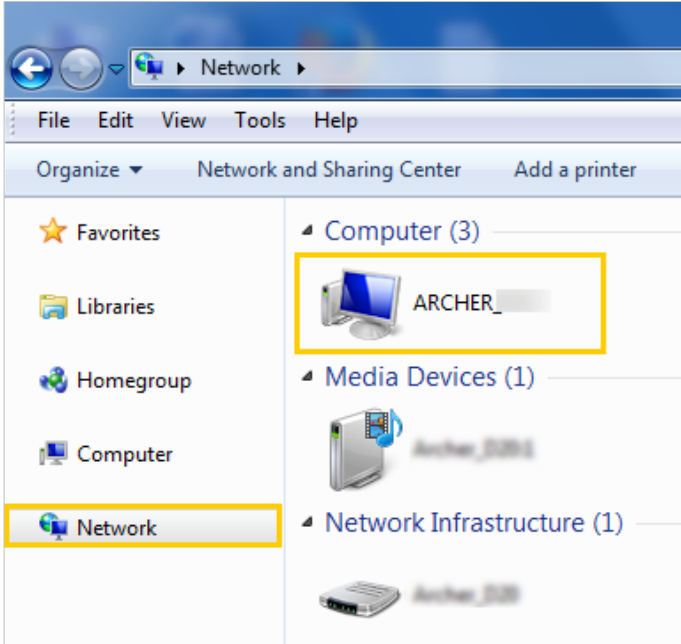
1. Operations in different systems are similar. Here we take Windows 7 as an example.
2. Network Server Name can be customized on the web management page.

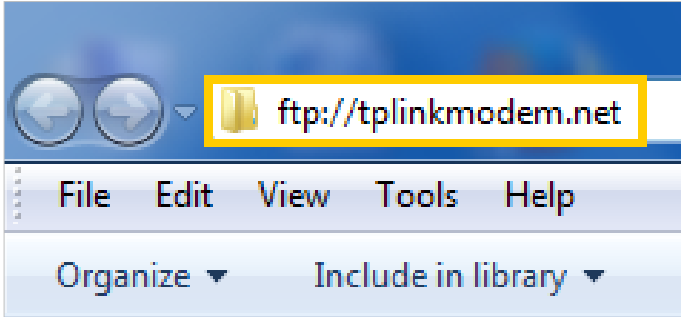
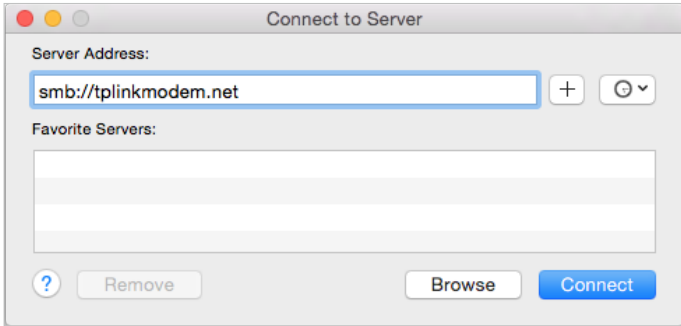

The screenshot shows a Windows 7 Network window. The address bar shows 'Network'. The left sidebar has 'Network' selected. The main pane shows a tree view with 'Computer (3)', 'Media Devices (1)', and 'Network Infrastructure (1)'. Under 'Computer (3)', a computer icon labeled 'ARCHER_' is highlighted with a yellow box.

Windows computer	<ul style="list-style-type: none"> • Method 2: <p>Open the Windows Explorer (or go to Computer) and type the server address <code>\\tplinkmodem.net</code> or <code>ftp://tplinkmodem.net</code> in the address bar, then press Enter.</p> 
Mac	<ol style="list-style-type: none"> 1) Select Go > Connect to Server 2) Type the server address <code>smb://tplinkmodem.net</code> 3) Click Connect  <ol style="list-style-type: none"> 4) When prompted, select the Guest radio box. (If you have set up a username and a password to deny anonymous access to the USB disks, you should select the Registered User radio box. To learn how to set up an account for the access, refer to To Set up Authentication for Data Security.) <p> Tips: You can also use the FTP, http and SFTP methods to access the USB storage device.</p>
Tablet	<p>Use a third-party app for network files management.</p>

9. 1. 2. Access the USB Device Remotely

You can access your USB disk outside the local area network. For example, you can:

- Share photos and other large files with your friends without logging in to (and paying for) a photo-sharing site or email system.
- Get a safe backup for the materials for a presentation.
- Save and remove the files on your camera's memory card during your travels.

Note:

If your ISP assigns a private WAN IP address (such as 192.168.x.x or 10.x.x.x), you cannot use this feature because private addresses are not routed on the internet.

Follow the steps below to configure remote access settings.

1. Visit <http://tplinkmodem.net>, then log in with your TP-Link ID or the password you set for the modem router.
2. Go to **Advanced > USB Sharing > USB Storage Device** page and locate the **Sharing Settings** section.
3. Select the check box to enable **FTP (via Internet)**, or **https (via Internet)**, or **SFTP (via Internet)**, then click **Save**.

Sharing Settings

Network/Media Server Name:

Enable	Access Method	Access Address	Port
<input checked="" type="checkbox"/>	Media Server	--	--
<input checked="" type="checkbox"/>	Network Neighborhood	\\MyShare	--
<input checked="" type="checkbox"/>	FTP	ftp://192.168.1.1:21	<input type="text" value="21"/>
<input checked="" type="checkbox"/>	FTP(via Internet)	ftp://0.0.0.0:21	21

4. Refer to the following table to access your USB disk remotely.

<p>Windows computer</p>	<ol style="list-style-type: none"> 1) Open the Windows Explorer (or go to Computer, only for Windows users) or open a web browser. 2) Type the server address in the address bar: Type in ftp://<WAN IP address of the modem router>:<port number> (such as ftp://59.40.2.243:21). If you have specified the domain name of the modem router, you can also type in ftp://<domain name>:<port number> (such as ftp://MyDomainName:21)  <ol style="list-style-type: none"> 3) Press Enter on the keyboard. 4) Access with the username and password you set in To Set up Authentication for Data Security. <p>Tips: You can also access the USB disk via a third-party app for network files management, which can resume broken file transfers.</p>
	<p>Tablet</p>

Tips:

Click [Set Up a Dynamic DNS Service Account](#) to learn how to set up a domain name for your modem router.

9.1.3. Customize the Access Settings

By default, all the network clients can access all folders on your USB disk. You can customize your sharing settings by setting a sharing account, sharing specific contents and setting a new sharing address on the modem router's web management page.

1. Visit <http://tplinkmodem.net>, then log in with your TP-Link ID or the password you set for the modem router.
2. Go to [Advanced](#) > [USB Sharing](#) > [USB Storage Device](#) page.

- **To Customize the Address of the USB Disk**

You can customize the server name and use the name to access your USB disk.

1. On the [Sharing Settings](#) part, make sure [Network Neighborhood](#) is ticked, and enter a Network/Media Server Name as you like, such as [MyShare](#), then click [Save](#).

Sharing Settings

Network/Media Server Name:

Enable	Access Method	Access Address	Port
<input checked="" type="checkbox"/>	Media Server	--	--
<input checked="" type="checkbox"/>	Network Neighborhood	\\MyShare	--
<input checked="" type="checkbox"/>	FTP	ftp://192.168.1.1:21	<input type="text" value="21"/>
<input checked="" type="checkbox"/>	FTP(via Internet)	ftp://0.0.0.0:21	21

2. Now you can access the USB disk by visiting `\\MyShare` (for Windows) or `smb://MyShare` (for Mac).

- **To Only Share Specific Content**

1. Focus on the [Folder Sharing](#) section. Click the button to disable [Share All](#), then click [Add](#) to add a new sharing folder.

Folder Sharing

Share All:

<input type="checkbox"/>	ID	Folder Name	Folder Path	Media Sharing	Volume Name	Status	Modify
<input type="checkbox"/>	--	--	--	--	--	--	--

Volume Name:

Folder Path:

Folder Name:

Enable Authentication

After disable authentication, if you are still asked to login, type "guest" in account and leave the password blank.

Enable Write Access

Enable Media Sharing

2. Select the [Volume Name](#) and [Folder Path](#), then enter a [Folder Name](#) as you like.

3. Decide the way you share the folder:

- **Enable Authentication:** Select to enable authentication for this folder sharing, and you will be required to log in to the Sharing Account to access the USB disk. Refer to [To Set up Authentication for Data Security](#) to learn more.
- **Enable Write Access:** If you tick this check box, network clients can modify this folder.
- **Enable Media Sharing:** Tick to enable media sharing for this folder, and you can view photos, play music and watch movies stored on the USB disk directly from DLNA-supported devices. Refer to [Media Sharing](#) to learn more.

4. Click [Save](#).

Tips:

The modem router can share eight volumes at most. You can click  on the page to detach the corresponding volume you do not need to share.

Folder Sharing

Share All:

[+ Add](#) [- Delete](#)

<input type="checkbox"/>	ID	Folder Name	Folder Path	Media Sharing	Volume Name	Status	Modify
<input type="checkbox"/>	1	1	G:/TPDLNA	Off	sda1		 

• **To Set up Authentication for Data Security**

You can set up authentication for your USB device so that network clients will be required to enter the username and password when accessing the USB disk.

1. Under [Sharing Account](#), choose [Use Default Account](#) or [Use New Account](#). The username and password are both admin for the default account. If you choose [Use New Account](#), you have to customize the username and a password.

Sharing Account

Content sharing requires a sharing account. You can use the login account or create a new one.

Account: [Use Default Account](#)
 [Use New Account](#)

Username:

Password:  (Same as Login Password)

[Save](#)

Note:

For Windows users, do not set the sharing username the same as the Windows username. Otherwise, Windows credential mechanism may cause the following problems:

- If the sharing password is also the same as the Windows password, authentication will not work since the Windows system will automatically use its account information for USB access.
- If the sharing password is different from the Windows password, the Windows system will be unable to remember your credentials and you will always be required to enter the sharing password for USB access.

2. Specify the folder(s) to enable authentication.

- If you want to enable authentication for all folders, leave [Share All](#) enabled, and toggle on [Enable Authentication](#).

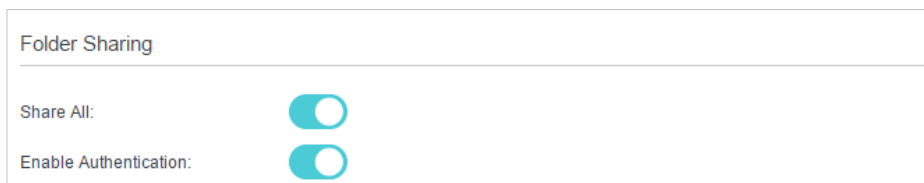

Folder Sharing

Share All:

Enable Authentication:

- If you want to enable authentication for specific folders, disable [Share All](#) and click [Add](#) to specify the folders, and select [Enable Authentication](#).

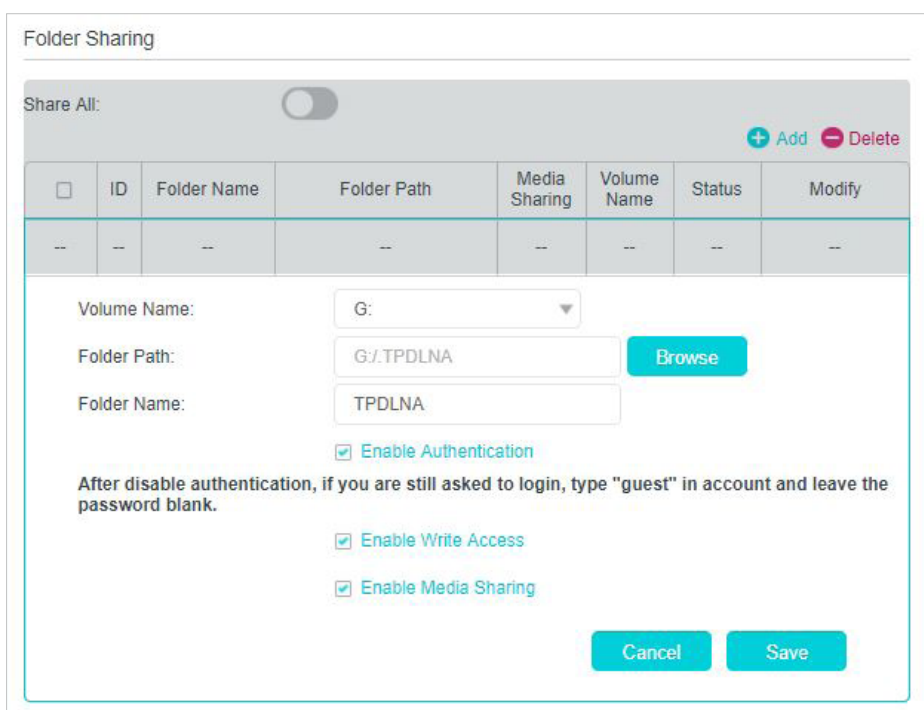

Folder Sharing

Share All:

[+ Add](#) [- Delete](#)

<input type="checkbox"/>	ID	Folder Name	Folder Path	Media Sharing	Volume Name	Status	Modify
<input type="checkbox"/>	--	--	--	--	--	--	--

Volume Name:

Folder Path:

Folder Name:

[Enable Authentication](#)

After disable authentication, if you are still asked to login, type "guest" in account and leave the password blank.

[Enable Write Access](#)

[Enable Media Sharing](#)

Note:

Due to Windows credential mechanism, you might be unable to access the USB disk after changing Authentication settings. Please log out from the Windows and try to access again. Or you can change the address of the USB disk by referring to [To Customize the Address of the USB Disk](#).

9.2. Media Sharing

Media Sharing allows you to view photos, play music and watch movies stored on the USB disk directly from DLNA-supported devices, such as your computer, tablet or games console.

1. When your USB disk is inserted into the modem router, your DLNA-supported devices (such as your computer and tablet) connected to the modem router can detect and play the media files on the USB disks.

2. Refer to the following table for detailed instructions.

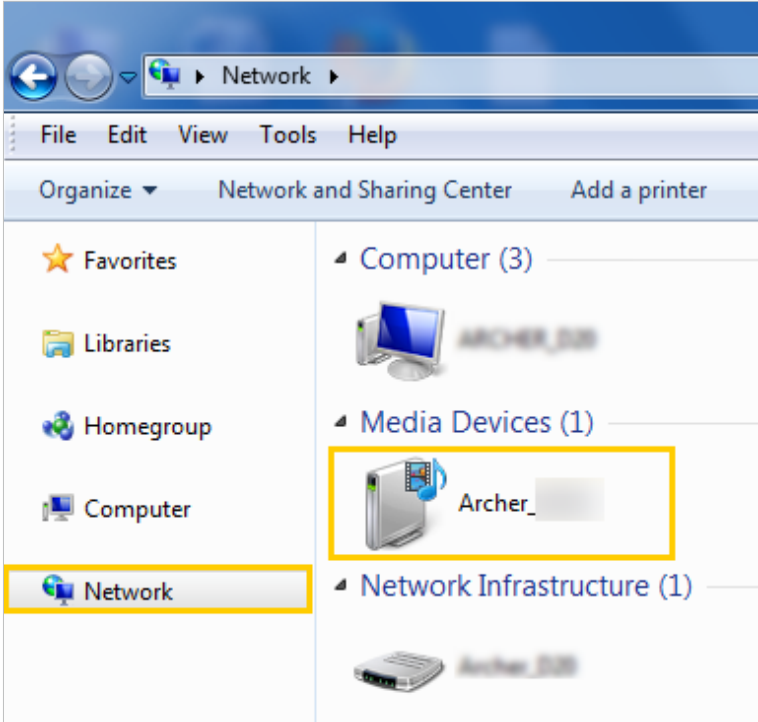
Windows Computer	<ul style="list-style-type: none"> Go to Computer > Network, then click the Media Server Name (Archer_ model number by default) in the Media Devices section. <p>Note: Here we take Windows 7 as an example.</p>  <p>The screenshot shows a Windows 7 Network folder window. The address bar shows 'Network'. The left sidebar has 'Network' selected. The main pane shows three categories: 'Computer (3)', 'Media Devices (1)', and 'Network Infrastructure (1)'. Under 'Media Devices (1)', a device named 'Archer_' is highlighted with a yellow box.</p>
Smart device	<ul style="list-style-type: none"> Use a third-party DLNA-supported player.

9.3. 3G/4G Settings

The modem router can be used as a 3G/4G wireless router if you have a 3G/4G USB modem. There are two ways to use your 3G/4G network:

- As a backup solution for internet access
- As the only way to access the internet

9.3.1. As a Backup Solution for Internet Access

Using 3G/4G network as a backup solution for internet access, your modem router will be directly connected to the 3G/4G network when the original network service fails.

Follow the steps below to set your 3G/4G network as a backup for internet access:

1. Plug your USB modem into the USB port of your modem router.
2. Visit <http://tplinkmodem.net>, then log in with your TP-Link ID or the password you set for the modem router.
3. Go to [Advanced](#) > [USB Settings](#) > [3G/4G Settings](#), and select the box of [Enable 3G/4G as a backup solution for Internet access](#).

3G/4G Settings

Note: 3G or 4G access is unavailable in the current operation mode. Please enable 3G/4G backup or change the operation mode to 3G/4G Router mode.

[Enable 3G/4G as a backup solution for Internet access](#)

3G/4G USB Modem: Detected successfully.

PIN Status: Unknown

Mobile ISP:

Set Dial Number, APN, Username and Password manually

Authentication Type:

Connection Status: Disconnected

[3G/4G USB Modem Settings](#)

4. Verify that your [3G/4G USB Modem](#) is successfully identified.

Note:

The 3G/4G USB modem will not be identified if it is incompatible with the modem router. Find the 3G/4G Compatibility List on the web page: <http://www.tp-link.com/en/comp-list.html>. If your USB modem is incompatible, contact our technical support.

5. Verify that the modem router has correctly recognized your [Mobile ISP](#). When your [Mobile ISP](#) is correct, you have successfully set 3G/4G network as a backup solution for internet access. Otherwise, select the box [Set the Dial Number, APN, Username and Password manually](#) and enter the information provided by your 3G/4G network service provider.
6. Click [Advanced](#) to have more configurations if needed.
7. Click [Save](#) to make the settings effective.

9.3.2. As the Only Way to Access the Internet

If you want the 3G/4G network to be your only way to access the internet, follow the steps below to configure:

1. Plug your USB modem into the USB port of your modem router.
2. Visit <http://tplinkmodem.net>, and log in with your TP-Link ID or the password you set for the modem router.
3. Go to [Advanced](#) > [Operation Mode](#) and choose [3G/4G Router Mode](#).
4. Click [Save](#) and when the modem router is successfully rebooted, the settings will be effective.
5. Go to [Advanced](#) > [USB Sharing](#) > [3G/4G Settings](#).

The screenshot shows the '3G/4G Settings' page. At the top, it says '3G/4G USB Modem: Detected successfully.' Below that, 'PIN Status: Unknown'. The 'Mobile ISP:' is set to '3' in a dropdown menu. There is a checkbox for 'Set Dial Number, APN, Username and Password manually' which is unchecked. 'Connection Mode:' is set to 'Auto' and 'Authentication Type:' is also set to 'Auto'. At the bottom left, there are 'Connect' and 'Disconnect' buttons, with the text 'Connecting' next to them. Below the buttons is a 'Advanced' link with a heart icon. At the bottom right, there is a 'Save' button. A link for '> 3G/4G USB Modem Settings' is at the bottom left.

6. Verify that your [3G/4G USB Modem](#) is successfully detected.

Note:

If your 3G/4G USB modem is incompatible with the modem router, it will not be identified. Find the 3G/4G Compatibility List on the web page: <http://www.tp-link.com/en/comp-list.html>. If your USB modem is incompatible, contact our technical support.

7. Verify that the modem router has correctly recognized your [Mobile ISP](#). When your [Mobile ISP](#) is correct, you can enjoy the internet! Otherwise, select the box [Set the Dial Number, APN, Username and Password manually](#) and enter the information provided by your 3G/4G network service provider.
8. Select the [Connection Mode](#). The default mode is [Always on](#). You can choose [Connect on demand](#) or [Connect manually](#).

- If you choose [Connect manually](#), you need to click the [Connect](#) or [Disconnect](#) button to manually turn on or off the internet.
 - If you choose [Connect on demand](#), the network will automatically turn off when there is no internet request in [Max Idle Time](#), and turn on again when you try to connect to the internet.
9. Click [Advanced](#) to have more configurations if needed.
 10. Click [Save](#) to make the settings effective.

Chapter 10

Parental Controls

This function allows you to block inappropriate, explicit and malicious websites and limit internet access during specified time periods.

I want to:

Control what types of websites my children or other home network users can visit and the time of day they are allowed to access the internet.

For example, I want to allow my children's devices (for example, a computer or a tablet) to access only www.tp-link.com and wikipedia.org from 18:00 (6PM) to 22:00 (10PM) on weekdays and not other time.

How can I do that?

1. Visit <http://tplinkmodem.net>, and log in with your TP-Link ID or the password you set for the router.
2. Go to [Basic](#) or [Advanced](#) > [Parental Controls](#) and enable [Parental Controls](#).

Parental Controls

Parental Controls:

Devices Under Parental Controls

The Effective Time is based on the time of the router. The time can be set in "Advanced > System Tools > Time Settings".

[Refresh](#) [+](#) Add [-](#) Delete

<input type="checkbox"/>	ID	Device Name	MAC Address	Effective Time	Description	Status	Modify
<input type="checkbox"/>	--	--	--	--	--	--	--

Content Restriction

Content Restriction:

Restriction Policy: Blacklist Whitelist

[+](#) Add a New Keyword

[Save](#)

3. Click [Add](#).

Devices Under Parental Controls

The Effective Time is based on the time of the router. The time can be set in "Advanced > System Tools > Time Settings".

Refresh + Add - Delete

<input type="checkbox"/>	ID	Device Name	MAC Address	Effective Time	Description	Status	Modify
--	--	--	--	--	--	--	--

Device Name: Scan

MAC Address:

Effective Time:

Description:

Enable This Entry

Cancel Save

- Click [Scan](#), and add the device to be controlled. Or, enter the [Device Name](#) and [MAC Address](#) manually.
- Click the icon to set the Effective Time. Drag the cursor over the appropriate cell(s) and click [OK](#).

Note: The time of Parental Controls is based on the system time of the modem router. Please go to [Advanced > System Tools > Time Settings](#) to set the correct time..

System Time: 01/01/2016 00:03:41

	Sun	Mon	Tue	Wed	Thu	Fri	Sat
0:00							
1:00							
2:00							
3:00							
4:00							
5:00							
6:00							
7:00							
8:00							
9:00							
10:00							
11:00							
12:00							
13:00							
14:00							
15:00							
16:00							
17:00							
18:00							
19:00							
20:00							
21:00							
22:00							
23:00							
24:00							

Effective Time

Reset OK

- Enter a [Description](#) for the entry.
- Select the check box to enable this entry and click [OK](#).
- Enable [Content Restriction](#) and select the restriction mode.

- 1) In **Blacklist** mode, the controlled devices cannot access any websites containing the specified keywords during the Effective Time period.
- 2) In **Whitelist** mode, the controlled devices can only access websites containing the specified keywords during the Effective Time period.

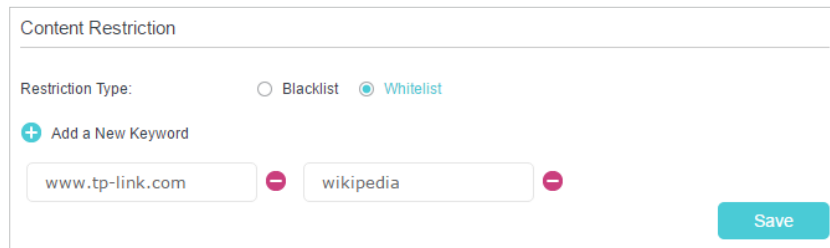

Content Restriction

Restriction Type: Blacklist Whitelist

+ Add a New Keyword

www.tp-link.com - wikipedia -

Save

9. Click **Add a New Keyword**. You can add many keywords for both Blacklist and Whitelist. Below are some sample entries to allow access.
 - 1) Enter a web address (for example, `www.tp-link.com`) or a web address keyword (for example, `wikipedia`) to only allow or block access to the websites containing that keyword.
 - 2) Specify the domain suffix (for example, `.edu` or `.org`) to allow access only to the websites with that suffix.
10. Enter the keywords or websites you want to add and click **Save**.

Done!

Now you can control your children's internet access according to your needs.

Chapter 11

QoS

This chapter explains how to create a QoS (Quality of Service) rule to prioritize your online activities, which minimizes the impact caused by heavy internet traffic.

It contains the following sections:

- [Prioritize Internet Traffic with QoS](#)
- [Update the Database](#)

11. 1. Prioritize Internet Traffic with QoS

QoS (Quality of Service) is designed to ensure the efficient operation of the network when network congestion is encountered.

I want to:

Specify priority levels for some devices or applications.

For example, I have several devices that are connected to my wireless network. I would like to set an intermediate speed on the internet for my phone.

How can I do that?

1. Enable QoS and set bandwidth allocation.
 - 1) Visit <http://tplinkmodem.net>, and log in with your TP-Link ID or the password you set for the router.
 - 2) Go to [Advanced](#) > [QoS](#) > [Settings](#).
 - 3) Select [Enable QoS](#).
 - 4) Choose your [Line Type](#).
 - 5) Input the maximum upload and download bandwidth provided by your internet service provider. 1Mbps equals to 1000Kbps.
 - 6) If you want to prioritize the IPTV traffic, select [Enable](#), the IPTV Priority will be high.
 - 7) Click [Advanced](#) and drag the scroll bar to set the bandwidth priority percentage.
 - 8) Click [Save](#).

The screenshot shows the QoS configuration page. At the top, the title is "QoS". Below it, there are several settings:

- QoS:** A checkbox labeled "Enable" is checked.
- Line Type:** Two radio buttons are present: "DSL" (selected) and "Other".
- Upload Bandwidth:** A text input field contains "1000" and a dropdown menu is set to "Mbps".
- Download Bandwidth:** A text input field contains "1000" and a dropdown menu is set to "Mbps".
- IPTV QoS:** A checkbox labeled "Enable" is checked.
- Advanced:** A button with a circular arrow icon.
- Priority Sliders:** Three horizontal sliders are shown, each with a yellow highlight and a percentage value to its right:
 - High Priority:** The slider is positioned at 60%.
 - Middle Priority:** The slider is positioned at 30%.
 - Low Priority:** The slider is positioned at 10%.
- Save:** A blue button at the bottom right corner.

2. Add a middle priority QoS rule for the phone.
 - 1) Click [Add](#) in the [Middle Priority](#) area and then select [By Device](#) and click [Scan](#).

QoS Rule

Type: By Device By Application

Device Name:

MAC Address:

2) Choose the respective device from the list.

ID	Device Name	IP Address	MAC Address	Operation
1	Unknown	192.168.1.200	50-E5-49-1E-06-80	<input style="width: 20px; height: 20px; border: none; border-radius: 50%;" type="button" value="+"/>

3) Click **Save**.

QoS Rule

Type: By Device By Application

Device Name:

MAC Address:

3. Refer to the steps above to apply other QoS rules if any.

Note:

If you want to delete a QoS rule, click to remove the responding rule from the list.

Done!

Now QoS is implemented to prioritize internet traffic.

11.2. Update the Database

This function can help to add or update the applications the router supports. If the applications you need are not listed in the Application list, you can try to download the new version and upgrade the database. New database versions are posted at www.tp-link.com and can be downloaded for free.

1. Download the latest QoS database from our website (www.tp-link.com).
2. Visit <http://tplinkmodem.net>, and log in with your TP-Link ID or the password you set for the router.

3. Go to [Advanced](#) > [QoS](#) > [Database](#). Click [Browse](#) to select the database upgrade file, and then click [Upgrade](#). Wait until the upgrade is complete and do not operate the router during the process.

Database Upgrade

New Database File: [Browse](#)

Database Version: 1.5.0

[Upgrade](#)

Chapter 12

Network Security

This chapter guides you on how to protect your home network from unauthorized users by implementing these five network security functions. You can protect the router from cyber attacks using the Firewall, prevent certain users from accessing the specified service, and even block internet access completely using Service Filtering, or use Access Control to block or allow specific client devices to access your network. Or you can prevent ARP spoofing and ARP attacks by using IP & MAC Binding and you can protect your IPv6 network by preventing access from the internet using IPv6 Firewall.

- [Firewall & DoS Protection](#)
- [Service Filtering](#)
- [Access Control](#)
- [IP & MAC Binding](#)
- [IPv6 Firewall](#)

12.1. Firewall & DoS Protection

The SPI (Stateful Packet Inspection) Firewall and DoS (Denial of Service) Protection protect the router from cyber attacks.

The SPI Firewall can prevent cyber attacks and validate the traffic that is passing through the router based on the protocol. This function is enabled by default, and it's recommended to keep the default settings.

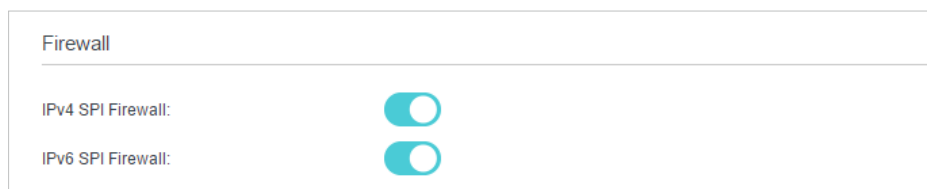

DoS Protection can protect your home network against DoS attacks from flooding your network with server requests. Follow the steps below to configure DoS Protection.

1. Visit <http://tplinkmodem.net>, and log in with your TP-Link ID or the password you set for the router.
2. Go to [Advanced](#) > [Security](#) > [Firewall & DoS Protection](#).

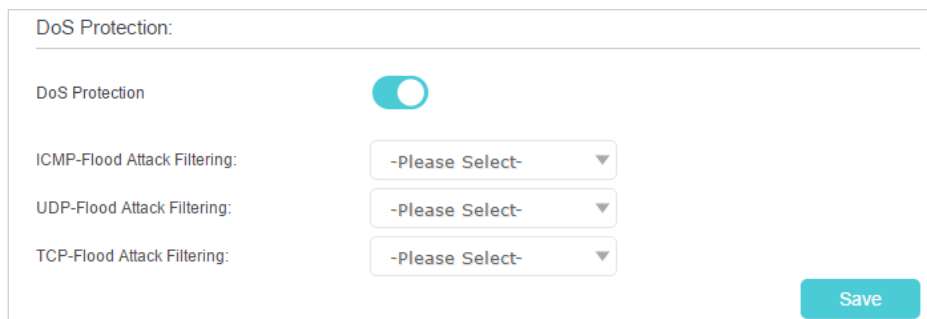

3. Enable [DoS Protection](#).
4. Set the level ([Low](#), [Middle](#) or [High](#)) of protection for [ICMP-Flood Attack Filtering](#), [UDP-Flood Attack Filtering](#) and [TCP-Flood Attack Filtering](#).
 - [ICMP-Flood Attack Filtering](#) - Enable to prevent the ICMP (Internet Control Message Protocol) flood attack.
 - [UDP-Flood Attack Filtering](#) - Enable to prevent the UDP (User Datagram Protocol) flood attack.
 - [TCP-Flood Attack Filtering](#) - Enable to prevent the TCP (Transmission Control Protocol) flood attack.
5. Click [Save](#).

 Tips:

1. The level of protection is based on the number of traffic packets. Specify the level at [DoS Protection Level Settings](#).

Dos Protection Level Settings

ICMP-Flood Protection Level:

Low: (5-3600) packets/sec

Middle: (5-3600) packets/sec

High: (5-3600) packets/sec

UDP-Flood Protection Level:

Low: (5-3600) packets/sec

Middle: (5-3600) packets/sec

High: (5-3600) packets/sec

TCP-SYN-Flood Protection Level:

Low: (5-3600) packets/sec

Middle: (5-3600) packets/sec

High: (5-3600) packets/sec

[Save](#)

- The protection will be triggered immediately when the number of packets exceeds the preset threshold value, and the vicious host will be displayed in the [Blocked DoS Host List](#).

Blocked DoS Host List

Host Number: 0 [Refresh](#) [Delete](#)

<input type="checkbox"/>	ID	IP Address	MAC Address
--	--	--	--

12.2. Service Filtering

With Service Filtering, you can prevent certain users from accessing the specified service, and even block internet access completely.

- Visit <http://tplinkmodem.net>, and log in with your TP-Link ID or the password you set for the router.
- Go to [Advanced](#) > [Security](#) > [Service Filtering](#).
- Toggle on [Service Filtering](#).
- Click [Add](#).

Filtering List

Refresh + Add - Delete

<input type="checkbox"/>	ID	Service Type	Port	IP Address	Status	Modify
--	--	--	--	--	--	--

Service Type: Any(ALL) ▼

Protocol: TCP/UDP ▼

Starting Port: 1 (1-65535)

Ending Port: 65535 (1-65535)

Service Type: Any(ALL)

Filter Service For: Single IP Address IP Address Range All IP Addresses

Cancel Save

5. Select a **Service Type** from the drop-down list and the following four fields will be auto-populated. Select **Custom** when your desired service type is not listed, and enter the information manually.
6. Specify the IP address(es) that this filtering rule will apply to.
7. Click **Save**.

■ Note: If you want to disable this entry, click the  icon.

12.3. Access Control

Access Control is used to block or allow specific client devices to access your network (via wired or wireless) based on a list of blocked devices (Blacklist) or a list of allowed devices (Whitelist).

I want to:

Block or allow specific client devices to access my network (via wired or wireless).

How can I do that?

1. Visit <http://tplinkmodem.net>, and log in with your TP-Link ID or the password you set for the router.
2. Go to **Advanced > Security > Access Control** and enable **Access Control**.

Access Control

Access Control:

Access Mode

Access Mode: Blacklist Whitelist

[Save](#)

Devices in Blacklist

[+ Add](#) [- Delete](#)

	ID	Device Name	MAC Address	Modify
<input type="checkbox"/>	--	--	--	--

Online Devices

[Refresh](#) [Block](#)

	ID	Device Name	IP Address	MAC Address	Connection Type
<input type="checkbox"/>	1	JuneHong-RockPC	192.168.1.100	50-7B-9D-5C-1A-2F	Wired

- Select the access mode to either block (recommended) or allow the device(s) in the list.

To block specific device(s)

- Select **Blacklist** and click **Save**.
- Select the device(s) to be blocked in the **Online Devices** table.
- Click **Block** above the **Online Devices** table. The selected devices will be added to **Devices in Blacklist** automatically.

To allow specific device(s)

- Select **Whitelist** and click **Save**.
- Click **Add**.

Devices in Whitelist

[+ Add](#) [- Delete](#)

	ID	Device Name	MAC Address	Modify
<input type="checkbox"/>	--	--	--	--

Device Name: [Scan](#)

MAC Address: [Cancel](#) [Save](#)

- 1) Click **San** and the **Device Name** and **MAC Address** will be automatically filled in.
Or enter the **Device Name** and **MAC Address** manually.
- 2) Click **Save**.

Done!

Now you can block or allow specific client devices to access your network (via wired or wireless) using the **Blacklist** or **Whitelist**.

12.4. IP & MAC Binding

IP & MAC Binding, namely, ARP (Address Resolution Protocol) Binding, is used to bind a network device's IP address to its MAC address. This will prevent ARP spoofing and other ARP attacks by denying network access to a device with a matching IP address in the Binding list, but an unrecognized MAC address.

I want to:

Prevent ARP spoofing and ARP attacks.

How can I do that?

1. Visit <http://tplinkmodem.net>, and log in with your TP-Link ID or the password you set for the router.
2. Go to **Advanced > Security > IP & MAC Binding** and enable **IP & MAC Binding**.

Settings

IP & MAC Binding:

Binding List

+ Add - Delete

<input type="checkbox"/>	ID	MAC Address	IP Address	Status	Enable	Modify
<input type="checkbox"/>	--	--	--	--	--	--

ARP List

Refresh Bind

<input type="checkbox"/>	ID	Device Name	MAC Address	IP Address	Bound	Modify
<input type="checkbox"/>	1	BRCM-CM	E8:94:F6:DE:AD:07	192.168.1.86	Unloaded	
<input type="checkbox"/>	2	Unknown	50:E5:49:1E:06:80	192.168.1.200	Unloaded	
<input type="checkbox"/>	3	Unknown	A4:2B:B0:C2:6C:5A	192.168.1.70	Unloaded	

3. Bind your device(s) according to your needs.

To bind the connected device(s)

- 1) Select the device(s) to be bound in the [ARP List](#).
- 2) Click [Bind](#) to add to the [Binding List](#).

To bind the unconnected device

- 1) Click [Add](#).

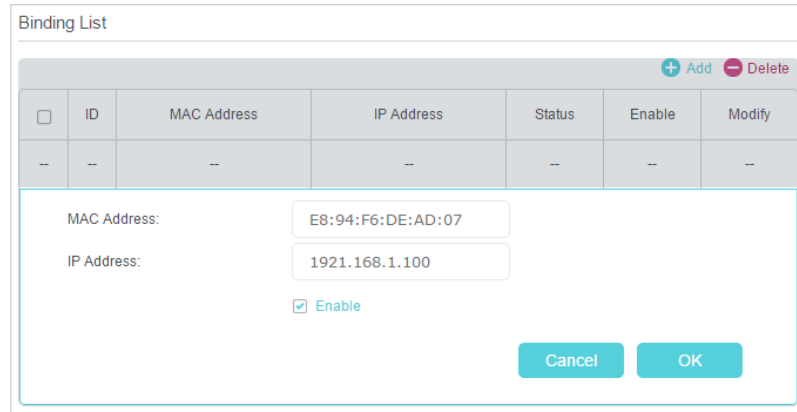

The screenshot shows a web interface titled "Binding List". At the top right, there are buttons for "+ Add" and "- Delete". Below this is a table with the following columns: ID, MAC Address, IP Address, Status, Enable, and Modify. The table currently contains one row with dashes in all cells. Below the table is a form to add a new entry. It has two input fields: "MAC Address" with the value "E8:94:F6:DE:AD:07" and "IP Address" with the value "1921.168.1.100". There is also a checked checkbox labeled "Enable". At the bottom right of the form are "Cancel" and "OK" buttons.

- 2) Enter the [MAC Address](#) and [IP Address](#) that you want to bind.
- 3) Select the check box to enable the entry and click [OK](#).

Done!

Enjoy the internet without worrying about ARP spoofing and ARP attacks.

12.5. IPv6 Firewall

IPv6 Firewall protects your IPv6 network by preventing access from the internet. However, when you are hosting a service, such as a file sharing server in your local network, you can choose to allow access to the server from the internet by adding entries on this page. This feature is available only when you've set up an IPv6 connection.

1. Visit <http://tplinkmodem.net>, and log in with your TP-Link ID or the password you set for the router.
2. Go to [Advanced](#) > [Security](#) > [IPv6 Firewall](#).
3. Click [Add](#).

IPv6 Firewall

+ Add - Delete

<input type="checkbox"/>	ID	Service Type	Port	Internal IP	Protocol	Status	Modify
--	--	--	--	--	--	--	--

Interface Name: pppoe_ptm_101_0_d

Service Type: Scan

Port: (XX-XX or XX)

Internal IP: Scan

Protocol: ALL

Enable This Entry

Cancel Save

4. Select an interface name from the drop-down list. Interface names are names of the internet connections you have set up.
5. Click **Scan** to select a service from the list to automatically populate the **Port** field with an appropriate port number. It is recommended to keep the default Port if you are unsure about which one to use. If the service is not listed, manually enter the **Service Type** and the **Port** number (e.g., 21 or 21-25).
6. Click **Scan** to select the local host device running the service. If the device is not listed, enter its global IPv6 address in the **Internal IP** field
7. Select a protocol for the service from the drop-down list.
8. Tick **Enable This Entry** and click **Save**.

Note: If you want to disable this entry, click the  icon.

Chapter 13

NAT Forwarding

Modem router's NAT (Network Address Translation) feature makes the devices in the LAN use the same public IP address to communicate in the internet, which protects the local network by hiding IP addresses of the devices. However, it also brings about the problem that external host cannot initiatively communicate with the specified device in the local network.

The modem router can use a forwarding feature to remove the isolation of NAT and allow external internet hosts to intuitively communicate with the devices in the local network, thus enabling some special features.

TP-Link modem router includes four forwarding rules. If two or more rules are set, the priority of implementation from high to low is Virtual Servers, Port Triggering, UPnP and DMZ.

This chapter contains the following sections:

- [Translate Address and Port by ALG](#)
- [Share Local Resources over the Internet by Virtual Server](#)
- [Open Ports Dynamically by Port Triggering](#)
- [Make Applications Free from Port Restriction by DMZ](#)
- [Make Xbox Online Games Run Smoothly by UPnP](#)

13.1. Translate Address and Port by ALG

ALG (Application Layer Gateway) allows customized NAT (Network Address Translation) traversal filters to be plugged into the gateway to support address and port translation for certain application layer “control/data” protocols: FTP, TFTP, H323 etc. Enabling ALG is recommended.

1. Visit <http://tplinkmodem.net>, and log in with your TP-Link ID or the password you set for the router.
2. Go to [Advanced](#) > [NAT Forwarding](#) > [ALG](#).

ALG	
PPTP Pass-through:	<input checked="" type="checkbox"/> Enable
L2TP Pass-through:	<input checked="" type="checkbox"/> Enable
IPSec Pass-through:	<input checked="" type="checkbox"/> Enable
FTP ALG:	<input checked="" type="checkbox"/> Enable
TFTP ALG:	<input checked="" type="checkbox"/> Enable
H323 ALG:	<input checked="" type="checkbox"/> Enable
SIP ALG:	<input checked="" type="checkbox"/> Enable
RTSP ALG:	<input type="checkbox"/> Enable

Save

- **PPTP Pass-through:** If enabled, it allows Point-to-Point sessions to be tunneled through an IP network and passed through the router.
- **L2TP Pass-through:** If enabled, it allows Layer 2 Point-to-Point sessions to be tunneled through an IP network and passed through the router.
- **IPSec Pass-through:** If enabled, it allows IPSec (Internet Protocol Security) to be tunneled through an IP network and passed through the router. IPSec uses cryptographic security services to ensure private and secure communications over IP networks.
- **FTP ALG:** If enabled, it allows FTP (File Transfer Protocol) clients and servers to transfer data via NAT.
- **TFTP ALG:** If enabled, it allows TFTP (Trivial File Transfer Protocol) clients and servers to transfer data via NAT.
- **H323 ALG:** If enabled, it allows Microsoft NetMeeting clients to communicate via NAT.
- **SIP ALG:** If enabled, it allows clients communicate with SIP (Session Initiation Protocol) servers via NAT.

- **RTSP ALG:** If enabled, it allows RTSP (Real-Time Stream Protocol) clients and servers to transfer data via NAT.

13.2. Share Local Resources over the Internet by Virtual Server

When you build up a server in the local network and want to share it on the internet, Virtual Server can realize the service and provide it to the internet users. At the same time virtual server can keep the local network safe as other services are still invisible from the internet.

Virtual server can be used for setting up public services in your local network, such as HTTP, FTP, DNS, POP3/SMTP and Telnet. Different service uses different service port. Port 80 is used in HTTP service, port 21 in FTP service, port 25 in SMTP service and port 110 in POP3 service. Please verify the service port number before the configuration.

I want to:

Share my personal website I've built in a local network with my friends through the internet.

For example, the personal website has been built on my home PC (192.168.1.100). I hope that my friends can visit my website. The PC is connected to the modem router with the WAN IP address 218.18.232.154.

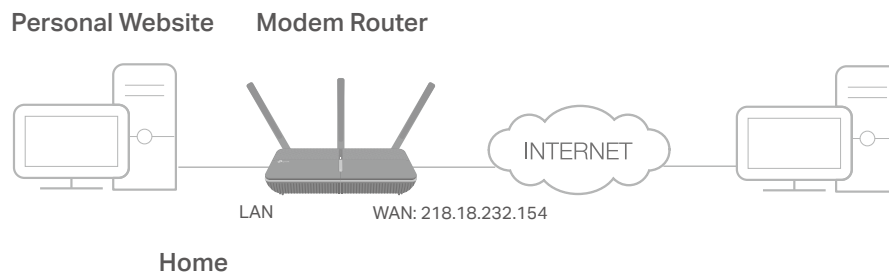

How can I do that?

1. Assign a static IP address to your PC, for example 192.168.1.100.
2. Visit <http://tplinkmodem.net>, and log in with your TP-Link ID or the password you set for the router.
3. Go to [Advanced](#) > [NAT Forwarding](#) > [Virtual Servers](#), click [Add](#).

Virtual Servers

+ Add - Delete

☐	ID	Service Type	External Port	Internal IP	Internal Port	Protocol	Status	Modify
--	--	--	--	--	--	--	--	--

Note: Virtual Server can be configured only when there is an available interface. If the external port is already used for Remote Management or CWMP, Virtual Server will not take effect.

Interface Name:

Service Type: Scan

External Port: (XX-XX or XX)

Internal IP:

Internal Port: (XX or Blank, 1-65535)

Protocol:

Enable This Entry

Cancel
Save

4. Click [Scan](#), and choose [HTTP](#). The external port, internal port and protocol will be automatically filled with contents. Enter the PC's IP address 192.168.1.100 in the [Internal IP](#) field.

5. Click [Save](#) to save the settings.

Tips:

1. It is recommended to keep the default settings of [Internal Port](#) and [Protocol](#), if you are not clear about which port and protocol to use.
2. If the service you want to use is not in the [Service Type](#), you can enter the corresponding parameters manually. You should verify the port number that the service needs.
3. You can add multiple virtual server rules if you want to provide several services from a modem router. Please note that the [External Port](#) cannot be overlapped.

Done!

Internet users can enter [http://WAN IP](#) (in this example: [http://218.18.232.154](#)) to visit your personal website.

Tips:

1. For a WAN IP that is assigned dynamically by ISP, it is recommended to apply and register a domain name for the WAN by DDNS, go to [Set Up a Dynamic DNS Service Account](#) for more information. Then you can use [http://domain name](#) to visit the website.
2. If you have changed the default [External Port](#), you should use [http://WAN IP: External Port](#) or [http://domain name: External Port](#) to visit the website.

13.3. Open Ports Dynamically by Port Triggering

Port triggering can specify a triggering port and its corresponding external ports. When a host in the local network initiates a connection to the triggering port, all the external ports will be opened for subsequent connections. The modem router can record the IP

address of the host. When the data from the internet returns to the external ports, the modem router can forward them to the corresponding host. Port triggering is mainly applied to online games, VoIPs and video players. Common applications include MSN Gaming Zone, Dialpad, Quick Time 4 players, and so on.

Follow the steps below to configure the port triggering rules:

1. Visit <http://tplinkmodem.net>, and log in with your TP-Link ID or the password you set for the router.
2. Go to [Advanced](#) > [NAT Forwarding](#) > [Port Triggering](#) and click [Add](#).

Port Triggering

+ Add - Delete

<input type="checkbox"/>	ID	Application	Triggering Port	Triggering Protocol	External Port	External Protocol	Status	Modify
--	--	--	--	--	--	--	--	--

Interface Name:

Application:

Triggering Port: (XX, 1-65535)

Triggering Protocol:

External Port: (XX or XX-XX, 1-65535, at most 5 pairs)

External Protocol:

Enable This Entry

3. Click [Scan](#), and select the desired application. The triggering port and protocol, the external port and protocol will be automatically filled with contents. Here we take [MSN Gaming Zone](#) as an example.
4. Click [Save](#) to save the settings.

Tips:

1. You can add multiple port triggering rules according to your network need.
2. If the application you need is not listed in the [Existing Applications](#) list, please enter the parameters manually. You should verify the external ports the application uses first and enter them into [External Port](#) field according to the format the page displays.

13.4. Make Applications Free from Port Restriction by DMZ

When a PC is set to be a DMZ (Demilitarized Zone) host in the local network, it is totally exposed to the internet, which can realize the unlimited bidirectional communication

between internal hosts and external hosts. The DMZ host becomes a virtual server with all ports opened. When you are not clear about which ports to open in some special applications, like IP camera and database software, you can set the PC to be a DMZ host.

Note:

DMZ is most applicable when you don't know which ports to open. When it is enabled, the DMZ host is totally exposed to the internet, which may bring some potential safety hazard. If DMZ is not in use, please disable it in time.

I want to:

Make the home PC join the internet online game without port restriction.

For example, Due to some port restriction, when playing the online games, you can login normally but cannot join a team with other players. To solve this problem, set your PC as a DMZ with all ports opened.

How can I do that?

1. Assign a static IP address to your PC, for example 192.168.1.100.
2. Visit <http://tplinkmodem.net>, and log in with your TP-Link ID or the password you set for the router.
3. Go to **Advanced > NAT Forwarding > DMZ** and select the checkbox to enable DMZ.



DMZ

DMZ: Enable DMZ

DMZ Host IP Address:

Save

4. Enter the IP address 192.168.1.100 in the **DMZ Host IP Address** field.
5. Click **Save** to save the settings.

Done!

The configuration is completed. You've set your PC to a DMZ host and now you can make a team to game with other players.

13.5. Make Xbox Online Games Run Smoothly by UPnP

UPnP (Universal Plug and Play) protocol allows the applications or host devices to automatically find the front-end NAT device and send request to it to open the corresponding ports. With UPnP enabled, the applications or host devices in the both sides of NAT device can freely communicate with each other realizing the

seamless connection of the network. You may need to enable the UPnP if you want to use applications such as multiplayer gaming, peer-to-peer connections, real-time communication (for example, VoIP or telephone conference), or remote assistance.

 Tips:

1. UPnP is enabled by default in this modem router.
2. Only the application supporting UPnP protocol can use this feature.
3. UPnP feature needs the support of operating system (e.g. Windows Vista/ Windows 7/ Windows 8, etc. Some of operating system need to install the UPnP components).

For example, when you connect your Xbox to the modem router which has connected to the internet to play online games, UPnP will send request to the modem router to open the corresponding ports allowing the following data penetrating the NAT to transmit. Therefore, you can play Xbox online games without a hitch.

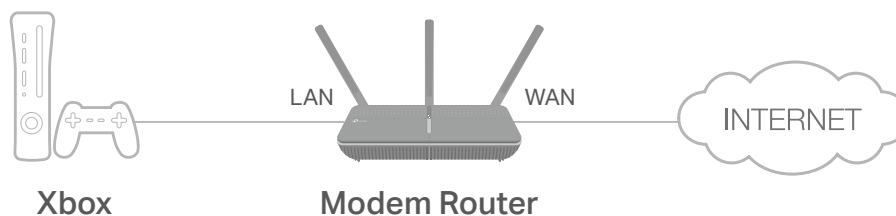

If necessary, you can follow the steps to change the status of UPnP.

1. Visit <http://tplinkmodem.net>, and log in with your TP-Link ID or the password you set for the modem router;
2. Go to **Advanced > NAT Forwarding > UPnP** and toggle on or off according to your needs.

UPnP

UPnP:

UPnP Service List

Total Clients: 0  Refresh

ID	Service Description	External Port	Protocol	Internal IP Address	Internal Port
--	--	--	--	--	--

Chapter 14

VPN Server

The VPN (Virtual Private Networking) Server allows you to access your home network in a secured way through the internet when you are out of the house. The router offers three ways to setup VPN connection: OpenVPN, PPTP (Point to Point Tunneling Protocol) VPN and IPSec (Internet Protocol Security) VPN.

OpenVPN is somewhat complex but with greater security and more stability. It is suitable for restricted environment, such as campus network and company intranet.

PPTP VPN is easier to use and its speed is faster. It's compatible with most operating systems and also supports mobile devices. However, its security is poor and packets may be cracked easily. PPTP VPN may be blocked by some ISPs.

IPSec (IP Security) is a set of services and protocols defined by IETF (Internet Engineering Task Force) to provide high security for IP packets and prevent attacks.

This chapter contains the following sections, please choose the appropriate VPN server connection type according to your needs.

- [Use OpenVPN to Access Your Home Network](#)
- [Use PPTP VPN to Access Your Home Network](#)
- [Use IPSec VPN to Access Your Home Network](#)

14. 1. Use OpenVPN to Access Your Home Network

In an OpenVPN connection, the home network can act as a server, and the remote device can access the server through the router which acts as an OpenVPN Server gateway. To use the VPN feature, you should enable OpenVPN Server on your router, install and run VPN client software on the remote device. Please follow the steps below to set up an OpenVPN connection.

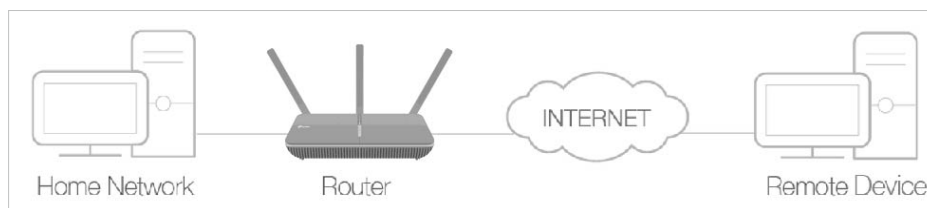

Step 1. Set up OpenVPN Server on Your Router

1. Visit <http://tplinkmodem.net>, and log in with your TP-Link ID or the password you set for the router.
2. Go to **Advanced > VPN > OpenVPN**, and select **Enable VPN Server**.

OpenVPN

Note: No certificate currently, please **Generate** one before enabling VPN Server.

Enable VPN Server

Service Type: UDP TCP

Service Port:

VPN Subnet/Netmask:

Client Access: Home Network Only Internet and Home Network

Note:

- Before you enable VPN Server, we recommend you configure Dynamic DNS Service (recommended) or assign a static IP address for your router's WAN port and synchronize your System Time via the internet.
 - The first time you configure the OpenVPN Server, you may need to **Generate** a certificate before you enable the VPN Server.
3. Select the **Service Type** (communication protocol) for OpenVPN Server: UDP, TCP.
 4. Enter a VPN **Service Port** to which a VPN device connects. The port number should be between 1024 and 65535.
 5. In the **VPN Subnet/Netmask** fields, enter the range of IP addresses that can be leased to the device by the OpenVPN server.

6. Select your **Client Access** type. Select **Home Network Only** if you only want the remote device to access your home network; select **Internet and Home Network** if you also want the remote device to access the internet through the VPN Server.
7. Click **Save**.
8. Click **Generate** to get a new certificate.

Certificate

Generate the certificate.

Generate

Note:

If you have already generated one, please skip this step, or click **Generate** to update the certificate.

9. Click **Export** to save the OpenVPN configuration file which will be used by the remote device to access your router.

Configuration File

Export the configuration.

Export

Step 2. Configure OpenVPN Connection on Your Remote Device

1. Visit <http://openvpn.net/index.php/download/community-downloads.html> to download the OpenVPN software, and install it on your device where you want to run the OpenVPN client utility.

Note:

You need to install the **OpenVPN** client utility on each device that you want to be able to use the VPN function. Mobile devices should download a third-party app from Google Play or Apple App Store.

2. After the installation, copy the file exported from your router to the OpenVPN client utility's "config" folder (for example, **C:\Program Files\OpenVPN\config** on Windows). The path depends on where the OpenVPN client utility is installed.
3. Run the OpenVPN client utility and connect it to OpenVPN Server.

14. 2. Use PPTP VPN to Access Your Home Network

PPTP VPN Server is used to create a VPN connection for remote devices. To use the VPN feature, you should enable PPTP VPN Server on your router, and configure the PPTP connection on the remote device. Please follow the steps below to set up a PPTP VPN connection.

Step 1. Set up PPTP VPN Server on Your Router

1. Visit <http://tplinkmodem.net>, and log in with your TP-Link ID or the password you set for the router.
2. Go to **Advanced > VPN > PPTP VPN**, and select **Enable VPN Server**.

PPTP VPN

Enable VPN Server

Client IP Address: -10.7.0. (up to 10 clients)

Username:

Password:

Note:

Before you enable [VPN Server](#), we recommend you configure Dynamic DNS Service (recommended) or assign a static IP address for router's WAN port and synchronize your [System Time](#) with internet.

3. In the [Client IP Address](#) field, enter the range of IP addresses (up to 10) that can be leased to the devices by the PPTP VPN server.
4. Enter the [Username](#) and [Password](#) to authenticate clients to the PPTP VPN server.
5. Click [Save](#).

Step 2. Configure PPTP VPN Connection on Your Remote Device

The remote device can use the Windows built-in PPTP software or a third-party PPTP software to connect to PPTP Server. Here we use the [Windows built-in PPTP software](#) as an example.

1. Go to [Start > Control Panel > Network and Internet > Network and Sharing Center](#).
2. Select [Set up a new connection or network](#).

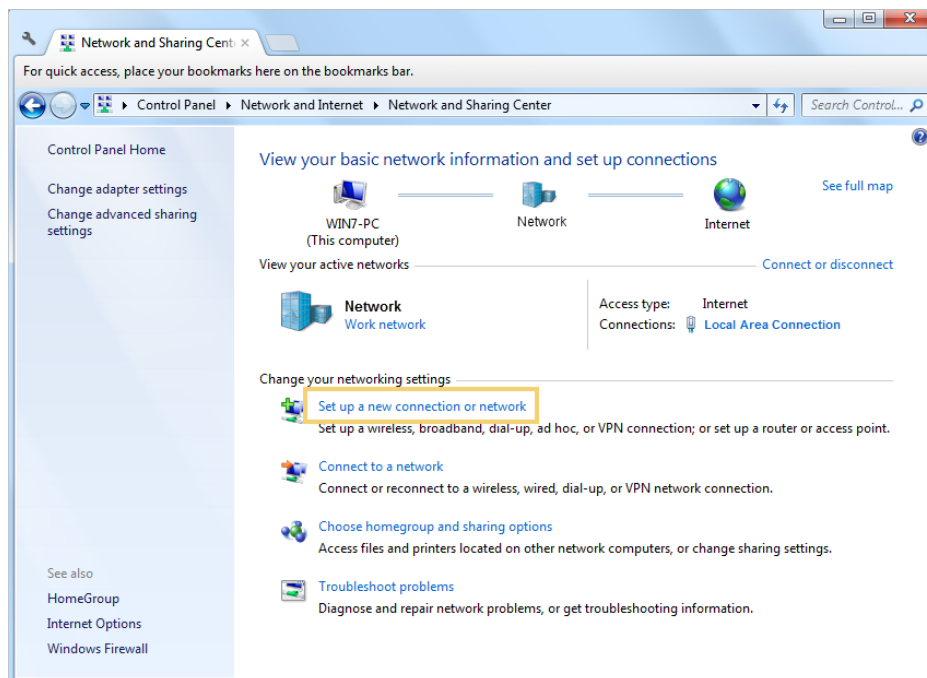

3. Select [Connect to a workplace](#) and click [Next](#).

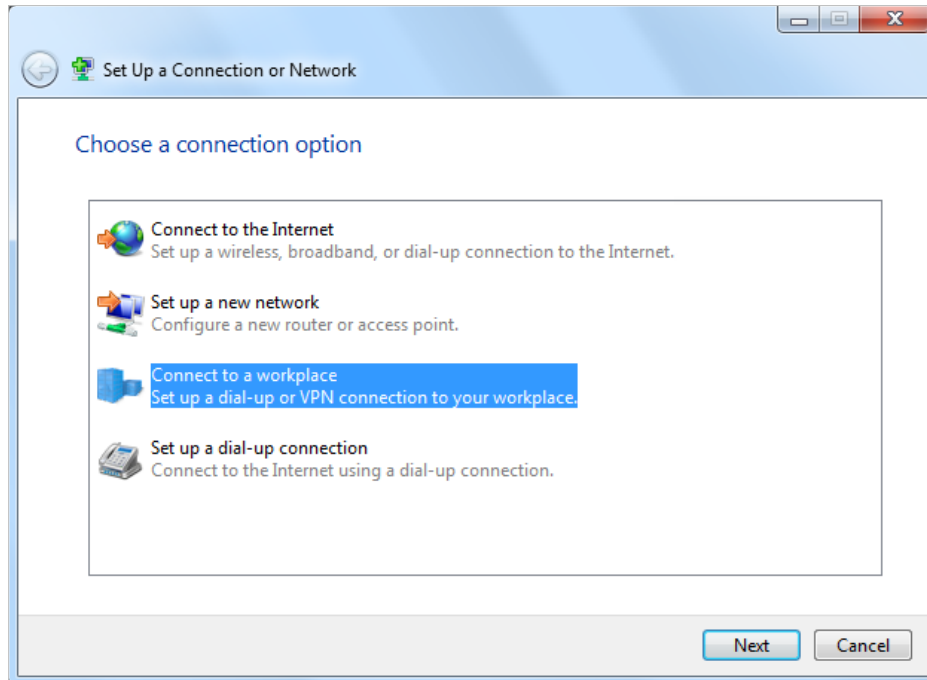

4. Select **Use my Internet connection (VPN)**.

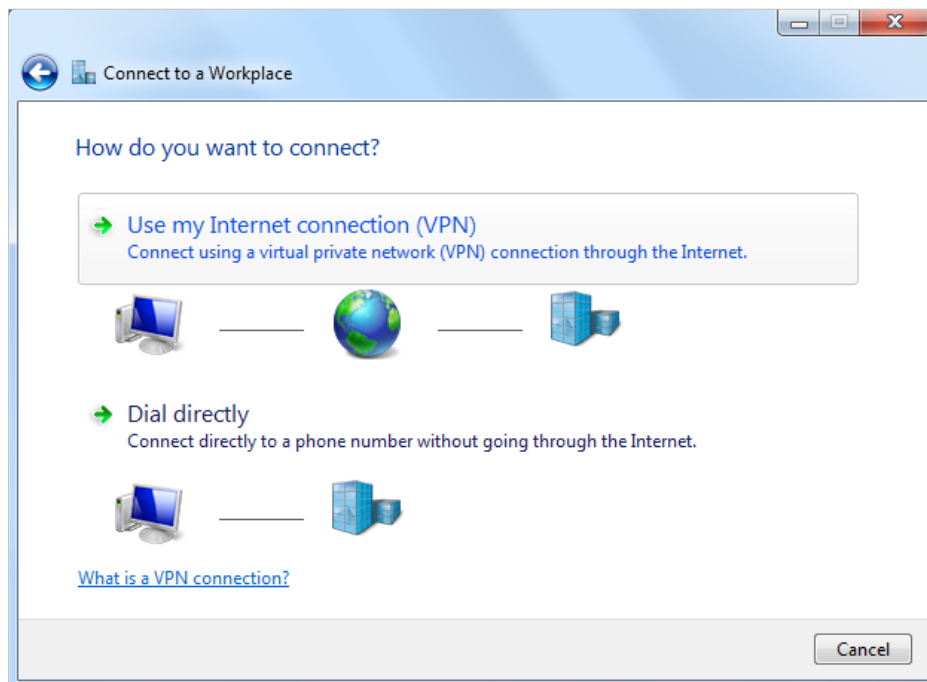

5. Enter the internet IP address of the router (for example: 218.18.1.73) in the **Internet address** field. Click **Next**.

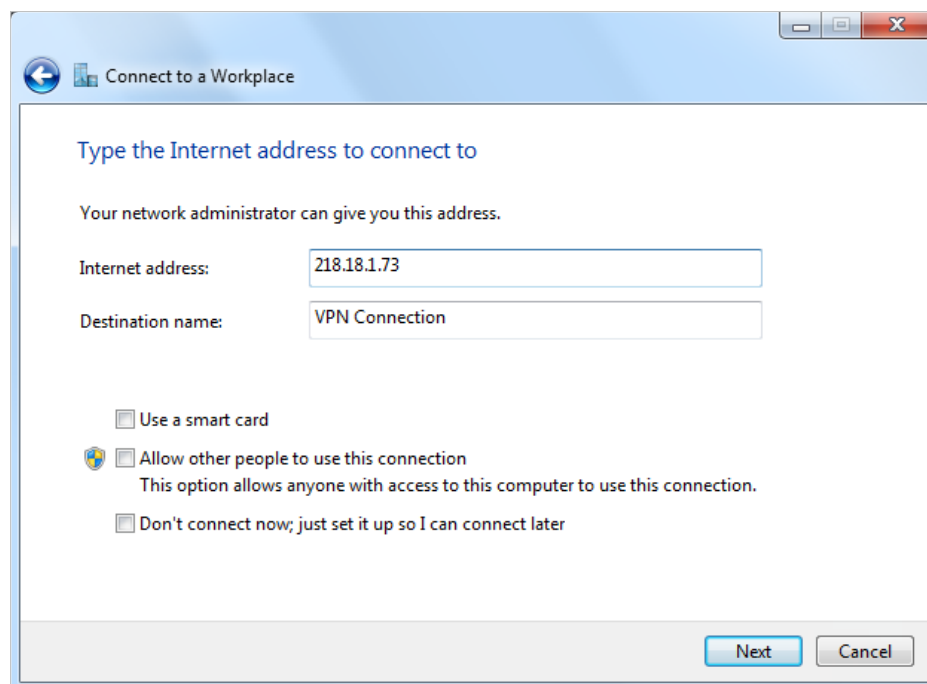

6. Enter the **Username** and **Password** you have set for the PPTP VPN server on your router, and click **Connect**.

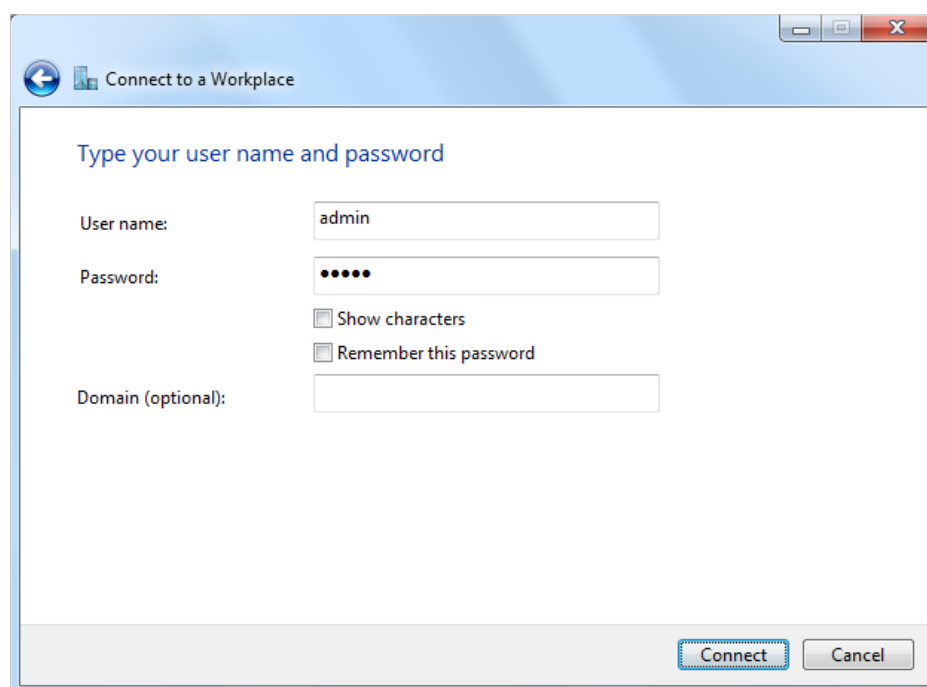

7. The PPTP VPN connection is created and ready to use.

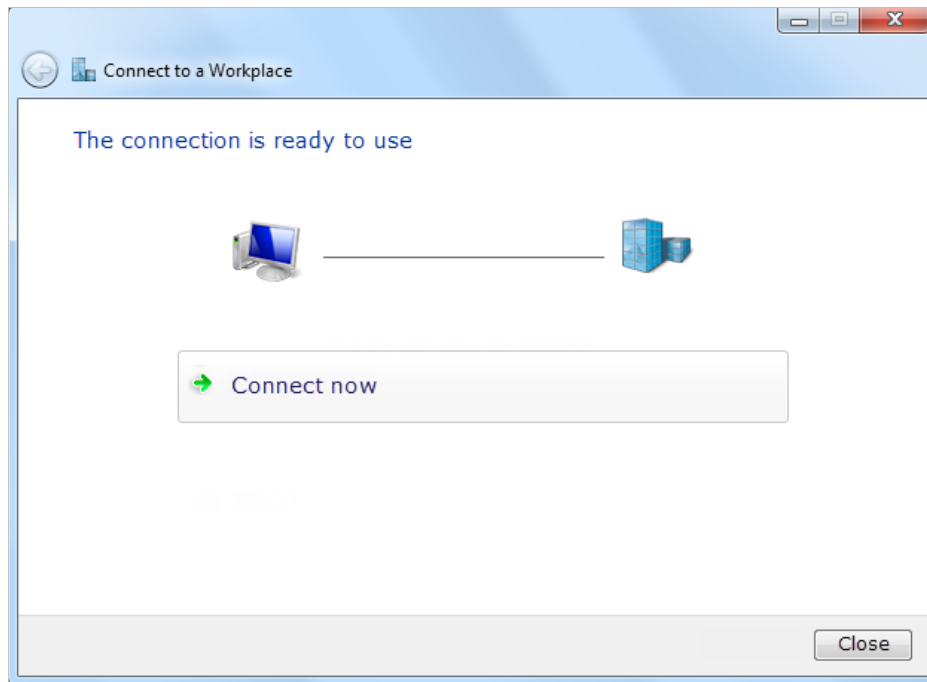

14.3. Use IPSec VPN to Access Your Home Network

IPSec VPN is used to create a VPN connection between local and remote networks. To use IPSec VPN, you should check that both local and remote routers support IPSec VPN feature. Then, follow the steps below to set up an IPSec VPN connection.

1. The typical VPN topology is here. Site A refers to local network, and Site B refers to the remote network that is to be connected. Record Site A and Site B's LAN and WAN IP addresses before you start configuration.

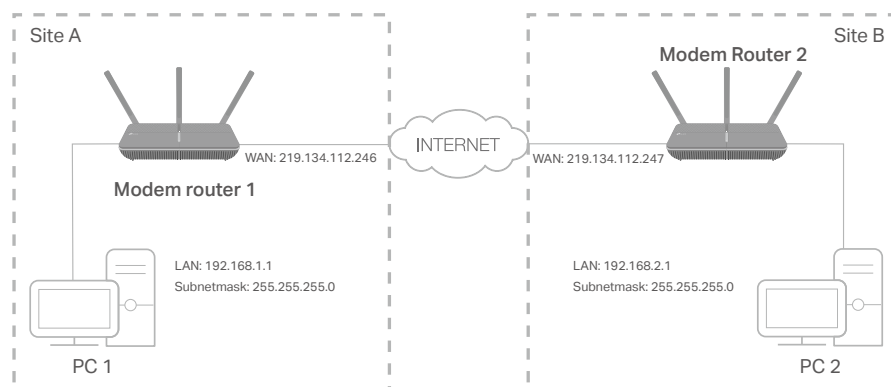

2. Configuration on Site A (local network).

- 1) Visit <http://tplinkmodem.net>, and log in with your TP-Link ID or the password you set for the router.
- 2) Go to **Advanced > VPN > IPSec VPN**, and click **Add**.

IPSec VPN

Dead Peer Detection:

+ Add - Delete

<input type="checkbox"/>	Connection Name	Remote Gateway	Local Address	Remote Address	Status	Enable	Modify
--	--	--	--	--	--	--	--

IPSec Connection Name:

Remote IPSec Gateway (URL): Site B's WAN IP

Tunnel access from local IP addresses:

IP Address for VPN: LAN IP range of Site A

Subnet Mask:

Tunnel access from remote IP addresses:

IP Address for VPN: LAN IP range of Site B

Subnet Mask:

Key Exchange Method:

Authentication Method:

Pre-Shared Key:

Perfect Forward Secrecy:

Advanced

- 3) In the **IPSec Connection Name** column, specify a name.
- 4) In the **Remote IPSec Gateway (URL)** column, Enter Site B's WAN IP address.
- 5) Configure **Site A's LAN**.
In the **Tunnel access from local IP addresses** column, we take **Subnet Address** as an example. Input the LAN IP range of Site A in the **IP Address for VPN** column, and input **Subnet Mask** of Site A.
- 6) Configure **Site B's LAN**.
In the **Tunnel access from remote IP addresses** column, we take **Subnet Address** as an example. Input the LAN IP range of Site B in the **IP Address for VPN** column, and input **Subnet Mask** of Site B.
- 7) Select the **Key Exchange Method** for the policy. We select **Auto(IKE)** here.

- 8) Enter the **Pre-Shared Key** for IKE authentication. Then keep **Perfect Forward Secrecy** enabled.

Note: Make sure Site A and Site B use the same key.

- 9) Leave the **Advanced Settings** as default value. Then click **Save**.

<input type="checkbox"/>	Connection Name	Remote Gateway	Local Address	Remote Address	Status	Enable	Modify
<input type="checkbox"/>	VPN1	219.134.112.247	192.168.1.0	192.168.2.0	Down		

Note: The **Status** column is **Down** after the configuration, and it will change to **UP** only when Site A and Site B are communicating via the VPN connection.

- Configuration on Site B (remote network). Refer to step 2 configuration on Site A and make sure that Site A and Site B use the same **pre-shared keys** and **Perfect Forward Secrecy** settings.
- Check the VPN connection. You can ping site B' LAN IP from your computer in site A to verify that the IPsec VPN connection is set up correctly.

Tips: To check the VPN connection, you can do the following.

- On the host in Site A, press **[Windows Logo] + [R]** to open Run dialog. Input "cmd" and hit **OK**.

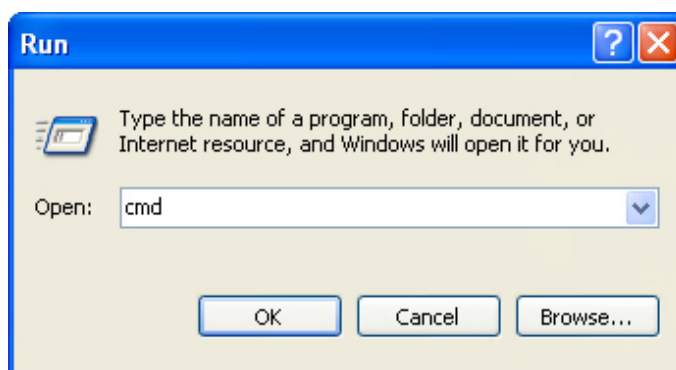

- In the CLI window, type in "ping 192.168.2.x" ("192.168.2.x" can be IP address of any host in Site B). Then press **[Enter]**.

```

C:\WINDOWS\system32\cmd.exe
Microsoft Windows XP [Version 5.1.2600]
(C) Copyright 1985-2001 Microsoft Corp.

C:\Users\Administrator>ping 192.168.2.100

Pinging 192.168.2.100 with 32 bytes of data:

Reply from 192.168.2.100: bytes=32 time<1ms TTL=128
Reply from 192.168.2.100: bytes=32 time<1ms TTL=128
Reply from 192.168.2.100: bytes=32 time<1ms TTL=128
Reply from 192.168.2.100: bytes=32 time<1ms TTL=128

Ping statistics for 192.168.2.100:
    Packets: Sent = 4, Received = 4, Lost = 0 (0% loss),
    Approximate round trip times in milli-seconds:
        Minimum = 0ms, Maximum = 0ms, Average = 0ms

C:\Users\Administrator>

```

- If Ping proceeds successfully (gets replies from host in Site B), the IPsec connection is working properly now.
- Now IPsec VPN is implemented to establish a connection.

Note:

1. The product supports a maximum of ten simultaneous connections.
2. If one of the site has been offline for a while, for example, if Site A has been disconnected, on Site B you need to click [Disable](#) and then click [Enable](#) after Site A back on line in order to re-establish the IPSec tunnel.

Chapter 15

Specify Your Network Settings

This chapter introduces how to change the default settings or adjust the basic configuration of the modem router using the web management page.

It contains the following sections:

- [LAN Settings](#)
- [IPv6 LAN Settings](#)
- [Wireless Settings](#)
- [Set Up a Dynamic DNS Service Account](#)
- [Create Static Routes](#)
- [Set Up the IPv6 Tunnel](#)

15.1. LAN Settings

15.1.1. Change the LAN IP Address

The modem router is preset with a default LAN IP 192.168.1.1, which you can use to log in to its web management page. The LAN IP address together with the Subnet Mask also defines the subnet that the connected devices are on. If the IP address conflicts with another device in your local network or your network requires a specific IP subnet, you can change it.

Follow the steps below to change your IP address.

1. Visit <http://tplinkmodem.net>, and log in with your TP-Link ID or the password you set for the router.
2. Go to [Advanced](#) > [Network](#) > [LAN Settings](#) page and select [IPv4](#).

Note:

If you have created an interface group, you can configure different IPv4 LAN settings for the default and created interface groups.

DHCP Server	
IP Version:	<input checked="" type="radio"/> IPv4 <input type="radio"/> IPv6
MAC Address:	00-0A-EB-13-09-69
IP Address:	192 . 168 . 1 . 60
Subnet Mask:	255.255.255.0
IGMP Snooping:	<input checked="" type="checkbox"/> Enable
Snooping Mode:	<input type="radio"/> Block <input checked="" type="radio"/> Allow
Second IP:	<input type="checkbox"/> Enable

3. Type in a new [IP Address](#) appropriate to your needs.
4. Select the [Subnet Mask](#) from the drop-down list. The subnet mask together with the IP address identifies the local IP subnet.
5. Keep [IGMP Snooping](#) enabled by default. IGMP snooping is the process of listening to IGMP (Internet Group Management Protocol) network traffic. The function prevents hosts on a local network from receiving traffic for a multicast group they have not explicitly joined.
6. You can configure the modem router's [Second IP](#) and [Subnet Mask](#) for LAN interface through which you can also access the web management page.
7. Leave the rest of the default settings as they are.
8. Click [Save](#) to make the settings effective.

15. 1. 2. Use the Modem Router as a DHCP Server

You can configure the modem router to act as a DHCP server to assign IP addresses to its clients. To use the DHCP server function of the modem router, you must configure all computers on the LAN to obtain an IP Address automatically.

Follow the steps below to configure DHCP server.

1. Visit <http://tplinkmodem.net>, and log in with your TP-Link ID or the password you set for the router.
2. Go to [Advanced](#) > [Network](#) > [LAN Settings](#) page and select [IPv4](#).

Note:

If you have created an interface group, you can configure different IPv4 LAN settings for the default and created interface groups.

DHCP: Enable

DHCP Server DHCP Relay

IP Address Pool: 192 . 168 . 1 . 100 - 192 . 168 . 1 . 199

Address Lease Time: 1440 minutes. (1-2880. The default value is 1440.)

Default Gateway: 192 . 168 . 1 . 1 (Optional)

Default Domain: (Optional)

Primary DNS: 192 . 168 . 1 . 1 (Optional)

Secondary DNS: (Optional)

Save

3. Select [DHCP](#) to enable the DHCP function and select [DHCP Server](#).
4. Specify the [IP Address Pool](#), the start address and end address must be on the same subnet with LAN IP. The modem router will assign addresses within this specified range to its clients. It is from 192.168.1.100 to 192.168.1.199 by default.
5. Enter a value for the [Address Lease Time](#). The [Address Lease Time](#) is the amount of time in which a DHCP client can lease its current dynamic IP address assigned by the modem router. After the dynamic IP address expires, the user will be automatically assigned a new dynamic IP address. The default is 1440 minutes.
6. Keep the rest of the settings as default and click [Save](#).

Note:

1. The modem router can be configured to work as a [DHCP Relay](#). A DHCP relay is a computer that forwards DHCP data between computers that request IP addresses and the DHCP server that assigns the addresses. Each of the device's interfaces can be configured as a DHCP relay. If it is enabled, the DHCP requests from local PCs will be forwarded to the DHCP server that runs on WAN side.
2. You can also appoint IP addresses within a specified range to devices of the same type by using [Condition Pool](#) feature. For example, you can assign IP addresses within the range (192.168.1.50 to 192.168.1.80) to Camera devices, thus facilitating the network management. Enable DHCP feature and configure the parameters according to your situation on the [Advanced](#) > [Network](#) > [LAN Settings](#) page.

15. 1. 3. Reserve LAN IP Addresses

You can view and add a reserved address for a client. When you specify an IP address for a device on the LAN, that device will always receive the same IP address each time when it accesses the DHCP server. If there are some devices in the LAN that require permanent IP addresses, please configure Address Reservation on the router for the purpose.

Follow the steps below to reserve an IP address for your device.

1. Visit <http://tplinkmodem.net>, and log in with your TP-Link ID or the password you set for the router.
2. Go to [Advanced](#) > [Network](#) > [LAN Settings](#) page and select [IPv4](#).
3. Scroll down to locate the [Address Reservation](#) table and click [Add](#) to add an address reservation entry for your device.

The screenshot shows the 'Address Reservation' configuration page. At the top right, there are '+ Add' and '- Delete' buttons. Below is a table with the following structure:

<input type="checkbox"/>	MAC Address	Reserved IP Address	Group	Status	Modify
--	--	--	--	--	--

Below the table, there are input fields for:

- MAC Address: [- - - - -] [Scan]
- IP Address: [- . - . -]
- Group: [Default]

There is a checkbox labeled 'Enable This Entry' which is checked. At the bottom right, there are 'Cancel' and 'Save' buttons.

4. Click [Scan](#) and select the device for which you want to reserve IP address. Then the [MAC Address](#) and [IP Address](#) fields will be automatically filled in.
5. Specify the IP address which will be reserved by the router.
6. Check to [Enable this entry](#) and click [Save](#) to make the settings effective.

15. 2. IPv6 LAN Settings

Based on the IPv6 protocol, the modem router provides two ways to assign IPv6 LAN addresses:

- Configure the RADVD (Router Advertisement Daemon) address type
- Configure the DHCPv6 Server address type

15.2.1. Configure the RADVD Address Type

1. Visit <http://tplinkmodem.net>, and log in with your TP-Link ID or the password you set for the router.
2. Go to [Advanced](#) > [Network](#) > [LAN Settings](#).
3. Select [IPv6](#) to configure IPv6 LAN parameters.

Note:

If you have created an interface group, you can configure IPv6 LAN settings for the default interface group only.

DHCP Server

IP Version: IPv4 IPv6

Group: Default

IPv6 Enable

Address Type: RADVD DHCPv6 Server

Enable RDNSS

Enable ULA Prefix

Site Prefix Type: Delegated Static

WAN Connection: No available interface

Save

- 1) Select the [RADVD](#) address type to make the modem router assign IPv6 address prefixes to hosts.

Note:

Do not select the [Enable RDNSS](#) and [Enable ULA Prefix](#) check boxes unless required by your ISP. Otherwise you may not be able to access the IPv6 network. For more information about RDNSS and ULA Prefix, contact our technical support.

- 2) Keep [Site Prefix Type](#) as the default value [Delegated](#). If your ISP has provided a specific IPv6 site prefix, select [Static](#) and enter the prefix.
 - 3) Keep [WAN Connection](#) as the default value.
4. Click [Save](#) to make the settings effective.

15.2.2. Configure the DHCPv6 Server Address Type

1. Visit <http://tplinkmodem.net>, and log in with your TP-Link ID or the password you set for the router.
2. Go to [Advanced](#) > [Network](#) > [LAN Settings](#).
3. Select [IPv6](#) to configure IPv6 LAN parameters.

Note:

If you have created an interface group, you can configure IPv6 LAN settings for the default interface group only.

The screenshot shows the DHCP Server configuration interface. The settings are as follows:

- IP Version:** IPv6 (selected)
- Group:** Default
- IPv6 Enable:** Checked
- Address Type:** DHCPv6 Server (selected)
- Starting IPv6 Address:** 1 (range 1~FFFE)
- Ending IPv6 Address:** FFFE (range 1~FFFE)
- Address Lease Time:** 86400 seconds
- Site Prefix Type:** Delegated (selected)
- WAN Connection:** No available interface

A **Save** button is located at the bottom right of the form.

- 1) Select the **DHCPv6 Server** address type to make the modem router assign IPv6 addresses to hosts.
 - 2) Specify the **Starting/Ending IPv6 Address** for the IPv6 suffixes. The modem router will generate IPv6 addresses within the specified range.
 - 3) Keep **Address Lease Time** as the default value.
 - 4) Keep **Site Prefix Type** as the default value **Delegated**. If your ISP has provided a specific IPv6 site prefix, select **Static** and enter the prefix.
 - 5) Keep **WAN Connection** as the default value.
4. Click **Save** to make the settings effective.

15.3. Wireless Settings

15.3.1. Specify Basic Wireless Settings

The modem router's wireless network name (SSID) and password, and security option are preset in the factory. The preset SSID and password can be found on the product label. You can customize the wireless settings according to your needs.

1. Visit <http://tplinkmodem.net>, and log in with your TP-Link ID or the password you set for the router.
2. Go to **Basic > Wireless** page.

The screenshot shows a web interface for configuring network settings. At the top, there is a 'Smart Connect' section with a toggle switch currently turned off. Below this is a description: 'Smart Connect allows your mobile device to automatically switch to the Wi-Fi band that provides the fastest speed.' The main section is titled 'Wireless Settings' and contains two identical blocks for 2.4GHz and 5GHz wireless networks. Each block has a checked 'Enable' checkbox, a 'Network Name (SSID)' text box containing 'TP-Link_0298', a 'Hide SSID' checkbox which is unchecked, and a 'Password' text box containing '12345670'. A blue 'Save' button is located at the bottom right of the form.

- **To enable or disable the wireless function:**

Enable the 2.4 GHz or 5GHz Wireless Network. If you don't want to use the wireless function, just deselect the box. If you disable the wireless function, all the wireless settings won't be effective.

- **To change the wireless network name (SSID) and wireless password:**

Enter a new SSID using up to 32 characters. The value is case-sensitive.

Note:

If you use a wireless device to change the wireless settings, you will be disconnected after the new settings are effective. Please write down the new SSID and password for future use.

- **To hide SSID:**

Select Hide SSID, and your SSID will not be broadcast. Your SSID won't display on your wireless device when you scan for local wireless network list and you need to manually join the network.

- **To use the Smart Connect function:**

The smart connect function lets you to enjoy a more high-speed network by assigning your devices to best wireless bands based on actual conditions to balance network demands.

1. Go to [Advanced](#) > [Wireless](#) > [Wireless Settings](#).
2. Enable [Smart Connect](#).
3. Keep the default or set a new SSID and password, and click [Save](#). This SSID and password will be applied both for 2.4GHz and 5GHz wireless networks.

Smart Connect

Smart Connect

Smart Connect allows your mobile device to automatically switch to the Wi-Fi band that provides the fastest speed.

Wireless Settings

Wireless Network Enable

Network Name (SSID): Hide SSID

Security:

Version: Auto WPA-PSK WPA2-PSK

Encryption: Auto TKIP AES

Password:

Mode:

Channel Width:

Channel:

Transmit Power: Low Middle High

Save

- **To change the mode or channel:**

Go to [Advanced](#) > [Wireless](#) > [Wireless Settings](#) page and select the wireless network 2.4GHz or 5GHz.

Mode: Select the desired mode.

- 802.11n only: Select only if all of your wireless clients are 802.11n devices.
- 802.11gn mixed: Select if you are using both 802.11g and 802.11n wireless clients.
- 802.11bgn mixed: Select if you are using a mix of 802.11b, 11g, and 11n wireless clients.

Note: When 802.11n only mode is selected, only 802.11n wireless stations can connect to the modem router. It is strongly recommended that you select 802.11bgn mixed, and all of 802.11b, 802.11g, and 802.11n wireless stations can connect to the modem router.

- 802.11ac/n mixed (5GHz): Select if you are using both 802.11ac and 802.11n wireless clients.
- 802.11a/n/ac mixed (5GHz): Select if you are using a mix of 802.11a, 802.11n and 802.11ac wireless clients. It is strongly recommended that you select 11a/n/ac mixed.

Channel: Select the channel you want to use from the drop-down list. This field determines which operating frequency will be used. It is not necessary to change the wireless channel unless you notice interference problems with another nearby access point.

Channel Width: Select the channel width from the drop-down list. The default setting is **Auto**, which can adjust the channel width for your clients automatically.

Transmit Power: Select Low, Middle, or High to specify the data transmit power. The default and recommended setting is High.

- **To change the security option:**

1. Go to **Advanced > Wireless > Wireless Settings** page.
2. Select the wireless network **2.4GHz** or **5GHz**.
3. Select an option from the **Security** drop-down list. The router provides four options, None, WPA/WPA2 Personal (Recommended), WPA/WPA2 Enterprise, WEP. WPA2 uses the newest standard and the security level is the highest. We recommend you don't change the default settings unless necessary.

15.3.2. Use WPS for Wireless Connection

You can use WPS (Wi-Fi Protected Setup) to add a new wireless device to your existing network quickly and easily.

Method 1: Use the WPS button

Use this method if your client device has a WPS button.

1. Press the WPS button the modem router for 1 second.
2. Press the WPS button of the client device directly.
3. The WPS LED flashes for about 2 minutes during the WPS process.
4. When the WPS LED is on, the client device has successfully connected to the modem router.

Method 2: Use the WPS button on the web management page

Use this method if your client device has a WPS button.

1. Visit <http://tplinkmodem.net>, and log in with your TP-Link ID or the password you set for the router.
2. Go to **Advanced > Wireless > WPS** page.

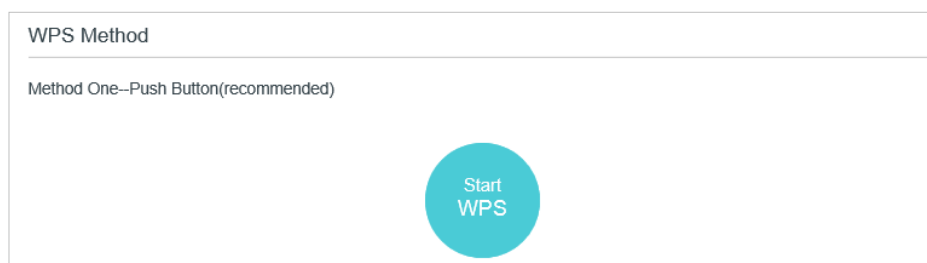

3. Click **Start WPS** on the page.

4. Press the WPS button of the client device directly.
5. The WPS LED of the router flashes for about 2 minutes during the WPS process.
6. When the WPS LED is on, the client device has successfully connected to the modem router.

Method 3: Enter the modem router's PIN on your client device

Use this method if your client device asks for the modem router's PIN.

1. Visit <http://tplinkmodem.net>, and log in with your TP-Link ID or the password you set for the router.
2. Go to [Advanced](#) > [Wireless](#) > [WPS](#) page. Click [Method Two--PIN](#).



Method Two--PIN

Router's PIN Client's PIN

Router's PIN

Router's PIN:

3. Take a note of the Current PIN of the modem router. You can also click the [Generate](#) button to get a new PIN.
4. On the client device, enter the modem router's PIN. (The default PIN is also printed on the label of the modem router.)
5. The WPS LED flashes for about two minutes during the WPS process.
6. When the WPS LED is on, the client device has successfully connected to the modem router.

Note:

1. The WPS LED on the modem router will light on for five minutes if the device has been successfully added to the network.
2. The WPS function cannot be configured if the wireless function of the modem router is disabled. Please make sure the wireless function is enabled before configuring WPS.

Method 4: Enter the client device's PIN on the modem router

1. Visit <http://tplinkmodem.net>, and log in with your TP-Link ID or the password you set for the router.
2. Go to [Advanced](#) > [Wireless](#) > [WPS](#) page. Click [Method Two--PIN](#).

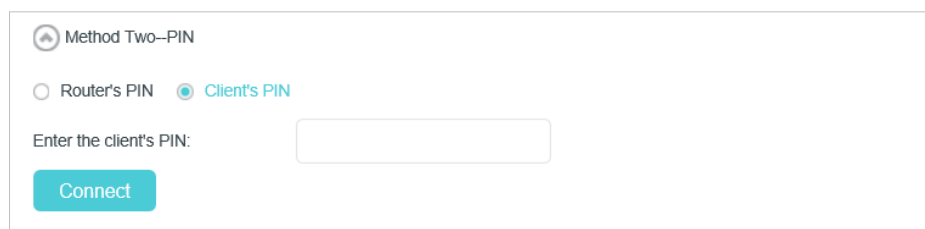

Method Two--PIN

Router's PIN Client's PIN

Enter the client's PIN:

3. Select **Client's PIN**.
4. Enter the client device's PIN in the field. Then click the **Connect** button.
5. **Device has been added successfully!** will appear on the above screen, which means the client device has successfully connected to the modem router.

15.3.3. Schedule Your Wireless Function

You can automatically turn off your wireless network (both 2.4GHz and 5GHz) when you do not need the wireless connection.

1. Visit <http://tplinkmodem.net>, and log in with your TP-Link ID or the password you set for the router.
2. Go to **Advanced > Wireless > Wireless Schedule** page.
3. Toggle on the button to enable the Wireless Schedule feature.

Wireless Schedule

Wireless Schedule:

Wireless Off Time

	ID	Wireless Off Time	Repeat	Modify
<input type="checkbox"/>	--	--	--	--

+ Add
− Delete

From:

To:

Repeat: Every Day Selected Day

Selected Day: Sun Mon Tue Wed Thu Fri Sat

Cancel
Save

4. Click **Add** to set the **Wireless Off Time**, and click **Save** to save the settings.
5. Repeat steps 3 and 4 to set another entry.

Note:

1. Make sure that the time of the router is correct before using this function. For details, refer to [Set System Time](#).
2. If you just set time for one wireless band, the other wireless band is still always on, so set time for both of the two bands to schedule your whole wireless network.
3. The wireless LED (2.4GHz, 5GHz) will turn off if the corresponding wireless network is disabled.
4. The wireless network will be automatically turned on after the time period you set.

15.3.4. View Wireless Information

- **To view the detailed wireless network settings:**
 1. Visit <http://tplinkmodem.net>, and log in with your TP-Link ID or the password you set for the router.
 2. Go to [Advanced](#) > [Status](#) page. You can see the [Wireless](#) box.
 3. Select [2.4GHz](#) or [5GHz](#) to view the wireless details.

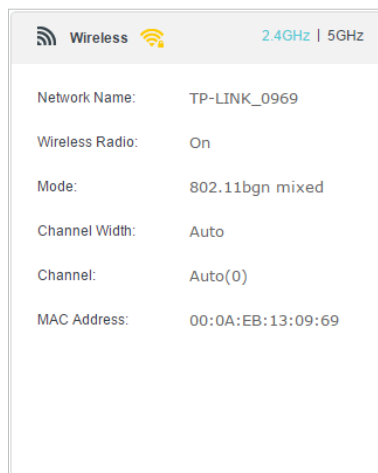

🔗 Tips: You can also see the wireless details by clicking the router icon on [Basic](#) > [Network Map](#).

- **To view the detailed information of the connected wireless clients:**
 1. Visit <http://tplinkmodem.net>, and log in with your TP-Link ID or the password you set for the router.
 2. Go to [Advanced](#) > [Wireless](#) > [Statistics](#) page.
 3. You can view the detailed information of the wireless clients, including its connected wireless band and security option as well as the packets transmitted.

🔗 Tips: You can also see the wireless details by clicking the wireless clients icon on [Basic](#) > [Network Map](#).

15.3.5. Advanced Wireless Settings

Advanced wireless settings are for those who have a network concept. If you are not familiar with the settings on this page, it's strongly recommended that you keep the provided default values; otherwise it may result in lower wireless network performance.

1. Visit <http://tplinkmodem.net>, and log in with your TP-Link ID or the password you set for the router.
2. Go to [Advanced](#) > [Wireless](#) > [Advanced Settings](#) page.

The screenshot shows the 'Advanced Settings' interface for a wireless network. At the top right, there are tabs for '2.4GHz' and '5GHz'. The settings are as follows:

Setting	Value	Range
Beacon Interval:	100	(25-1000)
RTS Threshold:	2346	(1-2346)
DTIM Interval:	1	(1-255)
Group Key Update Period:	0	seconds

Below these fields are three checkboxes:

- WMM: Enable
- Short GI: Enable
- AP Isolation: Enable

A 'Save' button is located at the bottom right of the settings panel.

- **Beacon Interval:** Enter a value between 25 and 1000 in milliseconds to determine the duration between which beacon packets are broadcasted by the router to synchronize the wireless network. The default is 100 milliseconds.
- **RTS Threshold:** Enter a value between 1 and 2346 to determine the packet size of data transmission through the router. By default, the RTS (Request to Send) Threshold size is 2346. If the packet size is greater than the preset threshold, the router sends Request to Send frames to a particular receiving station and negotiates the sending of a data frame, or else the packet will be sent immediately.
- **DTIM Interval:** Enter a value between 1 and 255 to determine the interval of the Delivery Traffic Indication Message (DTIM). 1 indicates the DTIM Interval is the same as **Beacon Interval**.
- **Group Key Update Period:** Enter the number of seconds to control the time interval for the encryption key automatic renewal. The default is 0, indicating no key renewal.
- **WMM:** This feature guarantees the packets with high-priority messages being transmitted preferentially. WMM is enabled compulsively under 802.11n or 802.11ac mode.
- **Short GI:** This feature is enabled by default and recommended to increase the data capacity by reducing the Guard Interval (GI) time.
- **AP Isolation:** Select this check box to enable the AP Isolation feature that allows you to confine and restrict all wireless devices on your network from interacting with each other, but still able to access the internet. AP isolation is disabled by default.

15.4. Set Up a Dynamic DNS Service Account

Most ISPs (Internet service providers) assign a dynamic IP address to the router and you can use this IP address to access your router remotely. However, the IP address can change any time and you don't know when it changes. In this case, you might need

the DDNS (Dynamic Domain Name Server) feature on the router to allow you and your friends to access your router and local servers (FTP, HTTP, etc.) using domain name, in no need of checking and remembering the IP address.

Note: DDNS does not work if the ISP assigns a private WAN IP address (such as 192.168.1.x) to the modem router.

To set up DDNS, please follow the instructions below:

1. Visit <http://tplinkmodem.net>, and log in with your TP-Link ID or the password you set for the router.
2. Go to [Advanced](#) > [Network](#) > [Dynamic DNS](#).
3. Select the [DDNS service provider](#) (TP-Link, DynDNS or NO-IP).
4. To use TP-Link DDNS service, you should log in with your TP-Link ID.
5. If you choose other DDNS service, you should also log in with your DDNS account, select a service provider and click [Go to register ...](#) Enter the username, password and domain name of the account (such as lisa.ddns.net).

Dynamic DNS Settings

Service Provider: TP-Link DynDNS NO-IP [Go to register...](#)

Username:

Password:

Domain Name:

[Log in](#) [Log out](#) Disconnected

[Save](#)

6. Click [Log in](#) and [Save](#).

Tips: If you want to use a new DDNS account, please Logout first, then login with the new account.

15.5. Create Static Routes

A static route is a pre-determined path that network information must travel to reach a specific host or network. Data from one point to another will always follow the same path regardless of other considerations. Normal internet usage does not require this setting to be configured.

I want to:

Visit multiple networks and multiple servers at the same time.

For example, in a small office, my PC can surf the internet, but I also want to visit my company's server. Now I have a switch and another router. I connect the devices as

shown in the following figure so that the physical connection between my PC and my company's server is achieved. To surf the internet and visit my company's network at the same time, I need to configure the static routing.

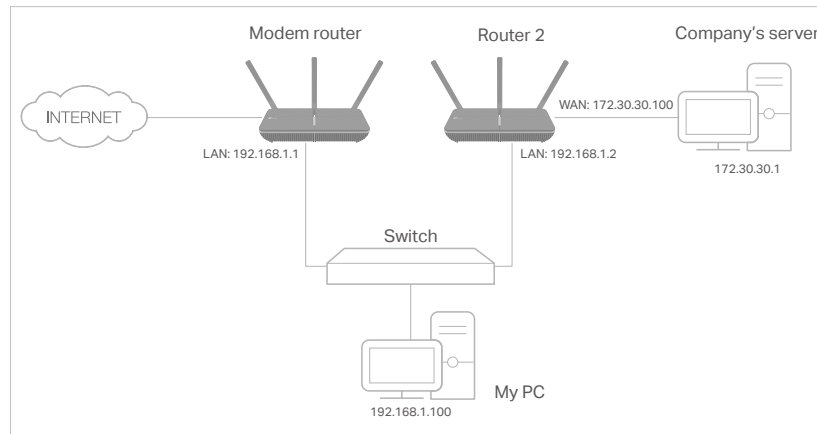

How can I do that?

1. Make sure the routers use different LAN IP addresses on the same subnet. Disable Router 2's DHCP function.
2. Visit <http://tplinkmodem.net>, and log in with your TP-Link ID or the password you set for the router.
3. Go to **Advanced > Network > Static Routing**. Select your current **WAN Interface** and click **Save**.

Default Gateway Settings IPv4 | IPv6

Select a WAN interface as the system default gateway.

Select WAN Interface: Save

Static Routing + Add - Delete

<input type="checkbox"/>	ID	Network Destination	Subnet Mask	Gateway	Status	Modify
–	–	–	–	–	–	–

4. Click **Add** to add a new static routing entry. Finish the settings according to the following explanations:

Static Routing

+ Add - Delete

<input type="checkbox"/>	ID	Network Destination	Subnet Mask	Gateway	Status	Modify
--	--	--	--	--	--	--

Network Destination: 172 . 30 . 30 . 1

Subnet Mask: 255 . 255 . 255 . 255

Gateway: 192 . 168 . 1 . 2

Interface: LAN

Enable This Entry

Cancel Save

- **Network Destination:** The destination IP address that you want to assign to a static route. This IP address cannot be on the same subnet with the WAN IP or LAN IP of the router. In the example, the IP address of the company network is the destination IP address, so here enters 172.30.30.1.
 - **Subnet Mask:** Determines the destination network with the destination IP address. If the destination is a single IP address, enter 255.255.255.255; otherwise, enter the subnet mask of the corresponding network IP. In the example, the destination network is a single IP, so here enters 255.255.255.255.
 - **Gateway:** The IP address of the gateway device to which the data packets will be sent. This IP address must be on the same subnet with the router's IP which sends out the data. In the example, the data packets will be sent to the LAN port of Router 2 and then to the Server, so the default gateway should be 192.168.1.2.
 - **Interface:** Determined by the port (WAN/LAN) that sends out the data packets. In the example, the data is sent to the gateway through the LAN port, so LAN should be selected.
5. Select the check box to enable this entry.
 6. Click [Save](#) to save the settings.

Done!

Open a web browser on your PC. Enter the company server's IP address to visit the company network.

15.6. Set Up the IPv6 Tunnel

The IPv6 Tunnel feature helps you obtain IPv6 resources based on an IPv4 WAN connection or vice versa.

IPv6 Tunnel is a transition mechanism that allows isolated IPv6 hosts and networks to reach each other over IPv4-only infrastructure before IPv6 completely supplants IPv4. It is a temporary solution for networks that do not support native dual-stack, where both IPv6 and IPv4 run independently.

The modem router provides three tunneling mechanisms: [6to4](#), [6rd](#) and [DS-Lite](#). The way to set up 6rd and DS-Lite tunnel are similar.

15. 6. 1. Use the Public IPv6 Tunnel Service-6to4

The 6to4 tunnel is a kind of public service. If there are any 6to4 servers on your network, you can use this mechanism to access IPv6 service. If your ISP provides you with an IPv4-only connection but you want to visit IPv6 websites, you can try to set up a 6to4 tunnel.

I want to:

Set up the IPv6 tunnel though my ISP doesn't provide me with the tunnel service.

How can I do that?

1. Visit <http://tplinkmodem.net>, and log in with your TP-Link ID or the password you set for the router.
2. Go to [Advanced](#) > [Network](#) > [IPv6 Tunnel](#).
3. Tick the check box, select [6to4](#) as the tunneling mechanism and select a WAN connection from the drop-down list, then click [Save](#).

IPv6 Tunnel

Note: You must reconfigure the IPv6 Tunnel settings every time you reboot the router. Make sure the desired WAN connection is connected before the configuration.

IPv6 Tunnel: Enable

Tunneling Mechanism:

WAN Connection:

Save

Note:

If there is no available WAN connection to choose, make sure you have connected to the internet and the connection type is not Bridge.

Done!

Now you can visit the IPv6 websites with the 6to4 tunnel.

Note:

Still not being able to access IPv6 resources means that not any 6to4 public server was found in your network. You can contact your ISP to sign up for IPv6 connection service.

15. 6. 2. Specify the 6rd Tunnel with Parameters Provided by Your ISP

I want to:

Specify the 6rd tunnel with the parameters provided by my 6rd tunnel service provider.

How can I do that?

1. Visit <http://tplinkmodem.net>, and log in with your TP-Link ID or the password you set for the router.
2. Go to [Advanced](#) > [Network](#) > [IPv6 Tunnel](#).
3. Tick the check box, select [6rd](#) as the tunneling mechanism and select a WAN connection from the drop-down list.
4. According to the parameters provided by your ISP, choose [Auto](#) or [Manual](#). More parameters are needed if you choose [Manual](#).
5. Click [Save](#).

IPv6 Tunnel

Note: You must reconfigure the IPv6 Tunnel settings every time you reboot the router. Make sure the desired WAN connection is connected before the configuration.

IPv6 Tunnel: Enable

Tunneling Mechanism:

WAN Connection:

Configuration Type: Auto Manual

IPv4 Mask Length:

6rd Prefix:

6rd Prefix Length:

Border Relay IPv4 Address:

[Save](#)

Note:

If there is no available WAN connection to choose, make sure you have connected to the internet and the connection type is not Bridge.

Done!

Now you can visit the IPv6 websites with the 6rd tunnel.

Tips:

The way to set up DS-Lite tunnel is similar to that of 6rd tunnel. If you are provided with an IPv6-only WAN connection and have signed up for DS-Lite tunnel service, specify the DS-Lite tunnel by referring to the steps above.

Chapter 16

Administrate Your Network

This chapter introduces how to change the system settings and administrate your modem router's network.

This chapter contains the following sections:

- [Set System Time](#)
- [Control LEDs](#)
- [Update the Firmware](#)
- [Back up and Restore Configuration Settings](#)
- [Reboot the Modem Router](#)
- [Change the Administrator Account](#)
- [Local Management](#)
- [Remote Management](#)
- [System Log](#)
- [Monitor the Internet Traffic Statistics](#)
- [CWMP Settings](#)
- [SNMP Settings](#)

16.1. Set System Time

System time is the time displayed while the modem router is running. The system time you configure here will be used for other time-based functions like Parental Controls and Wireless Schedule. You can manually set how to get the system time.

Follow the steps below to set your system time.

1. Visit <http://tplinkmodem.net>, and log in with your TP-Link ID or the password you set for the modem router.
2. Go to [Advanced](#) > [System Tools](#) > [Time Settings](#) page.

The screenshot shows the 'System Time' configuration page. At the top, it displays 'Current Time: 01/01/2016 03:50:44'. Below this, there is a 'Time Zone' dropdown menu set to '(GMT) Greenwich Mean Time: Dublin, Edinburgh, London, Lisbon'. The 'Date' field is set to '1/1/2016' with '(MM/DD/YY)' as a placeholder. The 'Time' field is set to '3 : 50 : 42'. There are two 'NTP Server' fields, both set to '0.0.0.0' and labeled '(Optional)'. At the bottom, there are three buttons: 'Get from PC', 'Get from the Internet', and 'Save'.

3. Configure the system time using the following methods:
 - Manually:** Select your time zone and enter your local time.
 - Get from PC:** Click this button if you want to use the current managing PC's time.
 - Get from the Internet:** Click this button if you want to get time from the internet. Make sure your modem router can access the internet before you select this way to get system time.
4. Click [Save](#).
5. After setting the system time, you can set [Daylight Saving Time](#) according to your needs. Tick the check box to enable [Daylight Saving Time](#), set the start and end time and then click [Save](#) to make the settings effective.

Daylight Saving Time

Daylight Saving Time: Enable Daylight Saving Time

Start: 1970 Mar M Last W Sun T 02:00

End: 1970 Oct M Last W Sun T 03:00

[Save](#)

16.2. Control LEDs

The router's LEDs indicate router's activities and status. You can turn on or turn off the LEDs either from the web management page or by pressing the LED button.

1. Visit <http://tplinkmodem.net>, and log in with your TP-Link ID or the password you set for the router.
2. Go to [Advanced](#) > [System Tools](#) > [LED Control](#).

- **To turn on/off LEDs**

Toggle on or off the LED Status to turn on or off the LEDs.

- **To set up Night Mode**

1. Enable [Night Mode](#).
2. Specify a time period in the [Night Mode Period](#) as needed.

LED Control

LED Status:

LED MODE

Note: Before enabling night mode, make sure [System Time](#) is correct.

Current Time: 01/01/2016 01:07:47

Night Mode: Enable

LED Off Time: From 21:00 to 09:00

[Save](#)

3. Click [Save](#), and then the LEDs will be off during this period.

16.3. Update the Firmware

TP-Link is dedicated to improving product features, giving you a better network experience.

We will inform you through the web management page if there's any update firmware available for your router. The latest firmware can also be downloaded from the [Support](#) page of our website www.tp-link.com for free.

Note:

1. Make sure that you have a stable connection between the router and your computer. It is NOT recommended to upgrade the firmware wirelessly.
2. Make sure you remove any USB storage device connected to the router before the firmware upgrade to prevent data loss.
3. Back up your router configuration before upgrading the firmware.
4. Do NOT turn off the router during the firmware upgrade.

16.3.1. Online Upgrade

1. Visit <http://tplinkmodem.net>, and log in with your TP-Link ID or the password you set for the router.

2. If there's any firmware update available for your router, the update icon  will display on the top-right corner of the page. Click the icon to go to the [Firmware Upgrade](#) page.

Alternatively, you can go to [Advanced](#) > [System Tools](#) > [Firmware Upgrade](#), and click [Check for Upgrades](#) to see if there's any new firmware.

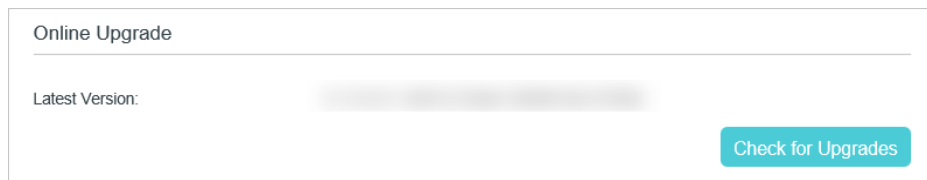

Tips:

If there's any new important firmware update for your router, you will see the notification (similar as shown below) on your computer when open a new web page. Click [Upgrade now](#), and log into the web management page. You will see the [Firmware Upgrade](#) page.

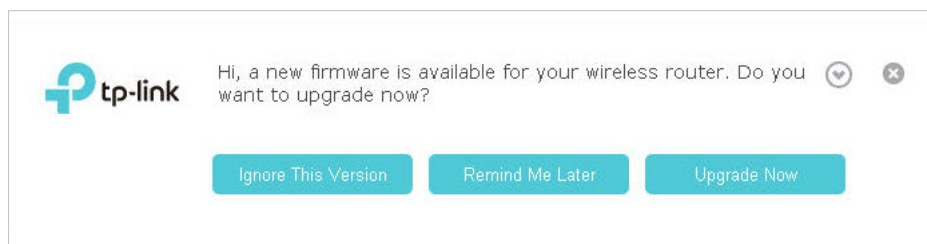

3. Wait a few moments for the upgrading and rebooting.

16.3.2. Local Upgrade

1. Download the latest firmware file for the router from our website www.tp-link.com.
2. Visit <http://tplinkmodem.net>, and log in with your TP-Link ID or the password you set for the router.
3. Go to [Advanced](#) > [System Tools](#) > [Firmware Upgrade](#).
4. Focus on the [Device Information](#) section. Make sure the downloaded firmware file matches with the [Hardware Version](#).
5. Focus on the [Local Upgrade](#) section. Click [Browse](#) to locate the downloaded new firmware file, and click [Upgrade](#).



The screenshot shows a web interface for a 'Local Upgrade'. At the top, there is a header 'Local Upgrade'. Below it, there is a label 'New Firmware File:' followed by an empty text input field. To the right of the input field is a teal button labeled 'Browse'. Further to the right is another teal button labeled 'Upgrade'.

6. Wait a few moments for the upgrading and rebooting.

16.4. Back up and Restore Configuration Settings

The configuration settings are stored as a configuration file in the router. You can back up the configuration file to your computer for future use and restore the modem router to a previous settings from the backup file when needed. Moreover, if needed you can erase the current settings and reset the modem router to the default factory settings.

- **To back up configuration settings**

1. Visit <http://tplinkmodem.net>, and log in with your TP-Link ID or the password you set for the router.
2. Click [Advanced](#) > [System Tools](#) > [Backup & Restore](#) page.
3. Click [Backup](#) to save a copy of the current settings to your local computer. A conf. bin file will be stored to your computer.

- **To restore configuration settings**

1. Visit <http://tplinkmodem.net>, and log in with your TP-Link ID or the password you set for the router.
2. Click [Advanced](#) > [System Tools](#) > [Backup & Restore](#) page.

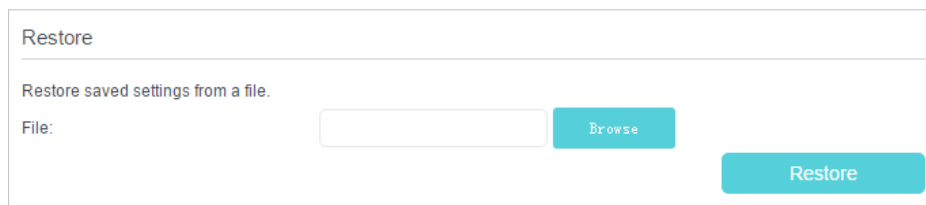

Restore

Restore saved settings from a file.

File: [Browse](#) [Restore](#)

3. Click [Browse](#) to locate the previous backup configuration file, and click [Restore](#).
 4. Wait for the restoring and then the modem router will automatically reboot.
- **To reset the modem router to factory default settings**
 1. Visit <http://tplinkmodem.net>, and log in with your TP-Link ID or the password you set for the router.
 2. Click [Advanced](#) > [System Tools](#) > [Backup & Restore](#) page.
 3. Click [Restore](#) to restore all configuration settings to default values, except your login and TP-Link ID information. Click [Factory Restore](#) to reset the modem router.
 4. Wait for the reset process to complete, and then the modem router will automatically reboot.

Note:

1. During the resetting process, do not turn off the modem router.
2. We strongly recommend you back up the current configuration settings before resetting the modem router.

16.5. Reboot the Modem Router

The Reboot feature cleans the cache to enhance the running performance of the router.

1. Visit <http://tplinkmodem.net>, and log in with your TP-Link ID or the password you set for the router.
2. Go to [Advanced](#) > [System Tools](#) > [Reboot](#).

- **To Reboot Manually**

Locate the [Manual Reboot](#) section and click [Reboot](#).

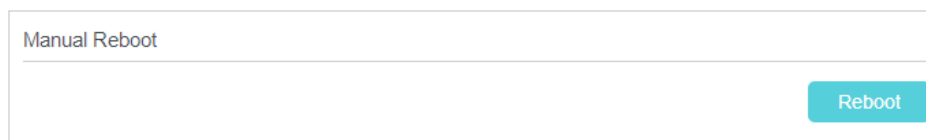

Manual Reboot

[Reboot](#)

- **To Reboot Automatically**

1. Locate the [Reboot Schedule](#) section and check the box to enable [Reboot Schedule](#).

Reboot Schedule

Note: Before enabling Reboot Schedule, please make sure your router is connected to the internet. Then go to [Time Settings](#) and choose **Get from the Internet** to get the correct network time.

Current Time: 01/01/2016 10:10:47

Reboot Schedule: Enable

Reboot Time: 03:00

Repeat: Every Week Mon

Save

2. Specify the **Reboot Time** when the router reboots and **Repeat** to decide how often it reboots.

Note:

Before enabling Reboot Schedule, please make sure your router is connected to the internet, then go to [Advanced > System Tools > Time Settings](#) and choose **Get from the Internet** to get the correct network time.

3. Click **Save**.

16.6. Change the Administrator Account

Admin account is used to log in to the modem router's web management page. You are required to set the admin account at first login. You can also change it on the web page.

1. Visit <http://tplinkmodem.net>, and log in with your TP-Link ID or the password you set for the router.
2. Go to [Advanced > System Tools > Administration](#) page. Locate the **Account Management** section.

Account Management

Old Password:

New Password:

Low Middle High

Confirm New Password:

Save

3. Enter the old password. Enter the new password and enter again to confirm.
4. Click **Save** to make the settings effective.

16.7. Local Management

You can control the local devices' authority to manage the modem router via Local Management feature. By default all local connected devices are allowed to manage the modem router. You can also specify one device to manage the modem router and enable local management over a more secure way, HTTPS.

Follow the steps below to allow only the specific device to manage the router via the local management over HTTPS.

1. Visit <http://tplinkmodem.net>, and log in with your TP-Link ID or the password you set for the router.
2. Go to [Advanced](#) > [System Tools](#) > [Administration](#) page. Locate the [Local Management](#) section.
3. Keep the [Port](#) as the default setting. Enable [Management over HTTPS](#) and keep the [Port for HTTPS](#) as the default setting. Enter the [IP address](#) or [MAC address](#) of the local device to manage the modem router.



Local Management

Port for HTTP: 80

Local Management via HTTPS: Enable

Port for HTTPS: 443

IP/MAC Address: 192.168.1.100

Save

4. Click [Save](#).

Now, you can manage the modem router over both HTTP (<http://tplinkmodem.net>) and HTTPS (<https://tplinkmodem.net>).

Note:

If you want that all local devices can manage the modem router, just leave the [IP/MAC Address](#) field blank.

16.8. Remote Management

By default, the remote devices are not allowed to manage the modem router from the internet. You can enable remote management over HTTP and/or HTTPS if needed. HTTPS is a more secure way to access the router.

Note:

If your ISP assigns a private WAN IP address (such as 192.168.x.x or 10.x.x.x), you cannot use the remote management feature because private addresses are not routed on the internet.

Follow the steps below to allow remote devices to manage the modem router over HTTPS.

1. Visit <http://tplinkmodem.net>, and log in with your TP-Link ID or the password you set for the router.
2. Go to [Advanced](#) > [System Tools](#) > [Administration](#) page. Locate the [Remote Management](#) section.

3. Tick the check box to enable [Remote Management](#). Enable [Remote Management via HTTPS](#) to allow for HTTPS connection. Keep the [Port](#) as the default setting.
4. Set the client device allowed for remote management. Select [All](#) to allow all remote devices to manage the modem router. If you just want to allow a specific device to manage the modem router, select [Only the Following IP Address](#) and enter the IP address of the remote device.
5. Click [Save](#).

All devices or the specific device on the internet can log in to your router using the address displayed on the [Manage This Router via the Address](#) field to manage the modem router.

Tips:

1. If you were warned about the certificate when visiting the web management page remotely, click [Trust](#) (or a similar option) to continue. To avoid this warning, you can download and install the certificate on the modem router's web management page at [Advanced](#) > [System Tools](#) > [Administration](#).

2. The router's WAN IP is usually a dynamic IP. Please refer to [Set Up a Dynamic DNS Service Account](#) if you want to log in to the router through a domain name.

16.9. System Log

System Log can help you know what happened to your modem router, facilitating you to locate the malfunctions. For example when your modem router does not work properly, you will need to save the system log and send it to the technical support for troubleshooting.

1. Visit <http://tplinkmodem.net>, and log in with your TP-Link ID or the password you set for the router.
2. Click [Advanced](#) > [System Tools](#) > [System Log](#) page.

System Log

Type:

Level:

[Refresh](#) [Delete All](#)

ID	Time	Type	Level	Log Content
1	1970-01-01 04:55:15	HTTPD	Notice	Clear log.

[Log Settings](#) [Save Log](#)

- **To view the system logs:**

You can view specific system logs by selecting the log Type and Level.

Click [Refresh](#) to refresh the log list.

- **To save the system logs:**

You can choose to save the system logs to your local computer or a remote server.

Click [Save Log](#) to save the logs in a txt file to your computer.

Click [Log Settings](#) to set the storage path of logs.

Log Settings

Save Locally

Minimum Level: Information

Save Remotely

Minimum Level: Warning

Server IP: 192.168.1.100

Server Port: 514

Local Facility Name: User

Back Save

- **Save Locally:** Select this option to cache the system log to the router's local memory, select the minimum level of system log to be saved from the drop-down list. The logs will be shown in the table in descending order on the System Log page.
- **Save Remotely:** Select this option to send the system log to a remote server, select the minimum level of system log to be saved from the drop-down list and enter the information of the remote server. If the remote server has a log viewer client or a sniffer tool implemented, you can view and analyze the system log remotely in real-time.

16. 10. Monitor the Internet Traffic Statistics

The Traffic Statistics page displays the network traffic of the interfaces, including the received and sent packets.

1. Visit <http://tplinkmodem.net>, and log in with your TP-Link ID or the password you set for the router.
2. Go to [Advanced](#) > [System Tools](#) > [Traffic Monitor](#).
3. Toggle on [Traffic Monitor](#), select the desired interface from the dropdown list, and then you can see the packets received and sent via this interface in the past ten minutes. This function is disabled by default.

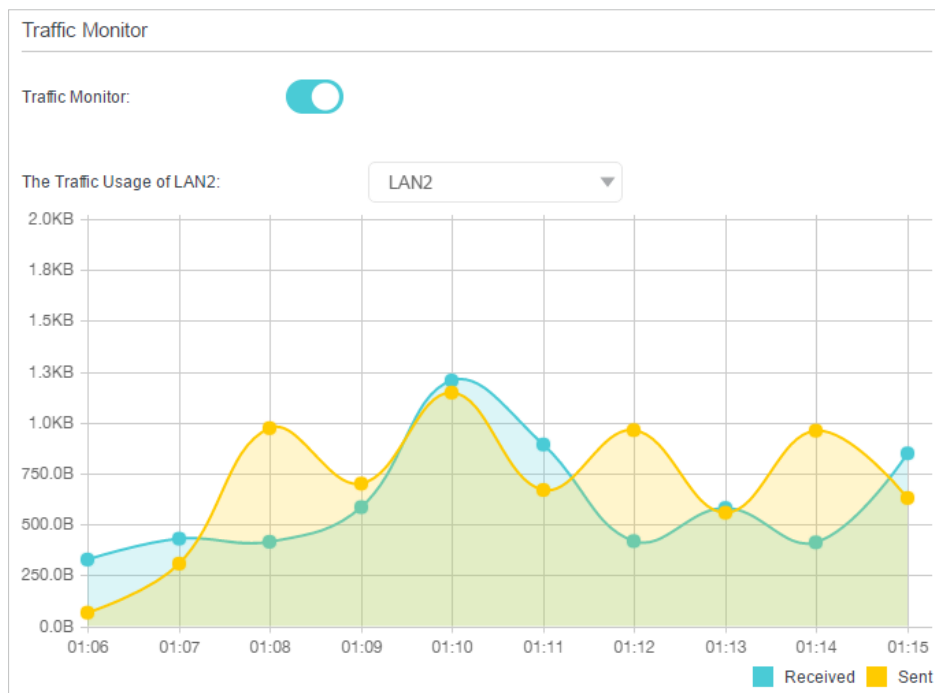

4. You can also go to [Traffic Monitor List](#) to view the traffic usage of all interfaces.

Traffic Monitor List

[Refresh](#) [Reset](#)

Interface Name	Bytes	Pkts	Errs	Drops
LAN1	0Bytes Rx 0Bytes Tx	0Pkts Rx 0Pkts Tx	0Pkts Rx 0Pkts Tx	0Pkts Rx 0Pkts Tx
LAN2	0Bytes Rx 0Bytes Tx	0Pkts Rx 0Pkts Tx	0Pkts Rx 0Pkts Tx	0Pkts Rx 0Pkts Tx
LAN3	4.730MBytes Rx 2.956MBytes Tx	17.873KPkts Rx 9.910KPkts Tx	0Pkts Rx 0Pkts Tx	0Pkts Rx 0Pkts Tx
LAN4	0Bytes Rx 0Bytes Tx	0Pkts Rx 0Pkts Tx	0Pkts Rx 0Pkts Tx	0Pkts Rx 0Pkts Tx
5G	0Bytes Rx 4.502MBytes Tx	0Pkts Rx 17.105KPkts Tx	0Pkts Rx 0Pkts Tx	0Pkts Rx 0Pkts Tx
2.4G	0Bytes Rx 0Bytes Tx	0Pkts Rx 0Pkts Tx	0Pkts Rx 0Pkts Tx	0Pkts Rx 0Pkts Tx

16. 11. CWMP Settings

The modem router supports CWMP (CPE WAN Management Protocol), also called TR-069. This collects information, performs diagnostics and configures the devices automatically via ACS (Auto-Configuration Server).

1. Visit <http://tplinkmodem.net>, and log in with your TP-Link ID or the password you set for the router.
2. Go to [Advanced](#) > [System Tools](#) > [CWMP Settings](#) page.

The screenshot shows the 'CWMP Settings' configuration page. It features several sections of controls:

- CWMP:** A toggle switch that is currently turned off.
- Inform:** A toggle switch that is currently turned off.
- Inform Interval:** A text input field containing '300' with '(seconds)' to its right.
- ACS URL:** An empty text input field.
- ACS Username:** A text input field containing 'admin'.
- ACS Password:** A password input field with masked characters '....' and a visibility icon.
- Interface used by TR-069 client:** A dropdown menu showing 'Any WAN'.
- Display SOAP messages on serial console:** A toggle switch that is currently turned off.
- Connection Request Authentication:** A checked checkbox.
- Username:** A text input field containing 'admin'.
- Password:** A password input field with masked characters '....' and a visibility icon.
- Path:** A text input field containing '/tr069'.
- Port:** A text input field containing '7547'.
- URL:** An empty text input field.

At the bottom left, there is a teal button labeled 'Get RPC Methods'. At the bottom right, there is a teal button labeled 'Save'.

- **CWMP:** Toggle On to enable the CWMP (CPE WAN Management Protocol) feature.
- **Inform:** Enable this feature to send an Inform message to the ACS (Auto Configuration Server) periodically.
- **Inform Interval:** Enter the time interval in seconds when the Inform message will be sent to the ACS.
- **ACS URL:** Enter the web address of the ACS which is provided by your ISP.
- **ACS Username/Password:** Enter the username/password to log in to the ACS server.
- **Interface used by TR-069 client:** Select which interface to be used by the TR-069 client.
- **Display SOAP messages on serial console:** Toggle to enable or disable this feature.
- **Connection Request Authentication:** Select this check box to enable authentication for the connection request.
- **Username/Password:** Enter the username/password for the ACS server to log in to the router.
- **Path:** Enter the path for the ACS server to log in to the router.
- **Port:** Enter the port that connects to the ACS server.
- **URL:** Enter the URL that connects to the ACS server.

- **Get RPC methods:** Click to get the methods to support CWMP.

Click **Save** to make the settings effective.

16. 12. SNMP Settings

SNMP (Simple Network Management Protocol) is widely applied in the computer networks of today, and is used for ensuring the transmission of the management information between two nodes. In this way, network administrators can easily search and modify the information on any node on the network. Meanwhile, they can locate faults promptly and implement the fault diagnosis, capacity planning and report generating.

An **SNMP Agent** is an application running on the modem router that performs the operational role of receiving and processing SNMP messages, sending responses to the SNMP manager, and sending traps when an event occurs. So a router contains SNMP "agent" software can be monitored and/or controlled by SNMP Manager using SNMP messages.

1. Visit <http://tplinkmodem.net>, and log in with your TP-Link ID or the password you set for the modem router.
2. Go to **Advanced > System Tools > SNMP Settings** page.

SNMP Settings

SNMP Agent:

SNMP Agent for WAN:

Read-only Community:

Write Community:

System Name:

System Description:

System Location:

System Contact:

Trap Manager IP:

Save

- **SNMP Agent:** Toggle On to enable the built-in SNMP agent that allows the router to operate as the operational role in receiving and processing of SNMP messages, sending responses to the SNMP manager, and triggering SNMP traps when an event occurs.

- **SNMP Agent for WAN:** Toggle On to allow management from the WAN side using SNMP.
- **Read-only Community:** Displays the default public community string that protects the router from unauthorized access.
- **Write Community:** Displays the default write community string that protects the router from unauthorized changes.
- **System Name:** Displays the administratively-assigned name for this managed device.
- **System Description:** Displays the textual description of the managed device. This value should include the full name and version identification of the system's hardware type, software operating-system, and networking software.
- **System Location:** Displays the physical location of this device (for example, the telephone closet, 3rd floor).
- **System Contact:** Displays the textual identification of the contact person for this managed device, together with information on how to contact this person.
- **Trap Manager IP:** Displays the IP address of the host to receive the traps.

You are suggested to keep the default settings. Click **Save** to make the settings effective.

Appendix: Troubleshooting

T1. How do I restore my modem router's configuration to its factory default settings?

With the modem router powered on, press and hold down the Reset button on the modem router for 8 seconds until all LEDs turn on momentarily, then release the button.

Note: Once the modem router is reset, the current configuration settings will be lost and you will need to re-configure the modem router.

T2. What should I do if I forgot my password?

Web management page password:

- If you are using a TP-Link ID to log in, click [Forgot password](#) on the login page and then follow the instructions to reset the password.
- Alternatively, refer to [T1](#) to reset the router, and then visit <http://tplinkmodem.net> to create a new login password.

Wireless network password:

1. The default Wireless Password/PIN is printed on the product label of the modem router.
2. If the default wireless password has been changed, log in to the modem router's web management page and go to [Basic > Wireless](#) to retrieve or reset your password.

T3. What should I do if I cannot log in to the modem router's web management page?

- Make sure the modem router connects to the computer correctly and the corresponding LED indicator(s) light up.
- Make sure the IP address of your computer is configured to obtain an IP address automatically and obtain the DNS server address automatically.
- Make sure the default access you input is right.
- Check your computer's settings:
 - 1) Go to [Start > Control Panel > Network and Internet](#), and click [View network status and tasks](#);
 - 2) Click [Internet Options](#) on the bottom left;
 - 3) Click [Connections](#), select [Never dial a connection](#);

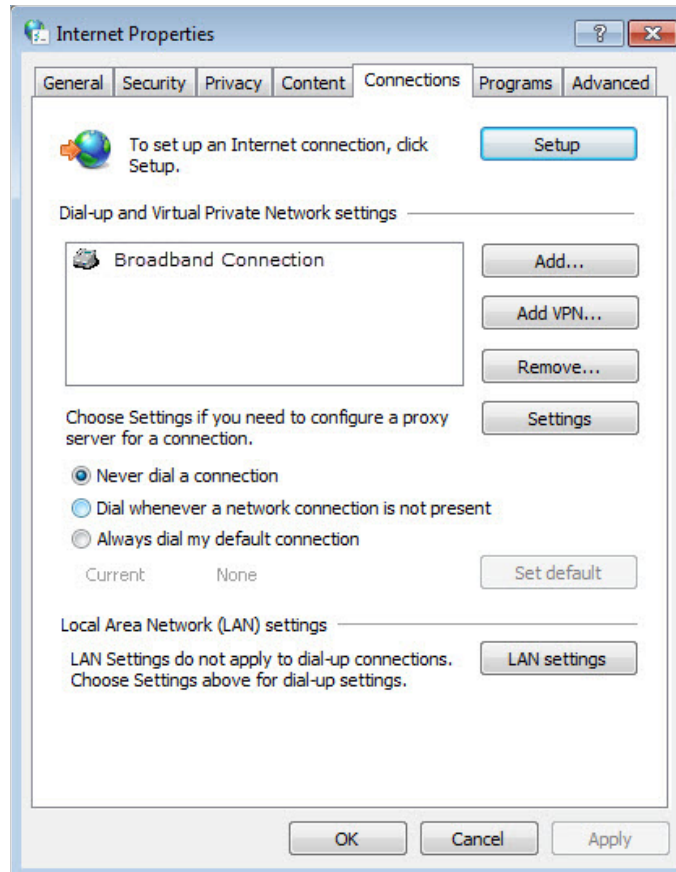

4) Click [LAN settings](#), deselect the following three options and click [OK](#);

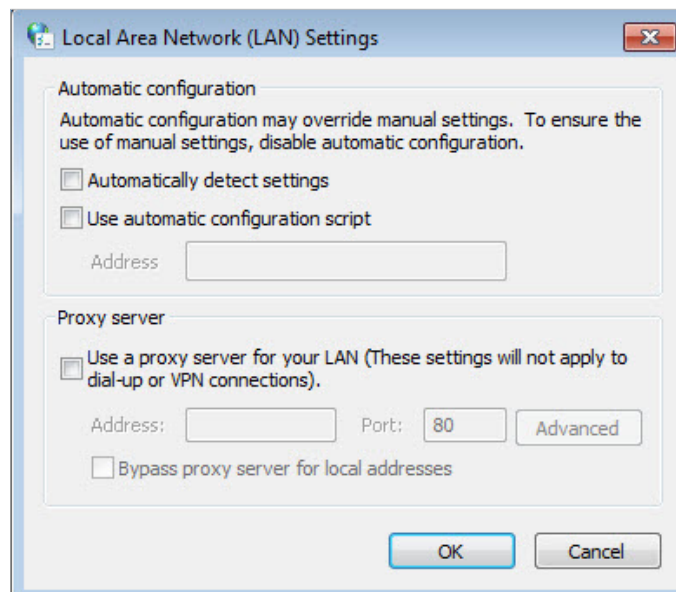

5) Go to [Advanced](#) > [Restore advanced settings](#), click [OK](#) to save the settings.

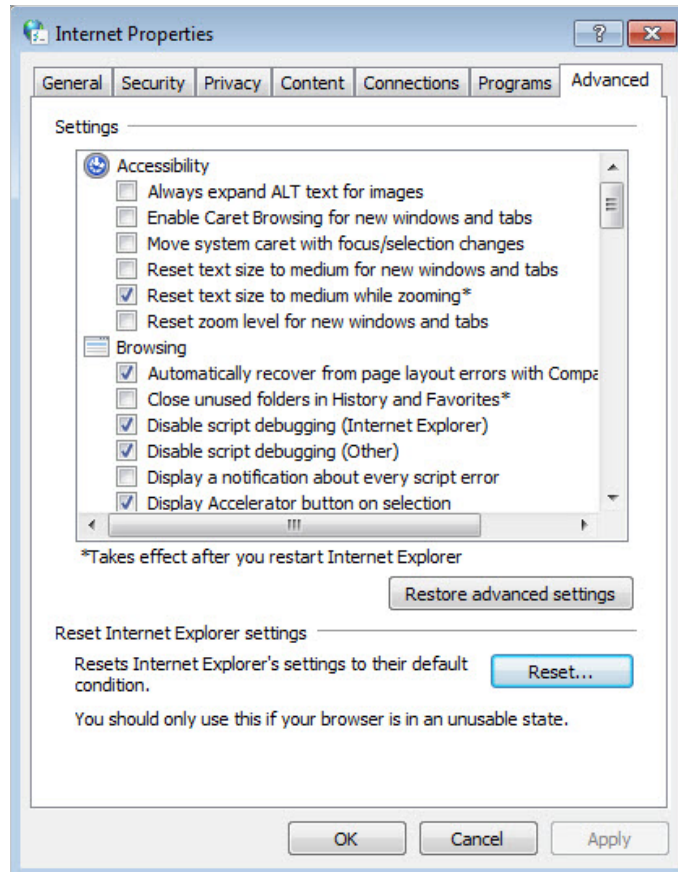

- Change a web browser or computer and log in again.
- Reset the modem router to factory default settings. Refer to [Back up and Restore Configuration Settings](#) for detailed information. Open a web browser and log in again. If login fails, please contact our Technical Support.

T4. What should I do if I cannot access the internet?

1. Ensure all connections are secure, including telephone lines, Ethernet cables and power adapters.
2. Check to see if you can log in to the web management page of the modem router. If you cannot, please adjust your computer's settings according to [T3](#) and then see if you can access the internet. If the problem persists, please go to the next step.
3. Consult your ISP and make sure the VPI/VCI, Connection Type, account username and password are correct. If there are any mistakes, please correct the settings and try again.
4. Refer to [T5](#) to clone the MAC address.
5. If you still cannot access the internet, please restore your modem router to its factory default settings and reconfigure your modem router by following the instructions in [Use Quick Setup Wizard](#).

6. Please contact our Technical Support if the problem persists.

T5. How do I clone a MAC address?

You can manually change the MAC address of the modem router. It is helpful when your internet access account provided by your ISP is bound to one specific MAC address, in other words, your ISP just permits only one computer with the authenticated MAC address to access the internet. In this case, you can use MAC Clone to allow more computers to access the internet via the same account.

1. Visit <http://tplinkmodem.net>, and log in with the account you set for the modem router.
2. Go to **Advanced** > **Network** > **Internet** page. Click the **Add** icon, and scroll down to get the **MAC Clone** section.

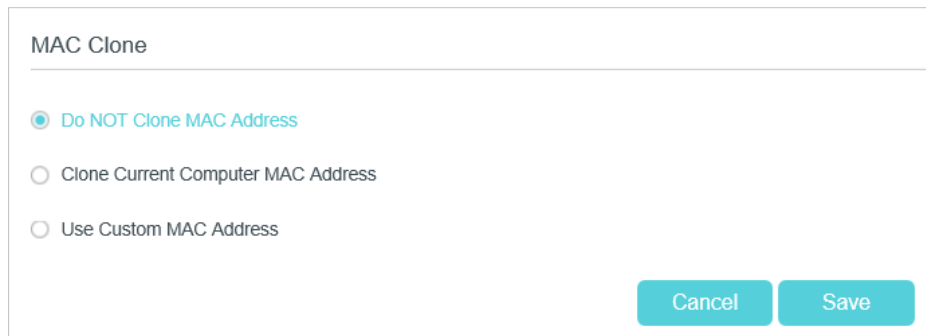

MAC Clone

Do NOT Clone MAC Address

Clone Current Computer MAC Address

Use Custom MAC Address

Cancel Save

- If you are using the computer with the authenticated MAC address to access the modem router, please select **Use Current Computer MAC Address**.
 - If you know the authenticated MAC address, please select **Use Custom MAC Address** and then enter the address.
3. Click **OK** to make the settings effective.

T6. How can I change my computer's settings to obtain an IP address automatically?

To change the computer's network settings, follow the steps below.

- For MAC OS X:
 - 1) Click the Apple icon, and select **System Preferences** from the drop-down list.
 - 2) Click the Network icon.
 - 3) Select **Ethernet** (for wired connection) or **Wi-Fi** (for wireless connection) in the left panel, then click **Advanced**.
 - 4) Click **TCP/IP**.
 - 5) From the **Configure IPv4** drop-down list, select **Using DHCP**.

- 6) Click **OK**.
 - For Windows 7/8/8.1/10:
 - 1) Right-click the Network icon on the system tray and select [Open Network and Sharing Center](#) > [Change adapter settings](#).
 - 2) Right-click your network connection (wired or wireless) and select [Properties](#).
 - 3) Double-click [Internet Protocol Version 4 \(TCP/IPv4\)](#).
 - 4) Select both [Obtain an IP address automatically](#) and [Obtain DNS server address automatically](#), then click **OK**.
 - 5) Click **OK** again to save your configuration.
 - For Windows XP:
 - 1) Right-click the Network icon on the system tray and select [Open Network Connections](#).
 - 2) Right-click your network connection (wired or wireless) and select [Properties](#).
 - 3) Double-click [Internet Protocol \(TCP/IP\)](#).
 - 4) Select both [Obtain an IP address automatically](#) and [Obtain DNS server address automatically](#), then click **OK**.
 - 5) Click **OK** again to save your configuration.

T7. What should I do if I cannot find my wireless network or I cannot connect the wireless network?

- **If you fail to find any wireless network, follow the steps below:**
 1. Make sure the wireless function is enabled if you're using a laptop with built-in wireless adapter. You can refer to the relevant document or contact the laptop manufacturer.
 2. Make sure the wireless adapter driver is installed successfully and the wireless adapter is enabled. You can refer to the relevant document or contact the wireless adapter manufacturer.
- **If you can find other wireless network except your own, follow the steps below:**
 1. Check the Wi-Fi LED indicator on your wireless router/modem;
 2. Make sure your computer/device is still in range of your router/modem. Move closer if you are currently too far away.
 3. Go to [Basic](#) > [Wireless](#) page, and check the wireless settings, double-check your Wireless Name (SSID) is not hidden.
 4. Connect to wireless network.

- If you can find your wireless network but fail to connect, follow the steps below:

1. Authentication problem: Network Security Key Mismatch.

- 1) Sometimes you will be asked to type in a PIN number when you connect to the wireless network for the first time. This PIN number is different from the Wireless Password/Network Security Key, usually you can only find it on the label of your modem router.



- 2) If you cannot find the PIN or PIN failed, you may choose “[Connecting using a security key instead](#)”, and then type in the Network Security Key/Wireless Password;



- 3) If you continue to be told there is a network security key mismatch, it is suggested to check the wireless password on your modem router.

Note: Wireless password/Network Security Key is case sensitive.



- 4) Connect to wireless network.
2. Windows was unable to connect to XXXX /Cannot join this network/Taking longer than usual to connect to this network.
 - 1) Check the wireless signal strength of your network, if it is weak (1~3 bars), please move the router closer and try again;
 - 2) Change the wireless Channel of the router to 1,6,or 11 to reduce interference from other networks;
 - 3) Re-install or update the driver for your wireless adapter of the computer;
 - 4) Connect to wireless network.

CE Mark Warning



This is a class B product. In a domestic environment, this product may cause radio interference, in which case the user may be required to take adequate measures.

OPERATING FREQUENCY(the maximum transmitted power)

2400 MHz -2483.5 MHz(20dBm)

5150 MHz -5250 MHz(23dBm)

5250 MHz -5350 MHz (23dBm)

5470 MHz -5725 MHz (30dBm)

EU Declaration of Conformity

TP-Link hereby declares that the device is in compliance with the essential requirements and other relevant provisions of directives 2014/53/EU, 2009/125/EC, 2011/65/EU and (EU)2015/863.

The original EU Declaration of Conformity may be found at <https://www.tp-link.com/en/support/ce/>

UK Declaration of Conformity

TP-Link hereby declares that the device is in compliance with the essential requirements and other relevant provisions of the Radio Equipment Regulations 2017.

The original UK Declaration of Conformity may be found at <https://www.tp-link.com/support/ukca/>

RF Exposure Information



This device meets the EU requirements (2014/53/EU Article 3.1a) on the limitation of exposure of the general public to electromagnetic fields by way of health protection.

The device complies with RF specifications when the device used at 20 cm from your body.

National Restrictions

Attention: This device may only be used indoors in all EU member states, EFTA countries and Northern Ireland.

Attention: This device may only be used indoors in Great Britain.

	AT	BE	BG	CH	CY	CZ	DE	DK
	EE	EL	ES	FI	FR	HR	HU	IE
	IS	IT	LI	LT	LU	LV	MT	NL
	NO	PL	PT	RO	SE	SI	SK	UK(IN)
	UK							

Canadian Compliance Statement

This device contains licence-exempt transmitter(s)/receiver(s) that comply with Innovation, Science and Economic Development Canada's licence-exempt RSS(s). Operation is subject to the following two conditions:

- (1) This device may not cause interference.
- (2) This device must accept any interference, including interference that may cause undesired operation of the device.

L'émetteur/récepteur exempt de licence contenu dans le présent appareil est conforme aux CNR d'Innovation, Sciences et Développement économique Canada applicables aux appareils radio exempts de licence. L'exploitation est autorisée aux deux conditions suivantes :

- 1) L'appareil ne doit pas produire de brouillage;
- 2) L'appareil doit accepter tout brouillage radioélectrique subi, même si le brouillage est susceptible d'en compromettre le fonctionnement.

Caution:

The device for operation in the band 5150–5250 MHz is only for indoor use to reduce the potential for harmful interference to co-channel mobile satellite systems;

DFS (Dynamic Frequency Selection) products that operate in the bands 5250- 5350 MHz, 5470-5600MHz, and 5650-5725MHz.

Avertissement:

- 1) Le dispositif fonctionnant dans la bande 5150-5250 MHz est réservé uniquement pour une utilisation à l'intérieur afin de réduire les risques de brouillage préjudiciable aux systèmes de satellites mobiles utilisant les mêmes canaux;

Les produits utilisant la technique d'atténuation DFS (sélection dynamique des fréquences) sur les bandes 5250- 5350 MHz, 5470-5600MHz et 5650-5725MHz.

Radiation Exposure Statement:

This equipment complies with IC radiation exposure limits set forth for an uncontrolled environment. This equipment should be installed and operated with minimum distance 20cm between the radiator & your body.

Déclaration d'exposition aux radiations:

Cet équipement est conforme aux limites d'exposition aux rayonnements IC établies pour un environnement non contrôlé. Cet équipement doit être installé et utilisé avec un minimum de 20 cm de distance entre la source de rayonnement et votre corps.

Korea Warning Statements

당해 무선설비는 운용중 전파혼신 가능성이 있음.



Продукт сертифіковано згідно с правилами системи УкрСЕПРО на відповідність вимогам нормативних документів та вимогам, що передбачені чинними законодавчими актами України.



Safety Information

- Keep the device away from water, fire, humidity or hot environments.
- Do not attempt to disassemble, repair, or modify the device. If you need service, please contact us.
- Do not use damaged charger or USB cable to charge the device.
- Do not use any other chargers than those recommended
- Do not use the device where wireless devices are not allowed.
- Adapter shall be installed near the equipment and shall be easily accessible.
- Use only power supplies which are provided by manufacturer and in the original packing of this product. If you have any questions, please don't hesitate to contact us.

Operating Temperature: 0℃~40℃

Storage Temperature:-40℃~60℃

Please read and follow the above safety information when operating the device. We cannot guarantee that no accidents or damage will occur due to improper use of the device. Please use this product with care and operate at your own risk.

NCC Notice & BSMI Notice:

注意!

依據 低功率電波輻射性電機管理辦法

LP0002低功率射頻器材技術規範_章節3.8.2

取得審驗證明之低功率射頻器材，非經核准，公司、商號或使用者均不得擅自變更頻率、加大功率或變更原設計之特性及功能。

低功率射頻器材之使用不得影響飛航安全及干擾合法通信；經發現有干擾現象時，應立即停用，並改善至無干擾時方得繼續使用。

前述合法通信，指依電信管理法規定作業之無線電通信。

低功率射頻器材須忍受合法通信或工業、科學及醫療用電波輻射性電機設備之干擾。

應避免影響附近雷達系統之操作。

高增益指向性天線只得應用於固定式點對點系統。

安全諮詢及注意事項

- 請使用原裝電源供應器或只能按照本產品注明的電源類型使用本產品。
- 清潔本產品之前請先拔掉電源線。請勿使用液體、噴霧清潔劑或濕布進行清潔。
- 注意防潮，請勿將水或其他液體潑灑到本產品上。
- 插槽與開口供通風使用，以確保本產品的操作可靠並防止過熱，請勿堵塞或覆蓋開口。
- 請勿將本產品置放於靠近熱源的地方。除非有正常的通風，否則不可放在密閉位置中。
- 請不要私自打開機殼，不要嘗試自行維修本產品，請由授權的專業人士進行此項工作。

限用物質含有情況標示聲明書







設備名稱：AC2100 Wireless MU-MIMO VDSL/ADSL Modem Router		型號（型式）：Archer VR2100				
Equipment name		Type designation (Type)				
單元 Unit	限用物質及其化學符號 Restricted substances and its chemical symbols					
	鉛 Lead (Pb)	汞 Mercury (Hg)	鎘 Cadmium (Cd)	六價鉻 Hexavalent chromium (Cr ⁶⁺)	多溴聯苯 Polybrominated biphenyls (PBB)	多溴二苯醚 Polybrominated diphenyl ethers (PBDE)
PCB	○	○	○	○	○	○
外殼	○	○	○	○	○	○
電源供應器	—	○	○	○	○	○
天線	○	○	○	○	○	○

備考1. “超出0.1 wt %” 及 “超出0.01 wt %” 係指限用物質之百分比含量超出百分比含量基準值
 Note 1: “Exceeding 0.1 wt %” and “exceeding 0.01 wt %” indicate that the percentage content of the restricted substance exceeds the reference percentage value of presence condition.

備考2. “○” 係指該項限用物質之百分比含量未超出百分比含量基準值。
 Note 2: “○” indicates that the percentage content of the restricted substance does not exceed the percentage of reference value of presence.

備考3. “—” 係指該項限用物質為排除項目。
 Note 3: The “—” indicates that the restricted substance corresponds to the exemption.

Explanation of the symbols on the product label

Symbol	Explanation
	DC voltage
	Class II equipment
	AC voltage
	Energy efficiency Marking
	Polarity of output terminals
	<p>RECYCLING</p> <p>This product bears the selective sorting symbol for Waste electrical and electronic equipment (WEEE). This means that this product must be handled pursuant to European directive 2012/19/EU in order to be recycled or dismantled to minimize its impact on the environment.</p> <p>User has the choice to give his product to a competent recycling organization or to the retailer when he buys a new electrical or electronic equipment.</p>
	Indoor use only