



Questo manuale d'istruzione è fornito da trovaprezzi.it. Scopri tutte le offerte per [ZTE Blade A31 Lite](#) o cerca il tuo prodotto tra le migliori offerte di Cellulari e Smartphone



Questo manuale d'istruzione è fornito da trovaprezzi.it. Scopri tutte le offerte per [Zte Blade A31 Lite](#) o cerca il tuo prodotto tra le migliori offerte di Cellulari e Smartphone

ZTE

ZTE Blade A31 Lite

User Manual

About This Manual

Thank you for choosing this ZTE mobile device. In order to keep your device in its best condition, please read this manual and keep it for future reference.

Copyright

Copyright © 2021 ZTE CORPORATION

All rights reserved.

No part of this publication may be quoted, reproduced, translated or used in any form or by any means, electronic or mechanical, including photocopying and microfilm, without the prior written permission of ZTE Corporation.

Notice

ZTE Corporation reserves the right to make modifications on print errors or update specifications in this guide without prior notice. This manual has been designed with the utmost care to ensure the accuracy of its content. However, all statements, information and recommendations contained therein do not constitute a warranty of any kind, either expressed or implied. Please refer to [For Your Safety](#) to be sure to use your phone properly and safely. We offer self-service for our smart terminal device users. Please visit the ZTE official website (at <https://www.ztedevices.com/>) for more information on self-service and supported product models. Information on the website takes precedence.

Disclaimer

ZTE Corporation expressly disclaims any liability for faults and damages caused by unauthorized modifications of the software. Images and screenshots used in this manual may differ from the actual product. Content in this manual may differ from the actual product or software.

Trademarks

ZTE and the ZTE logos are trademarks of ZTE Corporation.

Android™ is a trademark of Google LLC.

The *Bluetooth*® word mark and logos are registered trademarks owned by the Bluetooth SIG, Inc. and any use of such marks by ZTE Corporation is under license.



microSDXC Logo is a trademark of SD-3C, LLC.

Other trademarks and trade names are those of their respective owners.

Instructional Icons



NOTE

Additional information, supplementary instruction or tips for the operation of the product.



CAUTION

Safety information that, if ignored, may cause minor damage to the equipment or service interruption.



WARNING

Safety information that, if ignored, may cause serious damage to the equipment or danger to personal safety.

Version No.: R1.0

Edition Time: February 26, 2021

Contents

Getting Started	9
Getting to Know Your Phone	9
Knowing the Keys	11
Setting Up Your Phone	11
Charging the Phone	15
Powering On/Off	16
Setting Up for the First Time.....	17
Locking/Unlocking the Screen and Keys.....	17
Getting to Know the Home Screen	18
Personalizing	20
Setting the Navigation Style.....	20
Changing the System Language	21
Switching to Vibration or Silent Mode	22
Using Do Not Disturb Mode.....	23
Choosing Your Wallpaper	24
Using Dark Theme	25
Knowing the Basics	26
Phone Status Icons	26
Notification Icons.....	27
Using Quick Settings.....	27
Opening and Switching Apps.....	28
Security	30

Protecting Your Phone With Screen Locks	30
Protecting Your Phone With App Pinning.....	31
Connecting to Networks.....	33
Connecting to Mobile Networks.....	33
Connecting to Wi-Fi	36
Connecting to Devices	37
Connecting to Bluetooth Devices	37
Connecting to Your Computer via USB.....	38
Sharing Files With Nearby Devices	39
Sharing Your Mobile Data Connection Through Tethering.....	42
Phone Calls	43
Placing Calls.....	43
Answering or Rejecting Calls	44
Using Options During a Call.....	45
Managing Multi-party Calls.....	46
Contacts.....	49
Adding a New Contact	49
Importing and Exporting Contacts	49
Setting a Ringtone for a Contact	50
Setting Call Blocking.....	51
Messages.....	52
Sending a Message	52

Message Options	53
Web Browser	55
Opening the Browser	55
Using Multiple Browser Tabs	55
Changing Browser Settings	56
Camera	57
Capturing a Photo	57
Recording a Video.....	59
Using Pro Mode	59
Using Other Camera Modes.....	60
Gallery	62
Opening Gallery	62
Sharing Your Photos or Videos.....	62
Deleting Unwanted Photos or Videos	62
FM Radio	63
Scanning for Channels	63
Listening to FM Radio	63
Voice Recorder.....	64
Recording a Voice Memo	64
Playing a Voice Memo.....	64
Trimming a Voice Memo.....	65
Settings	66
Network & Internet	66

Connected Devices.....	68
Apps & Notifications.....	69
Battery.....	71
Features.....	71
Display.....	71
Sound.....	71
Storage.....	72
Privacy.....	72
Location.....	73
Security.....	73
Accounts.....	75
Accessibility.....	75
Digital Wellbeing & Parental Controls.....	76
Google.....	76
System.....	77
About Phone.....	78
For Your Safety.....	79
General Safety.....	79
FCC RF Exposure Information (SAR).....	81
FCC Regulations.....	82
Distractions.....	84
Product Handling.....	84
Electrical Safety.....	90
Radio Frequency Interference.....	90
Explosive Environments.....	92

Getting Started

Getting to Know Your Phone

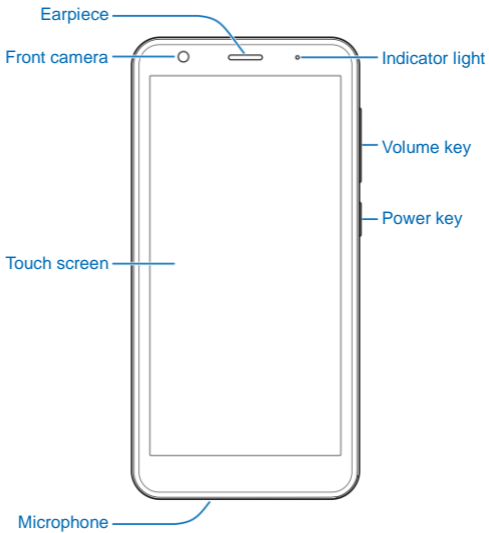

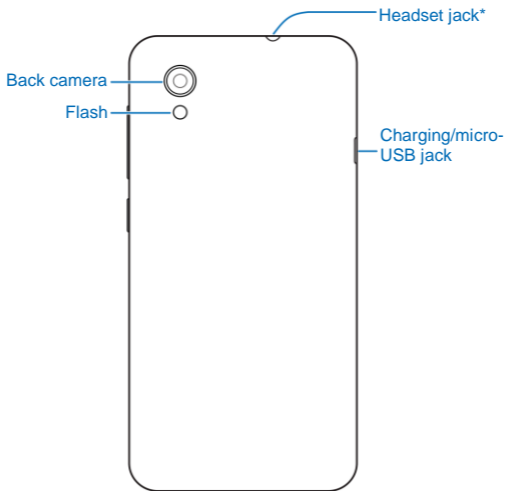

Knowing the Keys

Key	Function
Power key	<ul style="list-style-type: none">• Press and hold to power off or restart.• Press to turn off or on the screen display.
Volume key	Press or hold either end of the key to turn the volume up or down.

NOTE:

You can use virtual keys or gestures to navigate your phone. See [Setting the Navigation Style](#).

Setting Up Your Phone

Power off your phone before removing or replacing the battery.

WARNING!

To avoid damage to the phone, do not use any other kind of SIM cards, or any non-standard nano-SIM card cut from a SIM card. You can get a standard nano-SIM card from your service provider.

1. Place your finger into the slot at the bottom of the back cover, and gently lift and remove the cover.

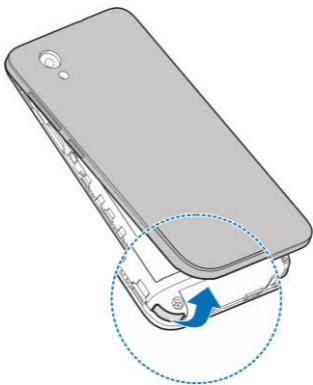

2. Install the nano-SIM card and the microSDXC card as shown.

If your phone supports dual SIM cards, you can also install a second nano-SIM card in slot 2.

Single-SIM
model

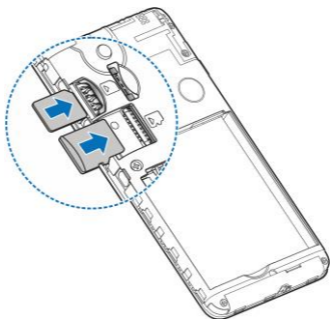

Dual-SIM
model

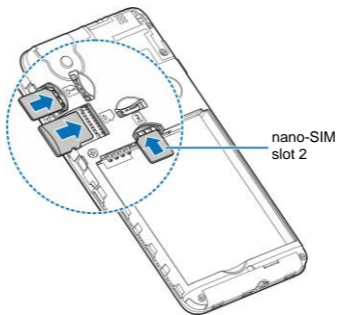

 **NOTES:**

- The dual-SIM model is not available in every country. Consult your supplier for more information.
 - If two nano-SIM cards are installed on the dual-SIM model, both cards can connect to the 4G, 3G, or 2G network, and either card can be used for mobile data.
3. Insert the battery, making sure the connectors align. Gently push down on the battery until it clicks into place.

Single-SIM
model

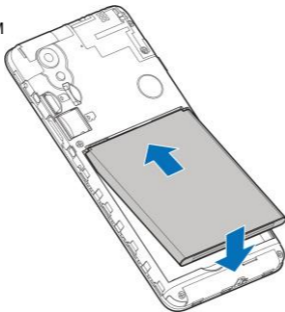

Dual-SIM
model

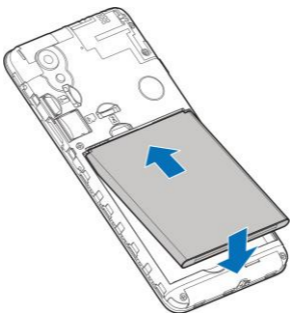

4. Replace the back cover.

Charging the Phone



Your phone's battery should have enough power for the phone to turn on, find a signal, and make a few calls. You should fully charge the battery as soon as possible.

WARNING!

Use only ZTE-approved chargers and USB cables. The use of unapproved accessories could damage your phone or cause the battery to explode.

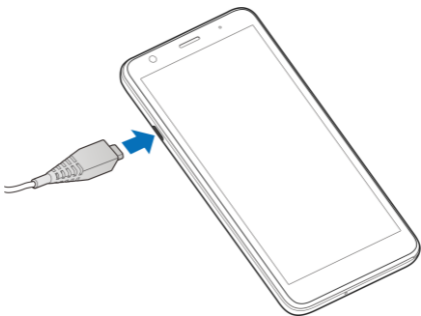
1. Connect the adapter to the charging jack. Ensure that the adapter is inserted in the correct direction.



2. Connect the charger to a standard AC power outlet. If the phone is on, you'll see a charging icon such as  or  appear on the status bar.
3. Disconnect the charger when the battery is fully charged.





NOTE:

If the battery is extremely low, you may be unable to power on the phone even when it is being charged. In this case, try again after charging the phone for at least 20 minutes. Contact the customer service if you still cannot power on the phone after prolonged charging.

Powering On/Off

- Press and hold the **Power** key to turn on your phone.

- To power off, press and hold the **Power** key to open the options menu, and touch  > .

 **NOTE:**

If the screen freezes or takes too long to respond, reinstall the battery and power on again.

Setting Up for the First Time

When you first power on your phone after you purchase it or reset it to factory settings, you need to do some settings before using it.

Select the language field and follow the on-screen prompts to set up your phone.

Locking/Unlocking the Screen and Keys

Your phone allows you to quickly lock the screen and keys (put the phone to sleep mode) when not in use and to turn the screen back on and unlock it when you need it.

To lock the screen and keys:

To quickly turn the screen off and lock the keys, press the **Power** key.

 **NOTE:**

To save battery power, the phone automatically turns off the screen after some time of inactivity. You will still be able to

receive messages and calls while the phone screen is off.

To unlock the screen and keys:

1. Press the **Power** key to turn the screen on.
2. Swipe up on the screen.

- or -

Swipe from  to open the camera.

- or -

Touch a notification twice consecutively to open the related app.



NOTE:

If you have set an unlock pattern, a PIN or a password for your phone (see [Protecting Your Phone With Screen Locks](#)), you'll need to draw the pattern or enter the PIN/password to unlock your screen.

Getting to Know the Home Screen

The home screen is the starting point for your phone's applications, functions, and menus. You can customize your home screen by adding shortcuts and folders.

Extended Home Screen Panels

Your home screen is extendable, providing more space for shortcuts and folders. After adding some extended panels, you can simply swipe left or right on the home screen to see each panel. You can also remove these panels.

To add a new home screen panel:

Touch and hold an item such as a shortcut or folder on the home screen and drag it to the right edge of the screen to create a new home screen panel and put the item on it.



NOTE:

No empty home screen panel is allowed to exist. If the shortcut or folder is the only item on the current home screen panel, the panel will be deleted as you remove the item.

Personalizing

Setting the Navigation Style



You can set the navigation style as virtual navigation or gesture navigation.

Use Virtual Navigation





To enable virtual navigation:

1. Open **Settings** and touch **Features > System navigation**.
2. Select **Virtual navigation**.

NOTE:

Touch  beside **Virtual navigation** to change the navigation key layout, or turn on or off the concealable navigation bar. To hide the navigation bar, switch off **Always show navigation bar** and touch  on the navigation bar. To display the navigation bar again, swipe up from the bottom of the screen.

To use virtual navigation:

- Touch  (the **Home** key) to return to the home screen from any application or screen.
- Touch and hold  to use the Google Assistant.
- Touch  (the **Back** key) to go to the previous screen.
- Touch  (the **Recent apps** key) to see recently used apps.

- Touch  twice to switch to the most recent application.

Use Gesture Navigation

To enable gesture navigation:

1. Open **Settings** and touch **Features > System navigation**.
2. Select **Gestures**.

NOTE:

Touch  beside **Gestures** to enable or disable visual feedback and adjust the back sensitivity of edges for gesture navigation.

To use gesture navigation:

- Swipe up from the bottom of your screen to return to the home screen from any application or screen.
- Swipe up from the bottom of your screen to the middle and hold to see recently used apps.
- Swipe left or right along the bottom of your screen to switch among recently used apps.
- Swipe inside from the left or right edge of your screen to go to the previous screen.
- Swipe up from the bottom left or bottom right of your screen to activate the Google Assistant.

Changing the System Language

1. Open **Settings** and touch **System > Languages & input > Languages**. The first language in the list is the default

system language.

2. Touch **Add a language** and then the language you need. Select the regional variant of the language if prompted.
3. Touch and hold a language and move it to the top to switch to that language.



NOTE:

To remove languages from the list, touch  > **Remove** and select the languages you want to delete.

Switching to Vibration or Silent Mode

You can set the phone to vibration or silent mode by using one of the following methods.

- Press the **Volume** key up or down and then touch the icon above the slider to switch the phone to vibration or silent mode or turn on the sound.
- Press the **Volume up** key and the **Power** key at the same time to switch to silent mode or vibration mode.



NOTE:

You can select to switch to silent or vibration mode by opening **Settings > Sound > Switch to vibrate/silent** and choosing **Mute** or **Vibrate**.

- Swipe down from the status bar to open the notification panel and drag the panel downwards. Touch **Ring**, **Vibrate**, or **Silent** to switch the phone to vibration or silent mode or turn on the sound.

- Open **Settings** and touch **Sound > Advanced > Notification mode** and select **Vibrate** or **Mute** to switch to vibration or silent mode.

Using Do Not Disturb Mode

You can limit interruptions with Do Not Disturb mode. This mode can mute sound, stop vibration, and block visual disturbances. You can pick what you block and what you allow.

Turn On or Off Do Not Disturb Mode

1. Open **Settings** and touch **Sound > Do Not Disturb**.
2. Touch **TURN ON NOW** or **TURN OFF NOW**.

Set the Exceptions for Do Not Disturb Mode

1. Open **Settings** and touch **Sound > Do Not Disturb**.
2. Select the following options and choose what to allow.
 - ▶ **People:** Allow calls, messages, or conversations.
 - ▶ **Apps:** Choose which apps can send you notifications.
 - ▶ **Alarms & other interruptions:** Allow alarms, media sounds, touch sounds, reminders, or calendar events.

Set an Automatic Schedule

You can set automatic schedules to activate Do Not Disturb mode for specific times or events.

1. Open **Settings** and touch **Sound > Do Not Disturb > Schedules**.

2. Touch an existing schedule to turn it on or off, or touch  next to the schedule to customize it.
- or -
Touch **Add more** to create your own schedules.

Set How Long Do Not Disturb Mode Lasts

1. Open **Settings** and touch **Sound > Do Not Disturb > Advanced > Duration for Quick Settings**.
2. Set how long Do Not Disturb mode will stay on when you turn it on.

Choose Settings for Hidden Notifications

1. Open **Settings** and touch **Sound > Do Not Disturb > Advanced > Display options for hidden notifications**.
2. Set notification behavior in Do Not Disturb mode. You can block sound or visuals from notifications, or customize more restrictions.

Choosing Your Wallpaper

You can set the wallpaper for the home screen or lock screen.

1. Touch and hold an empty place on the home screen and then touch **Wallpapers**.
2. Select a preset wallpaper, or touch **GALLERY > Gallery Go** to select a picture and pan and zoom on it to select the area for the wallpaper.

3. Touch **SET AS** and choose where the wallpaper should be used.

 **NOTE:**

Alternatively, you can open **Settings** and touch **Display > Wallpaper** to set the wallpaper.

Using Dark Theme

When Dark theme is enabled, your phone will turn the screen to dark with white text on a black background, relieving eye irritation caused by screen glare at night.

1. Open **Settings** and touch **Display > Dark theme**.
2. Touch **TURN ON NOW** to enable Dark theme.

- or -

If you want to set a schedule when Dark theme will be turned on automatically, touch **Schedule** and set the start and end time.



















 **NOTE:**

Not all apps support Dark theme.

Knowing the Basics







Phone Status Icons

The status bar at the top of the home screen provides phone and service status icons on the right side. Below are some of the icons you may see.

	3G connected		No signal
	4G connected		Signal strength
	Vibration on		Mobile data in use
	Silent mode on		Airplane mode
	Do Not Disturb mode on		Connected to a Wi-Fi [®] network
	Battery low		Speaker on
	Battery full		Phone microphone off
	Battery charging		Location service active
	Wired headset connected		Alarm set

Notification Icons

The status bar at the top of the home screen provides notification icons on the left. Below are some of the icons you may see.

	New message(s) from the Messages app		New Wi-Fi network detected
	Missed call		microSDXC card mounted
	Call in progress		Call on hold

Using Quick Settings

The Quick Settings make it convenient to view or change the most common settings for your phone.

Swipe down from the status bar and drag the notification panel downwards to open the Quick Settings panel.

To turn on or off settings quickly:

1. Open the Quick Settings panel.
2. To turn on or off a setting, touch its tile. Touch and hold certain tiles to access more setting options. For example, touch and hold the Wi-Fi tile to open Wi-Fi settings.

To customize the Quick Settings panel:

You can add, remove or rearrange the tiles on the Quick Settings panel.

1. Open the Quick Settings panel.
2. Touch  at the bottom and do one of the following.
 - ▶ Touch and hold a tile and drag it to the position you want.
 - ▶ Touch and hold a tile and drag it to the section below to hide it.
 - ▶ In the **HOLD AND DRAG TO ADD TILES** section, drag a tile up to show it in the Quick Settings panel.

Opening and Switching Apps

Open an App

1. Swipe up on the home screen to view apps.
2. Slide up or down on the screen and touch an app to open it.

 **NOTE:**

Drag the slider on the right side of the screen to the initial letter of the app you need, or touch the search box at the top to search for apps.

Switch Between Recently Opened Apps

1. Open the recent apps list. The apps you've used recently are displayed in a series of cards. Slide left and right to see all the cards.

 **NOTE:**

To view how to see recently used apps in different navigation styles, see [Setting the Navigation Style](#).

2. Touch a card to open that app.



NOTE:

You can swipe a card up to remove it from the screen, which will free up running memory on the phone.

Security

Protecting Your Phone With Screen Locks

You can protect your phone by creating a screen lock. When it is enabled, you need to swipe up on the screen, draw a pattern or enter a numeric PIN or password to unlock the phone's screen and keys.

1. Open **Settings** and touch **Security > Screen lock**.
2. Touch **None, Swipe, Pattern, PIN** or **Password**.
 - ▶ Touch **None** to disable the screen lock.
 - ▶ Touch **Swipe** to enable screen lock and allow unlocking with a “swipe” gesture. You can unlock the screen by touching the display and sliding up.
 - ▶ Touch **Pattern** to create a pattern that you must draw to unlock the screen.
 - ▶ Touch **PIN** or **Password** to set a numeric PIN or a password that you must enter to unlock the screen.
3. For Pattern, PIN, or Password lock, select how you want notifications and their contents to show when the phone is locked. Then touch **Done**.

CAUTION:

Remember the pattern, PIN or password you set. Otherwise, you will have to contact the customer service to reflash the phone

software to use your phone, and all data in your phone will be erased.

Protecting Your Phone With App Pinning

You can pin an app's screen to keep it in view until you unpin it. This feature can be used, for example, to let a trusted friend play a specific game.

NOTE:

When an app is pinned, the pinned app may open other apps and your personal data may be accessible, so use app pinning only with people you trust.



Turn On App Pinning

1. Open **Settings** and touch **Security > Advanced > App pinning**.
2. Touch the **On/Off** switch.
3. Read the on-screen prompts and touch **OK**.
4. To add security for unpinning, switch on **Lock device when unpinning** and set up a screen lock as prompted, or switch on **Ask for unlock pattern before unpinning**, **Ask for PIN before unpinning**, or **Ask for password before unpinning** if you've set a screen lock already.

Pin an App

1. Ensure that app pinning is turned on.
2. Open the recent apps list. If the app you want to keep in view is not in recent apps, open it first.
3. Swipe left and right to find the app card. Then touch  at the top of the card and select **Pin**.

Unpin the App

1. To unpin the app and return to normal use, touch and hold both  and  for virtual navigation; swipe up from the bottom of the screen and hold for a while for gesture navigation.
2. If screen lock is enabled for app pinning, swipe up on the lock screen and draw the pattern or enter the PIN/password.

Connecting to Networks

Connecting to Mobile Networks

Manage the nano-SIM Cards (Dual-SIM Model)

When two nano-SIM cards are installed on the dual-SIM model, you can turn on or off one of the cards or mobile data, or choose the default card for calls or messages.

To turn on or off a card:

1. Open **Settings** and touch **Network & internet**.
2. Touch one of the two card names at the top.
3. Touch the **Use SIM / Off** switch at the top.

NOTE:

You can touch  next to the card name to edit it, change its color, and view the service provider and number of the card.

To turn on/off mobile data:

1. Open **Settings** and touch **Network & internet**.
2. Touch one of the two card names at the top.
3. Touch the switch next to **Mobile data**.
4. If prompted, touch **USE [card name]** to confirm.

To set the default card for calls or messages:

1. Open **Settings** and touch **Network & internet**.
2. Touch either one of the two card names at the top.
3. Touch **Calls preference / SMS preference** to set the preferred SIM for outgoing calls and messages.

To allow non-data card to use data during calls:

When the non-data nano-SIM card is connected to a call, the other nano-SIM card cannot use data service. You can set the non-data card to use data temporarily during the call.



NOTE:

This feature is only useful when VoLTE service is available for the non-data card.

1. Open **Settings** and touch **Network & internet**.
2. Touch the name of the non-data card at the top.
3. Touch **Advanced** and turn on **4G Calling / VoLTE** and **Data during calls**.

Control Mobile Data Use

1. Open **Settings** and touch **Network & internet > Mobile network**.
2. If two nano-SIM cards are installed, touch one of the card names.
3. Touch the **Mobile data** switch to enable or disable mobile data for the current card.
4. If prompted, touch **USE [card name]** to confirm.



NOTE:

Switch on or off **Roaming** to control mobile data use on roaming networks.

Select Preferred Network Type

1. Open **Settings** and touch **Network & internet > Mobile network**.
2. If two nano-SIM cards are installed, touch one of the card names.
3. Touch **Advanced > Preferred network type** and select the type of network you prefer the phone to connect to.

Set Access Point Names

To connect to the Internet, you can use the default Access Point Names (APN). And if you want to add a new APN, please contact the service provider to get the necessary information.

1. Open **Settings** and touch **Network & internet > Mobile network**.
2. If two nano-SIM cards are installed, touch one of the card names.
3. Touch **Advanced > Access Point Names > ⋮ > New APN**.
4. Touch each item to enter the information you get from your service provider.
5. Touch **⋮ > Save** to complete.

NOTE:

To set the APN to default settings, touch **⋮ > Reset to default**.

Connecting to Wi-Fi

Wi-Fi is a wireless networking technology that can provide Internet access at distances of up to 100 meters, depending on the Wi-Fi router and your surroundings.

To turn Wi-Fi on and connect to a Wi-Fi network:

1. Open **Settings** and touch **Network & internet > Wi-Fi**.
2. Slide the switch to the on position to turn on Wi-Fi.
3. Touch a Wi-Fi network name to connect to it.
4. If the network is secured, enter the password and touch **CONNECT**.



NOTES:

- Your phone automatically connects to previously used Wi-Fi networks when they are in range.
- Your phone can automatically use mobile data network when the Wi-Fi signal is weak. To use this feature, touch **Wi-Fi preferences** below the network list in the Wi-Fi screen and switch on **Auto-switch to mobile network**. Additional charges may occur.

Connecting to Devices

Connecting to Bluetooth Devices

Bluetooth is a short-range wireless communication technology. Phones or other devices with Bluetooth capabilities can exchange information wirelessly within a distance of a few meters. The Bluetooth devices must be paired before the communication is performed.

1. Open **Settings** and touch **Connected devices**.
2. Touch **Pair new device**. Your phone automatically scans for and displays the IDs of all available Bluetooth devices in range.
3. Touch the device you want to pair with.
4. If necessary, confirm that the Bluetooth passkeys are the same between the two devices and touch **PAIR**. Alternatively, enter a Bluetooth passkey and touch **PAIR**.

Pairing is successfully completed when the other device accepts the connection or the same passkey is entered.



NOTE:

The Bluetooth passkey may be fixed for certain devices, such as headsets and hands-free car kits. You can try entering 0000 or 1234 (the most common passkeys), or refer to the documents for that device.

Connecting to Your Computer via USB

You can connect your phone to a computer with a USB cable and transfer music, pictures, and other files in both directions. Your phone stores these files in the phone storage or on a removable microSDXC card.

If you are using USB tethering, you must turn that off before you can use USB to transfer files between your phone and computer.

Connect Your Phone to a Computer via USB

1. Connect your phone to the computer with a USB cable.
2. The **Use USB for** options menu will automatically open, and you can choose one of the following options.
 - ▶ **File Transfer:** Transfer files on Windows[®] PC or Mac[®].
 - ▶ **PTP:** Transfer photos or files if File Transfer is not supported by your computer.
 - ▶ **Charge this device:** Charge your phone via USB.
 - ▶ **Install driver:** Install the driver needed for some USB connection modes (such as File Transfer). You only need to install the driver on the same PC once.

 **NOTE:**

You can also install the driver on PC by running the executable file in the new CD-ROM drive.

Disconnect Your Phone From the Computer

To disconnect the phone from the computer, simply unplug the

USB cable when you're finished.

Sharing Files With Nearby Devices

With Nearby Share, you can share photos, videos, and documents with nearby devices via Bluetooth or Wi-Fi.

Turn Sharing On or Off

1. On your phone, make sure Bluetooth, Wi-Fi, and Location are turned on. See [Connecting to Bluetooth Devices](#), [Connecting to Wi-Fi](#) and [Location](#).
2. Open **Settings** and touch **Connected devices > Connection preferences > Nearby Share**.
3. Touch the switch at the top to turn Nearby Share on or off.

Share Content With Someone

1. Open the content, like a photo or a message on your phone.
2. Find and touch the Share option and then select Nearby Share.
3. Touch **Turn on** if Nearby Share is switched off.
4. Hold your phone and your friend's device which supports the Nearby Share feature close to each other.



NOTE:

Make sure both devices are unlocked, and have Nearby Share, Wi-Fi, Bluetooth and location turned on.

5. If prompted, touch the Nearby Share notification on your friend's device to make that device visible to nearby devices.

6. On your phone, your friend's device name will appear and touch the device name to send the content.
7. Accept the sharing on your friend's device.

Get Content From Someone

1. Ask your friend to follow the "[Share Content With Someone](#)" steps above.
2. You'll get a notification that someone is sharing content with you. Touch the notification if you haven't set your phone visible to nearby devices.



NOTE:

Make sure both devices are unlocked, and have Nearby Share, Wi-Fi, Bluetooth and location turned on.

3. Touch **Accept** to get the content.

Choose Who Can Share Content With You

1. Open **Settings** and touch **Connected devices > Connection preferences > Nearby Share**.
2. Touch **Device visibility** and choose one of the following options.
 - ▶ **All Contacts:** Your phone is visible to your contacts while your phone screen is on and unlocked. You need to sign in to your Google account first.
 - ▶ **Some Contacts:** Your phone is visible to nearby contacts you choose while your phone screen is on and unlocked. You need to sign in to your Google account first.

- ▶ **Hidden:** When you get a notification that someone is sharing content, you can choose to make your phone visible manually in order for that device to find your phone.

Set Data Usage for Sharing

1. Open **Settings** and touch **Connected devices > Connection preferences > Nearby Share**.
2. Touch **Data** and choose one of the following options.
 - ▶ **Data:** Mobile data may be used for small files. Charges may apply.
 - ▶ **Wi-Fi only:** Never use mobile data to share.
 - ▶ **Without internet:** Files will always be shared offline.

Sharing Your Mobile Data Connection Through Tethering

You can use tethering to share your phone's Internet connection with a computer that connects to your phone by Bluetooth or via a USB cable.



NOTE:

You cannot transfer files between your phone and the computer when the phone is USB tethered.

1. Open **Settings** and touch **Network & internet > Hotspot & tethering**.
2. Switch on **USB tethering** or **Bluetooth tethering**.
 - ▶ For USB tethering, connect your phone to the computer with the supplied USB cable before touching **USB tethering**.
 - ▶ For Bluetooth tethering, pair your phone with the computer via Bluetooth and set the computer to obtain its network connection via Bluetooth.





NOTE:

To stop sharing your data connection, switch off **USB tethering** or **Bluetooth tethering**.

Phone Calls

Placing Calls

Place a Call by Dialing

1. From the home screen, touch .
2. Touch  to open the dialer and enter the phone number or the contact name with the dialpad. Touch  to delete incorrect digits.



NOTE:

As you enter the phone number or the contact name, your phone searches for matching information in your contacts. If you see the number and contact you want to call, touch it to get call, messaging, and history options.

3. Touch  below the keypad to dial a call.
4. If two nano-SIM cards are installed and there is no preferred card for phone calls, select the card you want to use for the call.





NOTE:

To make an international call, touch and hold the **0** key to enter the plus (+) symbol. Next, enter the country code, followed by the city/area code and then the phone number.

Place a Call From the Call History

The call history is a list of all the calls you've placed, received, or missed. It provides a convenient way to redial a number, return a call, or add a number to your contacts.

1. From the home screen, touch  >  (in the top search field) > **Call history**.



NOTE:

Touch **Missed** to find all missed calls.



2. Touch  next to a listing to call back.



NOTE:

You can also touch the contact icon in front of the listing to get more options for calling and texting.

Call Your Contacts

1. From the home screen, touch  > the  tab to view all your contacts.
2. Touch a contact and then touch the number to place a voice call, or touch  to start a Google Duo video call.

Answering or Rejecting Calls

Answer a Call

When you receive a phone call, slide  up to answer the call.

- or -

If the screen is unlocked, touch **ANSWER**.

 **NOTE:**

To silence the ringer before answering the call, press either end of the **Volume** key.

Reject a Call



When you receive a phone call, slide  down to reject the call. You can also touch **Reply** to reject the call and select a preset text message or edit one to send to the caller.





- or -

If the screen is unlocked, touch **DECLINE** to reject the call. You can also touch the caller number or name, and then touch **Reply** to reject the call and select a preset text message or edit one to send to the caller.

Using Options During a Call

During a call, you will see a number of on-screen options. Touch an option to select it.

- Touch  to turn on or off the speaker.
- Touch  to mute or unmute your microphone.
- Touch  to switch to the keypad when you need to enter a code (for example, the PIN for your voicemail or bank account) during the call.

- Touch  to put the call on hold.
- Touch  to make another call separately from the first call, which is put on hold.
- Touch  to merge the separate calls into a single conference call.
- Touch  to put the caller you are speaking to on hold, and switch to the other call that has been put on hold.
- Touch  to end the current call.



WARNING!

Because of higher volume levels, do not place the phone near your ear during speakerphone use.

Managing Multi-party Calls

When the call waiting and conference call features are available, you can switch between two calls or set up a conference call.





NOTE:

The call waiting and conference call features need network support and may result in additional charges. Please contact your service provider for more information.

Switch Between Current Calls

When you're on a call and another call comes in, your phone screen informs you and displays the caller ID.

To respond to an incoming call while you're on a call:





- Slide  up to answer the call. This puts the first caller on hold and answers the second call.
- Touch **Answer & end ongoing call** to answer the call. This ends the first call and answers the second call.
- Slide  down to reject the second call.
- Touch **Reply** to reject the second call and select a preset text message or edit one to send to the caller.

To switch between two calls:

Touch .

Set Up a Conference Call

With this feature, you can talk to multiple people at the same time.

1. Place the first call.
2. Once you have established the connection, answer an incoming call or touch  and dial the second number. This puts the first caller on hold.
3. When you're connected to the second party, touch .
4. If you need to add more parties, have them call you or touch  to dial the number, and touch  to merge the calls one by one.

**NOTE:**

The number of calls you can merge depends on your network. Contact your mobile service provider for more information.

If one of the people you called hangs up during the call, you and the remaining callers stay connected. If you initiated the call and are the first to hang up, all callers are disconnected.

To end the conference call, touch .

Contacts

You can add contacts on your phone and synchronize them with the contacts in your Google account or other accounts that support contact syncing.

To see your contacts, touch **Google** (folder) > **Contacts** from the home screen.

Adding a New Contact

1. Open **Contacts**.
2. Touch  to add a new contact.
3. Enter the contact name, phone numbers, email addresses, and other information. Touch **More fields** if necessary.
4. Touch **Save**.

Importing and Exporting Contacts

You can import contacts from your nano-SIM card, the phone storage or an installed microSDXC card, or export contacts to the phone storage or microSDXC card. This is especially useful when you need to transfer contacts between different devices.

Import Contacts From the nano-SIM Card



1. Open **Contacts**.
2. Touch  > **Settings** > **Import** > **SIM [card name]** > **OK**.

 **NOTE:**



For the single-SIM model or if only one nano-SIM card is installed, touch  > **Settings** > **Import** > **SIM card** > **OK**.

3. Check the contacts you need and then touch **Import**.

Import Contacts From the Phone Storage or the microSDXC Card

1. Open **Contacts**.
2. Touch  > **Settings** > **Import**.
3. Select **.vcf file** and touch **OK**.
4. Touch  and find the vCard file(s) on the phone storage or microSDXC card and touch one to import contacts.

Export Contacts to the Phone Storage or the microSDXC Card

1. Open **Contacts**.
2. Touch  > **Settings** > **Export**.
3. Touch  and select the directory in which the vCard file will be saved.
4. Edit the file name if needed and touch **SAVE** to create the file.



Setting a Ringtone for a Contact

Assign a special ringtone to a contact, so you know who is calling when you hear the ringtone.

1. Open **Contacts**.
2. Touch a contact you want to set a ringtone for and then touch  > **Set ringtone**.
3. Select a ringtone you like and touch **OK** or touch **Add ringtone** at the bottom to choose an audio file and set it as the ringtone.

Setting Call Blocking

The call blocking feature allows you to block calls and messages from certain numbers.

1. Open **Contacts**.
2. Touch  > **Settings** > **Blocked numbers**.
3. Touch **Add a number**.
4. Enter a phone number or touch  to select a number from the contact list.
5. Touch **Block**.







NOTES:



- You can also block calls from unidentified callers by switching on **Unknown** in the Blocked numbers screen.
- To unblock a number, touch  next to the number and touch **Unblock**.

Messages



You can use Messages to exchange text messages (SMS), multimedia messages (MMS), and chat messages.

Sending a Message

1. From the home screen, touch .
2. Touch **Start chat**.
3. Add recipients by one of the following ways.
 - ▶ Manually enter the recipient's number or contact name. (You can touch  to enter numbers with a dialpad.) If the phone presents a few suggestions, touch the one you want to add.
 - ▶ Select a recipient from your contact list.
 - ▶ To add more recipients for a group conversation, touch  to choose the recipients and then touch **Next**. You can edit the group name if necessary.
4. Touch the text box and enter the message text. You can touch  >  to add emoji to your text message.
5. If you want to send a multimedia message, touch  to add pictures, videos or voice recordings to the message.
6. For a multimedia message, touch and hold  to mark the message as urgent or add a message subject.



7. If two nano-SIM cards are available, you can also touch and hold  to choose the card for sending this message.
8. Touch .

NOTES:

- If you add two or more recipients, the message may be sent as a group MMS where everyone can reply and see each other's messages. For group message setting, touch  > **Settings > [nano-SIM card name] SIM > Group messaging** (if two nano-SIMs are installed) or  > **Settings > Advanced > Group messaging** (if only one nano-SIM card is installed) from the Messages screen.
- You can also include email addresses as recipients for a multimedia message.
- Do not add any attachment if you want to send a text message. Otherwise you may be charged for a multimedia message.

Message Options

On the Messages screen, touch and hold a thread and the following options are available.

- Touch  to archive the thread. You can touch  > **Archived** from the Messages screen to find all archived messages.
- Touch  > **Delete** to delete the thread.

- Touch  to add the new number in the thread to your contacts.
- Touch  > **OK** to block the contact or number in the thread, and the thread will be moved to “Spam & blocked.”
You can touch  > **Spam & blocked** from the Messages screen to find all blocked messages.



NOTE:

You can touch and hold a thread and touch more to select them, and then choose to archive or delete them.

Web Browser



Opening the Browser

Open the **Chrome** app to launch the web browser.

To open a web page or search the web:

1. Open **Chrome**.
2. Touch the address box at the top of the web page.
3. Enter the address (URL) of a web page or enter terms you want to search for. You can also touch  to search by voice.
4. Touch a URL or search suggestion or touch the enter key on the keyboard to open the web page or search results.

NOTE:

Touch  >  if you want to stop opening the page.

Using Multiple Browser Tabs

You can open several web pages at the same time (one page in each tab) and switch between them freely.

To open a new browser tab:

Touch  > **New tab**. A new browser tab opens.

To switch between tabs:

1. Touch  (the number shows how many tabs you have opened).
2. Swipe vertically to scroll through the list of opened tabs.
3. Touch the title of the tab you want to open.



NOTE:

Swipe a tab title left or right or touch its  to close the tab.

Changing Browser Settings

You can configure a number of settings to customize the way you browse the web, including options that you can use to control your privacy. To open the Chrome settings screen, touch

 > **Settings**.

Camera

Capturing a Photo

1. From the home screen, touch .
2. Aim the camera at the subject and make any necessary adjustments. Capture (auto camera) mode is used by default.



Number	Function
1	Change the HDR setting.
2	Change the flash setting.
3	Swipe left or right on the viewfinder area to change camera modes.
4	View pictures and videos you have taken.
5	Capture a picture.
6	Switch between the front and back cameras.
7	Swipe left or right to switch among the default Capture (auto camera) mode, Panorama mode, Burst mode, Pro mode, Video mode, and Time lapse mode. Touch More to use other special camera modes: Interval, Filter, QR code, Night, and DV Night.
8	Change the camera settings.
9	Enable beauty mode and customize its options to beautify faces in the picture.



WARNING!

Keep a safe distance when using the flash. Do not point the flash towards the eyes of people or animals.









NOTE:

You can spread or pinch on the screen to zoom in or out before taking pictures.

3. Lightly touch .

Recording a Video

1. From the home screen, touch .
2. Touch **Video**.
3. Aim the camera at the subject and make any necessary adjustments.
4. Touch  to start recording. You can touch  or  to pause or resume recording, or touch  to save the frame as a photo.
5. Touch  to stop recording.



NOTES:

- You can spread or pinch on the screen to zoom in or out before and during recording.
- You can record a silent video by turning off the microphone. Just touch  at the top and switch off **Microphone switch** before recording.

Using Pro Mode

You can use Pro mode to adjust more camera options for your photo such as ISO, white balance, exposure, etc.

1. Open the **Camera** app.

2. Touch **Pro**.
3. Aim the camera at the subject and you can make the following adjustments.
 - ▶ Touch the camera options at the bottom to adjust overall exposure, ISO, white balance, contrast and saturation.
 - ▶ Touch  at the top to adjust the metering setting.
4. Touch  to take the photo.

Using Other Camera Modes

Your camera app offers other powerful and interesting camera modes. Swipe left or right on the viewfinder screen to find them all.

- **Panorama:** Capture panoramic photos either horizontally or vertically.
- **Burst:** Touch and hold  to take a series of photos quickly.
- **Time lapse:** Record time lapse videos with the back camera. You can set the time interval between each frame in the camera settings.
- **Interval:** Take several pictures with the front camera automatically and save the selfie(s) you like. You can set the time interval between each picture in the camera settings.
- **Filter:** Select a color effect for the picture.

- **Qr code:** Read the QR code in the viewfinder screen. Or touch  at the top to open a picture and scan the QR code in it.
- **Night:** Capture pictures in low-light environment.
- **DV Night:** Record videos in low-light environment.



NOTE:

Some camera modes are only available for the back camera or the front camera.

Gallery

Opening Gallery

From the home screen, touch **Gallery** (Gallery Go). Gallery Go is an offline photo gallery, which you can use to edit, find, and manage photos without Internet. You can touch **Photos** to view all your photos and videos, or touch **Folders** to find photos and videos organized by folders.

Sharing Your Photos or Videos

1. Open **Gallery**.
2. Touch and hold a photo or video to select it.
3. Touch more items that you want to share.
4. Touch  and select how you want to share the items.

Deleting Unwanted Photos or Videos

1. Open **Gallery**.
2. Touch and hold a photo or video to select it.
3. Touch more items that you want to delete.
4. Touch  > **Delete** > **Delete**.

NOTE:

You cannot restore the deleted photos and videos.

FM Radio

Scanning for Channels





1. Plug in a wired headset and open the **FM Radio** app.
2. Touch  > **Scan**. Your phone scans for all available channels and saves them to the channel list.

NOTE:



When you open the **FM Radio** app for the first time, it will automatically scan for channels and show the channel list. You can also touch  > **All channels** to view the list.

Listening to FM Radio

1. Open **FM Radio** while the headset is connected.
2. Touch  > **All channels** and select a channel.

You can also drag the red line along the frequency panel or touch  or  to switch to other channels, or touch  or  to adjust the current channel frequency.







NOTES:

- Touch  to add the channel to favourites.
- Touch  to listen to the radio through the phone speaker.

Voice Recorder



Voice Recorder enables you to record and listen to voice memos.

Recording a Voice Memo





1. Open **Voice Recorder**.
2. Touch  to select the audio format of the recording.
3. Touch  to start recording. During recording, you can do the following:
 - ▶ Touch  or  to pause or continue the recording.
 - ▶ Touch  or  to add a time tag or photo tag to the recording.
 - ▶ Touch an added time tag to attach a picture or add text.
4. Touch **DONE** to stop recording.
5. Edit the file name and touch **SAVE** to save the recording. If you don't want to save the memo after recording it, touch **DELETE > DELETE** to delete it.

Playing a Voice Memo

1. Touch  at the top right of the screen to see all recordings.

2. Touch the title of a memo to play it. During the playing, you can touch  to change the playback speed, touch **View tag** to view all tags, touch  or  to add a time tag or photo tag, or touch and hold a tag to delete it.

Trimming a Voice Memo

1. While playing a recording, touch  to open the editing screen.
2. Drag  or  to trim the recording. You can touch  to preview the trimmed recording.
3. Touch **TRIM**.
4. Edit the new file name and touch **SAVE**.

Settings

The **Settings** app contains most of the tools for customizing and configuring your phone.

Network & Internet

Wi-Fi

Open **Settings** and touch **Network & internet > Wi-Fi**. You can turn Wi-Fi on or off and configure your Wi-Fi connections. See [Connecting to Wi-Fi](#).

Mobile Network

Open **Settings** and touch **Network & internet > Mobile network** to control mobile data, data roaming, check and manage mobile data use, set network type, VoLTE, and set access point names and other network options. If you have installed two nano-SIM cards on the dual-SIM model, you can also set the assigned name and color for each card, turn on or off a card, set the default card for calls/messages, and data use during calls. See [Connecting to Mobile Networks](#).



NOTE:

The data usage is measured by your phone, and your carrier's data usage accounting may differ.

Airplane Mode

Open **Settings** and touch **Network & internet > Airplane mode** to turn airplane mode on or off. All the phone's radios that transmit voice or data are turned off when airplane mode is on.

Hotspot & Tethering

Open **Settings** and touch **Network & internet > Hotspot & tethering** to share your phone's mobile data connection with PCs or other devices. See [Sharing Your Mobile Data Connection Through Tethering](#).

Data Saver

Open **Settings** and touch **Network & internet > Data Saver** to enable or disable Data Saver, which prevents apps from using data connection in the background. Apps you're currently using can access data, but may do so less frequently when Data Saver is enabled. You can touch **Unrestricted data** to allow some apps to always have data connection access, even when Data Saver is enabled.

VPN

Open **Settings** and touch **Network & internet > Advanced > VPN** to set up and connect to virtual private networks.

Private DNS

To get information from a website, your phone first asks where

the website is. Private DNS is a way to help secure these questions and answers.

By default, your phone uses Private DNS with all networks that can use Private DNS. We recommend keeping Private DNS turned on.

Open **Settings** and touch **Network & internet > Advanced > Private DNS** to turn Private DNS on or off, or change its settings.

Connected Devices

Open **Settings** and touch **Connected devices > Connection preferences** to use the following features.

- **Bluetooth:** Turn Bluetooth on or off and configure your Bluetooth connections. See [Connecting to Bluetooth Devices](#).
- **Printing:** Use the default printing service or other printer plug-ins installed from the Google Play Store or your printer manufacturer for wireless printing.
- **Files received via Bluetooth:** Check records of files received via Bluetooth.
- **Nearby Share:** Use Bluetooth or Wi-Fi to share contents with other devices near your phone. See [Sharing Files With Nearby Devices](#).

Apps & Notifications

App Info

Open **Settings** and touch **Apps & notifications**. View recently opened apps at the top or touch **SEE ALL [number] APPS** to see all apps installed on your phone and manage them. Touch an app to see its information and configure the available options.

Conversations

Open **Settings** and touch **Apps & notifications > Conversations** to check your priority and modified conversations in the Messages app and change conversation settings. Once you mark a conversation as priority by touching and holding it on the notification panel, or make any other changes to a conversation, it will appear in this menu.

Notifications

Open **Settings** and touch **Apps & notifications > Notifications** to manage app notifications.

Screen Time

Open **Settings** and touch **Apps & notifications > Screen time** to find out how much time you spend on apps and set the total time per day that you can use an app. When you reach your limit, the app closes and its icon dims.

Default Apps

Open **Settings** and touch **Apps & notifications > Advanced > Default apps** to select the default app for voice assistant and input, web browsing, phone calling, messaging, etc. Touch **Opening links** to set Instant apps options, or touch an installed app to check its supported links and set whether to open the links in the app, and clear the app's defaults.

Permission Manager

Open **Settings** and touch **Apps & notifications > Advanced > Permission manager** to check what apps have been allowed to access certain permissions. You can also change the app permissions.



WARNING!

Changing the app permissions may result in the app not working correctly or as originally intended.

Wireless Emergency Alerts

Open **Settings** and touch **Apps & notifications > Advanced > Wireless emergency alerts** to enable/disable emergency alerts such as AMBER alerts and Extreme threats and set alert preferences.

Special App Access

Open **Settings** and touch **Apps & notifications > Advanced > Special app access** to set special access options of apps.

Battery

Open **Settings** and touch **Battery** to view the battery level, enable different battery saving modes, check what has been using the battery, and manage apps intelligently or set more options to improve battery life.

Features

Open **Settings** and touch **Features**. The following features are available.

- **System navigation:** Set the navigation style as virtual navigation or gesture navigation. See [Setting the Navigation Style](#).
- **Scheduled power On/Off:** Set the day and time when the phone automatically powers on or off.

Display

Open **Settings** and touch **Display** to configure the display options, including brightness level, Dark theme, wallpapers, screen sleep time, auto-rotate screen, font size, lock screen options, etc.

Sound

Open **Settings** and touch **Sound**. Adjust different types of

volume, toggle sound mode (see [Switching to Vibration or Silent Mode](#)), set Do Not Disturb options (see [Using Do Not Disturb Mode](#)), set up ringtone, notification and alarm sound, and set other sounds and vibrations.

Storage

Open **Settings** and touch **Storage** to view the memory information of the internal phone storage and the microSDXC card (if one is installed).

- **Saving location:** When a microSDXC card is installed, you can select **Phone** or **SD card** as the default location for new data.
- **Internal shared storage:** Get a detailed breakdown of space usage by type.
- **PORTABLE STORAGE:** Safely mount, unmount (eject), and format your microSDXC card. If you need to store large applications, games, and their data in your microSDXC card, you can format the card and use it as part of the device storage.

Privacy

Open **Settings** and touch **Privacy** to configure the privacy settings.

- **Permission manager:** Check what apps have been allowed to access certain permissions. You can also change the app permissions.



WARNING!

Changing the app permissions may result in the app not working correctly or as originally intended.

- **Show passwords:** Display passwords as you enter them.
- **Notifications on lock screen:** Choose what notification contents will be shown on the lock screen.
- **Autofill service from Google:** Set the options of Autofill with Google. With a single touch, you can fill in passwords, addresses, credit cards, and other information saved to your Google account.
- **Advanced:** Set advanced options such as Google location history, activity controls, Ads personalization, and usage & diagnostics.

Location

Open **Settings** and touch **Location** to manage location services, which help your phone and apps determine your location. To use location-related applications, such as finding your location on Google Maps, you must have location services enabled on your phone.

Security

Open **Settings** and touch **Security** to configure options that help keep your phone and data safe. Touch **Advanced** if necessary.

- **Google Play Protect:** Google Play Protect regularly checks your apps and phone for harmful behaviour and warns you about any detected potential harm.
- **Find My Device:** Use Find My Device to locate, lock, or wipe your lost device remotely. The lost device must be signed in to a Google account.
- **Security update:** Check for security update of your system.
- **Screen lock:** Disable the screen lock or enable it with swipe, pattern, PIN, or password. See [Protecting Your Phone With Screen Locks](#).

Touch  beside **Screen lock** to set its options.

- **Smart Lock:** Keep the phone unlocked when connected to trusted devices, in trusted places, or unlocked when your phone is being carried on the body.

 **NOTE:**

You need to sign in to your Google account on the phone to use all the **Smart Lock** features.

- **Device admin apps:** View or deactivate apps you have authorized to be device administrators.
- **SIM card lock:**
 - ▶ **Lock SIM card:** Activate or deactivate the PIN lock to require the PIN before accessing the nano-SIM card.
 - ▶ **Change SIM PIN:** Change the PIN used to access the nano-SIM card.

 **NOTE:**

Put all your confidential passwords in a safe place for future use. If you enter the wrong SIM PIN more times than allowed, your nano-SIM card will be locked and you cannot access the mobile phone network. Contact your operator for a PIN Unlock Key (PUK) to restore the nano-SIM card.

- **Encryption & credentials:** Check the encryption status of your phone and set the credential storage options.
- **Trust agents:** View or deactivate trust agents.
- **App pinning:** Pin an app's screen to keep it in view until you unpin it. This feature can be used, for example, to let a trusted friend play a specific game. See [Protecting Your Phone With App Pinning](#).

Accounts

Open **Settings** and touch **Accounts** to manage your accounts and synchronization. Touch **Add account** to sign in to or create accounts on your phone. Touch an account you have added to adjust its settings.

Accessibility

Open **Settings** and touch **Accessibility** to configure accessibility options and services on your phone, such as using **Color correction** or **Display size** for users with sight problems.

Digital Wellbeing & Parental Controls

Open **Settings** and touch **Digital Wellbeing & parental controls** to get information about how you spend time on your phone, like how often you unlock it and how long you use each app. You can use that information to improve your digital wellbeing. You can also help your child balance their screen time with the Family Link app.

- Touch **Show your data** to get information on how you spend time on your phone and apps.
 - ▶ **Dashboard:** Check the screen time, number of notifications, and opened times of each app. You can set daily timers for the most-used apps to avoid indulgence (see [Screen Time](#).)
 - ▶ **Focus mode:** Select distracting apps and turn on focus mode to pause these apps when you need time to focus.
 - ▶ **REDUCE INTERRUPTIONS:** Manage app notifications and Do Not Disturb settings to reduce interruptions from your important tasks.
 - ▶ **Show icon in the app list:** Display or hide the Digital Wellbeing app in the app list.
- In the Parental controls section, touch **Set up parental controls** to add content restrictions and set other limits for your child with the Family Link app.

Google

Open **Settings** and touch **Google** to manage settings for

Google apps and services.

System

Languages & Input

Open **Settings** and touch **System > Languages & input** to configure options related to system language, input methods and assistance, speech output, mouse/trackpad input, and vibration redirection.

Date & Time

Open **Settings** and touch **System > Date & time** to set date, time, time zone, and the time format. You can also use network-provided data.

Downloads

Open **Settings** and touch **System > Downloads** to view and manage your downloaded files.

Backup

Open **Settings** and touch **System > Backup** to manage data backup options. To easily restore or switch phones at any time, you can enable automatic backup to Google Drive of important data. You need to sign in to your Google account to use this feature.

Reset Options

Open **Settings** and touch **System > Advanced > Reset options** to reset network settings, app preferences, or the phone to factory default status.

System Update



Open **Settings** and touch **System > Advanced > System update** to check for system updates and install them when they become available.





About Phone

Open **Settings** and touch **About phone** to view phone information, nano-SIM card status, legal information, and other information. You can also touch **Emergency information** to edit your medical information and emergency contacts for first responders to read from your lock screen.

For Your Safety

General Safety

	Don't make or receive phone calls while driving. Never text while driving.
	Keep your phone at least 15 mm away from your body while making calls.
	Small parts may cause choking.
	Your phone can produce a loud sound.
	To prevent possible hearing damage, do not listen at high volume levels for long periods. Exercise caution when holding your phone near your ear while the loudspeaker is in use.
	Avoid contact with anything magnetic.
	Keep away from pacemakers and other electronic medical devices.
	Turn off when asked to in hospitals and medical facilities.

	Turn off when told to on aircraft and at airports.
	Turn off when near explosive materials or liquids.
	Don't use at gas stations.
	Your phone may produce a bright or flashing light.
	Don't dispose of your phone in fire.
	Avoid extreme temperatures.
	Avoid contact with liquids. Keep your phone dry.
	Do not attempt to disassemble your phone.
	Only use approved accessories.
	Don't rely on your phone as a primary device for emergency communications.

FCC RF Exposure Information (SAR)

This phone is designed and manufactured not to exceed the emission limits for exposure to radio frequency (RF) energy set by the Federal Communications Commission of the United States.

During SAR testing, this device was set to transmit at its highest certified power level in all tested frequency bands, and placed in positions that simulate RF exposure in usage against the head with no separation, and near the body with the separation of 15 mm. Although the SAR is determined at the highest certified power level, the actual SAR level of the device while operating can be well below the maximum value. This is because the phone is designed to operate at multiple power levels so as to use only the power required to reach the network. In general, the closer you are to a wireless base station antenna, the lower the power output.

The exposure standard for wireless devices employing a unit of measurement is known as the Specific Absorption Rate, or SAR. The SAR limit set by the FCC is 1.6 W/kg.

This device is complied with SAR for general population/uncontrolled exposure limits in ANSI/IEEE C95.1-1992 and had been tested in accordance with the measurement methods and procedures specified in IEEE1528.

The FCC has granted an Equipment Authorization for this model phone with all reported SAR levels evaluated as in compliance with the FCC RF exposure guidelines. SAR information on this model phone is on file with the FCC and can

be found under the Display Grant section of www.fcc.gov/oet/ea/fccid after searching on **FCC ID: SRQ-ZTEA31LITE**. The FCC ID also can be found on the device when you swipe on the home screen and touch **Settings > About phone > FCC ID**.

For this device, the highest reported SAR value for usage against the head is **0.779 W/kg**, and for usage near the body is **1.411 W/kg**.

While there may be differences between the SAR levels of various phones and at various positions, they all meet the government requirements.

SAR compliance for body-worn operation is based on a separation distance of 10 mm between the unit and the human body. Carry this device at least 10 mm away from your body to ensure RF exposure level compliant or lower to the reported level. To support body-worn operation, choose the belt clips or holsters, which do not contain metallic components, to maintain a separation of 10 mm between this device and your body.

RF exposure compliance with any body-worn accessory that contains metal was not tested and certified, and use of such body-worn accessory should be avoided.

FCC Regulations

This device complies with part 15 of the FCC Rules. Operation is subject to the following two conditions: (1) This device may not cause harmful interference, and (2) this device must accept any interference received, including interference that may

cause undesired operation.

This equipment has been tested and found to comply with the limits for a Class B digital device, pursuant to part 15 of the FCC Rules. These limits are designed to provide reasonable protection against harmful interference in a residential installation. This equipment generates, uses and can radiate radio frequency energy and, if not installed and used in accordance with the instructions, may cause harmful interference to radio communications. However, there is no guarantee that interference will not occur in a particular installation. If this equipment does cause harmful interference to radio or television reception, which can be determined by turning the equipment off and on, the user is encouraged to try to correct the interference by one or more of the following measures:

- Reorient or relocate the receiving antenna.
- Increase the separation between the equipment and receiver.
- Connect the equipment into an outlet on a circuit different from that to which the receiver is connected.
- Consult the dealer or an experienced radio/TV technician for help.

! **CAUTION:**

Changes or modifications not expressly approved by the manufacturer could void the user's authority to operate the equipment.

The antenna(s) used for this transmitter must not be co-located or operating in conjunction with any other antenna or transmitter.

Distractions

Driving

Full attention must be given to driving at all times in order to reduce the risk of an accident. Using a phone while driving (even with a hands-free kit) can cause distraction and lead to an accident. You must comply with local laws and regulations restricting the use of wireless devices while driving.

Operating Machinery

Full attention must be given to operating the machinery in order to reduce the risk of an accident.

Product Handling

General Statement on Handling and Use

You alone are responsible for how you use your phone and any consequences of its use.

You must always switch off your phone wherever the use of a phone is prohibited. Use of your phone is subject to safety measures designed to protect users and their environment.

- Always treat your phone and its accessories with care and

keep them in a clean place.

- Keep the screen and camera lens clean. An unclean screen or camera lens may slow down the phone's reaction to your operations or interfere with the image quality.
- Clean your phone and its accessories with a soft material such as cleaning cloth for eyeglass lenses. Do not use alcohol or other corrosive substances for cleaning or allow them to get inside.
- Do not expose your phone or its accessories to open flames or lit tobacco products.
- Do not expose your phone or its accessories to liquid, moisture or high humidity.
- Do not drop, throw or try to bend your phone or its accessories.
- Do not use harsh chemicals, cleaning solvents, or aerosols to clean the phone or its accessories.
- Do not paint your phone or its accessories.
- Do not attempt to disassemble your phone or its accessories. Only authorized personnel can do so.
- Do not place your phone inside or near heating equipment or high-pressure containers, such as water heaters, microwave ovens, or hot cooking utensils. Otherwise, your phone may be damaged.
- Please check local regulations for disposal of electronic products.

- Do not carry your phone in your back pocket as it could break when you sit down.

Battery Safety Information

- Using ZTE-unapproved or incompatible battery, charger or power adapter may damage your device, shorten its lifespan or cause a fire, explosion or other hazards.
- The recommended operating temperatures are 0 °C to 35 °C and the storage temperatures are -20 °C to +45 °C. Extreme temperatures can damage the device and reduce the charging capacity and lifespan of your device and battery.
- Do not place the device or the battery in or near heating equipment, such as microwave ovens, stoves or radiators. Keep the device and the battery away from excessive heat and direct sunlight. If not, the device or the battery may overheat and cause explosion or fire.
- Please disconnect the charger when the battery is fully charged. Overcharging may shorten the battery life.
- Do not short-circuit the battery, as this can cause excessive heat and fire.
- Do not throw the battery into a fire to avoid explosion.
- Do not disassemble, squeeze or puncture the battery, as this can cause explosion or fire.
- When not using the battery for a long period, please charge the battery about half then remove the battery from your device and store it in a cool dry place.

- If the battery damages or shows signs of swelling or leakage, please stop use immediately and contact ZTE or ZTE authorized service provider for replacement.
- Return the worn-out battery to the provider or put it in the designated recycle place. Do not put it in household waste.
- There is a risk of explosion if the wrong battery model is replaced.



WARNING!

If the battery is broken, you should avoid contact with the contents inside. If they contaminate the skin, immediately rinse with plenty of water and seek medical help when necessary.

Small Children

Do not leave your phone and its accessories within the reach of small children or allow them to play with it. They could hurt themselves or others, or could accidentally damage the phone.

Your phone contains small parts with sharp edges that may cause an injury or may become detached and create a choking hazard.

Demagnetization

To avoid the risk of demagnetization, do not allow electronic devices or magnetic media close to your phone for a long time.

Electrostatic Discharge (ESD)

Do not touch the metallic connectors of the nano-SIM card and

the microSDXC card

Antenna

Do not touch the antenna unnecessarily.

Normal Use Position

When placing or receiving a phone call, hold your phone to your ear, with the bottom towards your mouth.

Airbags

Do not place a phone in the area over an airbag or in the airbag deployment area, as an airbag inflates with great force and serious injury could result. Store the phone in a safe and secure area before driving your vehicle.

Seizures/Blackouts

Your phone can produce a bright or flashing light. A small percentage of people may be susceptible to blackouts or seizures (even if they have never had one before) when exposed to flashing lights or light patterns such as when playing games or watching videos. If you have experienced seizures or blackouts or have a family history of such occurrences, please consult a physician. To reduce the risk of blackouts or seizures, use your phone in a well-lit room and take frequent breaks.

Repetitive Strain Injuries

To minimize the risk of Repetitive Strain Injury (RSI) when texting or playing games with your phone:

- Do not grip the phone too tightly.
- Press the buttons lightly.
- Use the special features which are designed to minimize the times of pressing buttons, such as Message Templates and Predictive Text.
- Take frequent breaks to stretch and relax.

Emergency Calls

This phone, like any other wireless phone, operates using radio signals, which cannot guarantee connection in all conditions. Therefore, you must never rely solely on any wireless phone for emergency communications.

Loud Noise

This phone is capable of producing loud noises, which may damage your hearing. Turn down the volume before using headphones, Bluetooth headsets or other audio devices.

Phone Heating

Your phone may become warm during charging and during normal use.

Electrical Safety

Accessories

Use only approved accessories.

Do not connect with incompatible products or accessories.

Take care not to allow metal objects, such as coins or key rings, to contact or short-circuit the charging jack and battery terminals. Never puncture the surface of the phone with sharp objects.

Connection to Vehicles

Seek professional advice when connecting a phone interface to the vehicle electrical system.

Faulty and Damaged Products

Do not attempt to disassemble the phone or its accessories. Only qualified personnel can service or repair the phone or its accessories. If your phone (or its accessories) has been submerged in water, punctured, or subjected to a severe fall, do not use it until you have taken it to be checked at an authorized service center.

Radio Frequency Interference

General Statement on Interference

Care must be taken when using your phone in close proximity to

personal medical devices, such as pacemakers and hearing aids. Please consult your doctor and the device manufacturers to determine if the operation of your phone may interfere with the operation of your medical devices.

Pacemakers

Pacemaker manufacturers recommend that a minimum separation of 15 cm be maintained between a mobile phone and a pacemaker to avoid potential interference with the pacemaker. To achieve this, use the phone on the opposite ear to your pacemaker and do not carry it in a breast pocket.

Hearing Aids

People with hearing aids or other cochlear implants may experience interfering noises when using wireless devices or when one is nearby.

The level of interference depends on the type of the hearing device and the distance from the interference source. Increasing the separation between them may reduce the interference. You may also consult your hearing aid manufacturer to discuss alternatives.

Medical Equipment

Switch off your wireless device when you are requested to do so in hospitals, clinics or healthcare facilities. These requests are designed to prevent possible interference with sensitive medical equipment.

Aircraft

Switch off your wireless device whenever you are instructed to do so by airport or airline staff.

Consult the airline staff about the use of wireless devices onboard the aircraft and enable airplane mode of your phone when boarding an aircraft.

Interference in Vehicles

Please note that because of possible interference with electronic equipment, some vehicle manufacturers forbid the use of mobile phones in their vehicles unless a hands-free kit with an external antenna is included in the installation.

Explosive Environments

Gas Stations and Explosive Atmospheres

In locations with potentially explosive atmospheres, obey all posted signs to turn off wireless devices such as your phone or other radio equipment.

Areas with potentially explosive atmospheres include fueling areas, below decks on boats, fuel or chemical transfer or storage facilities, and areas where the air contains chemicals or particles, such as grain, dust, or metal powders.

Blasting Caps and Areas

Power off your mobile phone or wireless device when in a blasting area or in areas where signs are posted to power off “two-way radios” or “electronic devices” to avoid interfering with blasting operations.