



Questo manuale d'istruzione è fornito da trovaprezzi.it. Scopri tutte le offerte per [Epos H3 Nero](#) o cerca il tuo prodotto tra le [migliori offerte di Cuffie e Microfoni](#)



Questo manuale d'istruzione è fornito da trovaprezzi.it. Scopri tutte le offerte per [Epos H3](#) o cerca il tuo prodotto tra le [migliori offerte di Cuffie e Microfoni](#)

# EPOS

## H3

Gaming headset

- EN Quick Guide
- DE Kurzanleitung
- FR Guide rapide
- IT Guida rapida
- ES Guía rápida
- PT Guia Rápida
- NL Snelle gids
- EL Γρήγορος οδηγός
- DA Hurtig vejledning
- SV Snabbguide
- FI Pikaopas
- PL Skrócona instrukcja obsługi
- RU Краткое руководство
- ZH 快速指南
- TW 快速指南
- TR Hızlı Rehber
- JA クイックガイド
- ID Panduan Ringkas
- KO 빠른 설명서

Model: SCWH19

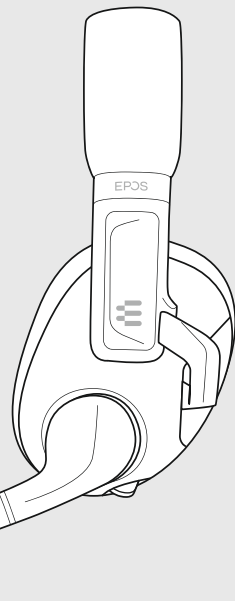

Package contents | Lieferumfang | Contenu de l'emballage |  
 Contenido della confezione | Contenido de la caja | Conteúdos da  
 embalagem | Inhoud van pakket | Περιεχόμενα συσκευασίας |  
 Pakkens indhold | Förpackningens innehåll | Pakkaksen sisältö |  
 Zawartość opakowania | Состав комплекта | 包装内容 | 包装内容 |  
 Paket içeriği | 패키지 내용 | Daftar isi paket | 패키지 내용물

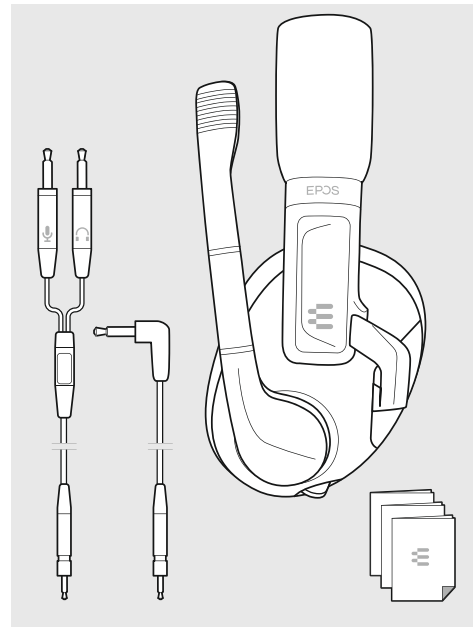

Connecting the headset | Headset anschließen | Connexion du micro-casque | Collegare le cuffie | Conexión de los auriculares |  
 Ligar o auscultador | De headset aansluiten | Σύνδεση ακουστικών | Tíslutning af headsettet | Ansluta headsetet | Kuulokkeiden liittäminen |  
 Podłączanie zestawu słuchawkowego | Подключение гарнитуры | 连接耳机 | 连接耳机 | Kulaklıği bağlama | ヘッドセットの接続 |  
 Menghubungkan headset | 헤드셋 연결

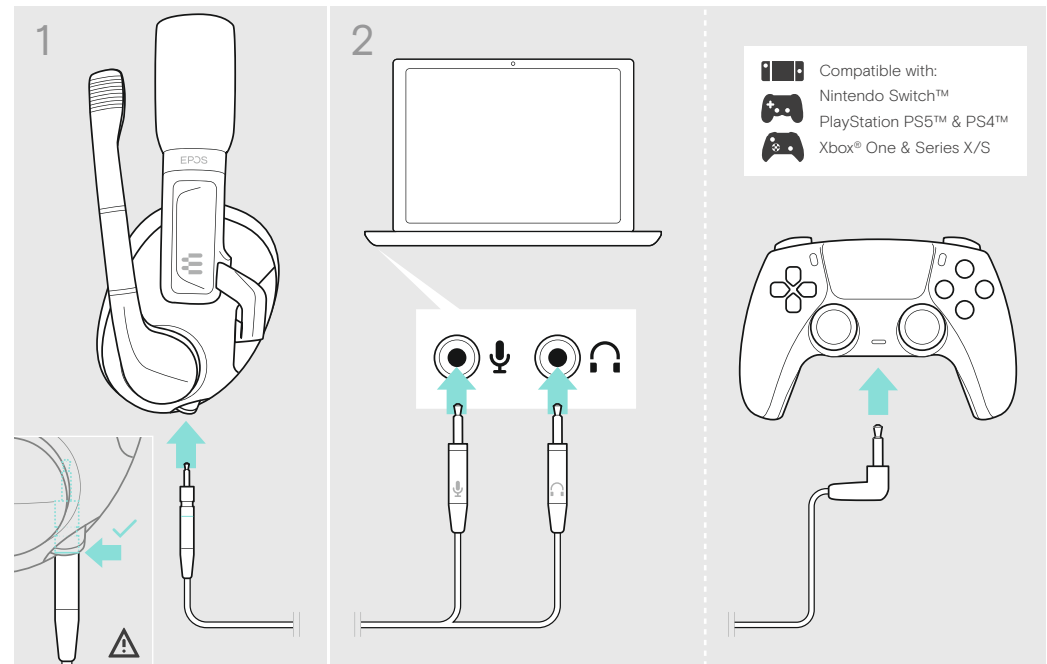

Adjusting and wearing the headset | Réglage et port du micro-casque | Regolazione e uso delle cuffie | Cómo ajustar y llevar el auricular |  
 Ajustar e usar o auscultador | De headset aanpassen en dragen | Προσαρμογή και εφαρμογή ακουστικών | Sådan justeres og bæres headsettet |  
 Anpassa och bär headsettet | Kuulokkeiden säätäminen ja käyttäminen | Regulacja i noszenie zestawu słuchawkowego |  
 Настройка и ношение гарнитуры | 调整并佩戴耳机 | 調整與配戴耳機 | Kulaklıği ayarlama ve takma | ヘッドセットの調整と装着 |  
 Menyesuaikan dan memakai headset | 헤드셋 조정 및 착용

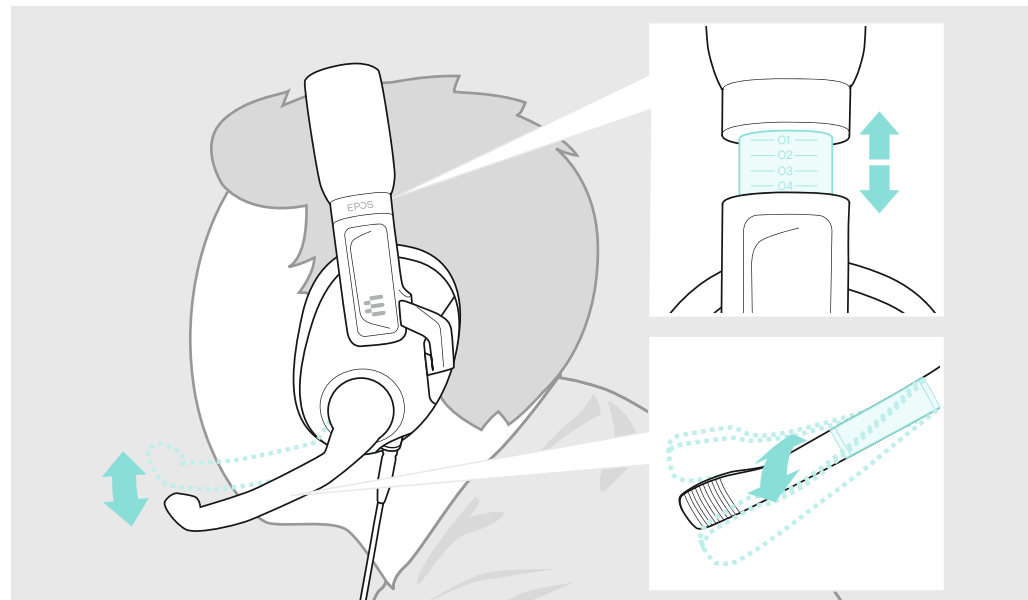

Adjusting the volume | Lautstärke einstellen | Réglage du volume |  
 Regulazione del volume | Ajuste del volumen | Ajustar o volume |  
 Het volume aanpassen | Ρύθμιση έντασης | Justering af  
 lydstyrken | Justera volymen | Äänenvoimakkuuden säätö |  
 Regulacja głośności | Регулировка громкости | 调节音量 |  
 調整音量 | Ses seviyesini ayarlama | 音量の調整 |  
 Menyesuaikan volume | 볼륨 조절

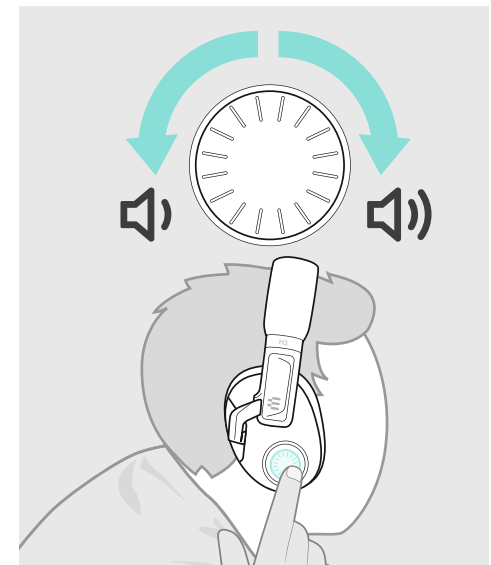

For FAQs & support:

▶ Contact our product service support:  
[www.eposaudio.com/gaming/support](http://www.eposaudio.com/gaming/support)

For further information & tutorials:

▶ Visit our website:

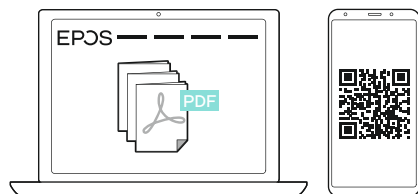

[www.eposaudio.com/gaming/downloads](http://www.eposaudio.com/gaming/downloads)

DSEA A/S

Kongebakken 9, DK-2765 Smørum, Denmark  
[www.eposaudio.com](http://www.eposaudio.com)

Printed in China, Publ. 02/21, 770-00338/A01

**Muting the microphone** | Mikrofon stummschalten | Désactivation du micro | Disattivazione del microfono | Silenciamento del micrófono | Silenciar o microfone | De microfoon dempen | Σίγαση μικροφώνου | Afbrødelse af mikrofonen | Stäng av mikrofonen | Mikrofonin mykistämnen | Wyciszenie mikrofonu | Выключение микрофона | 将麦克风静音 | 麥克風靜音 | Mikrofonu sessize alma | マイクをミュートにする | Membisukan mikrofon | 마이크 음소거

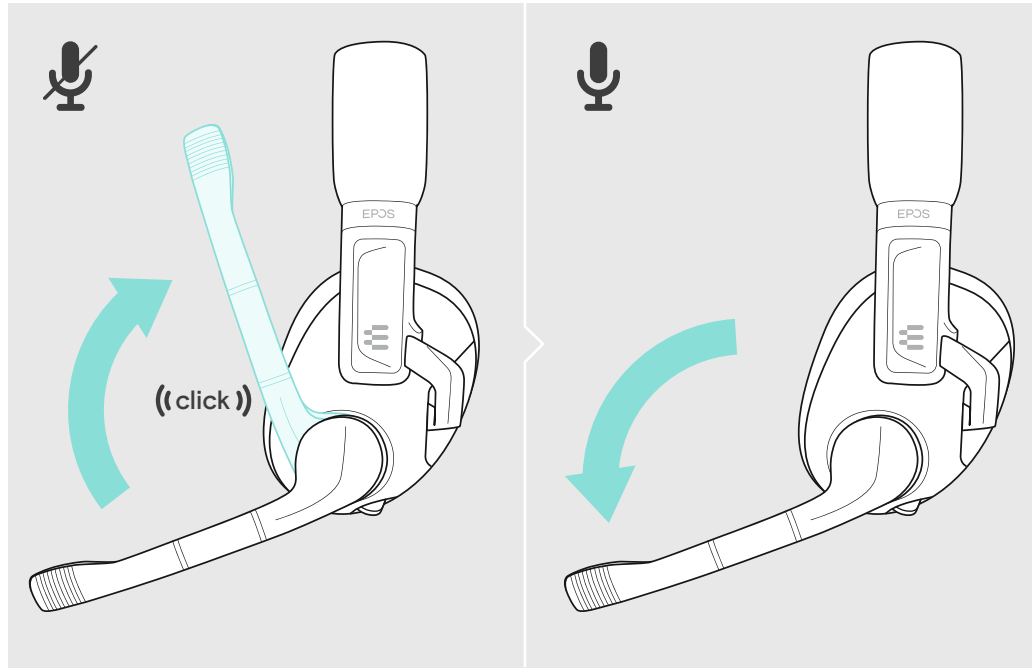

**Replacing the ear pads** | Ohrpolster austauschen | Remplacer les coussinets d'oreille | Sostituzione dei cuscinetti auricolari | Sustitución de las almohadillas | Substituir as almofadas | De oorkussentjes vervangen | Αντικατάσταση μαξιλαράκιών ακουστικών | Udsiftit ørepuderne | Byte av öronkuddar | Korvarehmusteiden vaihtaminen | Wymiana poduszek sluchawek | Замена амбушюр наушников | 更換耳墊 | 更換耳墊 | Kulaklık yastıklarını değiştirme | イヤーパッドの交換 | Mengganti earpad | 이어패드 교체

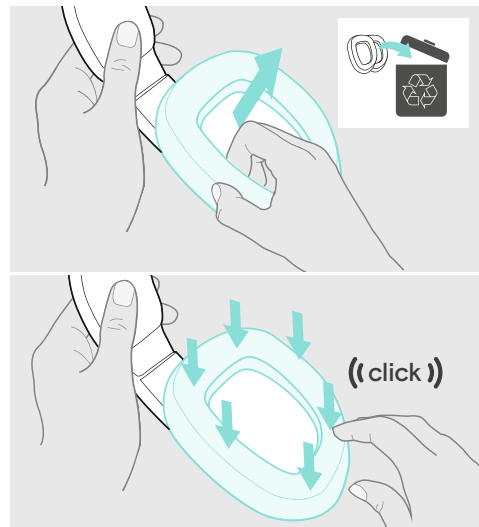

**Cleaning the product** | Produkt reinigen | Nettoyage du produit | Pulizia del prodotto | Limpieza del producto | Limpar o produto | Het product reinigen | Καθαρισμός προϊόντος | Rengøring af produktet | Rengöring av apparaten | Tuotteen puhdistaminen | Czyszczenie produktu | Очистка изделия | 清洁产品 | 清潔產品 | Ürünü temizleme | 製品のお手入れ | Membersihkan produk | 제품 청소

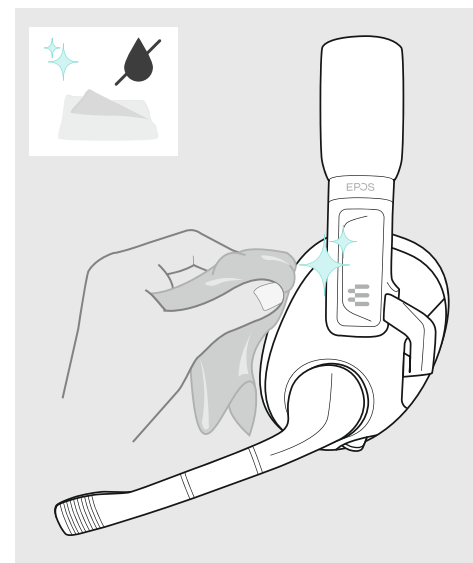

**Accessories** | Erhältliches Zubehör | Accessoires | Accessori | Accesorios | Acessórios | Accessoires | Παρελκόμενα | Tillbehør | Tillbehör | Tarvikkeet | Akcesoria | Аксессуары | 配件 | 配件 | Aksuarlar | アクセサリー | Aksesori | 액세서리

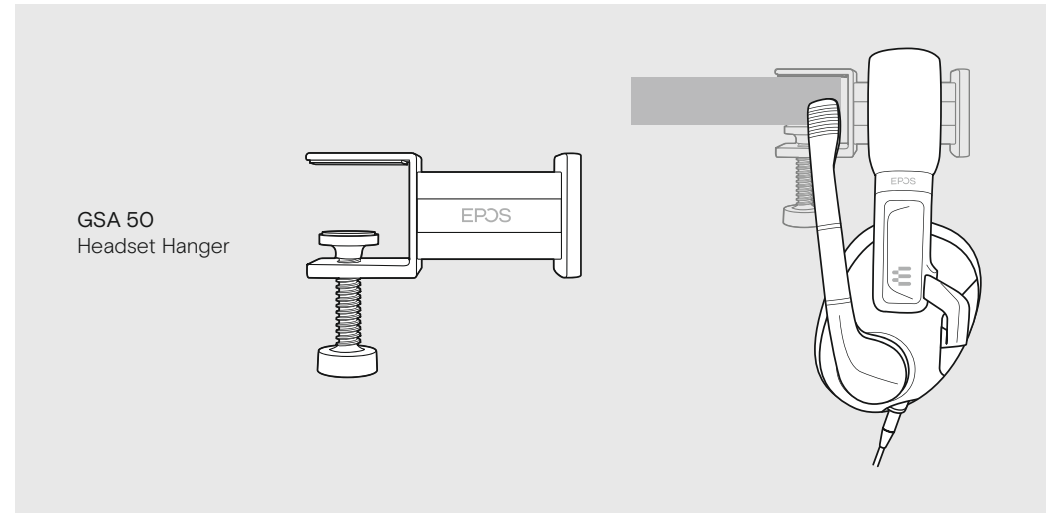

GSA 50  
Headset Hanger

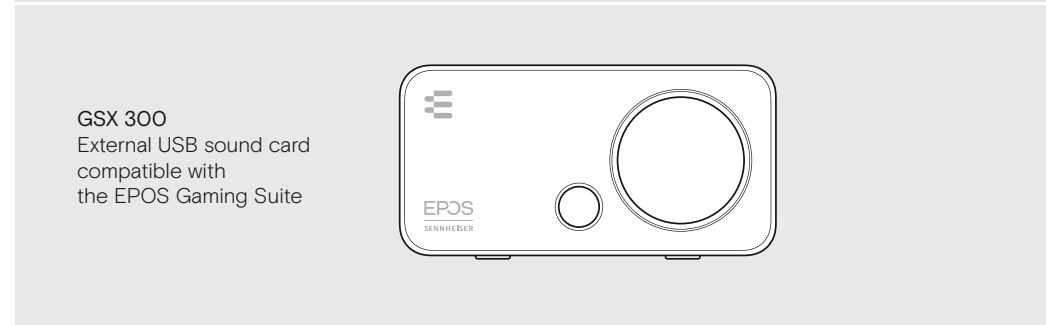

GSX 300  
External USB sound card  
compatible with  
the EPOS Gaming Suite

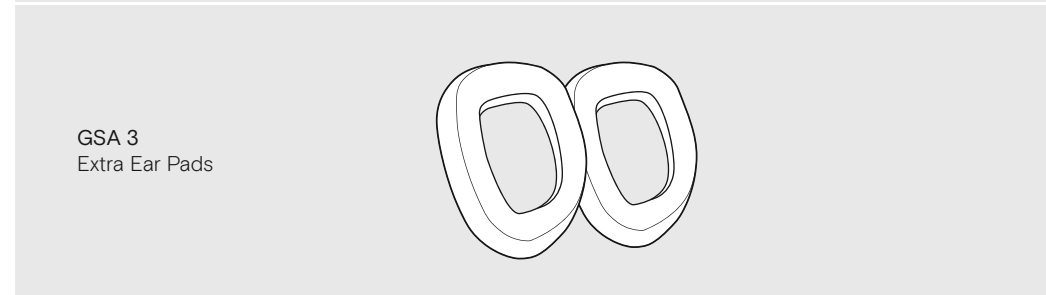

GSA 3  
Extra Ear Pads

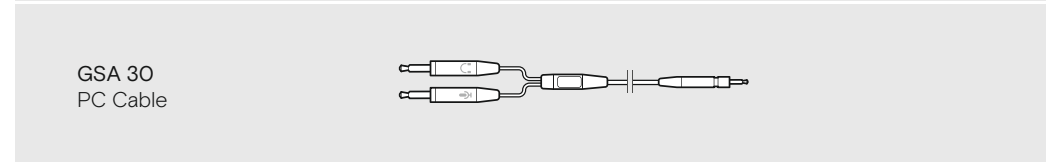

GSA 30  
PC Cable

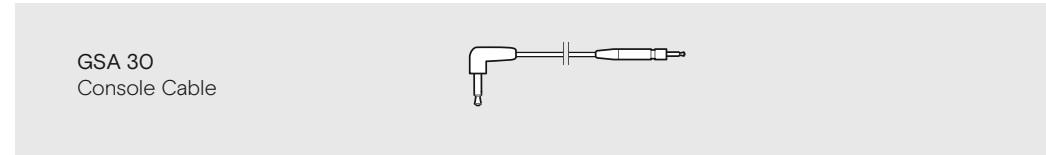

GSA 30  
Console Cable