

Fellowes

SafeCut™ Rotary Trimmers

Neutron™ / Neutron™ Plus

Proton™

Electron™

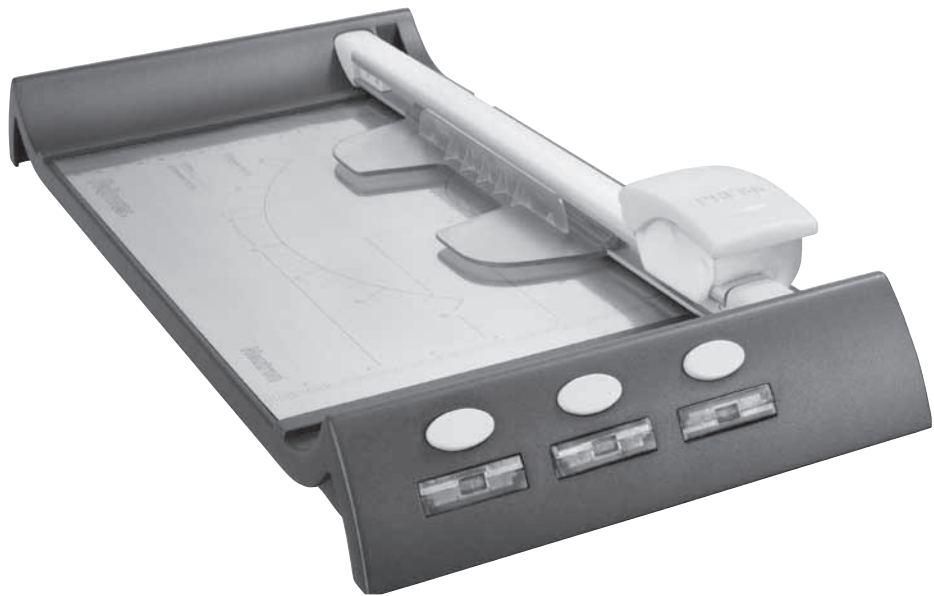

Please read these instructions before use.
Do not discard: keep for future reference.

Lire ces instructions avant utilisation.
Ne pas jeter : conserver pour référence ultérieure.

Lea estas instrucciones antes de usarlo.
No las deseche: guárdelas para tenerlas como referencia.

Diese Anleitungen vor Gebrauch genau durchlesen.
Bitte nicht entsorgen: Zur späteren Bezugnahme aufheben.

Prima dell'uso, si raccomanda di leggere questo manuale di istruzioni.
Conservare il manuale per consultarlo secondo le necessità.

Deze instructies voor gebruik lezen.
Niet weggoeien, maar bewaren om later te kunnen raadplegen.

Läs dessa anvisningar innan du använder apparaten.
Släng inte bort, behåll för framtida bruk.

Læs venligst denne vejledning før anvendelse.
Bør ikke bortskaffes. Behold for fremtidig henvisning.

Lue nämä ohjeet ennen käyttöä.
Älä hävitä: säilytä myöhempää käyttöä varten.

Vennligst les nøye igjennom denne bruksanvisningen før bruk.
Ikke kast den: Ta vare på den for senere referanse.

Przed użyciem proszę zapoznać się z tą instrukcją.
Nie wyrzucać - zachować jako źródło informacji na przyszłość

Перед началом эксплуатации обязательно прочтите данную инструкцию.
Не выбрасывайте данную инструкцию: сохраните ее для последующего использования.

Παρακαλείσθε να διαβάσετε αυτές τις οδηγίες πριν χρησιμοποιήσετε το προϊόν.
Μην τις απορρίψετε: κρατήστε τις για μελλοντική αναφορά.

Kullanmadan önce lütfen bu talimatları okuyun.
Atmayın: ileride başvurmak üzere saklayın.

Před použitím si přečtěte tyto pokyny.
Nelikvidujte: uschovejte pro budoucí použití.

Pred použitím si prečítajte tieto pokyny.
Nezahadzujte: odložte pre budúce použitie.

Kérjük, hogy használat előtt olvassa el az utasításokat!
Az utasításokat ne dobja ki; tartsa meg referenciaanyagként való jövőbeni használatra.

Leia estas instruções antes da utilização.
Não as deite fora: conserve-as para consulta futura.

ENGLISH

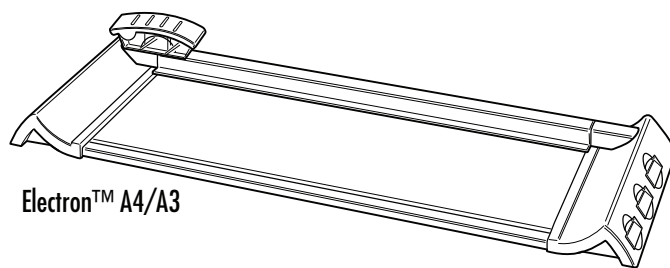

Electron™ A4/A3

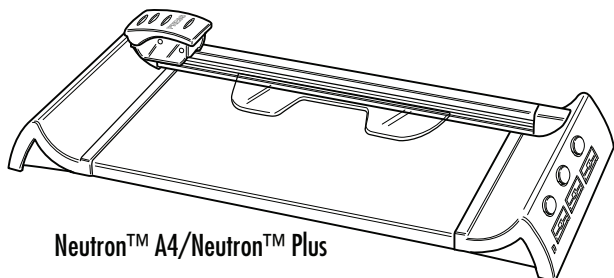

Neutron™ A4/Neutron™ Plus

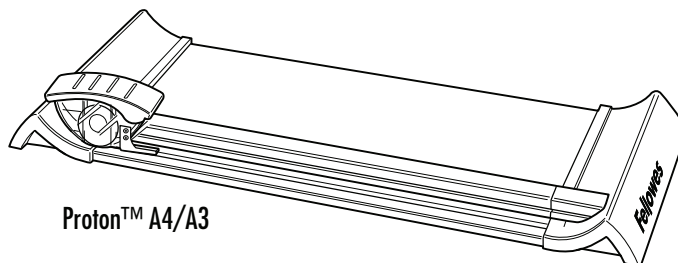

Proton™ A4/A3

CAPACITIES AND CONTENT

CRC #	Model	Number of blades	Cutting Length (mm)	Cutting Length (inch)	Cutting capacity (sheets 80 gsm)
54100	Neutron A4	1	320	12	10
54101	Neutron Plus	4	320	12	10
54102	Proton A4	1	320	12	10
54103	Proton A3	1	460	18	10

CRC #	Model	Number of blades	Cutting Length (mm)	Cutting Length (inch)	Cutting capacity (sheets 80 gsm)
54104	Electron A4	4	320	12	10
54105	Electron A3	4	460	18	10

IMPORTANT SAFETY INSTRUCTIONS — Read Before Using!

CAUTION

- Caution: blades are extremely sharp.
- SafeCut™ cassette encloses blades — do not try to extract blades manually.
- Always supervise children during use.
- Do not overload trimmer.
- Keep pets away from trimmer while in use.
- Do not open or attempt to repair, as this will void your warranty. Contact CustomerService if you have questions. Please note the warranty does not apply in cases of abuse, mishandling or unauthorized repair.
- Do not try to open SafeCut™ blade cartridges.

Need Help?

Customer Service
www.fellows.com
 Let our experts help you
 with a solution.
 Always call Fellows
 before contacting
 your place of purchase.

CUTTING PAPER AND PHOTOS

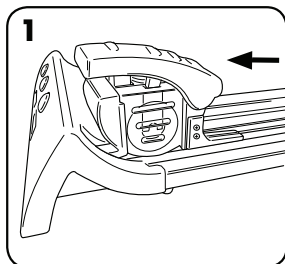

1. Slide cutting carriage to one end into lock position.

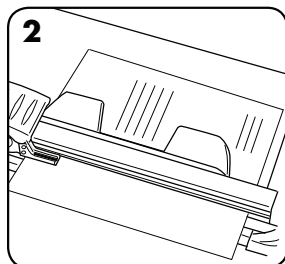

2. Place item (e.g. photo or paper) onto cutting table.

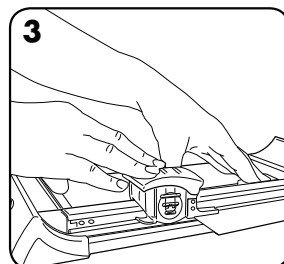

3. Hold paper steady with hand or clamping mechanism. To activate cutting blade, push down carriage handle. (Electron: when pressing handle down, LED will glow).

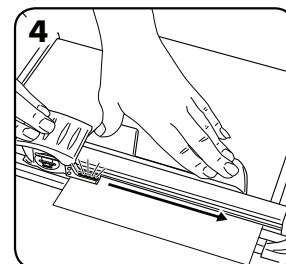

4. To cut, push handle downwards and slide carriage along until reaching the end of the bar. At the end of the bar, release the carriage and the clamping mechanism will release.

ENGLISH

SAFECUT™ SAFETY FEATURES

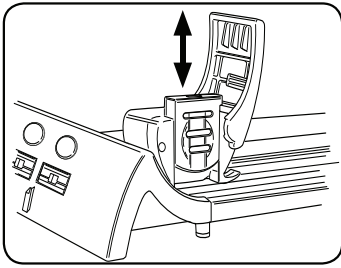



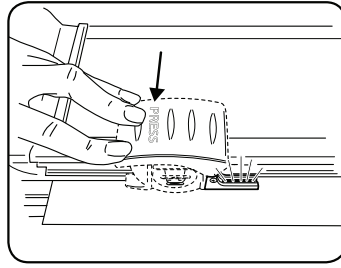



The SafeCut™ cartridge system allows users to change the cutting cartridge without touching the blades.

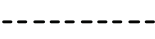

The SafeCut™ LED Guide on the Electron trimmer for illuminated precision. Safer than laser guides.

ACCESSORY PACKS

3 Creative SafeCut™ blades			Cutting capacity (sheets 80 gsm)
		Wave Cut	5
		Perforate	5
		Fold (crease)	3

CRC#	Pack contents
54113	3 Creative SafeCut™ blades (1x wave, 1x perforate, 1x fold)
54114	2 Straight SafeCut™ blades
54115	A4 Cutting strips (x3)
54116	A3 Cutting strips (x3)

CHANGING BLADE CASSETTE

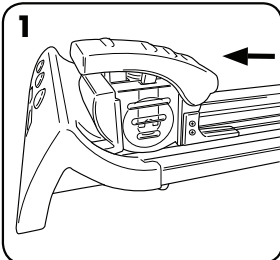

1. Slide cutting carriage to one end into lock position.

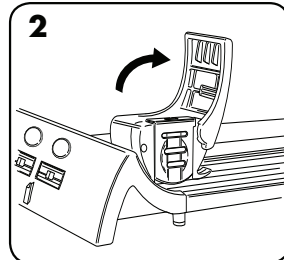

2. Lift carriage handle up.

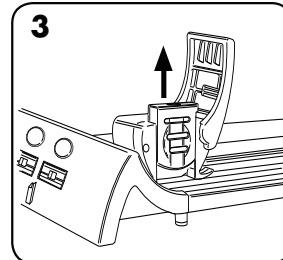

3. Pull SafeCut™ cartridge upwards out of cutting carriage and insert new cartridge (push down to click into place).

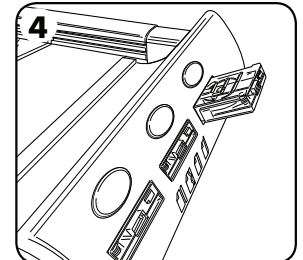

4. Press yellow button to release cassette from base. Return unused SafeCut™ into storage slot in base.

CHANGING CUTTING STRIP

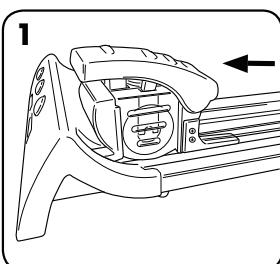

1. Slide cutting carriage to one end into lock position.

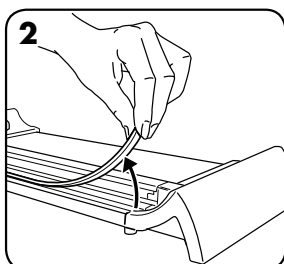

2. Remove cutting strip off trimmer base.

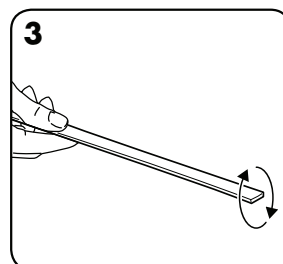

3. Turn cutting strip over to use both sides.

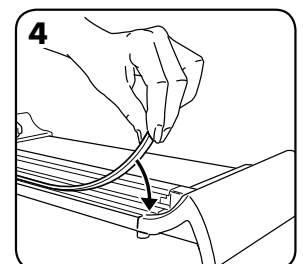

4. Replacement strips available (see accessory details).

ENGLISH

ELECTRON SAFECUT™ LED GUIDE

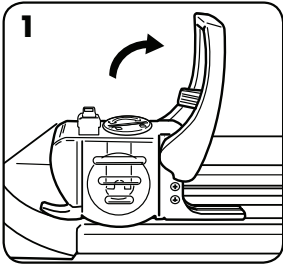

1. Slide cutting carriage to one end into lock position. Pull (swing) carriage handle up.

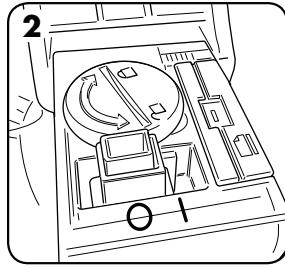

2. Turn switch to ON (I) position.

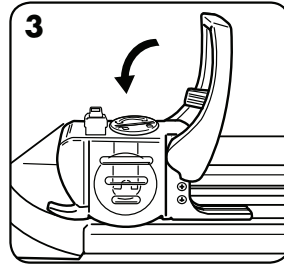

3. Pull (swing) carriage handle down.

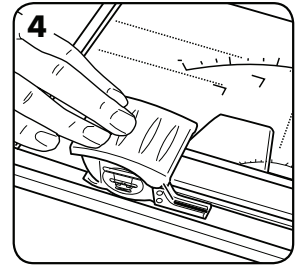

4. Press handle down to activate SafeCut™ LED Guide.

CHANGE BATTERY ON ELECTRON SAFECUT™ LED GUIDE

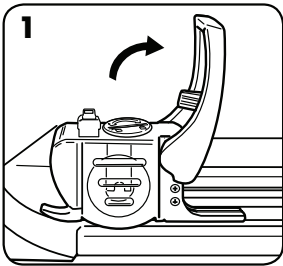

1. Slide cutting carriage to one end into lock position. Pull (swing) carriage handle up.

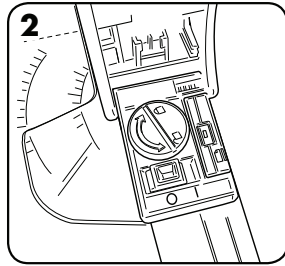

2. Unscrew battery cover with coin or screwdriver (left turn opens, right turn closes battery cover).

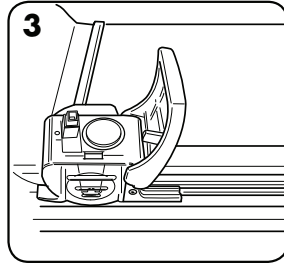

3. Remove old battery and replace with new battery [type CR2023].

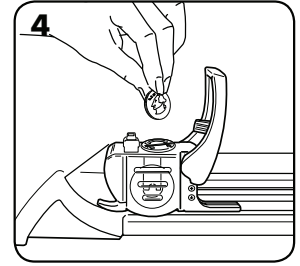

4. Close battery cover.

WARRANTY

Fellowes warrants all other parts of the machine to be free of defects in material and workmanship for 2 year from the date of purchase by the original consumer. If any part is found to be defective during the warranty period, your sole and exclusive remedy will be repair or replacement, at Fellowes' option and expense, of the defective part. This warranty does not apply in cases of abuse, mishandling, or unauthorized repair. ANY IMPLIED WARRANTY, INCLUDING THAT OF MERCHANTABILITY OR FITNESS FOR A PARTICULAR PURPOSE, IS HEREBY LIMITED IN DURATION TO THE APPROPRIATE WARRANTY

Australia Residents Only:

Our goods come with guarantees that cannot be excluded under the Australian Consumer Law. You are entitled to a replacement or refund for a major failure and for compensation for any other reasonably foreseeable loss or damage. You are also entitled to have the goods repaired or replaced if the goods fail to be of acceptable quality and the failure does not amount to a major failure. The benefits under Fellowes' Warranty are in addition to other rights and remedies under a law in relation to the trimmer.

PERIOD SET FORTH ABOVE. In no event shall Fellowes be liable for any consequential or incidental damages attributable to this product. This warranty gives you specific legal rights. The duration, terms, and conditions of this warranty are valid worldwide, except where different limitations, restrictions, or conditions may be required by local law. For more details or to obtain service under this warranty, please contact us or your dealer. Accessories and consumables are excluded from this warranty.

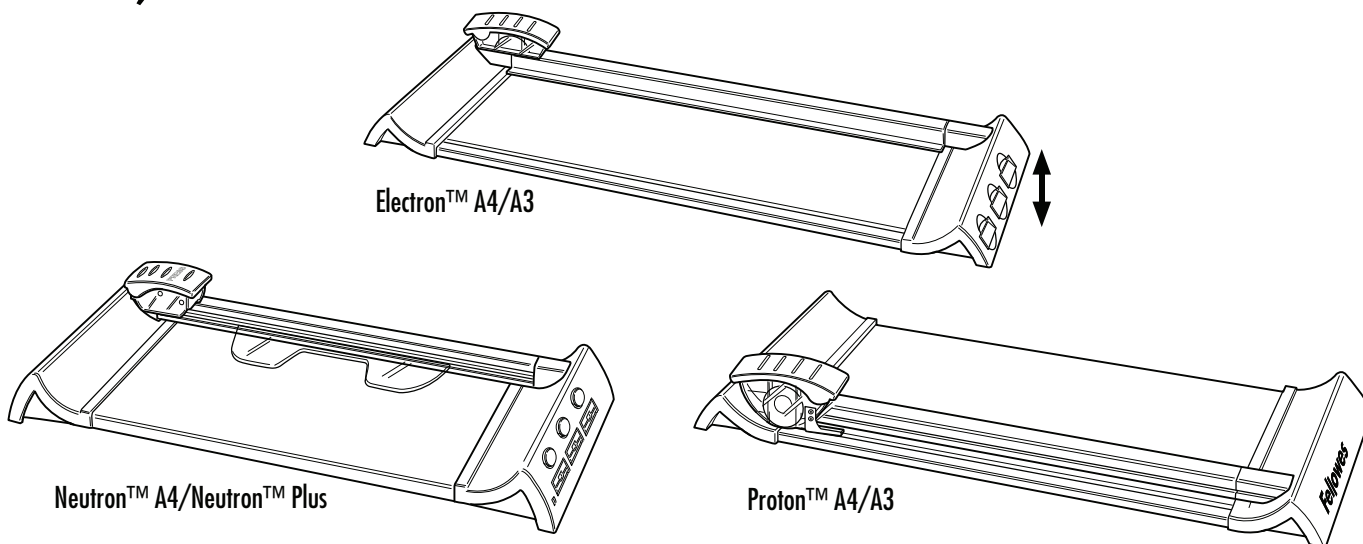

CAPACITÉS ET CONTENUS

CRC n°	Modèle	Nombre de lames	Longueur de la coupe (mm)	Capacité de coupe (feuilles 80 gsm)
54100	Neutron A4	1	320	10
54101	Neutron Plus	4	320	10
54102	Proton A4	1	320	10
54103	Proton A3	1	460	10

CRC n°	Modèle	Nombre de lames	Longueur de la coupe (mm)	Capacité de coupe (feuilles 80 gsm)
54104	Electron A4	4	320	10
54105	Electron A3	4	460	10

CONSIGNES DE SÉCURITÉ IMPORTANTES — Lire attentivement avant d'utiliser l'appareil !

ATTENTION

- Attention : Les lames sont très coupantes.
- Le boîtier SafeCut™ contient des lames — ne pas essayer d'extraire manuellement les lames.
- Toujours surveiller les enfants pendant l'utilisation.
- Ne jamais surcharger le massicot.
- Tenir les animaux domestiques hors de portée du massicot lors de son utilisation.
- Ne pas ouvrir ou essayer de réparer, car cela pourrait annuler votre garantie. Contacter le Service clientèle pour toute question. Cette garantie ne s'applique pas en cas d'utilisation abusive, de manipulation inappropriée ou de réparation non autorisée.
- Ne pas essayer d'ouvrir les cartouches de lames SafeCut™.

Vous avez besoin d'aide ?

Service à la clientèle
www.fellowes.com
 Consultez nos experts pour trouver une solution. Appelez toujours Fellowes avant de contacter le point de vente.

COUPER DU PAPIER ET DES PHOTOS

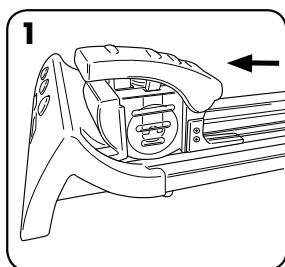

1. Faire glisser le chariot de coupe vers l'une des extrémités pour le mettre en position de blocage.

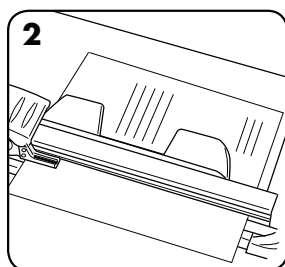

2. Placer l'objet (c.-à-d. la photo ou le papier) sur l'établi de coupe.

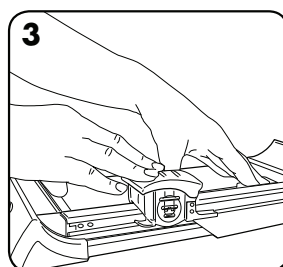

3. Tenir fermement le papier à la main ou avec la pince à serrer. Pour activer la lame de coupe, pousser la poignée du chariot vers le bas. (Electron : le voyant s'allume quand on presse la poignée vers le bas).

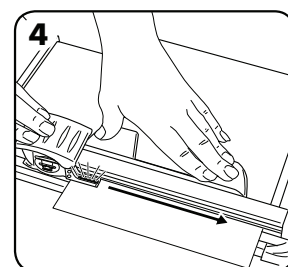

4. Pour couper, pousser la poignée vers le bas et faire glisser le chariot jusqu'à atteindre le bout de la barre. Arrivé au bout de la barre, relâcher le chariot et la pince de serrage se débloquent d'elle-même.

CARACTÉRISTIQUES DE SÉCURITÉ DE SAFECUT™

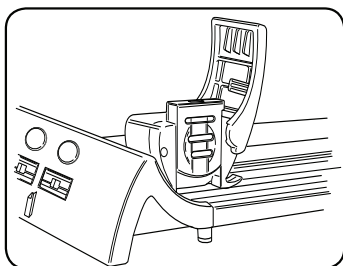



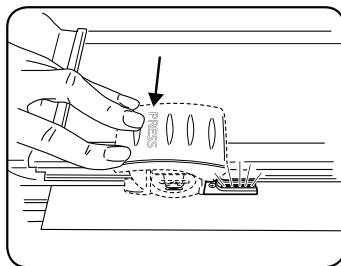



Le système de cartouches SafeCut™ permet aux utilisateurs de changer les cartouches sans toucher les lames.

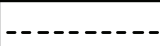

Le voyant guide lumineux sur le massicot SafeCut™ Electron permet une précision parfaite. Plus sûr qu'un guide laser.

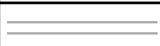
PACKS D'ACCESSOIRES

3 lames Creative SafeCut™		Capacité de coupe (feuilles 80 gsm)
	 Découpe en vagues	5
	 Perforation	5
	 Plier (pli)	3

CRC n°	Emballer des contenus
54113	3 lames Creative SafeCut™ (1x vague, 1x perforation, 1x pli)
54114	2 lames droites Straight SafeCut™
54115	Bandes de coupes A4 (x3)
54116	Bandes de coupes A3 (x3)

CHANGEMENT DE CARTOUCHE DE LAMES

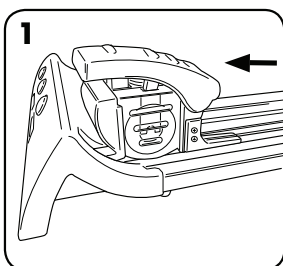

1. Faire glisser le chariot de coupe vers l'une des extrémités pour le mettre en position de blocage.

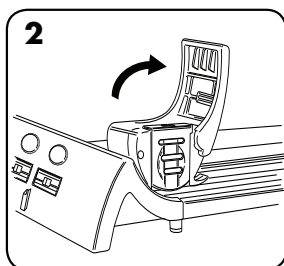

2. Soulever la poignée du chariot.

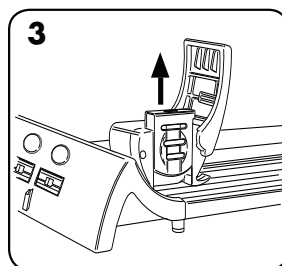

3. Tirer la cartouche SafeCut™ vers le haut et vers l'extérieur du chariot de coupe et insérer une nouvelle cartouche (pousser vers le bas jusqu'au dé clic).

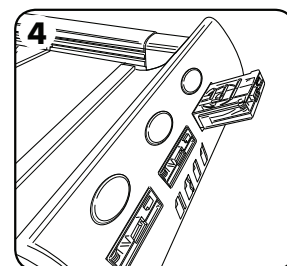

4. Pousser le bouton jaune pour retirer la cartouche de la base. Remettre les SafeCut™ dans la rainure de stockage de la base.

CHANGEMENT DE BANDE DE COUPE

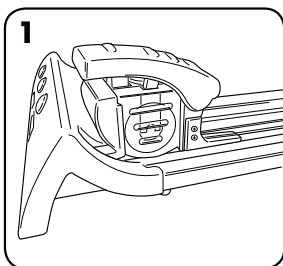

1. Faire glisser le chariot de coupe vers l'une des extrémités pour le mettre en position de blocage.

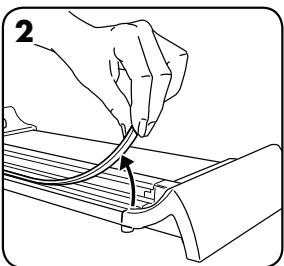

2. Enlever la bande de coupe de la base du massicot.

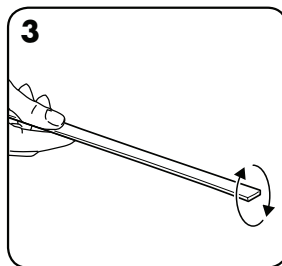

3. Retourner la bande de coupe pour utiliser les deux côtés.

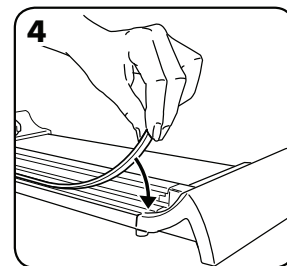

4. Des bandes de remplacement sont disponibles (voir les accessoires).

GUIDE DES VOYANTS DEL ELECTRON SAFECUT™

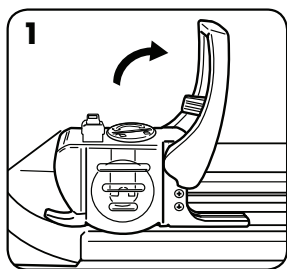

1. Faire glisser le chariot de coupe vers l'une des extrémités pour le mettre en position de blocage. Soulever (basculer) la poignée du chariot.

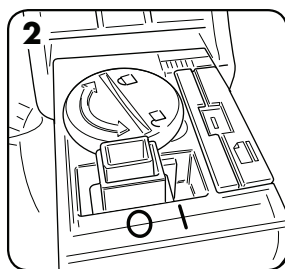

2. Mettre l'interrupteur en position MARCHÉ (I).

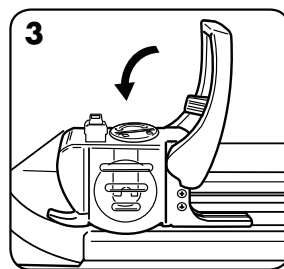

3. Tirer (faire basculer) la poignée du chariot vers le bas.

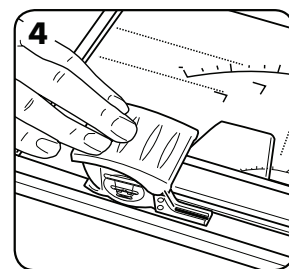

4. Appuyer sur la poignée pour activer le guide des voyants DEL SafeCut™.

CHANGER LA BATTERIE DU GUIDE LUMINEUX DE L'ELECTRON SAFECUT™

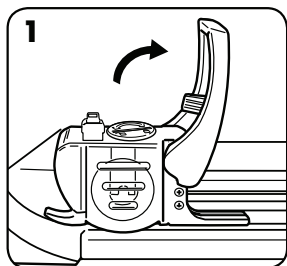

1. Faire glisser le chariot de coupe vers l'une des extrémités pour le mettre en position de blocage. Soulever (basculer) la poignée du chariot.

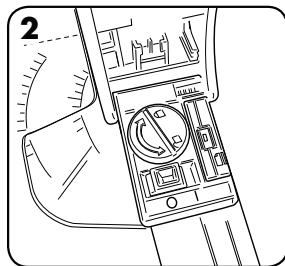

2. Dévisser le volet du compartiment des piles à l'aide d'une pièce de monnaie ou d'un tournevis (tourner à gauche pour ouvrir et à droite pour fermer).

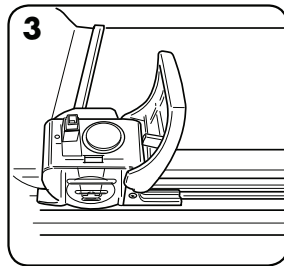

3. Enlever la vieille batterie et la remplacer par une nouvelle batterie [type CR2023].

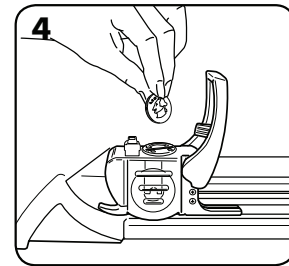

4. Fermer le couvercle de la pile.

GARANTIE

Fellowes garantit que tous les autres composants de la machine sont exempts de tout vice provenant d'un défaut de matière ou de fabrication pendant une période de 2 ans à partir de la date de l'achat initial. Si une pièce s'avère défectueuse pendant la période de garantie, votre seul et unique recours sera la réparation ou le remplacement de la pièce défectueuse selon les modalités et aux frais de Fellowes. Cette garantie ne s'applique pas en cas d'utilisation abusive, de manipulation impropre ou de réparation non autorisée. TOUTE GARANTIE IMPLICITE, Y COMPRIS CELLE DE COMMERCIALISATION OU D'ADAPTATION À UN USAGE PARTICULIER, EST PAR LA PRÉSENTE LIMITÉE EN DURÉE À

LA PÉRIODE DE GARANTIE APPROPRIÉE DÉFINIE CI-DESSUS. Fellowes ne saurait en aucun cas être tenu responsable de dommages consécutifs à un accident. Cette garantie vous donne des droits spécifiques. La durée, les conditions générales et les conditions de cette garantie sont valables dans le monde entier, excepté en cas de prescription, de restrictions ou de conditions exigibles par les lois locales. Pour plus de détails ou pour obtenir un service sous garantie, prendre contact avec nous ou le revendeur. Les accessoires et les consommables sont exclus de cette garantie.

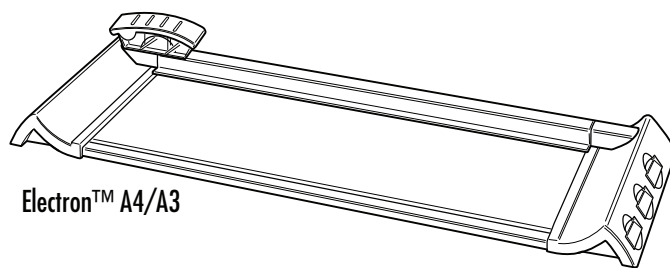

Electron™ A4/A3

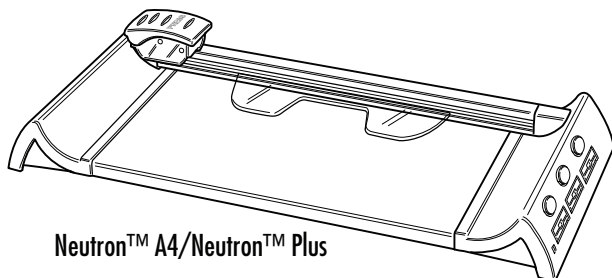

Neutron™ A4/Neutron™ Plus

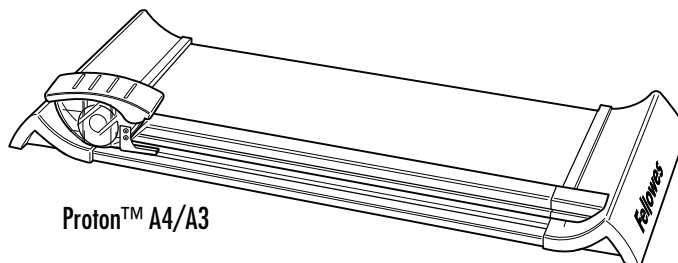

Proton™ A4/A3

CAPACIDADES Y CONTENIDO

Nº CRC	Modelo	Número de cuchillas	Longitud de corte (mm)	Capacidad de corte (hojas 80 gsm)
54100	Neutron A4	1	320	10
54101	Neutron Plus	4	320	10
54102	Proton A4	1	320	10
54103	Proton A3	1	460	10

Nº CRC	Modelo	Número de cuchillas	Longitud de corte (mm)	Capacidad de corte (hojas 80 gsm)
54104	Electron A4	4	320	10
54105	Electron A3	4	460	10

INSTRUCCIONES DE SEGURIDAD IMPORTANTES — ¡Lea todas las instrucciones antes del uso!

⚠️ PRECAUCIÓN

- Precaución: las cuchillas están muy afiladas.
- El casete SafeCut™ contiene las cuchillas. No intente extraer las cuchillas manualmente.
- Supervise siempre a los niños cuando esté utilizando la cortadora.
- No ponga una cantidad excesiva de material en la cortadora.
- Mantenga a las mascotas alejadas cuando esté utilizando la cortadora.
- No abra ni intente reparar la cortadora, ya que esto anulará la garantía. Comuníquese con el servicio de atención al cliente si tiene dudas. Esta garantía no se aplica en los casos de uso indebido, manejo inapropiado o reparación no autorizada.
- No intente abrir los cartuchos con las cuchillas SafeCut™.

¿Necesita ayuda?

Servicio al cliente
www.fellowes.com
 Deje que nuestros expertos le ayuden y le den una solución. Llámenos siempre antes de ponerse en contacto con su distribuidor.

PARA CORTAR PAPEL Y FOTOS

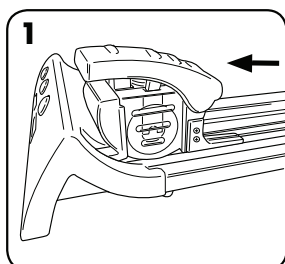

1. Deslice el carro de corte a un extremo a la posición de bloqueo.

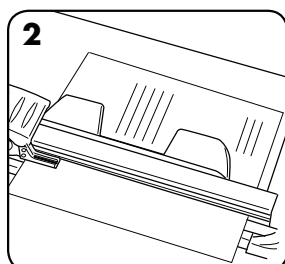

2. Coloque el material (por ejemplo, foto o papel) sobre la mesa de corte.

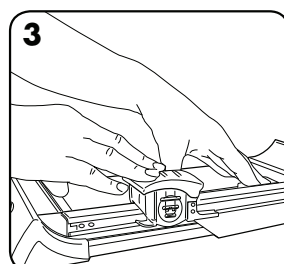

3. Sujete el papel firmemente con una mano o un mecanismo de sujeción. Para activar la cuchilla de corte, presione hacia abajo la palanca del carro. (Electron: al presionar la palanca, la guía LED se iluminará).

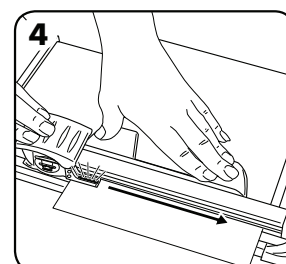

4. Para cortar, presione la palanca hacia abajo y deslice el carro a lo largo de la barra hasta alcanzar el otro extremo. Al final de la barra, suelte el carro y el mecanismo de sujeción se liberará.

CARACTERÍSTICAS DE SEGURIDAD DEL SISTEMA SAFECUT™

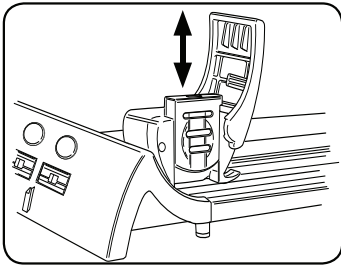

El sistema de cartucho SafeCut™ permite al usuario cambiar el cartucho de corte sin tocar las cuchillas.

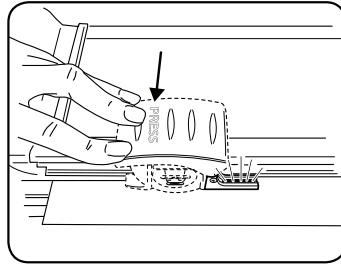

Guía LED SafeCut™ en la cortadora Electron para una mayor precisión. Más seguro que las guías láser.

KITS DE ACCESORIOS

3 cuchillas Creative SafeCut		Capacidad de corte (hojas 80 gsm)
	Corte ondulado	5
	Perforación	5
	Pliegue (doblez)	3

Nº CRC	Contenido del kit
54113	3 cuchillas Creative SafeCut™ (1x corte ondulado, 1x perforar, 1x plegar)
54114	2 cuchillas rectas SafeCut™
54115	Tiras de corte A4 (x3)
54116	Tiras de corte A3 (x3)

PARA CAMBIAR EL CASETE DE CUCHILLAS

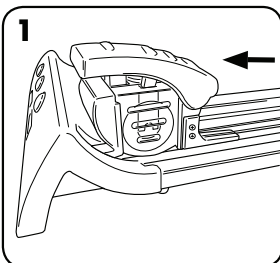

1. Deslice el carro de corte a un extremo a la posición de bloqueo.

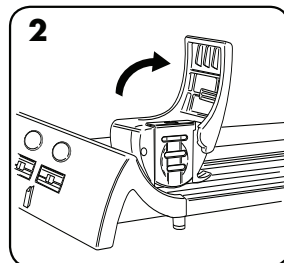

2. Levante la palanca del carro.

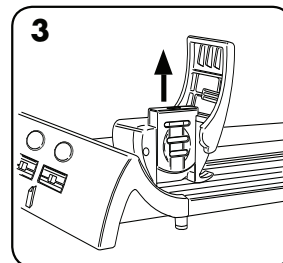

3. Tire del cartucho SafeCut™ hacia arriba para sacarlo del carro de corte, e inserte un cartucho nuevo (presione hacia abajo hasta que encaje con un chasquido en su lugar).

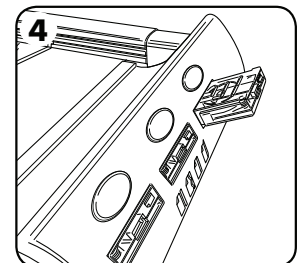

4. Pulse el botón amarillo para que el casete salga de la base. Vuelva a guardar el SafeCut™ no utilizado en la ranura correspondiente en la base.

PARA CAMBIAR LA TIRA DE CORTE

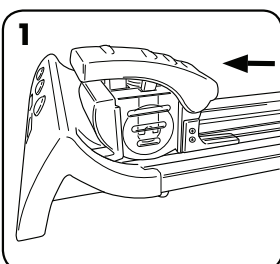

1. Deslice el carro de corte a un extremo a la posición de bloqueo.

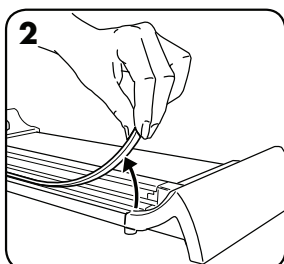

2. Quite la tira de corte de la base de la cortadora.

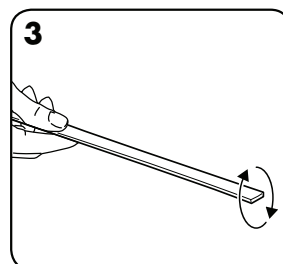

3. Dé la vuelta a la tira de corte para usar ambos lados.

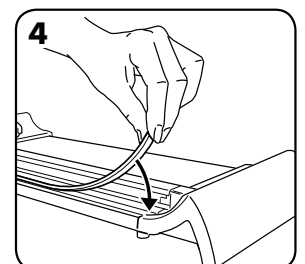

4. Pueden solicitarse tiras de repuesto (consulte los detalles de los accesorios).

GUÍA LED SAFECUT™ DE ELECTRON

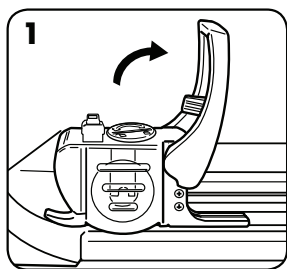

1. Deslice el carro de corte a un extremo a la posición de bloqueo. Tire del mango del carro hacia arriba.

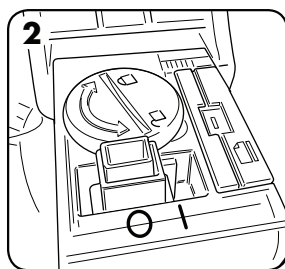

2. Coloque el interruptor en posición de ENCENDIDO (I).

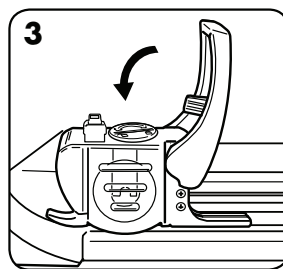

3. Empuje (desplace) hacia abajo la palanca del carro.

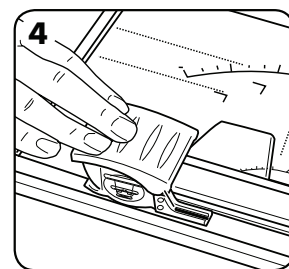

4. Presione la palanca para activar la Guía LED SafeCut™.

PARA CAMBIAR LA BATERÍA EN LA GUÍA LED SAFECUT™ DEL MODELO ELECTRON

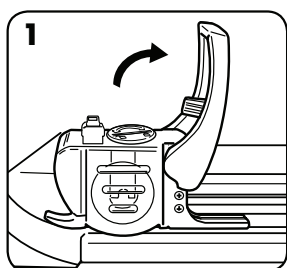

1. Deslice el carro de corte a un extremo a la posición de bloqueo. Tire del mango del carro hacia arriba.

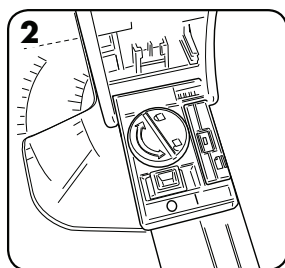

2. Desatornille la cubierta de la batería con una moneda o un destornillador (el giro a la izquierda la abre y el giro a la derecha la cierra).

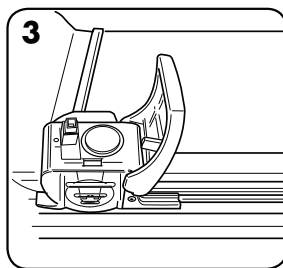

3. Saque la batería gastada y cámbiela por una nueva [tipo CR2023].

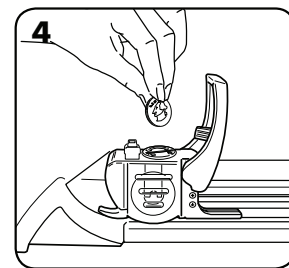

4. Cierre la cubierta de la batería.

GARANTÍA

Fellowes garantiza que todas las otras piezas de la máquina estarán libres de defectos de material y mano de obra durante 2 años a partir de la fecha en que el consumidor original haya adquirido el producto. Si se encuentra algún defecto en cualquiera de las piezas durante el período de garantía, la única y exclusiva solución será la reparación o el cambio de la pieza defectuosa, a criterio y cuenta de Fellowes. Esta garantía queda anulada en casos de abuso, uso indebido o reparación no autorizada. CUALQUIER GARANTÍA IMPLÍCITA, INCLUIDA LA DE COMERCIABILIDAD O APTITUD PARA UN OBJETIVO PARTICULAR, QUEDA LIMITADA POR LA PRESENTE EN SU DURACIÓN AL PERIODO

APROPIADO DE GARANTÍA ESTABLECIDO ANTERIORMENTE. Fellowes no será responsable en ningún caso de ningún daño indirecto o incidental atribuible a este producto. Esta garantía le confiere derechos legales específicos. La duración, los términos y las condiciones de esta garantía son válidos en todo el mundo, excepto en los lugares donde la legislación local exija limitaciones, restricciones o condiciones diferentes. Para obtener más detalles o recibir servicio conforme a esta garantía, comuníquese con nosotros o con su distribuidor. Los accesorios y los productos consumibles quedan excluidos de esta garantía.

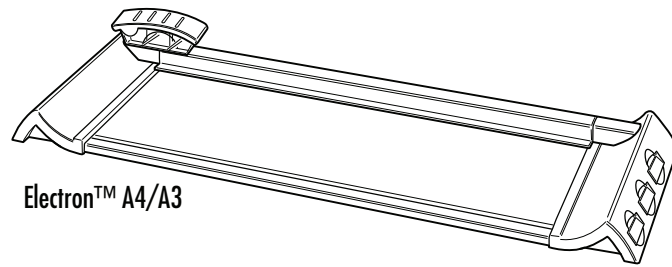

Electron™ A4/A3

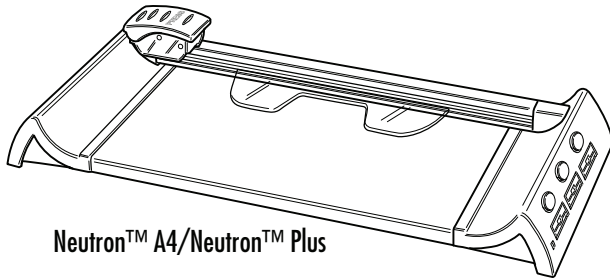

Neutron™ A4/Neutron™ Plus

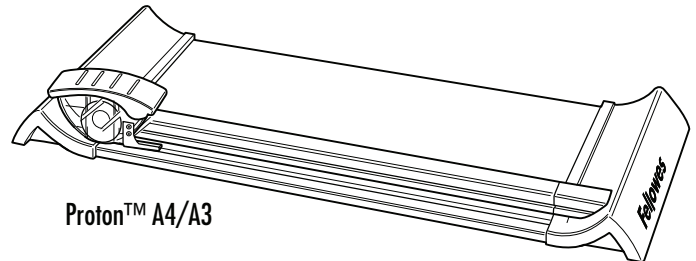

Proton™ A4/A3

Leistungsmerkmale

Modellnummer Nr.	Modell	Anzahl SafeCut™ Schneidekassetten	Schnittlänge (mm)	Schneideleistung (Blätter 80 g/m ²)
54100	Neutron A4	1	320	10
54101	Neutron Plus	4	320	10
54102	Proton A4	1	320	10
54103	Proton A3	1	460	10

Modellnummer Nr.	Modell	Anzahl SafeCut™ Schneidekassetten	Schnittlänge (mm)	Schneideleistung (Blätter 80 g/m ²)
54104	Electron A4	4	320	10
54105	Electron A3	4	460	10

WICHTIGE SICHERHEITSHINWEISE – Bitte vor Gebrauch lesen!

VORSICHT

- Achtung, Klingen sind sehr scharf – Verletzungsgefahr!
- SafeCut™ Sicherheits-Kassetten umschließen die Klingen – nicht öffnen oder manipulieren.
- Nicht für Kinder geeignet.
- Haustiere von den Schneidemaschinen fern halten.
- Nicht versuchen, die Schneidemaschinen selbst zu reparieren – dies bringt die Garantie zum Erlöschen. Bei Fragen wenden Sie sich bitte an den Kundendienst. Die Garantie verfällt im Fall von Missbrauch, unsachgemäßer Handhabung und unbefugter Reparatur.
- Schneidemaschinen nicht überlasten.

Benötigen Sie Hilfe?

Kundendienst
www.fellowes.com
 Rufen Sie bitte unsere Experten in der Kundendienstabteilung an. Die Nummer für die nächstgelegene Service-Zentrale finden Sie auf dem HINTEREN Umschlag dieses Handbuchs.

SCHNEIDEN VON PAPIER UND FOTOS

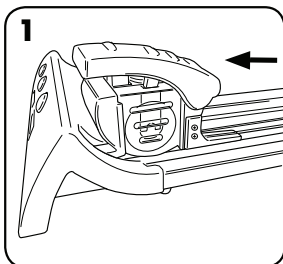

1. Schneidekopf bis zum Endanschlag ziehen.

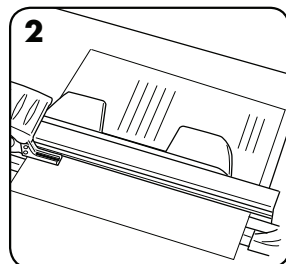

2. Zu beschneidendes Foto oder Papier auf dem Schneidetisch positionieren.

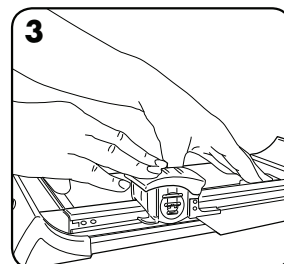

3. Papier während des Schneidens mit dem Haltemechanismus festhalten. Handgriff herunterdrücken, um die Schneideklinge zu aktivieren. (Electron: SafeCut™ LED Guide leuchtet, wenn der Handgriff heruntergedrückt wird.)

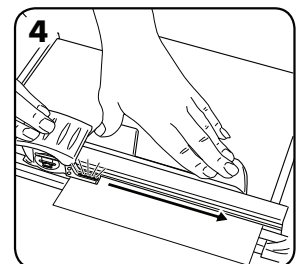

4. Schneidekopf gleichmäßig bis zum Anschlag entlang des Schneideguts ziehen. Beim Loslassen des Handgriffes wird der Haltemechanismus wieder gelöst.

SAFECUT™ SICHERHEITS-AUSSTATTUNG

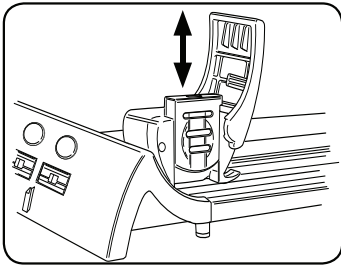



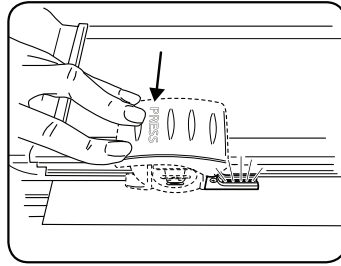



Das SafeCut™ Sicherheits-Kassetten System ermöglicht einen Wechsel der Schneidekassette ohne Berühren der Klingen.



Der SafeCut™ LED Guide ermöglicht eine genaueste Anzeige der Schneidelinie und ist sicherer als Laseranzeigen.

ZUBEHÖR

3 Creative SafeCut™-Messer		Schneideleistung (Blätter 80 g/m ²)
	 Wellenschnitt	5
	 Perforierung	5
	 Falten	3

Modellnummer (CRC)	Beschreibung
54113	3 Creative SafeCut™-Messer (1x Welle, 1x Perforierung, 1x Falten)
54114	2 gerade SafeCut™-Messer
54115	A4 Schneidestreifen (x3)
54116	A3 Schneidestreifen (x3)

WECHSEL DER SAFECUT™ SICHERHEITS-KASSETTEN

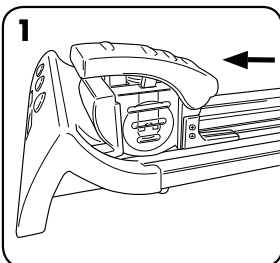

1. Schneidekopf bis zur Einrastung am Endanschlag ziehen.

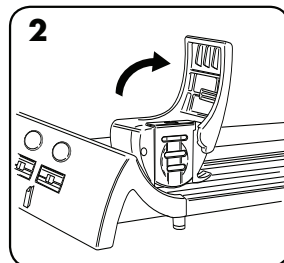

2. Abdeckung der Schneidekopfaufnahme öffnen.

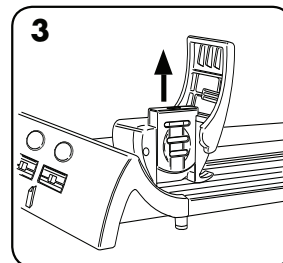

3. SafeCut™ Sicherheits-Kassette nach oben aus dem Schneidekopf herausziehen. Neue Kassette bis zum Einrasten in den Schneidekopf einschieben.

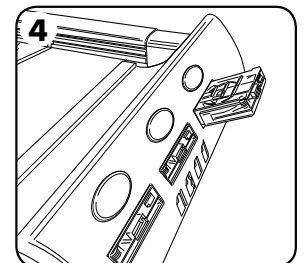

4. SafeCut™ Sicherheits-Kassette per Knopfdruck aus dem Fach im Schneidetisch auswerfen und die ersetzte Kassette in ein leeres Aufbewahrungsfach schieben.

WECHSEL DER SCHNITTLISTE

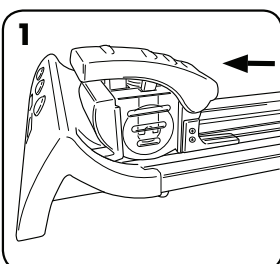

1. Schneidekopf bis zur Einrastung am Endanschlag ziehen.

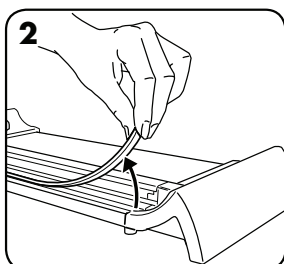

2. Schnittleiste vorsichtig vom Schneidetisch abziehen.

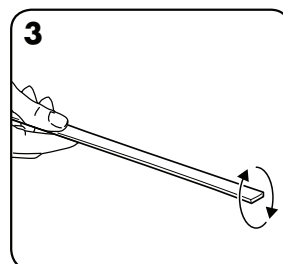

3. Schnittleiste umdrehen, um beide Seiten zu benutzen.

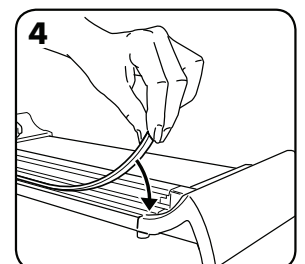

4. Ersatzschnittleiste (siehe Übersicht oben) sind im Fachhandel erhältlich.

ELECTRON SAFECUT™ LED-FÜHRUNG

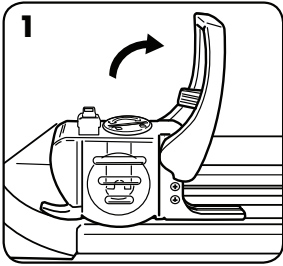

1. Schneidekopf bis zur Einrastung am Endanschlag ziehen. Abdeckung der Schneidekopf-aufnahme öffnen.

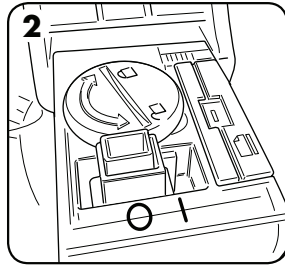

2. Den Schalter auf Position EIN (I) stellen.

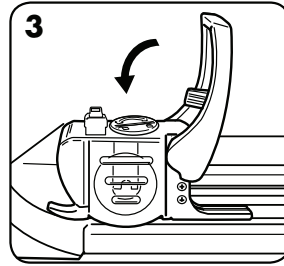

3. Den Schneidegriff nach unten ziehen (klappen).

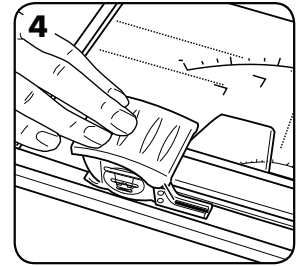

4. Den Griff nach unten drücken, um die SafeCut™ LED-Führung zu aktivieren.

WECHSEL DER BATTERIE BEIM SAFECUT™ LED GUIDE (NUR ELECTRON™ SCHNEIDEMASCHINE)

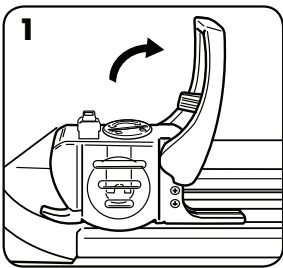

1. Schneidekopf bis zur Einrastung am Endanschlag ziehen. Abdeckung der Schneidekopf-aufnahme öffnen.

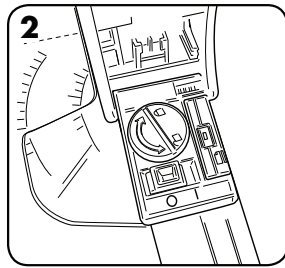

2. Die Batterieabdeckung mit einer Münze oder einem Schraubendreher abschrauben (nach links drehen, zum Öffnen, nach rechts drehen zum Verschließen der Batterieabdeckung).

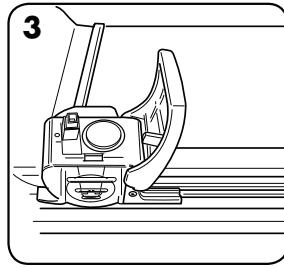

3. Batterie herausnehmen und mit neuer Batterie [Typ CR2032] ersetzen (erhältlich im Elektro-Fachhandel).

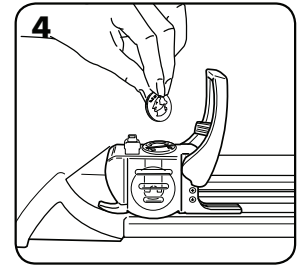

4. Batterieabdeckung wieder gut verschließen.

GARANTIE

Fellowes garantiert, dass alle Teile der Schneidemaschine für einen Zeitraum von 2 Jahren ab ursprünglichem Kaufdatum an den Erstkäufer frei von Material- und Verarbeitungsfehlern sind. Sollte sich ein Teil während der Garantiezeit als defekt erweisen, haben Sie nach Fellowes' Ermessen einzig und allein. Anspruch auf kostenlose Reparatur oder kostenlosen Ersatz des defekten Teils. Diese Garantie schließt Missbrauch, unsachgemäße Handhabung und unbefugte Reparaturen aus. ALLE STILLSCHWEIGENDEN GARANTIEEN, EINSCHLIESSLICH DIE DER MARKTGÄNGIGKEIT ODER EIGNUNG FÜR EINEN BESTIMMTEN ZWECK, WERDEN HIERMIT AUF DIE DAUER DER VORSTEHEND ANGEFÜHRTEN GARANTIEZEIT BESCHRÄNKT. AUF KEINEN FALL HAFTET FELLOWES FÜR EVENTUELL IM

ZUSAMMENHANG MIT DIESEM PRODUKT AUFTRETENDE NEBEN- ODER FOLGESCHÄDEN. Diese Garantie gewährt Ihnen bestimmte Rechte. Es können Ihnen noch weitere bzw. andere Rechte zustehen, die sich von dieser Garantie unterscheiden. Dauer, Bedingungen und Konditionen dieser Garantie gelten weltweit, außer lokale Gesetze schreiben andere Begrenzungen, Einschränkungen oder Konditionen vor. Um weitere Einzelheiten zu erfahren oder Serviceleistungen im Rahmen dieser Garantie in Anspruch zu nehmen, wenden Sie sich bitte an uns oder Ihren Händler. Zubehörteile sind von dieser Garantie ausgenommen.

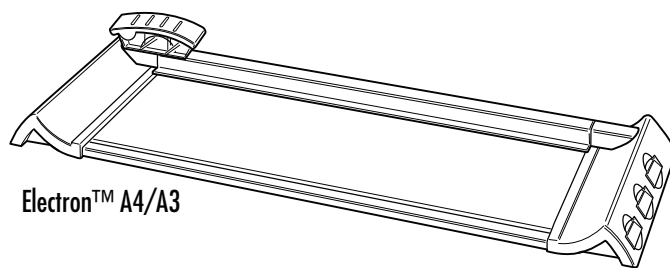

Electron™ A4/A3

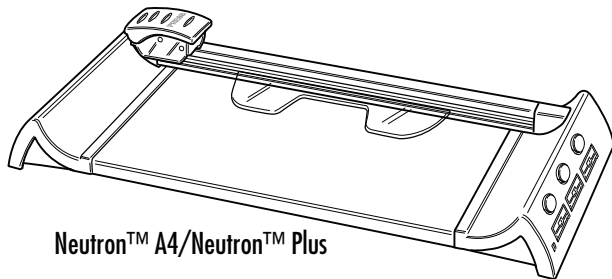

Neutron™ A4/Neutron™ Plus

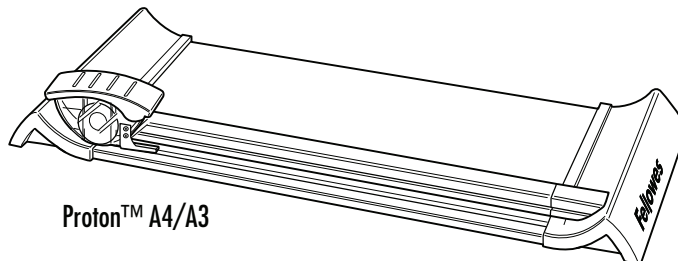

Proton™ A4/A3

DATI TECNICI E CONTENUTO

N. CRC	Modello	Numero di lame	Lunghezza di rifilatura (mm)	Capacità di rifilatura (n. fogli da 80 g/m ²)
54100	Neutron A4	1	320	10
54101	Neutron Plus	4	320	10
54102	Proton A4	1	320	10
54103	Proton A3	1	460	10

N. CRC	Modello	Numero di lame	Lunghezza di rifilatura (mm)	Capacità di rifilatura (n. fogli da 80 g/m ²)
54104	Electron A4	4	320	10
54105	Electron A3	4	460	10

IMPORTANTI ISTRUZIONI PER LA SICUREZZA — Leggere prima dell'uso!

ATTENZIONE

- Attenzione: le lame sono affilatissime.
- Le lame sono inserite nella cartuccia SafeCut™; non cercare di estrarle manualmente.
- Tenere lontano dalla portata dei bambini.
- Non sovraccaricare la taglierina.
- Tenere gli animali domestici lontani dalla taglierina durante l'uso.
- Non aprire la taglierina e non cercare di ripararla in quanto si annullerebbe la garanzia. In caso di domande rivolgersi al Servizio Assistenza Clienti. La garanzia non copre danni derivanti da uso improprio, manutenzione errata o riparazioni non autorizzate.
- Non cercare di aprire la cartuccia delle lame SafeCut™.

Per richiedere assistenza

Servizio clienti
www.fellowes.com
 I nostri tecnici sono a vostra disposizione per offrirvi la soluzione migliore. Contattate sempre Fellowes prima di rivolgervi al rivenditore.

RIFILATURA DI CARTA E FOTOGRAFIE

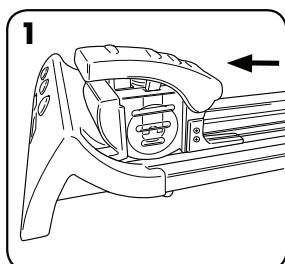

1. Fare scorrere il carrello di rifilatura sino a un'estremità nella posizione di bloccaggio.

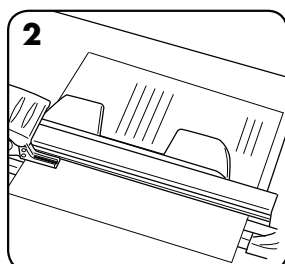

2. Posizionare la foto o i fogli di carta sulla taglierina.

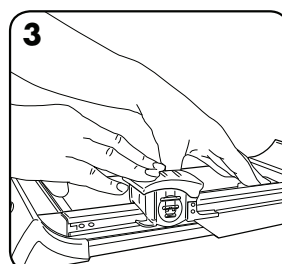

3. Bloccare la foto o la carta con la mano o con l'apposito meccanismo. Azionare la lama spingendo verso il basso sull'impugnatura del carrello. (Electron: quando si preme sull'impugnatura il LED si accende.)

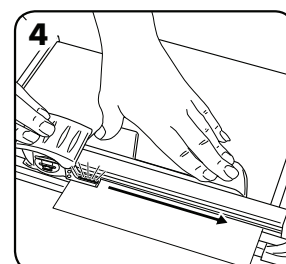

4. Per eseguire la rifilatura spingere l'impugnatura del carrello verso il basso e farlo scorrere sino all'altra estremità della barra, quindi rilasciarlo; il meccanismo di bloccaggio si sblocca.

SISTEMA DI SICUREZZA SAFECUT™

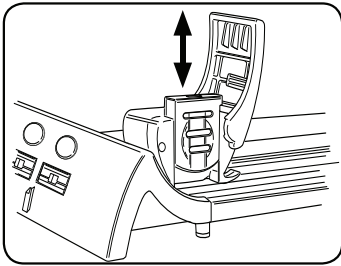

Il sistema SafeCut™ permette di sostituire la cartuccia delle lame senza bisogno di toccare le lame stesse.

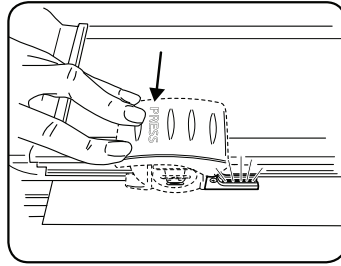

Il gruppo di LED SafeCut™ della taglierina Electron assicura precisione e sicurezza superiore a quella di una guida laser.

Assortimento di tre lame SafeCut™			Capacità di rifilatura (n. fogli da 80 g/m ²)
		Rifilatura ondulata	5
		Perforazioni	5
		Piegatura	3

N. CRC	Contenuto della confezione
54113	Assortimento di tre lame SafeCut™ (1 per rifilatura ondulata, 1 per perforazioni, 1 per piegatura)
54114	Due lame diritte SafeCut™
54115	Tre strisce di rifilatura A4
54116	Tre strisce di rifilatura A3

SOSTITUZIONE DELLA CARTUCCIA DELLE LAME

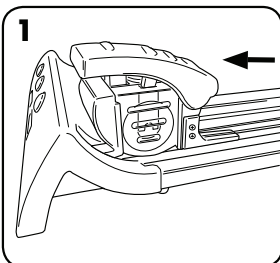

1. Fare scorrere il carrello di rifilatura sino a un'estremità nella posizione di bloccaggio.

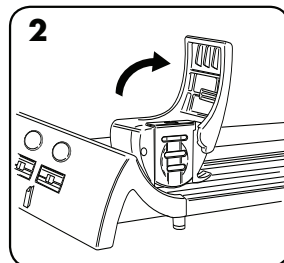

2. Sollevare l'impugnatura del carrello.

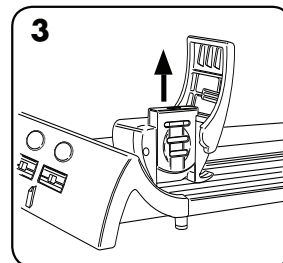

3. Tirare la cartuccia SafeCut™ verso l'alto per estrarla dal carrello e inserire la nuova cartuccia (spingerla verso il basso finché non si blocca con uno scatto).

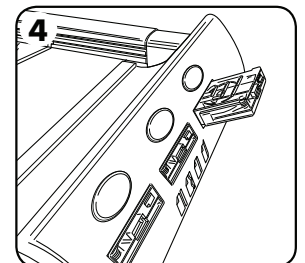

4. Premere il pulsante giallo per estrarre la cartuccia dalla base. Riporre nell'apposito vano nella base la cartuccia SafeCut™ non utilizzata.

SOSTITUZIONE DELLA STRISCIA DI RIFILATURA

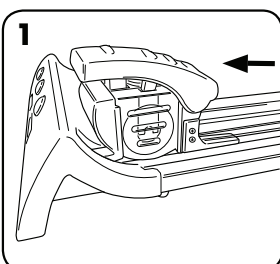

1. Fare scorrere il carrello di rifilatura sino a un'estremità nella posizione di bloccaggio.

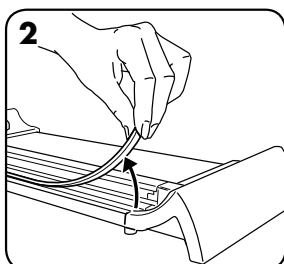

2. Rimuovere la striscia di rifilatura dalla base della taglierina.

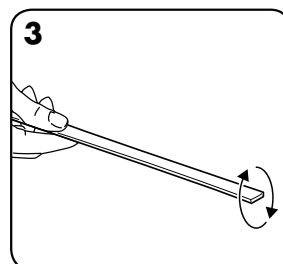

3. Capovolgere la striscia per usarne entrambi i lati.

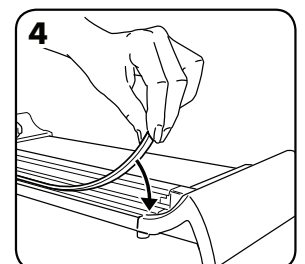

4. Sono disponibili strisce di ricambio (vedi Confezioni degli accessori).

GUIDA A LED ELECTRON SAFECUT™

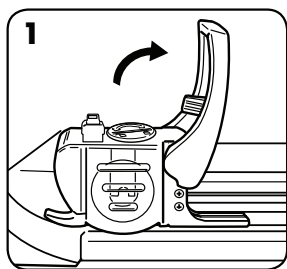

1. Fare scorrere il carrello di rifilatura sino a un'estremità nella posizione di bloccaggio. Aprire l'impugnatura incernierata del carrello tirandola verso l'alto.

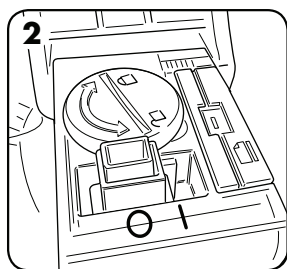

2. Portare l'interruttore in posizione di ACCESO (I).

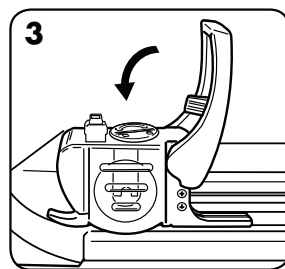

3. Abbassare la maniglia rotante.

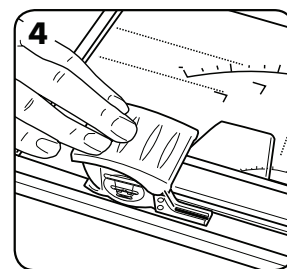

4. Premere la maniglia per attivare la guida a LED SafeCut™.

CHANGE BATTERY ON ELECTRON SAFECUT™ LED GUIDE

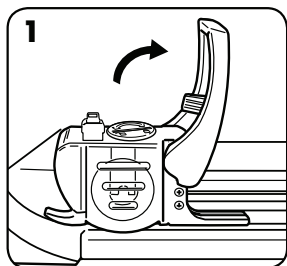

1. Fare scorrere il carrello di rifilatura sino a un'estremità nella posizione di bloccaggio. Aprire l'impugnatura incernierata del carrello tirandola verso l'alto.

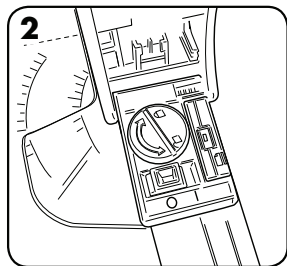

2. Svitare il coperchio del comparto batterie con una moneta o un cacciavite (girare a sinistra per aprire, a destra per chiudere).

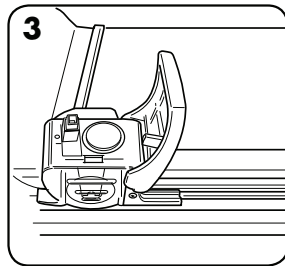

3. Sostituire la batteria vecchia con una nuova [tipo CR2023].

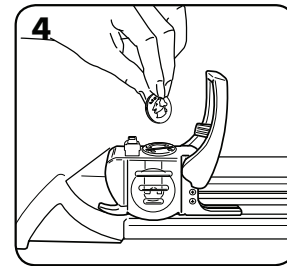

4. Chiudere il coperchio dello scomparto della batteria.

GARANZIA

Fellowes garantisce che tutti i componenti della macchina saranno privi di difetti di materiali e fabbricazione per la durata di 2 anni dalla data d'acquisto da parte dell'utente originale. Nel caso in cui si riscontrino dei difetti durante il periodo di garanzia, il rimedio esclusivo a disposizione del cliente sarà la riparazione o la sostituzione del prodotto difettoso, a carico di Fellowes e a sua discrezione. La garanzia non copre danni derivanti da uso improprio o eccessivo o da manutenzione errata. EVENTUALI GARANZIE IMPLICITE, COMPRESE QUELLE DI COMMERCIALIZZABILITÀ O IDONEITÀ PER UNO SCOPO SPECIFICO, SONO SOGGETTE AI LIMITI DI DURATA STABILITI NELLA GARANZIA SOPRA INDICATA. In nessun

caso Fellowes sarà ritenuta responsabile di danni indiretti o incidentali attribuibili a questo prodotto. La presente garanzia concede diritti legali specifici. La durata, i termini e le condizioni della presente garanzia sono validi in tutto il mondo, a eccezione dei luoghi in cui, in base alle norme di legge, siano previste limitazioni, restrizioni o condizioni diverse. Per maggiori dettagli al riguardo o per richiedere assistenza in garanzia, si raccomanda di contattarci direttamente o di consultare il rivenditore. Sono esclusi da questa garanzia gli accessori e i materiali usurabili.

NEDERLANDS

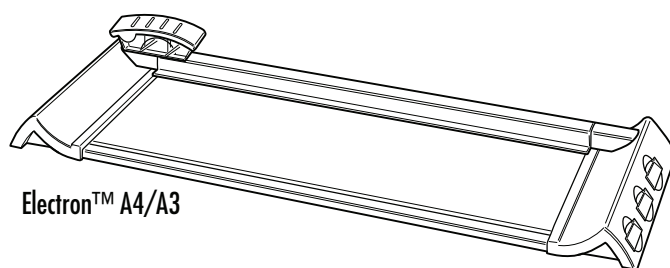

Electron™ A4/A3

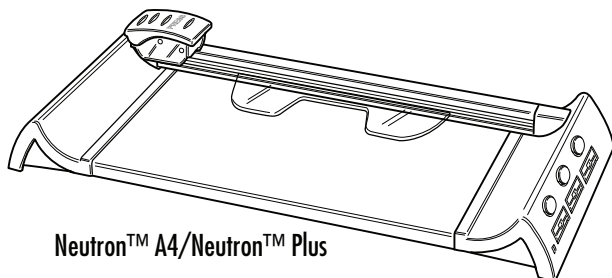

Neutron™ A4/Neutron™ Plus

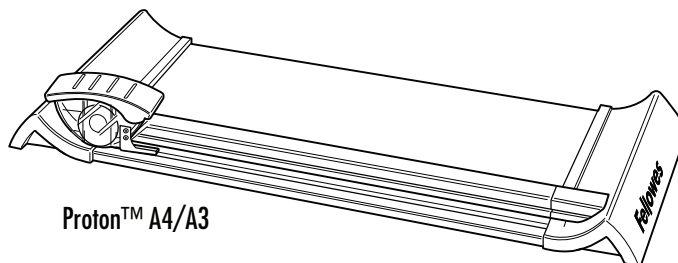

Proton™ A4/A3

CAPACITEITEN EN INHOUD

CRC nr.	Model	Aantal messen	Snijlengte (mm)	Snijcapaciteit (80 g vellen)
54100	Neutron A4	1	320	10
54101	Neutron Plus	4	320	10
54102	Proton A4	1	320	10
54103	Proton A3	1	460	10

CRC nr.	Model	Aantal messen	Snijlengte (mm)	Snijcapaciteit (80 g vellen)
54104	Electron A4	4	320	10
54105	Electron A3	4	460	10

VOORZICHTIG

- Let op: de messen zijn uitermate scherp.
- De SafeCut™ cassette omsluit de messen - niet proberen de messen met de hand naar buiten te trekken.
- Altijd toezicht houden op kinderen tijdens gebruik.
- De trimmer niet overbelasten.
- Huisdieren altijd uit de buurt van de trimmer houden terwijl deze wordt gebruikt.
- De trimmer niet proberen te openen op te repareren, daar dit de garantie ongeldig maakt. Neem bij eventuele vragen, contact op met uw klantendienst. Gelieve op te merken, dat deze garantie niet van toepassing is indien sprake is van misbruik, verkeerd gebruik of niet goedgekeurde reparatie.
- Niet proberen de SafeCut™ mescassettes te openen.

Hulp nodig?

Klantendienst
www.fellowes.com
 Laat onze deskundigen u helpen met een oplossing. Neem altijd eerst contact op met Fellowes alvorens contact op te nemen met de winkel waar u het product hebt gekocht.

PAPIER EN FOTO'S SNIJDEN

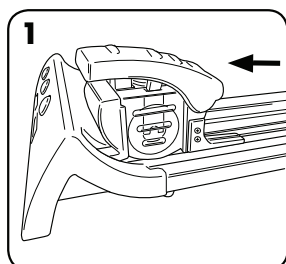

1. Trek het snijmechanisme naar één kant in de vergrendelde stand.

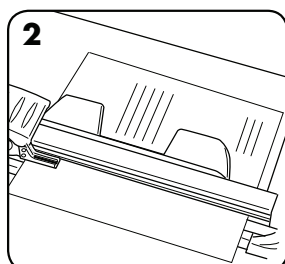

2. Leg het artikel (bijv. foto of papier) op de snijtafel.

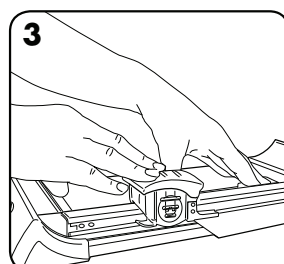

3. Houd het papier met uw hand of het klemmechanisme op zijn plaats. Duw de geleiderhendel van het snijmechanisme omlaag om het snijmes te activeren. (Electron: de led brandt wanneer de geleiderhendel omlaag wordt geduwd.)

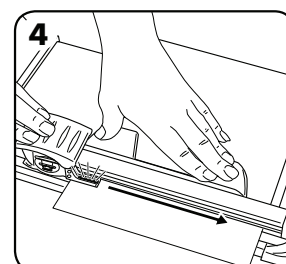

4. Om te snijden duwt u de hendel omlaag en schuift u het mechanisme totdat het einde van de stang bereikt wordt. Aan het einde van de stang laat u het snijmechanisme los, waarna het klemmechanisme wordt vrijgezet.

SAFECUT™ VEILIGHEIDSVORZIENINGEN

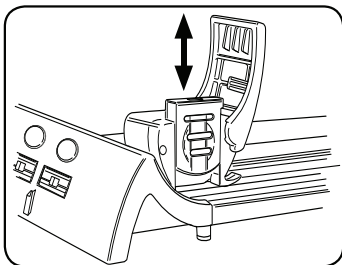

Het SafeCut™ cassettesysteem laat gebruikers de snijcassette vervangen zonder de messen aan te raken.

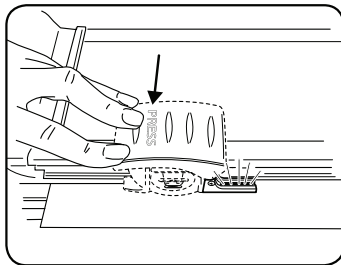

De SafeCut™ led-geleider op de Electron-trimmer voor verlichte precisie. Veiliger dan lasergeleiders.

ACCESSOIREPAKKETTEN

3 Creatieve SafeCut™ messen			Kesim kapasitesi (sayfa 80 gsm)
		Golfsnee	5
		Perforatie	5
		Vouw (plooi)	3

CRC nr.	Pakketinhoud
54113	3 Creatieve SafeCut™ messen (1x golf, 1x perforatie, 1x vouw)
54114	2 Rechte SafeCut™ messen
54115	A4 Snijstroken (x3)
54116	A3 Snijstroken (x3)

DE MESCASSETTE VERVANGEN

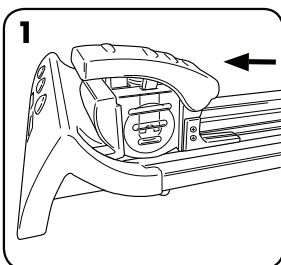

1. Schuif het snijmechanisme naar één kant in de vergrendelde stand.

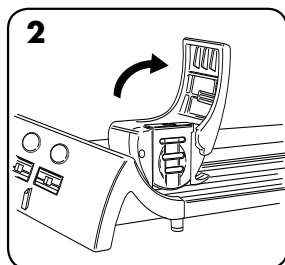

2. Til de geleiderhendel van het snijmechanisme omhoog.

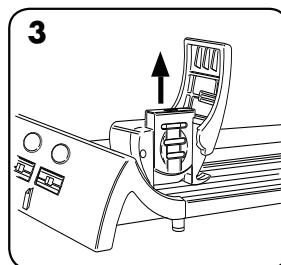

3. Trek de SafeCut™ cassette omhoog en uit het snijmechanisme en zet er een nieuwe cassette in (omlaag duwen om op zijn plaats te klikken).

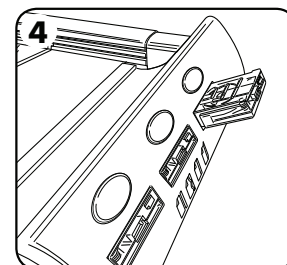

4. Druk op de gele knop om de cassette van het onderstuk los te maken. Stop de ongebruikte SafeCut™ terug in de sleuf in het onderstuk.

DE SNIJSTROOK VERVANGEN

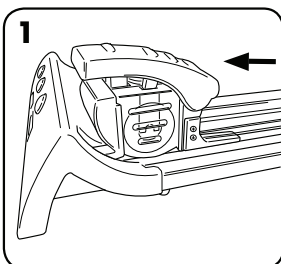

1. Schuif het snijmechanisme naar één kant in de vergrendelde stand.

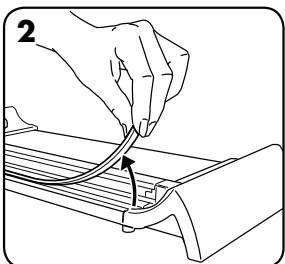

2. Verwijder de snijstrook van het onderstuk van de trimmer.

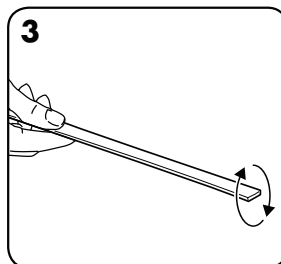

3. Draai de snijstrook om voor gebruik aan beide kanten.

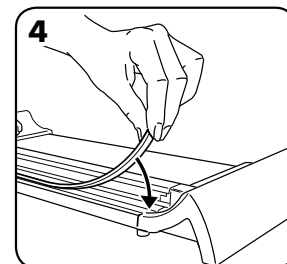

4. Er zijn vervangingsstroken verkrijgbaar (zie de accessoiredetails).

NEDERLANDS

ELECTRON SAFECUT™ LED-GELEIDER

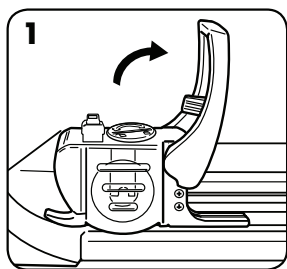

1. Schuif het snijmechanisme naar één kant in de vergrendelde stand. Trek (zwaai) de geleiderhendel van het snijmechanisme omhoog.

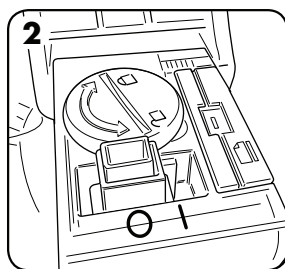

2. Zet de schakelaar op de AAN (I) stand.

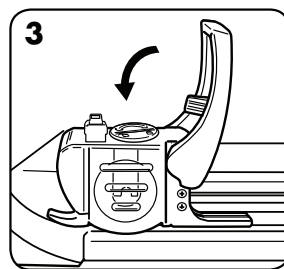

3. Trek (draai) de geleiderhendel van het het snijmechanisme omlaag.

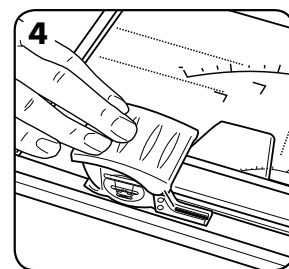

4. Druk de hendel omlaag om de SafeCut™ LED-geleider te activeren.

DE BATTERIJ VAN DE ELECTRON SAFECUT™ LED-GELEIDER VERVANGEN

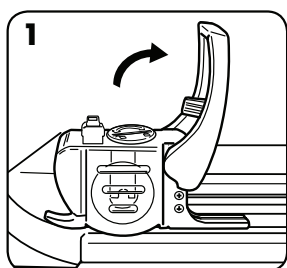

1. Schuif het snijmechanisme naar één kant in de vergrendelde stand. Trek (zwaai) de geleiderhendel van het snijmechanisme omhoog.

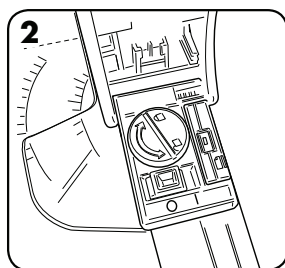

2. Schroef het deksel van de batterij los met een munt of schroevendraaier (naar links draaien opent, naar rechts sluit het batterijdeksel).

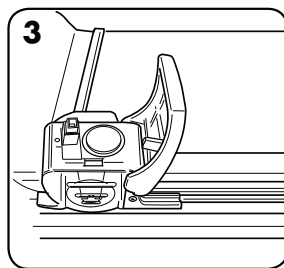

3. Verwijder de oude batterij en vervang hem met een nieuwe [type CR2023].

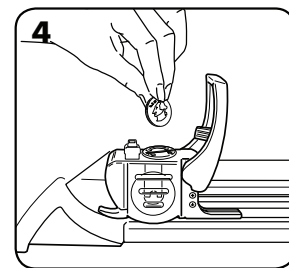

4. Batterijdeksel sluiten.

GARANTIE

Fellowes garandeert dat alle andere onderdelen van het apparaat zonder gebreken zijn wat betreft materiaal en vakmanschap gedurende 2 jaar vanaf datum van aankoop door de originele gebruiker. Als van enig onderdeel tijdens de garantieperiode wordt vastgesteld dat dit defect is, is uw enige en exclusieve verhaal de reparatie of vervanging van het defecte onderdeel, dit naar goeddunken en op kosten van Fellowes. Deze garantie is niet van toepassing in geval van misbruik, verkeerd gebruik of niet goedgekeurde reparatie. ALLE IMPLICIETE GARANTIES, WAARONDER GARANTIES MET BETREKKING TOT VERKOOPBAARHEID OF GESCHIKTHEID VOOR EEN BEPAALD DOEL,

WORDEN HIERBIJ BEPERKT IN DUUR TOT DE HIERBOVEN AANGEGEVEN TOEPASSELIJKE GARANTIEPERIODE. In geen geval is Fellowes aansprakelijk voor enige incidentele of gevolgschade die aan dit product kan worden verweten. Deze garantie geeft u specifieke wettelijke rechten. De duur, bepalingen en voorwaarden van deze garantie zijn wereldwijd geldig, behalve waar andere beperkingen, restricties of voorwaarden vereist kunnen worden door de plaatselijke wetgeving. Voor verdere details of om van de service te kunnen genieten onder deze garantie, gelieve met ons of met uw handelaar contact op te nemen. Accessoires en verbruiksgoederen zijn van deze garantie uitgesloten.

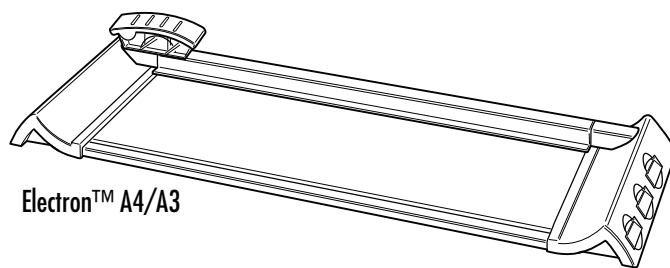

Electron™ A4/A3

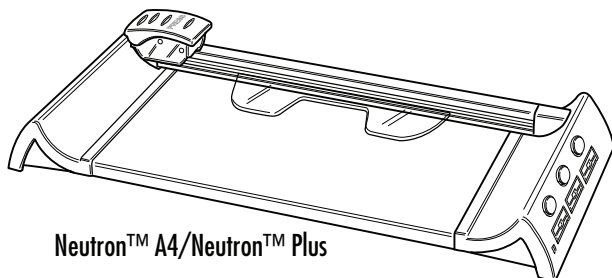

Neutron™ A4/Neutron™ Plus

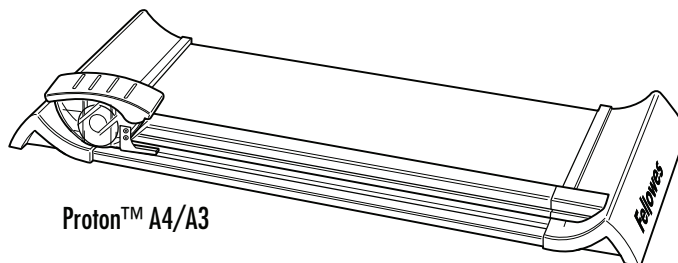

Proton™ A4/A3

KAPACITETER OCH INNEHÅLL

CRC nr.	Modell	Antal blad	Skärlängd (mm)	Skärkapacitet (ark 80 g)
54100	Neutron A4	1	320	10
54101	Neutron Plus	4	320	10
54102	Proton A4	1	320	10
54103	Proton A3	1	460	10

CRC nr.	Modell	Antal blad	Skärlängd (mm)	Skärkapacitet (ark 80 g)
54104	Electron A4	4	320	10
54105	Electron A3	4	460	10

VIKTIGA SÄKERHETS ANVISNINGAR — Läs före användning!

⚠ VAR FÖRSIKTIG

- Var försiktig: Bladen är extremt vassa.
- SafeCut™-kassetten omger bladen – försök inte att fälla ut bladen manuellt.
- Övervaka alltid barn vid användning.
- Överbelasta inte skärmaskinen.
- Husdjur får inte komma i närheten av skärmaskinen.
- Försök inte att öppna eller reparera maskinen då detta skadar din garanti. Kontakta kundtjänsten om du har frågor. Denna garanti gäller inte där varan utsatts för missbruk, felaktig hantering eller oauktorerad reparation.
- Försök inte att öppna SafeCut™-bladens kassett.

Behöver du hjälp?

Kundservice
www.fellowes.com
 Låt våra experter hjälpa dig med en lösning. Ring alltid Fellowes innan du kontaktar inköpsstället.

ATT SKÄRA PAPPER OCH BILDER

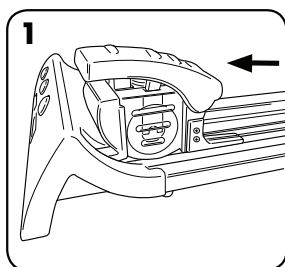

1. För skärvagnen till läsläget på ena sidan.

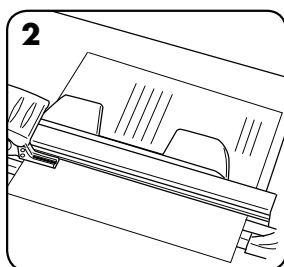

2. Placera arket (bilden eller pappret) på skärbordet.

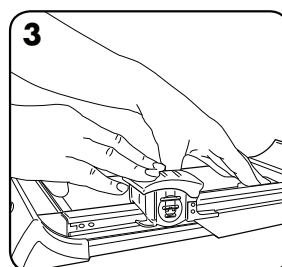

3. Håll pappret stilla med handen eller med klämmekanismen. Tryck vagnens handtag nedåt för att aktivera skärbladet. (Electron: när handtaget trycks ned lyser lysdioden.)

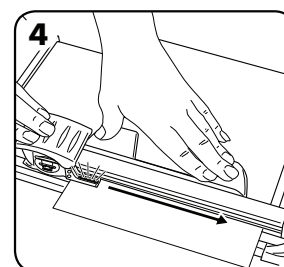

4. För att skära trycker du ned handtaget och för vagnen till ändläget. I ändläget släpper du vagnen och lossar därmed klämmekanismen.

SAFECUT™ SÄKERHETSFUNCTIONER

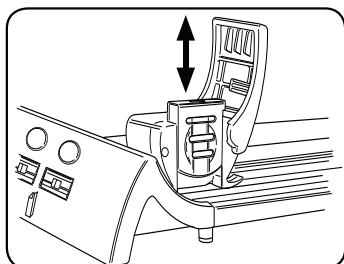



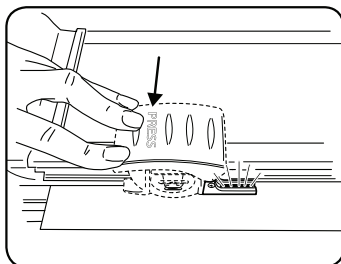



SafeCut™ kassettsystem gör att användaren kan byta skärvagnen utan att röra bladen.



SafeCut™ lysdiodguide på skärmaskinen Electron för ökad precision. Säkrare än laser.

TILLBEHÖRSPAKET

3 kreativa SafeCut™ -blad		Skärkapacitet (ark 80 g)
 	Vågskärning	5
 	Perforering	5
 	Vikning (anvisning)	3

CRC#	Paketens innehåll
54113	3 kreativa SafeCut™ -blad (1x vågformat, 1x perforering, 1x vikning)
54114	2 raka SafeCut™-blad
54115	A4 Klipprensor (x3)
54116	A3 Klipprensor (x3)

ATT BYTA BLADKASSETT

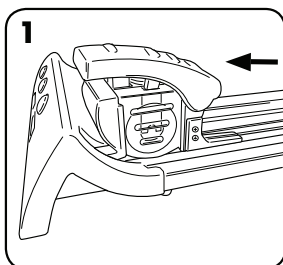

1. För skärvagnen till läsläget på ena sidan.

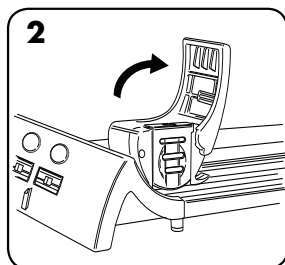

2. Lyft vagnens handtag uppåt.

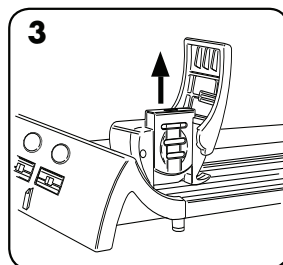

3. Drag SafeCut™-kassetten uppåt från skärvagnen och för in den nya kassetten (tryck nedåt tills den klickar i läge).

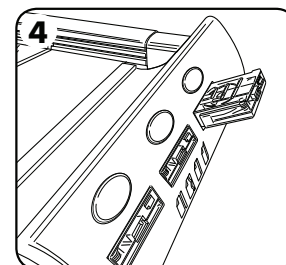

4. Tryck på den gula knappen för att lossa kassetten från basen. Sätt tillbaka den SafeCut™ som inte används i basens förvaringspår.

ATT BYTA KLIPPREMSA

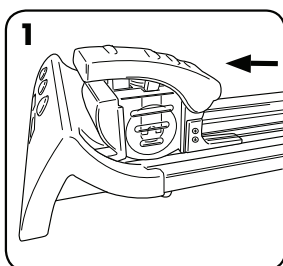

1. För skärvagnen till läsläget på ena sidan.

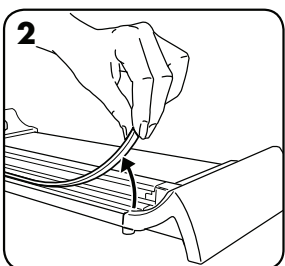

2. Ta bort klippremsan från skärmaskinens bas.

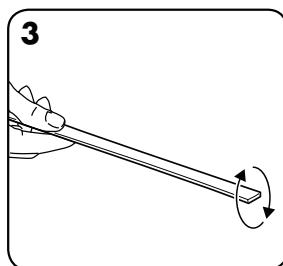

3. Vänd på remsan för att använda båda sidor.

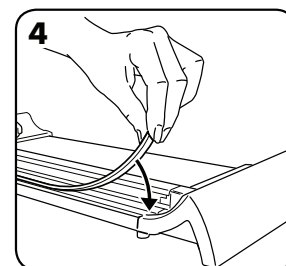

4. Det finns utbytesremsor att tillgå (se information om tillbehör).

ELECTRON SAFECUT™ LED GUIDE

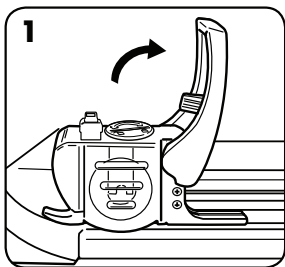

1. För skärvagnen till läsläget på ena sidan. Drag (vrid) vagnens handtag uppåt.

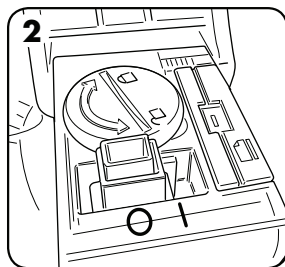

2. Slå PÅ strömbrytaren till (I) positionen.

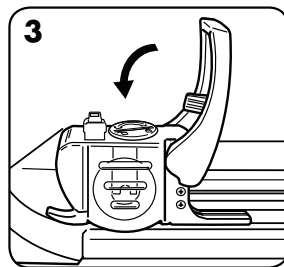

3. Skjut (vippa) ner slädhandtaget.

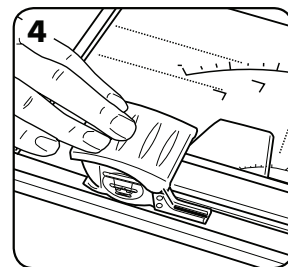

4. Tryck ner handtaget för att aktivera SafeCut™ LED Guide.

ATT BYTA BATTERI PÅ ELECTRON SAFECUT™ LYSDIODSGUIDE

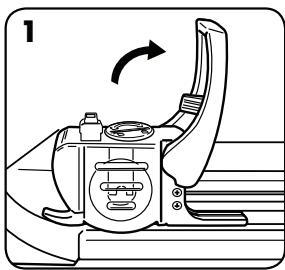

1. För skärvagnen till läsläget på ena sidan. Drag (vrid) vagnens handtag uppåt.

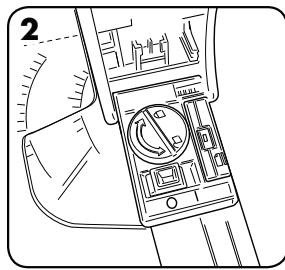

2. Skruva av batteriluckan med ett mynt eller skruvmejsel (åt vänster öppnar och åt höger stänger batteriluckan).

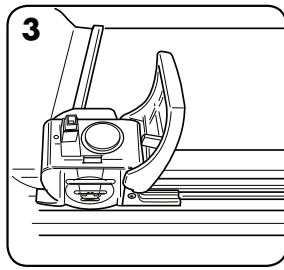

3. Tag ur det gamla batteriet och sätt i ett nytt [typ CR2023].

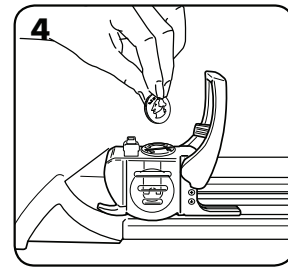

4. Stäng batteriluckan.

GARANTI

Fellowes garanterar att alla andra delar av maskinen är fria från materialfel eller tillverkningsfel i upp till två (2) år efter försäljning till första kund. Om någon del är defekt under garantiperioden kommer den enda och uteslutande ersättningen att bli reparation eller en ersättningsprodukt enligt Fellowes val och kostnad motsvarande den defekta delen. Denna garanti gäller inte där varan utsatts för missbruk, felaktig hantering eller oauktorerad reparation. **ALLA UNDERFÖRSTÅDDA GARANTIER, INKLUSIVE SÄLJBARHET ELLER LÄMPLIGHET FÖR NÅGOT SPECIELLT ÄNDAMÅL, BEGRÄNSAS HÄRI**

GENOM DEN TILLÄMPLIGA GARANTIPERIODEN SOM ANGES OVAN. Inte i något fall kan Fellowes ansvara för följskador eller olyckor kopplade till den här produkten. Den här garantin ger dig specifika juridiska rättigheter. Villkoren och varaktigheten för denna garanti gäller överallt utom där lagstiftningen ställer andra begränsningar eller villkor. För vidare information eller för att erhålla garantiservice skall försäljningsställe eller Fellowes kontaktas. Tillbehör och förbrukningsvaror exkluderas ur denna garanti.

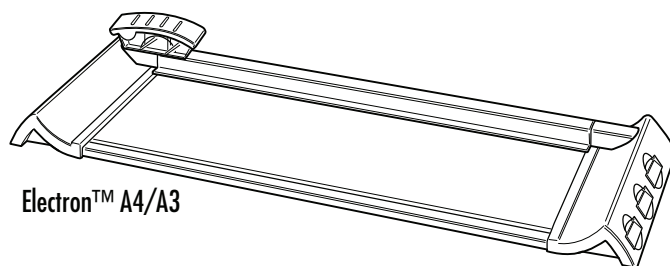

Electron™ A4/A3

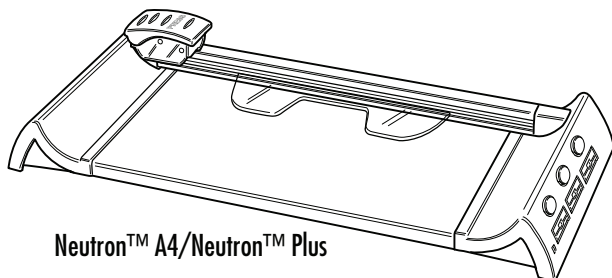

Neutron™ A4/Neutron™ Plus

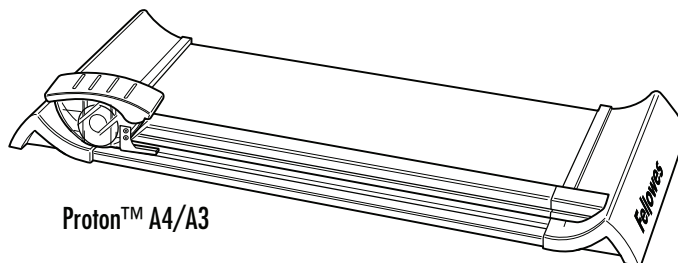

Proton™ A4/A3

KAPACITETER OG INDHOLD

CRC nr.	Model	Antal blade	Skærelængde (mm)	Skærekapacitet (ark 80 g)
54100	Neutron A4	1	320	10
54101	Neutron Plus	4	320	10
54102	Proton A4	1	320	10
54103	Proton A3	1	460	10

CRC nr.	Model	Antal blade	Skærelængde (mm)	Skærekapacitet (ark 80 g)
54104	Electron A4	4	320	12 10
54105	Electron A3	4	460	18 10

VIGTIGT SIKKERHEDSANVISNINGER – Læs for brug!



- Advarsel: bladene er ekstremt skarpe.
- SafeCut™ kassetten indeholder blade – forsøg ikke at tage bladene ud manuelt.
- Børn skal altid overvåges under brug.
- Makulatorene må ikke overbelastes.
- Hold kæledyr væk fra makulatorene når den er i brug.
- Maskinen må ikke åbnes, og der må ikke foretages reparationer, da dette ugyldiggør garantien. Kontakt Kundeservice hvis du har nogle spørgsmål. Denne garanti gælder ikke i tilfælde af overlast, misbrug eller uautoriseret reparation.
- Forsøg ikke at åbne SafeCut™ bladpatronerne.

Brug for hjælp?

Kundeservice
www.fellowes.com
 Lad vore eksperter hjælpe dig med at finde en løsning. Ring altid først til Fellowes før leverandøren kontaktes.

SKÆRING AF PAPIR OG FOTOGRAFIER

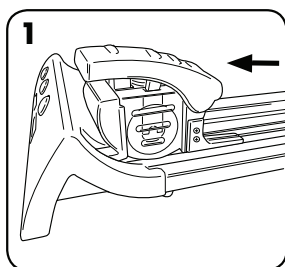

1. Skub skæreslæden til en ende og lås den i position.

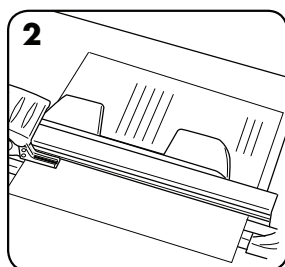

2. Anbring emnet (f.eks. foto eller papir) på skærebordet.

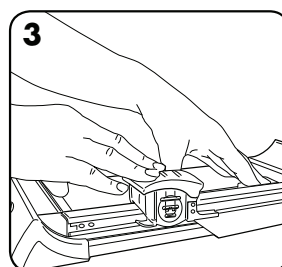

3. Hold fast på papiret med hånden eller klemmekanismen. For at aktivere skærebladet, tryk slædens håndtag ned. (Electron: når håndtaget trykkes ned, lyser LED.)

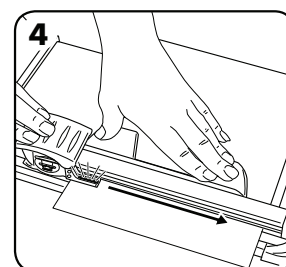

4. For at skære, skal håndtaget skubbes nedad og slæden skubbel langs med kanten, indtil den når enden af stangen. Slip slæden ved slutningen af stangen, hvorefter klemmekanismen udløses.

SAFECUT™ SIKKERHEDSFUNKTIONER

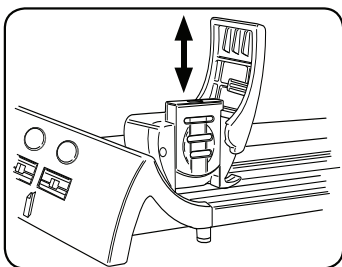

Systemet SafeCut™ patronen giver brugeren mulighed for at udskifte skærepatronen uden at røre ved bladene.

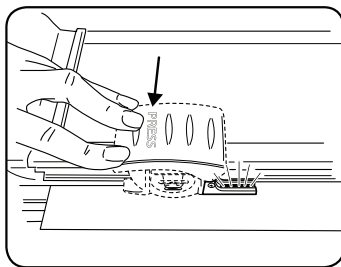

SafeCut™ LED-styr på Electron makulatoren for oplyst præcision. Mere sikker end laserstyr.

TILBEHØRSPAKKER

3 kreative SafeCut™ blade		Skærekapacitet (ark 80 g)
	Bølgeformet skæring	5
	Perforering	5
	Folde (markeringslinje)	3

CRC#	Pakken indeholder
54113	3 kreative SafeCut™ blade (1 stk. bølgeformet, 1 stk. perforeret, 1 stk. foldet)
54114	2 SafeCut™ blade til lige skæring
54115	A4 skærestimler (3 stk.)
54116	A3 skærestimler (3 stk.)

UDSKIFTNING AF BLADETS KASSETTE

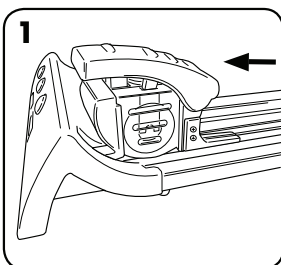

1. Skub skæreslæden til en ende og lås den i position.

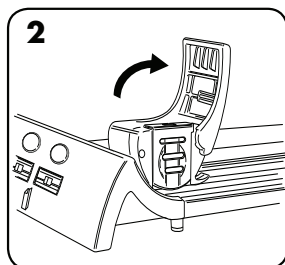

2. Løft slædens håndtag op.

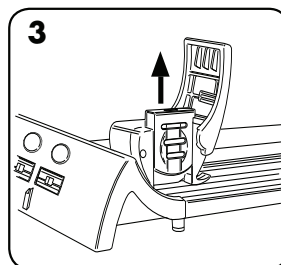

3. Træk SafeCut™ patronen op og ud af skærepatronen og sæt en ny patron i (skub den ned for at klikke den på plads).

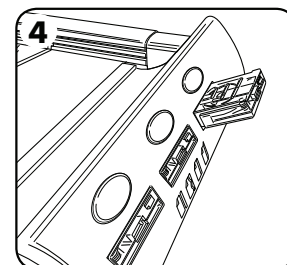

4. Tryk på den gule knap for at udløse kassetten fra bunden. Sæt den ubrugte SafeCut™ tilbage i opbevaringsrillen i bunden.

UDSKIFTNING AF SKÆRESTRIMLER

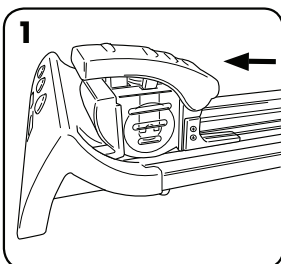

1. Skub skæreslæden til en ende og lås den i position.

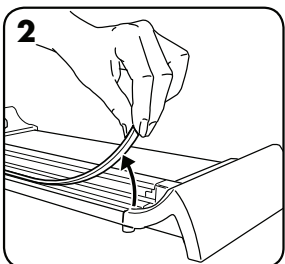

2. Tag skærestrimlen ud af makulatorens bund.

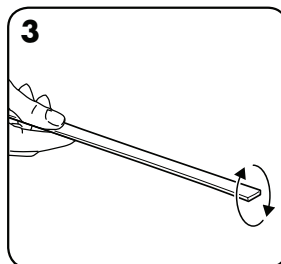

3. Vend skærestrimlen for at bruge begge sider.

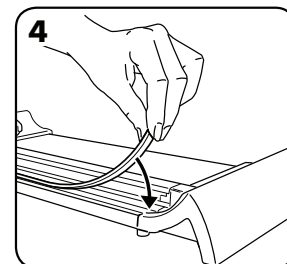

4. Ekstra strimler er tilgængelige (se detaljerne om tilbehør).

ELECTRON SAFECUT™ LED-GUIDE

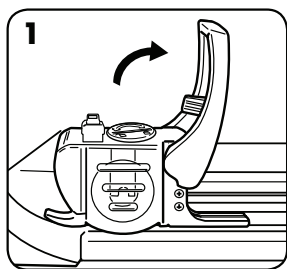

1. Skub skæreslæden til en ende og lås den i position. Træk (sving) slædens håndtag op.

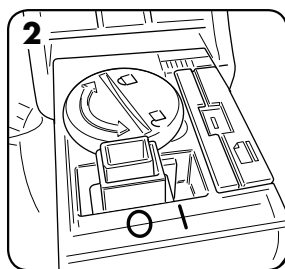

2. Drej afbryderknappen til TÆNDT (I)-stilling

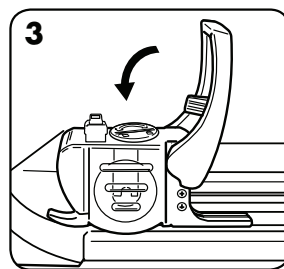

3. Træk (sving) slædehåndtaget nedad.

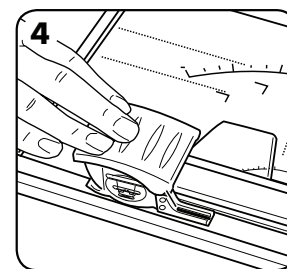

4. Tryk håndtaget ned for at aktivere SafeCut™ LED-Guide.

UDSKIFTNING AF BATTERIET PÅ ELECTRON SAFECUT™ LED-STYRET

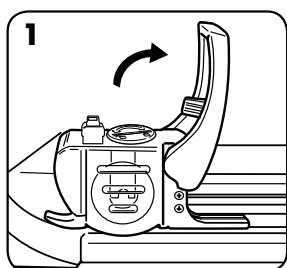

1. Skub skæreslæden til en ende og lås den i position. Træk (sving) slædens håndtag op.

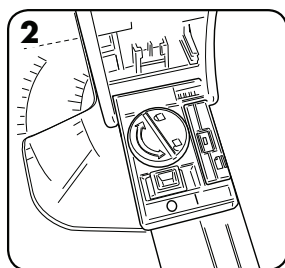

2. Skru batteridækslet løst med en mønt eller en skruetrækker (åbn mod uret, luk med uret).

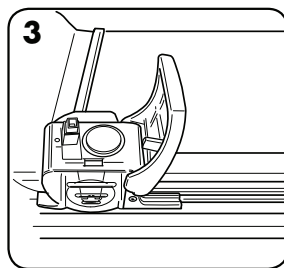

3. Tag det gamle batteri ud og sæt et nyt i [type CR2023].

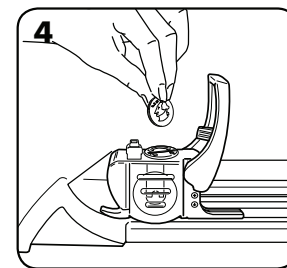

4. Luk batterilåget.

GARANTI

Fellowes garanterer at alle andre maskindele er fri for materialedefekter og fabriktionsfejl i 2 år fra den originale kundes købsdato. Hvis det konstateres, at en del er defekt under garantiperioden, vil den eneste og eksklusive afhjælpende foranstaltning være reparation eller ombytning, efter Fellowes' valg og omkostning, af den defekte del. Denne garanti gælder ikke i tilfælde af overlast, misbrug eller uautoriseret reparation. ENHVER IMPLICIT GARANTI, INKLUSIV SALGBARHED ELLER BRUGSEGNETHED TIL ET SPECIELT FORMÅL, ER HERMED BEGRÆNSET I VARIGHED TIL DEN

PÅGÆLDENDE GARANTIPERIODE SOM NÆVNT OVENFOR. Fellowes hæfter under ingen omstændigheder for følgende eller hændelige skader, der kan henføres til dette produkt. Denne garanti giver dig specifikke lovlige rettigheder. Varighed, betingelser og vilkår under denne garanti er gældende på verdensplan, undtagen hvor andre begrænsninger, restriktioner eller forhold kræves af den lokale lov. For yderligere detaljer eller for service under denne garanti, bedes du kontakte os eller din forhandler. Ekstraudstyr og hjælpematerialer er ikke inkluderet i denne garanti.

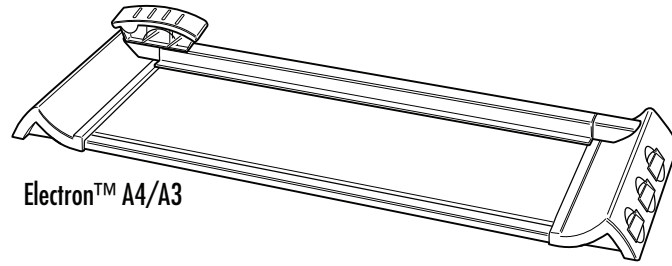

Electron™ A4/A3

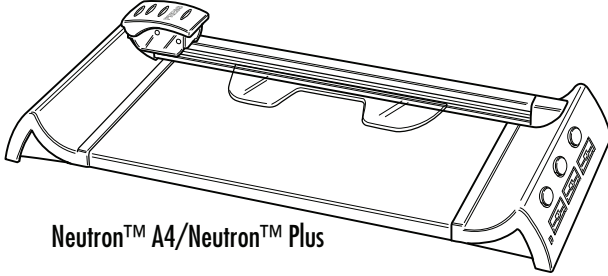

Neutron™ A4/Neutron™ Plus

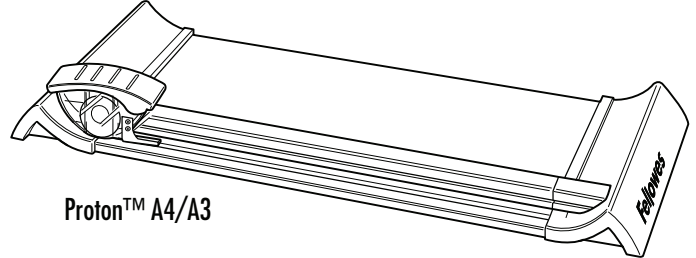

Proton™ A4/A3

KAPASITEETIT JA SISÄLTÖ

CRC NRO	Malli	Terien lukumäärä	Leikkauspituus (mm)	Leikkaus-kapasiteetti (arkit 80 gsm)
54100	Neutron A4	1	320	10
54101	Neutron Plus	4	320	10
54102	Proton A4	1	320	10
54103	Proton A3	1	460	10

CRC NRO	Malli	Terien lukumäärä	Leikkauspituus (mm)	Leikkaus-kapasiteetti (arkit 80 gsm)
54104	Electron A4	4	320	10
54105	Electron A3	4	460	10

TÄRKEITÄ TURVAOHJEITA – Lue ennen käyttöä!

VAROITUS

- Varoitus: Terät ovat erittäin teräviä.
- SafeCut™-kasetti sulkee terät – älä yritä vetää teriä ulos käsin.
- Ole aina varuillasi lasten suhteen käytön aikana.
- Älä ylikuormita leikkuria.
- Pidä lemmikkieläimet poissa leikkurin läheltä käytön aikana.
- Älä avaa tai yritä korjata leikkuria, koska se voi mitätöidä takuun. Asiakaspalvelu antaa lisätietoja. Huomautus: Takuu ei kata väärinkäyttöä, virheellistä käsittelyä tai valtuuttamatonta korjausta.
- Älä yritä avata SafeCut™-teräkasetteja.

Tarvitsetko apua?

Asiakaspalvelu
www.fellowes.com
Asiantuntijamme auttavat
kaikissa ongelmissa. Ota yhteyttä
asiakaspalveluun, ennen kuin
otat yhteyttä jälleenmyyjään.

PAPERIN JA VALOKUVIEN LEIKKAAMINEN

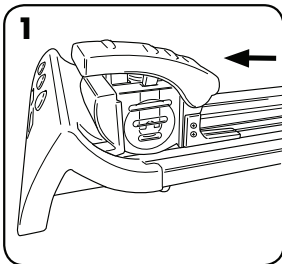

1. Vedä leikkausluisti toiseen päähän lukitusasentoon.

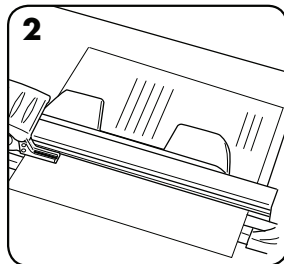

2. Aseta arkki (esim. valokuva tai paperi) leikkaustasolle.

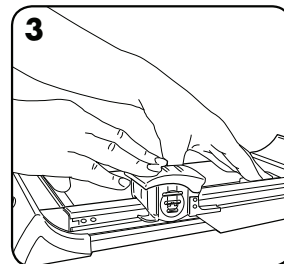

3. Pidä paperia paikallaan käsin tai lukitusmekanismin avulla. Käynnistä leikkuuterä painamalla luistin kahva alas. (Electron: Kun painat kahvan alas, valodiodi palaa.)

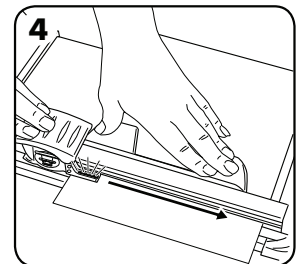

4. Leikkaa painamalla kahva alas ja vetämällä luisti mukana palkin päähän saakka. Kun luisti on palkin päässä, päästä se irti, jolloin lukitusmekanismi vapautuu.

SAFECUT™-TURVATOIMINNOT

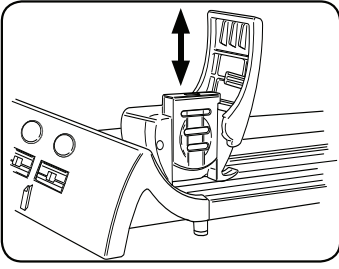



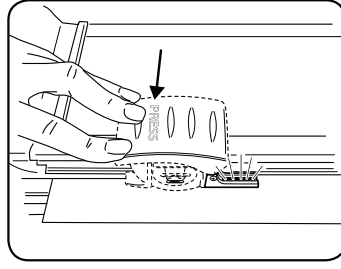



SafeCut™-kasetin avulla käyttäjä voi vaihtaa leikkaukaskasetin koskematta teriin.



Electron-leikkurin SafeCut™-lediohjain antaa tarkkuutta merkivalojen avulla. Turvallisempi kuin laserohjaimet.

LISÄVARUSTEPAKETIT

3 erikoismallista SafeCut™-terää		Leikkauk-kapasiteetti (arkit 80 gsm)
	 Aaltoleikkaus	5
	 Rei'itys	5
	 Taitto (laskos)	3

CRC nro	Paketin sisältö
54113	3 erikoismallista SafeCut™-terää (1x aalto, 1x reikä, 1x taite)
54114	2 suoraa SafeCut™-terää
54115	A4 leikkauksluskat (x3)
54116	A3 leikkauksluskat (x3)

TERÄKASETIN VAIHTAMINEN

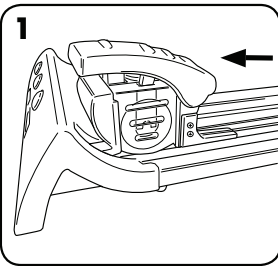

1. Vedä leikkauksluisti toiseen päähän lukitusasentoon.

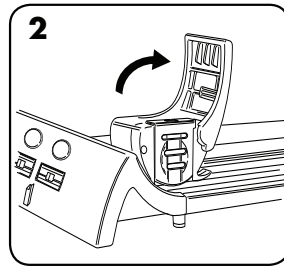

2. Nosta luistin kahva ylös.

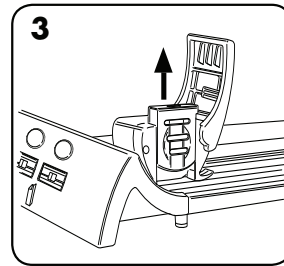

3. Vedä SafeCut™-kasetti ylös ja ulos leikkauksluistista ja aseta uusi kasetti tilalle (paina napsauttaaksesi paikalleen).

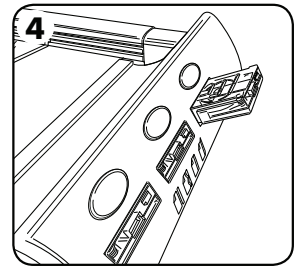

4. Paina keltaista painiketta vapauttaaksesi kasetin alustasta. Palauta käyttämätön SafeCut™ alustassa olevaan säilytysvennykseen.

LEIKKAUSLIUSKAN VAIHTAMINEN

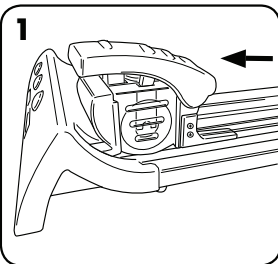

1. Vedä leikkauksluisti toiseen päähän lukitusasentoon.

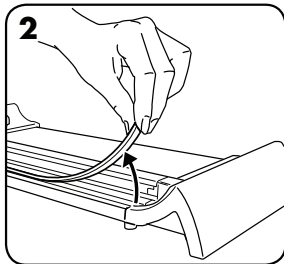

2. Vedä leikkauksluska irti leikkurin alustasta.

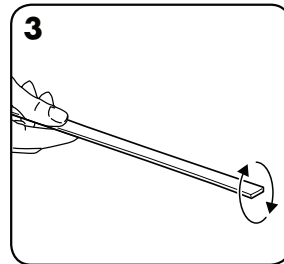

3. Käännä leikkauksluska ympäri käyttääksesi molemmat puolet.

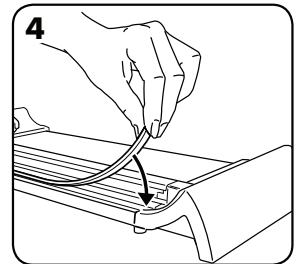

4. Vaihdoniuskoja on saatavilla tarvikkeena (ks. lisävarusteiden yksityiskohdat).

ELECTRON SAFECUT™ -LEDIOHJAIN

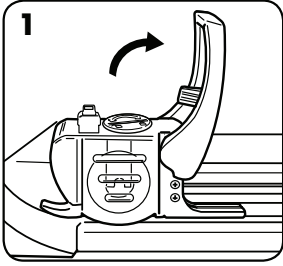

1. Vedä leikkausluisti toiseen päähän lukitusasentoon. Vedä (käännä) luistin kahva ylös.

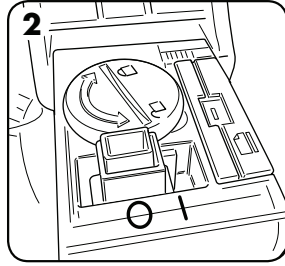

2. Käännä kytkin PÄÄLLE (I).

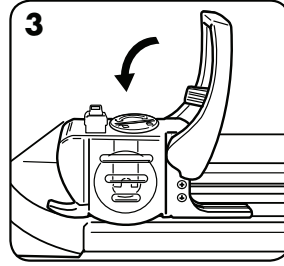

3. Vedä (käännä) luistin kahva alas.

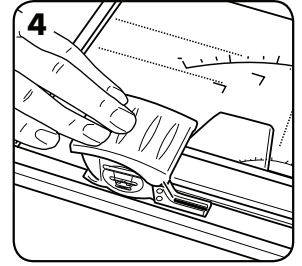

4. Paina kahva alas käynnistääkseen SafeCut™-lediohjaimen.

VAIHTA ELECTRON SAFECUT™ -LEDIOHJAIMEN PARISTO

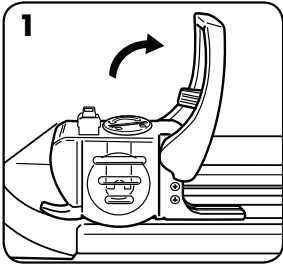

1. Vedä leikkausluisti toiseen päähän lukitusasentoon. Vedä (käännä) luistin kahva ylös.

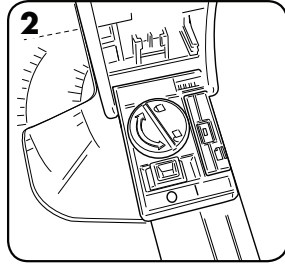

2. Ruuvaa paristokansi irti kolikolla tai ruuvimeisselillä (kierto vasemmalle avaa ja kierto oikealla sulkee paristokannen).

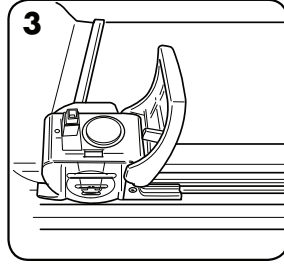

3. Poista vanha paristo ja vaihda uuteen [tyyppi CR2023].

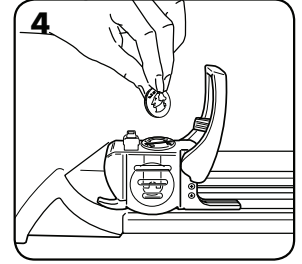

4. Sulje paristokansi.

TAKUU

Fellowes takaa, että koneen kaikissa muissa osissa ei ole materiaali- tai valmistusvika 2 vuoden ajan tuotteen alkuperäisestä ostopäivästä. Jos osassa havaitaan vika takuuaikana, ainoana ja yksinomaisena ratkaisuna on viallisen osan korjaus tai vaihto Fellowesin valinnan mukaan ja kustannuksella. Takuu ei kata väärinkäyttöä, virheellistä käsittelyä tai valtuuttamatonta korjausta. **KAIKKIEN HILJAISTEN TAKUIDEN, MUKAAN LUKIEN KAUPALLISTAMINEN TAI SOVELTUVUUS TIETTYÄ TARKOITUSTA VARTEN, KESTO**

ON SITEN RAJATTU EDELLÄ MÄÄRÄTYN TAKUUAJAN MUKAISESTI. Fellowes ei vastaa missään tapauksessa tästä tuotteesta johtuvista välillisistä vahingoista. Tämä takuu antaa sinulle erityiset lainmukaiset oikeudet. Tämän takuun kesto ja ehdot ovat voimassa maailmanlaajuisesti lukuun ottamatta paikallisen lainsäädännön edellyttämiä erilaisia rajoituksia tai ehtoja. Lisätietoja tai takuun alaisia palveluja on saatavissa meiltä tai jälleenmyyjältäsi. Lisävarusteet ja tarvikkeet eivät kuulu tämän takuun piiriin.

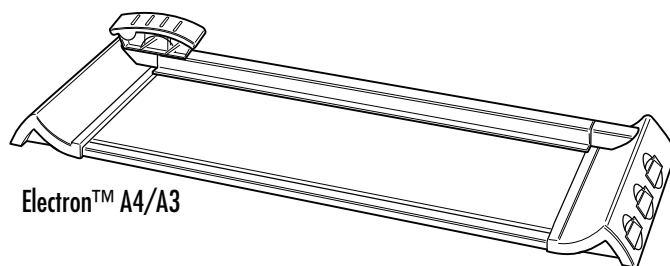

Electron™ A4/A3

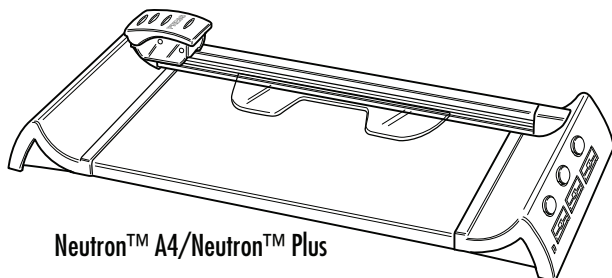

Neutron™ A4/Neutron™ Plus

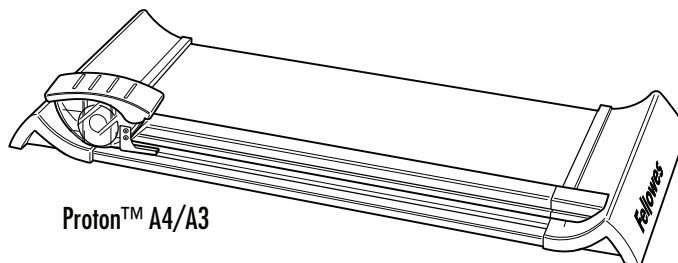

Proton™ A4/A3

KAPASITETER OG INNHOLD

CRC no.	Modell	Antall kniver	Skjærelengde (mm)	Skjærekapasitet (ark 80 g)
54100	Neutron A4	1	320	10
54101	Neutron Plus	4	320	10
54102	Proton A4	1	320	10
54103	Proton A3	1	460	10

CRC no.	Modell	Antall kniver	Skjærelengde (mm)	Skjærekapasitet (ark 80 g)
54104	Electron A4	4	320	10
54105	Electron A3	4	460	10

VIKTIGE SIKKERHETS- ANVISNINGER – Leses før bruk!



- Obs: Knivene er ekstremt kvasse.
- SafeCut™-kassetten dekker knivene - ikke prøv å dra ut knivene for hånd.
- Hold oppsyn med barn når maskinen er i bruk.
- Ikke overbelast skjæremaskinen.
- Hold alle kjæledyr borte fra skjæremaskinen når den er i bruk.
- Ikke åpne eller prøv å reparere den fordi dette gjør garantien ugyldig. Kontakt Kundeservice hvis du har spørsmål. Merk at garantien ikke gjelder ved misbruk, feil bruk, uvøren håndtering eller ikke-autoriserte reparasjoner.
- Ikke prøv å åpne SafeCut™-kassetten.

Trenger du hjelp?

Kundeservice
www.fellowes.com
 La ekspertene våre hjelpe deg med en løsning. Ring oss før du kontakter forhandleren.

TRIMMING AV PAPIR OG FOTO

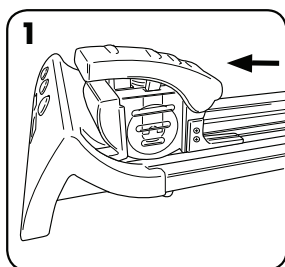

1. Skyv skjærevognen til siden i låseposisjon.

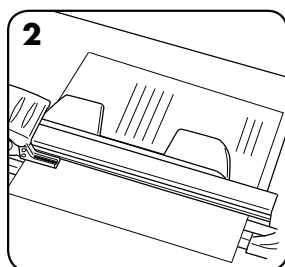

2. Plasser objekt (f.eks. foto eller papir) på skjærebrettet.

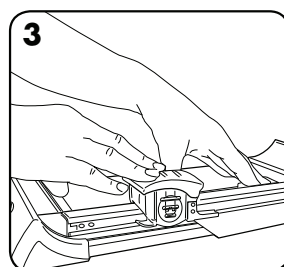

3. Hold papiret fast med hånden eller klemmekanismen. For å aktivere skjæreknivene, trykk ned håndtaket. (Electron: når håndtaket trykkes ned, lyser LEDen.)

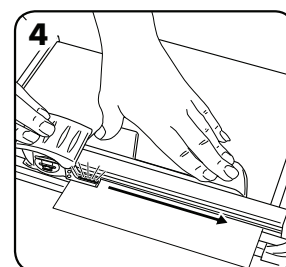

4. For å skjære trykkes håndtaket ned, og skyv vognen frem til den kommer til enden av skinnen. På enden av skinnen slippes vognen, og klemmekanismen frigjøres.

SAFECUT™ SIKKERHETSEGENSKAPER

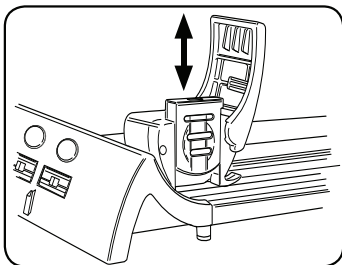



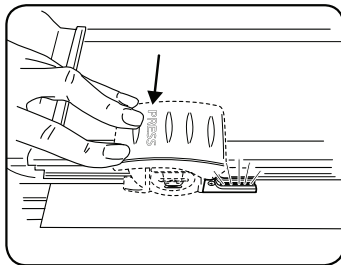



Med SafeCut™-kassettsystemet kan brukeren skifte skjærekassetten uten å komme bort i knivene.

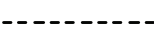

SafeCut™ LED-lys på Electron skjæremaskiner for opplyst presisjon. Mer sikker enn laserveiledning.

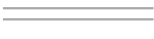
TILBEHØRSPAKKER

3 Kreative SafeCut™-kniver		Skjærekapasitet (ark 80 g)
	 Bølgekutt	5
	 Perforere	5
	 Brette (folde)	3

CRC#	Pakkeinnhold
54113	3 Kreative SafeCut™-kniver (1x bølge, 1x perforert, 1x brett)
54114	2 Rette SafeCut™-kniver
54115	A4 Skjæreremser (x3)
54116	A3 Skjæreremser (x3)

SKIFTE KNIVKASSETT

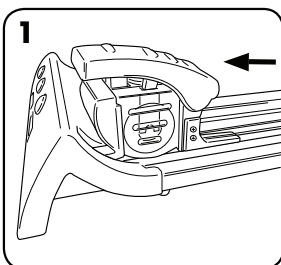

1. Skyv skjærevognen til siden i låseposisjon.

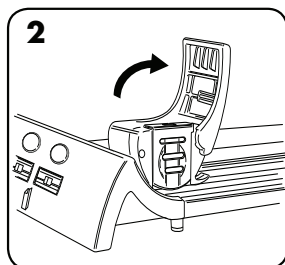

2. Løft opp håndtaket.

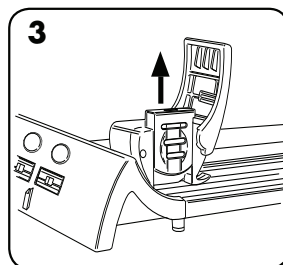

3. Trekk SafeCut™-kassetten oppover ut av skjærevognen, og sett inn en ny kassett (trykk ned og klikk den på plass).

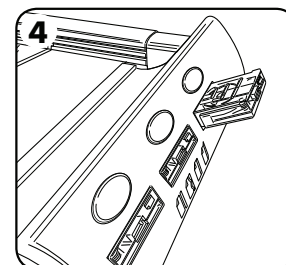

4. Trykk på den gule knappen, for å frigjøre kassetten fra skjærebrettet. Sett ubrukt SafeCut™ inn på skjærebrettets lagringsplass.

SKIFTE SKJÆREREMSE

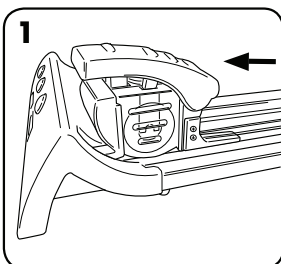

1. Skyv skjærevognen til siden i låseposisjon.

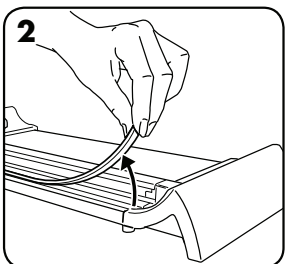

2. Fjern skjæreremsen fra brettet.

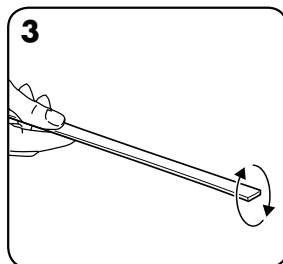

3. Vend skjæreremsen over, for å bruke begge sider.

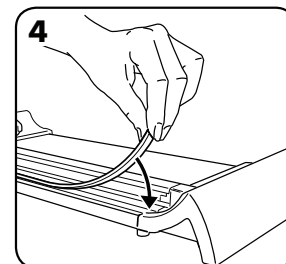

4. Tilgjengelige reserveremser (se detaljer for tilbehør).

ELECTRON SAFECUT™ LED-LYS

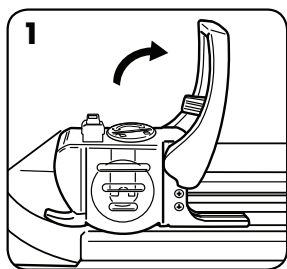

1. Skyv skjærevognen til siden i låseposisjon. Trekk (sving) håndtaket opp.

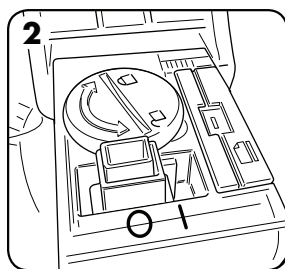

2. Slå PÅ (I) bryteren.

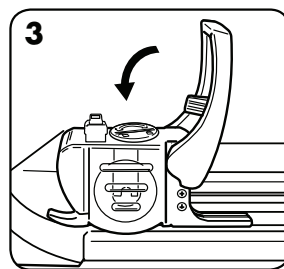

3. Trekk (sving) håndtaket ned.

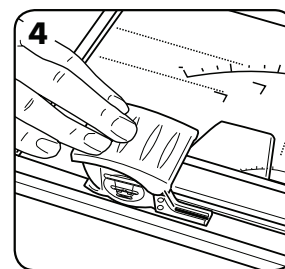

4. Trykk ned håndtaket for å aktivere SafeCut™ LED-lys.

SKIFTE BATTERI PÅ ELECTRON SAFECUT™ LED-LYS

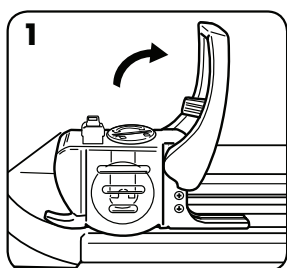

1. Skyv skjærevognen til siden i låseposisjon. Trekk (sving) håndtaket opp.

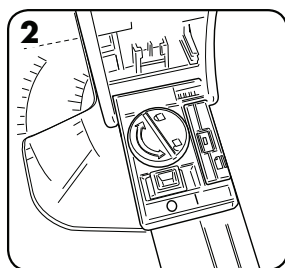

2. Åpne batteridekselet med en mynt eller et skrujern (skru mot venstre for å åpne, skru mot høyre for å lukke).

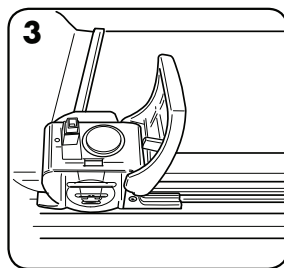

3. Fjern det gamle batteriet, og sett inn et nytt batteri [type CR2023].

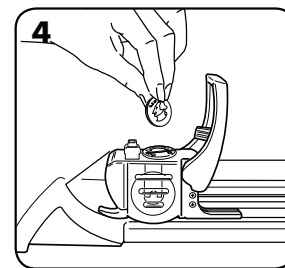

4. Lukk batterideksel.

GARANTI

Fellowes garanterer at alle andre deler av maskinen er uten defekter i materiale og utførelse i 2 år fra den opprinnelige forbrukers kjøpsdato. Hvis noen deler finnes å være defekte i garantiperioden, vil din eneste og eksklusive godtgjørelse være reparasjon eller skifting av delen, etter Fellowes' valg og for deres kostnad. Denne garantien gjelder ikke i tilfeller med misbruk, feilhåndtering eller ikke-autorisert reparasjon. **ENHVER UNDERFORSTÅTT GARANTI, INKLUDERT DET SOM MÅTTE GJELDE SALGBARHET ELLER EGNETHET FOR ET BESTEMT FORMÅL, ER HERVED BEGRENSET TIL VARIGHETEN AV DEN**

AKTUELLE GARANTIPERIODEN SOM ER ANGITT OVENFOR. Ikke under noen omstendigheter skal Fellowes være ansvarlig for noen følgesmessige eller tilfeldige skader i forbindelse med dette produktet. Denne garantien gir deg bestemte juridiske rettigheter. Garantien varighet, vilkår og betingelser er gyldige verden over, unntatt der ulike begrensninger, restriksjoner eller betingelser bestemmes av lokale lover. Du kan ta kontakt med oss eller forhandleren for mer informasjon, eller for å få service i forbindelse med denne garantien. Tilbehør og forbruksvarer er utelukket fra denne garantien.

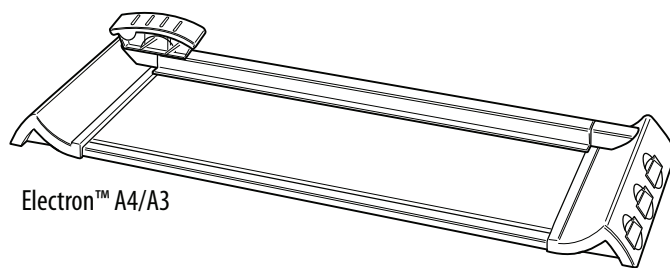

Electron™ A4/A3

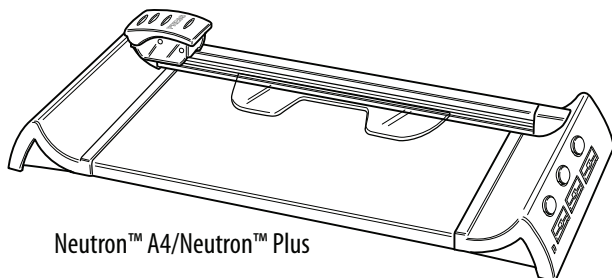

Neutron™ A4/Neutron™ Plus

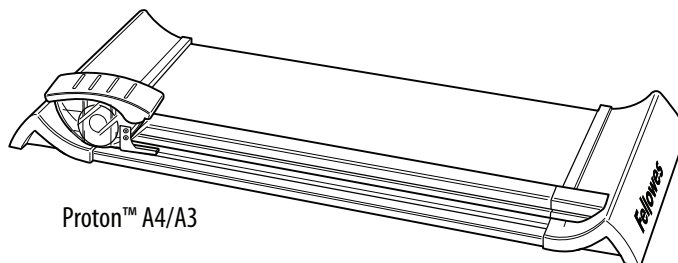

Proton™ A4/A3

PARAMETRY I ZAWARTOŚĆ

Nr CRC	Model	Liczba ostrzy	Długość cięcia (mm)	Tnie na raz (kartek 80 g/m ²)
54100	Neutron A4	1	320	10
54101	Neutron Plus	4	320	10
54102	Proton A4	1	320	10
54103	Proton A3	1	460	10

Nr CRC	Model	Liczba ostrzy	Długość cięcia (mm)	Tnie na raz (kartek 80 g/m ²)
54104	Electron A4	4	320	10
54105	Electron A3	4	460	10

WAŻNE WSKAZÓWKI BEZPIECZEŃSTWA — Przeczytać przed użyciem!

OSTROŻNIE

- Ostrożnie: ostrza są bardzo ostre.
- Kasetę SafeCut™ stanowi osłonę ostrzy - nie należy wyjmować ich ręcznie.
- Zawsze nadzorować dzieci podczas obsługi przycinarki.
- Nie należy przeciążać przycinarki.
- Trzymać zwierzęta domowe z dala w trakcie obsługi przycinarki.
- Nie należy otwierać lub próbować naprawiać - spowoduje to unieważnienie gwarancji. Ewentualne pytania proszę kierować do działu obsługi klienta. Należy pamiętać, że gwarancja nie obowiązuje w przypadku niewłaściwej eksploatacji, nieprawidłowej konserwacji lub nieautoryzowanej naprawy.
- Nie należy próbować otwierać pojemników z ostrzami SafeCut™.

Potrzebna pomoc?

Obsługa klienta
www.fellowes.com
 Proszę pozwolić naszym ekspertom znaleźć rozwiązanie. Zawsze proszę kontaktować się najpierw z firmą Fellowes, a dopiero później z punktem zakupu.

PRZycinanie PAPIERU I ZDJĘĆ

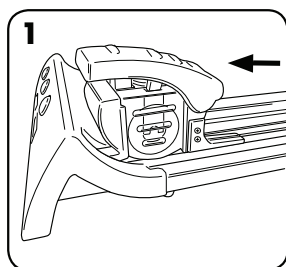

1. Przesunąć zespół przycinający do jednego końca, w zablokowane położenie.

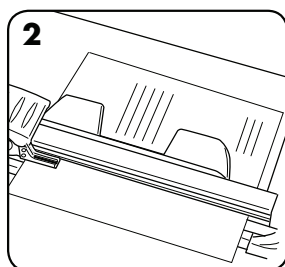

2. Umieścić element, który ma być przycięty (np. zdjęcie albo papier) na podstawie do przycinania.

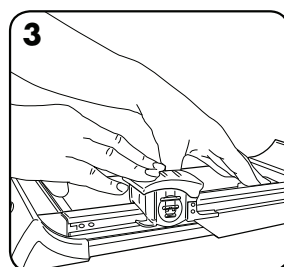

3. Przytrzymać papier bez ruchu, ręką lub trzymakiem. Aby uruchomić ostrze, popchnąć uchwyt pojemnika. (Electron: po naciśnięciu uchwyty zaświeci dioda LED.)

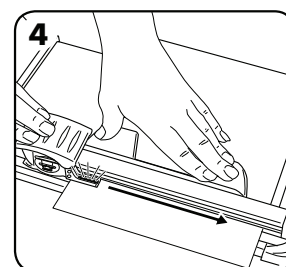

4. Cięcie wykonuje się popychając uchwyt w dół i przeciągając pojemnik do momentu dojścia do końca pręta. Na końcu pręta puścić pojemnik ostrzy, co zwolni również trzymak.

ZABEZPIECZENIE SAFECUT™

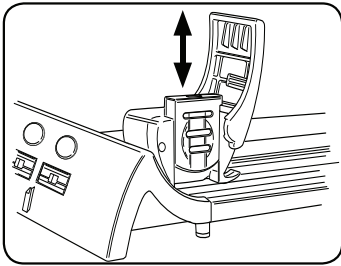

Pojemnik na ostrze SafeCut™ umożliwia wymianę pojemnika bez dotykania ostrzy.

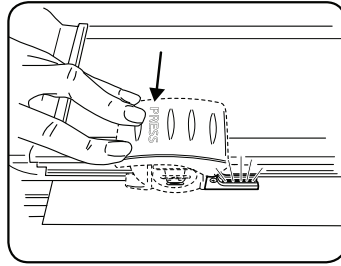

Prowadnik z diodą LED SafeCut™ na przycinaku Electron - podświetlenie w celu zwiększenia precyzji cięcia. Bezpieczniejsze niż prowadniki laserowe.

ZESTAW AKCESORIÓW

3 kreatywne ostrza SafeCut™		Tnie na raz (kartek 80 g/m ²)
	Cięcie ząbkowane	5
	Perforowanie	5
	Składanie (nacięcie)	3

Nr CRC	Zawartość opakowania
54113	3 kreatywne ostrza SafeCut™ (1x ząbkowane, 1x do perforacji, 1x do składania)
54114	2 ostrza proste SafeCut™
54115	Podkładki do przycinania A4 (x3)
54116	Podkładki do przycinania A3 (x3)

WYMIANA KASETY Z OSTRZAMI

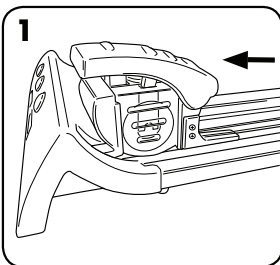

1. Przesunąć zespół przycinający do jednego końca, w zablokowane położenie.

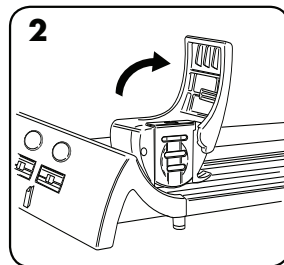

2. Podnieść uchwyt pojemnika.

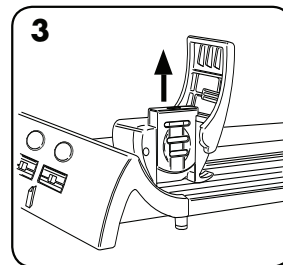

3. Wyciągnąć pojemnik z ostrzami SafeCut™ z pojemnika ruchem w górę i włożyć nowy pojemnik (nacisnąć, aż zatrzaśnie się na swoim miejscu).

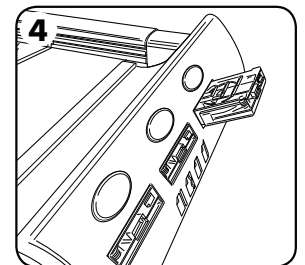

4. Nacisnąć żółty przycisk, aby zwolnić kasetę z podstawy. Włożyć nieużywaną kasetę SafeCut™ z powrotem do szczeliny do jej przechowywania w podstawie.

WYMIANA PODKŁADEK DO PRZycinANIA

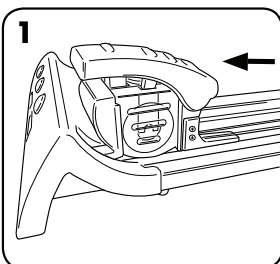

1. Przesunąć zespół przycinający do jednego końca, w zablokowane położenie.

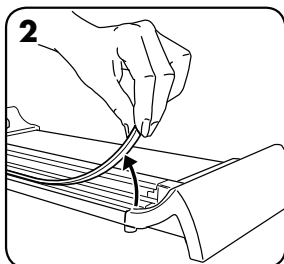

2. Zdjąć podkładkę do przycinania z podstawy przycinarki.

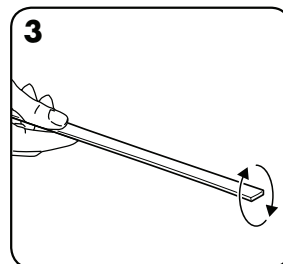

3. Obrócić podkładkę, aby wykorzystać obie jej strony.

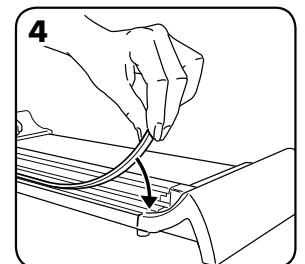

4. Można dokupić dodatkowe podkładki (zob. lista akcesoriów).

PROWADNIK LED ELECTRON SAFECUT™

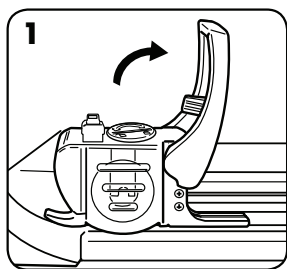

1. Przesunąć zespół przycinający do jednego końca, w zablokowane położenie. Podnieść (na zawiasie) uchwyt pojemnika.

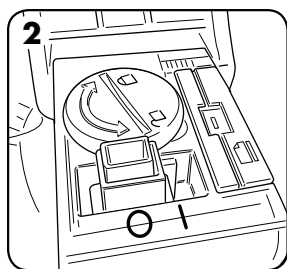

2. Przesłać włącznik w położenie WŁ (I).

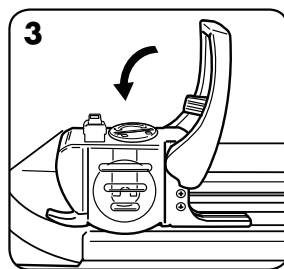

3. Opuścić (na zawiasie) uchwyt pojemnika.

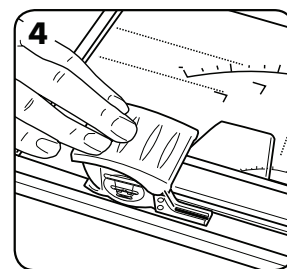

4. Nacisnąć uchwyt, aby włączyć prowadnik LED SafeCut™.

WYMIANA BATERII NA PROWADNIKU Z DIODĄ LED W SAFECUT™ PRZycinAKA ELEKTRON

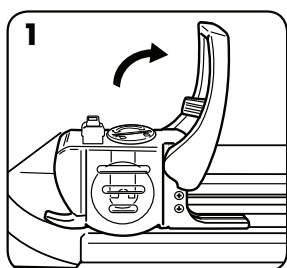

1. Przesunąć zespół przycinający do jednego końca, w zablokowane położenie. Podnieść (na zawiasie) uchwyt pojemnika.

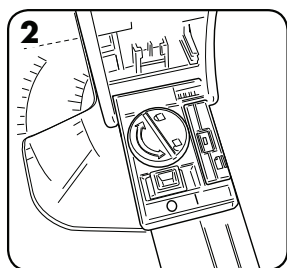

2. Otworzyć pokrywę pojemnika na baterie monetą lub śrubokrętem (obróć w lewo otwiera, obróć w prawo zamyka pokrywę).

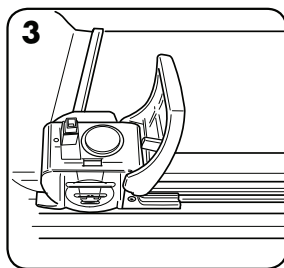

3. Wyjąć zużyta baterię i włożyć nową [typ CR2023].

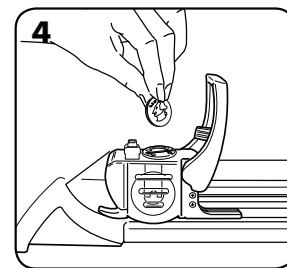

4. Zamknąć pokrywę baterii.

GWARANCJA

Fellowes gwarantuje, że wszystkie inne części niszczarki będą wolne od wad materiału i wykonawstwa przez 2 lata od daty zakupu przez pierwszego użytkownika. Jeżeli w okresie gwarancji jakakolwiek część urządzenia okaże się uszkodzona, użytkownikowi przysługuje wyłącznie prawo naprawy lub wymiany uszkodzonej części na koszt i zgodnie z decyzją firmy Fellowes. Gwarancja nie obowiązuje w przypadku niewłaściwego użytkowania, konserwacji lub nieautoryzowanej naprawy. WSZELKIE DOROZUMIANE GWARANCJE, ŁĄCZNIE Z GWARANCJĄ ZDATNOŚCI HANDLOWEJ I ZDATNOŚCI DO OKREŚLONEGO UŻYTKU SĄ NINIEJSZYM

OGRANICZONE W CZASIE DO OKREŚLONEGO POWYŻEJ OKRESU TRWANIA ODPOWIEDNIEJ GWARANCJI. W żadnym przypadku firma Fellowes nie będzie ponosiła odpowiedzialności za związane z powyższym lub przypadkowe uszkodzenia niszczarki. Niniejsza gwarancja daje użytkownikowi konkretne prawa. Czas trwania i warunki niniejszej gwarancji obowiązują na całym świecie, za wyjątkiem ograniczeń lub warunków narzuconych przez lokalne prawo. W razie dalszych pytań lub konieczności wezwania serwisu prosimy o kontakt z nami lub Państwa dostawcą. Gwarancja nie obejmuje akcesoriów i materiałów zużywalnych.

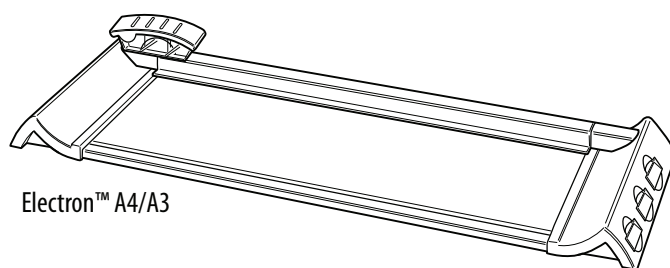

Electron™ A4/A3

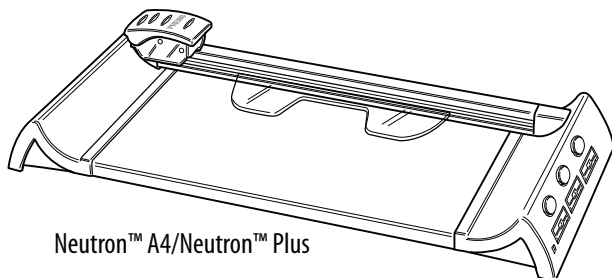

Neutron™ A4/Neutron™ Plus

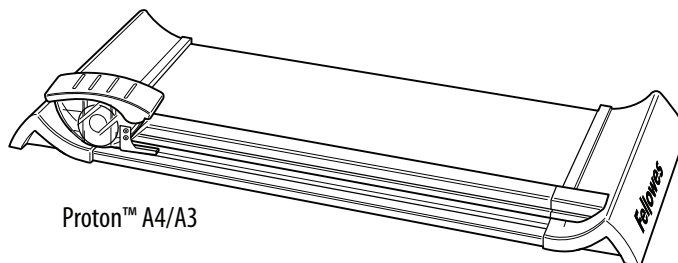

Proton™ A4/A3

ПРОИЗВОДИТЕЛЬНОСТЬ И НАПОЛНЕНИЕ

CRC №	Модель	Количество ножей	Длина резания (mm)	Тние на раз (kartek 80 g/m ²)
54100	Neutron A4	1	320	10
54101	Neutron Plus	4	320	10
54102	Proton A4	1	320	10
54103	Proton A3	1	460	10

CRC №	Модель	Количество ножей	Длина резания (mm)	Тние на раз (kartek 80 g/m ²)
54104	Electron A4	4	320	10
54105	Electron A3	4	460	10

ВАЖНЫЕ ПРАВИЛА ТЕХНИКИ БЕЗОПАСНОСТИ — прочтите перед использованием!

⚠ ВНИМАНИЕ!

- Внимание: ножи очень острые.
- В кассете SafeCut™ находятся ножи — не пытайтесь извлечь их вручную.
- Обязательно присматривайте за детьми во время использования.
- Не перегружайте обрезчик.
- Не подпускайте домашних животных к включенному обрезчику.
- Не открывайте и не пытайтесь ремонтировать аппарат. В противном случае гарантия будет аннулирована. Если у вас есть вопросы, обратитесь в отдел обслуживания покупателей. Пожалуйста, помните о том, что данная гарантия не действует в случае неправильной эксплуатации, несоблюдения правил пользования или неразрешенного ремонта.
- Не пытайтесь открывать картриджи с ножами SafeCut™.

Требуется помощь?

Отдел обслуживания покупателей
www.fellowes.com
 Наши специалисты помогут вам найти решение проблемы. Всегда связывайтесь с компанией Fellowes, прежде чем обратиться туда, где вы совершили покупку.

РЕЗКА БУМАГИ И ФОТОГРАФИЙ

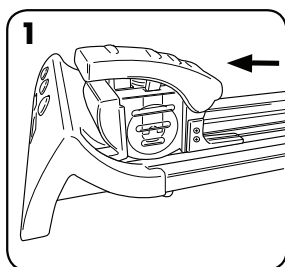

1. Переведите режущую каретку на одну сторону в положение блокировки.

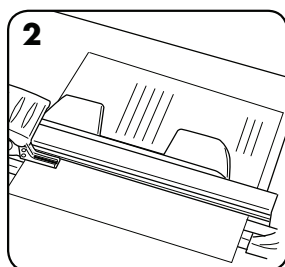

2. Поместите предмет (например, фотографию или бумагу) на стол для резки.

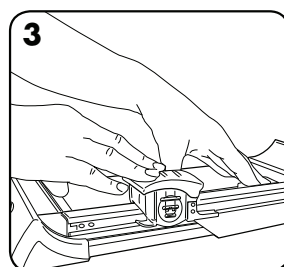

3. Твердо удерживайте бумагу рукой или с помощью зажимного механизма. Чтобы активировать режущий нож, нажмите на рукоятку каретки. (Electron: при нажатии на рукоятку загорится светодиодный индикатор.)

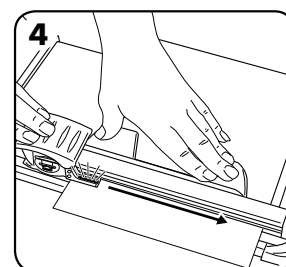

4. Чтобы выполнить отрез, нажмите на рукоятку и переведите каретку до конца планки. В конце планки отпустите каретку; зажимной механизм разблокируется.

МЕРЫ ОБЕСПЕЧЕНИЯ БЕЗОПАСНОСТИ SAFECUT™

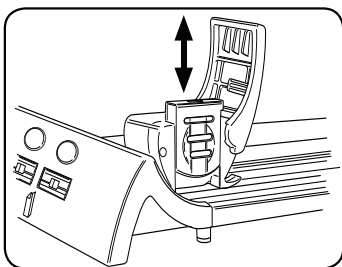



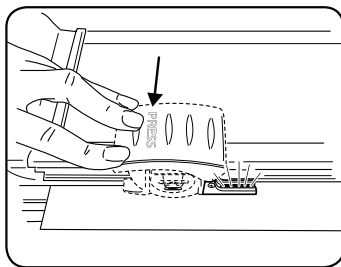

Картридная система SafeCut™ позволяет пользователям менять режущий картридж, не касаясь ножей.

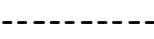

Светодиодная направляющая SafeCut™ на обрезчике Electron обеспечивает подсветку. Она безопаснее лазерных направляющих.

КОМПЛЕКТЫ ВСПОМОГАТЕЛЬНЫХ ПРИНАДЛЕЖНОСТЕЙ

3 ножа Creative SafeCut™		Типе na raz (kartek 80 g/m2)
	 Для волнистой резки	5
	 Для перфорирования	5
	 Для складывания (сгибания)	3

CRC №	Содержание пакета
54113	3 ножа Creative SafeCut™ (1 для волновой резки, 1 для перфорирования, 1 для складывания)
54114	2 прямых ножа SafeCut™
54115	Режущие полосы A4 (3 шт.)
54116	Режущие полосы A3 (3 шт.)

ЗАМЕНА КАСЕТЫ С НОЖАМИ

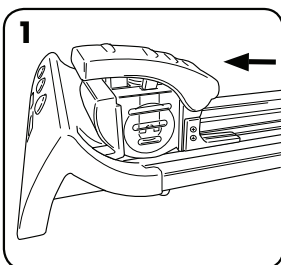

1. Переведите режущую каретку на одну сторону в положение блокировки.

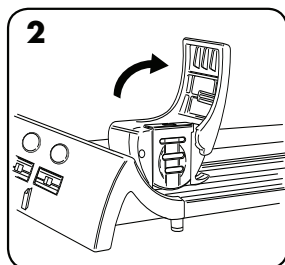

2. Поднимите рукоятку каретки.

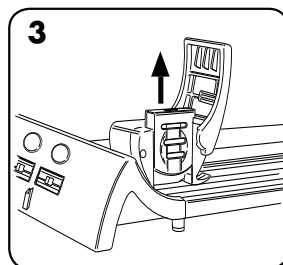

3. Вытяните картридж SafeCut™ из режущей каретки и вставьте новый картридж (нажмите до фиксации со щелчком).

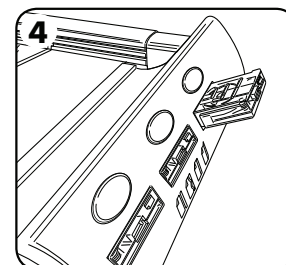

4. Нажмите желтую кнопку, чтобы отделить кассету от основания. Верните неиспользованный картридж SafeCut™ в отсек для хранения в основании.

ЗАМЕНА РЕЖУЩЕЙ ПОЛОСЫ

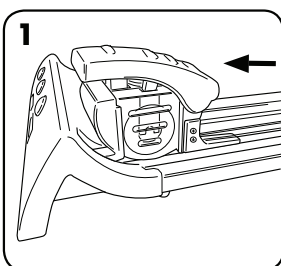

1. Переведите режущую каретку на одну сторону в положение блокировки.

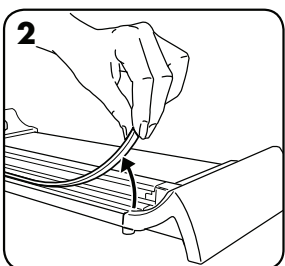

2. Снимите режущую полосу с основания обрезчика.

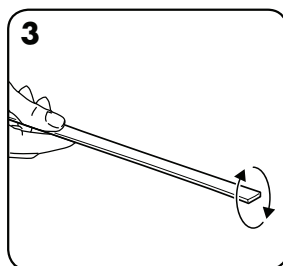

3. Переверните режущую полосу, чтобы использовать обе стороны.

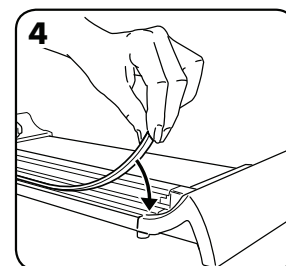

СВЕТОДИОДНАЯ НАПРАВЛЯЮЩАЯ ELECTRON SAFECUT™

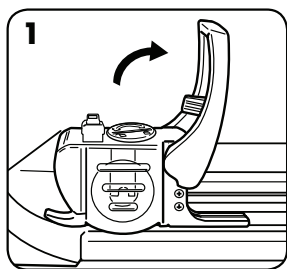

1. Переведите режущую каретку на одну сторону в положение блокировки. Потяните (переведите) рукоятку каретки вверх.

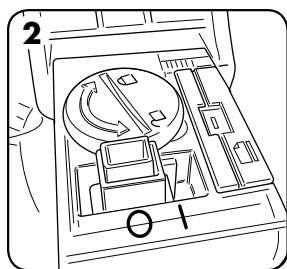

2. Установите выключатель в положение ВКЛ (I).

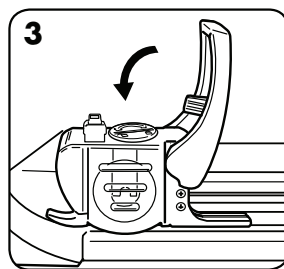

3. Потяните (переведите) рукоятку каретки вниз.

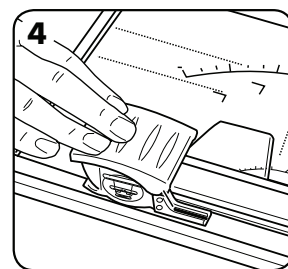

4. Нажмите на рукоятку, чтобы активировать светодиодную направляющую SafeCut™.

ЗАМЕНА АККУМУЛЯТОРА В СВЕТОДИОДНОЙ НАПРАВЛЯЮЩЕЙ ELECTRON SAFECUT™

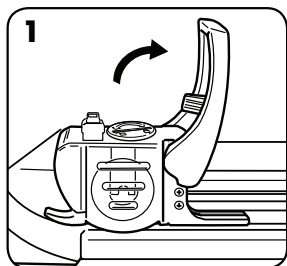

1. Переведите режущую каретку на одну сторону в положение блокировки. Потяните (переведите) рукоятку каретки вверх.

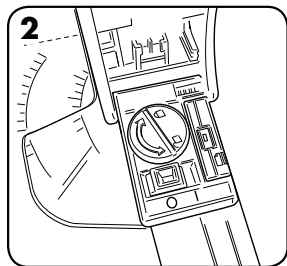

2. Отвинтите крышку аккумулятора с помощью монеты или отвертки (при повороте влево крышка аккумулятора открывается, а при повороте вправо — закрывается).

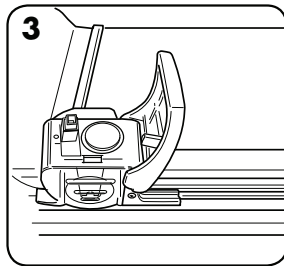

3. Извлеките старый аккумулятор и замените его новым [тип CR2023].

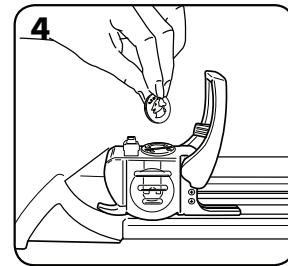

4. Закройте крышку аккумулятора.

ГАРАНТИЯ

Компания Fellowes гарантирует отсутствие дефектов материалов или производственных дефектов остальных деталей машины на протяжении 2 лет со дня покупки первоначальным покупателем. Если в течение гарантийного срока будет обнаружен дефект какой-либо детали, вы имеете право только и исключительно на ремонт или замену дефектной детали, который будет производиться по усмотрению и за счет компании Fellowes. Данная гарантия не распространяется на случаи неправильной эксплуатации, неправильного обращения или несанкционированного ремонта. **НАСТОЯЩИЙ ДОКУМЕНТ ОГРАНИЧИВАЕТ ДЕЙСТВИЕ ЛЮБОЙ ПОДРАЗУМЕВАЕМОЙ ГАРАНТИИ, В ТОМ ЧИСЛЕ ГАРАНТИИ ТОВАРНОГО СОСТОЯНИЯ**

ИЛИ ПРИГОДНОСТИ ДЛЯ ИСПОЛЬЗОВАНИЯ В ОПРЕДЕЛЕННЫХ ЦЕЛЯХ, УКАЗАННЫМ ВЫШЕ СООТВЕТСТВУЮЩИМ ГАРАНТИЙНЫМ СРОКОМ. Компания Fellowes ни при каких обстоятельствах не несет ответственность за любой косвенный или случайный ущерб, связанный с данным изделием. Данная гарантия дает вам определенные юридические права. Продолжительность и условия данной гарантии действительны по всему миру, кроме тех стран, где местное законодательство может налагать иные ограничения или условия. Для получения более подробной информации или обслуживания по данной гарантии обратитесь к нам или к продавцу вашего изделия. Данная гарантия не распространяется на вспомогательные принадлежности и расходные материалы.

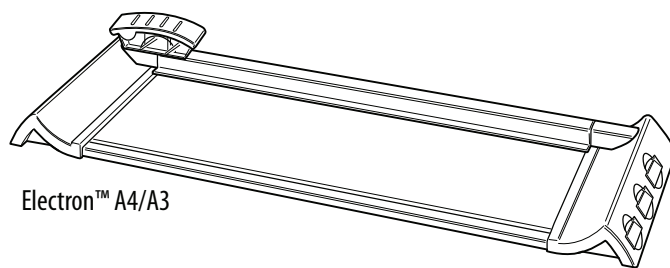

Electron™ A4/A3

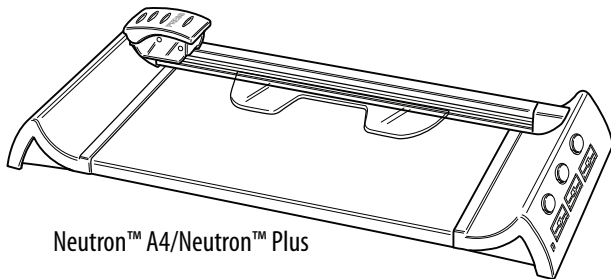

Neutron™ A4/Neutron™ Plus

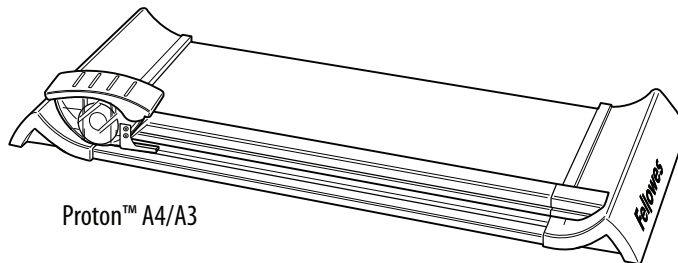

Proton™ A4/A3

ΧΩΡΗΤΙΚΟΤΗΤΕΣ ΚΑΙ ΠΕΡΙΕΧΟΜΕΝΟ

ΑΡ. CRC	Μοντέλο	Αριθμός λεπίδων	Μήκος κοπής (mm)	Χωρητικότητα κοπής (φύλλα 80 gsm)
54100	Neutron A4	1	320	10
54101	Neutron Plus	4	320	10
54102	Proton A4	1	320	10
54103	Proton A3	1	460	10

ΑΡ. CRC	Μοντέλο	Αριθμός λεπίδων	Μήκος κοπής (mm)	Χωρητικότητα κοπής (φύλλα 80 gsm)
54104	Electron A4	4	320	10
54105	Electron A3	4	460	10

ΣΗΜΑΝΤΙΚΕΣ ΟΔΗΓΙΕΣ ΑΣΦΑΛΕΙΑΣ — Διαβάστε πριν από τη χρήση!

ΠΡΟΣΟΧΗ

- Προσοχή: οι λεπίδες είναι εξαιρετικά κοφτερές.
- Η κασέτα SafeCut™ εσωκλείει λεπίδες - μην προσπαθήσετε να βγάλετε (εξωθήσετε) τις λεπίδες με το χέρι.
- Επιβλέπετε πάντα τα παιδιά κατά τη λειτουργία του μηχανήματος.
- Μην υπερφορτώνετε τον κόπτη.
- Διατηρείτε τα κατοικίδια ζώα μακριά από τον κόπτη, όταν είναι σε λειτουργία.
- Μην ανοίγετε ή επιχειρείτε να επισκευάσετε το παρόν προϊόν καθώς αυτό θα ακυρώσει την εγγύησή σας. Επικοινωνήστε με το τμήμα εξυπηρέτησης πελατών εάν έχετε οποιοδήποτε ερωτήσες. Παρακαλούμε σημειώστε ότι αυτή η εγγύηση δεν ισχύει σε περιπτώσεις κακομεταχείρισης, λανθασμένου χειρισμού, ή μη εξουσιοδοτημένης επισκευής.
- Μην προσπαθήσετε να ανοίξετε τις θήκες λεπίδων SafeCut™.

Χρειάζεστε βοήθεια;

Τμήμα εξυπηρέτησης πελατών
www.fellowes.com
 Αφήστε τους ειδικούς μας να σας βοηθήσουν με τις λύσεις τους. Να καλείτε πάντα την εταιρία Fellowes πριν επικοινωνήσετε με το κατάστημα αγοράς.

ΚΟΠΗ ΧΑΡΤΙΟΥ ΚΑΙ ΦΩΤΟΓΡΑΦΙΩΝ

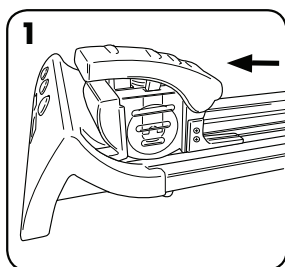

1. Σύρετε το φορέα κοπής στο ένα άκρο, στη θέση ασφάλισης.

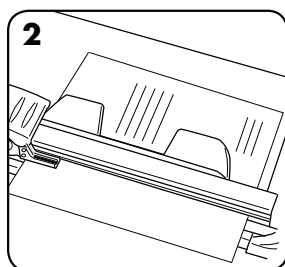

2. Τοποθετήστε το αντικείμενο (π.χ. φωτογραφία ή χαρτί) στην επιφάνεια (τραπέζι) κοπής.

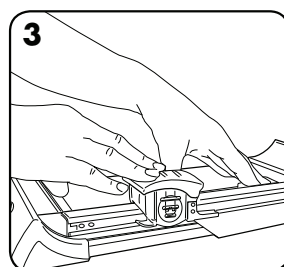

3. Κρατήστε το χαρτί σταθερά με το χέρι ή το μηχανισμό σύσφιξης. Για ενεργοποίηση της λεπίδας κοπής, πιέστε προς τα κάτω τη χειρολαβή του φορέα κοπής. (Electron: όταν πιέξετε τη χειρολαβή προς τα κάτω, θα ανάψει το LED.)

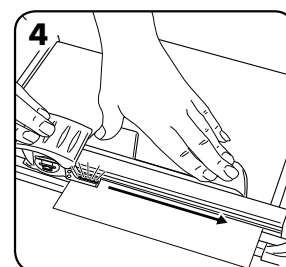

4. Για κοπή, ωθήστε προς τα κάτω τη χειρολαβή και σύρετε το φορέα κοπής κατά μήκος, έως ότου φτάσει στο άκρο της ράβδου. Στο άκρο της ράβδου, απελευθερώστε το φορέα κοπής και θα απελευθερωθεί ο μηχανισμός σύσφιξης.

ΧΑΡΑΚΤΗΡΙΣΤΙΚΑ ΑΣΦΑΛΕΙΑΣ SAFECUT™

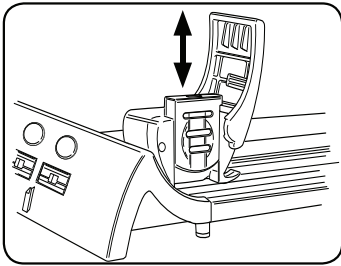

Το σύστημα φορέα κοπής SafeCut™ επιτρέπει στους χρήστες να αλλάζουν το φορέα κοπής χωρίς να αγγίζουν τις λεπίδες.

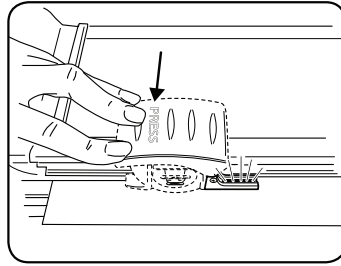

Ο οδηγός LED SafeCut™ του κόπτη Electron για ακρίβεια μέσω συστήματος φωτισμού. Ασφαλέστερος από τους οδηγούς λέιζερ.

ΠΑΚΕΤΑ ΠΑΡΕΛΚΟΜΕΝΩΝ (ΑΞΕΣΟΥΑΡ)

3 λεπίδες κοπής σχημάτων SafeCut™		Χωρητικότητα κοπής (φύλλα 80 gsm)
	Κυματιστή κοπή	5
	Διάτρηση	5
	Δίπλωση (τσάκιση)	3

ΑΡ. CRC	Περιεχόμενα πακέτου
54113	3 λεπίδες κοπής σχημάτων SafeCut™ (1 κυματιστή, 1 διάτρησης, 1 τσάκισης)
54114	2 ίσιες λεπίδες SafeCut™
54115	Ταινίες κοπής A4 (x3)
54116	Ταινίες κοπής A3 (x3)

ΑΛΑΓΗ ΚΑΣΕΤΑΣ ΛΕΠΙΔΩΝ

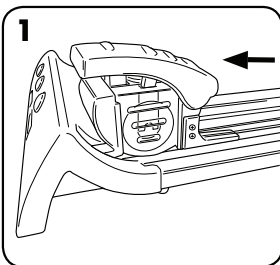

1. Σύρτε το φορέα κοπής στο ένα άκρο, στη θέση ασφάλισης.

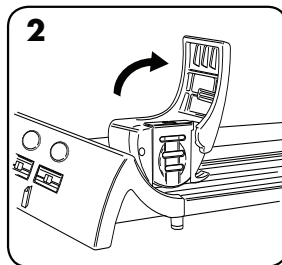

2. Ανασηκώστε προς τα πάνω τη χειρολαβή του φορέα κοπής.

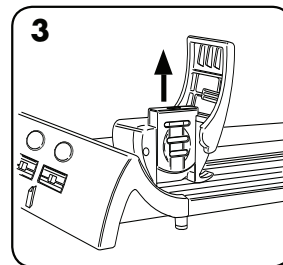

3. Τραβήξτε τη θήκη SafeCut™ προς τα πάνω, εκτός του φορέα κοπής και εισάγετε νέα θήκη (πιέστε προς τα κάτω για να την "κλειδώσετε" στη θέση της).

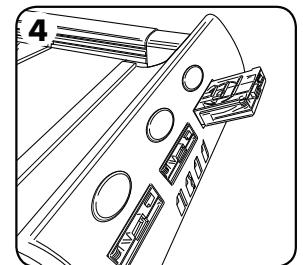

4. Πιέστε το κίτρινο κουμπί για να απελευθερώσετε την κασέτα από τη βάση. Βάλτε τη μη χρησιμοποιημένη θήκη SafeCut™ στην εγκοπή αποθήκευσης στη βάση.

ΑΛΑΓΗ ΤΑΙΝΙΑΣ ΚΟΠΗΣ

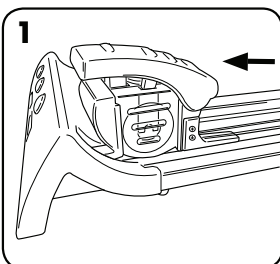

1. Σύρτε το φορέα κοπής στο ένα άκρο, στη θέση ασφάλισης.

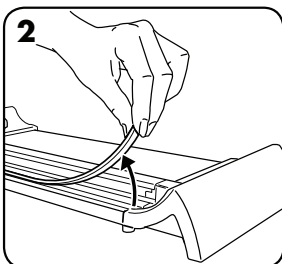

2. Αφαιρέστε την ταινία κοπής από τη βάση κοπής.

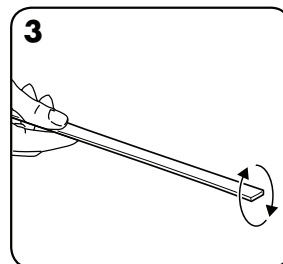

3. Γυρίστε την ταινία κοπής από την άλλη πλευρά για να χρησιμοποιήσετε και τις δύο πλευρές.

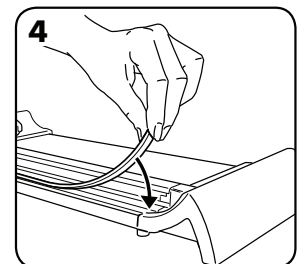

4. Διατίθενται ανταλλακτικές ταινίες (δείτε τις πληροφορίες παρελκομένων-αξεσουάρ).

ΟΔΗΓΟΣ LED ELECTRON SAFECUT™

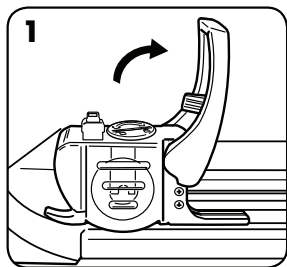

1. Σύρετε το φορέα κοπής στο ένα άκρο, στη θέση ασφάλισης. Τραβήξτε (με στροφή) τη χειρολαβή του φορέα κοπής προς τα πάνω.

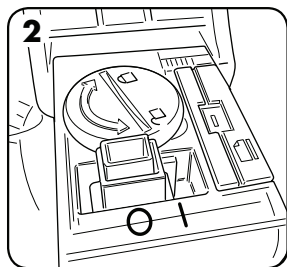

2. Ανοίξτε το διακόπτη ΘΕΣΗ (I).

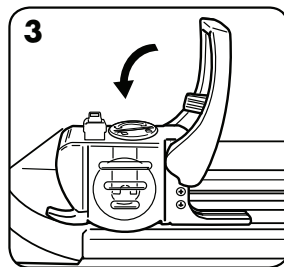

3. Τραβήξτε (περιστρέψτε) προς τα κάτω τη χειρολαβή φορέα.

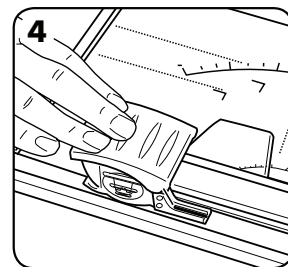

4. Πιέστε τη χειρολαβή προς τα κάτω για ενεργοποίηση του Οδηγού LED SafeCut™.

ΑΛΛΑΓΗ ΜΠΑΤΑΡΙΑΣ ΣΤΟΝ ΟΔΗΓΟ LED ΤΟΥ ΜΗΧΑΝΙΣΜΟΥ SAFECUT™ ΤΟΥ ELECTRON

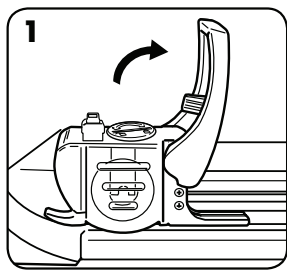

1. Σύρετε το φορέα κοπής στο ένα άκρο, στη θέση ασφάλισης. Τραβήξτε (με στροφή) τη χειρολαβή του φορέα κοπής προς τα πάνω.

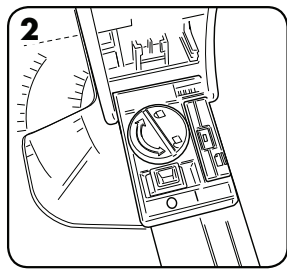

2. Ξεβιδώστε το κάλυμμα της μπαταρίας με ένα νόμισμα ή κατσαβίδι (ανοίγει αριστερόστροφα, ενώ η δεξιόστροφη περιστροφή κλείνει το κάλυμμα της μπαταρίας).

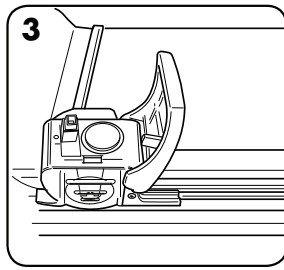

3. Αφαιρέστε την παλιά μπαταρία και αντικαταστήστε με νέα μπαταρία [τύπου CR2023]

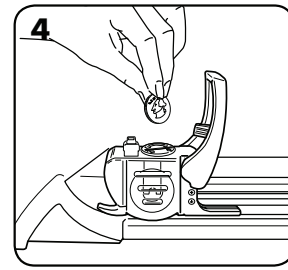

4. Κλείστε το κάλυμμα της μπαταρίας.

ΕΓΓΥΗΣΗ

Η Fellowes εγγυάται ότι κανένα από τα υπόλοιπα εξαρτήματα του μηχανήματος δεν θα παρουσιάσει ελαττώματα σε υλικά και εργατικά για 2 έτη από την ημερομηνία αγοράς από τον αρχικό αγοραστή. Εάν παρουσιαστεί ελάττωμα σε οποιοδήποτε εξάρτημα κατά την περίοδο εγγύησης, η μόνη και αποκλειστική σας αποκατάσταση θα είναι η επισκευή ή η αντικατάσταση, κατά την επιλογή και με έξοδα της Fellowes, του ελαττωματικού εξαρτήματος. Αυτή η εγγύηση δεν ισχύει σε περιπτώσεις κακομεταχείρισης, λανθασμένου χειρισμού, ή μη εξουσιοδοτημένης επισκευής. ΟΠΟΙΑΔΗΠΟΤΕ ΥΠΟΝΟΟΥΜΕΝΗ ΕΓΓΥΗΣΗ, ΣΥΜΠΕΡΙΛΑΜΒΑΝΟΜΕΝΩΝ ΕΓΓΥΗΣΕΩΝ ΕΜΠΟΡΕΥΣΙΜΟΤΗΤΑΣ Ή ΚΑΤΑΛΛΗΛΟΤΗΤΑΣ ΓΙΑ ΣΥΓΚΕΚΡΙΜΕΝΟ ΣΚΟΠΟ, ΠΕΡΙΟΡΙΖΕΤΑΙ ΔΙΑ ΤΟΥ ΠΑΡΟΝΤΟΣ ΣΕ ΔΙΑΡΚΕΙΑ ΙΣΗ ΜΕ ΤΗΝ ΑΝΑΛΟΓΗ ΔΙΑΡΚΕΙΑ ΕΓΓΥΗΣΗΣ

ΠΟΥ ΑΝΑΦΕΡΕΤΑΙ ΠΑΡΑΠΑΝΩ. Η εταιρία Fellowes δεν θα είναι σε καμία περίπτωση υπεύθυνη για οποιοδήποτε συνεπαγόμενο ή συμπωματικές ζημιές αποδοτές σ' αυτό το προϊόν. Αυτή η εγγύηση σας δίνει συγκεκριμένα νομικά δικαιώματα. Η διάρκεια, οι όροι και οι προϋποθέσεις αυτής της εγγύησης ισχύουν σε παγκόσμιο επίπεδο, εκτός από τις περιπτώσεις στις οποίες μπορεί να απαιτούνται από την τοπική νομοθεσία συγκεκριμένοι περιορισμοί, ή ειδικές απαγορεύσεις ή προϋποθέσεις. Για περισσότερες λεπτομέρειες, ή για να λάβετε υπηρεσίες με βάση αυτή την εγγύηση, παρακαλείσθε να επικοινωνήσετε μαζί μας ή με τον αντιπρόσωπο της περιοχής σας. Τα παρελκόμενα (αξεσουάρ) και τα αναλώσιμα δεν καλύπτονται απ' αυτή την εγγύηση.

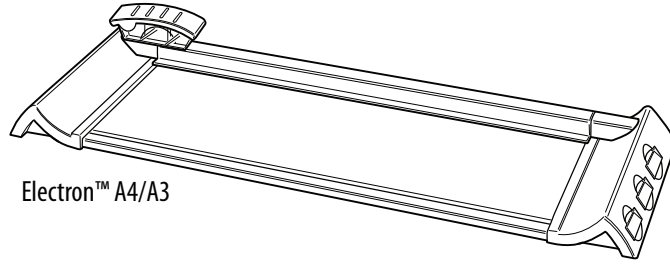

Electron™ A4/A3

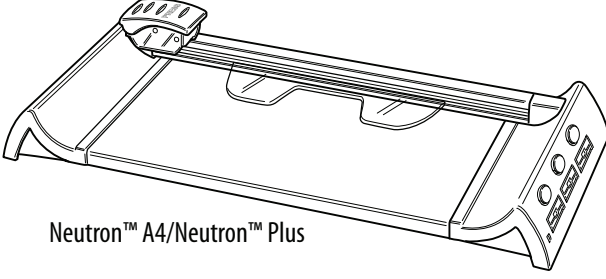

Neutron™ A4/Neutron™ Plus

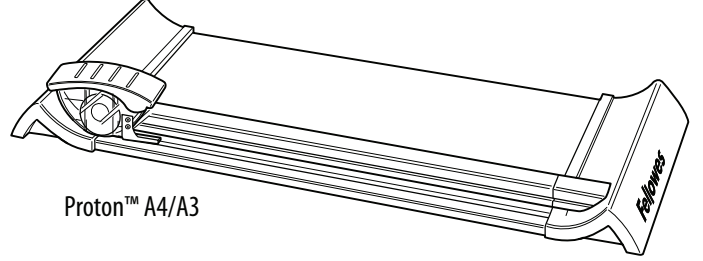

Proton™ A4/A3

KAPASİTELER VE İÇERİK

CRC No.	Model	Bıçak sayısı	Kesim Uzunluğu (mm)	Kesim kapasitesi (sayfa 80 gsm)
54100	Neutron A4	1	320	10
54101	Neutron Plus	4	320	10
54102	Proton A4	1	320	10
54103	Proton A3	1	460	10

CRC No.	Model	Bıçak sayısı	Kesim Uzunluğu (mm)	Kesim kapasitesi (sayfa 80 gsm)
54104	Electron A4	4	320	12 10
54105	Electron A3	4	460	18 10

ÖNEMLİ GÜVENLİK TALİMATLARI — Kullanmadan Önce Okuyun!



DİKKAT

- Dikkat: bıçaklar çok keskindir.
- SafeCut™ kaseti bıçakları kuşatır – bıçakları manuel olarak çıkarmaya çalışmayın.
- Kullanım sırasında her zaman çocukları gözetim altında tutun.
- Cihazı aşırı yüklemeyin.
- Kullanım sırasında ev hayvanlarını cihazdan uzak tutun.
- Onarım için cihazı sökmeye çalışmayın, aksi takdirde garantiniz geçersiz kılınır. Sorularınız varsa Müşteri Hizmetleri ile iletişim kurun. Bu garanti, kötü kullanım, yanlış muamele ya da yetkisiz taraflarca yapılmış onarım vakalarına uygulanmaz.
- SafeCut™ bıçak kartuşlarını açmaya çalışmayın.

Yardım mı Gerekli?

Müşteri Hizmetleri
www.fellowes.com
Uzmanlarımızın size bir çözüm sunmasına olanak verin. Satın aldığınız yer ile iletişim kurmadan önce daima Fellowes' u arayın.

KAĞIT VE RESİM KESİMİ

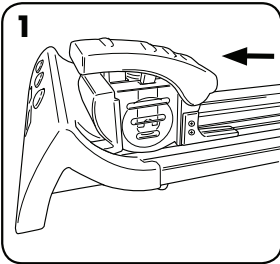

1. Kesim şaryosunu bir uca bulunan kilitleme konumuna kaydırın.

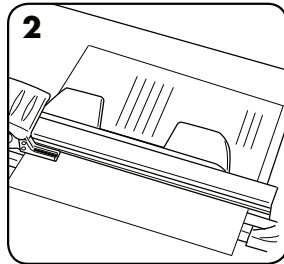

2. Kesilecek cismi (örneğin resim veya kağıt) kesim masasına yerleştirin.

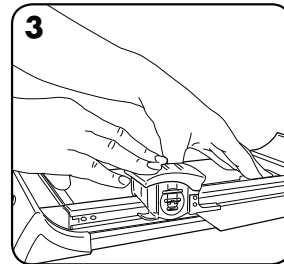

3. Elinizi veya sıkıştırma mekanizması kullanarak kağıdı sabit tutun. Kesim bıçağını etkinleştirme için şaryo kolunu aşağıya itin. (Electron: aşağıya doğru bastırırken, LED ışığı yanar.)

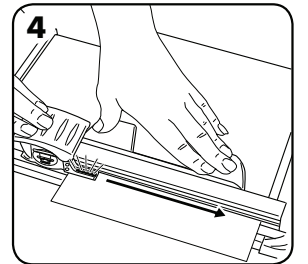

4. Kesmek için, kolu aşağıya doğru bastırın ve şaryoyu çubuğun sonuna kadar ulaşacak biçimde kaydırın. Çubuğun sonuna geldiğinde, şaryoyu bırakın ve sıkıştırma mekanizması da serbest kalacaktır.

SAFECUT™ GÜVENLİK ÖZELLİKLERİ

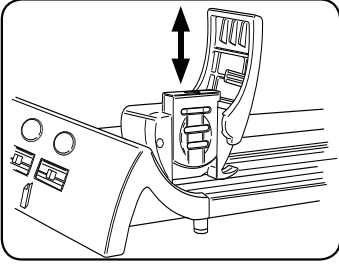



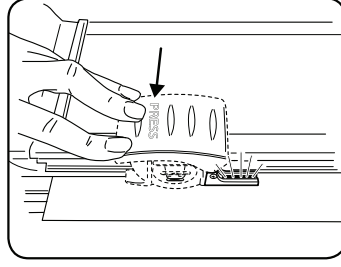



SafeCut™ kartuş sistemi bıçaklara dokunmaksızın kullanıcıların kesme kartuşlarını değiştirmesine olanak sağlar.



Işıklılandırılmış hassasiyet için Electron kesim cihazının üzerindeki SafeCut™ LED Kılavuzu. Lazer kılavuzlarından daha güvenli.

AKSESUAR PAKETLERİ

3 Yaratıcı SafeCut™ bıçak	Kesim kapasitesi (sayfa 80 gsm)
  Dalgalı Kesim	5
  Tırtırlama	5
  Katlama (kıvrımlı)	3

CRC No.	Paket içerikleri
54113	3 Yaratıcı SafeCut™ bıçak (1x dalgalı, 1x tırtırlı, 1x katlamalı)
54114	2 Düz SafeCut™ bıçak
54115	A4 Kesme bandı (x3)
54116	A3 Kesme bandı (x3)

BIÇAK KASETİNİN DEĞİŞTİRİLMESİ

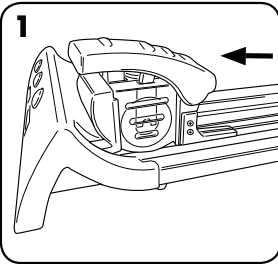

1. Kesim şaryosunu bir uca bulunan kilitleme konumuna kaydırın.

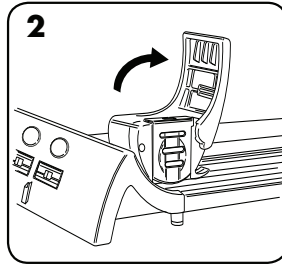

2. Şaryo kolunu yukarı kaldırın.

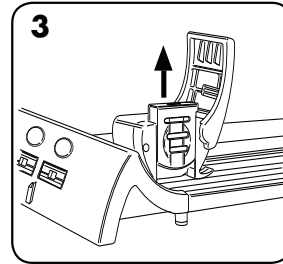

3. SafeCut™ kartuşu kesim şaryosunun dışına çıkması için yukarıya doğru kaldırın ve yeni kartuşu takın (yerine kenetlenmesi için itin).

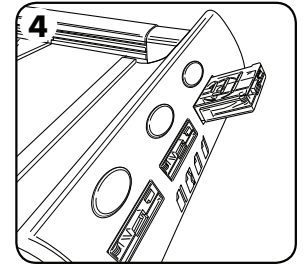

4. Sarı düğmeye basarak kartuşu yerinden çıkarın. Kullanılmamış SafeCut™'i tabandaki saklama haznesine geri yerleştirin.

KESME BANDININ DEĞİŞTİRİLMESİ

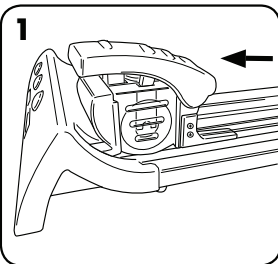

1. Kesim şaryosunu bir uca bulunan kilitleme konumuna kaydırın.

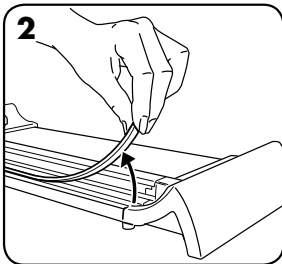

2. Kesme bandını cihazın tabanından çıkarın.

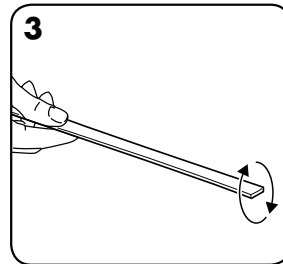

3. Her iki tarafını da kullanmak üzere kesme bandını çevirin.

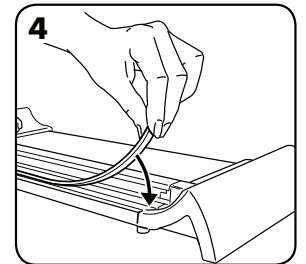

4. Yedek yenileme bantları mevcuttur (aksesuar detaylarına bakınız).

TÜRKÇE

ELECTRON SAFECUT™ LED KILAVUZ

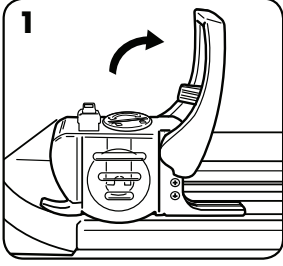

1. Kesim şaryosunu bir uca bulunan kilitleme konumuna kaydırın. Şaryo (döndürülebilir) kolunu yukarı kaldırın.

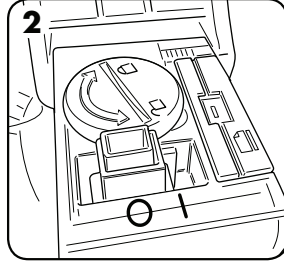

2. Anahtarı AÇIK (I) konuma çevirin.

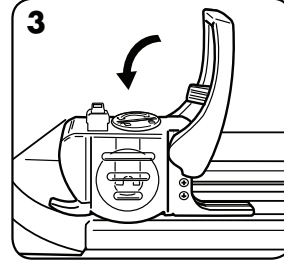

3. Taşıyıcı kulpunu aşağı çekin (çevirin).

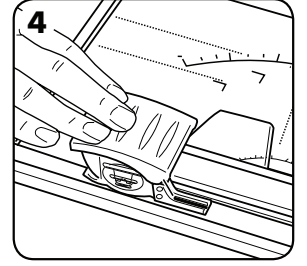

4. SafeCut™ LED Kılavuzunu devreye sokmak için kulpu aşağı doğru bastırın.

ELECTRON SAFECUT™ LED KILAVUZUNDA PİL DEĞİŞTİRME

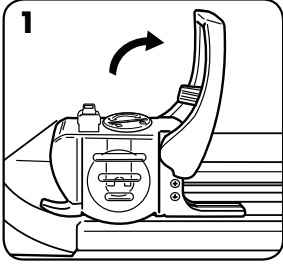

1. Kesim şaryosunu bir uca bulunan kilitleme konumuna kaydırın. Şaryo (döndürülebilir) kolunu yukarı kaldırın.

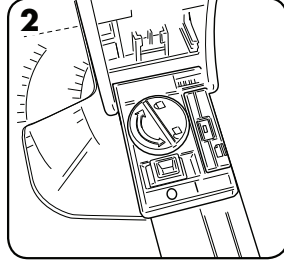

2. Pil kapağının vidasını madeni para ya da tornavida ile açın (pil kapağını açmak için sola, kapatmak için sağa çevirin).

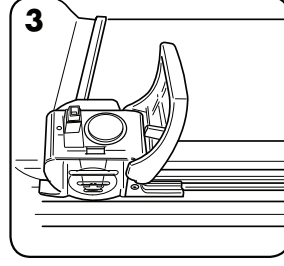

3. Eski pili çıkarın ve yenisiyle değiştirin [CR2023 tipi].

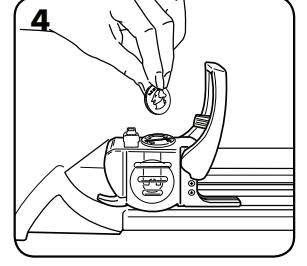

4. Pil kapağını kapat.

GARANTİ

Fellowes, makinenin tüm diğer parçalarının, ilk tüketici tarafından satın alınma tarihinden itibaren 2 yıl süreyle malzeme ve işçilik açısından kusursuz olacağını garanti eder. Eğer garanti dönemi içinde herhangi bir parça kusurlu bulunursa, yegane ve münhasır tazminatınız, seçme hakkı ve masrafları Fellowes'a ait olmak üzere, söz konusu parçanın onarılması veya değiştirilmesidir. Bu garanti, kötü kullanım, yanlış muamele ya da yetkisiz taraflarca yapılmış onarım vakalarına uygulanmaz. SATILABİLİRLİK VE BELLİ BİR AMACA UYGUNLUK GARANTİLERİ DAHİL OLMAK ÜZERE, HERTÜRLÜ ZİMNİ GARANTİLERİN SÜRESİ, YUKARIDA

BEYAN EDİLEN İLGİLİ GARANTİ DÖNEMİ İLE SINIRLIDIR. Fellowes, bu ürünün kullanılmasına bağlı olarak ya da kullanılması sonucunda oluşan zararlardan hiçbir şekilde sorumlu değildir. Bu garanti size belirli yasal haklar verir. Bu garantinin süresi ve şartları, yerel yasaların gerektirebileceği sınırlamalar, kısıtlamalar veya şartlar haricinde tüm dünya genelinde geçerlidir. Daha fazla ayrıntı ya da bu garanti altında servis almak için bizimle ya da bayinizle iletişim kurunuz. Aksesuar ve sarf malzemeleri bu garanti kapsamı altında değildir.

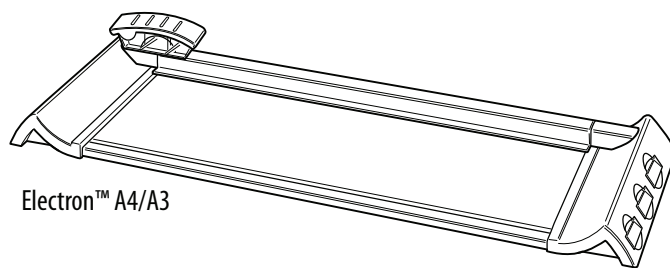

Electron™ A4/A3

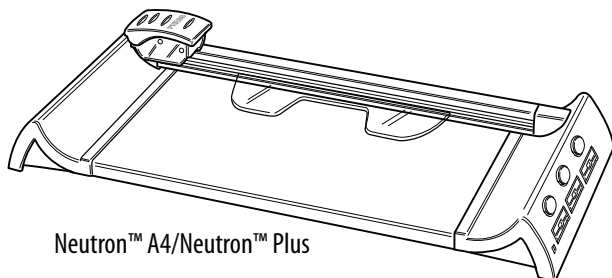

Neutron™ A4/Neutron™ Plus

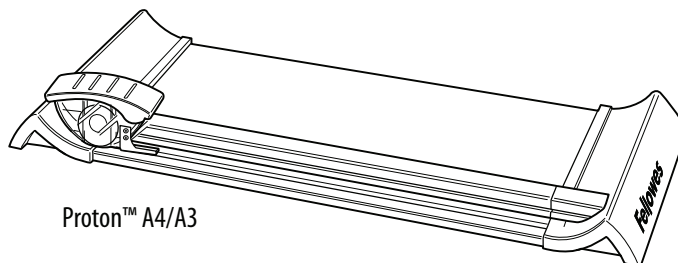

Proton™ A4/A3

KAPACITA A OBSAH

Č. CRC	Model	Počet čepelí	Délka řezu (mm)	Kapacita řezu (listy 80 gsm)
54100	Neutron A4	1	320	10
54101	Neutron Plus	4	320	10
54102	Proton A4	1	320	10
54103	Proton A3	1	460	10

Č. CRC	Model	Počet čepelí	Délka řezu (mm)	Kapacita řezu (listy 80 gsm)
54104	Electron A4	4	320	10
54105	Electron A3	4	460	10

DŮLEŽITÉ BEZPEČNOSTNÍ POKYNY — Přečtěte si před použitím!



POZOR

- Důležité upozornění: čepele jsou velmi ostré.
- Kazeta SafeCut™ čepele kryje - nepokoušejte se čepele vyndávat ručně.
- Pokud toto zařízení používají děti, mějte je vždy pod dozorem.
- Do ořezávače nedávejte nadměrné množství papírů.
- Při používání ořezávače dbejte na to, aby se v blízkosti stroje nevyskytovala domácí zvířata.
- Ořezávač neotvírejte ani se jej nepokoušejte opravit; zrušili byste tím platnost záruky. V případě dotazů se obraťte na zákaznický servis. Tato záruka neplatí v případě zneužití, nesprávného použití nebo nepovolené opravy.
- Nepokoušejte se otvírat zásobníky čepelí SafeCut™.

Potřebujete pomoc?

Služba zákazníkům
www.fellowes.com
 Dovolte našim odborníkům, aby vám pomohli. Než se obrátíte na místo, kde jste výrobek zakoupili, vždy nejprve zavolejte společnosti Fellowes.

OŘEZÁVÁNÍ PAPÍRŮ A FOTOGRAFIÍ

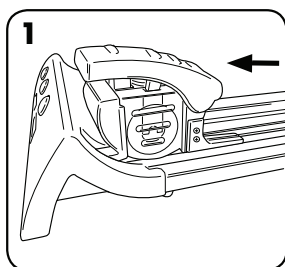

1. Posuňte ořezávací hlavu na jeden konec do uzamčené polohy.

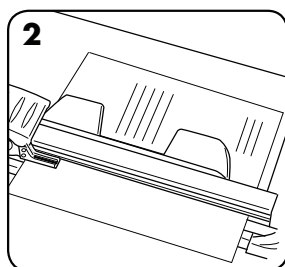

2. Umístěte položku (např. fotografii nebo papír) na desku ořezávače.

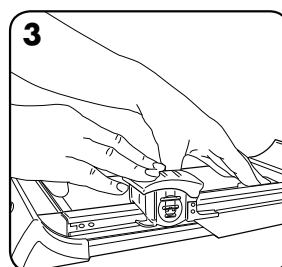

3. Přidržte papír rukou nebo úchytným mechanismem, aby se nepohyboval. K aktivaci řezné čepele zatlačte na držadlo hlavy směrem dolů. (Electron: při zatlačení na držadlo směrem dolů se rozsvítí kontrolka.)

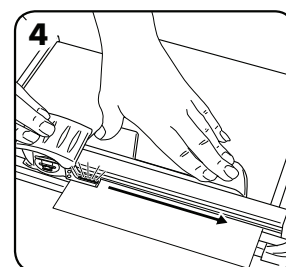

4. Oříznutí provedte zatlačením držadla směrem dolů a posunutím hlavy na konec kolejničky. Na konci kolejničky uvolněte hlavu a úchytný mechanismus se uvolní.

BEZPEČNOSTNÍ FUNKCE SAFECUT™

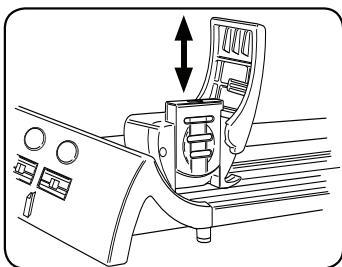



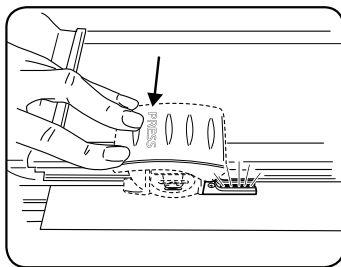



Systém hlavy SafeCut™ umožní uživateli vyměnit hlavu bez dotýkání se čepelí.



Kontrolka SafeCut™ slouží jako vodítko ořezávače k zajištění větší přesnosti pomocí osvětlení. Bezpečnější než laserová vodítka.

BALÍČKY DOPLŇKOVÝCH SOUČÁSTEK

3 tvořivé čepelí SafeCut™		Kapacita řezu (listy 80 gsm)
	 Vlnkový řez	5
	 Perforátor	5
	 Skládač (záhyb)	3

Č. CRC	Balíček obsahuje
54113	3 tvořivé čepelí SafeCut™ (1x vlna, 1x perforátor, 1x skládač)
54114	2 řezné čepelí Straight SafeCut™ pro rovný řez
54115	Řezací pruhy pro A4 (x3)
54116	Řezací pruhy pro A3 (x3)

VÝMĚNA KAZATY S ČEPELÍ

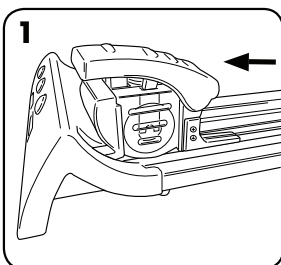

1. Posuňte ořezávací hlavu na jeden konec do uzamčené polohy.

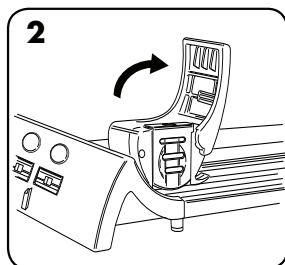

2. Zvedněte držadlo hlavy směrem nahoru.

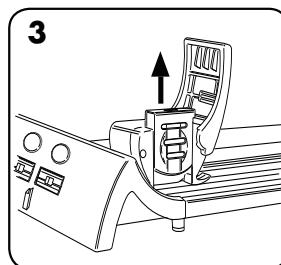

3. Vytáhněte zásobník SafeCut™ z řezné hlavy směrem nahoru a vložte nový zásobník (zatlačte jej směrem dolů, dokud nezacvakne na místo).

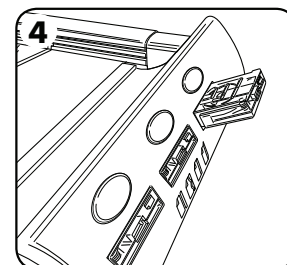

4. Stisknutím žlutého tlačítka uvolněte kazetu ze základny. Vraťte nepoužitý SafeCut™ do skladovací zdířky v základně.

VÝMĚNA ŘEZNÝCH PRUHŮ

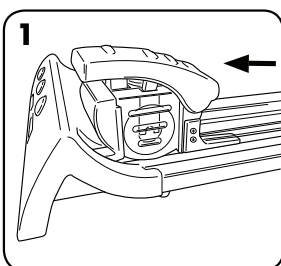

1. Posuňte ořezávací hlavu na jeden konec do uzamčené polohy.

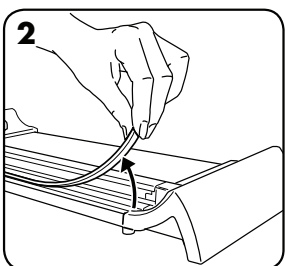

2. Vyndejte řezný pruh ze základny ořezávače.

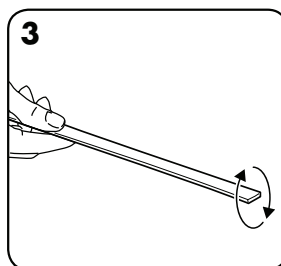

3. Otočte řezný pruh, abyste použili obě strany.

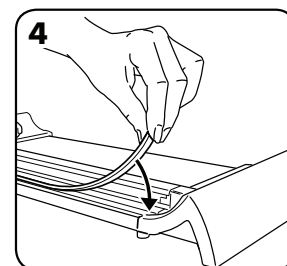

4. K dispozici jsou náhradní pruhy (viz. informace o doplňkových součástkách).

VODÍTKO ELECTRON SAFECUT™ LED

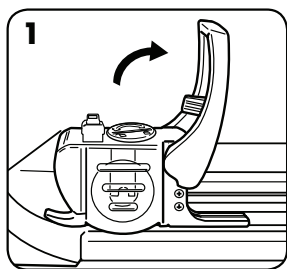

1. Posuňte ořezávací hlavu na jeden konec do uzamčené polohy. Vytáhněte (vyklopte) držadlo hlavy směrem nahoru.

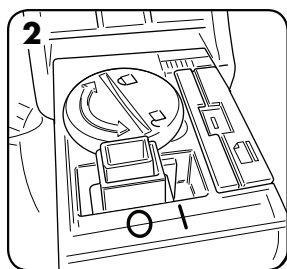

2. Přepněte vypínač do polohy ZAPNUTO (I).

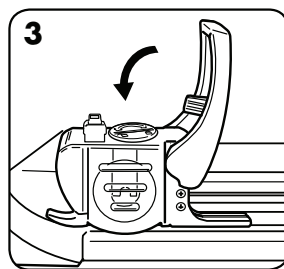

3. Stáhněte (vykývněte) rukojeť jezdce dolů.

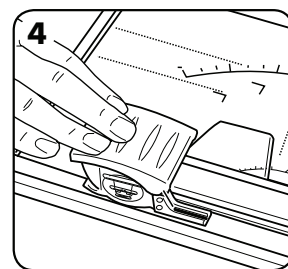

4. Stlačte rukojeť jezdce, aby se aktivovalo vodítko SafeCut™ LED.

VÝMĚNA BATERIE NA SVĚTLNÉM VODÍTKU ELECTRON SAFECUT™

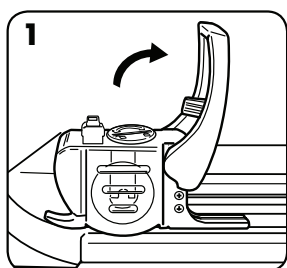

1. Posuňte ořezávací hlavu na jeden konec do uzamčené polohy. Vytáhněte (vyklopte) držadlo hlavy směrem nahoru.

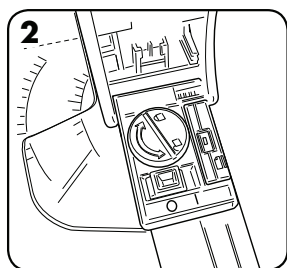

2. Odšroubujte víko baterie pomocí mince nebo šroubováku (otočením doleva se víko baterie otvírá, otočením doprava zavírá).

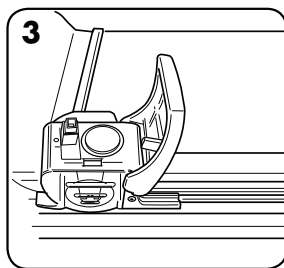

3. Vyndejte starou baterii a vložte novou baterii [typ CR2023].

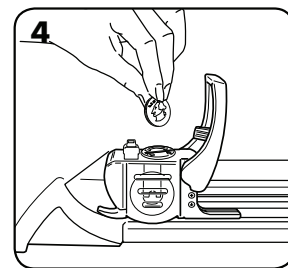

4. Zavřete kryt baterie.

ZÁRUKA

Společnost Fellowes zaručuje, že všechny ostatní součásti stroje budou prosty vad materiálu a provedení po dobu 2 let od data nákupu původním spotřebitelem. Pokud se v průběhu záruční doby kterákoliv část ukáže závadnou, vaše jediná a výlučná forma nápravy bude oprava nebo výměna vadné části podle volby a na náklady společnosti Fellowes. Tato záruka neplatí v případě zneužití, nesprávného použití nebo nepovolené opravy. JAKÁKOLI MLČKY PŘEDPOKLÁDANÁ ZÁRUKA, VČETNĚ ZÁRUKY PRODEJNOSTI NEBO VHODNOSTI PRO URČITÝ

ÚČEL, JE TÍMTO ČASOVĚ OMEZENA NA VÝŠE UVEDENOU ZÁRUČNÍ DOBU. Společnost Fellowes v žádném případě nezodpovídá na následné nebo náhodné škody, které je možno přisoudit tomuto výrobku. Trvání, termíny a podmínky této záruky platí celosvětově, kromě případů, kde místní zákony ukládají různá omezení, restrikce nebo podmínky. Se žádostí o další podrobnosti nebo o servis v rámci této záruky se obraťte přímo na nás nebo na prodejce. Tato záruka se nevztahuje na doplňkové a spotřebitelné součástky.

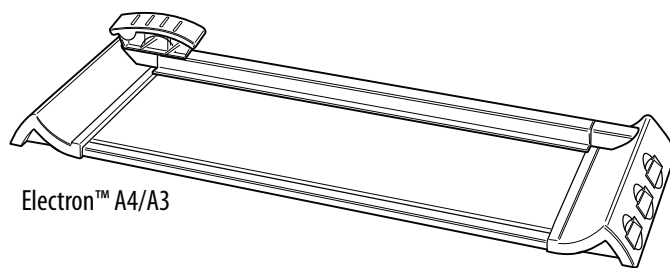

Electron™ A4/A3

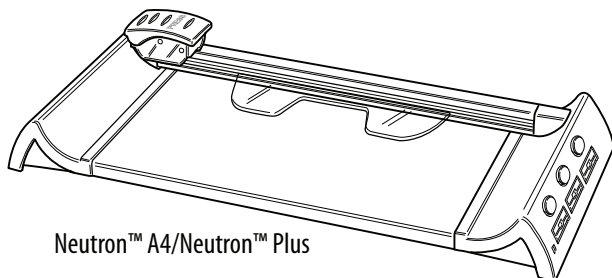

Neutron™ A4/Neutron™ Plus

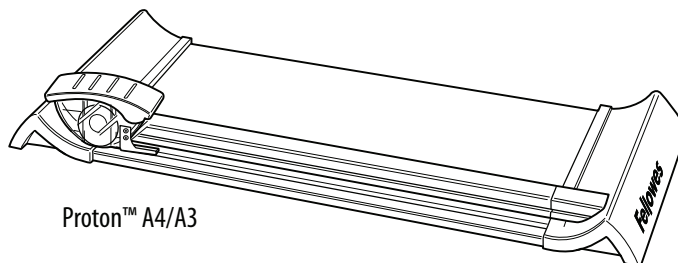

Proton™ A4/A3

CHARAKTERISTIKY A OBSAH

CRC č.	Model	Počet nožov	Dĺžka rezu (mm)	Kapacita rezu (listov 80 gsm)
54100	Neutron A4	1	320	10
54101	Neutron Plus	4	320	10
54102	Proton A4	1	320	10
54103	Proton A3	1	460	10

CRC č.	Model	Počet nožov	Dĺžka rezu (mm)	Kapacita rezu (listov 80 gsm)
54104	Electron A4	4	320	10
54105	Electron A3	4	460	10

DÔLEŽITÉ BEZPEČNOSTNÉ POKYNY — pred použitím si prečítajte!



POZOR

- Upozornenie: nože sú veľmi ostré.
- SafeCut™ kazeta na uzatváranie nožov – nepokúšajte sa ručne vyberať nože.
- Vždy dozerajte na deti počas používania.
- Nepreťažujte orezávač počas používania.
- Držte domáce zvieratá ďalej počas použitia laminátora.
- Neotvárajte a ani sa nepokúšajte opravovať orezávač, lebo tak stratíte garanciu. Ak máte otázky, kontaktujte Služby zákazníkom. Majte na pamäti, že táto záruka neplatí v prípade zneužitia, nesprávneho použitia alebo neoprávnenej opravy.
- Nepokúšajte sa otvoriť kazetu SafeCut™ na nože.

Potrebuje pomoc?

Zákaznícky servis
www.fellowes.com
 Nechajte našich odborníkov, aby vám pomohli s riešením. Vždy zavolajte najprv spoločnosti Fellowes, až potom kontaktujte predajcu.

REZANIE PAPIERA A FOTOGRFÍ

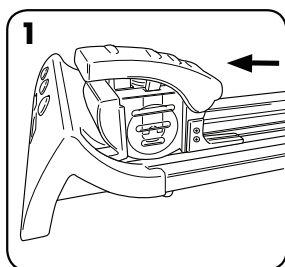

1. Posuňte rezáciu rukoväť na jeden z koncov do bezpečnej pozície.

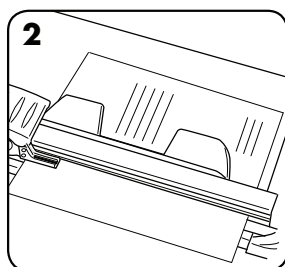

2. Uložte vec (napr. fotografiu alebo papier) na rezací stôl.

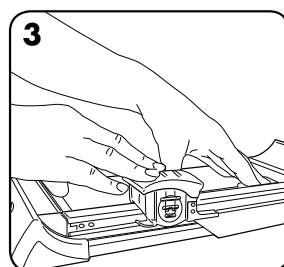

3. Držte papier neustále rukou alebo pomocou úchytného mechanizmu. Na aktivovanie rezacích nožov zatlačte smerom dole rezáciu rukoväť. (Electron: keď zatlačíte rezáciu rukoväť smerom dole, LED (kontrolné svetielko) sa rozsvieti.)

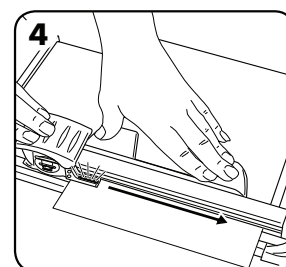

4. Na rezanie, zatlačte rezáciu rukoväť a posúvajte ju až na druhý koniec vodiacej lišty. Na konci vodiacej lišty, upustíte rezáciu rukoväť a blokovací mechanizmus sa uvoľní.

BEZPEČNOSTNÉ CHARAKTERISTIKY SYSTÉMU SAFECUT™

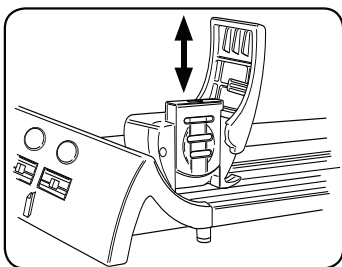

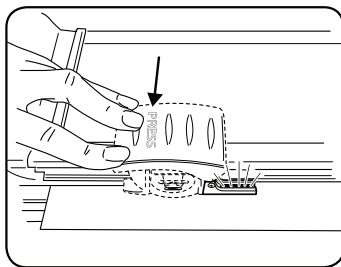

Zásobníkový systém SafeCut™ umožňuje používateľom vymieňať rezací zásobník bez toho, aby sa dotýkali nožov.

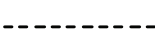

LED Sprievodca SafeCut™ napomáha pri používaní orezávača Electron, pomocou presného osvetľovania kontrolných svetielok. Istejšie ako laserový sprievodca.

SADA PRÍSLUŠENSTIEV

3 Kreatívne nože SafeCut™		Kapacita rezu (listov 80 gsm)
	 Vlnkový rez	5
	 Dierkovač	5
	 Ohýbač	3

CRC č.	Obsah sady
54113	3 Kreatívne nože SafeCut™ (1x vlnkový, 1x dierkovač, 1x ohýbač)
54114	2 rovné nože SafeCut™
54115	A4 rezacie pásiky (x3)
54116	A3 rezacie pásiky (x3)

VÝMENA NOŽOVÝCH KAZIET

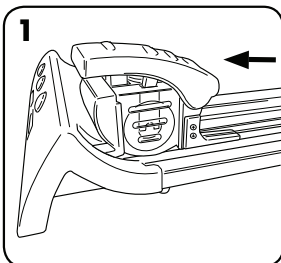

1. Posuňte rezáciu rukoväť na jeden z koncov do bezpečnej pozície.

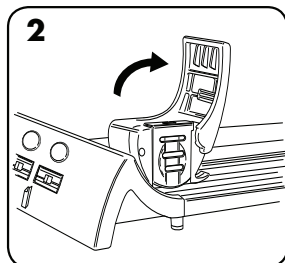

2. Zdvihnite rezáciu rukoväť smerom hore.

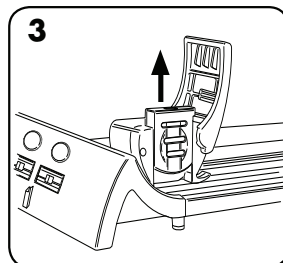

3. Zatiahnite SafeCut™ zásobník smerom hore von z lišty a vložte nový zásobník (zatlačte smerom dole do pôvodnej pozície).

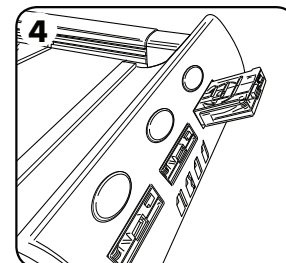

4. Zatlačte žltý gombík na uvoľnenie kazety z bázy. Vráťte naspäť systém SafeCut™ na uskladňovacie miesto v báze.

VÝMENA REZACÍCH PÁSIKOV

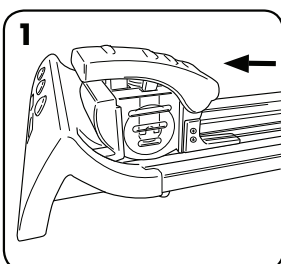

1. Posuňte rezáciu rukoväť na jeden z koncov do bezpečnej pozície.

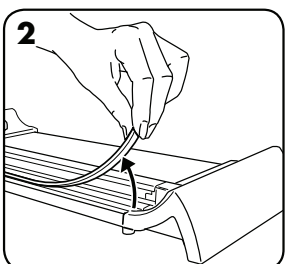

2. Vyberte rezací pásik z bázy orezávača.

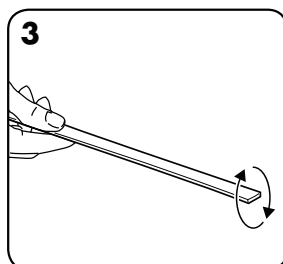

3. Otočte rezací pásik tak, aby sa použila aj druhá strana.

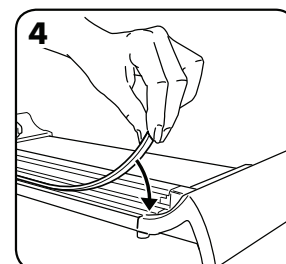

4. Nahradenie dostupných pásikov (pozri príslušenstvo).

SLOVENSKY

VODIDLO ELECTRON SAFECUT™ LED

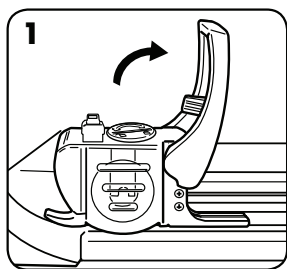

1. Posuňte rezáciu rukoväť ne jeden z koncov do bezpečnej pozície. Potiahnite (kmitaním) rezáciu rukoväť smerom hore.

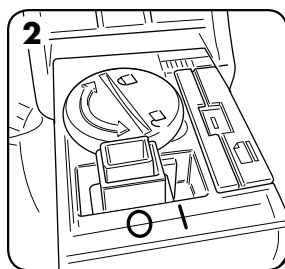

2. Prepnete vypínač do polohy ZAPNUTÉ (I).

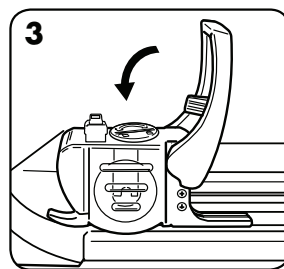

3. Stiahnite (vykývajte) rukoväť jazdca dole.

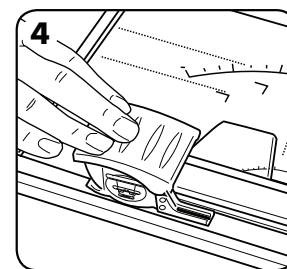

4. Stlačte rukoväť jazdca, aby sa aktivovalo vodidlo SafeCut™ LED.

VÝMENA BATERKY NA LED SPRIEVODCOVI ELECTRON SAFECUT™

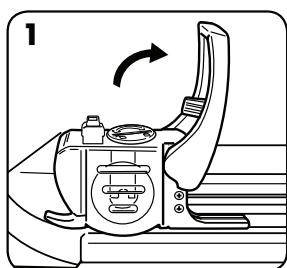

1. Posuňte rezáciu rukoväť ne jeden z koncov do bezpečnej pozície. Potiahnite (kmitaním) rezáciu rukoväť smerom hore.

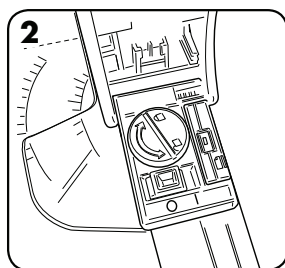

2. Odskrutkujte veko batérie pomocou mince alebo šroubováka (otočením doľava sa veko batérie otvára, otočením doprava zatvára).

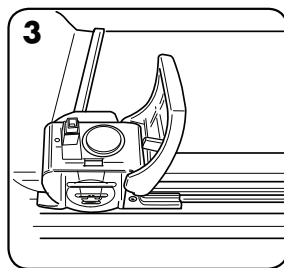

3. Vyberte starú batériu a nahradte ju novou [typ CR2023].

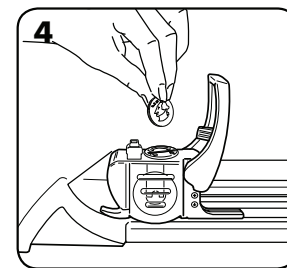

4. Zavrite kryt batery.

ZÁRUKA

Spoločnosť Fellowes zaručuje, že všetky ostatné súčasti stroja budú bez závad materiálu a výroby po dobu 2 rokov od dátumu nákupu pôvodným spotrebiteľom. Ak sa nájde počas záručnej lehoty chybná časť, výhradné nápravné opatrenie bude oprava alebo výmena chybných častí na náklady spoločnosti Fellowes podľa jej úvahy. Táto záruka neplatí v prípade zneužitia, nesprávneho použitia alebo nedovolenej opravy. KAŽDÁ ZAHRNUTÁ ZÁRUKA VRÁTANE PREDAJNOSTI ALEBO SPÔSOBILOSTI PRE URČITÝ ÚČEL JE TÝMTO OBMEDZENÁ NA TRVANIE PRIMERANEJ ZÁRUČNEJ LEHOTY VYSVETLENEJ TUPREDTÝM. V žiadnom prípade

nebude spoločnosť Fellowes zodpovedná za prípadné následné alebo vedľajšie škody prisudzované tomuto výrobku. Táto garancia vám poskytuje špecifické legálne práva. Trvanie, termíny a podmienky tejto záruky platia celosvetovo, okrem prípadov, kde miestne zákony ukladajú rôzne obmedzenia, reštrikcie alebo podmienky. So žiadosťou o ďalšie podrobnosti alebo o servis v rámci tejto záruky obráťte sa priamo na svojho predajcu alebo na nás. Príslušenstvo a spotrebný materiál nespádajú do tejto garancie.

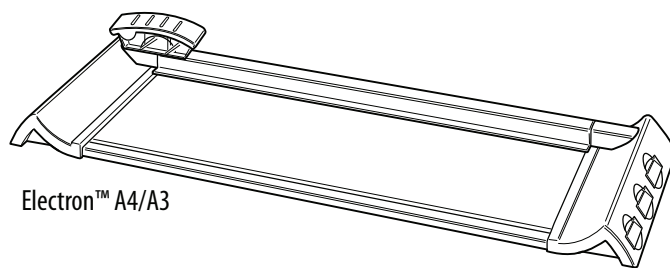

Electron™ A4/A3

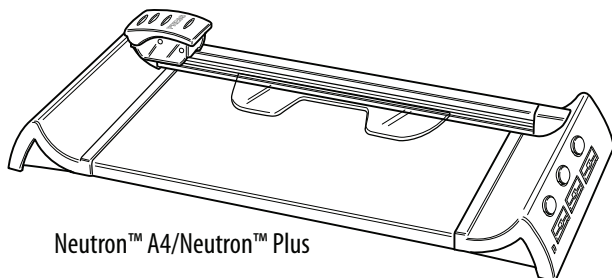

Neutron™ A4/Neutron™ Plus

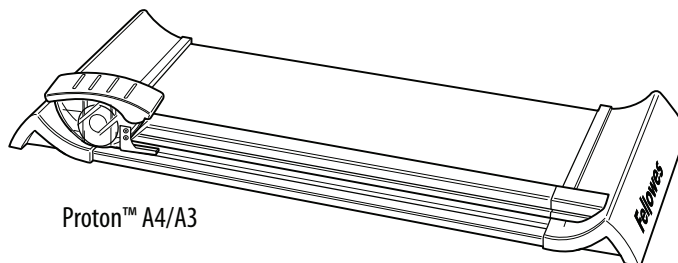

Proton™ A4/A3

TELJESÍTMÉNY ÉS TARTALOM

CRC-szám	Modell	Vágóélek száma	Vágási hossz (mm)	Vágókapacitás (80 g/m ² -es lapok)
54100	Neutron A4	1	320	10
54101	Neutron Plus	4	320	10
54102	Proton A4	1	320	10
54103	Proton A3	1	460	10

CRC-szám	Modell	Vágóélek száma	Vágási hossz (mm)	Vágókapacitás (80 g/m ² -es lapok)
54104	Electron A4	4	320	10
54105	Electron A3	4	460	10

FONTOS BIZTONSÁGI UTASÍTÁSOK — Használat előtt olvassa el!

VIGYÁZAT

- Vigyázat: a vágóélek rendkívül élesek!
- A SafeCut™ kazetta biztonságosan befogja a vágóéleket – ne próbálja meg a vágóéleket kézzel kiszedni!
- Gyermeknek a készüléket mindig csak felügyelet alatt használják.
- Ne terhelje túl a lapvágó gépet.
- Használat közben tartsa távol a háziállatokat a lapvágó géptől.
- Ne nyissa ki vagy ne próbálja meg megjavítani, mert ez érvényteleníti a garanciát. Ha kérdései vannak, lépjen kapcsolatba a Vevőszolgálattal. Kérjük, jegyezze meg, hogy a garancia nem vonatkozik a helytelen használatra, hibás kezelésre, vagy illetéktelen javításra.
- Ne próbálja meg kinyitni a SafeCut™ vágóél-kazettákat.

Segítségre van szüksége?

Vevőszolgálat
www.fellowes.com

Hagyja, hogy szakértőink segítsenek egy megoldással. Mielőtt megkeresné a forgalmazót, akitől a készüléket vásárolta, először mindig a Fellowes vállalatot hívja.

PAPÍR ÉS FÉNYKÉPEK VÁGÁSA

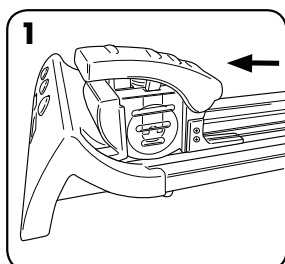

1. Csúsztassa a vágó-kocsit a készülék egyik végéhez a zárt helyzetbe.

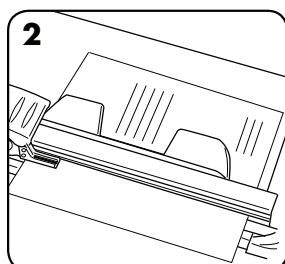

2. Helyezzen egy méretre vágandó tételt (pl. fényképet vagy papírt) a vágóasztalra.

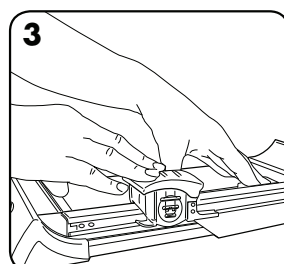

3. Kézzel vagy szorítószerkezettel tartsa a papírt egyenesen. A vágóél aktiválásához nyomja le a kocsifogantyúját. (Az Electron modellnél: a fogantyú lenyomásakor a LED fény világítani fog.)

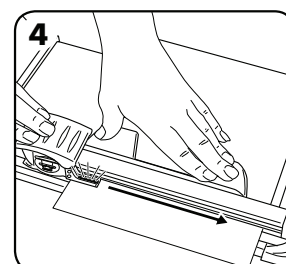

4. Vágáshoz a fogantyút nyomja lefelé, és a kocsit csúsztassa el a rúd végéig. A rúd végén engedje fel a kocsit, és a szorítószerkezet is felenged.

SAFECUT™ BIZTONSÁGI FUNKCIÓK

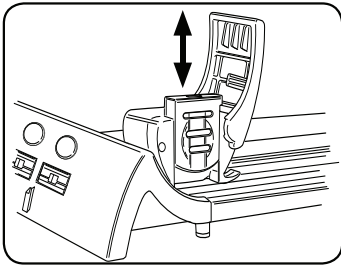



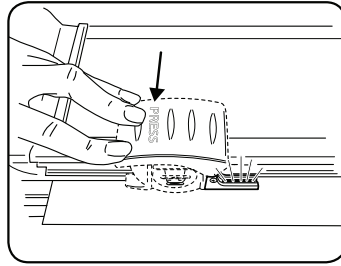

A SafeCut™ kazetta rendszer a vágókazetta cseréjét anélkül teszi lehetővé, hogy a felhasználónak hozzá kellene érnie a vágóélekhöz.



A SafeCut™ LED vezető, az Electron lapvágón a megvilágított precizitás biztosítására. Biztonságosabb a lézeres vezetőknél.

TARTOZÉKSOMAGOK

3 kreatív SafeCut™ vágóél		Vágókapacitás (80 g/m ² -es lapok)
	 Hullámvágó	5
	 Perforáló	5
	 Behajtó (hajtó)	3

CRC-szám	A csomag tartalma
54113	3 kreatív SafeCut™ vágóél (1x hullámvágó, 1x perforáló, 1x behajtó)
54114	2 egyenes SafeCut™ vágóél
54115	A4-es gumisínek (x3)
54116	A3-as gumisínek (x3)

A VÁGÓÉL-KAZETTA CSERÉJE

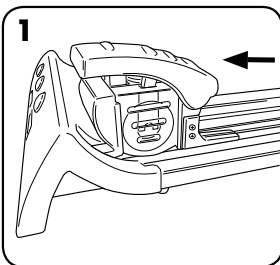

1. Csúsztassa a vágó-kocsit a készülék egyik végéhez a zárt helyzetbe.

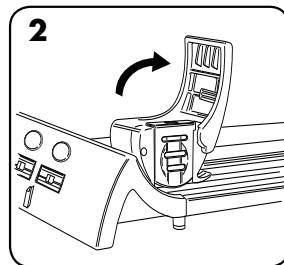

2. Emelje fel a kocsifogantyúját.

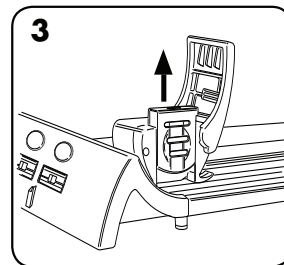

3. Felfelé húzza ki a SafeCut™ kazettát a vágó-kocsiból, majd helyezze be az új kazettát (nyomja le, hogy bepattintsa a helyére).

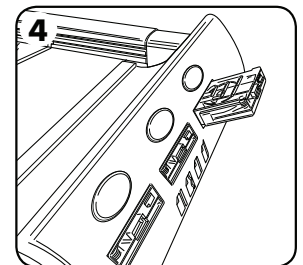

4. Nyomja meg a sárga gombot a kazetta kiengedésére az alaptárból. A felhasználatlan SafeCut™ kazettát tegye vissza az alaptár tároló részébe.

A GUMISÍN CSERÉJE

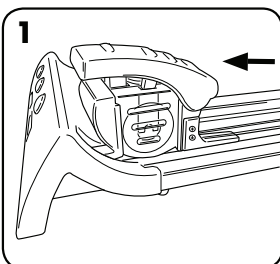

1. Csúsztassa a vágó-kocsit a készülék egyik végéhez a zárt helyzetbe.

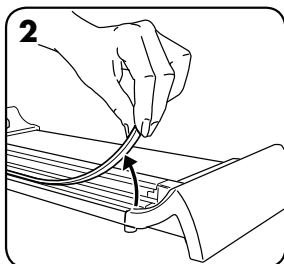

2. Vegye le a gumisínt a lapvágó alaptárból.

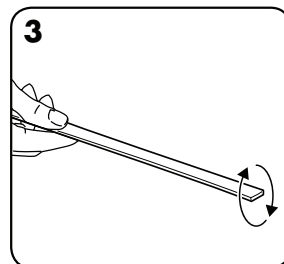

3. Fordítsa meg a gumisínt, hogy mindkét oldala felhasználásra kerüljön.

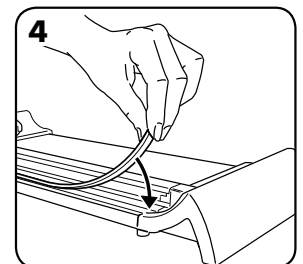

4. Cseré gümisínek rendelhetők (lásd a tartozékok részletezését).

ELECTRON SAFECUT™ LED VEZETŐ

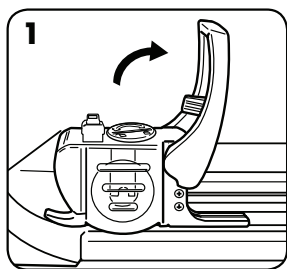

1. Csúsztassa a vágó-kocsit a készülék egyik végéhez a zárt helyzetbe. Húzza (lendítse) a koci fogantyúját fel.

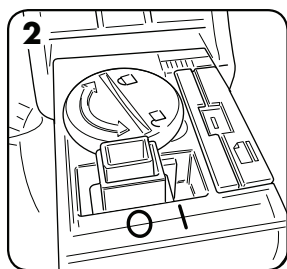

2. Fordítsa a kapcsolót a BE (I) állásra.

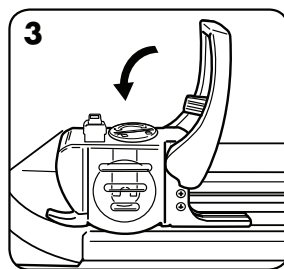

3. Húzza (lendítse) a koci fogantyúját le.

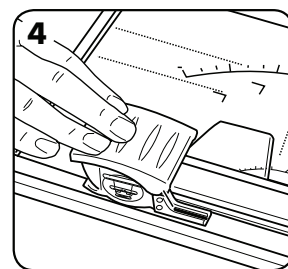

4. Nyomja le a fogantyút a SafeCut™ LED vezető aktiválására.

AZ ELECTRON SAFECUT™ LED VEZETŐ ELEMÉNEK CSERÉJE

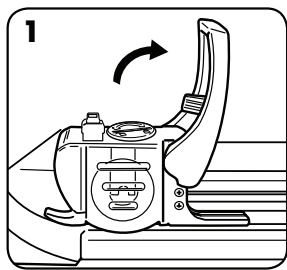

1. Csúsztassa a vágó-kocsit a készülék egyik végéhez a zárt helyzetbe. Húzza (lendítse) a koci fogantyúját fel.

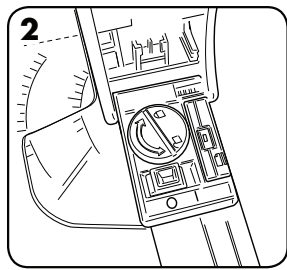

2. Egy érmével vagy csavarhúzóval csavarozza ki az elemet fedő lap csavarjait (balra fordítással kinyitja, jobbra fordítással lezárja az elemrekesz fedelét).

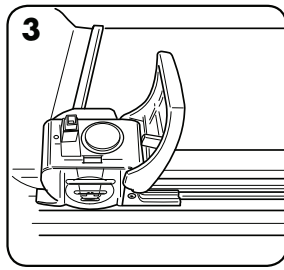

3. Vegye ki az elhasznált elemet, és cserélje ki az újra [CR2023-as típus].

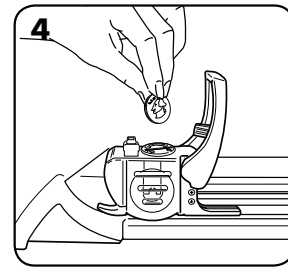

4. Zárja le az elemet fedő lapot.

GARANCIA

A Fellowes az eredeti fogyasztó általi vásárlás dátumától számított 2 évre garántálja, hogy a gép minden egyéb alkatrésze mentes az anyag- és megmunkálási hibáktól. Ha a jótállási időszak alatt valamely alkatrész hibásnak bizonyul, az egyetlen és kizárólagos orvoslás a hibás alkatrésznek vagy a terméknek - a Fellowes választása szerint - a Fellowes költségére történő javítása vagy cseréje. A jótállás nem vonatkozik a helytelen használat, hibás kezelés vagy illetéktelen javítás eseteire. A JÓTÁLLÁS, BELEÉRTVE AZ ELADHATÓSÁGOT VAGY EGY BIZONYOS CÉLRA VALÓ ALKALMASSÁGOT, IDŐTARTAMÁT TEKINTVE A FENT KÖZZÉTETT

JÓTÁLLÁSI IDŐSZAKRA KORLÁTOZÓDÍK. A Fellowes semmilyen esetben sem felelős a terméknek tulajdonítható következményi vagy véletlen károkért. Ez a jótállás sajátos jogokat ad Önnek. A jelen jótállás időtartama, kikötései és feltételei világszerte érvényesek, kivéve, ahol a helyi törvények különböző korlátozásokat, megkötéseket vagy feltételeket követelnek meg. További részletekért, vagy a jelen jótállás keretében történő szervizelésért lépjen kapcsolatba velünk vagy a kereskedővel. A tartozékokra és a fogyóciikkre nem vonatkozik a jótállás.

PORTUGUÊS

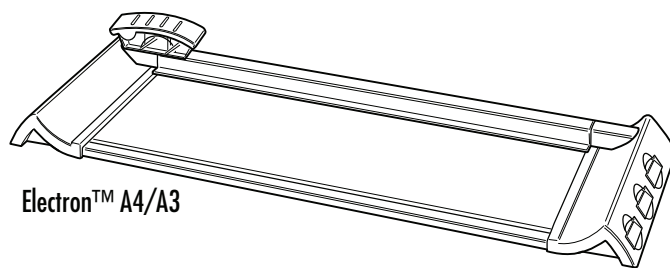

Electron™ A4/A3

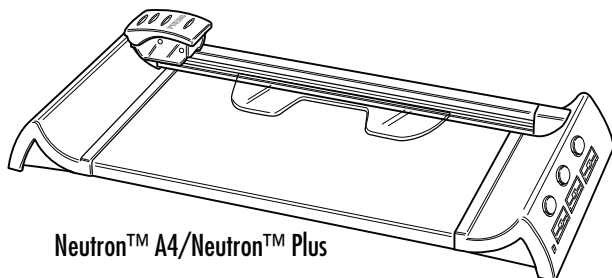

Neutron™ A4/Neutron™ Plus

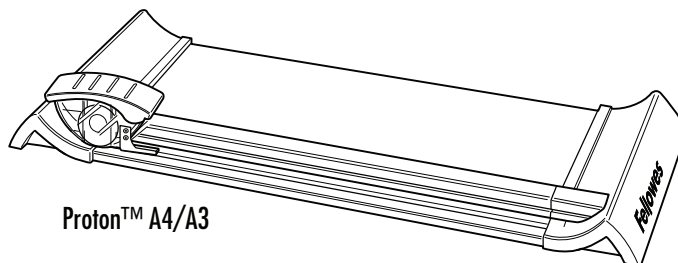

Proton™ A4/A3

CAPACIDADES E CONTEÚDO

Nº CRC	Modelo	Número de lâminas	Comprimento de corte (mm)	Capacidade de corte (folhas 80 gsm)
54100	Neutron A4	1	320	10
54101	Neutron Plus	4	320	10
54102	Proton A4	1	320	10
54103	Proton A3	1	460	10

Nº CRC	Modelo	Número de lâminas	Comprimento de corte (mm)	Capacidade de corte (folhas 80 gsm)
54104	Electron A4	4	320	10
54105	Electron A3	4	460	10

INSTRUÇÕES DE SEGURANÇA IMPORTANTES — Leia antes de utilizar o aparelho!

ATENÇÃO

- Cuidado: as lâminas são extremamente afiadas.
- A cassetete SafeCut™ contém lâminas — não tente extrair as lâminas manualmente.
- Durante a utilização vigie sempre as crianças.
- Não sobrecarregue o cortador.
- Mantenha os animais de estimação afastados do cortador durante o seu funcionamento.
- Não abra nem tente reparar, pois isso tornará a garantia nula. Contacte o Serviço de Apoio ao Cliente se tiver quaisquer dúvidas. Observe que a garantia não se aplica em casos de utilização abusiva, manuseamento inadequado ou reparação não autorizada.
- Não tente abrir os cartuchos de lâminas SafeCut™.

Precisa de ajuda?

Serviço de apoio ao cliente
www.fellowes.com
 Deixe os nossos peritos ajudá-lo a encontrar uma solução. Ligue sempre para a Fellowes antes de entrar em contacto com o seu ponto de venda.

CORTAR PAPEL E FOTOS

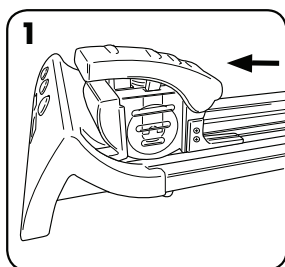

1. Faça deslizar o carro de corte para uma extremidade, para a posição de bloqueio.

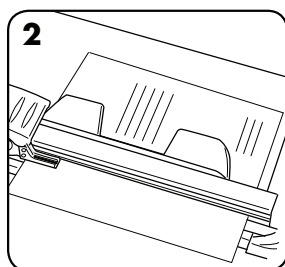

2. Coloque o artigo (por ex., foto ou papel) sobre a mesa de corte.

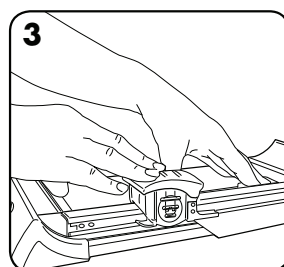

3. Segure bem o papel com a mão ou com o mecanismo de fixação. Para activar a lâmina de corte, empurre o manipulador do carro para baixo. (Electron: ao premir o manipulador para baixo, o LED acende-se.)

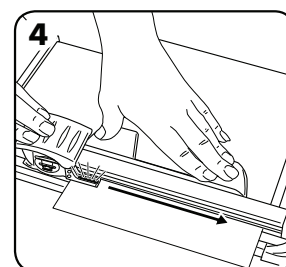

4. Para cortar, empurre o manipulador para baixo e faça deslizar o carro no comprimento até alcançar o fim da barra. No fim da barra, solte o carro e o mecanismo de fixação solta-se.

FUNCIONALIDADES DE SEGURANÇA SAFECUT™

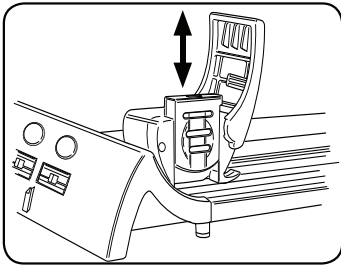



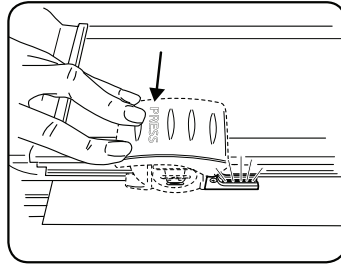



O sistema de cartucho SafeCut™ permite aos utilizadores alterar o cartucho de corte sem tocar nas lâminas.



A Guia LED de SafeCut™ no cortador Electron para uma precisão iluminada. Mais seguro do que as guias de laser.

CONJUNTOS DE ACESSÓRIOS

3 lâminas criativas SafeCut™		Capacidade de corte (folhas 80 gsm)
	 Corte onda (Wave Cut)	5
	 Perfurar	5
	 Dobrar (dobra)	3

Nº CRC	Conteúdo dos conjuntos
54113	3 lâminas criativas SafeCut™ (1x onda, 1x perfurar, 1x dobrar)
54114	2 lâminas direitas SafeCut™
54115	Fitas de corte A4 (3)
54116	Fitas de corte A3 (3)

SUBSTITUIR A CASSETE DE LÂMINAS

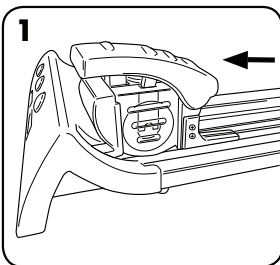

1. Faça deslizar o carro de corte para uma extremidade, para a posição de bloqueio.

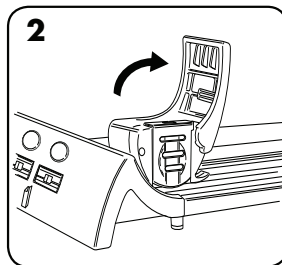

2. Levante o manipulador do carro para cima.

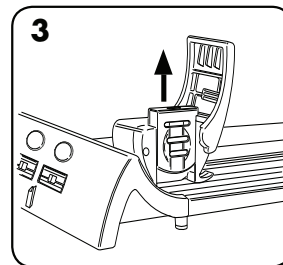

3. Puxe o cartucho SafeCut™ para cima, para fora do carro de corte, e introduza o novo cartucho (prima para encaixar no lugar com um clique).

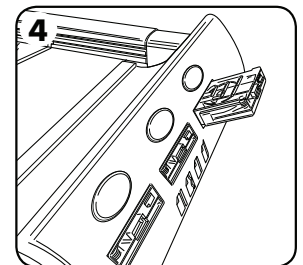

4. Prima o botão amarelo para soltar a cassette da base. Volte a colocar o SafeCut™ não utilizado na abertura de armazenagem na base.

SUBSTITUIR A FITA DE CORTE

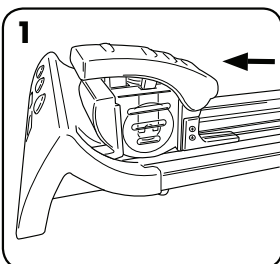

1. Faça deslizar o carro de corte para uma extremidade, para a posição de bloqueio.

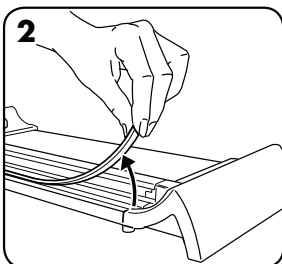

2. Retire a fita de corte da base do cortador.

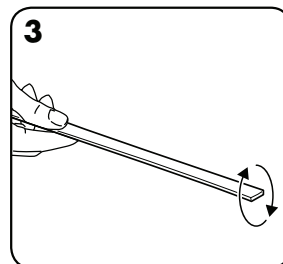

3. Vire a fita de corte para ser utilizada de ambos os lados.

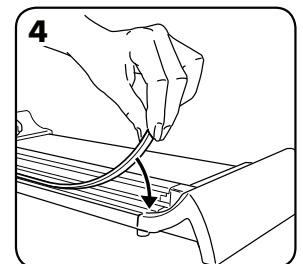

4. Fitas de substituição disponíveis (ver detalhes de acessórios).

PORTUGUÊS

GUIA LED DO ELECTRON SAFECUT™

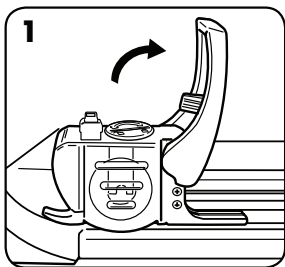

1. Faça deslizar o carro de corte para uma extremidade, para a posição de bloqueio. Puxe (movimentando de um lado para o outro) o manipulador do carro para cima.

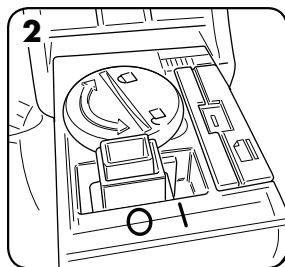

2. Ligue o interruptor na posição LIGADO (I).

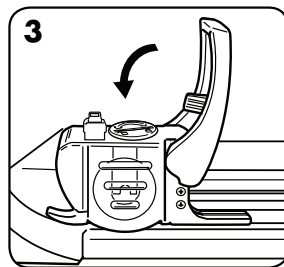

3. Puxe (vire) o manipulador do carro para baixo.

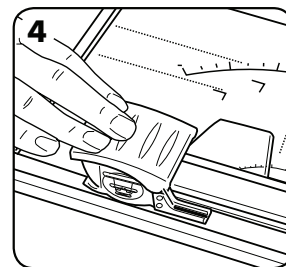

4. Prima o manipulador para ativar a Guia LED SafeCut™.

SUBSTITUIR A BATERIA NA GUIA LED ELECTRON SAFECUT™

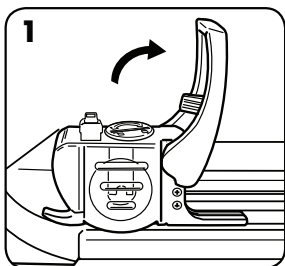

1. Faça deslizar o carro de corte para uma extremidade, para a posição de bloqueio. Puxe (movimentando de um lado para o outro) o manipulador do carro para cima.

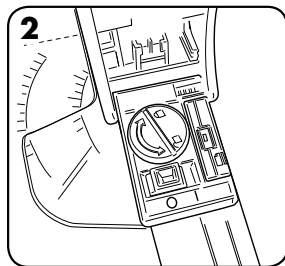

2. Desenrosque a tampa de baterias com uma moeda ou uma chave de fenda (para abrir a tampa de bateria, rode para à esquerda, para fechá-la, rode para à direita).

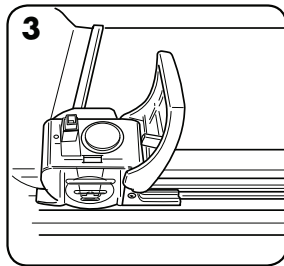

3. Retire a bateria velha e substitua pela nova [tipo CR2023].

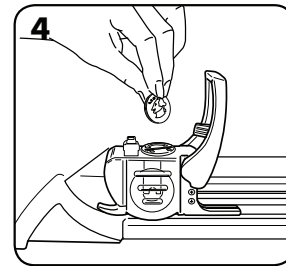

4. Feche a cobertura da bateria.

GARANTIA

A Fellowes garante que todas as peças da máquina estão isentas de defeitos de material e mão-de-obra durante um período de 2 anos a contar da data de compra pelo consumidor original. Se encontrar um defeito em qualquer peça durante o período de garantia, o seu único e exclusivo recurso será a reparação ou a substituição, mediante o critério e a expensas da Fellowes, da peça com defeito. Esta garantia não se aplica em casos de utilização abusiva, manuseamento inadequado ou reparação não autorizada. QUALQUER GARANTIA IMPLÍCITA, INCLUINDO DE COMERCIALIZAÇÃO OU DE ADEQUAÇÃO PARA UMA FINALIDADE EM PARTICULAR, É AQUI LIMITADA AO PERÍODO DE GARANTIA APROPRIADO,

CONFORME ANTERIORMENTE ESTABELECIDO. Em caso algum poderá a Fellowes ser responsabilizada por quaisquer danos secundários ou acidentais imputáveis a este produto. Esta garantia dá-lhe direitos legais específicos. A duração e os termos e condições desta garantia são válidos a nível mundial, salvo em caso de imposição de limitações, restrições ou condições diferentes pelas leis locais. Para obter mais pormenores ou receber assistência nos termos desta garantia, contacte-nos directamente ou consulte o seu agente autorizado. Os acessórios e consumíveis não estão incluídos na garantia.



CUSTOMER SERVICE & SUPPORT

www.fellowes.com

Europe Freephone: 00800-1810-1810

Benelux: +31-(0)-13-458-0580

Deutschland: +49 (0)511 545489-0

France: +33 (0) 1 78 64 91 00

Italia: +39-071-730041

Polska: +48 (22) 205-21-10

España/Portugal: +34-91-748-05-01

United Kingdom: +44 (0) 1302 836836

Australia: +61-1-800-33-11-77



1789 Norwood Avenue, Itasca, Illinois 60143 • 1-800-955-0959 • www.fellowes.com

© 2017 Fellowes, Inc. | Part #410481