



Questo manuale d'istruzione è fornito da [trovaprezzi.it](http://trovaprezzi.it). Scopri tutte le offerte per [Fitbit Inspire Nero](#) o cerca il tuo prodotto tra le [migliori offerte di Smartwatch e wearable](#)



# fitbit inspire™



User Manual  
Version 2.1

# Table of Contents

---

<b>Get started</b> .....	<b>5</b>
What's in the box .....	5
<b>Set up Inspire</b> .....	<b>6</b>
Charge your tracker .....	6
Set up with your phone or tablet .....	7
Set up with your Windows 10 PC .....	8
See your data in the Fitbit app .....	8
<b>Wear Inspire</b> .....	<b>9</b>
Wear Inspire on your wrist .....	9
Secure the band .....	9
Handedness .....	11
Wear Inspire in a clip .....	11
Clip Placement .....	12
<b>Change the band</b> .....	<b>13</b>
Remove a band .....	13
Attach a band .....	13
<b>Basics</b> .....	<b>15</b>
Navigate Inspire .....	15
Basic navigation .....	15
Quick settings .....	17
Care for Inspire .....	18
<b>Change the clock face</b> .....	<b>19</b>
<b>Notifications</b> .....	<b>20</b>
Set up notifications .....	20
See incoming notifications .....	21
Turn off notifications .....	21
<b>Timekeeping</b> .....	<b>23</b>

Set an alarm .....	23
Dismiss or snooze an alarm .....	24
Use the Timers app .....	25
<b>Activity and Sleep .....</b>	<b>26</b>
See your stats .....	26
Track a daily activity goal .....	27
Choose a goal .....	27
Track your hourly activity .....	27
Track your exercise automatically .....	28
Track your sleep .....	28
Set a sleep goal .....	28
Learn about your sleep habits .....	28
<b>Update, Restart, and Erase .....</b>	<b>29</b>
Update Inspire .....	29
Restart Inspire .....	29
Erase Inspire .....	30
<b>Troubleshooting .....</b>	<b>31</b>
Unresponsive device .....	31
<b>General Info and Specifications .....</b>	<b>32</b>
Sensors .....	32
Materials .....	32
Wireless technology .....	32
Haptic feedback .....	32
Battery .....	32
Memory .....	33
Display .....	33
Band size .....	33
Environmental conditions .....	33
Learn more .....	34
Return policy and warranty .....	34
<b>Regulatory &amp; Safety Notices .....</b>	<b>35</b>
USA: Federal Communications Commission (FCC) statement .....	35

Canada: Industry Canada (IC) statement .....	36
European Union (EU) .....	37
Argentina .....	38
Australia and New Zealand .....	39
China .....	39
India .....	41
Israel .....	41
Japan .....	41
Mexico .....	41
Morocco .....	42
Nigeria .....	42
Oman .....	42
Pakistan .....	43
Philippines .....	43
Serbia .....	43
South Korea .....	44
Taiwan .....	44
United Arab Emirates .....	46
Zambia .....	47
Safety Statement .....	47

# Get started

---

Fitbit Inspire is a friendly fitness tracker for every day that helps you build healthy habits. Take a moment to review our complete safety information at [fitbit.com/safety](https://fitbit.com/safety). Inspire is not intended to provide medical or scientific data.

## What's in the box

Your Inspire box includes:



Tracker with small band  
(color and material vary)



Charging cable



Additional large band  
(color and material vary)

The detachable bands on Inspire come in a variety of colors and materials, sold separately.

# Set up Inspire

---

For the best experience, use the Fitbit app for iPhones and iPads or Android phones. You can also set up Inspire on Windows 10 devices. If you don't have a compatible phone or tablet, use a Bluetooth-enabled Windows 10 PC. Keep in mind that a phone is required for call, text, calendar, and smartphone app notifications.

To create a Fitbit account, you're prompted to enter your birthdate, height, weight, and sex to calculate your stride length and to estimate distance, basal metabolic rate, and calorie burn. After you set up your account, your first name, last initial, and profile picture are visible to all other Fitbit users. You have the option to share other information, but most of the information you provide to create an account is private by default.

## Charge your tracker

A fully-charged Inspire has a battery life of up to 5 days. Battery life and charge cycles vary with use and other factors; actual results will vary.

To charge Inspire:

1. Plug the charging cable into the USB port on your computer, a UL-certified USB wall charger, or another low-energy charging device.
2. Hold the other end of the charging cable near the port on the back of the tracker until it attaches magnetically. Make sure the pins on the charging cable align with the port on the back of your tracker.

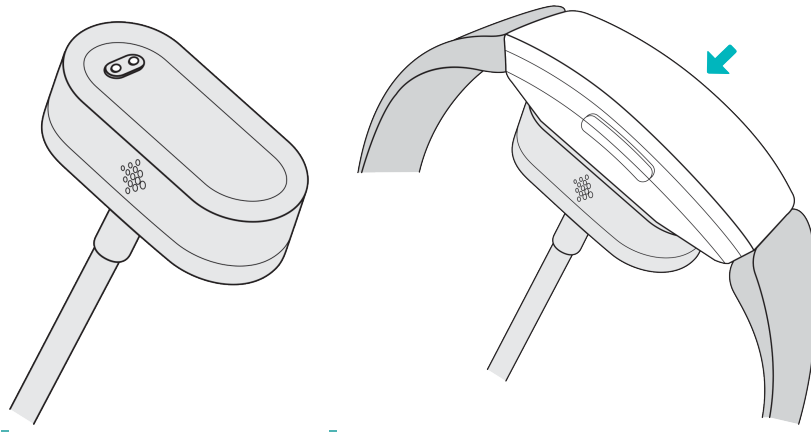

Charging fully takes about 1-2 hours. While the tracker charges, you can press the button to check the battery level. A fully-charged tracker shows a solid battery icon with a smile.

## Set up with your phone or tablet

Set up Inspire with the Fitbit app. The Fitbit app is compatible with most popular phones and tablets. For more information, see [fitbit.com/devices](https://www.fitbit.com/devices).

To get started:

1. Download the Fitbit app:
  - [Apple App Store](#) for iPhones and iPads
  - [Google Play Store](#) for Android phones
  - [Microsoft Store](#) for Windows 10 devices
2. Install the app, and open it.
  - If you already have a Fitbit account, log in to your account > tap the Today tab  > your profile picture > **Set Up a Device**.
  - If you don't have a Fitbit account, tap **Join Fitbit** to be guided through a series of questions to create a Fitbit account.
3. Continue to follow the on-screen instructions to connect Inspire to your account.

When you're done with setup, read through the guide to learn more about your new tracker and then explore the Fitbit app.

For more information, see [help.fitbit.com](https://help.fitbit.com).

## Set up with your Windows 10 PC

If you don't have a compatible phone, you can set up and sync Inspire with a Bluetooth-enabled Windows 10 PC and the Fitbit app.

To get the Fitbit app for your computer:

1. Click the Start button on your PC and open the Microsoft Store.
2. Search for "Fitbit app". After you find it, click **Free** to download the app to your computer.
3. Click **Microsoft account** to sign in with your existing Microsoft account. If you don't already have an account with Microsoft, follow the on-screen instructions to create a new account.
4. Open the app.
  - If you already have a Fitbit account, log in to your account, and tap the account icon  > **Set Up a Device**.
  - If you don't have a Fitbit account, tap **Join Fitbit** to be guided through a series of questions to create a Fitbit account.
5. Continue to follow the on-screen instructions to connect Inspire to your account.

When you're done with setup, read through the guide to learn more about your new tracker and then explore the Fitbit app.

## See your data in the Fitbit app

Sync Inspire to transfer your data to the Fitbit app, where you can view your activity and sleep data, log food and water, participate in challenges, and more.

Each time you open the Fitbit app, Inspire syncs automatically when it's nearby. You can also use the **Sync Now** option in the app at any time.

# Wear Inspire

---

Choose to wear Inspire around your wrist or in the clip accessory (sold separately). If you need to remove the band or attach a different band, see the instructions in ["Change the band" on page 13](#).

## Wear Inspire on your wrist

Wear Inspire a finger's width above your wrist bone. Attach the bands, and then securely fasten your tracker on your wrist. For more information, see ["Change the band" on page 13](#).

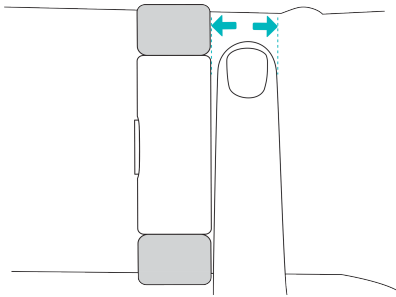

## Secure the band

1. If you previously wore Inspire in a clip, change your device setting to On Wrist. For more information, see ["Navigate Inspire" on page 15](#).
2. Place Inspire around your wrist.
3. Slide the end of the band with the peg through the loop.
4. Align both ends of the band so they directly overlap, and choose the hole that best fits your wrist.

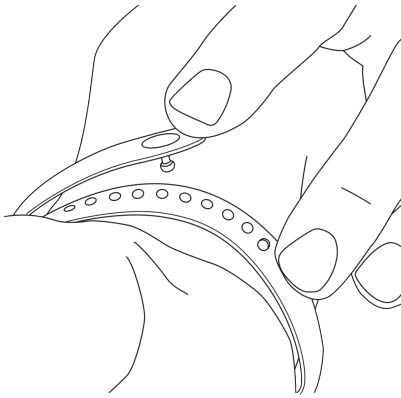

5. Squeeze the peg and band between your thumb and forefinger until you feel the band snap into place. Don't wear your tracker too tightly.

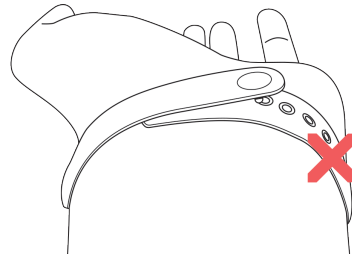
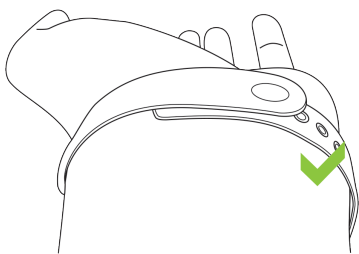
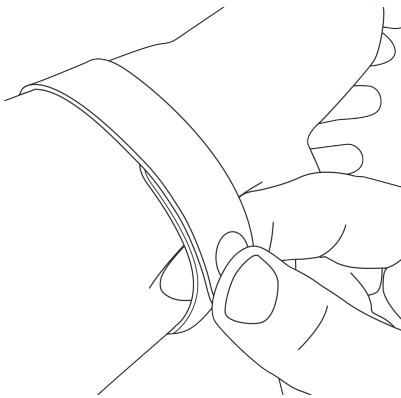

## Handedness

For greater accuracy, you must specify whether you wear Inspire on your dominant or non-dominant hand. Your dominant hand is the one you use for writing and eating. By default, the Wrist setting is set to non-dominant. If you wear Inspire on your dominant hand, change the Wrist setting in the Fitbit app.

From the Today tab  in the Fitbit app, tap your profile picture > Inspire tile > **Wrist > Dominant**

## Wear Inspire in a clip

Wear Inspire clipped to your clothing. Remove the bands, and then place your tracker in the clip. For more information, see "[Change the band](#)" on page 13.

To put Inspire in the clip:

1. If you previously wore Inspire on your wrist, change your device setting to On Clip. For more information, see "[Navigate Inspire](#)" on page 15.
2. Hold the tracker with the screen facing you and the button on the left.
3. Hold the clip with the opening facing you and the button insert on the left.
4. Place the top of the tracker into the clip opening and move the bottom of the tracker into place. Inspire is secure when all edges of the clip lie flat against the tracker.

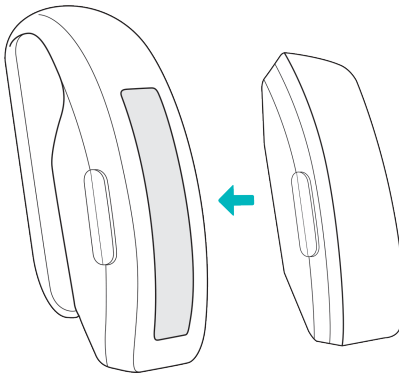

## Clip Placement

Wear Inspire on or close to your body with the screen facing outward. Secure the clip tightly to a shirt pocket, bra, pants pocket, belt, or waistband. Try out a few different locations to see what's most comfortable and secure for you.

If you experience skin irritation when wearing Inspire on your bra or waistband, clip it to an external piece of clothing instead, such as your belt or pocket.

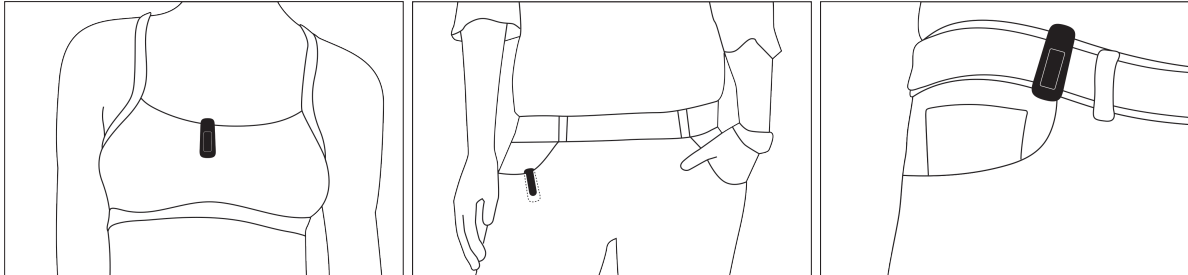

## Change the band

---

Inspire comes with a small band attached and an additional large, bottom band in the box. Both the top and bottom bands can be swapped with accessory bands, sold separately on [fitbit.com](https://www.fitbit.com). For band measurements, see "Band size" on page 33.

### Remove a band

1. Turn over Inspire and find the quick-release lever.
2. While pressing the quick-release lever inward, gently pull the band away from the tracker to release it.

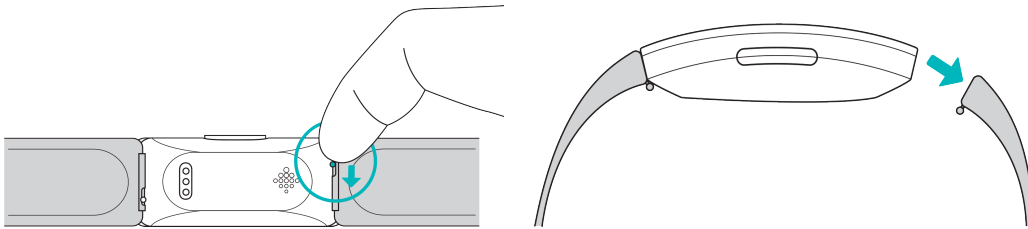

3. Repeat on the other side.

### Attach a band

1. To attach a band, hold the band and slide the pin (the side opposite the quick-release lever) into the notch on the tracker.

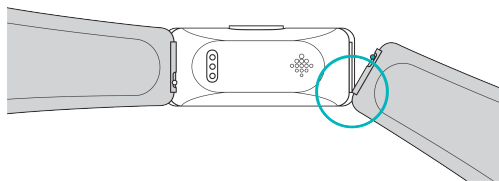

2. While pressing the quick-release lever inward, slide the other end of the band into place.

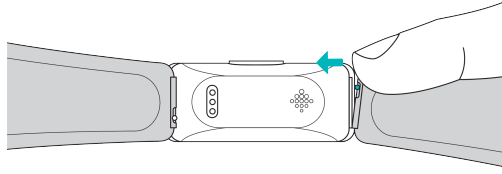

3. When both ends of the pin are inserted, release the quick-release lever.

# Basics

---

Learn how best to navigate, check the battery level, and care for your tracker.

## Navigate Inspire

Inspire has an OLED touchscreen display and 1 button.

Navigate Inspire by tapping the screen, swiping up and down, or pressing the button. To preserve battery, the tracker's screen turns off when not in use.

### Basic navigation

The home screen is the clock.

- Swipe down to scroll through the apps on Inspire. To open an app, swipe to find the app and then tap it.
- Swipe up to see your daily stats.



## Quick settings

Press and hold the button and on Inspire for a faster way to access certain settings. Tap a setting to turn it on or off. When you turn off the setting, the icon appears dim with a line through it.

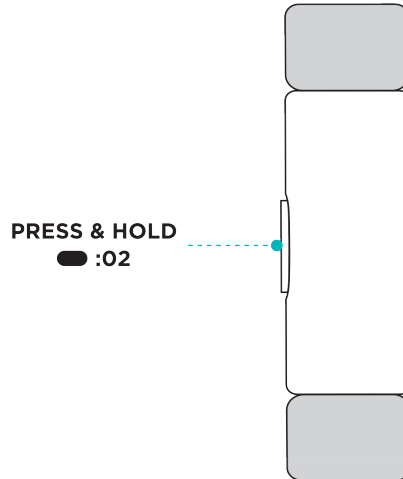

On the quick settings screen:

Battery	Check the battery level.
Screen Wake	When the screen wake setting is on, turn your wrist toward you to turn on the screen.
On Wrist setting	When Inspire is on your wrist, make sure the tracker is set to On Wrist. When Inspire is in the clip, make sure the tracker is set to On Clip.
Notifications	When the notifications setting is on, Inspire displays notifications from your phone when your phone is nearby. For more information, see " <a href="#">Notifications</a> " on page 20.

## Care for Inspire

It's important to clean and dry Inspire regularly. For more information, see [fitbit.com/productcare](https://fitbit.com/productcare).

## Change the clock face

---

1. From the Today tab  in the Fitbit app, tap your profile picture > Inspire tile.
2. Tap **Clock Faces** > **All Clocks**.
3. Browse the available clock faces. Tap a clock face to see a detailed view.
4. Tap **Select** to add the clock face to Inspire.

# Notifications

---

Inspire can show call, text, calendar, and app notifications from your phone to keep you informed. Keep your tracker within 30 feet of your phone to receive notifications. Up to 10 notifications are stored in the Notifications app  on your tracker.

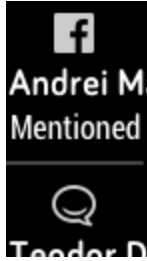

## Set up notifications

Check that Bluetooth on your phone is on and that your phone can receive notifications (often under Settings > Notifications). Then set up notifications:

1. From the Today tab  in the Fitbit app, tap your profile picture > Inspire tile.
2. Tap **Notifications**.
3. Follow the on-screen instructions to pair your tracker if you haven't already. Call, text, and calendar notifications are turned on automatically.
4. To turn on notifications from apps installed on your phone, including Fitbit and WhatsApp, tap **App Notifications** and turn on the notifications you want to see.

Note that if you have an iPhone or iPad, Inspire shows notifications from all calendars synced to the Calendar app. If you have an Android phone, Inspire shows calendar notifications from the calendar app you choose during setup.

For more information, see [help.fitbit.com](https://help.fitbit.com).

## See incoming notifications

When your phone and Inspire are within range, a notification causes the tracker to vibrate.

- Phone calls—the name or number of the caller scrolls once. Press the button to dismiss the notification.
- Text messages—the name of the sender scrolls once above the message. Swipe up to read the full message.
- Calendar alerts—the name of the event scrolls once below the time and location.
- App notifications—the name of the app or sender scrolls once above the message. Swipe up to read the full message.

To read a notification later, swipe down from the clock face, and tap the

Notifications app .

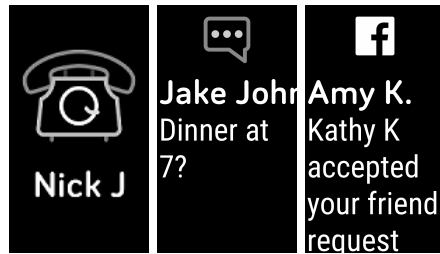

Note: Your tracker shows the first 250 characters of the notification. Check your phone for the full message.

## Turn off notifications

Turn off certain notifications in the Fitbit app, or turn off all notifications in the quick settings on Inspire. When you turn off all notifications, your tracker won't vibrate and the screen won't turn on when your phone receives a notification.

To turn off certain notifications:

1. From the Today tab  in the Fitbit app on your phone, tap your profile picture > Inspire tile > **Notifications**.
2. Turn off the notifications you no longer want to receive on your tracker.
3. Sync your tracker to save your changes.

To turn off all notifications:

1. Press and hold the button on your tracker to reach the quick settings screen.
2. Tap **Notifications** to turn them off.

Note that if you use the do not disturb setting on your phone, you don't receive notifications on your tracker until you turn off this setting.

# Timekeeping

---

Alarms vibrate to wake or alert you at a time you set. Set up to 8 alarms to occur once or on multiple days of the week. You can also time events with the stopwatch or set a countdown timer.

## Set an alarm

Set and delete alarms in the Fitbit app. Turn alarms on or off directly on Inspire in the Alarms app  .

For more information, see [help.fitbit.com](https://help.fitbit.com).

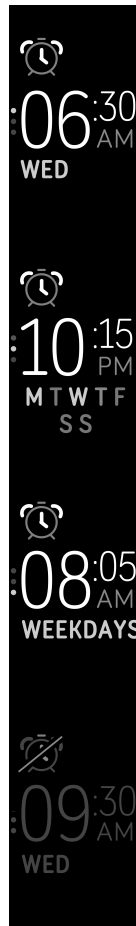

## Dismiss or snooze an alarm

When an alarm goes off, the tracker vibrates. To dismiss the alarm, press the button. To snooze the alarm for 9 minutes, swipe down.

Snooze the alarm as many times as you want. Inspire automatically goes into snooze mode if you ignore the alarm for more than 1 minute.



## Use the Timers app

Time events with the stopwatch or set a countdown timer with the Timers app  on your tracker. You can run the stopwatch and countdown timer at the same time.

For more information, see [help.fitbit.com](https://help.fitbit.com).

# Activity and Sleep

Inspire continuously tracks a variety of stats whenever you wear it. Data automatically syncs when in range of the Fitbit app throughout the day.

## See your stats

Swipe up from the clock face on your tracker to see your daily stats, including:

Core stats	Steps taken today, distance covered, calories burned, and active minutes
Hourly steps	Steps taken this hour, and the number of hours you met your hourly activity goal (tap to switch between these stats)
Cycle track	Information on the current stage of your menstrual cycle, if applicable
Sleep	Duration of your sleep
Water	Water intake logged today
Weight	Current weight, progress toward your weight goal, or where your weight falls within a healthy range if your goal is to maintain your weight

If you set a goal in the Fitbit app, a ring shows your progress toward that goal.



Find your complete history and other information detected by your tracker in the Fitbit app.

For more information, see [help.fitbit.com](https://help.fitbit.com).

## Track a daily activity goal

Inspire tracks your progress toward a daily activity goal of your choice. When you reach your goal, your tracker vibrates and shows a celebration.

### Choose a goal

Set a goal to help you get started on your health and fitness journey. To begin, your goal is to take 10,000 steps per day. Choose to change the number of steps, or pick a different activity goal depending on your device.

For more information, see [help.fitbit.com](http://help.fitbit.com).

Track progress toward your goal on Inspire. For more information, see "[See your stats](#)" on the previous page.

## Track your hourly activity

Inspire helps you stay active throughout the day by keeping track of when you're stationary and reminding you to move.

Reminders nudge you to walk at least 250 steps each hour. You feel a vibration and see a reminder on your screen at 10 minutes before the hour if you haven't walked 250 steps. When you meet the 250-step goal after receiving the reminder, you feel a second vibration and see a congratulatory message.



For more information, see [help.fitbit.com](http://help.fitbit.com).

## Track your exercise automatically

Inspire automatically recognizes and records many high-movement activities which are at least 15 minutes long. Sync your device to see basic stats about your activity in the Exercise tile in the Fitbit app.

For more information, including how to change the minimum duration before an activity is tracked, see [help.fitbit.com](https://help.fitbit.com).

## Track your sleep

Wear Inspire to bed to automatically track your time asleep and movement during the night to help you understand your sleep patterns. Sync your tracker when you wake up and check the Fitbit app to see your sleep stats, including when you go to bed, how long you're asleep, and how long you spend awake or restless.

For more information, see [help.fitbit.com](https://help.fitbit.com).

### Set a sleep goal

To start, you have a sleep goal of 8 hours of sleep per night. Customize this goal to meet your needs.

For more information, see [help.fitbit.com](https://help.fitbit.com).

### Learn about your sleep habits

With a Fitbit Premium subscription, get tips to help you build a better sleep routine and wake up feeling refreshed.

For more information, see [help.fitbit.com](https://help.fitbit.com).

# Update, Restart, and Erase

---

Learn how to update, restart, and erase Inspire.

## Update Inspire

Update your tracker to get the latest feature enhancements and product updates.

When an update is available, a notification appears in the Fitbit app. After you start the update, a progress bar appears on Inspire and in the Fitbit app until the update is complete. Keep your tracker and phone close to each other during the update.

---

Note: Updating Inspire takes several minutes and may be demanding on the battery. We recommend plugging your tracker into the charger before starting the update.

---

For more information, see [help.fitbit.com](https://help.fitbit.com).

## Restart Inspire

If you can't sync Inspire, don't see your stats, or your tracker is unresponsive, restart your device:

1. Connect Inspire to the charging cable. For instructions, see "[Charge your tracker](#)" on page 6.
2. Press and hold the button on your tracker for 5 seconds. Release the button. When you see a smiley face and Inspire vibrates, the tracker restarted.

Restarting your tracker reboots the device but doesn't delete any data.

## Erase Inspire

If you want to give Inspire to another person or wish to return it, first clear your personal data:

1. On Inspire, open the Settings app  > **Clear User Data**.
2. When prompted, press the screen for 3 seconds, then release. When Inspire vibrates and you see the clock screen, your data is erased.

# Troubleshooting

---

If Inspire isn't working properly, see our troubleshooting steps below. Visit [help.fitbit.com](https://help.fitbit.com) for more information.

## Unresponsive device

If you experience any of the following issues, restart your tracker:

- Won't sync
- Won't respond to taps, swipes, or button press
- Won't track steps or other data

For instructions, see "[Restart Inspire](#)" on page 29.

For more information or to contact Customer Support, see [help.fitbit.com](https://help.fitbit.com).

# General Info and Specifications

---

## Sensors

Fitbit Inspire contains a MEMS 3-axis accelerometer, which tracks motion patterns.

## Materials

The housing on Inspire is plastic. The Inspire classic band is made of a flexible, durable elastomer material similar to that used in many sports watches, and the peg is made of anodized aluminum. While anodized aluminum can contain traces of nickel, which can cause an allergic reaction in someone with nickel sensitivity, the amount of nickel in all Fitbit products meets the European Union's stringent Nickel Directive.

## Wireless technology

Inspire contains a Bluetooth 4.0 radio transceiver.

## Haptic feedback

Inspire contains a vibration motor for alarms, goals, notifications, and reminders.

## Battery

Inspire contains a rechargeable lithium-polymer battery.

## Memory

Inspire stores your data, including daily stats, sleep information, and exercise history, for 7 days. Sync your tracker with the Fitbit app to access your historical data.

## Display

Inspire has an OLED display.

## Band size

Band sizes are shown below. Note that accessory bands sold separately may vary slightly.

Small band	Fits a wrist between 5.5 - 7.1 inches (140 mm - 180 mm) in circumference
Large band	Fits a wrist between 7.1 - 8.7 inches (180 mm - 220 mm) in circumference

## Environmental conditions

Operating temperature	14° to 113° F (-10° to 45° C)
Non-operating temperature	-4° to 14° F (-20° to -10° C)  113° to 140°F (45° to 60° C)
Water resistance	Water resistant up to 50 meters
Maximum operating altitude	28,000 feet (8,534 m)

## Learn more

To learn more about your tracker, how to track your progress in the Fitbit app, and how to build healthy habits with Fitbit Premium, visit [help.fitbit.com](https://help.fitbit.com).

## Return policy and warranty

Find warranty information and the fitbit.com return policy on [our website](#).

# Regulatory & Safety Notices

---

Notice to the User: Regulatory content for select regions for FB412 can also be viewed on your device. To view the content: Settings > Device Info.

## USA: Federal Communications Commission (FCC) statement

Model FB412

FCC ID: XRAFB412

Notice to the User: The FCC ID can also be viewed on your device. To view the content:

Settings > Device Info

Unique Identifier: FB412

### Responsible Party – U.S. Contact Information

199 Fremont Street, 14th Floor  
San Francisco, CA  
94105  
United States  
877-623-4997

[www.fitbit.com](http://www.fitbit.com)

### FCC Compliance Statement (for products subject to Part 15)

This device complies with Part 15 of the FCC Rules.

Operation is subject to the following two conditions:

1. This device may not cause harmful interference and
2. This device must accept any interference, including interference that may cause undesired operation of the device.

#### FCC Warning

Changes or modifications not expressly approved by the party responsible for compliance could void the user's authority to operate the equipment.

**Note:** This equipment has been tested and found to comply with the limits for a Class B digital device, pursuant to part 15 of the FCC Rules. These limits are designed to provide reasonable protection against harmful interference in a residential installation. This equipment generates, uses and can radiate radio frequency energy and, if not installed and used in accordance with the instructions, may cause harmful interference to radio communications. However, there is no guarantee that interference will not occur in a particular installation. If this equipment does cause harmful interference to radio or television reception, which can be determined by turning the equipment off and on, the user is encouraged to try to correct the interference by one or more of the following measures:

- Reorient or relocate the receiving antenna.
- Increase the separation between the equipment and receiver.
- Connect the equipment into an outlet on a circuit different from that to which the receiver is connected.
- Consult the dealer or an experienced radio/TV technician for help.

This device meets the FCC and IC requirements for RF exposure in public or uncontrolled environments.

## Canada: Industry Canada (IC) statement

Model/Modèle FB412

IC: 8542A-FB412

**Notice to the User: The IC ID can also be viewed on your device. To view the content:**

**Settings > Device Info**

## Paramètres> Informations sur l'appareil

This device meets the IC requirements for RF exposure in public or uncontrolled environments.

Cet appareil est conforme aux conditions de la IC en matière de RF dans des environnements publics ou incontrôlée

IC Notice to Users English/French in accordance with current issue of RSS GEN:

This device complies with Industry Canada license exempt RSS standard(s).

Operation is subject to the following two conditions:

1. this device may not cause interference, and
2. this device must accept any interference, including interference that may cause undesired operation of the device.

Cet appareil est conforme avec Industrie Canada RSS standard exempts de licence (s). Son utilisation est soumise à Les deux conditions suivantes:

1. cet appareil ne peut pas provoquer d'interférences et
2. cet appareil doit accepter Toute interférence, y compris les interférences qui peuvent causer un mauvais fonctionnement du dispositif

## European Union (EU)

Model FB412

### Simplified EU Declaration of Conformity

Hereby, Fitbit, Inc. declares that the radio equipment type Model FB412 is in compliance with Directive 2014/53/EU. The full text of the EU declaration of conformity is available at the following internet address: [www.fitbit.com/safety](http://www.fitbit.com/safety)

### Vereinfachte EU-Konformitätserklärung

Fitbit, Inc. erklärt hiermit, dass die Funkgerätypen Modell FB412 die Richtlinie 2014/53/EU erfüllen. Der vollständige Wortlaut der EU-Konformitätserklärungen kann unter folgender Internetadresse abgerufen werden: [www.fitbit.com/safety](http://www.fitbit.com/safety)

#### **Declaración UE de Conformidad simplificada**

Por la presente, Fitbit, Inc. declara que el tipo de dispositivo de radio Modelo FB412 cumple con la Directiva 2014/53/UE. El texto completo de la declaración de conformidad de la UE está disponible en la siguiente dirección de Internet: [www.fitbit.com/safety](http://www.fitbit.com/safety)

#### **Déclaration UE de conformité simplifiée**

Fitbit, Inc. déclare par la présente que les modèles d'appareils radio FB412 sont conformes à la Directive 2014/53/UE. Les déclarations UE de conformité sont disponibles dans leur intégralité sur le site suivant : [www.fitbit.com/safety](http://www.fitbit.com/safety)

#### **Dichiarazione di conformità UE semplificata**

Fitbit, Inc. dichiara che il tipo di apparecchiatura radio Modello FB412 è conforme alla Direttiva 2014/53/UE. Il testo completo della dichiarazione di conformità UE è disponibile al seguente indirizzo Internet: [www.fitbit.com/safety](http://www.fitbit.com/safety)



Argentina

Model FB412:

**CNC** COMISIÓN NACIONAL  
DE COMUNICACIONES **C-22555**

## Australia and New Zealand



## China

Regulatory content can also be viewed on your device. To view the content:

**Settings > Device Info**

### **Model FB412:**

Frequency band: 2400-2483.5

Transmitted power: Max EIRP, 6.3dBm

Occupied bandwidth: 2MHz

Modulation system: GFSK

CMIIT ID displayed: On packaging

**CMIT ID: 2018DJ9012**

China RoHS

部件名称 Part Name	有毒和危险品 Toxic and Hazardous Substances or Elements					
Model FB412	铅 (Pb)	水银 (Hg)	镉 (Cd)	六价铬 (Cr(VI))	多溴化苯 (PBB)	多溴化二苯 醚 (PBDE)
表带和表扣 (Strap and Buckle)	○	○	○	○	○	○
电子 (Electronics)	--	○	○	○	○	○
电池 (Battery)	○	○	○	○	○	○
充电线 (Charging Cable)	○	○	○	○	○	○

本表格依据 SJ/T 11364 的规定编制

○ = 表示该有害物质在该部件所有均质材料中的含量均在 GB/T 26572规定的限量要求以下 (indicates that the content of the toxic and hazardous substance in all the Homogeneous Materials of the part is below the concentration limit requirement as described in GB/T 26572).

X = 表示该有害物质至少在该部件的某一均质材料中的含量超出 GB/T 26572规定的限量要求 (indicates that the content of the toxic and hazardous substance in at least one Homogeneous Material of the part exceeds the concentration limit requirement as described in GB/T 26572).



## India

Model FB412

Notice to the User: Regulatory content for this region can also be viewed on your device. To view the content:

**Settings > Device Info**

## Israel

Model FB412

התאמה אישור 55-01198

המוצר של המודולארי בחלק טכני שינוי כל לבצע אין.

## Japan

Model FB412

Notice to the User: Regulatory content for this region can also be viewed on your device. To view the content:

**Settings > Device Info**



201-180693

## Mexico

Model FB412



La operación de este equipo está sujeta a las siguientes dos condiciones:

1. Es posible que este equipo o dispositivo no cause interferencia perjudicial y
2. Este equipo o dispositivo debe aceptar cualquier interferencia, incluyendo la que pueda causar su operación no deseada

## Morocco

Model FB412

AGREE PAR L'ANRT MAROC  
Numéro d'agrément: MR 18210 ANRT 2018  
Date d'agrément: 11/12/2018

## Nigeria

Model Name FB412

Connection and use of this communications equipment is permitted by the Nigerian Communications Commission.

## Oman

Model FB412

D090258  
TRA/TA-R/6790/19

Pakistan

Model No.: FB412

TAC No: 9.6044/2018



**Model: FB412**

**Serial No: Refer to retail box**

**Year of Manufacture: 2018**

Philippines

Model FB412



Serbia

Model FB412



## South Korea

Model FB412

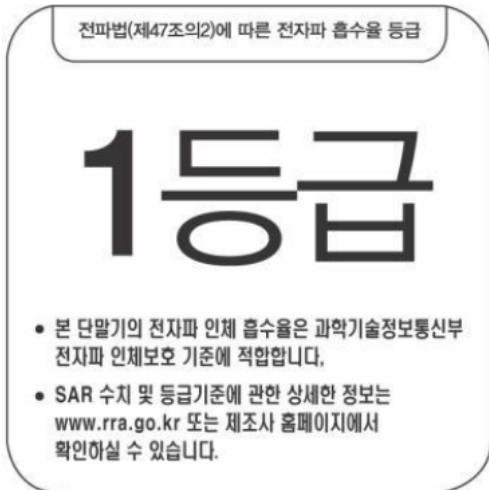

클래스 B 장치 (가정 사용을 위한 방송 통신 기기): EMC 등록 주로 가정용 (B 급)으로하고, 모든 지역에서 사용할 수 있습니다 얻을이 장치.

**" 해당 무선설비는 전파혼신 가능성이 있으므로 인명안전과 관련된 서비스는 할 수 없습니다. "**

## Taiwan

Model FB412



CCAF19LP0010T1

低功率警語:

依據 低功率電波輻射性電機管理辦法

第十二條

經型式認證合格之低功率射頻電機，非經許可，公司、商號或使用者均不得擅自變更頻率、加大功率或變更原設計之特性及功能

第十四條

低功率射頻電機之使用不得影響飛航安全及干擾合法通信；經發現有干擾現象時，應立即停用，並改善至無干擾時方得繼續使用。

前項合法通信，指依電信法規定作業之無線電通信。低功率射頻電機須忍受合法通信或工業、科學及醫療用電波輻射性電機設備之干擾

Translation:

Low power warning:

According to the management method of low power radio wave radiating motor.

Article 12

Low-power RF motors that have passed the type certification are not allowed to change the frequency, increase the power or change the characteristics and functions of the original design without permission.

Article 14

The use of low-power RF motors shall not affect flight safety and interfere with legal communications; if interference is found, it shall be immediately deactivated and improved until no interference is required.

Legal communication in the preceding paragraph refers to radio communications operating in accordance with the provisions of the Telecommunications Act. Low-power RF motors must withstand interference from legitimate communications or radiological electrical equipment for industrial, scientific, and medical use.

使用過度恐傷害視力」

使用30分鐘請休息10分鐘。 2歲以下幼兒不看螢幕，2歲以上每天看螢幕不要超過1小時。

Translation:

“Excessive use may cause damage to vision”

Rest for 10 minutes after every 30 minutes.

Children under 2 years old should stay away from this product. Children 2 years old or more should not see the screen for more than 1 hour.

電池警語：

此裝置使用鋰電池。

若未遵照下列準則，則裝置內的鋰離子電池壽命可能會縮短或有損壞裝置、發生火災、化學品灼傷、電解液洩漏及／或受傷的風險。

Translation:

Battery warning:

This device uses a lithium-ion battery.

If the following guidelines are not followed, the life of the lithium-ion battery in the device may be shortened or there is a risk of damage to the device, fire, chemical burn, electrolyte leakage and / or injury.

## United Arab Emirates

Model FB412

TRA Registered No.: ER68013/18  
Dealer No: 35294/14

Zambia

Model FB412



ZMB / ZICTA / TA / 2019 / 1 / 3

## Safety Statement

This equipment has been tested to comply with safety certification in accordance with the specifications of EN Standard: EN60950-1:2006 + A11:2009 + A1:2010 + A12:2011 + A2:2013 & EN62368-1:2014 + A11:2017.

©2020 Fitbit, Inc. All rights reserved. Fitbit and the Fitbit logo are trademarks or registered trademarks of Fitbit in the US and other countries. A more complete list of Fitbit trademarks can be found at <http://www.fitbit.com/legal/trademark-list>. Third-party trademarks mentioned are the property of their respective owners.