

Haier

HB26FSSAAA
HB26FGSAAA
HB26FSNAAA

GB	Refrigerator - Freezer User Guide
D	Kühlschrank Bedienungsanleitung
F	Réfrigérateur Mode d'emploi
I	Frigorifero Guida per l'utente
E	Frigorífico Manual del usuario
RO	Congelator Manual de utilizare
PL	Lodówka Podręcznik użytkownika
GR	ΨΥΓΕΙΟ ΟΔΗΓΙΕΣ ΧΡΗΣΗΣ
CZ	Chladnička Uživatelská příručka
HU	Hűtőszekrény Felhasználói útmutató
NL	Ijskast De Gids van de gebruiker

GB

D

F

I

E

RO

PL

GR

CZ

HU

NL

Risk of fire/Brandgefahr



WARNING: Risk of fire/flammable material

The symbol indicates there is a risk of fire since flammable materials are used. Take care to avoid causing a fire by igniting flammable material.

WARNUNG: Brandgefahr / brennbares Material

Das Symbol weist auf Brandgefahr hin, da brennbare Materialien verwendet werden. Verhindern Sie die Entstehung von Bränden, die durch entflammbare Materialien verursacht werden.

ATTENTION: Risque d'incendie ou de matières inflammables.

Le symbole montre qu'il y'a le risque de matières inflammables sont utilisés. Prendre soin d'éviter de provoquer un incendie en ignorant des matières inflammables.

ATTENZIONE: Rischio di incendio/materiale infiammabile

Il simbolo indica il rischio di incendio nel caso di utilizzo di materiali infiammabili. Fare attenzione ed evitare l'insorgere di incendi a causa della combustione di materiali infiammabili.

ADVERTENCIA : Riesgo de incendio o material inflamable.

El símbolo indica que existe riesgo de incendio, dado que se utilizan materiales inflamables. Se debe procurar evitar incendios mediante la combustión de materiales inflamables.

WAARSCHUWING: Brandrisico/brandbaar materiaal

Het systeem geeft aan dat er een brandrisico bestaat aangezien brandbaar materiaal wordt gebruikt. Zorg ervoor dat er geen brand wordt veroorzaakt door brandbaar materiaal te ontsteken.

OSTRZEŻENIE: Ryzyko pożaru/materiał łatwopalny

Symbol wskazuje, że istnieje ryzyko pożaru, ponieważ używane są materiały łatwopalne. Dbaj o to, aby uniknąć pożaru poprzez zapale nie łatwopalnego materiału.

AVERTISMENT: Risc de incendiu/material inflamabil

Simbolul indică că există risc de incendiu deoarece sunt folosite materiale inflamabile. Aveți grijă și evitați incendiile aprinzând materiale inflamabile.

VAROVÁNÍ: Nebezpečí Požáru / Hořlavého Materiálu

Symbol označuje riziko požáru, protože byly použity hořlavé materiály. Dbejte na to, aby nedošlo ke vzniku požáru zapálením hořlavého materiálu.

FIGYELEM: Tűz / gyúlékony anyag veszélye

A szimbólum azt jelzi, hogy tűzveszély áll fenn, mivel gyúlékony anyagokat használnak. Ügyeljen arra, hogy ne tegyen rá tűzveszélyes gyúlékony anyagot.

ΠΡΟΣΟΧΗ : Κίνδυνος φωτιάς/εύφλεκτο υλικό

Το σύμβολο υποδεικνύει ότι υπάρχει κίνδυνος φωτιάς επειδή χρησιμοποιούνται εύφλεκτα υλικά.

Προσέχετε να αποφεύγετε την πρόκληση φωτιάς από ανάφλεξη εύφλεκτου υλικού.

Haier

HB26FSSAAA
HB26FGSAAA
HB26FSNAAA

GB	Refrigerator - Freezer User Guide
D	Kühlschrank Bedienungsanleitung
F	Réfrigérateur Mode d'emploi
I	Frigorifero Guida per l'utente
E	Frigorífico Manual del usuario
RO	Congelator Manual de utilizare
PL	Lodówka Podręcznik użytkownika
GR	ΨΥΓΕΙΟ ΟΔΗΓΙΕΣ ΧΡΗΣΗΣ
CZ	Chladnička Uživatelská příručka
HU	Hűtőszekrény Felhasználói útmutató
NL	Ijskast De Gids van de gebruiker

GB

D

F

I

E

RO

PL

GR

CZ

HU

NL

Household Refrigerator - Freezer Manual

- Please read the Manual carefully before use.
- Please properly save this Manual for future reference.

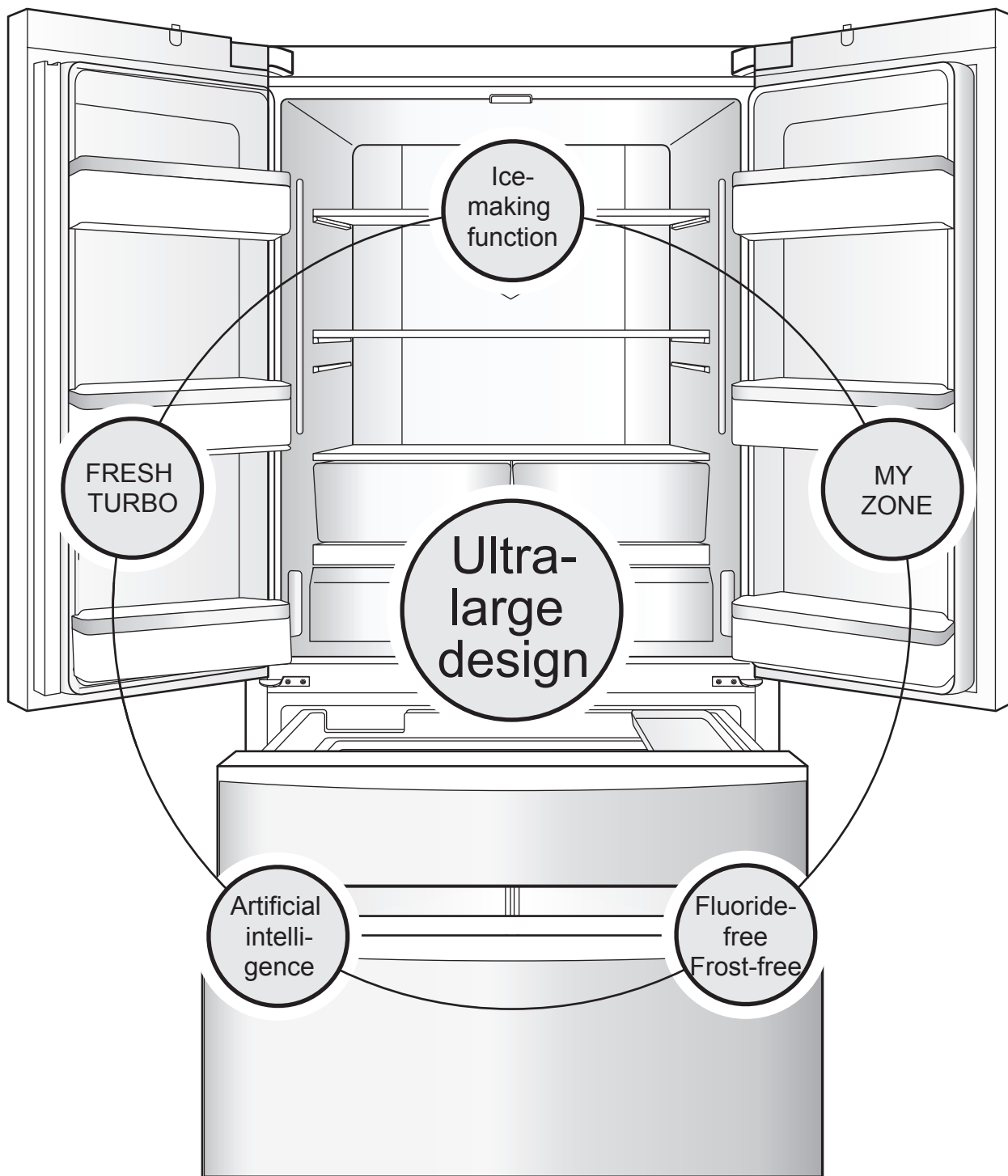

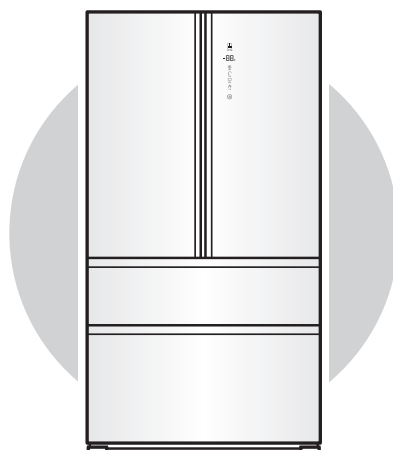

Ice-making function

Equipped with a built-in automatic icemaker which makes ice cubes according to your preferences.

Full fan-cooled dual cooling system

Compressor and condenser, heat dissipating fan, good cooling effect, energy saving and environmentally friendly, as well as reliable quality.

Defrosting and pre-cooling

Determine the temperature inside the appliance prior to defrosting it, and pre-cool it so that the pre-defrosting and post-defrosting temperatures inside the refrigeration do not markedly change by a wide margin, this helps to maintain food freshness.

Artificial intelligenc

No user is required, the appliance is automatically regulated to achieve the optimum refrigeration effect in accordance with the appliance's internal temperatures and environmental temperature conditions.

Ultra-large and super-luxurious design

Ultra-large capacity, large refrigerator and large freezer. Luxuriously designed interior and exterior.

*The utmost in storing freshness from all the corners of the world
– taste the varied sensations of different latitudes*

TASTE FRESHNESS

In order to precisely realize your style of living, Haier has bestowed each of its product categories for households with exclusive state of the mind concepts. What this product brings to you is taste freshness.

HB26FSSAAA is a French style side-by-side door household Refrigerator - Freezer.

Please read this Manual carefully to help you use this product safely and comfortably.

For safe use of this product, please read the Safety Instructions carefully before use of the product.

Full width LED backlighting

Stable bright light source, interior illumination without any dead spaces.

MY ZONE

Independent and accurate temperature controls, and a broad temperature range to maintain a biological freshness zone.

Full width rack

Full width rack design, more convenient for storing and taking out foods.

LED display

Open-door alarm, touch buttons, and hidden LED display.

FRESH TURBO

Three-dimensional freshness keeping technology is applied, which can prolong the time that fruits and vegetables are kept fresh.

Contents

Safety instructions	4	Usages and precautions for the refrigeration compartments	18
Preparation procedures before using this product	9	Recommended storage zones for various foods	18
Names of the components for the assemblies of this product	10	MY ZONE drawer usage	18
Pre-use preparation procedures for this product	11	Refrigerated food precautions	19
Instructions for the major functions of this product	12	Usages and precautions for the freezer compartments	20
Control panel	12	Frozen food precautions	20
1. Refrigerator temperature setting	13	Refrigerator Usage Tips	21
2. Freezer temperature setting	13	Precautions for energy-saving usage	21
3. Function settings and deactivation of MY ZONE	13	Water Supply Connection	21
4. Quick-freeze function setting	14	Fitting the Water Filter	21
5. Artificial intelligence function setting	14	Cleaning and usage of the icemaker	22
6. Icemaker on and off function setting	15	Cleaning the ice cube tray	22
7. Holiday function setting	15	Icemaker usage precautions	22
8. Lock / unlock function setting	16	Daily maintenance of this product	23
9. Door-open alarm function	16	Cleaning of the appliance	23
10. Outage memory function	16	Disassembling and cleaning the parts	23
11. If storage space needs to be increased	17	Transporting the appliance	26
		Appliance usage disruptions	26
		Water filter	26
		Do you have any questions? First look here!	27
		(If you have questions about the appliance, first check the contents of this chapter to deal with them.)	
		Product Fiche (according EU 1060/2010)	30

Safety instructions

Safety



WARNING!

Before first use

- Make sure there is no transport damage.
- Remove all packaging and keep out of children's reach.
- Wait at least two hours before installing the appliance in order to ensure the refrigerant circuit is fully efficient.
- Handle the appliance always with at least two persons because it is heavy.



WARNING!

Installation

The appliance should be placed in a well-ventilated place. Ensure a space of at least 10 cm above and around the appliance.

WARNING: Keep ventilation openings, in the appliance or in the in-built structure clear of obstruction.

- Never place the appliance in a damp area or location where it might be splashed with water.
- Clean and dry water splashes and stains with a soft clean cloth.
- Do not install the appliance in direct sunlight or in the near of heat sources (e.g. stoves, heaters). Install and level the appliance in an area suitable for its size and use.
- Make sure that the electrical information on the rating plate agrees with the power supply. If it does not, contact an electrician.
- The appliance is operated by a 220-240 VAC/50 Hz power supply. Abnormal voltage fluctuation may cause the appliance to fail to start, or damage to the temperature control or compressor, or there may be an abnormal noise when operating. In such case, an automatic regulator shall be mounted.
- Do not use multi-plug adapters and extension cables.
- **WARNING:** Do not locate multiple portable socket-outlets or portable power supplies at the rear of the appliance.
- **WARNING:** When positioning the appliance, ensure the supply cord is not trapped or damaged. Do not step on the power cable.

- Use a separate earthed socket for the power supply which is easy accessible. The appliance must be earthed.
 - Only for UK: The appliance's power cable is fitted with 3-cord (grounding) plug that fits a standard 3-cord (grounded) socket.
 - Never cut off or dismount the third pin (grounding). After the appliance is installed, the plug should be accessible.
- WARNING:** Do not damage the refrigerant circuit.



WARNING!

Daily use

- This appliance can be used by children aged from 8 years and above and persons with reduced physical, sensory or mental capabilities or lack of experience and knowledge if they have been given supervision or instruction concerning use of the appliance in a safe way and understand the hazards involved.
- Children shall not play with the appliance. Cleaning and user maintenance shall not be made by children without supervision.
- Children aged from 3 to 8 years are allowed to load and unload refrigerating appliances.
- Keep away children under 3 years of age from the appliance unless they are constantly supervised. If coal gas or other inflammable gas is leaking in the vicinity of the appliance, turn off the valve of the leaking gas, open the doors and windows and do not unplug a plug in the power cable of the refrigerator or any other appliance.
- Notice that the appliance is set for operation at a specific ambient range between 10 and 43°C. Chest freezer is suitable for use in unheated rooms and out building no less than -12°C. The appliance may not work properly if it is left for a long period at a temperature above or below the indicated range. Do not place unstable articles (heavy objects, containers filled with water) on top of the refrigerator, to avoid personal injury caused by falling or electric shock caused by contact with water.

 **WARNING!**

- Do not pull on the door shelves. The door may be pulled slant, the bottle rack, may be pulled away, or the appliance may topple.
- Open and close the doors only with the handles. The gap between the doors and between the doors and the cabinet is very narrow. Do not extend your hands in these areas to avoid pinching your fingers. Open or close the refrigerator doors only when there are no children standing within the range of door movement.
- Never store bottled beer or beverages in the freezer, as these will burst during freezing.
- Do not store explosive substances such as aerosol cans with a flammable propellant in this appliance.
- Do not store medicines, bacteria or chemical agents in the appliance. This appliance is a household appliance. It is not recommended to store materials that require strict temperatures.
- Check the condition of food if a warning in the freezer has taken place.
Do not set unnecessarily low temperature in the refrigerator compartment. Minus temperatures may occur at high settings.
Attention: Bottles can burst.
- Do not touch frozen goods with wet hands (wear gloves). Especially do not eat ice lollies immediately after removal from the freezer compartment. There is the risk to freeze or the formation of frost blisters. **FIRST aid:** keep immediately under running cold water. Do not pull away!
- Do not touch the inside surface of the freezer storage compartment when in operation, especially with wet hands, as your hands may freeze onto the surface.

- Unplug the appliance in event of a power interruption or before cleaning. Allow at least 7 minutes before restarting the appliance, as frequent starting may damage the compressor.
- Do not use electrical devices inside the food storage compartments of the appliance, unless they are of the type recommended by the manufacturer.

 **WARNING!**
Maintenance / cleaning

- Make sure children are supervised if they carry out cleaning and maintenance.
- Disconnect the appliance from the electrical supply before undertaking any routine maintenance. Allow at least 7 minutes before restarting the appliance, as frequent starting may damage the compressor.
- Hold the plug, not the cable, when unplugging the appliance.
- Do not clean the appliance with hard brushes, wire brushes, de-tergent powder, petrol, amyl acetate, acetone and similar organic solutions, acid or alkaline solutions. Please clean with special refrigerator/freezer detergent to avoid damage. Eventually use warm water and baking soda solution - about a tablespoon of baking soda to a liter/quart of water. Rinse thoroughly with water and wipe dry. Do not use cleaning powders or other abrasive cleaners. Do not wash removable parts in a dishwasher.
- Do not scrape off frost and ice with sharp objects. Do not use prays, electric heaters like heater, hair dryer, steam cleaners or other sources of heat in order to avoid damage to the plastic parts
- **WARNING:** Do not use mechanical devices or other means to accelerate the defrosting process, other than those recommended by the manufacturer.

 **WARNING!**

- If the supply cord is damaged, it must be replaced by the manufacturer, its service agent or similarly qualified persons in order to avoid a hazard.
- Do not try to repair, disassemble or modify the appliance by your-self. In case of repair please contact our customer service.
- If the illuminating lamps are damaged, it must be replaced by the manufacturer, its service agent or similarly qualified persons in order to avoid a hazard.
- Eliminate the dust on the back of the unit at least once in the year to avoid hazard by fire, as well as increased energy consumption.
- Do not spray or flush the appliance during cleaning.
- Do not use water spray or steam to clean the appliance.
- Do not clean the cold glass shelves with hot water. Sudden temperature change may cause the glass to break.
- If you leave your appliance out of use for an extended period, leave it open to prevent odour and unpleasant smells building up inside.

Refrigerant gas information

 **WARNING!**

The appliance contains the flammable refrigerant ISOBUTANE (R600a). Make sure the refrigerant circuit is not damaged during transportation or installation. Leaking refrigerant may cause eye injuries or ignite. If a damage has occurred, keep away open fire sources, thoroughly ventilate the room, do not plug or unplug the power cords of the appliance or any other appliance. Inform the customer service. In case of eyes get into contact with the refrigerant, rinse immediately it under running water and call immediately the eye specialist.

WARNING: The refrigeration system is under high pressure. Do not tamper with it. Since the flammable refrigerants are used, please installed, handle, and service the appliance strictly according to the instruction and contact the professional agent or our after-sale service to dispose of the appliance.

 **WARNING!**

Intended use

For good maintenance and to avoid unpleasant odors, the device should be cleaned at least every four weeks. Always keep the door seal clean.

This appliance is intended to be used in household and similar applications such as

- staff kitchen areas in shops, offices and other working environments;
 - farm houses and by clients in hotels, motels and other residential type environments;
 - bed and breakfast type environments;
 - catering and similar non-retail applications.
- If the appliance is not used for an extended period of time, and you will not only use the Holiday-function or the fridge off function for the refrigerator;

- Take out the food.
- Unplug the power cord.
- Empty and clean the watertank.
- Clean the appliance as described above.
- Keep the doors open to prevent the creation of bad odours inside. To ensure the safe preservation of foodstuffs, please comply with this instruction to use.
- To avoid contamination of food, please respect the following instructions:

-
- Opening the door for long periods can cause a significant increase of the temperature in the compartments of the appliance.
 - Clean regularly surfaces that can come in contact with food and accessible drainage systems.
 - Store raw meat and fish in suitable containers in the refrigerator, so that it is not in contact with or drip onto other food.
 - If the refrigerating appliance is left empty for long periods, switch off, defrost, clean, dry, and leave the door open to prevent mould developing within the appliance.
- WARNING:** Connect to potable water supply only.
- If need clean the ice-maker and the accessory, please contact Haier service.

Correct Disposal of This Product



This marking on the product, accessories or literature indicates that the product and its electronic accessories (e.g. charger, headset, USB cable) should not be disposed of with other household waste at the end of their working life. To prevent possible harm to the environment or human health from uncontrolled waste disposal, please separate these items from other types of waste and recycle them responsibly to promote the sustainable reuse of material resources. Household users should contact either the retailer where they purchased this product, or their local government office for details of where and how they can take these items for environmentally safe recycling. Business users should contact their supplier and check the terms and conditions of the purchase contract. This product and its electronic accessories should not be mixed with other commercial wastes for disposal. When replacing old appliances with new ones, the retailer is legally obligated to take back your old appliance for disposals at least free of charge. Disconnect the appliance from the main supply. Cut off the power cord and dismantle the door/s and seals to prevent children and pets being trapped inside the appliance.



WARNING!

Risk of injury or suffocation

Refrigerants and gases must be disposed of professionally. Ensure that the tubing of the refrigerant circuit is not damaged before being properly disposed of. Disconnect the appliance from the mains supply. Cut off the mains cable and dispose of it. Remove the trays and drawers as well as the door catch and seals to prevent children and pets to get closed in the appliance.

Preparation procedures before using this product

1 Remove all packaging components

The foam base and adhesive tape for holding the accessories must also be removed.

The 2 packing wedges below each door must be removed before using the appliance. The packing wedges are only used to protect the appliance during transportation.

2 Count attached accessories and data

Please check articles in the package according to the details of the packing list. If there are discrepancies, please consult a salesperson.

3 Place the appliance in the place where the following conditions are met:

- The space surrounding the appliance should include a space of 10 cm or more in the rear.
- The appliance should be placed on flat solid ground. If packing is needed, a smooth, hard and non-flammable pad should be selected. If it is a little unstable, adjust the black adjustable feet at the front of the appliance:
 - Rotate clockwise to increase the height of the appliance.
 - Rotate counterclockwise to reduce the height of the appliance.

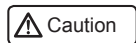

To prevent the appliance from rolling forward during use, please adjust the adjustable feet so that they are in full contact with the ground in order to secure the appliance's position. Do not use the packing foam base for the appliance to pad the appliance.

4 Clean before use

(For cleaning method, see "Cleaning of the appliance" on page 21, "Cleaning the water reservoir assembly" on page 19 and "Cleaning the ice cube tray" on page 20.)

5 Standing

After placing, leveling and cleaning of the appliance, do not switch on. Leave the appliance stand for 5 hours or more, then switch on the appliance with the power plug to ensure the normal operation of the appliance.

6 Peel off the film

Before use, please peel off the transparent films on the side panel so as not to affect the normal cooling and power consumption of the appliance.

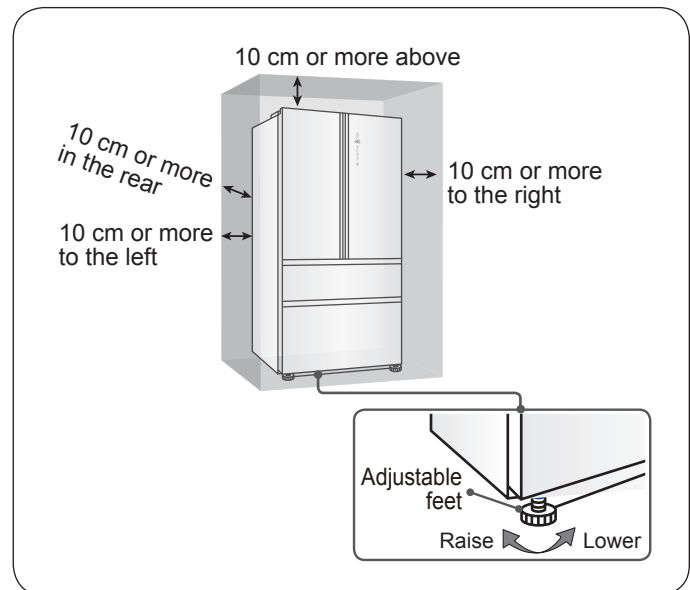
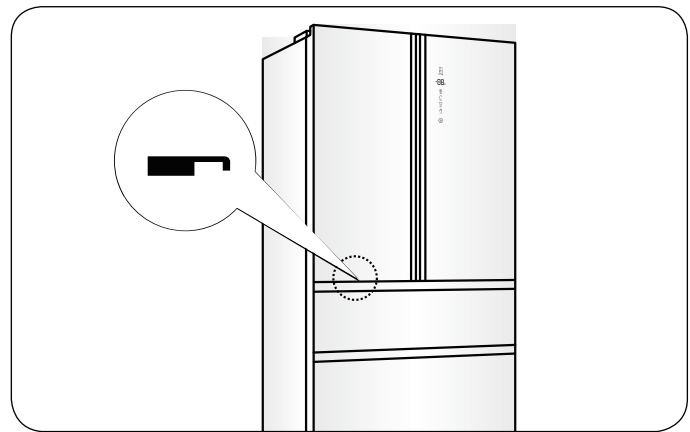

Names of the components for the assemblies of this product

GB

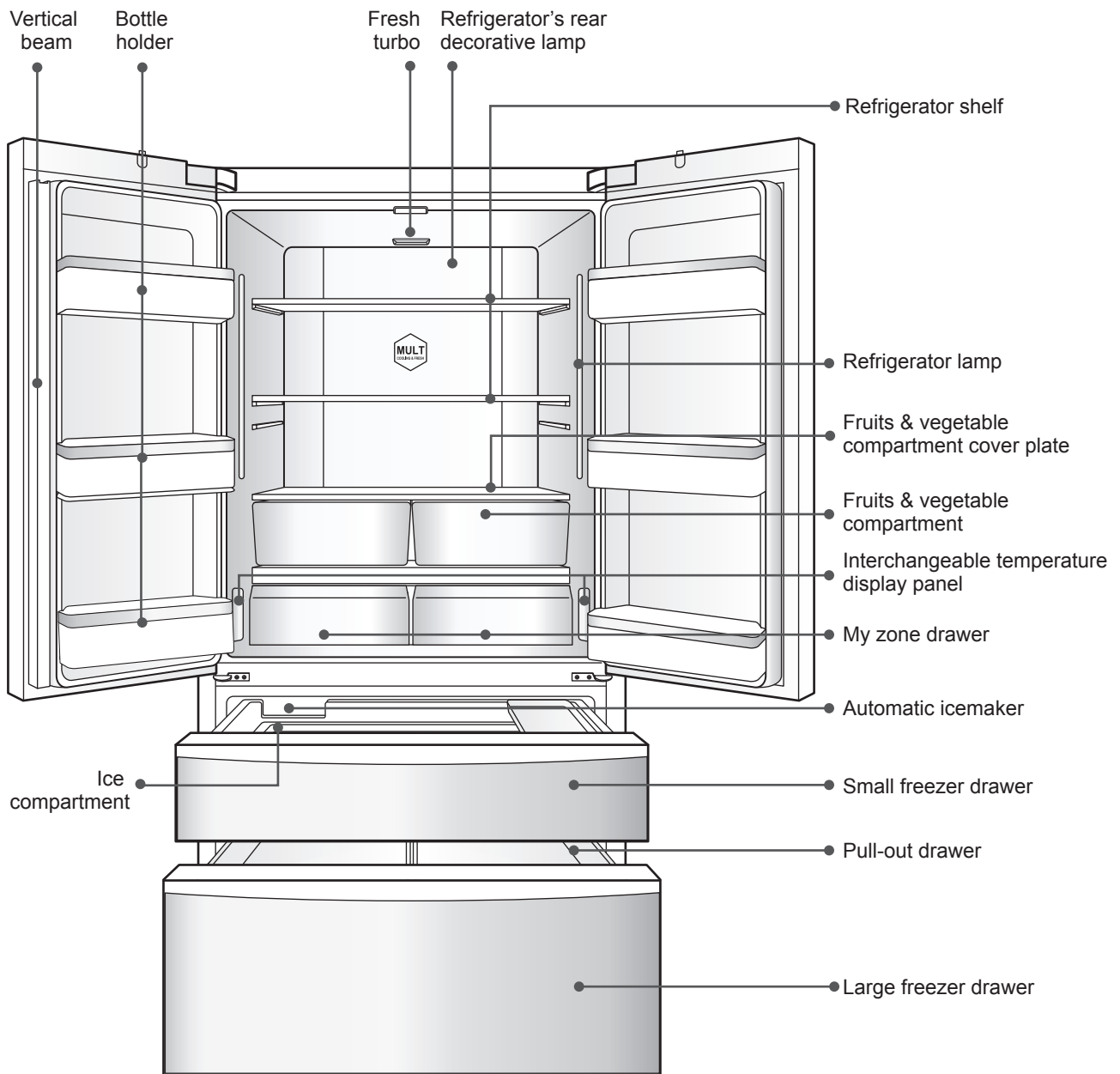

Tip:

If the temperature setting is changed, the inside temperature can achieve a balance over a period of time. In addition, the length of time depends on the temperature setting change, the ambient temperature, the door opening frequency, and the amount of stored foods in the appliance, etc.

Pre-use preparation procedures for this product

1 Power on

When the power is on, the temperature is of the actual refrigerating temperature and freezing temperature. At this moment, the refrigerating temperature is set at 5 °C, the freezing temperature is set at -18 °C, and the button is unlocked.

2 The appliance has a power-off memory function

After switching on for the first time, the machine will run according to the last power-off setting.
(See “Outage memory function” on page 14 for details).

3 Select the working mode for the appliance

You may need to select one of the following two ways to set the appliance:

Artificial intelligence mode

Under artificial intelligence mode, the inner appliance can be automatically adjusted at a temperature for food storage. If you do not have any special requirements, we recommend that you use artificial intelligence mode.

(For specific setting methods, refer to “Artificial intelligence function setting” on page 12).

Manual adjusting mode:

If you want to manually adjust the temperature of the appliance in order to store a particular food, you can set the temperature via a temperature adjusting button.

(For specific setting methods, refer to “Appliance temperature setting” and “Freezer temperature setting” on page 11).

4 Put the food into the appliance

After a period of power operation, the appliance has cooled down sufficiently, you can officially put food in and use it. If there are lots of fresh foods (such as meat) to be placed into the freezing chamber, the user should turn on the “quick-freeze” function 12 hours before putting the food inside.

5 Turn off

Empty the appliance before turning off.

To turn the appliances off, please pull the power cable out of the power socket.

Instructions for the major functions of this product

GB

Control panel

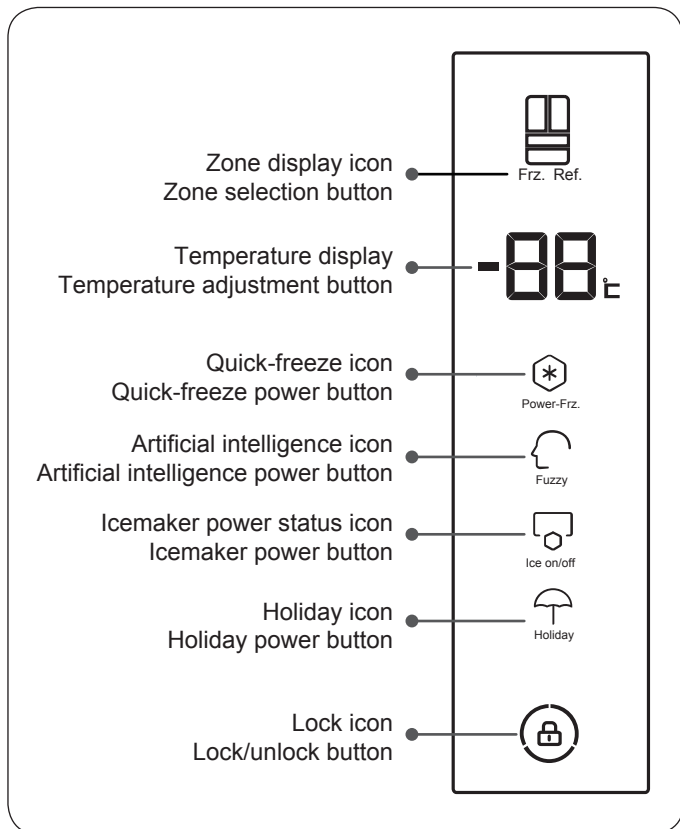

Artificial Intelligence icon: Activates or deactivates intelligent function;
Artificial Intelligence power button:

Icemaker power status icon: Activates or deactivates icemaker function;
Icemaker power button:

Holiday icon: Activates or deactivates holiday function;
Holiday power button:

Lock icon: Lock or unlock of the control panel
Lock/unlock button:

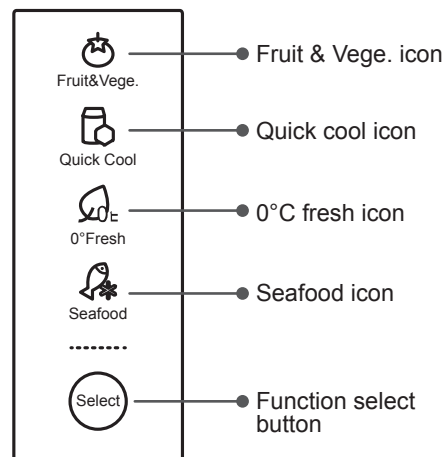

MY ZONE control panel:

Zone display icon: When "Frz." is lit, the currently selected temperature zone and freezer temperature zone are displayed; When "Ref." is lit, the currently selected temperature zone and refrigerator temperature zone are displayed;

Zone selection button: Switch between the refrigerator temperature zone and the freezer temperature zone;

Temperature display: Show the temperature of the refrigerator temperature zone or the freezer temperature zone;

Temperature adjustment button: Adjust the temperature of the refrigerator temperature zone or the freezer temperature zone. Slide slightly upward, the temperature will increase by 1°C; When sliding downward or clicking the temperature adjustment button, the temperature will decrease by 1°C;

Quick-freeze icon: Activates or deactivates quick-freeze function;
Quick-freeze power button:

Select button: Click the button, and cycle in sequence. Select "Fruit & Vege.", "Quick Cool", "0°C Fresh", "Seafood" functions.

Sensor buttons: The keys on the control panel are sensor keys that respond even when lightly touched by the finger.

Standby mode: The display will automatically turn off 30 seconds after a key is pressed. It lights up when a key is pressed or the door is opened (the display does not light up in the event of an alarm).

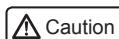

The display lights up automatically when opening the door, and it lights up until 7 minutes unless you close the door.

1 Refrigerator temperature setting

1. Under an unlocked state, click on the "Frz.Ref." button, and select the zone of the refrigerator.
2. The display shows the refrigeration compartment's original set temperature.
3. Click on the display. The setting temperature will decrease by 1°C for each click. In addition, you can also slide the temperature display upward or downward. Slide upwards to increase the temperature setting by 1°C. Slide downwards to decrease the temperature setting by 1°C.

The temperature can be set from 1 °C to 7 °C. The optimal cooling temperature in the cooling area is 5 °C.

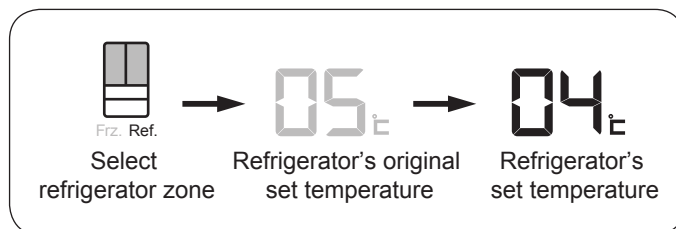

2 Freezer temperature setting

1. Under an unlocked state, click on the "Frz.Ref." button, and select the freezer zone.
2. The display shows the freezer compartment's original set temperature.
3. Click on the temperature display. The setting temperature will decrease by 1°C for each click. In addition, you can also slide the temperature display upward or downward. Slide upwards to increase the temperature setting by 1°C. Slide downwards to decrease the temperature setting by 1°C.

The temperature can be set from -15 °C to -23 °C. The optimum temperature in the freezing area is -18 °C.

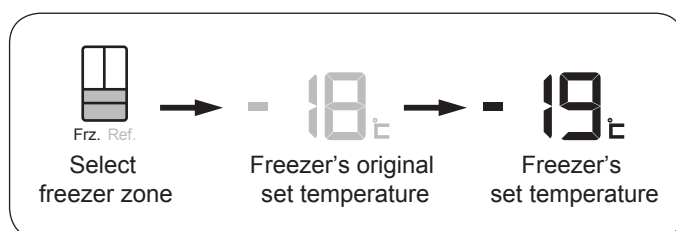

3 Function settings and deactivation of MY ZONE

You can select the appropriate function according to the food stored in MY ZONE, so as to be able to better maintain the nutritional value of the food.

1. Press the "Select" button. The "Fruit & Vege.", "Quick cool", "0 fresh" and "Seafood" icons light up and rotate in sequence from top to bottom. Press repeatedly button "Select" until the desired function flashes. The corresponding function is activated.
2. Press the left and right "Select" buttons simultaneously for 3 seconds, all of the MY ZONE icons go out, and MY ZONE is deactivated.
3. Press any "Select" button for 3 seconds to activate MY ZONE. Activate after positioned in "Fruit & Vege." status.

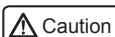
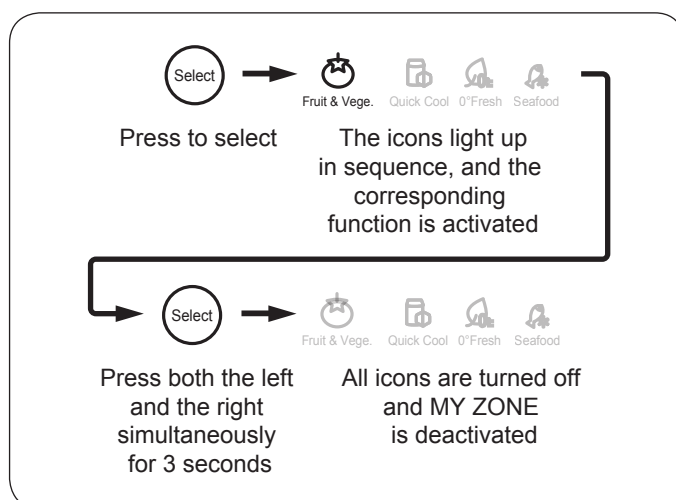

After deactivating, MY ZONE can be used as a refrigeration compartment.

4 Quick-freeze function setting

Fresh food should be frozen as quickly as possible to the core. This preserved the best nutritional value, appearance and taste. The quick-freeze function accelerates the freezing of fresh food and protects the goods already stored from undesirable warming. Activate the function 24 hours before inserting the food.

1. Under a non-lock state, press "Power-Frz." button.
2. Turn on the quick-freeze icon to access to the quick-freezing function.
3. If you want to exit from the quick-freezing function, please press the "Power-Frz." button under the non-lock state.
4. Turn off the quick-freezing icon, and then exit from the quick-freezing function.

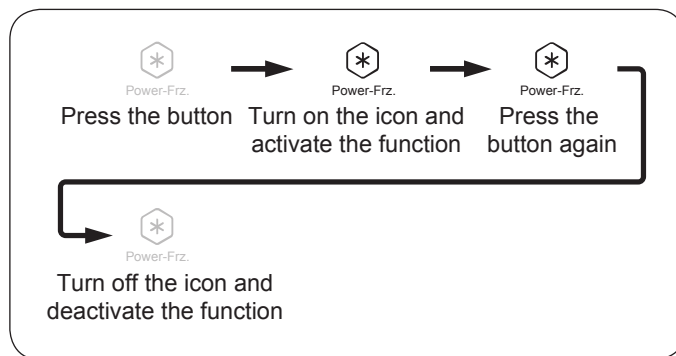

The quick - freeze function will automatically self cancel after put in the correct time when the function will be automatically shut off hours as required by EU law. When the time has elapsed, you may re-select quick freeze function.

5 Artificial intelligence function settin

Under the artificia intelligence state, the refrigerator will automatically adjust the temperature setting according to the ambient temperature and temperature change in the refrigerator.

1. Under an unlocked state, press the "Fuzzy" button.
2. When the intelligence icon flashes the function is activated.
3. For deactivating the intelligence function press again the "Fuzzy" button.
The icon turns off and the function is deactivated.

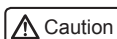
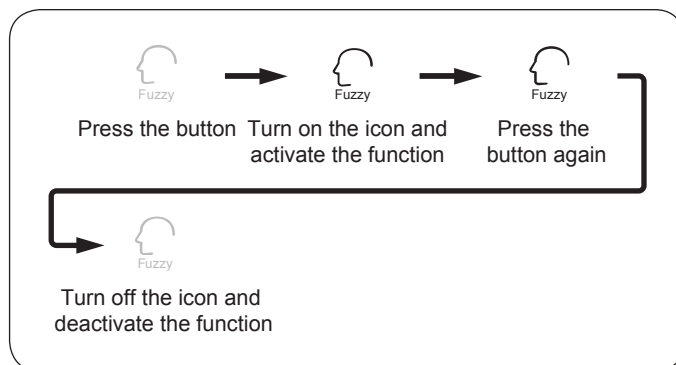

Under the artificia intelligence state, you can not adjust the refrigerating temperature;

Under the artificia intelligence, freezing and quick-freezing states, you cannot adjust the freezing temperature;

Under the holiday function state, the interchangeable temperature is deactivated.

Under the artificia intelligence state and when selecting the quickfreeze function, the artificia intelligence function is automatically exited from;

Under the quick-freezing state and when selecting artificia intelligence function, the quick-freeze function is automatically exited from.

6 Icemaker on and off function setting

When initially powering up, the icemaker is in a deactivated state, the "Ice on/off" is not lit.

1. When the icemaker function is required, under an unlocked state, press the "Ice on/off" button.
2. When the icemaker icon comes on, the ice making function is on.
3. If you want to exit from the ice making function, please press the "Ice on/off" button under an unlocked state.
4. When the icemaker icon goes out, the ice making function is off.

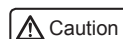

Please note the ice maker will not function until the freezer has reached a temperature of -12 °C or below.

See "Ice maker usage precautions" section of this manual

If you need to change it, please contact after sales service personnel.

7 Holiday function setting

After activating the holiday function, the freezer compartment of the refrigerator operates normally, and the refrigerator compartment is automatically set at 17 °C.

When the ambient temperature is below 17 °C, the refrigerating temperature is close to the ambient temperature.

1. Under an unlocked state, press the "Holiday" button.
2. When the "Holiday" flashes the function is activated.
3. If you want to exit from the holiday function, please press the "Holiday" button under an unlocked state.
4. The icon turns off and the function is deactivated.



During the holiday mode is in operation: no food may be stored in the refrigerator. The set temperature of +17 °C is too warm for food.

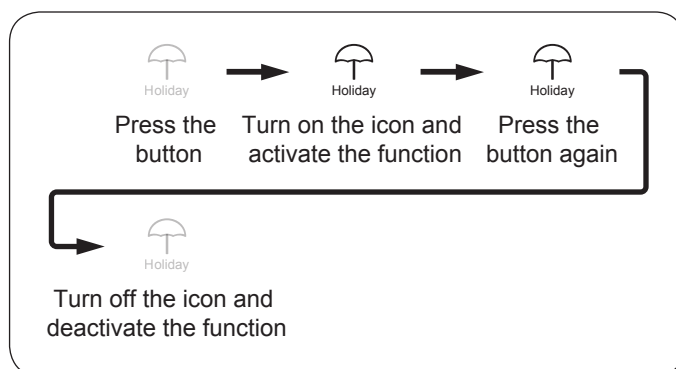
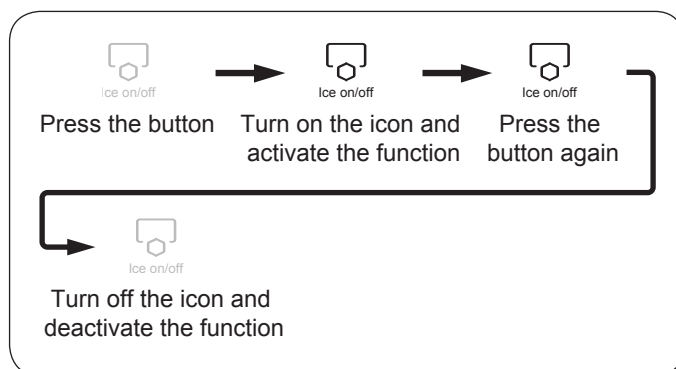

8 Lock / unlock function setting

1. For locking press "Lock/Unlock Button" for 2 seconds.
2. The locking icon flashes and the display is locked.
3. For unlocking press "Lock / Unlock Button" for 3 seconds.
4. The lock icon is off, and the button unlocks.
5. After 30 seconds of non-operation of the button, it automatically locks.

Under a locked state, no setting is possible.

9 Open-door alarm function

When any door or freezer drawer is left open for more than 60 seconds or the door is not closed properly, the appliance will sound the door open alarm at intervals to remind you to close the doors or freezer drawers.

10 Outage memory function

When the appliance has a failure or power outage, or is unplugged from the power supply, the operating state that the appliance was in at the moment the power was interrupted is memorized, and after the power is restored, the appliance will still continue to function in accordance with the setting configuration and functions which were set prior to the power outage.

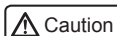

Caution

Locked functions are not memorized, after the appliance is powered up they are in an unlocked state.

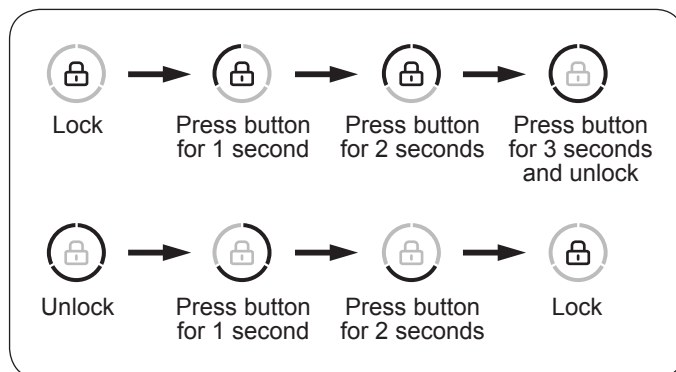

11 If storage space needs to be increased

Users can remove parts of the appliance to achieve the purpose of increasing the storage space of the appliance.

The following is a list of detachable parts. The detachable parts are as shown in the right figure
For detailed disassembly methods, please see "Disassembling and cleaning the parts" on page 21.

Number Name of part

- ① Bottle holder (upper left)
- ② Bottle holder (middle left)
- ③ Bottle holder (lower left)
- ④ Bottle holder (upper right)
- ⑤ Bottle holder (middle right)
- ⑥ Bottle holder (lower right)
- ⑦ Shelf (upper)
- ⑧ Shelf (lower)
- ⑨ Fruit & Vege box cover plate
- ⑩ Fruit & Vege box (left)
- ⑪ Fruit & Vege box (right)
- ⑫ MY ZONE (left)
- ⑬ MY ZONE (right)
- ⑭ Fruit & Vege compartment tray
- ⑮ MY ZONE
- ⑯ Automatic icemaker
- ⑰ Small freezer drawer
- ⑱ Small freezer drawer tray
- ⑲ Pull-out box (left)
- ⑳ Pull-out box (right)
- ㉑ Pull-out tray
- ㉒ Gear connecting rod

- Detachable part
- ⊙ Detachable part (concealed)

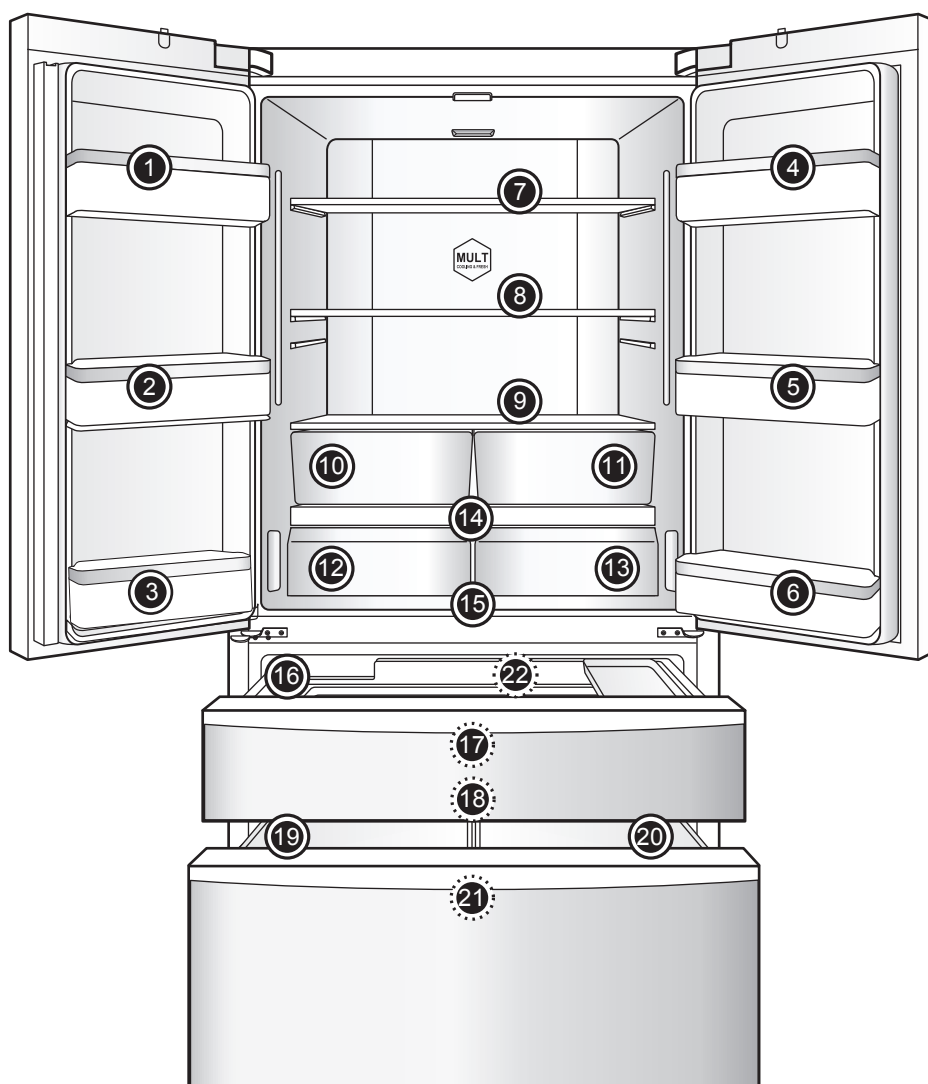

Usages and precautions for the refrigeration compartments

GB

Primarily place foods which are to be stored for short periods of time, or that are going to be consumed all the time inside the refrigerator.

Although the average temperatures in most areas in the refrigerator can be kept at 0°C - 10°C by adjusting the temperature setting, the food cannot be kept fresh for a long time; therefore, the refrigerator can only be used for storage for a short time.

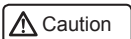

When the ambient temperature in winter is between 0°C - 10°C, the temperature in the refrigerator is lower, and the temperature in the lower part is at 0°C or so.

At this time, the fruits and vegetables should be placed in the upper part of the refrigerator so that they do not get frozen. When closing the refrigerator's left hand door, make sure that the vertical beam is closed in place; otherwise, the door unit cannot be closed tightly; thereby causing the refrigerator's temperature to rise which will set off an alarm.

Recommended storage zones for various foods

Since cold air circulation inside the refrigerator causes differences in the temperatures in various areas, it is recommended that different foods should be placed in different areas at different temperatures.

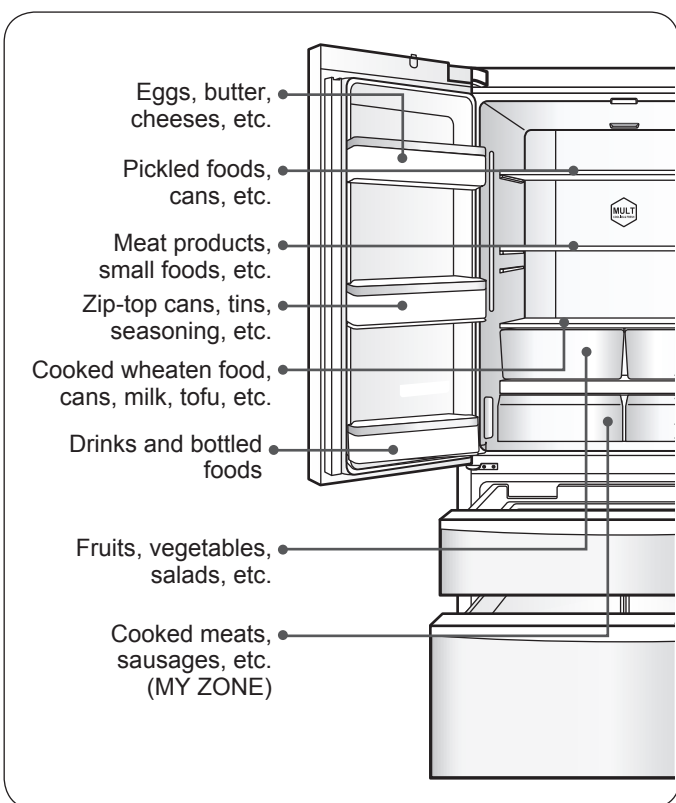

MY ZONE drawer usage

The refrigerator is equipped with MY ZONE drawers which have individual temperature control functions. In accordance with the food's storage demands, foods can be placed in variable temperature compartments that are suitable for their storage: Fruit & Vege, Quick cool, 0° fresh, and Seafood.

Tip:

due to different water contents of meat, some meat with more moisture will be frozen at lower temperatures during storage, so "Immediately cut" meat should be stored in MY ZONE, with function "0°Fresh".

MY ZONE drawer regulation method:

The regulator is the device at the top of the refrigerator's left side wall, it can change the temperature in the left hand MY ZONE drawer.

Tip:

- If larger storage space is needed, MY ZONE can be detached. For detailed disassembly methods, please see "Disassembling and cleaning the parts" on page 21.
 - After detaching MY ZONE, please close it. For detailed methods, please see "Function settings and deactivation of MY ZONE" on page 11.
- If MY ZONE is not closed, MY ZONE drawers' temperatures decrease, which may result in the freezing of stored foods.

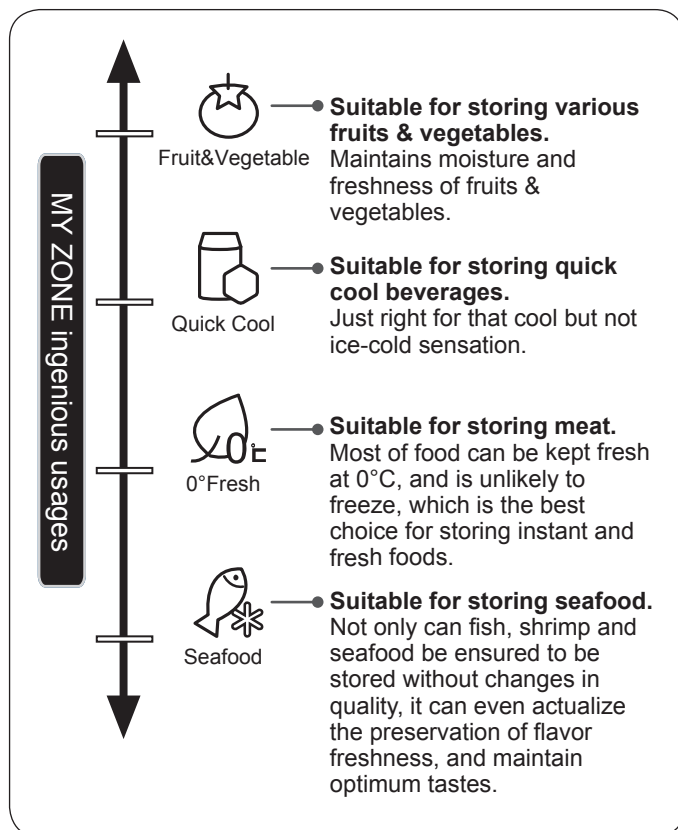

Refrigerated food precautions

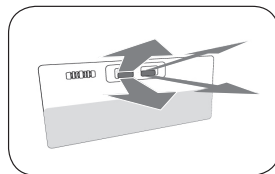
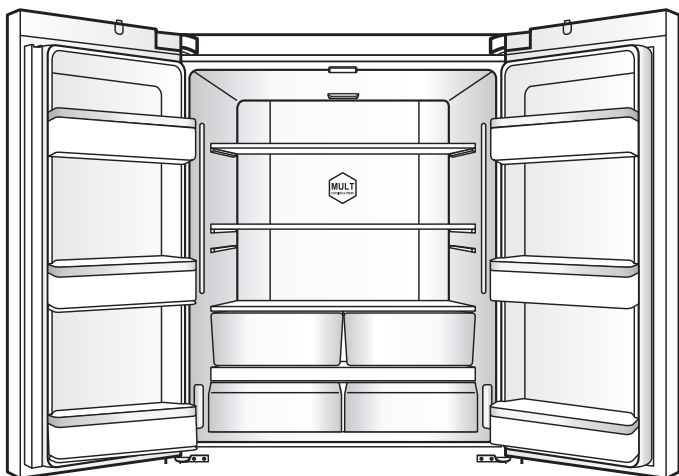

Do not block air outlets.

If the cold air is obstructed without it being discharged, the temperature inside the refrigerator will not drop, and the compressor will constantly work, thereby resulting in a waste of electricity.

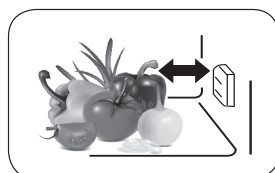

Do not block a temperature sensing device.

In the position as shown in the refrigerating chamber, there is a temperature sensing device. Please make sure that the device is not completely blocked by food, or the refrigerator might not measure the correct temperature and will work intermittently, so that the temperature inside the refrigerator will be too low and unnecessary energy is further wasted.



Do not put hot food directly into the refrigerator

Before putting any hot food in the refrigerator, cool it down to room temperature. Any hot food which is directly put into the refrigerator will not only raise the temperature in the refrigerator, but also affect the freshness of the other foods.

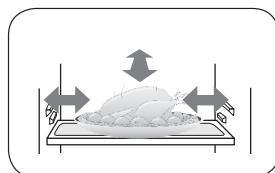

Prevent foods from coming into contact with the refrigerator's linings

The food stored in the refrigerator, especially oily foods should not come into contact with the linings for a long time since this will cause liner corrosion, so as much as possible make sure that foods do not come into direct contact with the lining. When the lining is stained with oil, it should promptly be cleaned.

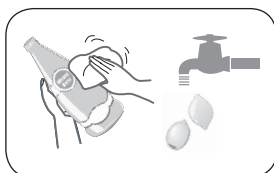

Before putting food into the refrigerator, the food should be cleaned.

In order to ensure good hygienic environment inside the appliance, it is recommended to clean food and wipe up drops, and then store it in the refrigerator.

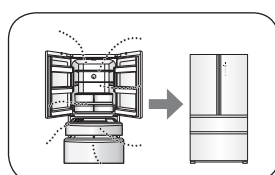

Minimize the times that the doors are opened and closed

In reducing the times that the doors are opened and closed and in avoiding opening them too much, etc. this can reduce the outflow loss of cold air in order to save electricity.

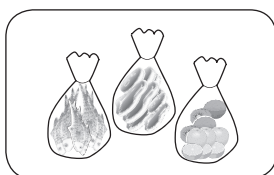

Sort and organize foods in the refrigerator.

Store food separately according to the type, put the food that is eaten every day at the front of the shelves, so as to avoid unnecessarily long openings of the doors and to prevent food from expiring due to forgetting where it is.

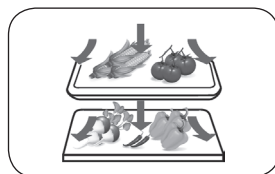

Do not overfill the refrigerator.

Open up spaces between stored foods, so that there are channels for cool air to flow, thereby an even better refrigeration effect is attained.

Usages and precautions for the freezer compartments

GB

The temperature in the freezing chamber is very low, so you can keep food fresh for a long time, and therefore it is best to place the food under long-term storage in this space, but you should comply with food storage time as indicated on the package.

Please watch children and pets, and do not let them play in the drawers, so that they do not damage them. Please do not remove the partition in the large freezer drawer at random.

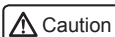

Do not use egg cartons as ice storage containers, and do not put them into the freezer compartments in order to avoid cracking.

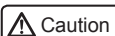

Ice-cold foods (such as ice cream) must be stored in the freezer compartment, not the bottle cage.

Since the temperature at the door bottle holder can easily change when the doors are opened, it could thaw ice-cold food in it.

Frozen food precautions

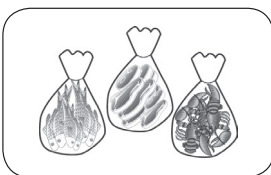
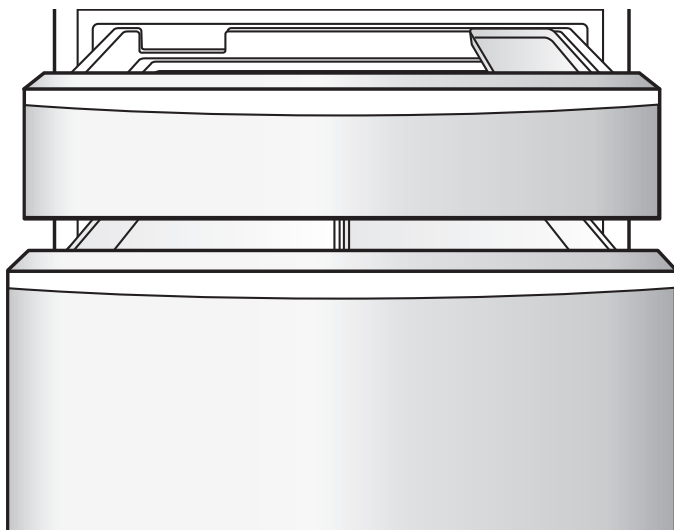

It is best to pack food before freezing it

The outer surface of the package must be dry to prevent it from freezing to the food. Packaging materials should be odorless, airtight, watertight, non-toxic, non-polluting, so as to prevent food odors and reductions in quality.

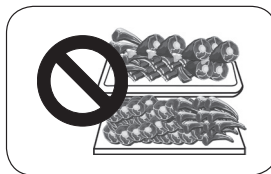

Do not put too much food inside.

Do not put too much fresh food into the freezer compartment at a time. It is best not to exceed the freezing capacity of the refrigerator (refer to "Product Fiche" on page 28).

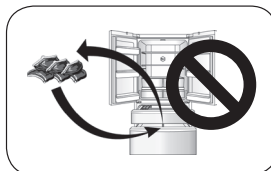

Avoid repeated freezing of foods

In principle, only the required quantity of food should be taken from the freezer compartment to defrost and thaw it, food cannot be refrozen, unless it is processed into finished dishes before freezing it, otherwise that will affect the quality of the food.



Do not put hot food directly inside

Before putting food into the freezer compartment, the hot food must be cooled down to room temperature.

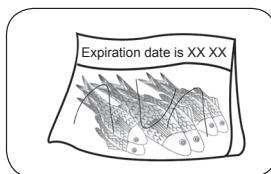

Mark dates on the foods in accordance with the foods' storage periods

The freezing date, deadline and name should be marked on the packaging in accordance with the foods' storage periods when storing foods, in order to prevent expiration.

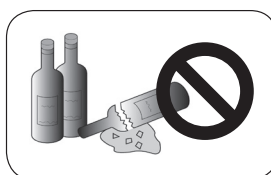

Do not put bottled drinks into the freezer compartment.

Do not put bottled beers, drinks, etc. into the freezer compartment in order to prevent them from cracking.



Divide the food into proper portions

This makes it easier to freeze them thoroughly, so as to better ensure the quality of thawing and cooking; in addition, each portion of food should not exceed 2.5 kg.

Refrigerator Usage Tips

- Radish leaves should be cut off to prevent the absorption of nutrients by the leaves.
- You may move egg cartons to a suitable storage location according to need and choose the right egg carton according to the amount of eggs.
- Zucchini, melons, papayas, bananas, and pineapples, etc. in a refrigerated state will promote their metabolism, so they shall not be refrigerated. But for unripe fruit, it is better to store them in a refrigeration compartment for a certain time to promote their maturation.
- Some foods, such as onions, garlic, ginger, water chestnuts, tubers, etc., can be stored for long periods at room temperature, so it is unnecessary to store them in the refrigerator.
- Fresh vegetable should be washed and then placed into the refrigerator in order to prevent the breeding or spreading of bacteria in the refrigerator.

Precautions for energy-saving usage

- The refrigerator should be installed in a cool and well ventilated room, keep it away from heat, and avoid direct exposure to sunlight as much as possible.
- Minimize the times and frequencies that the doors are opened. For example: store food regularly, which can reduce the access times for opening the doors.
- Cool hot foods or drinks first and then put them in the refrigerator;
- The foods that need to be thawed should be placed first into the refrigerator compartment (or MY ZONE), so you can use the lower temperature of the frozen food to cool the food in the refrigerating chamber (or MY ZONE);
- Do not overfill the refrigerator to avoid obstructing the air flow
- For the temperature setting of the refrigerator, the lower the temperature is set, the greater the energy consumption of the refrigerator is. Based upon the premise of actualizing the food storage conditions, the temperature inside the refrigerator should be set as high as possible.
- If you need to use a relatively large amount of space in the freezer compartment, the small freezer drawer and the gear connecting rod can be removed, then food can be directly put in and taken out through the freezer compartment's glass partition, at the same time this can also decrease the refrigerator's energy consumption;
- Leave as much gap or space around the appliance as practical to ensure good ventilation. See page 7.
If the ventilation is restricted this will increase the running / operating costs and the appliance will not achieve its energy consumption data.
- Keep door seals clean so that the door always closes correctly.

Water Supply Connection

- ▲ It is recommended to have this product installed by a qualified technician.

Note: For further installation details refer to the instructions supplied with the water filter.

- Pressure of the cold water supplied to the automatic icemaker is between 0.15-0.6 Mpa.
- The water tube should be of an appropriate length, usually 8 metres, and should be free of bends after being inserted into place. If the water pipe is too long then the water pressure will be reduced, affecting the ice and cold water content.
- DO NOT connect to the water supply when the ambient temperature is below 0°C, otherwise the water pipe may freeze.
- Always connect to the drinking water supply.
- Keep the water pipe away from heat sources.
- The water filter is there to filter impurities in the water, and to make ice clean and hygienic. It cannot sterilise or destroy anything, so be certain to connect the water pipe to a drinkable water source.
- Automatic water system, do not manually add water.
- If the ice maker is turned on but the appliance is not connected to water, the ice maker will not work.

Fitting the Water Filter

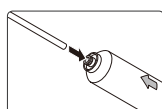

Measure out and cut the length of pipe required from the filter to the Fridge-freezer, and from the filter to the water supply. Make sure that you achieve a square cut using a sharp knife.

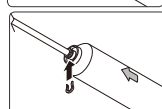

Push fit one of the pipes into the water filter.

Secure the pipe to the filter by sliding a locking clip into the groove as shown.

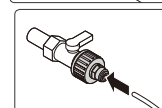

Repeat the procedure on the other end of the filter.

Connect the end into the plastic adaptor. Screw the adaptor onto a suitable 1/4" BSP connector water outlet.

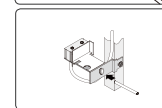

Access the water valve assembly at the back of the refrigerator. Push the pipe into the valve assembly.

Open the water valve to flush the pipe, check leakage in the water pipe joints and allow the water to run until it is clear.

Cleaning and usage of the icemaker

GB

Door Alignment

If the two doors of the refrigerator compartment are not level, please adjust the door height as follows.

1. Lift the lowest door at the hinge side.
2. Using a pair of pliers inset a 'C' washer in the hinge as shown. The 'C' washer should be next to the hinge bracket.
3. Insert as many 'C' washers as required to lift the door to match the other door height. A total of 3 'C' washers are provided in the accessory bag.

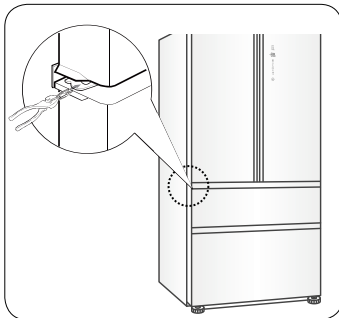

Cleaning the ice cube tray

1. Turn off the icemaker function via the display panel, hold down the handle of the icemaker, and use strength to pull out the icemaker.
2. Remove the icemaker assembly from the refrigerator and turn over the icemaker, so that the ice cube tray is visible.
3. Pull the oval shaped fastener on the ice tray in the direction of arrow 1. Tilt the ice tray upward and pull it out in the direction of arrow 2.

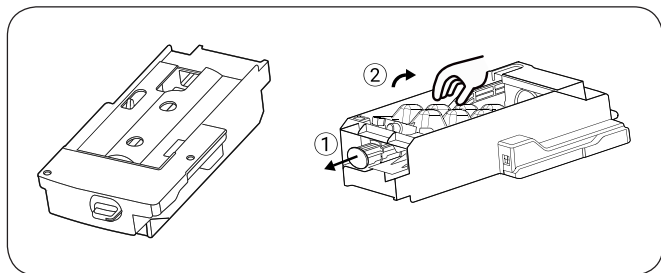

4. After cleaning the tray, put it back in, then firmly push in the icemaker, close the freezer drawer, and switch on the icemaker function via the display panel.

Icemaker usage precautions

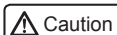

For newly installed appliance, you should wait for 24 hours. This will enable the freezer compartment to cool down, so that it can make ice.

- The ice machine will make 8 ice cubes each time; but the specific ice-making quantity will depend on the indoor temperature, frequency that the doors are opened, water pressure, freezer compartment temperature, etc.
- In order to ensure that the ice tray gets filled up with ice cubes, the ice tray should be frequently pulled out so that the ice cubes get evenly distributed.
- It is a normal phenomenon that some of the ice cubes will clump together during removing.
- When the freezer compartment reaches or is below -12°C , the icemaker will start making ice (if you are just beginning to use the icemaker, or it has not been used to make ice in a long time, you should discard the first several ice cubes, so that impurities in the water line get run out.)
- The icemaker must be installed in the refrigerator through an authorized service agency.

- NEVER expose the water pipe to temperatures below 0°C to avoid freezing.
- Test the tubing for leaks by flushing the tube through with water, until the water runs clear.
- After the appliance has been sited into the location of your choice, make sure that the water tube is arranged so it does not incur damage through bends and kinks and is clear of any heat sources.
- Once the temperature inside the freezer is at -12°C ice production will begin.
- DO NOT touch the ice cube outlet with your hands, or any implements to avoid injury or damage.
- The icemaker can only be supplied with water via the container on top of the left door unit. It can not be connected directly to an external drinking water supply.
- DO NOT manually add water – this is an automatic water system. If the ice maker is turned on but the appliance is not connected to water, the ice maker will not work.

If you occasionally hear unusual sounds in the refrigerator

You may occasionally hear some "crunching" sounds, but these are just normal sounds that are emitted during ice making, so do not worry.

If you do not often use ice cubes

"Old" ice cubes will become cloudy, and will not taste fresh; therefore, please periodically clean the ice cube tray and wash it out with warm water. Before replacing the ice cube tray, be sure to cool it down, otherwise, ice will stick to other parts of the ice machine and affect the ice making function.

If the icemaker in the freezer compartment is not used for a long time

If not used for a long time, please remove the automatic icemaker and any residual ice cubes in the ice storage compartment, wash the ice cube tray and the ice storage compartment with warm water, wipe them dry with a clean towel and put them somewhere else in order to increase storage space.

The water reservoir should be removed, any residual water should be drained out .

How the Icemaker Works

The ice making capacity is 1kg/24 hours (this figure is the test result in lab under the 32°C ambient temperature condition). During the daily use of the appliance, due to the different ambient temperature and water pressure, the ice making capacity may differ a little.

Do not store ice cubes, which are produced during the first batch of cubes following appliance start up, or after a prolonged break. Discard these cubes.

To allow the ice cube tray to fill to maximum capacity, you will need to manually arrange the ice cubes periodically.

Some ice cubes may stick together when dropped into the storage box – you will need to separate these to allow maximum use of the icebox.

Throw out the first few batches of ice cubes if you are making ice for the first time or have not made it for a long time.

If the cubed ice becomes smaller, this may suggest that the filter is blocked from the impurities.

Daily maintenance of this product

Cleaning of the appliance

Food left in the refrigerator will produce bad odors, so you need to periodically clean the appliance.

Steps during cleaning:

1. Unplug the power plug and cut off the power.
2. Use a soft towel or sponge dipped in warm water (neutral detergent can be added) to clean the appliance.
3. Wipe the water on the surface of the appliance with a dry cloth.
4. Clear away the dust at the back and left and right sides of the refrigerator.
5. Complete cleaning (when continuing to use it, please switch on the power).

Tip:

the door gaskets get easily soiled, please pay attention to keeping them clean regularly. Clean door gaskets can ensure that the appliance is well sealed which prevents unnecessary power consumption.

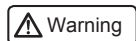

In order to prevent leakage accidents, do not rinse the appliance with water while cleaning it. Use a dry cloth to clean the "switch", "LED lamp" and other electrical parts.

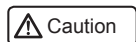

To prevent damage to the appliance, do not use the following substances during cleaning:

1. Acidic or weakly acidic kitchen cleaning agents.
2. Powdered detergents, similar to abrasive powders.
3. Benzene, thinners, alcohol, acids, petroleum and so on.
4. Hard brushes, abrasive sponge brushes and so on.
5. Hot boiling water.

The appliance is very heavy, so please protect the ground when moving the appliance for cleaning and maintenance. Keep the appliance upright when moving it, in order to prevent damage to floor surfaces do not sway it and move it.

When cleaning, do not use hot water to clean the ice-cold glass shelves. This will prevent the glass from breaking and causing personal injury and property damage, due to rapid temperature changes.

Do not directly touch the surface of the part of the freezer compartments with wet hands to prevent skin from being stuck to the freezer compartment parts. Do not put your hand under the bottom of the appliance directly to clean the floor, so as not to hurt your hands. If you need to clean the floor, move the appliance.

When moving the appliance, be careful to adjust the adjustable feet in advance so that they are moved away from the floor, which will prevent them from scratching up the floor.

After installing a new water filter, discard all ice produced during the first 24 hours.

Defrosting the freezer compartment

The refrigerator's freezer compartment is automatically defrosted, no manual operations are required.

Disassembling and cleaning the parts

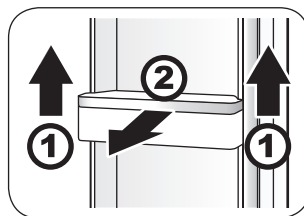

Disassembling and cleaning of the door bottle holder

1. Hold both sides of the door bottle holder to lift it upward in the direction of ①.
2. Pull out in the direction of ②.

Wipe the shelves with a soft towel or sponge dipped in warm water (neutral detergent can be added), after cleaning, put the door bottle holder back on.

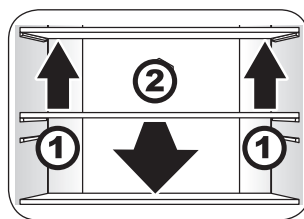

Disassembly and cleaning of the refrigerator shelves

1. The front end of the shelves shall be lifted upward in the direction of ①.
2. Pull out upward in the direction of ②.

Wipe the shelves with a soft towel or sponge dipped in warm water (neutral detergent can be added), and after cleaning, put them back in.

Note:

When removing the shelves, make sure that the doors are opened at maximum angles to prevent the shelves from striking the door frame, or to enable them to be pulled all the way out.

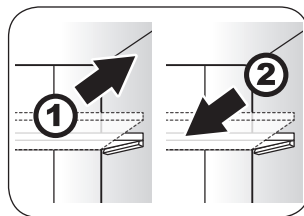

Adjusting the refrigerator shelves

Adjust the shelves to the right height in accordance with food storage needs. Before adjusting the height, please remove the foods on the shelves. When adjusting the height, the shelves need to be disassembled.

1. Lift the front of the shelf up and tilt it, then pull it out, and take it apart.

- When installing, wedge the shelf into the brackets on the right and the left and push it in along the ribs in the liner, lower the front part of the shelf, then insert it into the groove.

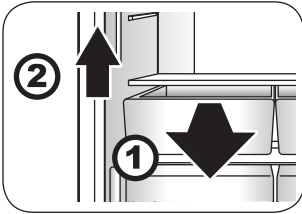

Disassembling and cleaning the fruit and vegetable compartment

- Pull the fruit and vegetable drawer fully out.
- Lift the fruit and vegetable boxes up at the front edge to remove from the drawer frame.
- When refitting the fruit and vegetable boxes in the drawer frame ensure the pips on the bottom of each box engage in the holes in the drawer frame.

Wipe the fruit and vegetable compartment with a soft towel or sponge dipped in warm water (neutral detergent can be added), and after cleaning, put it back in.

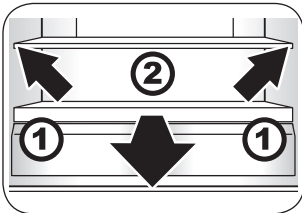

Disassembling and cleaning the fruit and vegetable box cover plate

- After pulling the fruit and vegetable compartment down to a suitable position, tilt the cover plate upward and take it out.
- Pull out forward.

Wipe the fruit and vegetable cover plate (the fruit and vegetable cover plate consists of the glass panel and the plastic shelf, pay attention to the glass panel when removing it, in order to prevent injuries caused by crushing) with a soft towel or sponge dipped in warm water (neutral detergent can be added). After cleaning it, put it back in.

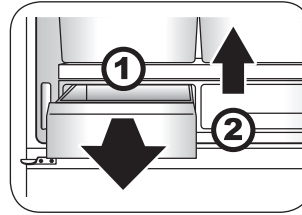

Disassembling and cleaning the MY ZONE drawer

- Pull the MY ZONE drawer out forward.
- Lift upward to remove.

Wipe the MY ZONE drawer with a soft towel or sponge dipped in warm water (neutral detergent can be added), and after cleaning it, put it back in.

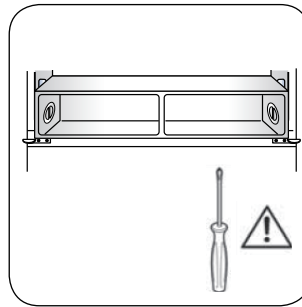

Disassembling the entire MY ZONE compartment

The My Zone cannot be removed without the use of tools. If it is necessary to remove the My Zone and assistance is required, please call the Hotline for help.

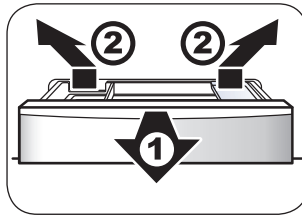

Disassembling and cleaning the freezer compartment's small drawer that is connected to the ice compartment and the dumpling tray

- Pull the small freezer drawer out as far as possible.
- Tilt the ice compartment and the dumpling tray upward and then pull them out.

Wipe the inside of the small freezer drawer and the dumpling tray with a soft towel or sponge dipped in warm water (neutral detergent can be added), and after cleaning them, push them back in.

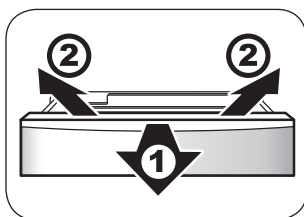

Disassembling and cleaning the small freezer drawer

1. Pull out the small freezer drawer as far as possible, and take out the ice cube tray and dumping tray that are connected to the small freezer drawer.
2. Tilt the small freezer drawer upwards then pull it out.
3. Reverse the above procedures to put the small freezer drawer back in.

Wipe the small freezer drawer with a soft towel or sponge dipped in warm water (neutral detergent can be added), and after cleaning it, put it back in.

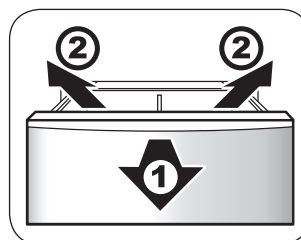

Disassembling and cleaning the large freezer drawer

1. Pull out the large freezer drawer as far as possible, and take out the pull-out drawer of the large freezer drawer.
2. After moving the pull-out tray, disengage the clip position, and take out the tray.
3. Tilt the large freezer drawer upward to take it out.
4. Reverse the above procedures to install the large freezer drawer.

Wipe the large freezer drawer with a soft towel or sponge dipped in warm water (neutral detergent can be added), and after cleaning it, put it back in.

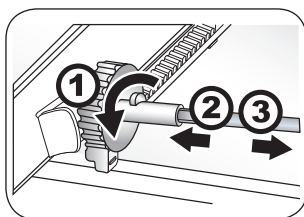

Disassembling the gear connecting rod

1. After removing the small freezer drawer, push the gear connecting rod to the very front. Push aside the protruding clip fastener that is on the left end of the gear connecting rod.
2. Move the metal rod to the left, then disengage the gear connection from the right end of the rod.
3. Pull out the metal rod from the left gear connecting part.
4. Reverse the above procedures to install the gear connecting rod.

Disassembling the door unit

For the disassembly of the door unit, please contact a Haier salesperson if necessary.

Illumination lamps in the refrigerator and their replacements

Illumination lamp parameters: DC 12 V, 2 W × 2, 18 W × 1
The illumination lamp is an LED lamp, the corresponding lamp consumes less power and has a long lifespan.
In case of failure, do not disassemble by yourself. Please contact after-sales staff to replace.

The illumination lamp in the freezer compartment and its replacement

Illumination lamp parameters: DC 12 V, 1 W × 4
The illumination lamp is an LED lamp, the corresponding lamp consumes less power and has a long lifespan.
In case of failure, do not disassemble by yourself. Please contact after-sales staff to replace.

The illumination lamp in MY ZONE and its replacement

Illumination lamp parameters: DC 12 V, 1 W × 2
The illuminating lamp is of an LED lamp, the corresponding lamp consumes less power and has a long lifespan.
In case of failure, do not disassemble by yourself. Please contact after-sales staff to replace.

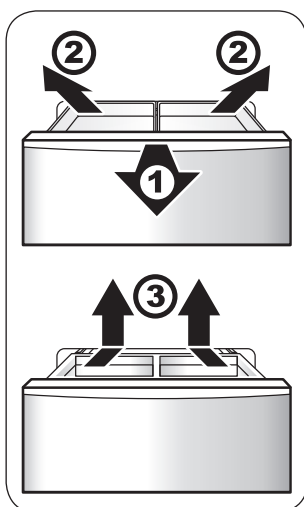

Disassembling and cleaning the pull-out tray

1. Pull out the large freezer drawer as far as possible.
2. Tilt the pull-out tray upward to take it out.
3. After moving the pull-out drawer, disengage the clip position, and take out the tray.

Wipe the pull-out drawer and the pull-out tray with a soft towel or sponge dipped in warm water (neutral detergent can be added), and after cleaning them, put them back in.

Transporting the appliance

1. Unplug the power plug and cut off the power.
2. Remove all of the food that is inside the appliance.
3. Secure the shelves that are inside of the refrigerator, and the MY ZONE drawer, freezer compartment drawer, and any other movable parts with tape.
4. Close the refrigerator doors tightly and secure them with adhesive tape to prevent them from opening while the appliance is being transported.

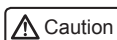

Do not let the the appliance fall over at any time. When moving the appliance, the maximum tilting angle can not exceed 45 degrees (the angle between perpendicular), this is to prevent the refrigerating system from getting damaged, which will affect normal usage.



Appliance usage disruptions

Processing when there is a power failure

After a power outage, the temperature inside the appliance will not be affected within 1-2 hours even in summer.

After a power outage, do not put any new food into the appliance, nor open the doors as much as possible.

If you have been notified of a power outage in advance, you should make some ice cubes, and fill leakproof containers with them, then put the containers inside the top section of the refrigerator.

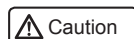

If the temperature in the freezing chamber is rising due to a power failure or other malfunction, it will shorten the shelf life of food and reduce the edible quality.

Usage disruption / long absence

If you need to and you do not want to activate the Holiday-function using the refrigerator for a relatively long amount of time, you should unplug the power plug, cut off the power supply, and clean out the refrigerator as per the aforementioned methods.

When there are usage disruptions, the doors of the refrigerator should be opened to prevent the residue of trace food in the refrigerator from producing adverse odors.

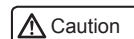

After unplugging the power, keep it unplugged for at least five minutes, and then replug it. In order to prevent the lifespan of the appliance from being affected, under general circumstances do not stop using the appliance.

Water Filter

To maintain water quality, the filter will need replacing from time to time. We recommend that the water filter is replaced every 6 months. However, if the water quality shows signs of deterioration, either visually or in taste, then the filter should be changed sooner.

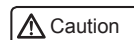

The disused device must be disposed of properly or handed over to a specialist for disposal. In order not to exclude hazards to the environment and damage to your health, the old equipment must not be disposed of by negligence.

During longer absence (holiday)

Before long periods of absence (eg holidays), please switch off the appliance, remove all refrigerated goods, clean the interior after defrosting and leave the refrigerator doors open after dry wiping, so that no unpleasant odor caused.

1. Disconnect the plug and turn off the power.
2. Remove all food in the fridge.
3. If it is necessary to clean the refrigerator, please refer to the correct procedure under "Cleaning the refrigerator" on page 23.

Do you have any questions? First look here!

Phenomenon	Cause	Solution
Q1: Whether the refrigerator is working or not?		
The lamp in the refrigerator is not on.	<ul style="list-style-type: none"> a. The power is off. b. The LED lamp is damaged. 	<ul style="list-style-type: none"> a. Check the plugs, sockets, fuses, etc. to see if there is any damage, and then power on in case there are not any problems. b. Please replace the LED lamp by referring to the contents of "The illumination lamp in the refrigerator compartment and its replacement" on page 23.
The appliance is not working.	<ul style="list-style-type: none"> a. The power is off. b. The power voltage is too low. 	<ul style="list-style-type: none"> a. Check the plugs, sockets, fuses, etc. to see if there is any damage, and then power on in case there are not any problems. b. Request a professional electrician to resolve power supply problems.
Q2: How long does the appliance compressor work?		
The set-up time is too long or the appliance starts working and shuts down frequently.	<ul style="list-style-type: none"> a. When initial using, the temperature in the appliance is relatively high. b. The ambient temperature is high or the ventilation is poor. c. The doors of the appliance are not closed tightly or food obstructs the doors so that they cannot be closed. d. The doors of the appliance are opened frequently, or the doors are left open for a long time. e. A lot of foods are put into the appliance at one time to cool or freeze. f. The temperature value is set too low. 	As long as the door is locked, the compressor runs for a period of time, the temperature in the appliance achieves a balance, and then the problem will be resolved. In addition, the length of time depends on the temperature setting, the ambient temperature, door opening frequency, and how much food is stored in the appliance.
Q3: What temperature is normal in the appliance?		
Low enough temperatures in the appliance cannot be achieved.	<ul style="list-style-type: none"> a. The temperature value is set too high. b. The doors of the appliance are opened frequently, or the doors are left open for a long time. c. The appliance is under direct sun exposure or too close to a stove, heating and other heat sources. d. The ventilation is poor, there is something blocking the steel panel on the left and right sides or the back of the appliance, or these locations are too dirty. 	<ul style="list-style-type: none"> a. Decrease the temperature setting value of the appliance. For the specific adjustment method, see "Refrigerator temperature setting" on page 11. b. Close the doors of the appliance tightly, and operate the appliance normally for a period of time to resolve the problem. c. Position the refrigeration in another location away from the heat sources. d. Reposition the appliance in another well-ventilated location, or clean up the dirty locations. For specific cleaning methods, see "Cleaning of the refrigerator" on page 21.

Phenomenon	Cause	Solution
Q4: Condensation on the outside the appliance?		
Condensation forms on the outside the refrigerator.	The air humidity is relatively great at this time.	Please wipe it dry with a soft cloth.
Q5: Drops inside the refrigerator?		
Foods are frosted or icy crystals have formed.	<ul style="list-style-type: none"> a. The temperature value is set too high. b. The doors of the refrigerator are not closed tightly or food obstructs the doors so that they cannot be closed. c. The doors of the refrigerator are opened frequently, or the doors are left open for a long time. d. The food is too close to the ventilation ports. 	Firmly close the refrigerator doors, and do not put food near the ventilation ports. In addition, the formation of frost inside frozen packages is a normal phenomenon, there is no need for concern.
Q6: Odors in the refrigerator?		
There are odors in the refrigerator.	<ul style="list-style-type: none"> a. Odorous food is not sealed. b. There is spoiling food. c. The inside of the refrigerator needs to be cleaned. 	<ul style="list-style-type: none"> a. Tightly wrap any odorous food. b. Clean up and throw away any spoiled food. c. Clean up the inside of the refrigerator. For specific cleaning methods, see "Cleaning the refrigerator"
Q7: Temperature of the appliance's exterior casing?		
Sometimes the appliance's exterior casing produces heat, especially when it was just purchased, brought home and initially plugged in.	This is not a malfunction, it was designed this way in order to prevent condensation.	This is a normal phenomenon, there is no need for concern.

Phenomenon	Cause	Solution
Q8: What sound does the appliance make in normal operation?		
The sounds that the appliance produces when it goes into operation are relatively loud.	The reason is that due to the power being put through, the operating conditions of the appliance are not yet stable.	When some time has elapsed after operations are stabilized, the sounds will then decrease.
The appliance makes a "ticking" sound when it starts and shuts down.	This is the sound made when the compressor is under normal operation.	This is a normal phenomenon, there is no need for concern.
The appliance makes a scraping sound when it is working.	Due to temperature changes, the evaporator and the piping will make sounds due to thermal expansion and contraction.	This is a normal phenomenon, there is no need for concern.
There are sounds of a slight breeze blowing when the appliance is working.	A fan is at work when the refrigerator is working.	This is a normal phenomenon, there is no need for concern.
There are sounds of water flowing when the appliance is working.	When the liquid refrigerant is flowing within the evaporator, sounds similar to "flowing water" are produced. Such a sound is made in the evaporator and the compressor generally: when the refrigerator shuts down and the liquid working medium reflows it will make a continuous or discontinuous sound like a "rushing" stream.	This is a normal phenomenon, there is no need for concern.
There are "whirring" or "gurgling" sounds when the appliance is working.	When the defroster is going through its cycles, the water which drips onto the heated wires produces "hissing" or "bubbling" sounds, and after the defrosting is completed, some kinds of slight "crackling" sounds might be made, at the same time the evaporator produces some boiling or gurgling sounds.	This is a normal phenomenon, there is no need for concern.
There are rumbling sounds when the appliance is working.	<ul style="list-style-type: none"> a. The ground is not level nor is the appliance positioned stably. b. Some part of the refrigerator is in contact with an external object or the wall. 	<ul style="list-style-type: none"> a. Place the appliance in another level location and adjust it so that it is stable. b. Move the external object that is making contact with the appliance, or move the appliance a certain distance away from the objects it is touching.

Product Fiche (according EU 1060/2010)

GB

Model	HB26FSSAAA/HB26FGSAAA/HB26FSNAAA
Trade mark	Haier
Appliance category	Refrigerator-freezer
Energy efficiency class	A++
Energy consumption (kWh/year) ¹⁾	435
Net fridge storage volume (L)	460
Net freezer storage volume (L)	225
The design temperature of "other compartments" >14°C	Not applicable
No-frost	Yes
Temperature rise time (h)	20
Freezing capacity (kg/24h)	14
Climate class	SN,N,ST,T
Noise level (dB(A))	40
Built-in / Freestanding	Freestanding
Ice making capacity	

¹⁾ Based on standard test results for 24 hours. Actual energy consumption will depend on how the appliance is used and where it is located.