



# 16/24-Port Gigabit Ethernet Switch

Quick Start Guide

# TABLE OF CONTENTS

<b>Chapter 1 Introduction</b> .....	<b>1</b>
1.1 Overview.....	1
1.2 Packing List .....	1
1.3 Appearance.....	2
1.3.1 Front Panel.....	2
1.3.2 Rear Panel .....	3
<b>Chapter 2 Installation</b> .....	<b>4</b>
2.1 Preventive and Cautionary Tips.....	4
2.2 Working Environment Requirements.....	4
2.2.1 Temperature and Humidity.....	4
2.2.2 Static Electricity Protection .....	4
2.2.3 Lightning Protection.....	5
2.2.4 Installation Position .....	5
2.3 Installation .....	5
2.4 Grounding.....	6
2.4.1 With Grounding Bar .....	6
2.4.2 Without Grounding Bar .....	7
<b>Chapter 3 Physical Connection</b> .....	<b>9</b>
3.1 Connecting RJ45 Port .....	9
3.2 Checking the Cabling .....	9
3.3 Powering on Switch .....	10

## **Quick Start Guide**

COPYRIGHT ©2018 Hangzhou Hikvision Digital Technology Co., Ltd.

### **ALL RIGHTS RESERVED.**

Any and all information, including, among others, wordings, pictures, graphs are the properties of Hangzhou Hikvision Digital Technology Co., Ltd. or its subsidiaries (hereinafter referred to be “Hikvision”). This user manual (hereinafter referred to be “the Manual”) cannot be reproduced, changed, translated, or distributed, partially or wholly, by any means, without the prior written permission of Hikvision. Unless otherwise stipulated, Hikvision does not make any warranties, guarantees or representations, express or implied, regarding to the Manual.

### **About this Manual**

This Manual is applicable to DS-3E03XXP Series 100M PoE Switch.

The Manual includes instructions for using and managing the product. Pictures, charts, images and all other information hereinafter are for description and explanation only. The information contained in the Manual is subject to change, without notice, due to firmware updates or other reasons. Please find the latest version in the company website (<http://overseas.hikvision.com/en/>).

Please use this user manual under the guidance of professionals.

### **Trademarks Acknowledgement**

**HIKVISION** and other Hikvision’s trademarks and logos are the properties of Hikvision in various jurisdictions. Other trademarks and logos mentioned below are the properties of their respective owners.

### **Legal Disclaimer**

TO THE MAXIMUM EXTENT PERMITTED BY APPLICABLE LAW, THE PRODUCT DESCRIBED, WITH ITS HARDWARE, SOFTWARE AND FIRMWARE, IS PROVIDED “AS IS”, WITH ALL FAULTS AND ERRORS, AND HIKVISION MAKES NO WARRANTIES, EXPRESS OR IMPLIED, INCLUDING WITHOUT LIMITATION, MERCHANTABILITY, SATISFACTORY QUALITY, FITNESS FOR A PARTICULAR PURPOSE, AND NON-INFRINGEMENT OF THIRD PARTY. IN NO EVENT WILL HIKVISION, ITS DIRECTORS, OFFICERS, EMPLOYEES, OR AGENTS BE LIABLE TO YOU FOR ANY SPECIAL, CONSEQUENTIAL, INCIDENTAL, OR INDIRECT DAMAGES, INCLUDING, AMONG OTHERS, DAMAGES FOR LOSS OF BUSINESS PROFITS, BUSINESS INTERRUPTION, OR LOSS OF DATA OR DOCUMENTATION, IN CONNECTION WITH THE USE OF THIS PRODUCT, EVEN IF HIKVISION HAS BEEN ADVISED OF THE POSSIBILITY OF SUCH DAMAGES.

REGARDING TO THE PRODUCT WITH INTERNET ACCESS, THE USE OF PRODUCT SHALL BE WHOLLY AT YOUR OWN RISKS. HIKVISION SHALL NOT TAKE ANY RESPONSIBILITIES FOR ABNORMAL OPERATION, PRIVACY LEAKAGE OR OTHER DAMAGES RESULTING FROM CYBER ATTACK, HACKER ATTACK, VIRUS INSPECTION, OR OTHER INTERNET SECURITY RISKS; HOWEVER, HIKVISION WILL PROVIDE TIMELY TECHNICAL SUPPORT IF REQUIRED.

SURVEILLANCE LAWS VARY BY JURISDICTION. PLEASE CHECK ALL RELEVANT LAWS IN YOUR JURISDICTION BEFORE USING THIS PRODUCT IN ORDER TO ENSURE THAT YOUR USE CONFORMS THE APPLICABLE LAW. HIKVISION SHALL NOT BE LIABLE IN THE EVENT THAT THIS PRODUCT IS USED WITH ILLEGITIMATE PURPOSES.

IN THE EVENT OF ANY CONFLICTS BETWEEN THIS MANUAL AND THE APPLICABLE LAW, THE LATER PREVAILS.

## Regulatory Information

### FCC Information

Please take attention that changes or modification not expressly approved by the party responsible for compliance could void the user's authority to operate the equipment.

**FCC compliance:** This equipment has been tested and found to comply with the limits for a Class A digital device, pursuant to part 15 of the FCC Rules. These limits are designed to provide reasonable protection against harmful interference when the equipment is operated in a commercial environment. This equipment generates, uses, and can radiate radio frequency energy and, if not installed and used in accordance with the instruction manual, may cause harmful interference to radio communications. Operation of this equipment in a residential area is likely to cause harmful interference in which case the user will be required to correct the interference at his own expense.

### FCC Conditions

This device complies with part 15 of the FCC Rules. Operation is subject to the following two conditions:

1. This device may not cause harmful interference.
2. This device must accept any interference received, including interference that may cause undesired operation.

### EU Conformity Statement

 This product and - if applicable - the supplied accessories too are marked with "CE" and comply therefore with the applicable harmonized European standards listed under the EMC Directive 2014/30/EU, the LVD Directive 2014/35/EU, the RoHS Directive 2011/65/EU.

 2012/19/EU (WEEE directive): Products marked with this symbol cannot be disposed of as unsorted municipal waste in the European Union. For proper recycling, return this product to your local supplier upon the purchase of equivalent new equipment, or dispose of it at designated collection points. For more information see: [www.recyclethis.info](http://www.recyclethis.info)

 2006/66/EC (battery directive): This product contains a battery that cannot be disposed of as unsorted municipal waste in the European Union. See the product documentation for specific battery information. The battery is marked with this symbol, which may include lettering to indicate cadmium (Cd), lead (Pb), or mercury (Hg). For proper recycling, return the battery to your supplier or to a designated collection point. For more information see: [www.recyclethis.info](http://www.recyclethis.info)

### Industry Canada ICES-003 Compliance



This device meets the CAN ICES-3 (A)/NMB-3(A) standards requirements.

## Applicable Models

This manual is applicable to DS-3E0516 and DS-3E0524 series gigabit Ethernet switch.

## Symbol Conventions

The symbols that may be found in this document are defined as follows.

Symbol	Description
 <b>NOTE</b>	Provides additional information to emphasize or supplement important points of the main text.
 <b>WARNING</b>	Indicates a potentially hazardous situation, which if not avoided, could result in equipment damage, data loss, performance degradation, or unexpected results.
 <b>DANGER</b>	Indicates a hazard with a high level of risk, which if not avoided, will result in death or serious injury.

### **WARNING**

- During the installation and utilization of the device, please strictly conform to electrical safety rules in different nations and regions.
- The device must be installed in machine room only, and only maintenance staff or qualified person should access to the device.
- Do not touch the upper cover area of the device that may be overheated.
- Power must be shut down during cable connection, device installation and dismantlement.
- You shall acknowledge that the use of the device with Internet access might be under network security risks, please strengthen protection for your personal information and data security. If you find the device might be under network security risks, please contact with us.
- Proper configuration of all passwords and other security settings is the responsibility of the installer, and you shall keep user name and passwords properly.

# Chapter 1 Introduction





## 1.1 Overview

DS-3E0516 and DS-3E0524 series unmanaged switches are layer 2 gigabit Ethernet switches, providing 16/24 10/100/1000M Ethernet ports to upload data via convergence switches. DS-3E0516 and DS-3E0524 series switches are reliable, easy to install and maintain, and equipped with rapid switch function. With multiple access ports, the switches are applicable for access or aggregation and upload of small-scale LAN devices.

## 1.2 Packing List

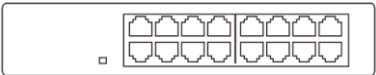
The packing list is shown as below. If there is any damage or lack, take the original package and contact the dealer to change.

Table 1-1 Packing List of DS-3E0516 and DS-3E0524

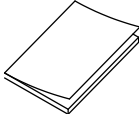
Name	Item	Quantity
Switch	 <p> <b>NOTE</b> The picture takes DS-3E0516 as an example.</p>	1
L-shaped bracket		1
Power cord		1
Screw		4
User manual		1

## 1.3 Appearance

### 1.3.1 Front Panel

Front panels of DS-3E0516 and DS-3E0524 are shown as below.

#### Front Panel of DS-3E0516

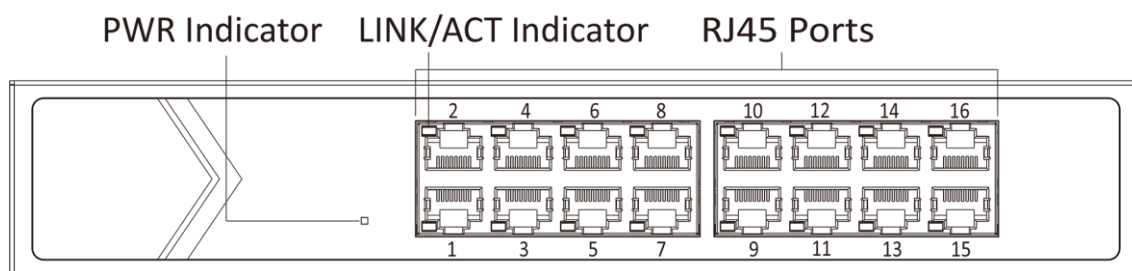

Figure 1-1 DS-3E0516 Front Panel

#### Front Panel of DS-3E0524

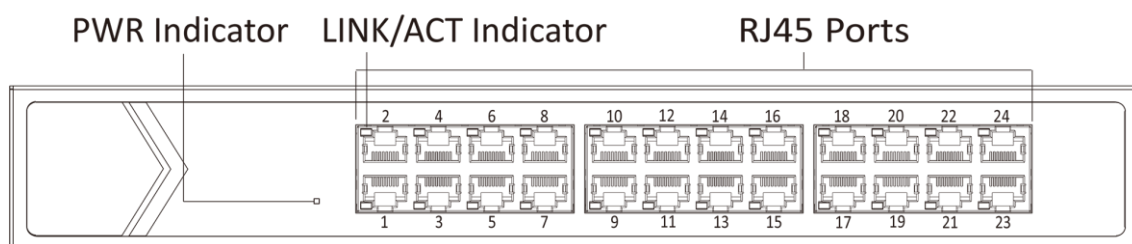

Figure 1-2 DS-3E0524 Front Panel

#### RJ45 Ports

1000M Ethernet ports are used for devices connection via network cables.

#### Indicator

Indicators are used to monitor the status of switches. See the following table for the description of the indicators.

Table 1-2 Indicator Description

Indicator	Status	Description
PWR indicator	Solid	The switch is powered on normally.
	Unlit	No power supply connected or power supply is abnormal.
LINK/ACT indicator	Solid	RJ45 port is connected.
	Flashing	RJ45 port is transmitting data.
	Unlit	RJ45 port is disconnected or connection is abnormal.

## 1.3.2 Rear Panel

Rear panel of DS-3E0516 and DS-3E0524 is shown as below.

### Rear Panel of DS-3E0516 and DS-3E0524



Figure 1-3 DS-3E0516 and DS-3E0524 Rear Panel

### Grounding Terminal

The grounding terminal is used to connect to the ground cable to protect the switch from lightning. For details about grounding, see section *Grounding*.

### Power Supply

Connect power port of the switch with power socket by power cord, and use 100~240 VAC to provide power to the switch.



Use the attached power cord to connect the switch to socket.

## Chapter 2 Installation

### 2.1 Preventive and Cautionary Tips

- Before installation, put on anti-static gloves.
- During the installation, power off your switch.
- Use the attached power adapter or power cord to connect the switch to power supply.
- The input voltage range must be consistent with the voltage range of the power adapter and switch.
- Ensure the switch is installed in a well-ventilated position.
- Do not open or dismantle the shell of the switch.
- Cut off power supply before cleaning the switch. Do not clean the switch with any liquid.
- Keep the switch away from power line, electric light, and power grid.

### 2.2 Working Environment Requirements

#### 2.2.1 Temperature and Humidity

In order to ensure normal working and operation life of the switch, room temperature and humidity must be kept at certain level.

- If room humidity is too high for a long time, insulating materials may be ineffective or even lead to electricity leakage; mechanical performance of materials may change, and metal components may be rust, etc.
- If relative humidity is too low in the room, insulating gaskets may shrink, which leads to the loosening of screws and static electricity, and damages circuit of your switch.
- If room temperature is too high for a long time, insulating materials may be aging in a fast speed, which substantially reduces the reliability of your switch and seriously impacts its operation life.

#### 2.2.2 Static Electricity Protection

Dust may lead to electrostatic adsorption. To protect the device from static electricity harm, pay attention to the following requirements:

- Keep the environment air clean. A regular dusting is necessary.
- Make sure the device is grounded well.

## 2.2.3 Lightning Protection

In thunderstorm weather, a sudden strong current may damage the switch. To protect your switch from lightning strike or strong current, please:

- Make sure the switch, rack, installation desktop, and power socket on the wall all are well-grounded.
- Route the switch cables properly.
- If you need to route cables outdoors, it is advised to use a lightning arrester.

## 2.2.4 Installation Position

No matter whether your switch is installed on a rack or desktop, follow the instructions below:

- Make sure the rack or desktop be stable and firm enough.
- The room must be well-ventilated. Keep at least 10 cm distance between all sides for cooling.
- Do not place any heavy or big-size object on the switch.
- Keep at least 1.5 cm vertical distance between each switch while installing it on a rack.

## 2.3 Installation

DS-3E0516 and DS-3E0524 switches only support rack installation. Follow the steps below for rack installation.

### NOTE

The following panel is the front panel of the switch. For details about the ports, see section *Appearance*.

Step 1 Check the grounding and stability of the rack.

Step 2 Use the attached screws to fix two L-shaped brackets to the sides of the switch.

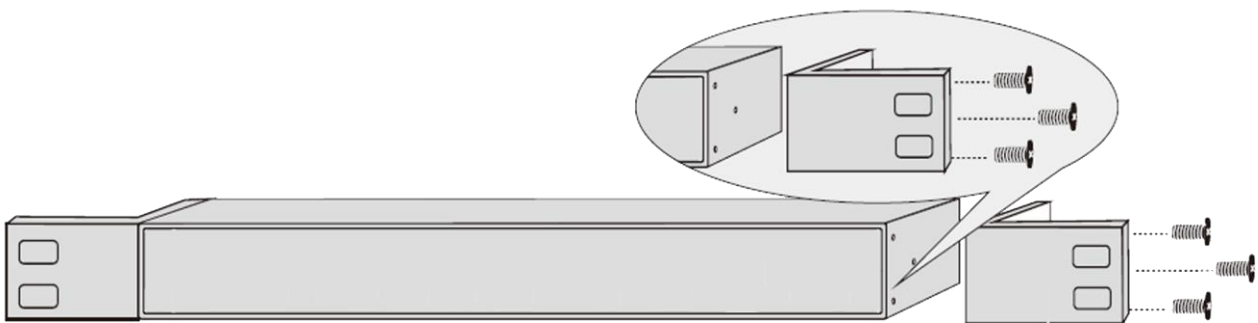

Figure 2-1 Install L-Shaped Bracket

Step 3 Place your switch on the rack, fix it to the rack with self-prepared screws, and ensure the stable installation of your switch to the rack.

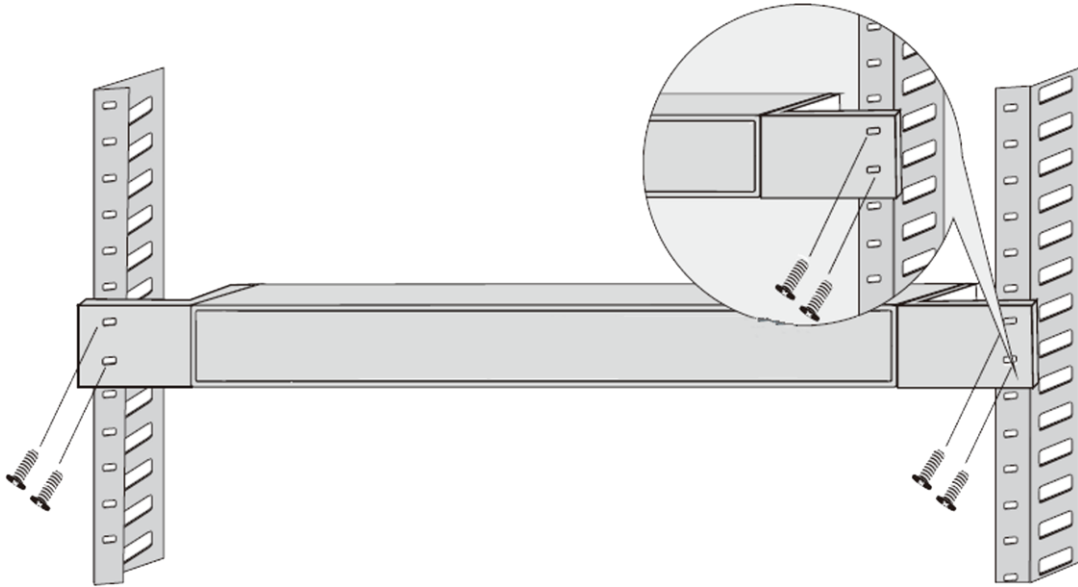

Figure 2-2 Fix Switch to Rack

 **NOTE**

- Do not place any heavy object on the switch in case of any incident.
- Make sure sound cooling and ventilation.

## 2.4 Grounding

***Purpose:***

Grounding is used to quickly release overvoltage and overcurrent induced by lightning for switch, and to protect personal safety. Select the appropriate grounding method according to your needs.

### 2.4.1 With Grounding Bar

If a grounding bar is available at the installation site, follow the steps below.

Step 1 Connect one end of the grounding cable to the binding post on the grounding bar.

Step 2 Connect the other end of the grounding cable to the switch grounding terminal and fix the screw.

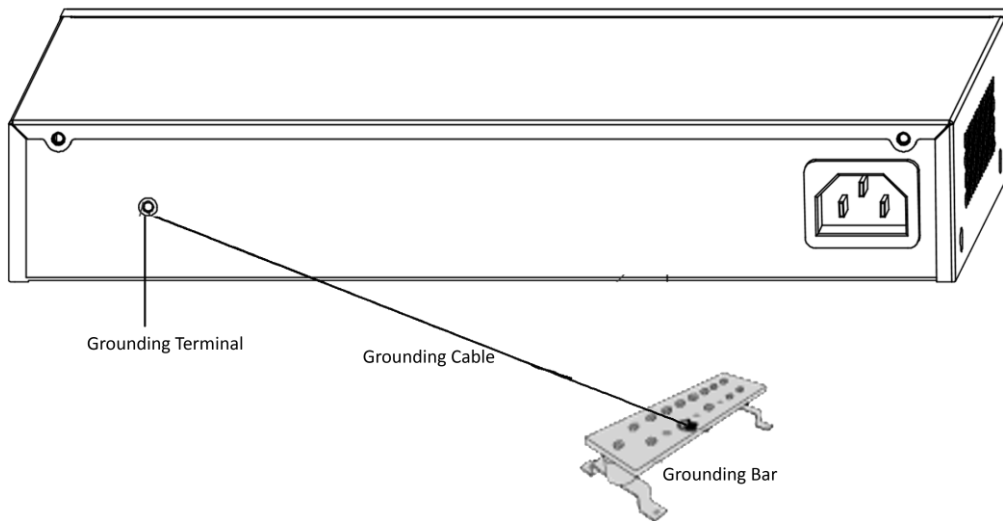

Figure 2-3 Grounding with Grounding Bar

 **NOTE**

Connect the grounding cable to the grounding system in the equipment room. Do not connect it to a fire main or lightning rod.

## 2.4.2 Without Grounding Bar

If there is no grounding bar but earth is nearby and the grounding body is allowed to be buried, follow the steps below.

Step 1 Bury an angle steel or steel pipe ( $\geq 0.5$  m) into the mud land.

Step 2 Weld one end of the grounding cable to the angle steel or steel pipe and embalm the welding point via electroplating or coating.

Step 3 Connect the other end of the grounding cable to the grounding terminal.

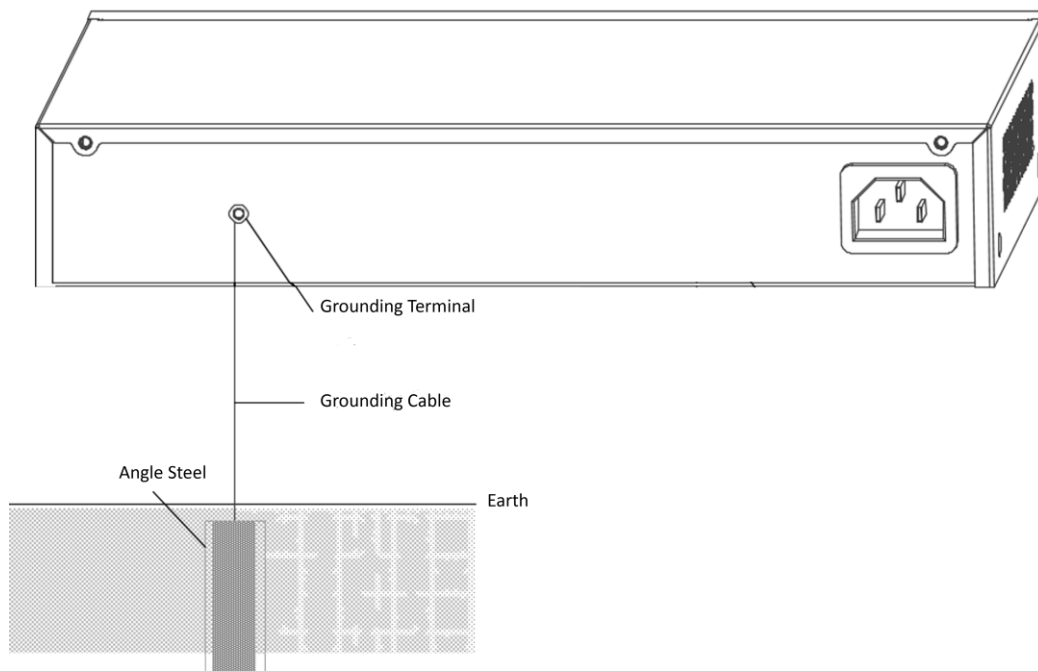

Figure 2-4 Grounding with Angle Steel

If the conditions for burying the grounding body are not available, an AC-powered Ethernet switch can be grounded using the PE (Protective Earth) wire of the AC power supply. The precondition is that the power cord of the switch should adopt 3-pin cable with protective earth wire, and the AC power supply protective earth wire has been well grounded on the side of distribution room or AC power supply transformer.

## Chapter 3 Physical Connection

### 3.1 Connecting RJ45 Port

Use a network cable to connect your switch to the RJ45 port of an opposite end device. The RJ45 port can connect with network camera, IP camera, NVR, switch, etc.

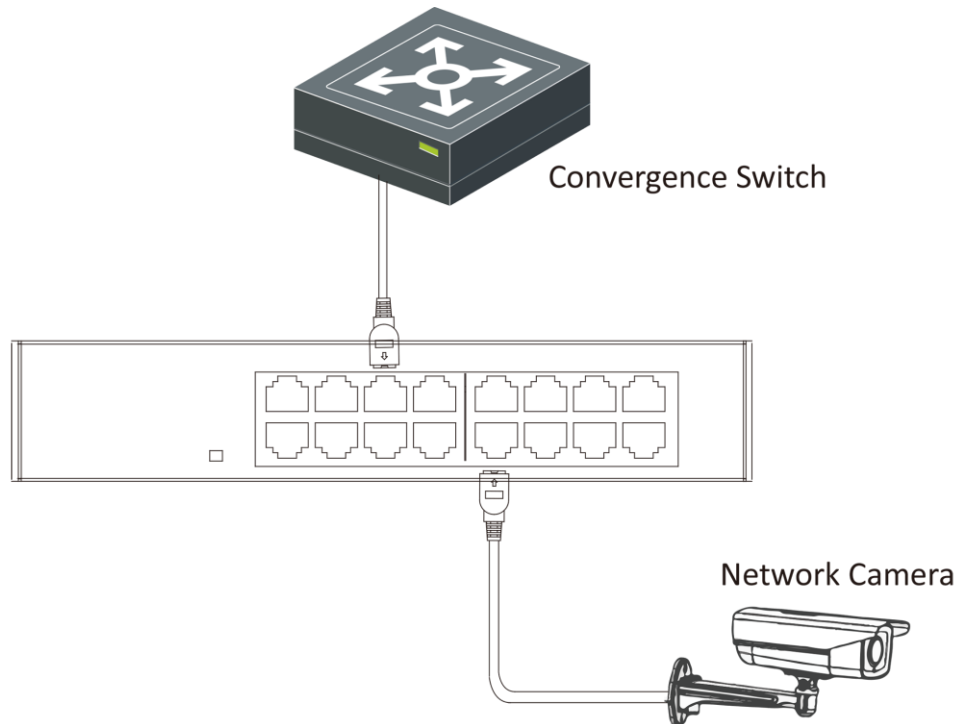

Figure 3-1 RJ45 Port Connection

### 3.2 Checking the Cabling

Before powering on your switch, make sure that:

- The operating power supply is compliant with rated input standard.
- Port cables and grounding cables are correctly connected.
- If there is outdoor cabling, connect a lightning rod and lightning arrester to the cable.

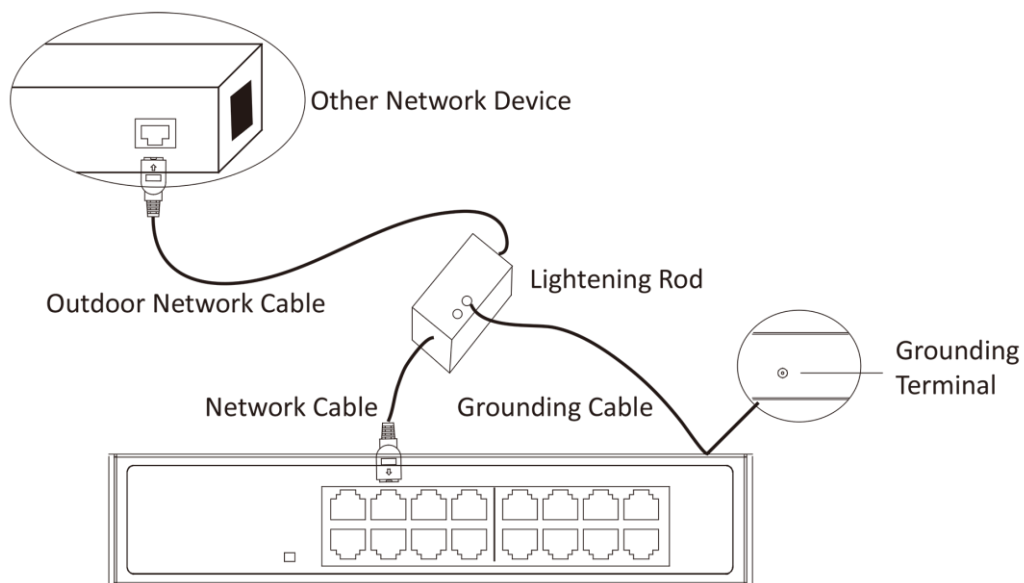

Figure 3-2 Lightning Rod Connection

### 3.3 Powering on Switch

Please use the attached power cord to provide power to the switch.



See Far, Go Further