

Hisense

USER MANUAL

Before using the TV, please read this manual thoroughly and retain it for future reference.

ENGLISH

FRANÇAIS

ESPAÑOL

Hisense

USER MANUAL

Before using the TV, please read this manual thoroughly and retain it for future reference.

Copyright Statement

© 2018 Hisense Company Ltd. All Rights Reserved.

All material in this User Manual is the property of Hisense Company Ltd. and its subsidiaries, and is protected under US, CANADA, MEXICO and International copyright and/or other intellectual property laws. Reproduction or transmission of the materials, in whole or in part, in any manner, electronic, print, or otherwise, without the prior written consent of Hisense Company Ltd. is a violation of Hisense Company Ltd. rights under the aforementioned laws.

No part of this publication may be stored, reproduced, transmitted or distributed, in whole or in part, in any manner, electronic or otherwise, whether or not for a charge or other or no consideration, without the prior written permission of Hisense Company Ltd.

Requests for permission to store, reproduce, transmit or distribute materials may be made to one of the following addresses:

USA: Hisense USA Corporation
7310 McGinnis Ferry Road
Suwanee, GA 30024

CANADA: Hisense Canada Co., Ltd
2283 Argentia Road, Unit 16
Mississauga, ON, Canada
L5N 5Z2

MEXICO: Hisense Mexico S. de R.L. de C.V.
Blvd. Miguel de Cervantes Saavedra No 301
Torre Norte Piso 2, Col. Ampliación Granada
Miguel Hidalgo, Ciudad de México, C.P. 11520

Hisense, and any and all other Hisense product names, logo's, slogans or marks are registered trademarks of Hisense Company Ltd. and its subsidiaries. All other trademarks are the property of their respective holders.

©2018. All rights reserved. Hisense and the Hisense logo are registered trademarks of Hisense. Other brand and product names are registered trademarks of their respective owners.

Disclaimer Page

**Notwithstanding anything to the contrary, including in any or all descriptions, representations, statements or other communications related to this Hisense device (hereinafter "Device") made in any form whatsoever and at any time, some or all of the pre-installed, or subsequently installed Application Services may not be available or capable of functioning as intended by the provider of the Application Services in any or all usage areas for reasons outside of Hisense's control, including but not limited to, Internet access, local service limitations, etc. Any purchase or use of the Device, including any Application Services, is purely at the user's risk. Application Services are provided on an as-available basis without warranties of any kind, either expressed or implied, that the Application Service will be uninterrupted or error-free, including but not limited to vagaries of weather, disruption of Service, acts of God, warranties of title, local or regional limitations, no infringement, NOR IMPLIED WARRANTIES OF MERCHANTABILITY OR FITNESS FOR A PARTICULAR PURPOSE. No advice or information given by Hisense, providers, affiliates, or contractors or their respective employees shall create such a warranty. Hisense specifically disclaims responsibility for any or all Application Services from functioning at any time, and by purchasing the Device, you accept such disclaimer without any claim on Hisense. You are solely responsible for providing an active and working connection to the Internet, along with any and all hardware and/or software necessary to use the Hisense Device as intended.

Disclaimer:

Images throughout this document are for illustrative purposes only and may differ from the actual product.

Content

| | |
|---|-----------|
| Content | 3 |
| Connecting Devices to your TV | 6 |
| Connecting an antenna, cable set-top box or satellite receiver | 6 |
| Connecting a satellite receiver, DVD player or other audio visual (AV) devices with a composite video cable (yellow/red/white)..... | 6 |
| Connecting an AV device with an HDMI cable..... | 7 |
| Connecting a headphone | 7 |
| Connecting a USB device..... | 8 |
| Connecting speakers or other audio receivers..... | 8 |
| Connecting a digital sound bar to use Audio Return Channel (ARC)..... | 9 |
| Connecting Your TV to a Wireless or Wired Network..... | 10 |
| Connecting to a wireless network | 10 |
| Connecting to a wired (Ethernet) network..... | 10 |
| Using Your TV Remote Control..... | 12 |
| Buttons on your TV remote..... | 12 |
| Remote control range information..... | 12 |
| Begin using your remote | 13 |
| Pairing the Remote Control | 13 |
| Other | 14 |
| Completing the First-Time Setup Menu | 15 |
| Shortcuts Instructions..... | 17 |
| Turning your TV on or off..... | 17 |
| Using the Live TV | 17 |
| Using shortcuts | 18 |
| Home | 19 |
| Getting familiar with the Home screen..... | 19 |
| Menu..... | 20 |
| Using the Menu | 20 |
| Picture | 20 |
| Sound..... | 21 |
| Channels..... | 22 |
| Parental Controls..... | 22 |
| Audio Only | 24 |

| | |
|--------------------------|----|
| TV Captions | 24 |
| Audio Language(MTS)..... | 24 |
| Sleep Timer | 24 |
| Settings | 24 |
| Help..... | 24 |

Settings.....25

| | |
|--|----|
| Network..... | 25 |
| Inputs | 25 |
| Picture / Sound / Apps / Help / Parental Controls..... | 25 |
| Alexa Voice Control..... | 25 |
| Google Cast | 25 |
| Screen saver | 26 |
| Use Mode..... | 26 |
| Wake Up | 26 |
| Setup Wizard..... | 26 |
| Storage & reset | 26 |
| About..... | 26 |
| Date & time | 26 |
| Timer | 26 |
| Language | 26 |
| Keyboard | 27 |
| Home screen..... | 27 |
| Google | 27 |
| Accessibility | 27 |
| RS232 Control | 27 |
| Add accessory..... | 27 |
| Location | 27 |
| Security & restrictions | 27 |
| Usage & Diagnostics | 28 |
| Add account | 28 |

Apps.....29

| | |
|---------------------------------------|----|
| Installing an App | 29 |
| Removing an App | 29 |
| Moving App Icons around..... | 29 |
| Customizing the name of your TV | 29 |

Media.....30

| | |
|---|----|
| Panels that appear on the Media screen..... | 30 |
| File formats that may be supported | 30 |

Browsing Content.....30

Viewing Pictures as a Slideshow.....30

Viewing Video30

Edit30

Using Anyview Cast to mirror content from your device to the TV screen.....31

Software updates for your TV.....31

Quick Problem-Solving Tips32

Connecting Devices to your TV

You have several options for connecting your TV to different devices. The method you choose will be based upon the type of cables you have and the available outputs on your device.

Connecting an antenna, cable set-top box or satellite receiver

To connect an antenna, cable set-top box or satellite receiver:

1. Connect one end of a coaxial cable (not included) to the **RF OUT** port on the antenna, cable or satellite box. If you are using an antenna with twin-lead cable, you may need a 300-75 Ohm adapter (not provided) to connect it to the back of your TV. Likewise, if you are using several antennas, you may need a combiner (not provided).
2. Connect the other end of the cable to the **ANT/CABLE** port on the side of TV.
3. Using your remote, select the  Inputs icon in Home screen and select **Channels** as the input source.

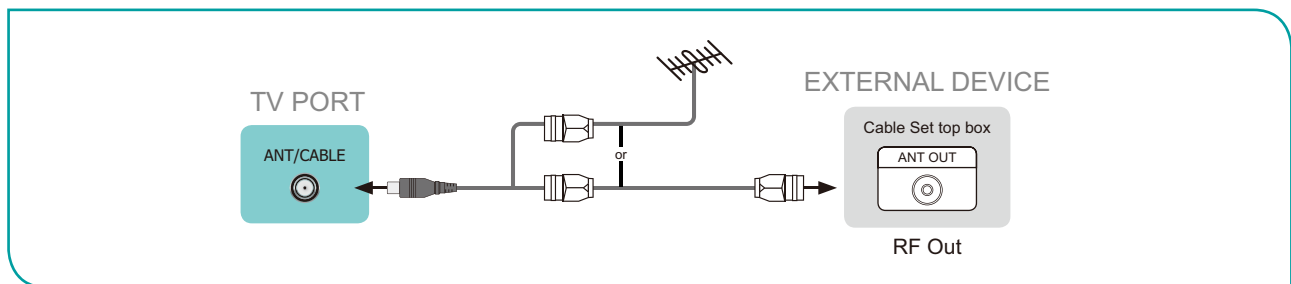

Connecting a satellite receiver, DVD player or other audio visual (AV) devices with a composite video cable (yellow/red/white)

To connect an AV device with a composite video cable (not provided):

1. Use the audio and video cables to connect the composite video/audio ports of the external AV device to the **AV IN** ports of the TV. (Video = yellow, Audio Left = white, and Audio Right = red)
2. Plug the connected devices into the AV connectors on the TV before switching it on.
3. Using your remote, select the  Inputs icon in Home screen and select **Composite** as the input source.

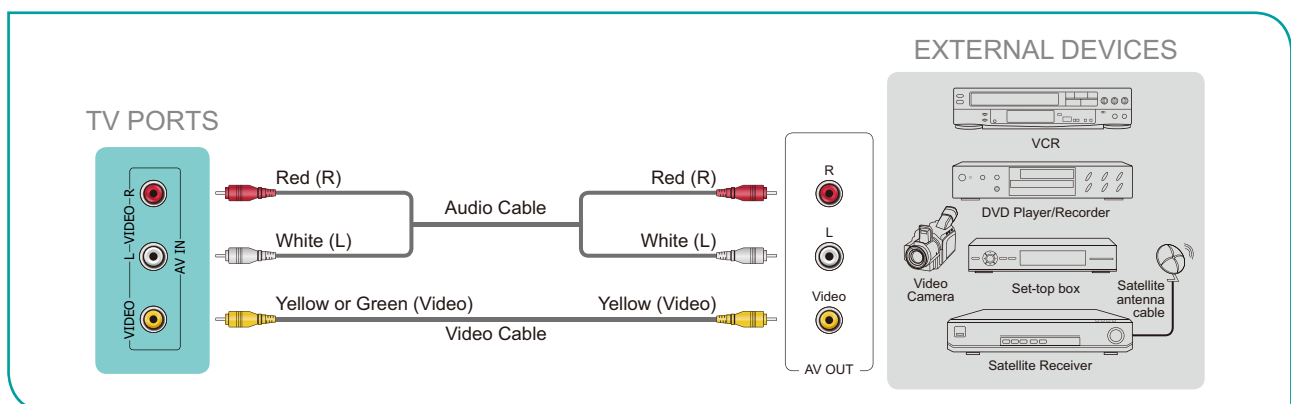

Connecting an AV device with an HDMI cable

This 4K TV has three high-powered HDMI version 2.0 inputs that enable you to connect 4K Ultra-HD external devices. For example, if you have an X-box or Blu-ray player that supports the 2.0 standard, more details will be transmitted to the TV screen to maximize your entertainment experience.

Please refer to the User Manual that came with your device for step-by-step instructions.

To connect an AV device with an HDMI cable (not provided):

1. Use an HDMI cable to connect the HDMI output port of the AV device to the **HDMI** port of the TV.
2. Plug the connected devices into the **HDMI** port on the TV before switching it on.
3. Using your remote, select the  Inputs icon in Home screen and select the corresponding **HDMI** input.

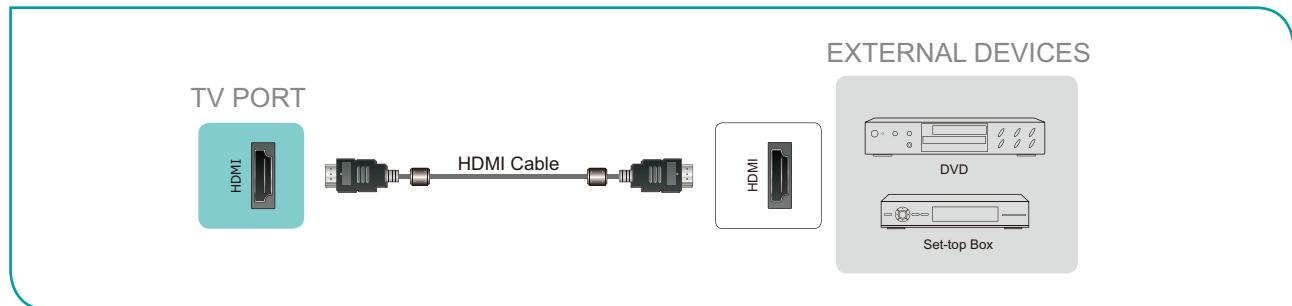

NOTES

- Because the HDMI connector provides video and audio signals, it is not necessary to connect an audio cable.
- We strongly recommend to use HDMI Cable with 2 cores as shown in the figure.

Connecting a headphone

You can connect headphone (not provided) to the **AUDIO OUT** port on your TV. While the headphone is connected, the sound from the built-in speakers will be disabled.

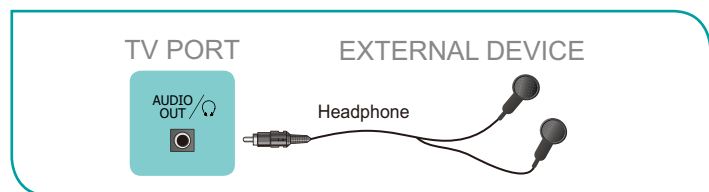

NOTES

- Headphones with microphones are not supported.
- If "Headphone with Speakers" in the sound menu is selected manually, the headset and the whole machine will have sound at the same time.

Connecting a USB device

You can connect the USB devices such as hard drives, USB sticks and digital cameras for browsing photos, listening to music and watching recorded movies.

1. Connect a USB device into the **USB** port.
2. Select the Media type on the **Media** screen. For more information, see [Media on page 30](#).

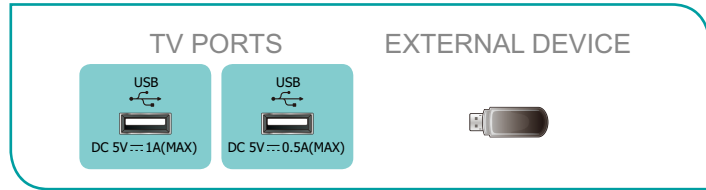

NOTES

- When connecting a hard disk or a USB hub, always connect the mains adapter of the connected device to the power supply. Exceeding a total current consumption may result in damage. The USB1.1 and USB2.0 devices maximum current consumption are 500mA.
- For individual non-standard high-capacity mobile hard disk, if its impulse current is greater than 500mA, it may cause TV-rebooting or self-locking. So the TV does not support it.
- The USB port supports a voltage of 5V.

Connecting speakers or other audio receivers

To connect speakers or other audio receivers with an audio cable (not provided):

1. Use an audio cable to connect the digital audio in port of the audio receiver device to the **DIGITAL AUDIO OUT** port of the TV. Another option is to use an RCA Y-cable (1/8"-stereo mini to L/R phono) to connect an analog sound system to the **AUDIO OUT** port of the TV.
2. Plug the connected devices into the main power socket before switching on the TV..

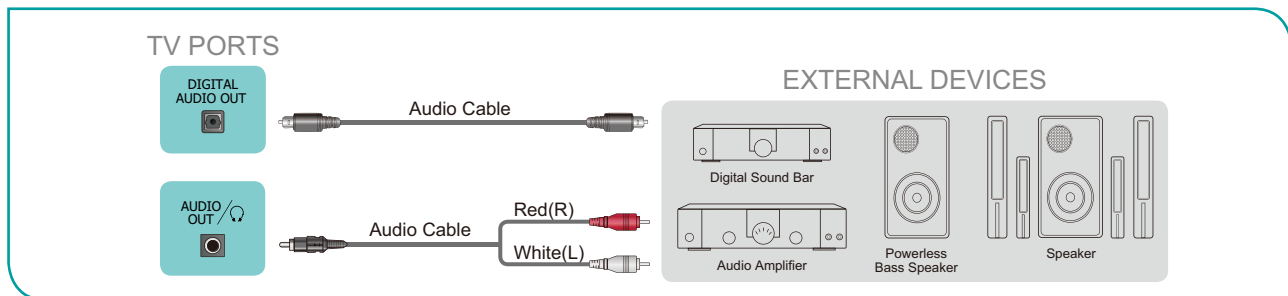

TIP: If you prefer to use Audio Return Channel, then see [Connecting a digital sound bar to use Audio Return Channel \(ARC\) on page 9](#).

NOTES

- When a digital audio system is connected to the **DIGITAL AUDIO OUT** port, decrease the TV and system volume.
- You can connect the **DIGITAL AUDIO OUT** port on the back of the TV to the Optical port on the Amplifier. Then go to the **Settings / Menu > Sound > Advanced Audio > Digital Audio Out** to select **Dolby Digital** to receive the Dolby Digital audio.

Connecting a digital sound bar to use Audio Return Channel (ARC)

If you'd like to use the Audio Return Channel (ARC) feature to have sound sent from the TV back down an HDMI cable to a digital sound bar, then you will need to connect the cable to the **HDMI / ARC** port. By using this feature, you will also be able to control the sound bar with your TV remote instead of using multiple remotes for each device.

To connect a digital sound bar with an HDMI cable (not provided):

1. Connect the cable that's attached to the sound bar to the **HDMI / ARC** port on the TV.
2. Turn on the sound bar by pressing the Power button.
3. Press the **[O]** button on your remote and select the **Settings** icon, then go to **Sound > Speaker**.
4. Select the **ARC** option.

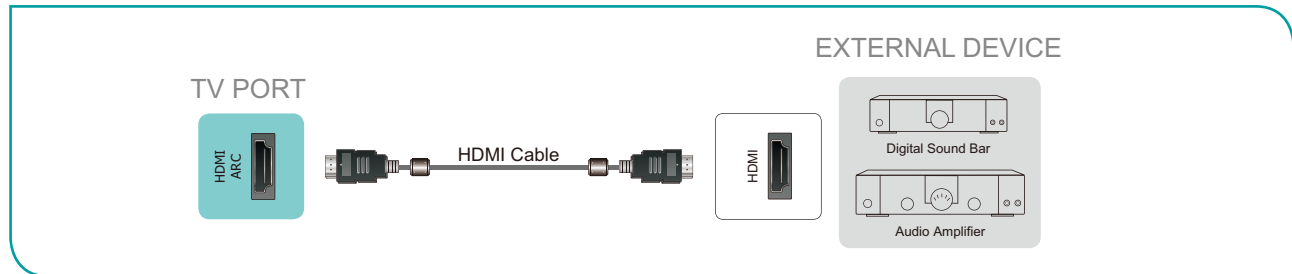

NOTES

- Only digital sound bars that require a wired connection are compatible with the TV.
- If the device has an Input Selector feature then make sure to change it to TV.
- 5.1 CH (channel) audio is available when the TV is connected to an external device that supports a 5.1 channel surround sound. You can go to the **Settings / Menu > Sound > Advanced Audio > Digital Audio Out** to select **Dolby Digital Plus** to receive the 5.1 channel audio. You will need to also go into the sound or audio settings of your device to ensure it is set to 5.1 Channel output. It may read 'Bitstream', 'RAW' or 'Digital'.

Connecting Your TV to a Wireless or Wired Network

You have the option to connect your TV to a wireless or wired network to access the Internet. For more information about the network settings on TV, see [Network on page 25](#).

Connecting to a wireless network

Our built-in wireless LAN adapter supports the IEEE 802.11 ac/b/g/n communication protocols and we recommend that you use an IEEE 802.11n or IEEE 802.11ac router. When you play a video over an IEEE 802.11 b/g connection, the video may not play smoothly.

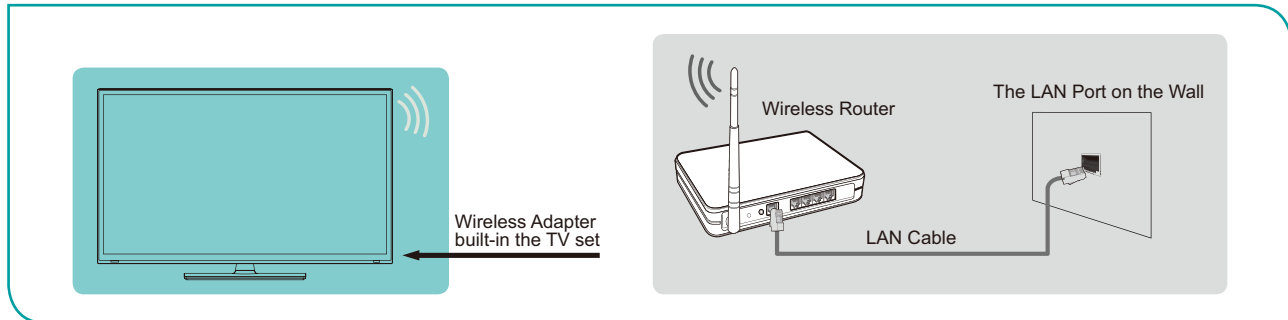

NOTES

- You must use the built-in Wireless LAN Adapter to use a wireless network because the set does not support an external USB network adapter.
- To use a wireless network, your TV must be connected to a wireless IP sharer. If the wireless IP sharer supports Dynamic Host Configuration Protocol (DHCP), your TV can use a DHCP or static IP address to connect to the wireless network.
- Select a channel for the wireless IP sharer that is not currently being used. If the channel set for the wireless IP sharer is currently being used by another device nearby, this will result in interference and communication failure.
- If you apply a security system other than the systems listed below, it will not work with the TV.
- If Pure High-throughput (Greenfield) 802.11N mode is selected and the Encryption type is set to WEP, TKIP or TKIP-AES (WPS2 Mixed) for your Access Point (AP), then the TV will not support a connection in compliance with these Wi-Fi certification specifications.
- If your access point (AP) supports Wi-Fi Protected Setup (WPS), you can connect to the network via Push Button Configuration (PBC) or PIN (Personal Identification Number). WPS will automatically configure the SSID and WPA key in either mode.

Connecting to a wired (Ethernet) network

You can attach your TV to your LAN in one of the three following ways:

Option 1

You can attach your TV to your LAN by connecting the **LAN** port on the back of your TV to an external modem using a Cat 5 LAN cable. See the illustration below.

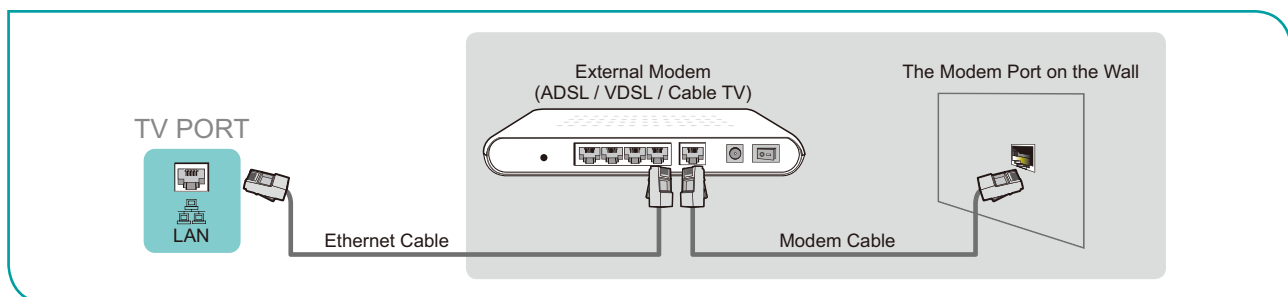

● Option 2

You can attach your TV to your LAN by connecting the **LAN** port on the back of your TV to an IP Sharer which is connected to an external modem. Use an Ethernet cable for the connection. See the illustration below.

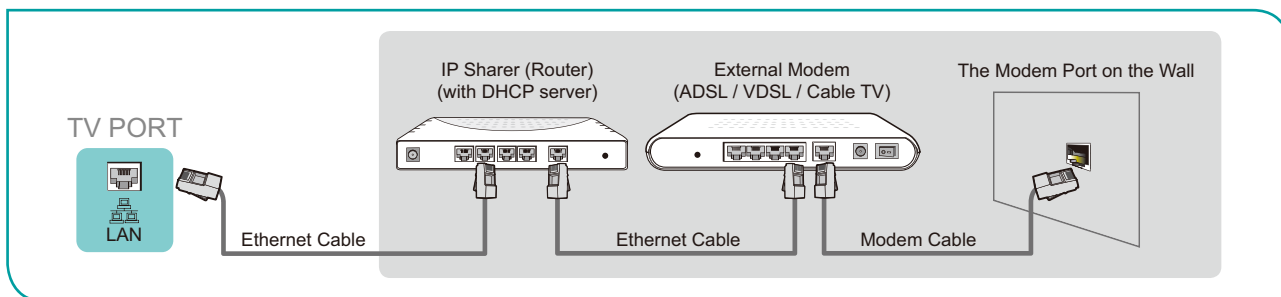

● Option 3

Depending on how your network is configured, you may be able to attach your TV to your LAN by connecting the **LAN** port on the back of your TV directly to a network wall outlet with an Ethernet cable. See the diagram below.

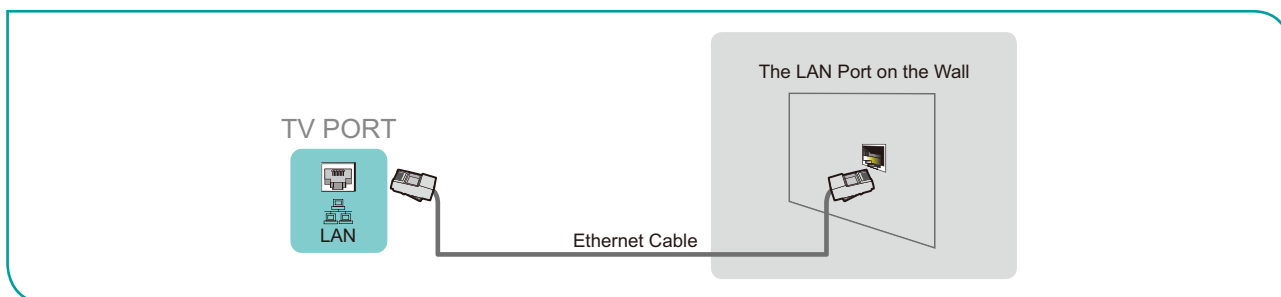

If you have a Dynamic Network, you should use an ADSL modem or router that supports Dynamic Host Configuration Protocol (DHCP). Modems and routers that support DHCP automatically provide the IP address, subnet mask, gateway, and DNS, so you don't have to enter them manually. Most home networks are Dynamic Networks.

Some networks require a Static IP address. If your network requires a Static IP address, you must enter the IP address, subnet mask, gateway, and DNS values manually on your TV's Cable Setup Screen when you set up the network connection. To get the IP address, subnet mask, gateway and DNS values, contact your Internet Service Provider (ISP).

☑ **NOTE**

- You can use ADSL modems that support DHCP if your network requires a static IP address. ADSL modems that support DHCP also let you use static IP addresses.

Using Your TV Remote Control

Buttons on your TV remote

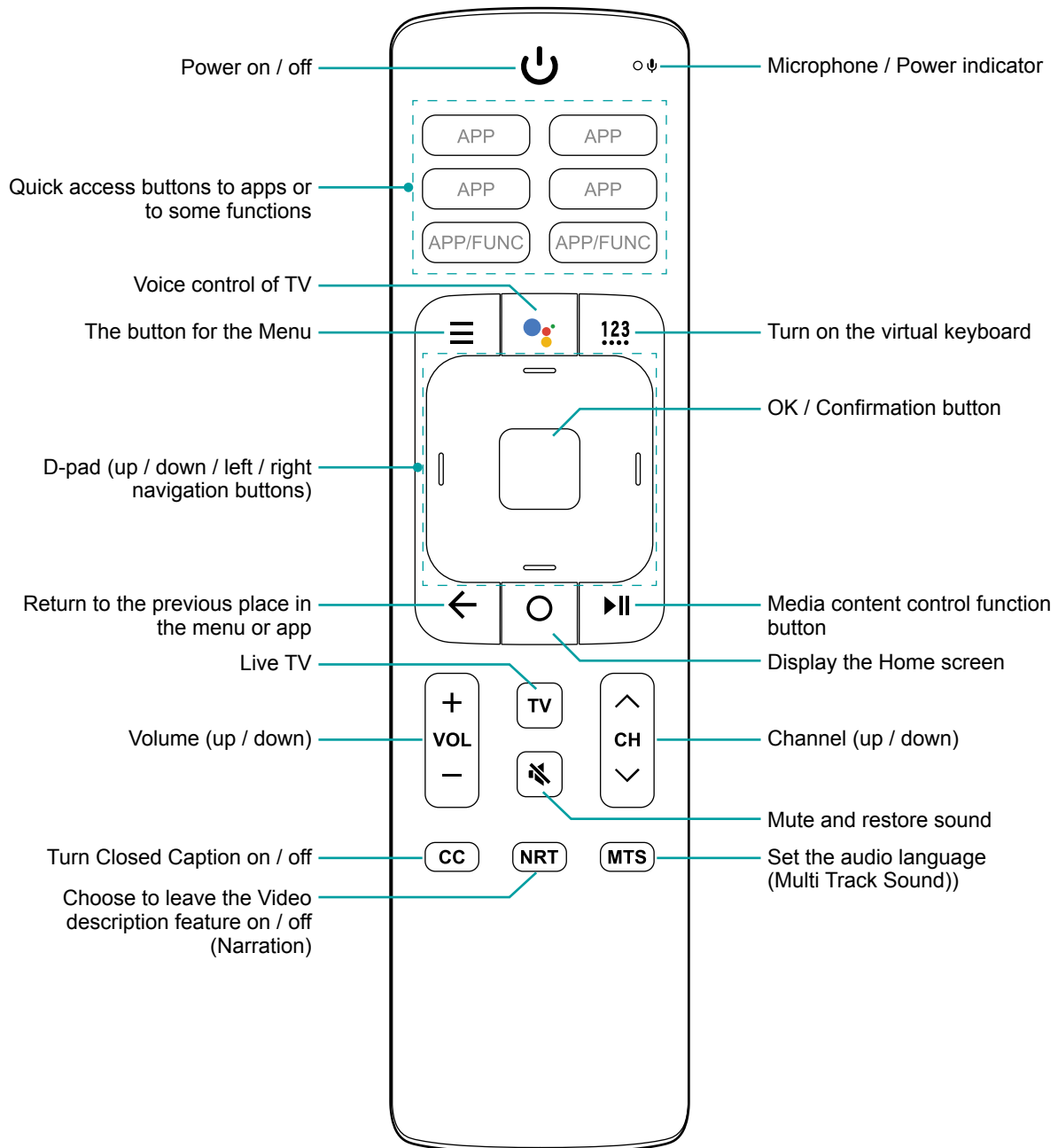

NOTE

- The buttons are only for reference, actual remote may vary in appearance.

Remote control range information

- The remote control can work at a distance of up to 26 feet in front of the TV set.
- It can work at a 30 degree horizontal or vertical angle.

Begin using your remote

- Slide the back cover to open the battery compartment of the remote control.

1

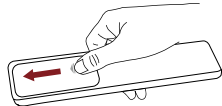

Gently push and slide

2

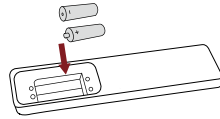

Insert the batteries

3

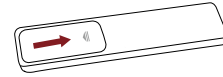

Gently push and slide

- Insert two AAA size batteries. Make sure to match the (+) and (-) ends of the batteries with the (+) and (-) ends indicated in the battery compartment.
- Replace the battery compartment cover.

NOTES

- Discard batteries in a designated disposal area. Do not throw them into a fire.
- Remove old batteries immediately to prevent them from leaking into the battery compartment.
- If you do not intend to use the remote control for a long time, remove the batteries.
- Battery chemicals can cause a rash. If the batteries leak, clean the battery compartment with a cloth. If chemicals touch your skin then wash it immediately.
- Do not mix old and new batteries.
- Do not mix alkaline, standard (carbon-zinc) or rechargeable (NiCd, NiMH, etc.) batteries.
- Do not continue using the remote if it gets warm or hot.
- Call our Support Center immediately on the support website.

Pairing the Remote Control

- Pair the remote to the TV after you power it on. Keep the remote control within 20 feet from the TV. Press and hold the **[≡]** button at least 3 seconds to start pairing.
- If the remote paired successfully then a confirmation will display on the screen. If it did not pair successfully then an 'unsuccessful' message will display. Repeat step 1.

NOTES

- If an unknown error occurred with the remote then it could have been caused by interference. Try to remove what's causing the interference and pair it again.
- If an unknown error occurred in the remote control while the battery power is normal, you can take out the batteries and press any key for 1~2 seconds, then the remote control can work normally.
- The remote cannot be paired to the TV while the TV is in standby mode.

Other

Program your universal cable or satellite remote control to operate your new television (only for USA)

If you would like to program your other household remote controls to your new television, please refer to the User's Manual supplied by your Cable or Satellite provider. The Cable or Satellite providers' User's Manuals should include instructions on how to program their remote to your television.

A list of codes for the most common Cable and Satellite providers are listed below. Use the code that is associated with your Cable or Satellite provider (if applicable).

DIRECTV

0178, 10178, 10019, 10748, 11314, 11660, 11710, 11780, 12049, 10171, 11204, 11326, 11517, 11564, 11641, 11963, 12002, 12183

Time Warner Cable

386, 0178, 10178, 400, 450, 461, 456, 0748, 1463, 0463, 10463

Comcast

0178, 10178, 10463, 11463, 10748, 11314, 11660, 10171, 11204, 11326, 11517, 11641, 11780, 11785, 11892, 11963, 12002

Cox Communications

0178, 10178, 1326, 1463

Dish Network

505, 627, 538, 720, 659

If the code associated with your Cable or Satellite provider is not listed, does not work or you cannot locate the instructions to program your remote, call your local Cable or Satellite provider's customer service center.

If your Cable or Satellite provider does not have a code available, please contact us.

Using your cable set-top box or satellite receiver remote as a 'universal' remote

If you prefer to use your Cable Set-top Box or Satellite Receiver Remote as a 'Universal Remote', then visit the Support page to view a list of the codes.

Completing the First-Time Setup Menu

Press the [] button on the remote to turn on the TV.

After the splash screen that displays the logo appears, begin the first-time setup menu.

| Screen | Task |
|--|---|
| Welcome | Using the D-pad arrows of your remote, choose your Language . |
| End User License Agreement | Choose Accept or View Hisense End User License Agreement . |
| Set up your TV with an Android phone or tablet? | Choose Yes or Skip. |
| Select your Wi-Fi network | If your TV does not automatically detect an Ethernet connection, then use a wireless network. Select your network from the list that displays, input the password. Also you can add a hidden network. |
| Terms of Service | Choose Accept or view these services. |
| Location | Choose Yes or No. |
| Help improve Android performance | Choose Yes or No. |
| Choose a name for your TV | Choose a name for your TV or enter custom name. |
| Select your country | Using the D-pad arrows of your remote, choose your country. |
| Select your time zone | Using the D-pad arrows of your remote, choose your time zone. |

| Screen | Task |
|--------------------------|---|
| Register your TV | Registering helps keep your product humming with software updates, product support and our warranty. |
| Setup is Complete | <ul style="list-style-type: none">• Select Home Mode (which appears by default). <p> NOTE</p> <ul style="list-style-type: none">• Store Mode and Store Mode (Video Demo Only) should only be selected by Retailers who plan to demonstrate the TV. |

Shortcuts Instructions

You can use shortcuts on the remote control for fast operation.

Turning your TV on or off

- To turn your TV on:
 1. Connect the power cord to the back of the TV, then plug the power cord into an AC outlet.
 2. When the TV is powered on, press the **[⏻]** button on the remote to turn on TV.
- To turn your TV off, press the **[⏻]** button on the remote.

NOTES

- When your TV is in standby mode, it is still consuming power. To completely disconnect power, please remove the plug from the AC outlet.
- If your TV does not receive an input signal for several minutes, it automatically goes into standby mode.

Using the Live TV

To view broadcast programs, press the **[TV]** button on your remote.

Channel search guide

When you select **Channels** as input, if no TV channels were saved before, you will be prompted to do a channel search. You can also go to **Menu > Channels** to change the channel settings.

Launch Live TV

After channel scanning is done for the first time, the screen will display LiveTV operating tutorial, including: how to Load info Bar, how to load the channel list and so on.

[Up] Load info bar

[OK] Load channel list

[≡] Load onscreen menu

[←] Jump to previous channel

Viewing channel information

As you use the **[CH ^ / ∨]** button on your remote to scroll through channels, an information banner appears on the top of the screen.

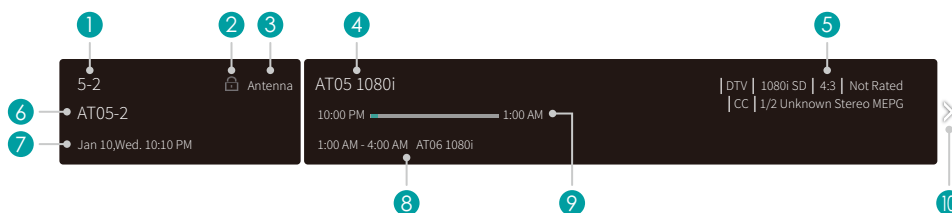

The information banner displays the following information:

1. Channel number
2. Lock status
3. Input
4. Program name
5. Show identification

6. Channel name
7. Current date and time
8. Beginning and end time of the next program
9. Start/Stop time progress bar of the current program
10. Prompt

If you are watching a particular channel, you can also press the **[Up]** button of your remote to view channel information.

Viewing a channel list

After you have done an automatic channel scan (if you're using an antenna) or receiving your channels through a cable provider, you can view your list of channels by pressing **[OK]** on your remote.

You will see the channel list display on the right side of the screen.

Creating a Favorite List

To quickly access your most-watched channels, you can create a Favorite List in one of two ways.

- The first way is to create your Favorite List in Menu:
 1. Press the **[≡]** button to access the **Menu** in Channels source.
 2. Select **Channels > Favorite List**.
 3. Using the **[Up / Down]** buttons of your remote, select a channel and press **[OK]** button.
- The second way is to create your Favorite List in channel list:
 1. Press the **[OK]** button to call out the channel list in Channels source.
 2. Select a channel and add it by using the **[!?#]** button. About the details of how to use the **[!?#]** button, you can see [Virtual keyboard on page 18](#).

A heart-shaped indicator will appear beside the channel as confirmation that it has been successfully added.

Viewing your Favorite list

To view channels that you've added to your Favorite List simply press **[OK]** on your remote to call out the channel list.

The channel list appears on the right side of the screen and heart-shaped icons are shown next to the channels that make up your Favorite List. You can press the **[Left / Right]** buttons to switch the channel list (**Antenna** or **Cable**), **Favorite** and **History** list.

Using shortcuts

Google Assistant

You can press the **[🗨]** button to turn on your Google Assistant, use your voice to ask it questions, tell it to do things.

Virtual keyboard

You can call out the numeric virtual keyboard by pressing **[!?#]** button. Then press the **[Up / Down]** buttons to switch between the Number pad and the Special function (Red / Green / Yellow / Blue) buttons.

You can press **[▶||]** button to call out the media content control function virtual keyboard. And you can Play / Pause / Fast backward / Fast forward / Stop playback the media content by using this keyboard.

Closed Caption (CC)

You can switch among OFF, ON and CC ON when mute.

Narration (NRT)

You can switch between Video Description On and Video Description Off.

Audio Language (MTS)

You can choose the audio language in DTV mode and you can set MTS for Mono, Stereo or SAP in ATV mode.

Home

Getting familiar with the Home screen

The simple design of the **Home** screen menu makes it easy to navigate. It serves as the central location to access **Notifications, Apps, LiveTV, Inputs, Media** and **Settings**.

To access the Home screen, press the [**O**] button on your remote control and use the D-pad to make your selection.

Indicators and Icons on the top of the Home screen

- **Google Search:** You can search movies, TV, and more by speaking or typing.
- **Notifications:** Notifications can come from the system, an external device, an application, the media player etc.
- **Inputs:** Select the Input source depending on the device you have connected to your TV.
- **Settings:** Settings lets you configure the TV, set app options, add accounts, and change other preferences.
- **Time:** You can always view the current time at the top right corner of the Home screen.

If your TV is connected to the Internet through a wireless connection, then an icon  will display at the top right corner of the screen. This location makes it very convenient for you to determine if you still have Internet connectivity as you use the TV.

Names of sections that appear on the Home screen

The Home screen displays the following section names:

- **Apps**
- **Live TV**
- **Feature Apps**
- **Media**

Menu

Your TV comes with many TV setting features to allow you to customize the picture based on your viewing preference and environment. As you navigate throughout different screens to access settings, some of the indicators appear as words On and Off.

Using the Menu

You can press the [] button to access the **Menu** in TV mode.

The **Menu** consists of the following settings:

- **Picture**
- **Sound**
- **Channels**
- **Parental Controls**
- **Audio Only**
- **TV Captions**
- **Audio Language(MTS)**
- **Sleep Timer**
- **Settings**
- **Help**

In each menu, you can:

- Press the [**Up / Down**] buttons to select an item.
- Press the [**OK**] buttons to enter the sub-menu or to set on or off.
- Press the [**Left / Right**] buttons to adjust the value.
- Press the [**←**] button to return to the previous menu.

Picture

- **BackLight:** Adjust Local Dimming, Backlight Level, Automatic Light Sensor and Minimum Backlight to change the overall brightness of the screen.
 - **Local Dimming:** Enable the TV to automatically adjust the backlight by sections according to the changes in the image and increase the contrast.

NOTE

- Some models don't support this function.
- **Backlight level:** Adjust how bright you want images to appear, lower settings create darker images.
- **Automatic Light Sensor:** Enable the TV to automatically adjust the picture settings according to the amount of ambient light in your room.
- **Minimum Backlight:** Adjust the lower point of the dynamic backlight adjustment scope. This is a money-saving feature because it reduces power consumption.
- **Picture Mode:** If you'd like to configure the settings for your picture, then there are seven types of picture modes available: **Vivid**, **Standard**, **Energy Saving**, **Theater**, **Game**, **Sport** and **Calibrated**.

Once you choose the mode, you can adjust the picture based on the following settings:

- **Contrast:** Adjust the Contrast level to increase or decrease how bright images appear.
- **Brightness:** Adjust the Brightness level to generate lighter or darker images.
- **Color:** Adjust the color intensity of the picture for a more vibrant image.
- **Tint:** Adjust the colors from a green to magenta tint to view the natural skin tones of people on the screen.
- **Sharpness:** Adjust how sharp or soft edges of images appear.

- **Advanced Settings:** Adjust advanced picture settings based on your viewing preference.
- **Overscan:** Change the video size settings to slightly crop the edges of the displayed image.
- **Color Temp:** Select a preset color temperature. Adjust how warm(red) or cool(blue) the white areas of an image appears.
- **Motion Enhancement:** This setting minimizes afterimages that are left on the screen when viewing fast-moving objects. You can adjust it from Off, Custom, Film, Clear, Standard or Smooth. A Smooth setting will produce a smoother picture whereas a Clear setting will result in a picture that has less judder (shaking).

NOTE

- Some models don't support this function.
- **Digital Noise Reduction:** Improve how clear the picture appears by reducing noise.
- **HDMI Dynamic Range:** Adjust the HDMI signal range to be more suitable for the content. (HDMI mode only)
- **Active Contrast:** Automatically darken dark areas and lighten light areas of images to see more details.
- **Color Space:** Change the range of colors the TV displays.

NOTE

- Some models don't support this function.
- **Expert Settings:** Adjust the color space and Gamma to best suit the content you're viewing.
- **Color Tuner:** Adjust the Hue, Saturation and Brightness of color settings.
- **White Balance:** Adjust the intensity of red, green and blue lights to view the true colors of all images in the picture.
- **Gamma Adjustment:** Adjust the Gamma to choose how the TV will respond to the content grayscale. In a dark room choose a Higher number like 2. In a brighter area select a Lower number like 0. In general, 1 is normally recommended.

NOTE

- Some models don't support this function.
- **Gamma Calibration:** Adjust selected Gamma curve.
- **RGB Only Mode:** View images based on default settings or choose the color red,blue or green.
- **Aspect Ratio:** Adjust the Aspect Ratio to stretch or zoom in on your picture. You can choose from the following settings: **Auto, Normal, Zoom, Wide, Direct, Dot-By-Dot, Panaramic** or **Cinema**.
- **HDMI 2.0 Format:** Match the connected device output format. You can select **Standard format** and **Enhanced format** in HDMI mode. Enhanced format for devices of 4K@50/60Hz (YCbCr4:4:4, YCbCr4:2:2).
- **Apply Picture Settings:** Adjust current picture mode to apply to all sources or just current source.
- **Reset Picture Settings:** Reset current picture settings to factory mode.

Sound

- **System Sound:** S
- **Sound Mode:** Select a preset sound mode to suit the type of content you are listening to: **Standard, Theater, Concert Hall, Speech, Late night** and **Sports**.

Once you choose the mode, you can adjust the audio based on the following settings:

- **Speakers:** Select the speakers which you want to use: **TV Speaker, ARC, SPDIF,** or **BT Sound Bar**.
- **TotalSonics™ Total Sonics:** Optimizes overall sound quality by increasing bass, making dialog clear and natural, and widening the sound field.
- **TotalSurround™ Total Surround:** Provides surround sound experience with psycho-acoustic processing to place sounds beside, behind, and above the viewer. For best results use with Total Sonics.
- **TotalVolume™ Total Volume:** Maintains consistent loudness levels from wide dynamic range programs, loud commercials, and channel or input changes.
- **Wall Mount Setup:** Automatically optimize the sound based on the position of the TV.

- **Advanced Audio:** Tune the audio settings and quality of the TV.
 - **Balance:** Adjust the left and right speaker strength to optimize audio for a specific location.
 - **Digital Audio Out:** Select the digital audio output format that best suits the audio device type. For example, choose **Dolby Digital Plus** if you have an AV device which supports Dolby Digital Plus 5.1. Choose **PCM** if you have an amplifier that does not support Dolby Digital technology.

NOTE

- When connected the TV with optical, Dolby Digital Plus is not suggested.
- **Digital Audio Delay:** Adjust the digital audio output delay time to sync sound from an external speaker with the images on the TV.
- **Lip Sync:** Synchronize the displayed image with the audio output.
- **Equalizer:** Boost the volume at different frequencies.
- **Preferred Audio Language:** Set the default audio output language for the type of digital broadcast content that you're viewing.
- **Headphone Mode:** Disable the TV speaker when you are using a sound bar, ARC or any other external audio amplifiers.
- **Headphone Volume:** Change the way audio is sent through the type of device that's connected to your TV Audio Out port.
- **Reset Audio Settings:** Reset current audio settings to factory mode.

Channels

- **Tuner Mode:** Select if you receive TV channels over the air (antenna) or through a cable set top box.
- **Auto Channel Scan:** Automatically scan for channels.
- **Manual Channel Scan:** Type in a channel to add it manually to your TV.
- **Channel Skip:** Skip selected channels from your Channel List.
- **Favorite List:** Add Channels to your Favorite List.

Parental Controls

The Parental Controls setting allows you to block content that is not appropriate for children to watch.

Turning Parental Controls On

1. Go to **Locks**.
2. Press the **[OK]** button on your remote, a Create PIN window displays. Using the D-pad on your remote, create the password.
3. Press the **[OK]** button to turn the locks On.

You will see the other Parental Controls settings change from a greyed out state to highlighted. When this occurs, begin adding other settings to the **Block Time, Channel Block, Program Block, Input Block, App Block, Change PIN** or **Restore Parental Control Defaults** features.

- **Block Time:** Block all channels and programs during selected periods of time.
- **Channel Block:** Block selected channels.
- **Program Block:** Block programs by ratings. For more information about Ratings, See [Description of U.S. TV Ratings on page 23](#).
 - **Open V-Chip:** Turn this On to automatically block programs based on the US rating.
 - **Block Unrated:** Block or unblock unrated movies.
- **Input Block:** Block selected inputs.
- **App Block:** If an app that you want to restrict doesn't appear here then check the Parental Controls settings in the app.

- **Change PIN:** Change the PIN that you use to access Parental Controls.

 **NOTE**

- If you forget your password, call the **Consumer Electronics Care Center**.
- **Restore Parental Control Defaults:** Reset Parental Controls back to the factory setting.

Description of U.S. TV Ratings

| Content | Defined as |
|-----------|--------------------------|
| A | All |
| D | Suggestive dialog |
| L | Coarse or crude language |
| S | Sexual references |
| V | Violence |
| FV | Fantasy violence |

Description of Age-based Ratings

| Age | Defined as |
|--------------|-----------------------------|
| TV-Y | All children |
| TV-Y7 | Directed to older children |
| TV-G | General audience |
| TV-PG | Parental Guidance Suggested |
| TV-14 | Parents strongly cautioned |
| TV-MA | Mature Audiences Only |

US Movie Ratings

| Rating | Defined as |
|--------------|--|
| G | General audience |
| PG | Parental Guidance suggested |
| PG-13 | Parents strongly cautioned |
| R | Restricted |
| NC-17 | No one 17 and under permitted |
| X | A rating that has now been superseded by NC-17 |

Canadian English Ratings

| Rating | Defined as |
|------------|--|
| C | Children |
| C8+ | Children 8 years and older |
| G | General programming that is suitable for all audiences |
| PG | Parental Guidance |
| 14+ | Viewers 14 years and older |
| 18+ | Adult Programming |



Canadian French Ratings

| Rating | Defined as |
|---------------|---|
| G | General (appropriate for all ages and must contain little to no violence or sexual content) |
| 8ans+ | General but inadvisable for young children(could contain scenes disturbing to children under eight). Recommended for viewing with parent. |
| 13ans+ | Programming is appropriate for children 13 and older and may contain moderate violence, language and some sexual situations. |
| 16ans+ | Recommended for children 16 and older and may contain strong violence, language and sexual content. |
| 18ans+ | Programming intended for viewers that are 18 and older. Programming may contain extreme violence and graphic sexual content/pornography. |

NOTE

- All ratings that are higher than those you select are also blocked. For example, if you choose to block the PG-13 rating, then the higher ratings (R and NC-17) are automatically blocked too.

Audio Only

When you select this option, the screen will not display the picture. You can only listen the audio. Press any button except the [] button, [**VOL + / -**] buttons and [] button to restore operation.

TV Captions

- **Closed Caption:** You can switch between **OFF**, **ON** and **CC ON when mute** in Channel mode.
- **Analog Closed Caption:** Select an Analog Closed Caption setting from **Off**, **CC1-CC4**, **Text 1-Text 4**.
 - **CC1-CC4:** Closed Caption appears in a small banner across the bottom of the screen. CC1 is usually the “printed” version of the audio. CC2-CC4 display content provided by the broadcaster.
 - **Text1-Text4:** Closed Caption that covers half or all of the screen. Text1-Text4 display content provided by the broadcaster.
 - **Off:** To turn off the Analog Closed Caption.
- **Digital Closed Caption:** Select a Digital Closed Caption: **Off**, **Service1-Service6**.
- **Digital Caption Style:** There are two caption styles. One is the **As Broadcaster**, while the other is the **Custom** style where you can adjust the Font Size, Font Style, Font Color, Font Opacity, Background Color etc.

Audio Language(MTS)

You can choose the audio language in DTV mode and you can set MTS for **Mono**, **Stereo** or **SAP** in ATV mode.

Sleep Timer

Set the sleep timer to automatically turn the TV off within a specified time: off, 10 Minutes, 20 Minutes, 30 Minutes, 40 Minutes, 50 Minutes, 60 Minutes, 90 Minutes and 120 Minutes.

Settings

Settings lets you configure the TV, set app options, add accounts, and change other preferences. For more information about Settings, See [Settings on page 25](#).

Help

- **TV Information:** View system information, including: Serial Number, Serial Code, Software Version etc.
- **Signal Diagnosis:** Perform self diagnosis to test sound, picture and connections.

Settings

Network

- **Wi-Fi:** Turn on the Wi-Fi to access the Internet via a wireless network connection.
- **Connect via WPS:** If your access point (AP) supports Wi-Fi Protected Setup (WPS), you can connect to the network via Push Button Configuration (PBC) or PIN (Personal Identification Number). WPS will automatically configure the SSID and WPA key in either mode.
- **Add new network:** You can add wireless network.
- **Scanning always available:** Check to scan for networks even when Wi-Fi is turned off.
- **Anyview Stream:** Allow to view videos, images and music shared from another device in your network.
- **Not connected:** Configure network settings to connect to an available network.
- **Proxy settings:** Configure network settings to connect to an available network.
- **IP settings:** Configure the IP setting for your network connection.

Inputs

You can see the state of devices that the TV connected: Connected Input, Standby Input and Not connected Input.

Consumer Electronic Control (CEC)

- **HDMI control:** Allow the TV to control HDMI devices.
- **Device auto power off:** Power off HDMI devices with the TV.
- **TV auto power on:** Power on the TV with HDMI device.

NOTES

- HDMI cables must be used to connect HDMI CEC-compatible devices to your TV.
- The HDMI CEC feature of the connected device must be turned on.
- If you connect an HDMI device that is not HDMI CEC-compatible, all the HDMI-CEC Control features do not work.
- Depending on the connected HDMI device, the HDMI-CEC Control feature may not work.

Picture / Sound / Apps / Help / Parental Controls

See other chapters for more information about these settings. For example, for Picture settings, see [Picture on page 20](#).

Alexa Voice Control

Use your voice to control the TV, other smart home devices, and more.

- **Voice Service Control:** Turn on and off Alexa service.
- **Voice Control Setup:** Set up accounts to use Alexa service.
- **Setup Checklist:** Check the current settings of Alexa and guide the user to set up
- **Things to try:** Show the main functions that the Alexa can support currently.

Google Cast

Enables you to extend your app to direct its streaming video and audio to the TV. Your app becomes the remote control to play, pause, seek, rewind, stop, and otherwise control the media.

Screen saver

Enables Screen saver when the TV is idle.

Use Mode

Set the TV to use in Home or Store Mode (Some models have a Store Mode with 4K Video).

Wake Up

- **Wake on LAN:** An application on your second screen with Wake on Wired LAN will turn on your TV when you use the feature.
 1. Your TV and the device must in the same LAN.
 2. Click the screencast icon in the device's app (like YouTube). The device displays the ID of all available devices.
 3. Click on your TV name, the TV opens the app or casts the contents on the app to the TV.When the device casts the contents of app to the TV which in standby mode, the TV automatically boots.
- **Wake on Wireless Network:** An application on your second screen with Wake on Wireless will turn on your TV when you use the feature. (See "Wake on LAN" for more details.)

Setup Wizard

Use the Setup Wizard for instructions to help you set up your TV.

Storage & reset

You can view the TV storage and also you can reset to the factory data.

About

You can view the version information, the status of network, and other information. You can also update the software version or change the TV's name.

- **System update:**
- **Device name:**
- **Restart:**

Date & time

- **Automatic date & time:** Set the current time based on the network.
- **Set date:** Set the date.
- **Set time:** Set the time.
- **Set time zone:** Select your time zone.
- **Use 24-hour format:** Set the time to display in a 12 or 24-hour format.

Timer

- **Sleep Timer:** Set the sleep timer to automatically turn the TV off within a specified time: off, 10 Minutes, 20 Minutes, 30 Minutes, 40 Minutes, 50 Minutes, 60 Minutes, 90 Minutes and 120 Minutes.
- **Power on timer:** Set the clock for the time you want the TV to turn On automatically.
- **Power off timer:** Set the clock for the time you want the TV to turn Off automatically.

Language

Adjust the default Language settings for the TV.

Keyboard

Adjust the default Language settings for the keyboard.

Home screen

- **Customize channels:** Displays closed captions.
- **Enable video previews:** Enables broadcasted descriptive audio for visually impaired.
- **Enable audio previews:** Reads the menu items for visually impaired.
- **Reorder apps:** Improves contrast for visually impaired.
- **Reorder games:** Allow customization of spoken menu language.
- **Android TV Home:** Reads the menu items for visually impaired.
- **Android TV Core Services:** Improves contrast for visually impaired.

Google

Enables Screen saver when the TV is idle.

Accessibility

- **Captions:** Displays closed captions.
- **TV Captions:** Displays closed captions.
- **High contrast text:** Choose to leave the high contrast menu on or off.
- **Video Description:** Choose to leave the Video description feature on or off.
- **TalkBack:** Reads the menu items for visually impaired.
- **Switch Access:** Reads the menu items for visually impaired.
- **Kpad:** Reads the menu items for visually impaired.
- **Text to speech:** Reads the menu items for visually impaired.

RS232 Control

Enables Screen saver when the TV is idle.

Add accessory

Connect your Bluetooth devices (like a keyboard, a mouse, a soundbar etc.) to the TV.

Before you can use a Bluetooth device with your TV, you must first pair it.

1. Make the device you want to pair discoverable. See the documentation that came with your device to learn how to make it discoverable.
2. The TV displays the ID of all available devices in range.
3. Click the ID of the Bluetooth device in the list on your TV to pair with it.
4. Follow the prompts to complete the pairing.

Location

Your TV can use different modes to access location information. Each mode uses different sources to estimate the TV's location.

Security & restrictions

Enables Screen saver when the TV is idle. Create restricted profile

ENGLISH

FRANÇAIS

ESPAÑOL

Usage & Diagnostics

Enables Screen saver when the TV is idle.

Add account

You can use multiple Google Accounts on your TV. You may also be able to add other kinds of accounts, depending on your apps.

Apps

Numerous factory-installed apps are available for you to choose from for your entertainment preferences.

Installing an App

- To install an app from the **App Installer**:
 1. From the Home screen, click on the **Apps** to select the **App Installer** icon.
 2. Use the navigation buttons on your remote to select the app that you want to install.
 3. Press the **[OK]** button on your remote.

- To install an app from the **Opera TV**:

Even though your TV has numerous factory-installed apps, there may be others that you'd like to download.

1. From the Home screen, click on the **Apps** to select the **Opera TV** icon.
2. Navigate to the **SEARCH** tab.
3. Begin typing the name of the app. As you begin typing the first two to three letters the Opera Store suggests words to quicken your search time.
4. Use the navigation buttons of your remote to select the app. A page displays that shows a written description of the app.
5. Click on **OPEN** or **ADD TO FAVORITES**.

Removing an App

You can only delete apps that you've installed to the TV. Factory-installed apps can not be deleted.

To delete an app:

1. From the Apps screen, click on the **Uninstall** icon.
2. Use the navigation buttons on your remote to select the app that you want to remove.
3. Press the **[OK]** button on your remote. A dialog message displays that asks do you want to remove this app.
4. Click on **Uninstall**. A confirmation message displays and the icon is removed from the Apps list screen.

NOTE

- If an app is deleted, the information related to that app is also removed.

Moving App Icons around

Apps can not be moved around on the screen.

Customizing the name of your TV

If you have several TV's in your home then you may want to customize the name of your TV. By giving your TV a name, it will make it easier for you to identify it when connecting devices to the TV to stream or mirror content.

To customize the name of your TV:

1. Press the **[≡]** button on your remote.
2. Press the **[v]** button on the D-pad to select **Settings**, press **[OK]** button to enter the Settings menu.
3. Go to **System->Advanced Settings->TV Name**.
4. Select **User Input** to bring up the keyboard and begin typing the name.
5. When you are finished, power off the TV and power it back on for the change to take effect.

Media

Media is a central location for you to view or listen to different types of content (for example, your photos, music and movies) through the following methods:

- A USB thumb drive or hard drive
- Compatible mobile phone, tablet or other personal devices: You can stream movies, music and photos that are stored on Compatible personal device and play or view the content on your TV.

Panels that appear on the Media screen

The Media screen displays five panels: **Picture**, **Video**, **Music**, **All** and **Search**.

File formats that may be supported

NOTE

- Due to differences in programming tools and other factors, some of the file formats that are listed may or may not be supported.

| Medium | File Format |
|----------------|--|
| Video | .avi (MPEG2, Divx), .mkv (Divx), .mpeg (MPEG2) |
| Picture | .JPEG |
| Music | .mp3 |

Browsing Content

To browse through content based on the type that you wish to access:

1. Navigate to the appropriate menu tab on the screen and select **Picture**, **Video**, **Music**, **All** and **Search**.
2. Click on the name of the folder that contains your content.
3. Make your selection to play or view the content.

If you want to close out of the Media center, then press the **[EXIT]** button or **[BACK]** button on your remote.

Viewing Pictures as a Slideshow

To view pictures in a slideshow:

1. Press the **[≡]** button on your remote.
2. Click on **Repeat Mode**, and select **All**.
3. Back to the menu, click on **Interval**, and select the time.
4. Press the **[OK]** button, the slideshow of your pictures begins.

To stop the slideshow, press the **[OK]** button on your remote and press it again to restart it.

Viewing Video

To stop or restart the video, you can press the **[OK]** button on your remote. You can use the navigation buttons of your remote to control the video.

Edit

By operating this option, you can add a tile, including add an input, add an app and add a channel.

Using the **[▲/▼]** buttons of your remote to change or remove it, also you can select **Reset** to return your operation.

Using Anyview Cast to mirror content from your device to the TV screen

The Anyview Cast is an app that enables you to share (or cast) a video, audio or image from your Android-based device to the TV.

From your tablet or phone

To mirror content from your tablet or phone to the TV:

1. Press the [] button on your remote, press the [**v**] button on the D-pad to select **Settings**, press [**OK**] button to enter the Settings menu. Go to **Network > Network Configuration** and select **Wireless**.
2. Press the [**INPUT**] button on your remote and select the **Anyview Cast**. 
3. Turn on the wireless display function on your Android-based device.

NOTE

- Some Android-based devices may not support casting.
4. Find your TV in the list of devices that displays and select it.
 5. Wait for the Creating Connection progress bar to complete on the TV screen and the video or image will display in a moment.

Software updates for your TV

The software (also referred to as firmware) is part of what powers your TV. We will provide software updates to continuously enhance your TV and correct any issues that may impact your user experience; therefore, we recommend that you keep your TV connected to the Internet to receive updates when they are available.

You can choose to receive updates manually or check for software updates and install them manually.

Checking for the latest firmware

To manually check for the latest firmware:

1. Using your remote, press the [] button.
2. Press the [**v**] button on the D-pad to select **Settings**, press [**OK**] button to enter the Settings menu.
3. Go to **Support > Check Software Upgrade**.

Quick Problem-Solving Tips

When you experience an issue with your TV, turn it off and on again. If this does not resolve the problem, then refer to the tips below. If the problem is still not resolved, then contact us.

| ISSUES | POSSIBLE SOLUTIONS |
|--|---|
| No sound or picture | <ul style="list-style-type: none"> • Check if the power cord is plugged into a powered AC outlet. • Press the [] button on the remote control to activate the unit from 'Standby' mode. • Check to see if the LED light is on or not. If it is, then the TV is receiving power. |
| I have connected an external source to my TV and I get no picture and/or sound | <ul style="list-style-type: none"> • Check for the correct output connection on the external source and for the correct input connection on the TV. • Make sure you have made the correct selection for the input mode for the incoming signal. |
| When I turn on my TV, there is a delay for a few seconds before the picture appears. Is this normal? | <ul style="list-style-type: none"> • Yes, this is normal. The TV is initializing and searching for previous setting information. |
| The picture is normal but there is no sound | <ul style="list-style-type: none"> • Check the volume settings. • Check if 'Mute' mode is set to On. |
| Sound but no picture or black and white picture | <ul style="list-style-type: none"> • If the picture is black and white, unplug the TV from the AC outlet and replug it after 60 seconds. • Check that the Color is set to 50 or higher. • Try different TV channels. |
| The sound and/or picture is distorted or appears wavy | <ul style="list-style-type: none"> • An electric appliance may be affecting the TV. Turn off any appliances that are nearby and move it farther away from the TV. • Insert the power plug of the TV set into another power outlet. |
| The sound and picture is blurry or cuts out | <ul style="list-style-type: none"> • If using an external antenna, check the direction, position and connection of the antenna. • Adjust the direction of your antenna or reset or fine tune the channel. |
| A horizontal or vertical stripe appears on the picture and/or the picture is shaking | <ul style="list-style-type: none"> • Check if there is an appliance or electric tool nearby that is causing interference. |
| The plastic cabinet makes a "clicking" type of sound | <ul style="list-style-type: none"> • The 'click' sound can occur when the temperature of the television changes. This change causes the television cabinet to expand or contract, which makes the sound. This is normal and the TV is OK. |
| The remote control does not work | <ul style="list-style-type: none"> • Confirm that TV still has power and is operational. • Change the batteries in the remote control. • Check if the batteries are correctly installed. |

NOTE

- For usage in Mexico, operation of this equipment is subject to the following two conditions: 1) it is possible that this device doesn't cause any detrimental interference and 2) this device must take any kind of interference, including that which may cause its malfunctioning.