



Instruction Manual

Thank you for purchasing this product.



Before using this product please read the instructions carefully.

After reading the instruction manual, please keep it for reference.

Table of Contents

Caution	2
Battery Precautions	3
Included	4
Platform	5
Layout	5
How to Connect	6
How to use the Neckset	9
• Checking the Battery Level	9
• Turn off the Neckset	9
• Volume Controls	10
• Mic On/Off	10
Switch between Sound Modes	11
Troubleshooting	12
• If the Neckset is not responding	12
• Can't Charge / Neckset is not responding when fully charged	12
• If there is no sound from the Neckset	13
• If others cannot hear your voice and/or cannot use voice chat	14
Main Features	15

Caution

-  Turn the volume down before connecting to a DualSense™ Wireless Controller.
Connecting at a high volume setting may cause a loud sound, which may damage your ears.
-  Using while connected to the PlayStation®5 console may create noise in the neckset audio. If this occurs, please do not charge while using the neckset.

Caution Parents/Guardians: Please read the following information carefully.

- Keep this product away from small children or infants. Seek medical attention immediately if any small parts are swallowed.
- Long cord. Strangulation hazard.
- Do not use high volume settings for an extended period of time to avoid hearing loss.
- Keep the product away from dusty or humid areas.
- Do not use this product if it has been damaged or modified.
- Do not get this product wet, place in wet places, or handle with wet hands.
This may cause an electric shock or malfunction.
- This product is not waterproof. Please do not use this product when:
 - Exercising or during strenuous activity that causes excessive sweating.
 - In wet or steamy rooms such as bathrooms.
- Do not touch the metal parts of the USB plug.
- Do not use the USB plug when it's covered with dust.
- Do not place this product near heat sources or leave under direct sunlight for an extended period. Overheating may cause malfunction.
- Do not twist or bundle the cables.
- Do not apply strong impact or weight on the product.
- Do not pull roughly or bend the cable of the product.
- Do not disassemble, modify or attempt to repair this product.
- If the product needs cleaning, use only a soft dry cloth.
Do not use any chemical agents like benzene or thinner.
- Do not use this product for anything other than its intended purpose.
We are not responsible for any accidents or damages in the event of use other than the intended purpose.

Battery Precautions

If batteries leak, please do not touch the acid with your bare hands.
Do not place this product near heat sources or leave under direct sunlight.
Internal battery life may deplete over time.

Please be aware of the following during usage or storage. The built-in battery may overheat or rupture, and may cause fire, electric shock, injury, deformation or malfunction of the product.

- Do not place the product in fire, microwave, high-pressure containers, or use a dryer to dry.
- Keep this product away from the following high temperature areas:
 - Near heat sources or leave under direct sunlight.
 - Heated carpet, high pile carpet, or on top of home theater equipment.
 - Outdoors or inside a car during the summer.
- Do not charge this product other than by its specified method.
The built-in battery may overheat or rupture, and it may cause fire or malfunction of the product.
- Do not touch if this product is charging when lightning strikes, as there may be risk of electric shock.
- Keep USB connector away from metal objects. This may cause overheating, rupturing, electric shock, or leakage.
- Never disassemble, repair or modify this product. It may cause fire, rupturing or overheating.
- Do not drop, step on, or inflict strong impact. This may cause ignition, overheating, or rupture.
- Keep the product away from liquid or foreign matter. It may cause fire, electric shock, or malfunction.
If any liquid or foreign matter gets inside the product, stop using the product immediately and contact us for inspection.
- Keep the product away from water and do not use with wet or oily hands.
It may cause electric shock or malfunction.
- Keep the product away from humid, dusty, or smoky areas.
It may cause electric shock or malfunction.
- Keep the USB connector away from foreign matter or dust. It may cause electric shock, malfunction, or contact failure. Use a dry cloth to wipe off any foreign matter or dust.
- Charge this product where the room temperature is 10 - 35°C (50 - 95°F). Charging outside this temperature range may result in the product not charging properly or prolong the charging time.
- The charge and discharge life of the internal battery of this product is about 500 times.
Battery life depends on storage method, usage, environment, etc.
- If the battery life drastically diminishes or device stops functioning on a full charge, the battery life has come to its end.
- Recharge the battery at least once in three months to maintain function even if it has not been used for a prolonged time.



The Lithium Polymer battery is made from recyclable resources.

Li-ion 00

Included

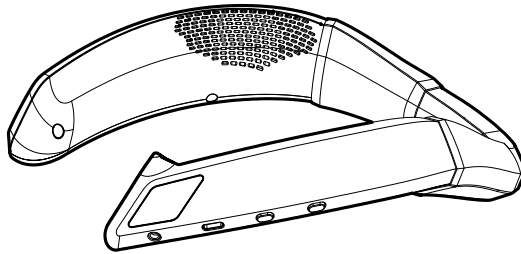

Gaming neckset ×1

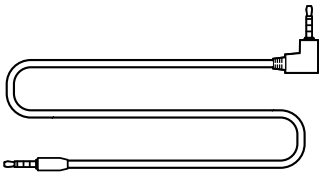

3.5mm audio cable ×1

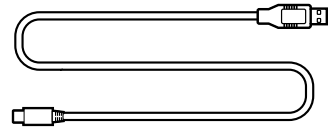

USB cable (Type-A to C) ×1

Platform

PlayStation®5, PlayStation®4, PC

Important

Before using this product, please read the instruction manual for the PlayStation®5 and other devices you may use with the Neckset. Please check that your PlayStation®5, PlayStation®4, or PC is updated to the latest system firmware.

※ When using a PC that does not support $\Phi 3.5\text{mm}$ 4-ring mini jack compatible hardware, please purchase a separate converter.

This product is designed for the PlayStation®5 but can also be used with the PlayStation®4 and Windows 10 PC by following the instructions in this manual.

Layout

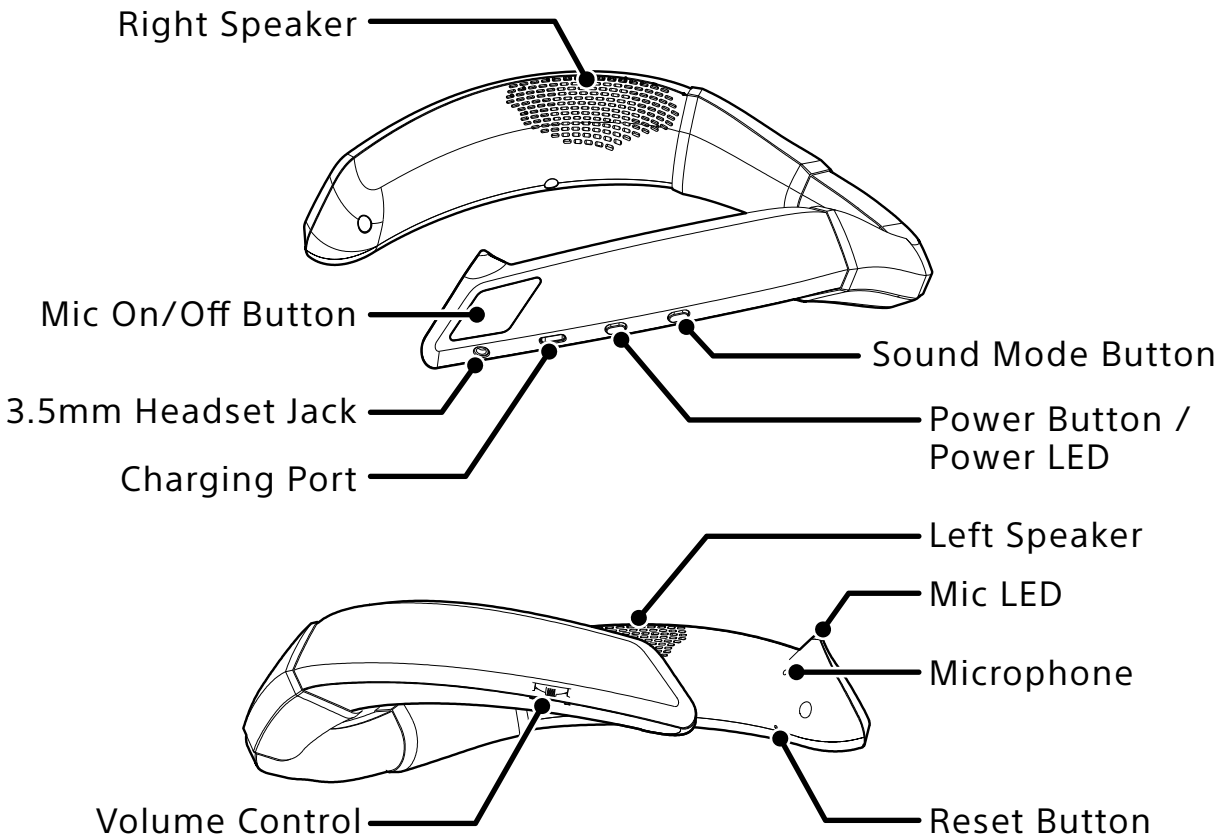

How to Connect

① Please charge the Neckset.

- * Please charge the Neckset before using it for the first time.
- * Do not press on any buttons when connecting the USB cable.
- * Check the connector direction before inserting.

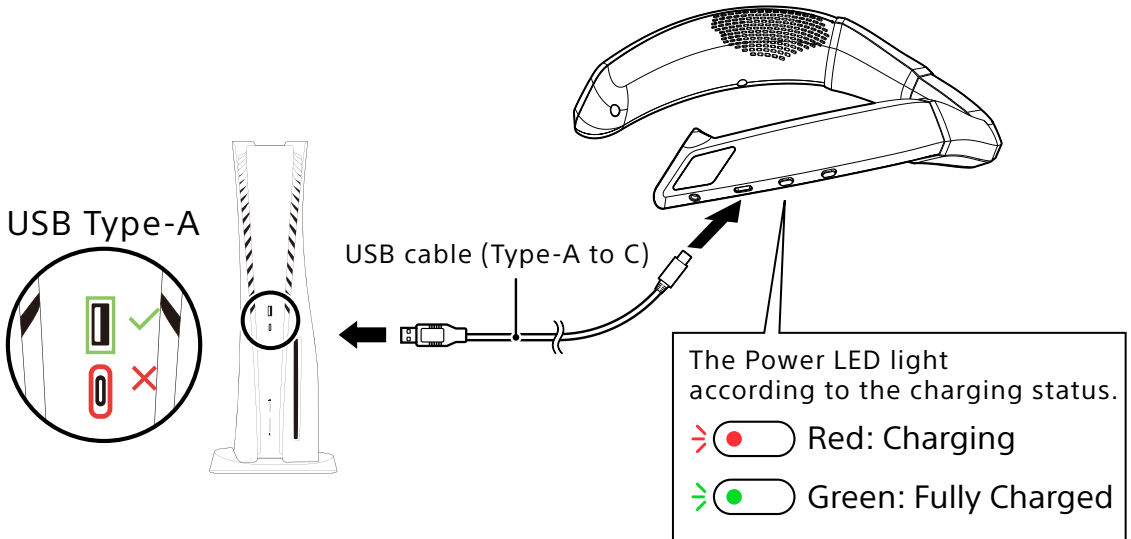

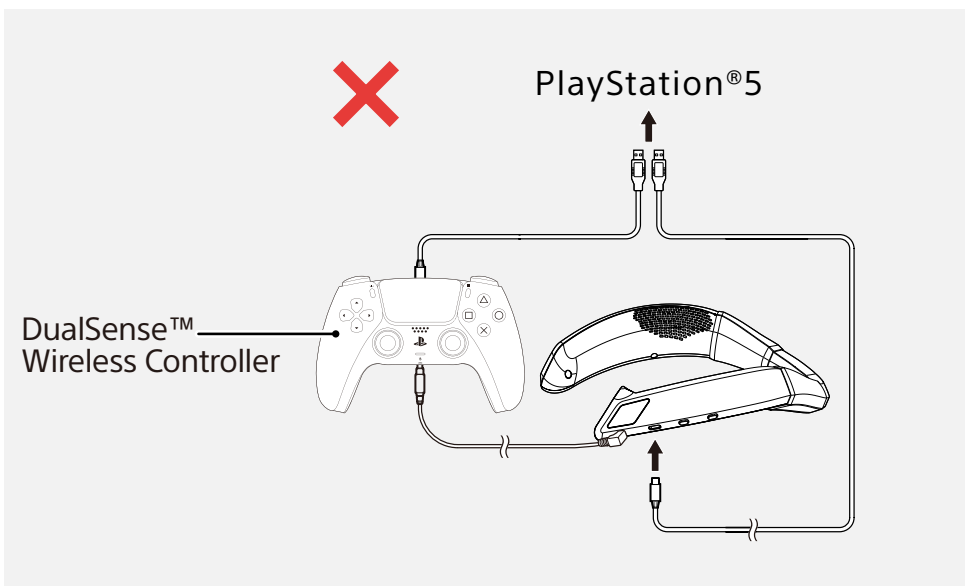

Using while connected to the PlayStation®5 console may create noise in the neckset audio. If this occurs, please do not charge while using the neckset.

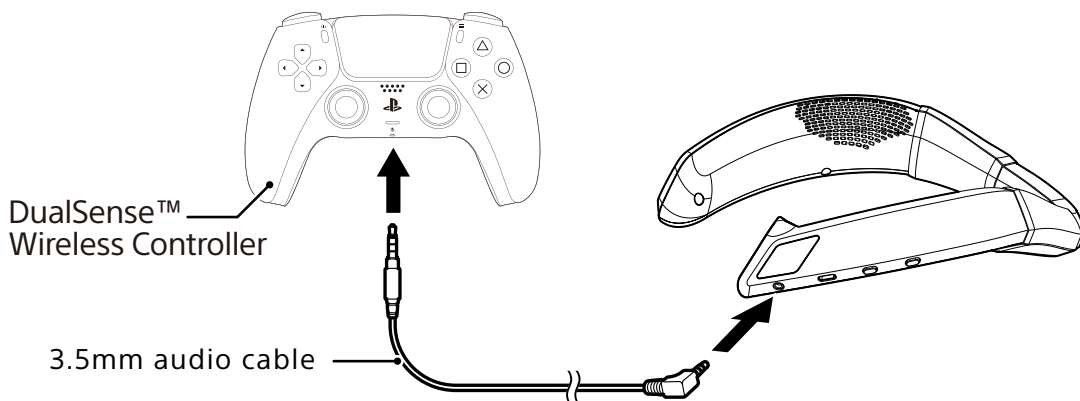

② Connect the 3.5mm audio cable to the DualSense™ Wireless Controller's 3.5mm Headset Jack.

* Please ensure that the cable is pushed in completely.



 Turn down the volume before connecting to a DualSense™ Wireless Controller. Connecting at a high volume setting may cause a loud sound, which may damage your ears.

③ Turn on the Neckset.

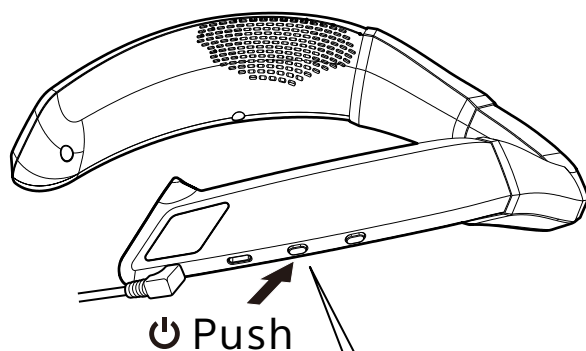

When the product turns on it will 'beep' and the LED will light up for 3 seconds. Then it will blink every 5 seconds.

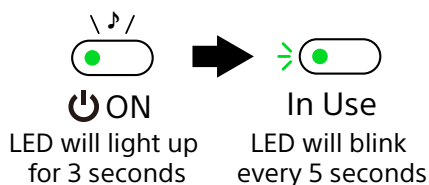

- ④ Place the Neckset around the back of your neck, resting on your shoulders.

* Please refer to the image to properly wear the Neckset.

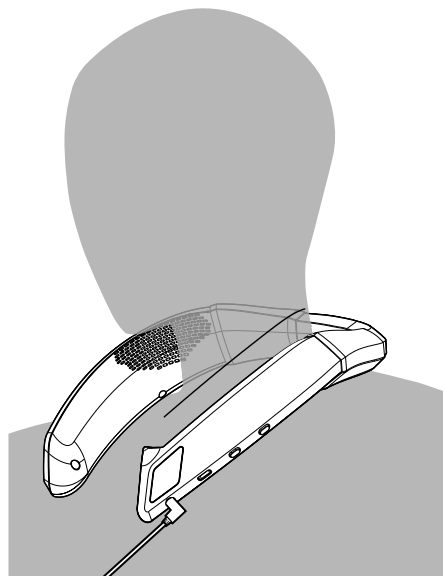

How to adjust the PlayStation®5 volume

From the home screen, select "Settings", then choose "Sound"→"Audio Output"→"Output to Headphones".

Select "All Audio" to enable both in-game audio and voice chat audio. "Chat Audio" Only voice chat audio will be enabled.

*This setting may differ based on the PlayStation®5 firmware version.

How to adjust the PlayStation®4 volume

From the home screen, select "Settings", then choose "Devices"→"Audio Devices"→"Output to Headphones".

Select "All Audio" to enable both in-game audio and voice chat audio. "Chat Audio" Only voice chat audio will be enabled.

*This setting may differ based on the PlayStation®4 firmware version.

How to use the Neckset

Checking the Battery Level

The Mic LED will blink orange and 'beep' when the battery level reaches 20% and 10%.

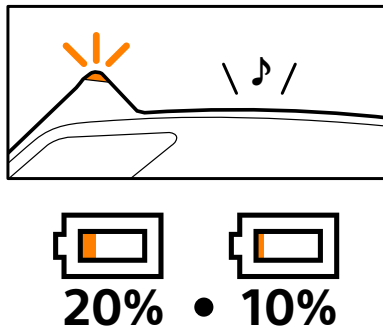

Turn off the Neckset

Push and hold the Power Button down for three seconds to turn off.

- * Please turn off when not in use.
- * If the product has not been in use for 30 minutes, the Neckset will 'beep' and then turn off automatically.

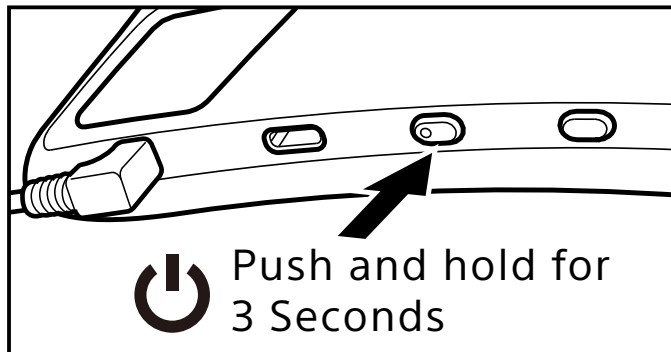

Volume Controls

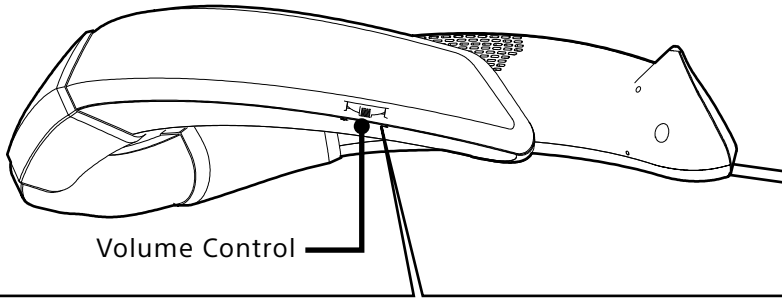

Increase Volume ↔ Decrease Volume

* There will be a 'beep' when the minimum or maximum volume has been reached.

Mic On/Off

Press the Mic Button to turn the Mic ON and OFF.

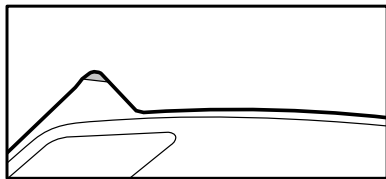
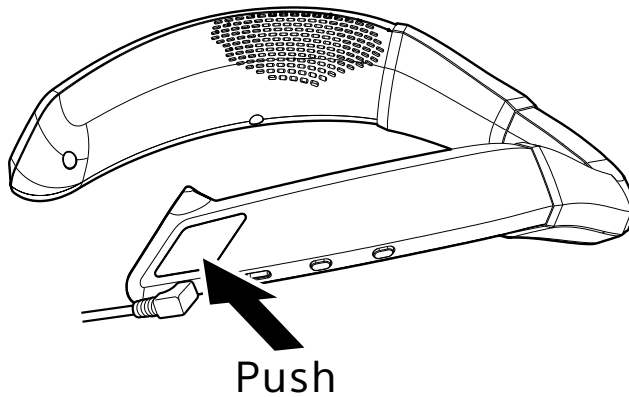

Mic Input On

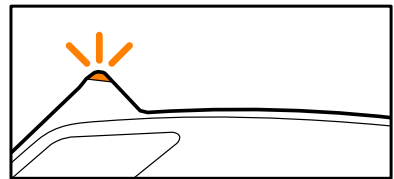

Mic Input Off

Switch between Sound Modes

Push the Sound Mode Button once to change the mode.

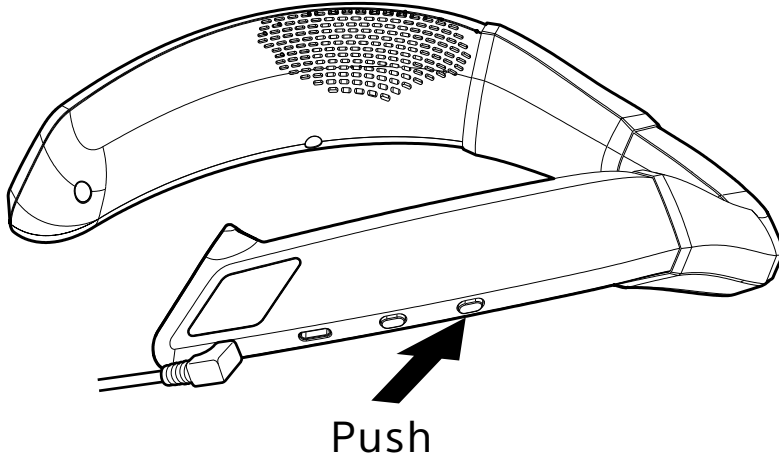

Bass Boost Mode

This mode emphasizes bass for balanced gaming sound.

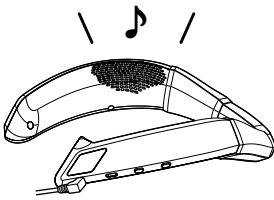

One Beep

FPS Mode

Easily detect the location of players and in-game sounds in this mode.

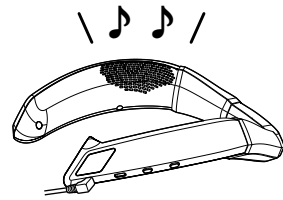

Two Beeps



There will be one or two 'beeps' when switching between modes.

Troubleshooting

If an issue occurs, please check the following.

If the Neckset is not responding

If the product does not respond when the Power Button is pressed, the battery may need to be charged.

Please charge the neckset according to the following instructions.

- * Please charge the Neckset when before using it for the first time.
- * Do not press on any buttons when connecting the USB cable.

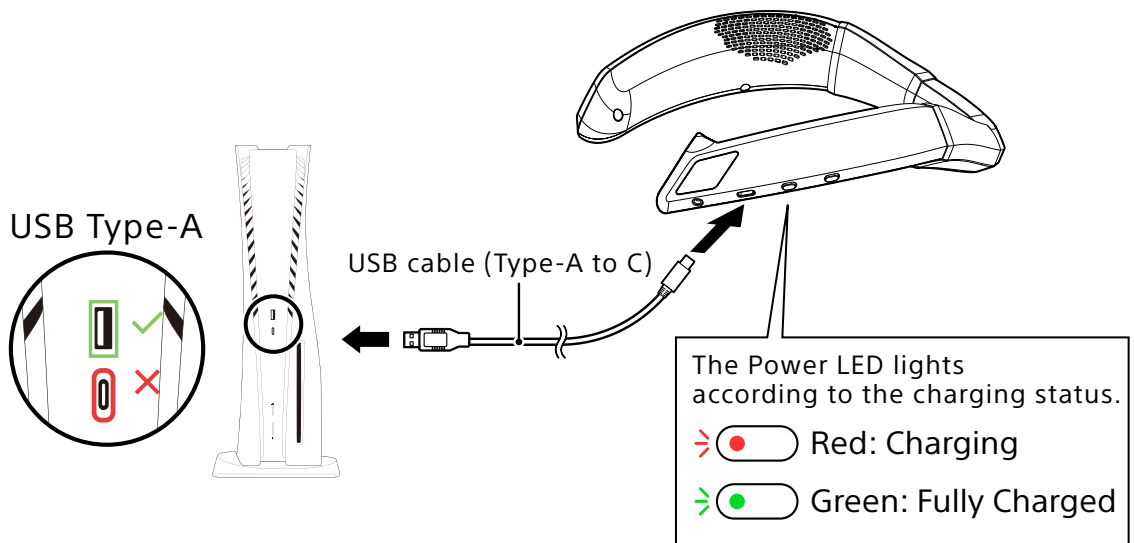

Can't Charge / Neckset is not responding when fully charged

If charging is not possible, if the product does not respond even after charging, or if it responds on its own, press the Reset Button located inside the neckset with a fine-tipped object to reset and reconnect it.

- * When pushing the Reset Button, please use the end of a paper clip and not a sharp needle.

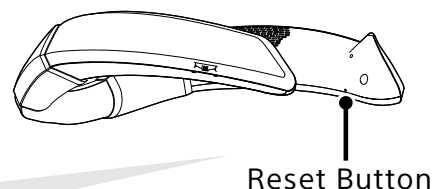
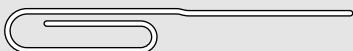

If there is no sound from the Neckset

If there is no sound coming from the Neckset, please try the following:

- ① Make sure that all plugs are connected all the way in.
- ② Ensure that the product is turned ON.
- ③ Please check that the battery is charged.
- ④ Check that the volume is turned up.
- ⑤ Check the settings on the PlayStation®5 or PlayStation®4.

PlayStation®5 Settings

From the PlayStation®5 home screen, select "Settings" → "Sound".

- "Volume" → "Headphones"
- "Output Device" → "Controller Headset"
- "Output to Headphones" → "All Audio"

(Select "Chat Audio" to enable only voice chat audio.)

PlayStation®4 Settings

From the PlayStation®4 home screen, select "Settings" → "Devices" → "Audio Devices".

- Confirm that "Volume Control (Headphones)" is adjusted.
- Confirm that "Output Device" is set to "Headset Connected to Controller".
- Make sure that "Output to Headphones" is set to "All Audio".

(Select "Chat Audio" to enable only voice chat audio.)

- ⑥ Make sure to adjust any other hardware device setting and/or in-game settings.

If others cannot hear your voice and/or cannot use voice chat

If others cannot hear your voice and/or cannot use voice chat, please try the following:

- ① Make sure that all plugs are connected all the way in.
- ② Ensure that the product is turned ON.
- ③ Please check that the battery is charged.
- ④ Ensure that the Mic Input is turned on.
- ⑤ Check the settings on the PlayStation®5 or PlayStation®4.

PlayStation®5 Settings

From the PlayStation®5 home screen, select "Settings" → "Sound".

- Adjust the microphone level by selecting "Microphone" • "Adjust Microphone Level".
- Confirm that "Microphone" • "Input Device" is set to "Controller Headset".
- Confirm that the DualSense™ Wireless Controller isn't muted.

PlayStation®4 Settings

From the PlayStation®4 home screen, select "Settings" → "Devices" → "Audio Devices".

- Select "Adjust Microphone Level".
- Check that "Input Device" is set to "Controller Headset".

- ⑥ Make sure to adjust any other hardware device setting and/or in-game settings.

Main Features

Gaming neckset

External Dimensions	: (width) 9.8in x (depth) 8.1in x (height) 1.3in
Weight	: Approx 0.5lbs
Maximum Output	: 3W
Internal Battery	: Lithium Ion Battery
Battery Life	: Up to 10 hours (Battery life may vary depending on how the product is used.)
Charging Time	: 3 hours
Connection Type	: USB Type-A to C
Input	: $\Phi 3.5\text{mm}$ 4 ring plug
Impedance	: $4\Omega \pm 15\%$
Driver Aperture	: $\Phi 31\text{mm}$
Maximum Input	: 40mW
Frequency Range	: 20Hz to 20kHz
Sound pressure	: $80\text{dB} \pm 3\text{dB}$
Power Supply	: DC5V / 500mA (max)

Microphone

Impedance	: $2.2\text{k}\Omega \pm 5\%$
Sensitivity	: $-36 \pm 3\text{dB}$
Frequency	: 100Hz~10kHz
Directivity	: Omni-directional

3.5mm audio cable

Cable Length	: 3.9ft
--------------	---------

USB cable (Type-A to C)

Cable Length	: 3.3ft
--------------	---------

The image on the package may differ from the actual product.

The manufacturer reserves the right to change the product design or specifications without notice.

“”, “PlayStation”, “DualSense” and “PlayStation Shapes Logo” are registered trademarks of Sony Interactive Entertainment Inc.

USB Type-C® are registered trademarks of USB Implementers Forum.

HORI & HORI logo are registered trademarks of HORI.

All other trademarks are the property of their respective owners.

©2021 Sony Interactive Entertainment Inc.

Ages 6+