



Questo manuale d'istruzione è fornito da trovaprezzi.it. Scopri tutte le offerte per [Insta360 Link 2C Pro Standard](#) o cerca il tuo prodotto tra le [migliori offerte di Webcam](#)

**Link 2C Pro & Link 2 Pro User Manual**

**Insta360 Link 2C Pro**

**Insta360 Link 2 Pro**

# User Manual

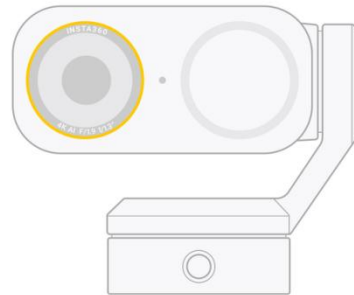
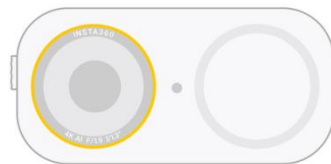

# Contents

ABOUT THIS MANUAL .....	1
OVERVIEW .....	1
Appearance .....	1
What's in the Box .....	2
Indicator Light .....	3
FIRST USE .....	5
Setting Up the Device .....	5
Connecting to Computer .....	6
Basic Use (No Client Required) .....	7
INSTA360 LINK CONTROLLER .....	11
Download and Installation .....	11
Software Interface Overview .....	12
Audio Mode Selection .....	13
Insta360 InSight and AI Recording Summary .....	14
Other Useful Features .....	16
ADVANCED USE .....	17
AI Tracking and Auto Framing .....	17
Whiteboard Mode .....	21
DeskView Mode .....	23
LIVE STREAMING .....	24
Preparations: Installation and Basic Settings .....	24
Two Camera Signal Sources .....	26
Configuring the Camera in Streaming Software .....	27

## **Link 2C Pro & Link 2 Pro User Manual**

---

Using the Camera via OBS Studio .....	28
Advanced Application – Green Screen Keying Live Stream .....	30
ECOSYSTEM INTEGRATION .....	33
Using Elgato Stream Deck to Control Link 2 Series Cameras .....	33
Advanced Application – Multi-Camera Live Streaming .....	40
Integration with Wave .....	44
MAINTENANCE AND CARE .....	45
Checking the Serial Number (SN) .....	45
Log Upload .....	47
Firmware Update .....	49
Storage and Maintenance .....	49
SPECIFICATIONS .....	50

## About This Manual

1. This manual applies to both the Insta360 Link 2 Pro and Link 2C Pro cameras. Where functions and operations are identical, they will be referred to collectively as "this device" or "the camera". Any differences will be noted separately.
2. The images in this manual are for reference only. Actual interface may vary slightly.

## Overview

### Appearance

#### Link 2 Pro

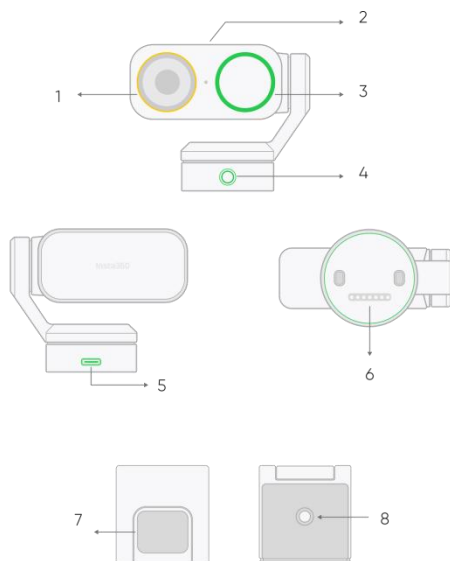



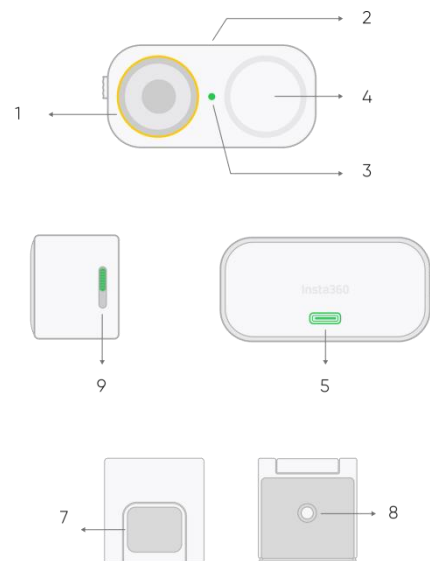

#### Link 2C Pro



1. Lens
2. Microphone
3. Indicator Light
4. Touch Key
5. USB-C Port

6. Magnetic Base (Link 2 Pro Only)
7. Magnetic Surface
8. 1/4" Screw Hole
9. Privacy Switch (Link 2C Pro Only)

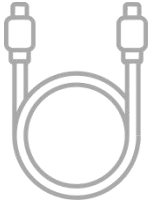
## What's in the Box

	Insta360 Link 2C Pro / Insta360 Link 2 Pro
	Magnetic Mount
	USB-C Cable
	USB-C to USB-A Adapter
	Whiteboard Recognition Markers

## Indicator Light

### 1. System & Basic Status

Status	Indicator Light
Powering On	Solid Green
Startup Self-check	Breathing Green
Standby (Idle)	Solid Green
Sleep	Light Off
U-Disk Mode	Solid Blue
Firmware Update in Progress	Breathing Blue
Firmware Update Successful	Solid Green
Factory Reset in Progress	Flashing Blue
Factory Reset Complete	Solid Green

### 2. Main Working Modes

Status	Indicator Light
Single-Person Tracking Active	Solid Cyan
Multi-Person Tracking Active	Solid Cyan
Whiteboard Mode - Scanning	Breathing Green
Whiteboard Mode - Active	Solid Green
Smart Whiteboard - Scanning	Breathing Green
Smart Whiteboard - Active	Solid Green
DeskView Mode - Active	Solid Green
Auto-Framing - Active (Link 2C Pro)	Solid Cyan

### 3. Prompts & Abnormalities

Status	Indicator Light
Gesture Control Successful	Fast Flashing Green (3 times)
Hardware Failure	Solid Red
Update Failed	Fast Flashing Red (3 times, then stops)
Abnormal Operation	Fast Flashing Red (3 times, then stops)
Single Person Tracking - Interrupted	Fast Flashing Red (3 times, then stops)
Whiteboard Mode - Not Scanned	Fast Flashing Red (3 times, then stops)
Gesture Recognized - Failed to Activate	Fast Flashing Red (3 times, then stops)

### 4. Privacy Mode

Status	Indicator Light
Privacy Mode (Link 2 Pro only, camera and microphone are disabled by default)	Solid Yellow

# First Use

## Setting Up the Device

Steps	Graphics
<ol style="list-style-type: none"> <li>1. Secure the Magnetic Mount to your screen's edge as shown.</li> <li>2. Place the camera, ensuring the status LED on top is centered with the screen.</li> <li>3. Adjust the angle of the mount to keep the camera roughly at body level.</li> <li>4. Connect the camera to your computer using the included cable. Once successfully connected, the indicator light will turn solid green.</li> </ol>	
<p>For vertical shooting, a tripod is required. The camera can be mounted on a tripod via the 1/4" screw hole at the bottom of the Magnetic Mount.</p>	

## Connecting to Computer

1. Connect the device to your computer using the included cable. The webcam will perform a self-check, then the indicator light will then turn solid green, indicating the camera is ready to use.
2. Once connected, you can select this device as the video and audio source in third-party video conferencing software. You will see two options in the camera/microphone settings list:
  - Insta360 Link 2C/2 Pro (Physical Camera Stream): Provides basic video and audio, and supports AI tracking control via the camera's buttons or gestures.
  - Insta360 Virtual Camera (Virtual Camera Stream): Enable this option to use all advanced features provided by the Insta360 Link Controller, such as Makeup, Beautify, Virtual Background, Smart Whiteboard, etc.

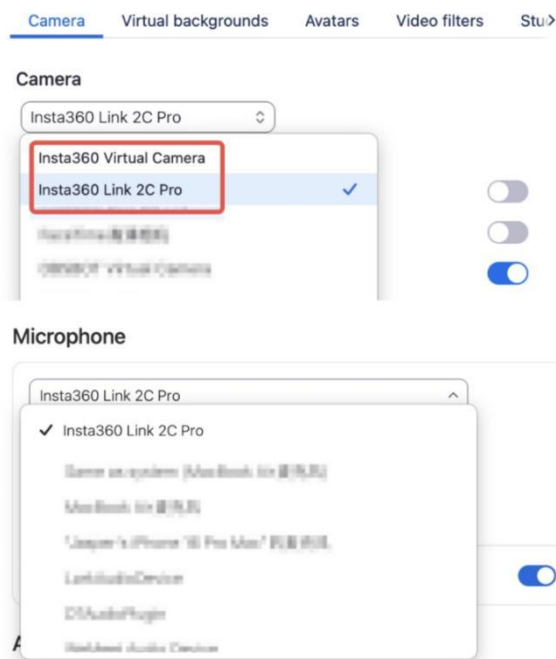

3. To experience the full performance of the device, it is recommended to download the Insta360 Link Controller software (hereinafter referred to as the "client") from the official website. This allows you to use features such as Smart Whiteboard, Background Replacement, Background Blur, Bokeh, Green Screen Keying, Makeup, Beautify, as well as utilize Insta360 InSight and customize AI Tracking settings (e.g., setting pause-track areas/tracking areas and adjusting tracking speed).

### Notes:

- To prevent malfunctions due to power supply, please connect the device directly to your computer or to a dock with an independent power supply. (Power requirements: 5V/1A)
- This device is compatible with Windows and macOS computers. To avoid compatibility issues, please ensure you use the included cable to connect to your computer.

## Basic Use (No Client Required)

### Touch Key

- **Single Tap:** Turn AI Tracking on or off.
- **Double Tap:** Link 2 Pro: Double-tap the touch key on the gimbal base to recenter the gimbal. Link 2C Pro: Double-tap the touch key to switch between 1x and 1.5x zoom.
- **Triple Tap:** Triple-tap and then long press for 5 seconds to enter U-Disk Mode for firmware updates and other operations. Unplug the cable to exit U-Disk Mode (On Windows, please safely remove hardware first).

### Gesture Control

Gesture control allows you to perform operations such as zooming, Whiteboard Mode, and tracking for a more efficient and smooth experience. Below are the gestures that can be used without the client software. Gesture Control is enabled by default on Link 2 Pro and disabled by default on Link 2C Pro.

### Zoom via Gestures

1. Ensure your face is within the camera's frame.
2. Show an **"L" gesture** to the lens. The indicator light will flash green, indicating successful detection. (Ensure the gesture does not block your face).
3. Keep the gesture visible; move your hand **upward to zoom in** and **downward to zoom out**. (You only need to perform the upward or downward motion; continuous movement is not required).

### Tips:

- The "L" gesture must remain within the frame during the zooming process.
- When multiple people are in the frame, the camera will only track one person at a time. For the "L" gesture, it will only respond to the first detected gesture.
- If multiple people move in different directions, it will not affect the recognition rules; the camera still responds based on the first detected gesture.



### Control Whiteboard Mode via Gestures

1. When the whiteboard you are using meets the following conditions, you can directly activate Whiteboard Mode via a "V" gesture, without relying on recognition markers or opening the Link Controller client:
  - Whiteboard Characteristics:
    - White background with distinct borders. The maximum recognition distance is 5m when facing the device directly. When tilted, the angle should not exceed 30 degrees, and the recognition distance should not exceed 3m.
2. Show a "V" gesture (scissors sign) within the camera's frame. The indicator light will flash green, indicating successful detection.
3. The device will then detect the whiteboard in the frame and highlight it.

4. If using a non-white surface (such as a blackboard) or an irregularly shaped surface, please use Whiteboard Recognition Markers or enable Smart Whiteboard Mode in the Link Controller client for recognition.



### Control AI Tracking or Auto Framing via Gestures

With your face in frame, show your palm to the camera and hold it for a moment. Once the green light flashes, recognition is successful and AI Tracking is enabled. At this point, Link 2 Pro will adjust the gimbal angle to follow the subject's movement; Link 2C Pro will use digital zoom and cropping to keep the subject centered in the frame as much as possible.



### Privacy Mode

#### Link 2 Pro

Manually tilt the camera downward 90° to enter Privacy Mode. The camera and microphone functions will be disabled. Manually tilt the camera back up to exit Privacy Mode.

Note: Entering Privacy Mode disables both audio and video. When the device is not being used by any platform, the camera will automatically tilt down after 10 seconds to enter Sleep Mode.

When the camera is in Privacy Mode, you can wake it up using any of the following methods:

- **Software wake-up:** Open a software that requires the camera (e.g., a video conferencing app). The camera will wake up automatically when the software starts receiving the video or audio stream.
- **Manual wake-up:** Manually rotate the camera gimbal up to a normal usage angle to exit Privacy Mode.
- **Reconnection:** Unplug and replug the camera's cable to re-establish the connection for use.

### Link 2C Pro

Toggle the privacy switch on the camera to physically block the lens view and protect your privacy. To turn off the microphone, please manually disable the audio input in the Insta360 Link Controller or third-party software.

# Insta360 Link Controller

## Download and Installation

- **Download:** Please visit the Download Center on the official Insta360 website.
- **Installation:** After downloading the "Insta360 Link Controller" software, follow the prompts to complete the installation.
- **Virtual Camera Settings (Important):** To use advanced features such as Smart Whiteboard, Virtual Background, and Beautify, you must select "**Insta360 Virtual Camera**" as the video source in your live streaming or conferencing software.

The setup methods are as follows:

- **Windows:** Click the virtual camera icon within the Link Controller software and follow the prompts to complete the installation.
- **macOS:** For first-time use, follow the system prompts to go to "System Settings" > "Privacy & Security" to allow the relevant camera extension permissions, then restart the client. If your macOS version is 15.0.1 or later, go to "System Settings" > "General" > "Login Items & Extensions" > "Camera Extensions", enable the client permission, and restart the client for the feature to take effect.

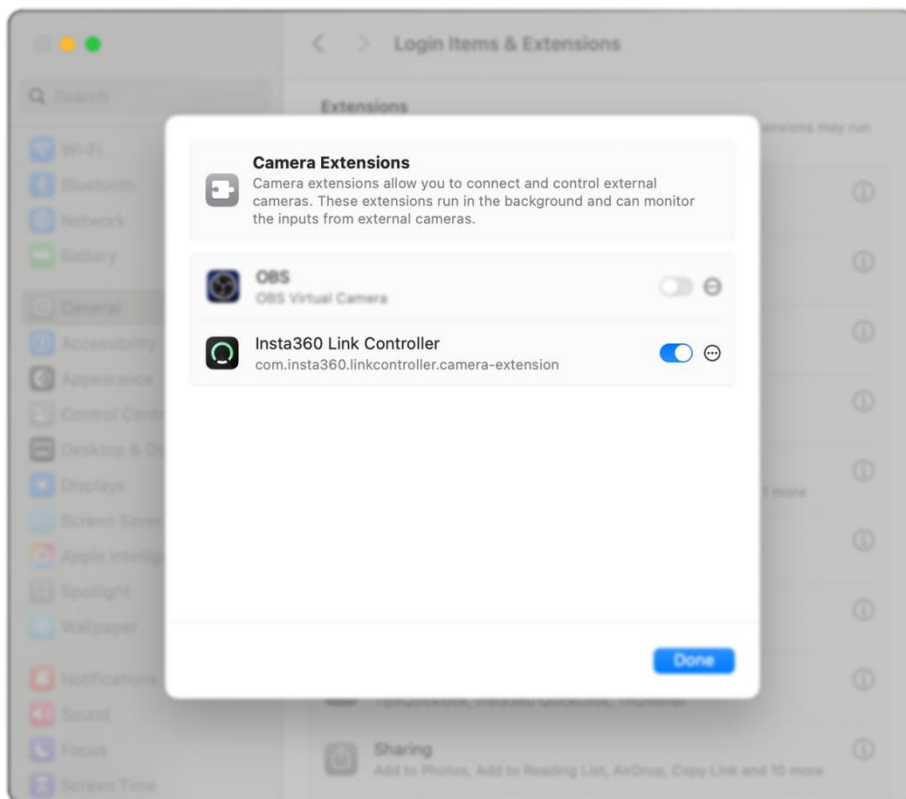



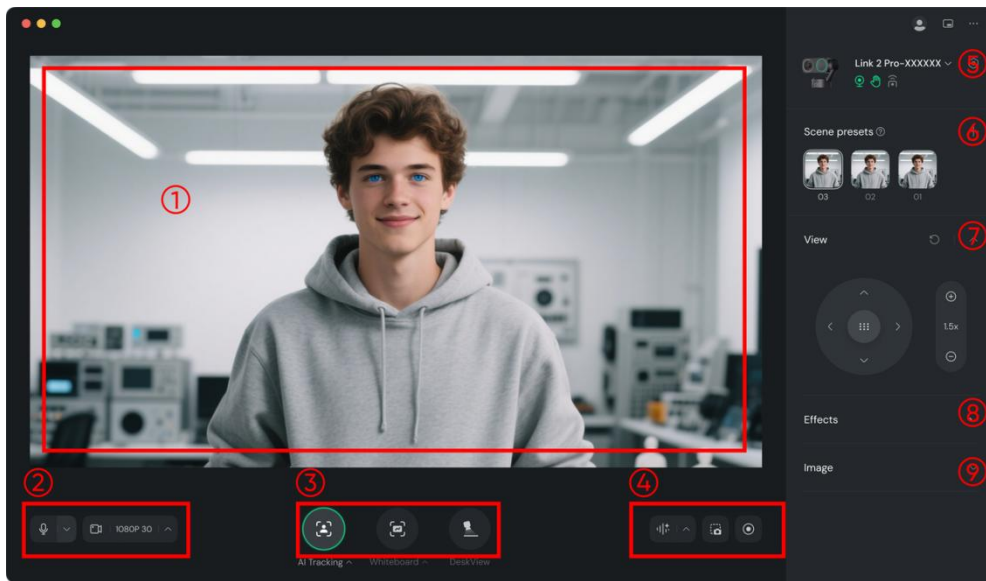

## Software Interface Overview



1. **Preview Area:** Real-time preview of the captured footage.
2. **Video and Audio Settings Area:** Connect or disconnect video/audio signals and adjust settings (select microphone source, pickup mode, aspect ratio, resolution, frame rate, vertical and horizontal mirroring, etc.).
3. **Smart Features Entry:** Turn "AI Tracking" / "Auto Framing," "Whiteboard," and "DeskView" on or off, and access specific settings for adjustments. See below for detailed operation methods.
4. **Recording Area:** Start or stop standard video recording, use AI Recording (transcribes audio into text summaries; requires account login), or take screenshots.
5. **Status Bar:** Display and adjust gesture settings, virtual camera status, and access more settings.
6. **Scene Presets:** Save current parameters as a preset (AI mode, view, effects, image settings) for quick switching.
7. **View:** Adjust the camera direction (Link 2 Pro only) and zoom.
8. **Effects:** Select real-time filters, use or upload virtual backgrounds (choose "Bokeh" to focus on the subject, or "Background Blur/Replacement" to protect privacy), perform Green Screen Keying (see "Advanced Applications – Green Screen Keying Live Streaming" for detailed steps), and apply real-time Beautify & Makeup effects.
9. **Image:** Manually adjust exposure, color temperature, saturation, etc., and save these parameters as a color template for one-click application in future sessions.

## Audio Mode Selection

Based on your usage, click the microphone icon at the bottom of the client to select the pickup mode and access more audio settings.

Modes	Description	Graphics
Standard	Suitable for daily use. It picks up ambient sound around the device, enhances and highlights human voices, and slightly reduces environmental noise.	
Wide	Suitable for single or multi-person meetings, live streaming, and other scenarios. It picks up and enhances all human voices in front of the device while automatically suppressing environmental noise and voices from behind the device.	
Focus	Suitable for noisy environments such as workstations or cafes. The pickup range is more concentrated, prioritizing the enhancement of human voices within approximately 1 meter in front of the device while automatically suppressing voices and environmental noise outside this area.	
Original	Suitable for scenarios with high audio quality requirements, such as content creation and live streaming. It picks up ambient sound around the device with noise reduction turned off to preserve the original sound as much as possible.	

## Insta360 InSight and AI Recording Summary

InSight is our premiere, value-added AI: An intelligent meeting assistant. After logging in to your account, you can record meetings directly in the client and automatically obtain complete text transcripts and AI-generated summaries, helping you and your team efficiently capture and retain meeting content.

### Operation Process

#### 1. Preparation Before Starting

- Log in to your account: Make sure you are logged in to your Insta360 official website account in the Link Controller client. The AI recording summary feature is not available without logging in.
- Check audio: Click the microphone icon at the bottom to confirm that the correct audio input device is selected.
- Recording settings: Click the “^” next to the “AI Recording” button in the client to access settings.
  - Summary: When enabled, after ending the recording while connected to the internet, the AI will generate a summary using the default template.
  - Recording Language: Set the language used during recording. The AI will transcribe and summarize based on this language to improve accuracy.
  - Local Cache Location: Used to temporarily store recordings that have not yet been uploaded. The file will be automatically deleted after upload.
  - Meeting Recording Reminder: When a meeting is detected to start and the audio input device is selected as Link 2 Pro or Link 2C Pro, the system will automatically prompt you to start recording.

#### 2. Start AI Recording

- Recording: On the main interface of the client, click the “Start AI Recording” button to begin capturing meeting audio. (You must review and agree to the privacy policy before first use.)

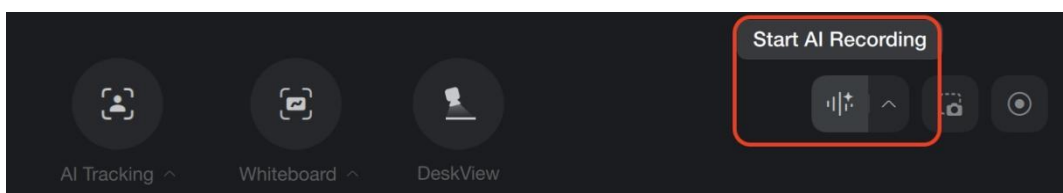

- **Controls:** During recording, you can pause or resume at any time, or click the microphone icon to temporarily mute. You can also quickly locate and mark important moments in the recording.

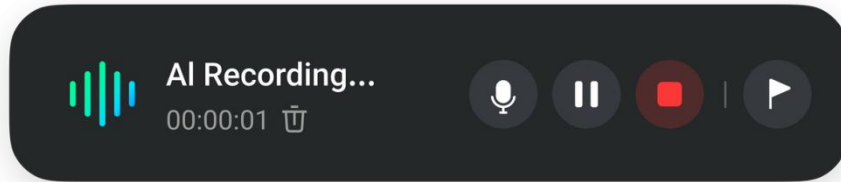

- **Stop:** After the meeting ends, click the red “Stop Recording” button to end the recording. The system will automatically upload the audio (closing the window will not affect file upload). You can then choose to manually generate an AI text summary or set it to be generated automatically in advance.

### 3. View and Use the Recordings

- **View in the client:** After recording ends, click the “^” next to the “AI Recording” button in the client and select “View Recordings” to enter the InSight web page to view files.

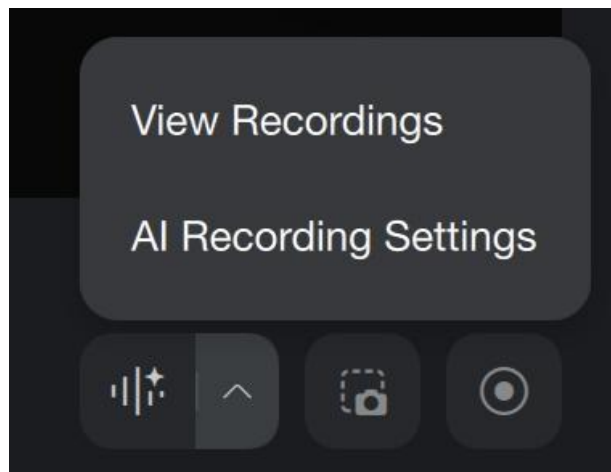

- **In-depth analysis on the InSight website:** Visit the InSight website to view the complete interactive transcript, AI-generated meeting summaries, extracted to-do items, and other in-depth insights. It also supports locating and exporting key content. [Click here](#) to learn more about the features of the InSight website.

### Tips:

- This is an optional feature and does not affect the core hardware performance or daily use of the device.
- As a Link 2 Pro or Link 2C Pro user, you will receive 300 minutes of free transcription time to try the feature. For longer recording time, more transcription minutes, or access to advanced features, you can choose a paid subscription.
- [Click here](#) to learn more about InSight.

## Other Useful Features

- **Insta360 Insight (Meeting Assistant):** After logging into your account, the software can automatically transcribe recorded audio into text transcripts, meeting summaries, and AI insights to improve meeting efficiency. Your history can be viewed within the client.
- **Remote Control:** Ensure your phone and the camera are on the same Wi-Fi network. Scan the QR code in the client to remotely control the field of view, switch modes, and more through your phone's browser.
- **Toolbar Mode:** Click to minimize the client into a floating toolbar, allowing you to quickly access core functions while using third-party software (such as video conferencing apps).
- **Virtual Camera Usage:** This allows you to use all software enhancement features (such as Beautify & Makeup, Background Blur, Background Replacement, Bokeh, and Green Screen Keying). Please select "Insta360 Virtual Camera" from the camera device list in your streaming software (e.g., OBS, StreamLabs). See below for detailed operation methods.

## Advanced Use

### AI Tracking and Auto Framing

AI Tracking and Auto Framing automatically identify and lock onto subjects in the frame. As you move, the camera uses gimbal rotation and smart zoom to track you continuously, ensuring you remain centered and providing an optimal perspective for video conferences, online classes, and live streaming. You can customize tracking zones, no-tracking zones, tracking speed, and composition within the client.

- **Link 2 Pro:** Long-press the directional axis in the client to control gimbal movement; click the buttons for digital zoom.
- **Link 2C Pro:** Use the buttons for digital zoom; after zooming in, you can drag the frame to adjust the composition.

### Operation Guide

- **Gesture Recognition:** Quickly activate this feature using the gestures described in the "First Use" chapter.
- **Touch Key (Link 2 Pro Only):** Single-tap the Touch Button on the camera to quickly enable or disable AI Tracking. Ensure that "Tap /Touch once to activate AI Tracking" feature is turned on under "Settings" > "Camera".

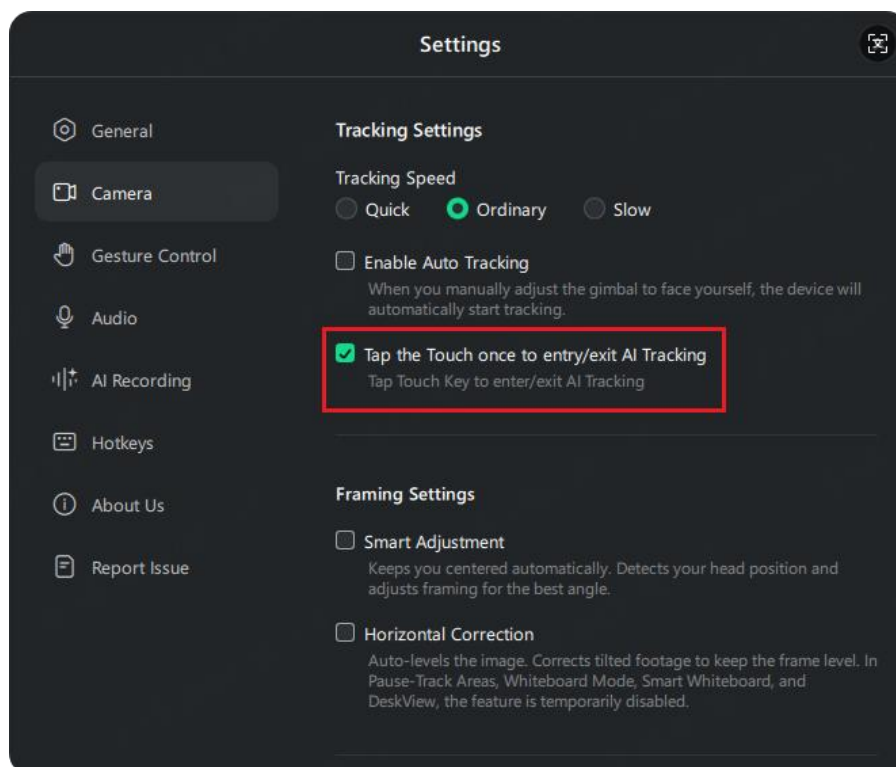

- **Client Control**

1. Open the client and click the "**AI Tracking**" or "**Auto Framing**" icon in the bottom control bar to toggle the feature.
2. Click the "A" icon to the right of the button to access more settings. **Link 2C Pro** allows for Head or Half-body framing adjustments; **Link 2 Pro** offers options for single or multi-person tracking, smart composition, tracking areas, pause-track areas and more.

### Link 2 Pro

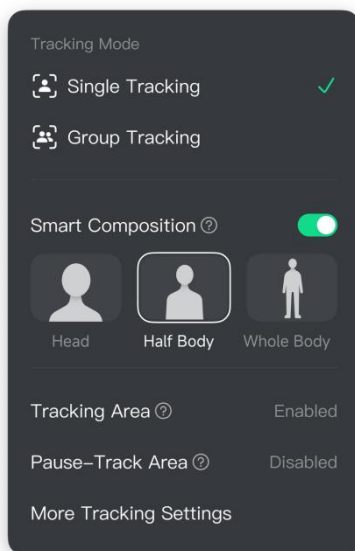

### Link 2C Pro

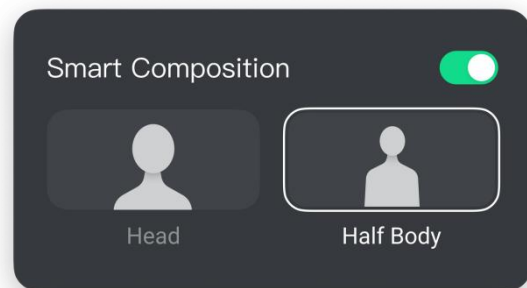

### Tips:

- By default, AI Tracking uses Single-Person Tracking and Gesture Control.
- Do not block your face when using gestures to avoid recognition failure.

### Advanced Operations via Insta360 Link Controller

1. Open the client.
2. Click to enable the **[AI Tracking]** feature. Once the camera identifies a person, the indicator light will turn cyan, and tracking will begin.
3. Once enabled, the camera will automatically identify and track the main subject (single person), keeping them centered in the frame.

## Multi-Person Tracking

- Intelligently adjusts the composition to ensure everyone in the frame is included.
- When there are two or more people in the frame, if you wish to track a specific individual, select **Single Tracking Mode**, then manually click the detection box over the target person's face in the preview area. The camera will switch to tracking the selected person.

## Smart Composition

Once enabled, you can choose between Head, Half Body, or Whole Body. This feature only takes effect when tracking is active.

## Tracking Zone

Once enabled, the camera will only track within the specified area, making it easy to protect your privacy.

- **Requirement:** Only applicable to Single-Person Tracking mode.
- **Setup Method:**
  - In the AI Tracking settings, click to enable **[Tracking Area]**.
  - Enter the angle adjustment page. You can click the directional arrows or drag the frame to adjust the angle and set the boundaries.

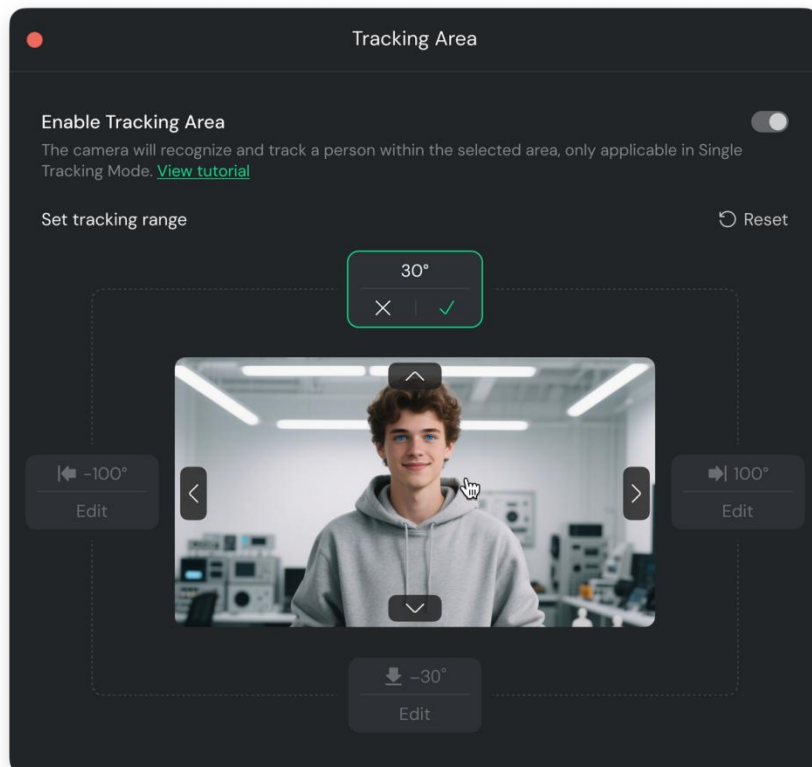

Only one boundary angle can be edited at a time. After clicking "✓" to save, you can adjust the next boundary angle value. You can adjust the boundary angles for the "Top, Bottom, Left, and Right" directions as needed. Once the boundary angle adjustments are complete, the tracking range will be restricted to this area.

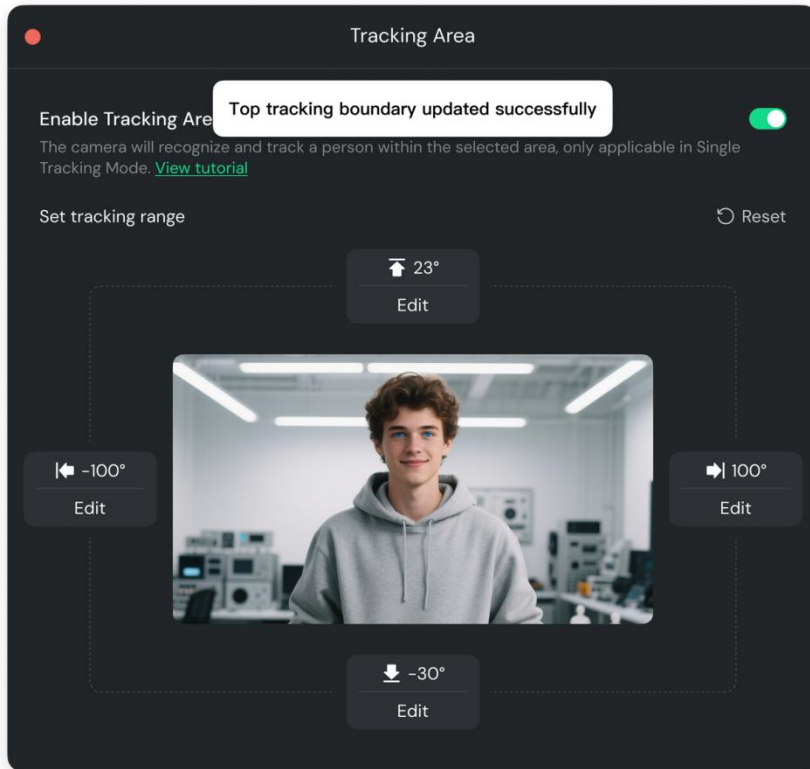

### Pause-Track Area

This feature allows you to set specific areas within the frame. When the tracked subject enters these areas, the camera will stop tracking and keep the lens steady. This is suitable for scenarios requiring a fixed frame, such as product demonstrations or presenting in front of a whiteboard.

- **Requirement:** Only applicable to Single-Person Tracking Mode.
- **Setup Method:**
  - Find the "Pause-Track Area" option in the AI Tracking settings.
  - You can directly drag the mouse on the preview screen to draw rectangular areas. Up to 6 no-tracking zones can be set.
  - **(Optional)** You can draw or import a panoramic view of the room to visually preview the corresponding positions of each no-tracking zone in physical space.

### More Settings

You can adjust tracking speed, enable/disable Auto Tracking (the device starts tracking automatically when the camera is facing you), framing settings (Smart Adjustment, Horizontal Correction), compatibility settings (Portrait Resolution, Enable Low Resolution), etc.

#### Tips:

- AI Tracking only supports tracking human faces; it does not support tracking hands, objects, or animals.
- If no human face is detected for 60 consecutive seconds, AI Tracking will automatically turn off.
- When both "Tracking Area" and "Pause-Track Area" are enabled, all no-tracking zones must be entirely within the boundaries of the tracking zone to function properly.
- If a no-tracking zone is partially or fully outside the tracking zone's boundary, it will be retained but cannot be activated, and the camera will ignore the no-tracking command for that area.

### Whiteboard Mode

#### Whiteboard Mode (Regular)

Whiteboard Mode offers two convenient ways to use whiteboards: Gesture Recognition for standard white rectangular whiteboards without recognition stickers, and the Whiteboard Mode button in the client for whiteboards or any flat surface with recognition stickers, allowing for efficient presentations.

#### Operation Guide

- **Gesture Recognition:** Quickly activate Whiteboard Mode using the gestures described in the First Use chapter. This method is particularly suitable for temporary, quick explanations when the whiteboard is in a fixed position.
- **Client Control:** Open the client and click "Whiteboard Mode" at the bottom of the software interface to toggle the feature.

### Smart Whiteboard

In Smart Whiteboard Mode, recognition stickers are not required. The client automatically recognizes or allows you to manually set the whiteboard area, which is then automatically corrected and displayed in full screen. This mode is ideal for complex scenarios, such as working off-site or using multiple whiteboards.

**Note:** Before using Smart Whiteboard or background recognition features, please enable **Insta360 Virtual Camera**. When using this mode in third-party software, you must select **Insta360 Virtual Camera** as the video stream.

#### Operation Guide:

1. Open the client.
2. Click "**Smart Whiteboard**" at the bottom of the software interface to toggle the feature.

Whiteboard Mode supports the recognition of regular standard whiteboards without corner markers. When paired with recognition stickers, it can customize specific whiteboard areas, such as blackboards, green boards, walls, or monitors. Smart Whiteboard Mode supports both regular whiteboards without stickers and any whiteboard or area with stickers.

### FAQ

#### Can the device switch to vertical mode while in Whiteboard Mode?

Yes. You must set the device to Portrait Mode first, and then enable Whiteboard Mode.

#### Are the whiteboard recognition stickers reusable? Do they need glue to enhance stickiness when reused?

- The whiteboard recognition stickers are reusable approximately 100 times.
- Simply stick them directly onto the surface when reusing; you can also use double-sided tape to help secure them if needed.
- If stickers are lost or the stickiness is significantly reduced, you can purchase replacement stickers at the official Insta360 Store.

## DeskView Mode

1. Click **DeskView Mode** in the client, and the gimbal will automatically tilt the camera downward.
2. Manually adjust the Magnetic Mount until an ideal overhead angle is achieved.

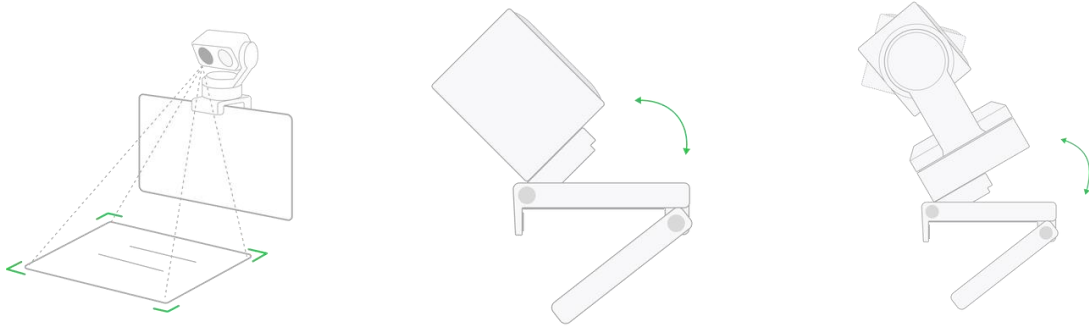

\*You can further adjust the mount manually to get the best angle.

Link 2 Pro achieves DeskView Mode by adjusting the gimbal angle.

Link 2C Pro achieves DeskView Mode by manually adjusting the mount and fine-tuning the angle via the Link Controller.

### Tips:

- In DeskView Mode, virtual background features (including Background Blur, Bokeh, Background Replacement, and Green Screen Keying) will be temporarily disabled.
- If the device fails to enter DeskView Mode, try tilting the device forward and try again.



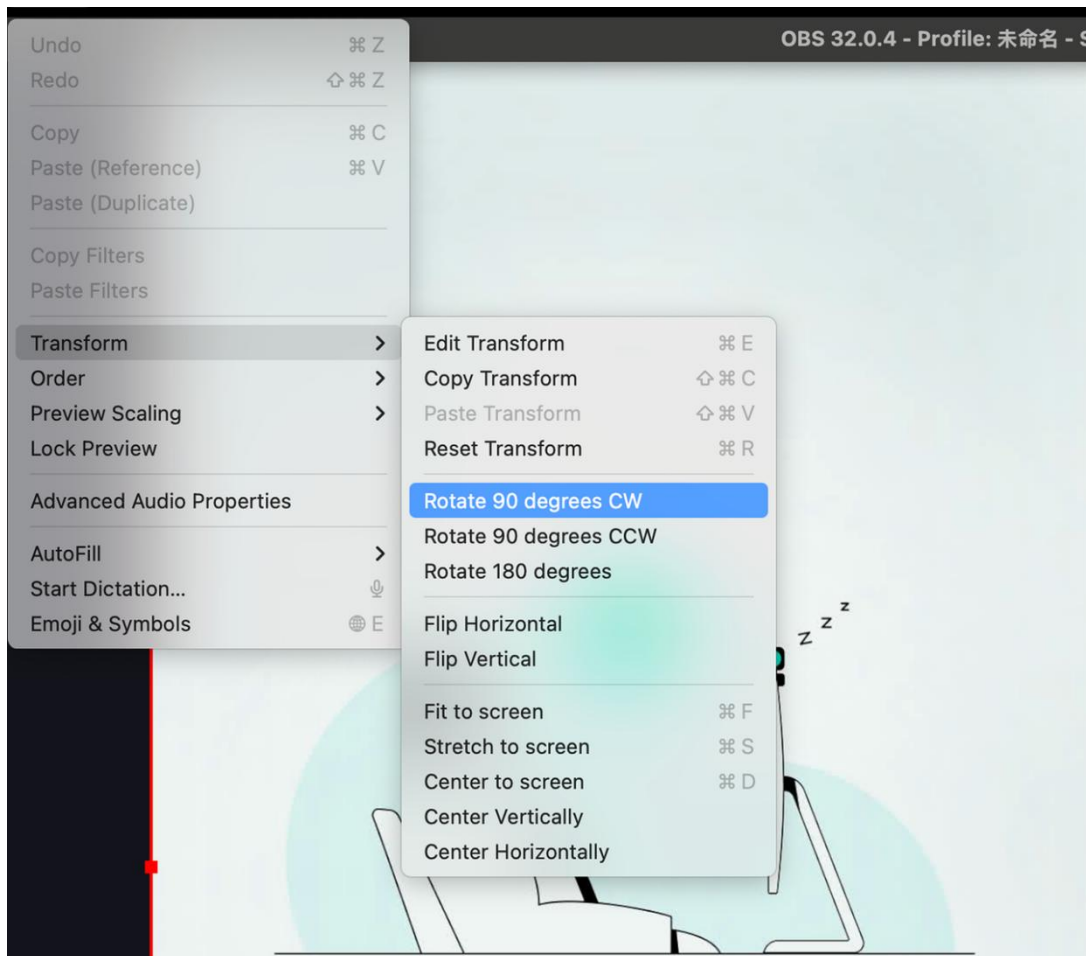

- **Client Settings:** On a Mac computer, you can keep the client preview enabled at the same time. On a Windows computer, please turn off the client preview; otherwise, OBS may fail to properly obtain the camera video stream due to resource usage.

## 2. Alternative Option: Switch Resolution in the Client

This method is primarily used for scenarios where third-party software (such as video conferencing apps) needs to directly recognize and preview a vertical frame.

- **Physical Preparation:** Use a tripod to position the device vertically.

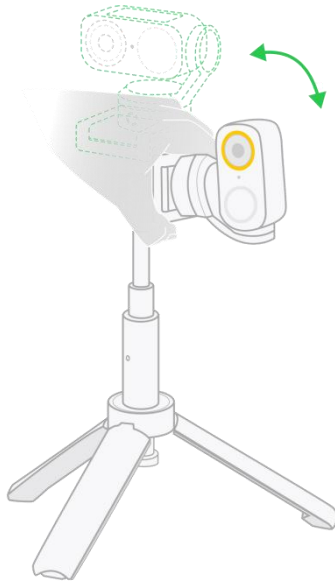

- Client Settings: Click the Settings button in the top-right corner of the client, go to "Camera" > "Compatibility Settings," and enable "Portrait Resolution."
- Once enabled, the camera's output stream will be in a native vertical format. You can see the correct vertical preview in other software without needing to rotate the canvas manually.

## Two Camera Signal Sources

- **Physical Camera (Insta360 Link 2C/2 Pro):** Directly accesses the camera hardware to provide basic video, AI tracking, and microphone functions.
- **Virtual Camera (Insta360 Virtual Camera):** An advanced video stream generated by the Insta360 Link Controller software. **You must select this option** to use all advanced features, including Beautify & Makeup, Virtual Backgrounds (including Green Screen Keying), Filters, and Smart Whiteboard. Select **[Insta360 Virtual Camera]** as the video source in your meeting or live streaming platform to output these effects.

**Tips:** If your macOS version is 15.0.1 or later, go to "System Settings" > "General" > "Login Items & Extensions" > "Camera Extensions", enable the client permission, and restart the client for the feature to take effect.

## Configuring the Camera in Streaming Software

### General Setup Steps:

1. Open your live streaming software (e.g., OBS, StreamLabs, etc.).
2. Add a video source and select [Camera] or [Video Capture Device].
3. **Key Selections:**
  - If you only need basic tracking and video, select "Insta360 Link 2C/2 Pro" (or the corresponding model). Then choose the appropriate resolution based on your streaming canvas (Landscape/Portrait).

For platforms like TikTok and Zoom, it is recommended to set the resolution as follows (Landscape / Portrait): 1920x1080 or 3840x2160 / 1080x1920 or 2160x3840.

- To use advanced features like Beautify or Virtual Backgrounds, select "Insta360 Virtual Camera." Additionally, when using Beautify features, please ensure you are connected to the internet and set the resolution to 1080p.

### Important Notes:

- **Stream Occupancy Rule (Windows):** The video stream from a single physical camera cannot be accessed by multiple software applications simultaneously. Before opening your streaming software, please close any other applications that might be using the camera (such as video conferencing apps).
- **Ensure the Client is Running:** When using the "Insta360 Virtual Camera," the Insta360 Link Controller client must remain running in the background at all times.

## Using the Camera via OBS Studio

OBS is a professional live streaming and recording software that supports high levels of customization.

### Adding a Physical or Virtual Camera

1. In the OBS "Sources" panel, click "+" → select "Video Capture Device."

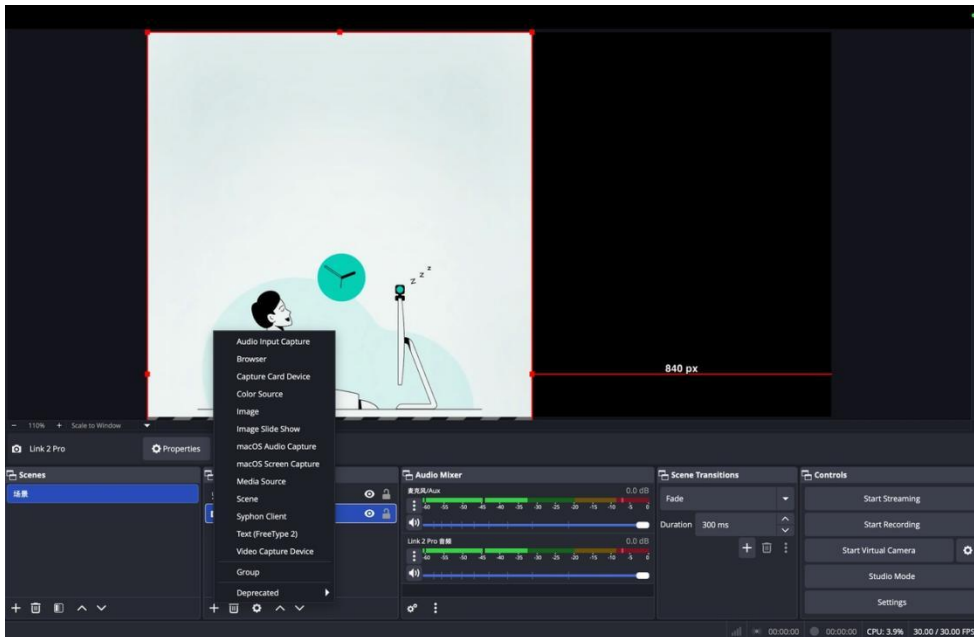

2. In the settings pop-up, check "Create new," enter a camera name, and click "OK." In the "Device" dropdown menu of the next pop-up, scroll down and select your target Link series camera.

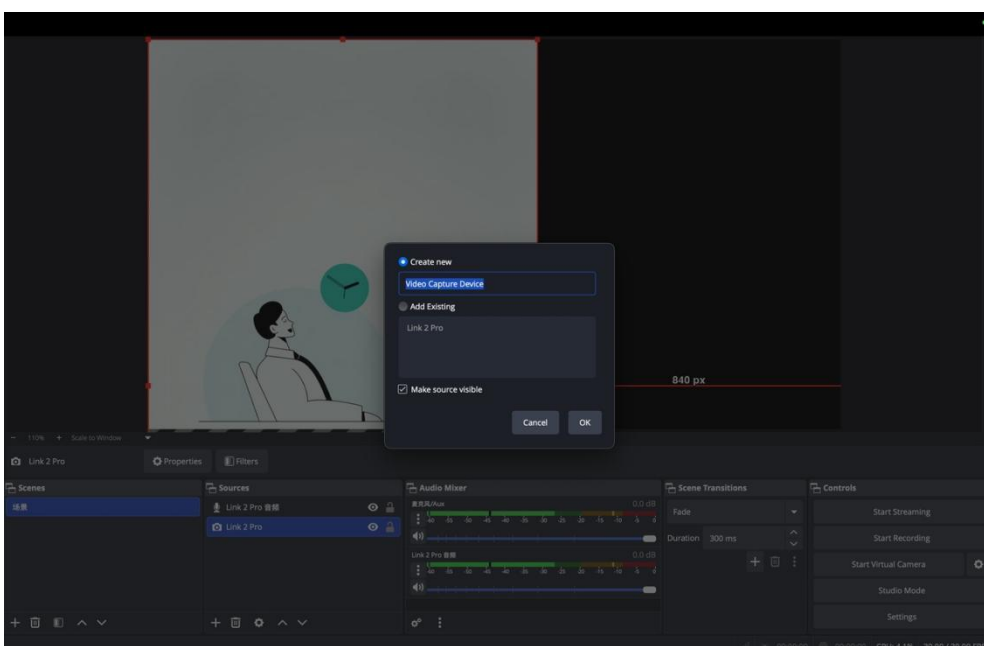

- When creating a new source or selecting an existing one, in the "Device" dropdown menu:
  - Select the camera labeled with the device model for basic features.
  - Select "Insta360 Virtual Camera" for advanced features (the virtual camera feature must be enabled in the Link Controller first).

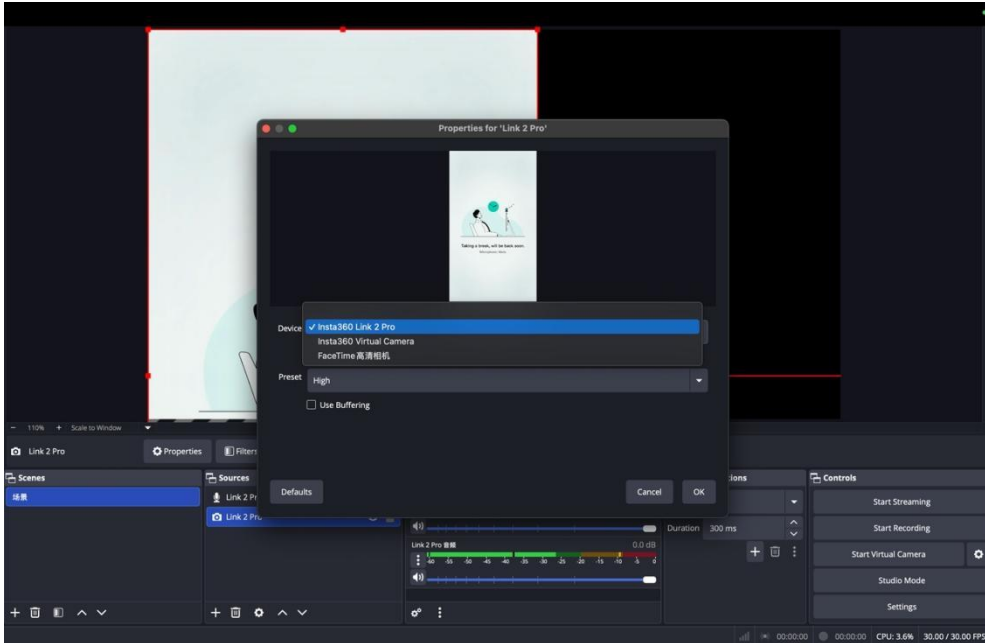

### Adding the Camera Microphone as an Audio Source

- In the OBS "Sources" panel, click "+" → select "Audio Input Capture."

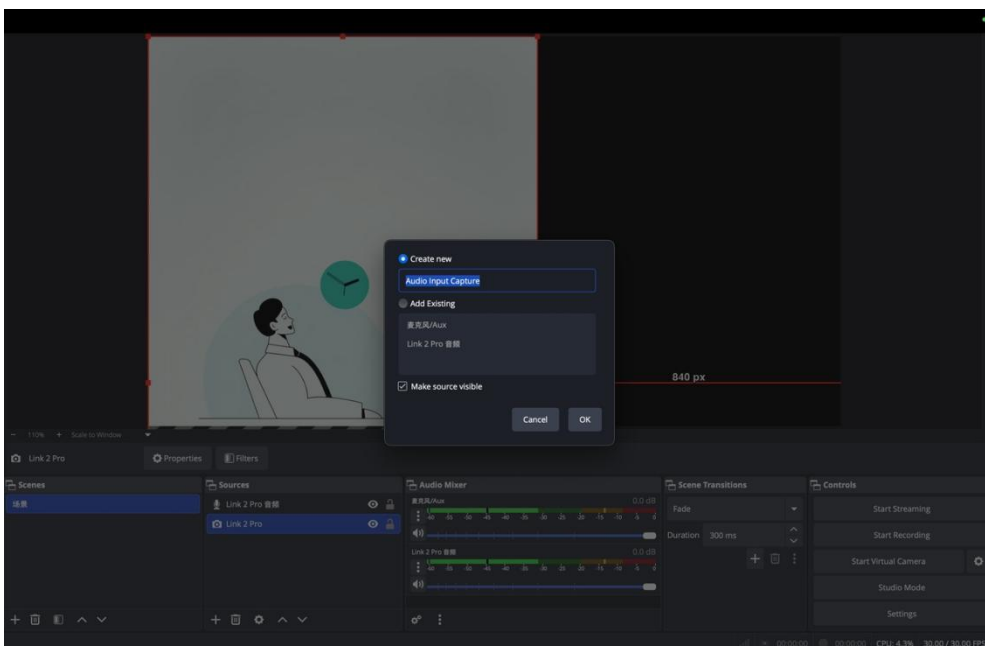

2. Check "Create new," enter a microphone name (e.g., "Link 2 Pro Audio"), and click "OK." In the "Device" list, select the microphone of your target Link series camera and click "OK."

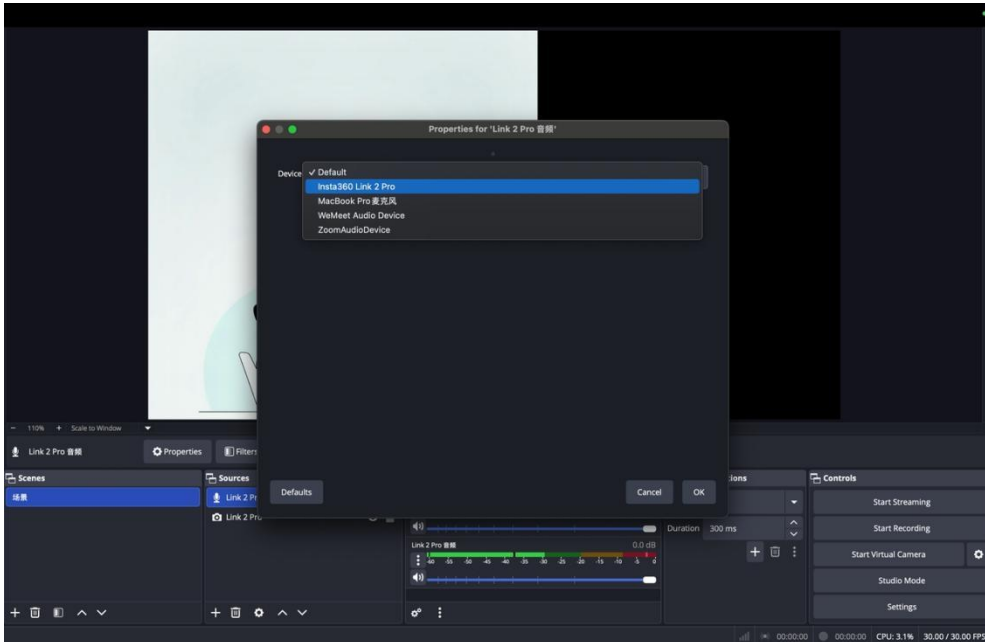

### Notes

- You can add multiple camera sources by repeating the steps above.
- The physical and virtual cameras of the same device cannot output active video simultaneously. If one is in use, the other may display a black screen.

## Advanced Application – Green Screen Keying Live Stream

### 1. Setting up Keying in the Client:

- Open the client and go to the "Effects" tab.
- In "Background" settings, select a virtual background or upload an image/video.
- Check "Green screen available", the system will automatically recognize the backdrop color in the environment and optimize the keying parameters to quickly achieve an initial chroma key effect.

If you are not satisfied with the result or if the environment changes, you can choose to:

- Click "**Auto Color**" for one-click keying, or use the eyedropper tool to manually sample a color within the video frame for keying;
- Use the sliders to fine-tune the details until the keyed edges are clean and the subject appears natural:
  - Background Color: Adjust the range of background removal during keying to display the subject more completely.
  - Edge Smoothing: Optimize the transition between the subject and the background, making the edges appear more natural.
  - Reduce Reflection: Minimize the impact of background lighting on the subject, making the subject's colors more pure.
  - Detail Enhancement: Enhance details such as hair and clothing to make the subject appear more realistic and natural.

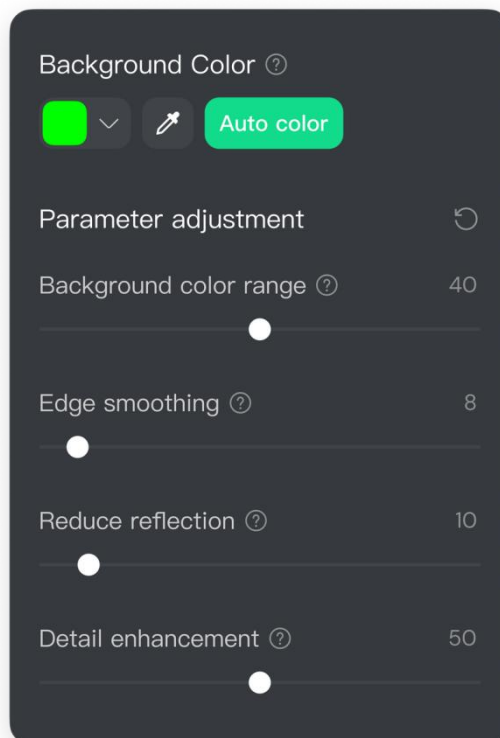

## 2. Selecting the Signal Source in Streaming Software:

- When adding a camera to your streaming software, select "**Insta360 Virtual Camera.**"

### 3. Real-time Synchronization:

- Any adjustments made in the client—such as toggling AI Tracking, changing Beautify & Makeup intensity, adjusting image parameters (brightness, contrast, etc.), or switching virtual backgrounds and filters—will be synced to the streaming software's preview in real time.

#### Tips:

- Use the "**Auto color**" function to quickly achieve ideal keying results and reduce manual adjustments.
- It is recommended to use green or blue screens for the best keying results.
- Ensure the screen is flat and wrinkle-free, and that the lighting is as even as possible.
- Maintaining a distance (recommended  $\geq 1$  meter) between the person and the green screen can effectively reduce color spill.

## FAQ

### **If I restart my computer and use streaming software without opening the client, will the camera maintain the previously set audio control mode by default?**

In non-vertical 4K high-resolution modes, the camera will maintain the last set audio mode by default even if the computer is restarted and the client is not open.

### **Can I use the microphone separately without using the camera?**

Yes, the microphone can be used independently. For example, in a Teams meeting, you can turn off the camera and use the Link series microphone alone.

## Ecosystem Integration

### Using Elgato Stream Deck to Control Link 2 Series Cameras

By integrating with Stream Deck, you can map frequently used functions of Link 2 series cameras to Stream Deck keys, enabling quick settings and control without needing to use the client interface.

#### Software Installation and Setup

1. Ensure both the camera and Stream Deck are connected to your computer.
2. [Download](#) and open the Elgato Stream Deck software. Search for and install the "Insta360 Webcam" plugin in the plugin store. If the search fails, you can also download the plugin and install it manually.
3. Once installation is complete, the "Insta360 Webcam" option will appear in the software sidebar, featuring the following three categories of control functions:
  - **Webcam Configuration**
  - **Adjust Webcam**
  - **Reset Webcam**

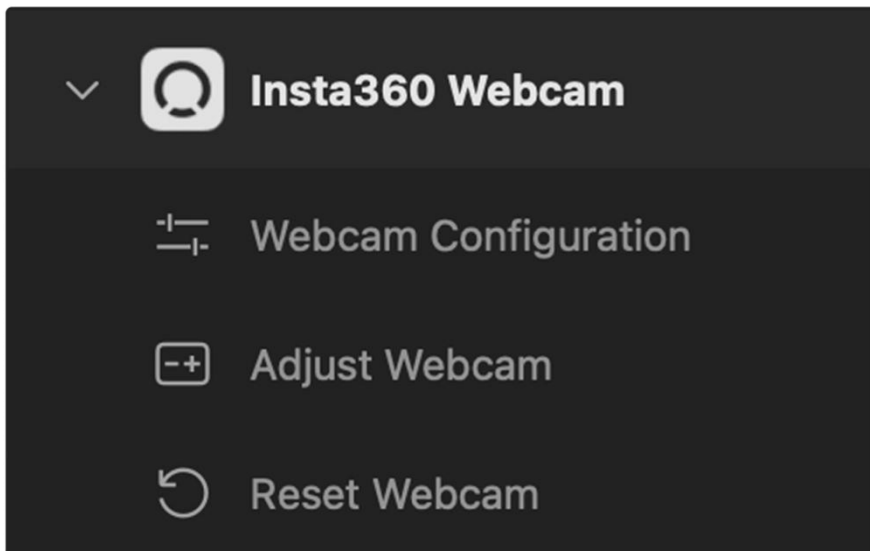

## Operation Guide

### 1. Webcam Configuration

This function is used to set camera parameters to a predefined fixed value with a single click or to act as a toggle for specific features.

- **Parameter Preset Example:** Drag and drop "Webcam Configurationa" onto a key, enter a button title, select the camera, and choose the "Color Temperature" function with a value set to "10000." Once pressed, the color temperature will immediately adjust to 10000K, regardless of the current setting. This applies similarly to other adjustable parameters like brightness and saturation.
- **Feature Toggle Example:** Set the key function to "AI Tracking On/Off." Pressing this key will enable or disable the AI tracking feature. Pressing it again will toggle the state.

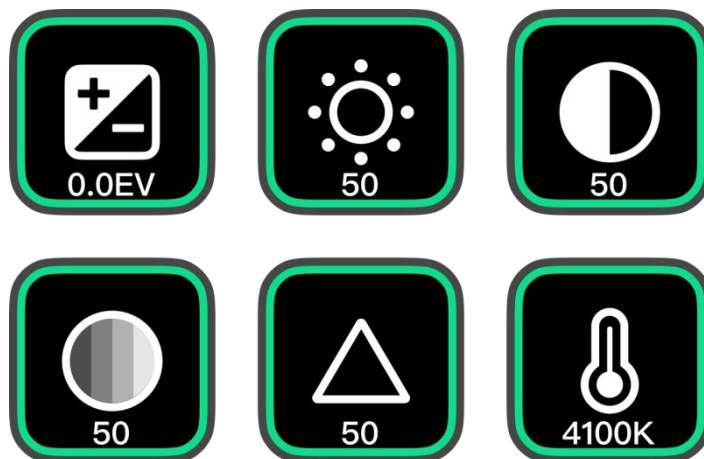

### 2. Adjust Webcam

This function is used to adjust the camera incrementally by a set amount.

- **Operation Example:** Drag and drop two "Adjust Webcam" functions onto two separate keys.
- Key 1: Select "Zoom" for the function and set the increment to "+0.1" (Zoom In).
- Key 2: Select "Zoom" for the function and set the increment to "-0.1" (Zoom Out).
- By repeatedly pressing these two keys, you can gradually zoom the field of view in or out.

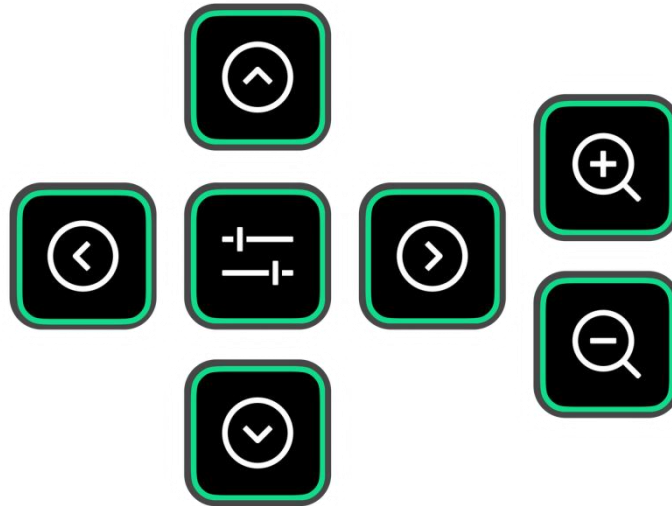

### 3. Reset Webcam

This function is used to restore one or all of the camera's settings to their initial state.

- **Single Reset Example:** Set the key function to "Brightness." If you are unsatisfied with the brightness adjustment, press this key to restore the brightness value to its standard initial value.
- **Reset All:** Set the key function to "All Parameters." Pressing the key will restore all image and function settings of the camera to factory default states.

**Tips:** If using macOS, you need to open System Preferences and grant permissions to Stream Deck to trigger the keys.

## Customizing Control Panel Layout

Users can customize the panel layout. You can partially modify preset buttons or click the page numbers below to set up a new page. Here is a suggested layout for the Stream Deck control panel, which you can customize based on your personal habits:

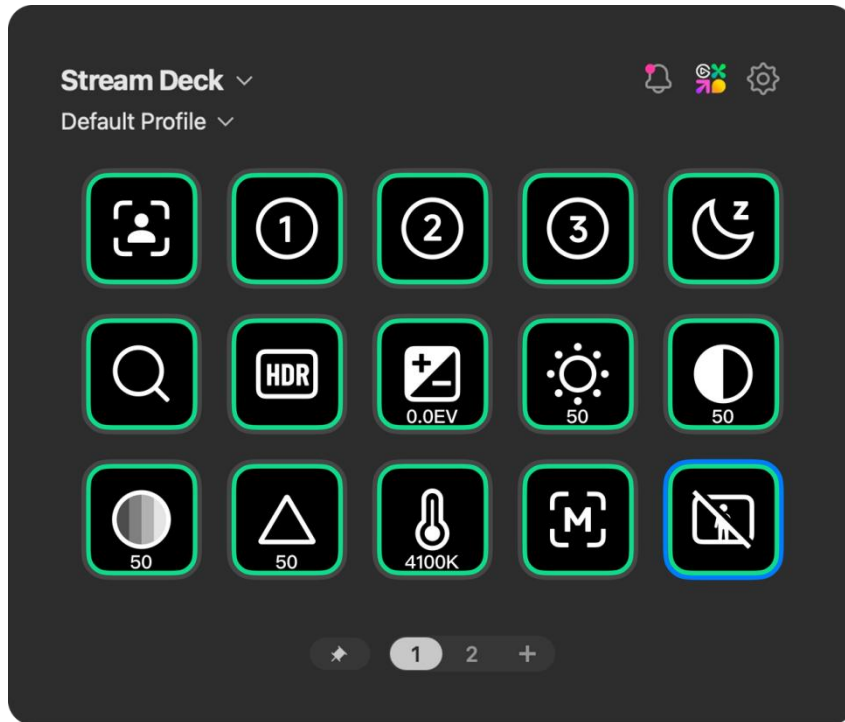

- **Central Area (Directional Control):** Place five "Adjust Webcam" keys with functions set to: Gimbal Up, Down, Left, Right, and "Gimbal Reset."
- **Left and Right Sides (Zoom Control):** Place two "Adjust Webcam" keys with the "Zoom" function, setting the increments to "+0.1" and "-0.1."
- **Other Keys:** You can place "Webcam Configuration" keys to quickly toggle frequently used functions, such as:
  - **AI Tracking On/Off**
  - **DeskView Mode On/Off**
  - **Adjusting exposure (brightness) to a specific value**
- **Preset Keys:** Place "Webcam Configuration" keys, select the "Preset" function, and specify sub-options (e.g., Preset 1, Preset 2).
  - **Saving a Preset:** First, adjust all parameters in the client (e.g., Beautify, Filters, Image settings, etc.). On the Stream Deck, click the corresponding preset key to save all current settings.
  - **Calling a Preset:** When needed, press the key to switch to the saved settings with one click.
  - **Updating a Preset:** After modifying parameters in the client, return to the Stream Deck and long-press the corresponding preset key for 3 seconds to refresh and save the new settings.
  - **Examples:**

- **Preset 1:** General Live Stream settings (Enable Beautify, Makeup, Auto Tracking).
- **Preset 2:** Green Screen Live Stream settings (One-click keying and virtual background replacement).
- **Navigation Keys:** You can place the default Stream Deck "Previous Page" and "Next Page" navigation keys in the corners of the panel to switch between different control pages.

### Notes

When calling functions involving Beautify, Makeup, Virtual Backgrounds, Filters, and certain image parameters via Stream Deck, ensure the client is running in the background for the settings to take effect.

## Multi-Camera Real-Time Control

You can use Stream Deck as a real-time control console to adjust camera angles and various settings without ever opening the settings menu.

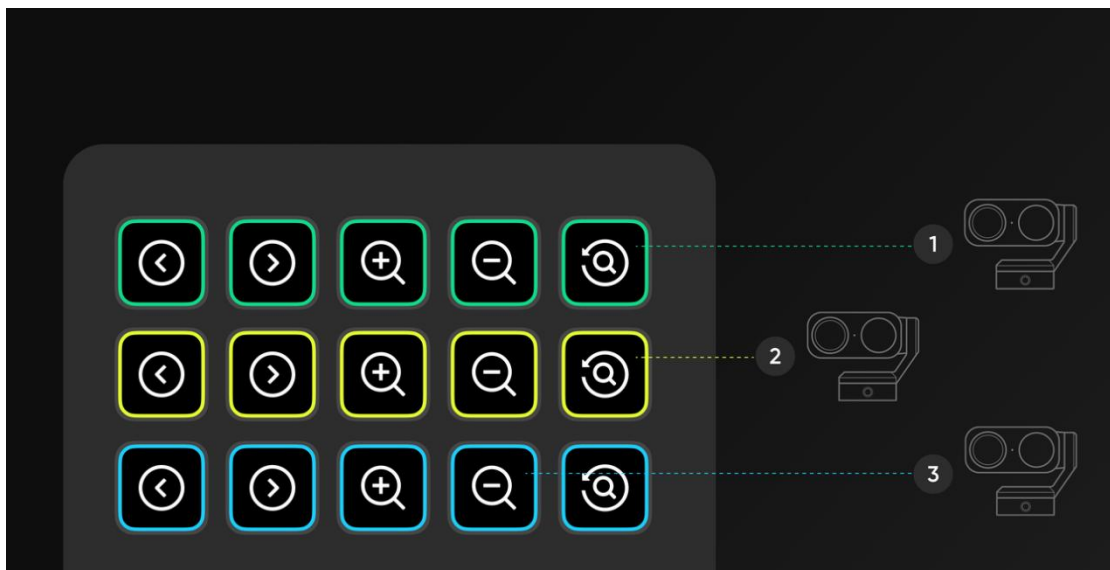

### Tip 1: Preset Workflow

Set up one-tap switches for multiple cameras, saving time and allowing for easier use.

Preset Button Operation Logic:

- First Click (when the button has no preset): Save the current state of all storable camera settings as a new preset.
- Subsequent Clicks (when the button already has a preset): Quickly switch to the saved state of the preset with a single click.
- Long press for 3 seconds (when the button already has a preset): Overwrite the existing preset with the camera's current new state.

### Tips:

1. Feature Permissions: The scope of preset content stored and called via Stream Deck depends on the current operating environment.
  - Hardware only (without running the Link Controller client): You can only preset and call parameters directly related to the camera hardware, such as gimbal position, digital zoom, and AI modes (including AI Tracking/Auto Framing, Whiteboard Mode, and Deskview Mode).
  - Full functionality (with the Link Controller client running in the background): You can preset and call all software parameters, including the hardware parameters and AI modes mentioned above, as well as effect settings (such as virtual background, filters, makeup, beautify), and image settings.
2. Operation Interval: When switching between different presets using Stream Deck, it is recommended to allow at least 3 seconds between operations. Clicking too quickly in succession may cause some commands to fail due to device response delay.

Operation Workflow:

- Set up the shot: In the Insta360 software or on the Stream Deck, point Camera A at the face. Adjust the exposure to ensure the face is well-lit.
- Save to Stream Deck:
  1. Drag the "Webcam Configuration" action from the Insta360 list onto a key.
  2. In the Stream Deck software, select "Preset."

3. Choose Camera A.
  4. Name the key: "Camera A: Close-up."
- Create a wide-angle shot: Now, create a new preset, adjust the camera to a wider angle. Long-press the preset key for 3 seconds to save it, and name it "Camera B: Wide."
  - Repeat: You can point Camera C at the presentation whiteboard and repeat the steps above to save the preset.
  - Result: You can now instantly switch between wide shots and close-ups for any guest with a single button press, without affecting the quality of the independent recording.

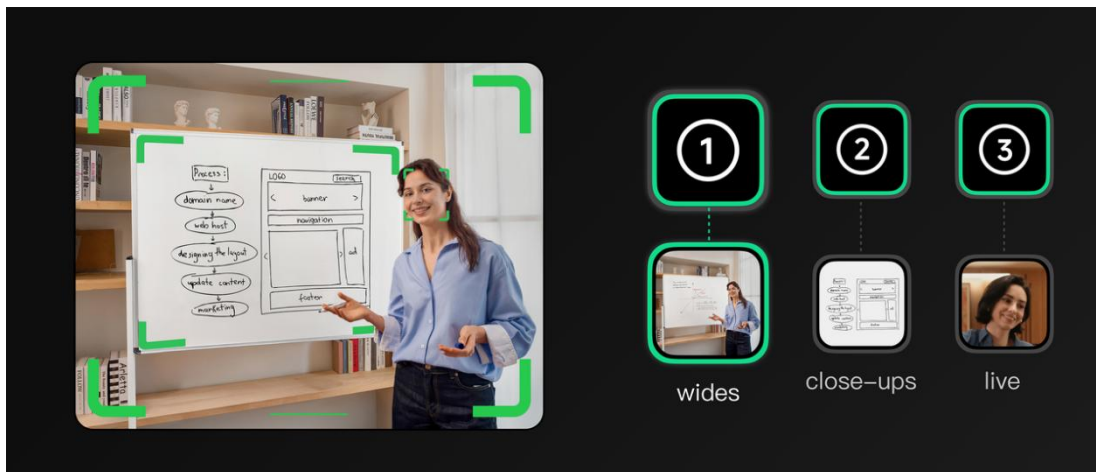

### Tip 2: Real-Time Manual Adjustments During Recording

You can adjust guest framing and image settings during recording without opening the client software.

- **Gimbal Adjustment:** Drag the "Adjust Webcam" action to the Deck and select gimbal movement. This creates a "joystick" on your Stream Deck (Up/Down/Left/Right/Zoom). If a guest moves out of frame, you can physically move the camera gimbal to follow them.
- **Image Settings:** Drag the "**Webcam Configuration**" action to a key.
  - Configure it to control Exposure or White Balance.
  - If a camera shot looks too dark during recording, tap this key to immediately brighten the raw hardware footage.

## Advanced Application – Multi-Camera Live Streaming

In professional podcasts, interviews, or multi-camera production scenarios, you may need to record separate video streams for each webcam (known as "Isolated Recording" or "ISO Recording") to allow individual adjustment of each camera angle during post-production. The following introduces two methods to achieve this in OBS Studio. You need to follow the specific workflow below. This workflow supports recording up to three cameras simultaneously.

### Pre-recording Checklist:

- GPU Performance: Ensure your computer has a dedicated graphics card (e.g., NVIDIA RTX series) to handle multi-channel video encoding.
- Audio Test: Before starting the official recording, be sure to test whether each microphone is accurately recording to an independent audio track.
- Disk Space: ISO recording consumes a significant amount of space. Please reserve 3–4 times the storage space required for a regular recording.

In professional podcasts, interviews, or multi-camera production scenarios, you may need to record the footage from each Insta360 Link camera into a separate video file (ISO recording) to allow for independent adjustments during post-production. The following section introduces two methods to achieve this in OBS Studio.

### Method 1: Using the "Source Record" Plugin (Recommended)

This method uses a free plugin to create independent video files for each camera.

1. Install the Plugin: Download the "[Source Record](#)" plugin from the official OBS Resources forum. After installation, restart OBS.
2. Add a Filter:
  - Add your camera source to a scene.
  - In the "Sources" list, right-click Camera A > select "Filters."

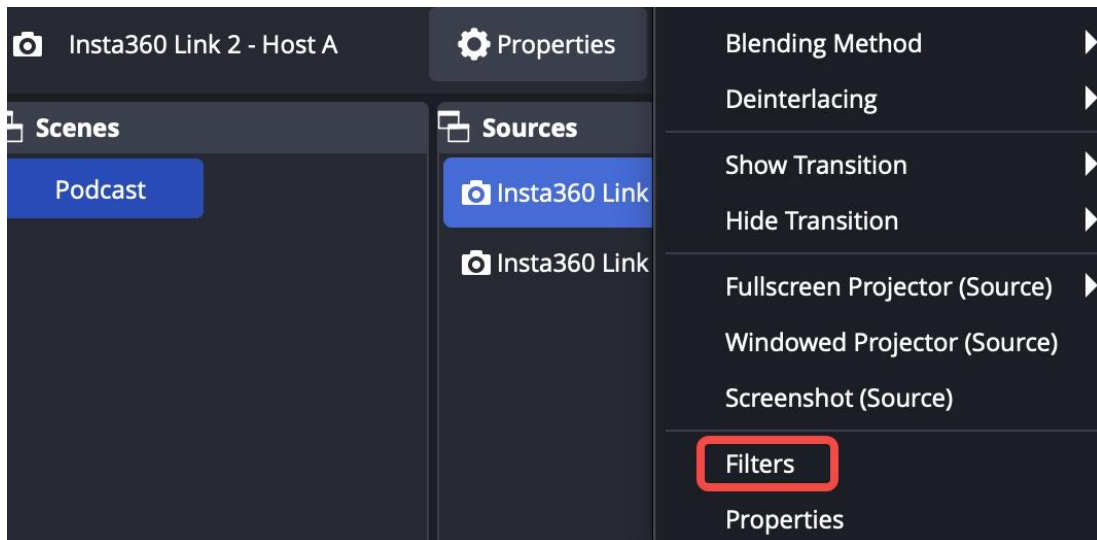

- Click the "+" icon under "Effect Filters" and select the Source Record plugin.

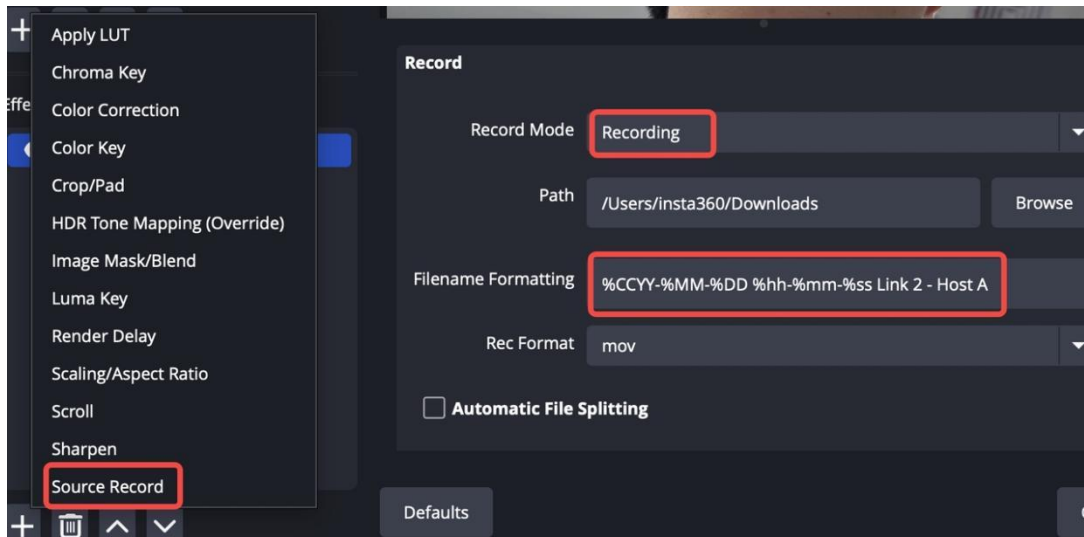

### 3. Encoding Settings:

- Name: Give this recording source a name, such as "Host View."
- Record Mode: Set to "Recording" so it starts simultaneously when the main OBS recording button is clicked.
- Encoder: To reduce the load on your computer, ensure you select a hardware encoder:
  - Windows: Select NVENC (NVIDIA graphics cards) or Hardware Encoding (AMD graphics cards).
  - macOS: Select the Apple VT H264 Hardware Encoder.
  - Avoid using x264 software encoding for all cameras, as this may lead to insufficient performance.

4. Repeat Settings: Repeat the steps above for any other Link cameras in the scene.
5. Start Recording: Once you click "Start Recording" in OBS, an independent lossless video file will be generated for each camera in addition to the main output file.

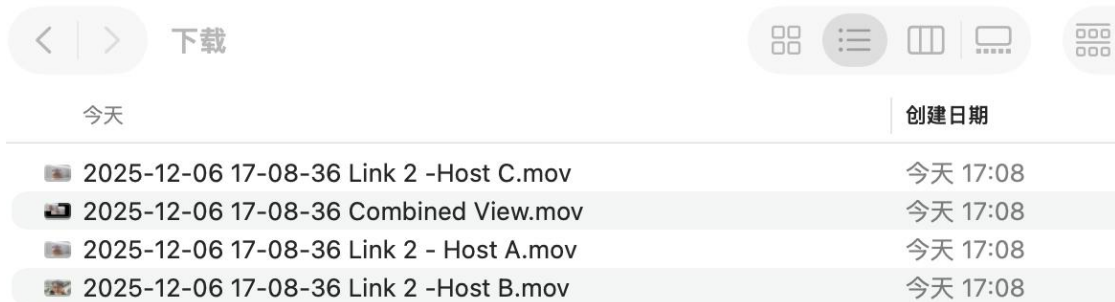
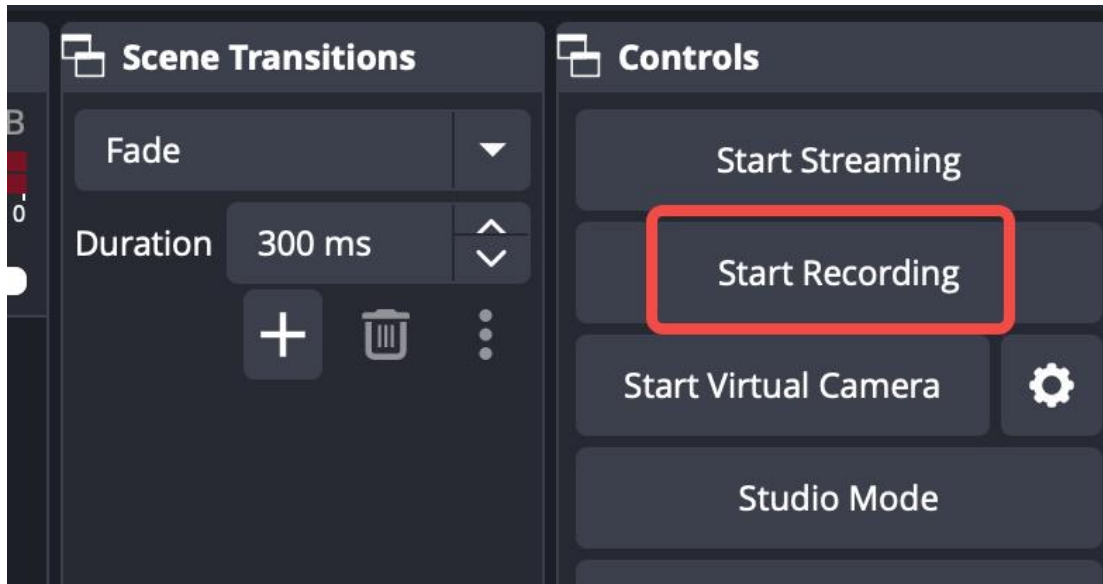

**Tips:** This method requires encoding four videos simultaneously, which demands high computer performance. If your computer resources are limited and you want to ensure audio-video synchronization, please consider Method 2.

### Method 2: "Ultra-Wide" Canvas

1. Change Canvas Size: Go to "Settings" > "Video" tab in the bottom-right corner of the OBS client.
  - Set "Base (Canvas) Resolution" to 5760x1080 (i.e., three 1920x1080 frames side-by-side).

- Set "Output (Scaled) Resolution" to 5760x1080.

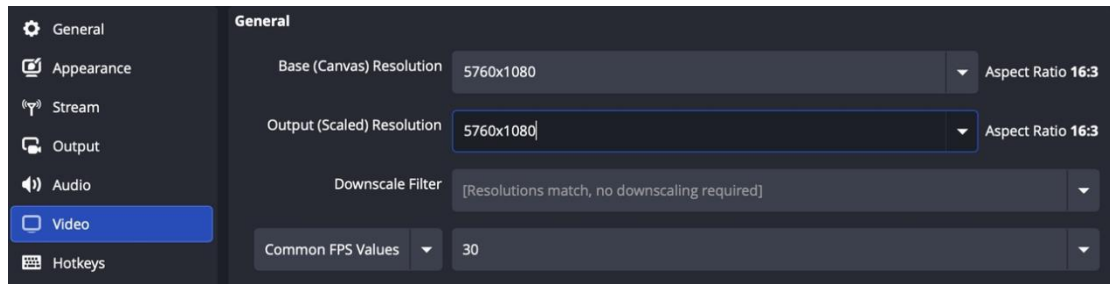

2. Arrange Cameras: In the scene, arrange the three camera sources side-by-side from left to right.
3. Post-production Editing: Import the resulting ultra-wide video file into editing software (e.g., Adobe Premiere Pro, DaVinci Resolve). Duplicate the video track and use the cropping tool to isolate each individual camera angle.
4. Audio Separation Settings

For podcasts, independent audio tracks are just as important as the video. Please complete the following settings in OBS:

- Go to the top menu bar "Edit" > "Advanced Audio Properties."
- In the "Tracks" area, assign an exclusive track to each microphone (e.g., for Microphone A, check only Track 1; for Microphone B, check only Track 2).

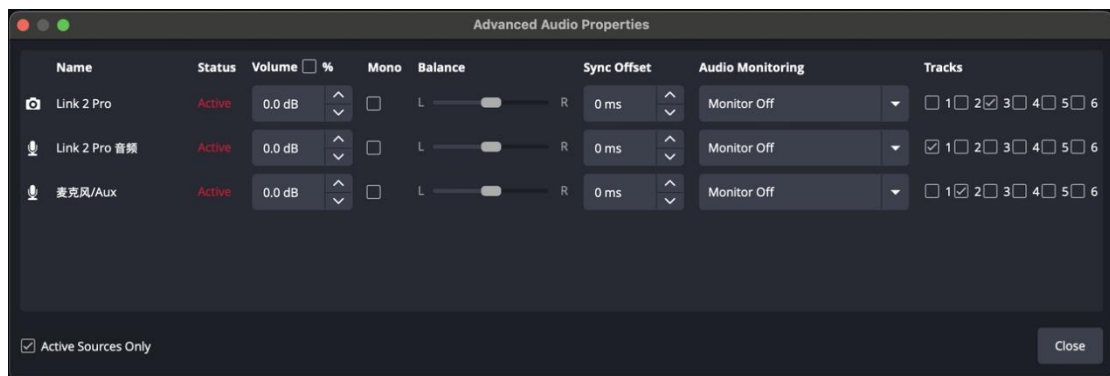

- Go to "Settings" > "Output", set "Output Mode" to "Advanced", and under the "Recording" tab, check the independent audio tracks you want to record (e.g., Track 1, Track 2). After recording, you will obtain audio files with separate tracks for editing.

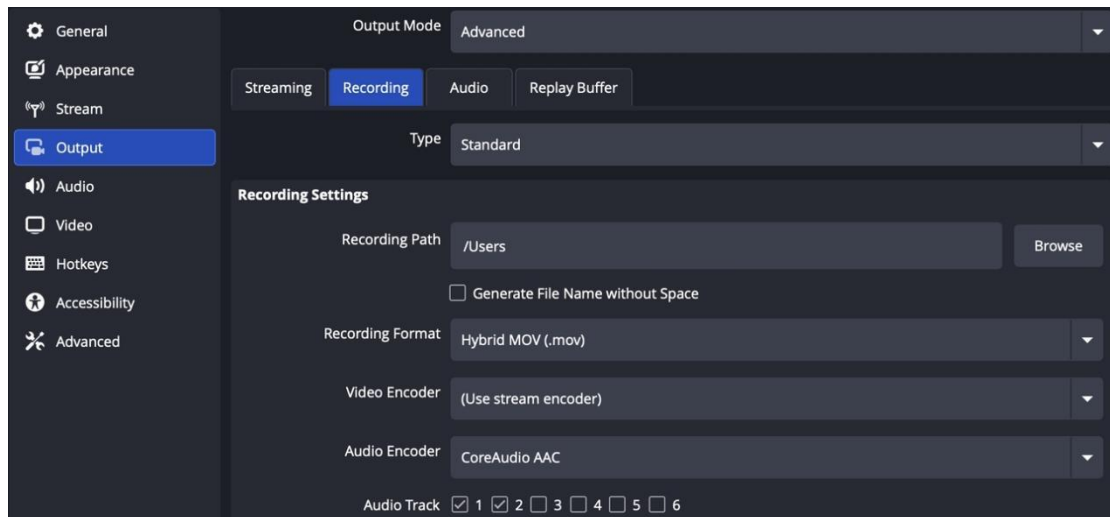

## Integration with Wave

Detach the main body of the Link 2 Pro from the magnetic mount and attach it magnetically to the top of the Insta360 Wave microphone. This setup is ideal for meetings or demonstration scenarios with specific requirements for audio pickup quality. For detailed instructions, [please refer here](#).

# Maintenance and Care

## Checking the Serial Number (SN)

### Method 1: Via the product packaging

Check the back of the packaging box, where the corresponding serial number label is attached.

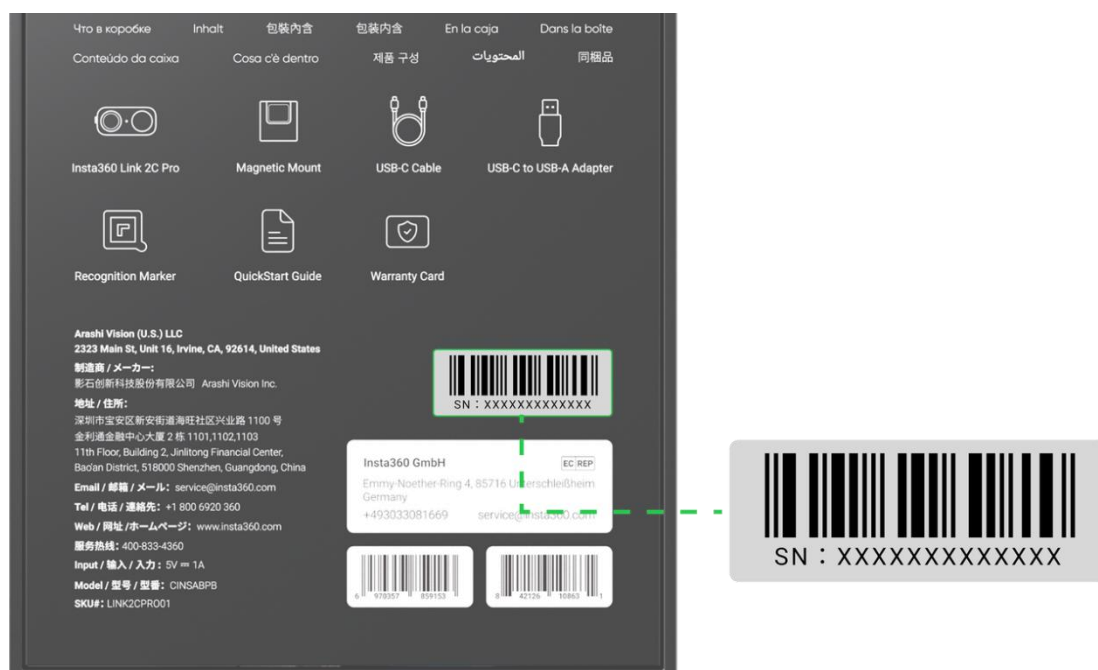

### Method 2: Via the client

1. Ensure the camera is connected to the Insta360 Link Controller client.
2. The serial number of the connected device is displayed in the upper-right corner of the client.

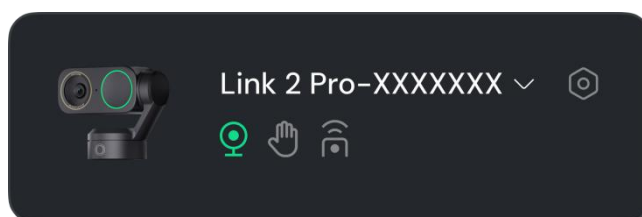

Alternatively, click the "..." icon in the control bar at the top-right of the client window, then go to "More Settings" > "About Us" to view the serial number.

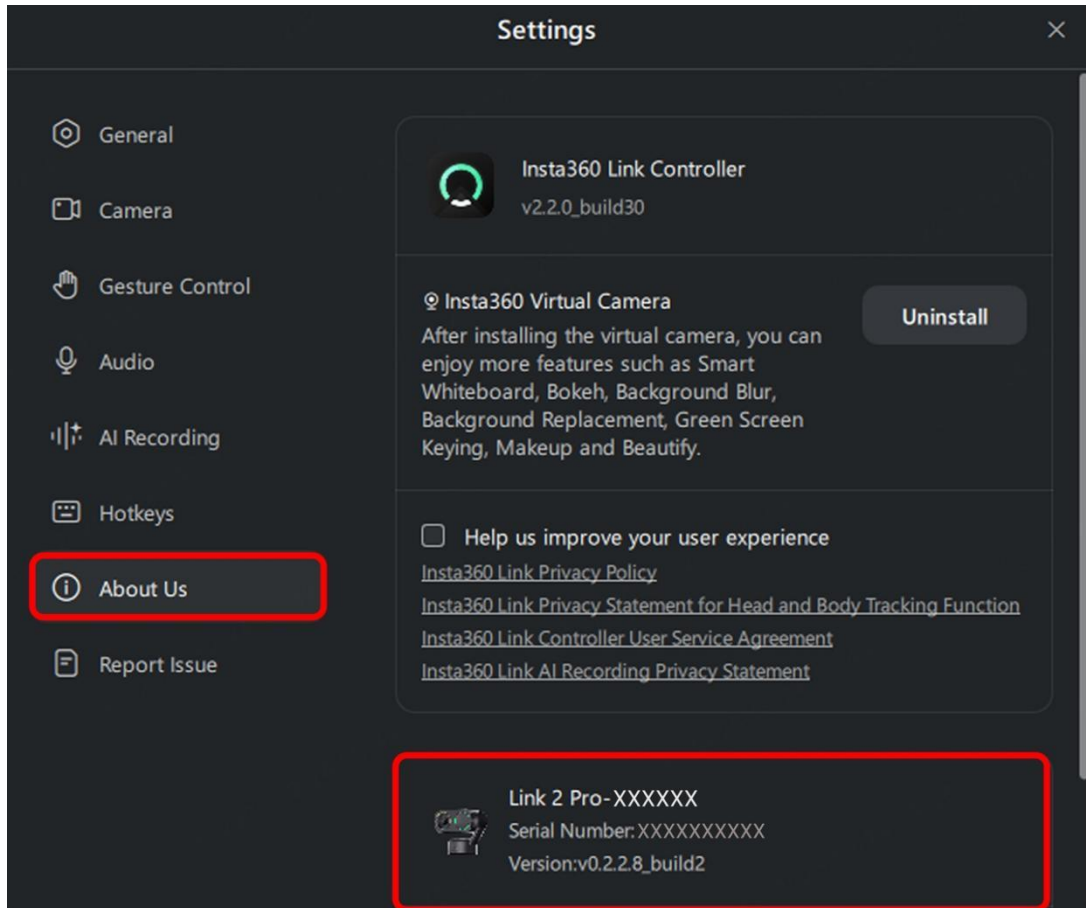

### Method 3: Via the camera body

Link 2C Pro: The serial number is located below the USB-C port.



Link 2 Pro: The serial number is located on the bottom of the gimbal base.

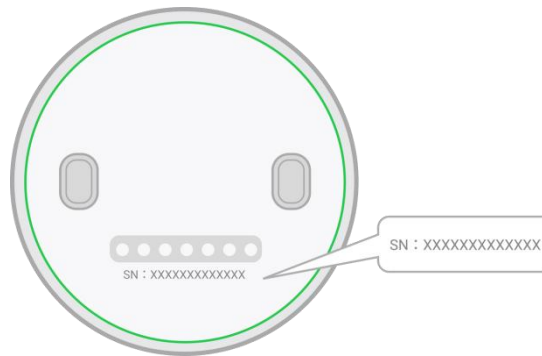

## Log Upload

To help you quickly locate and resolve issues encountered during use, we provide a convenient log upload feature. You can upload log files from the device, virtual camera, or Link Controller client using either of the following methods.

### Method 1: Upload directly through the client

This method allows you to upload all related logs at once when the camera is properly connected to the client.

1. Open the Link Controller client and click "More Settings" (... icon) in the upper-right corner.
2. Select "Report Issue".
3. Click "Upload Logs".
4. In the pop-up window, select the date when the issue occurred and briefly describe the problem you encountered.
5. Click "Upload Logs" and wait for the upload to complete.
6. After a successful upload, click "Copy Log ID" and provide this log ID to the Insta360 support team.

**Tip:** When the camera and client are properly connected, this method can upload device logs, virtual camera logs, and Link Controller client logs all at once. During the log upload process, the camera will enter USB drive mode. Be sure to wait until the upload progress is complete and a success message is shown before manually unplugging and reconnecting the USB cable to restart the camera. Do not disconnect the connection before the upload is finished, as this may cause log corruption or upload failure.

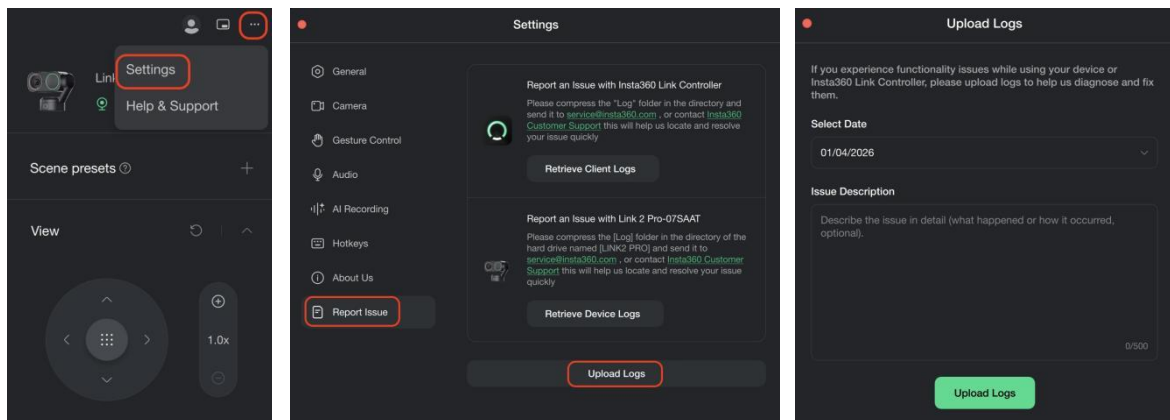

## Method 2: Manually obtain and export log files

If you need to manually check or submit log files, use this method.

1. Open the Link Controller client and click "More Settings" in the upper-right corner.
2. Select "Report Issue".
3. Click "Retrive Client Logs". The system will automatically generate a log file package locally on your computer.
4. You can directly provide this file package to the support team.
  - The logs exported in this step include Link Controller client logs and virtual camera logs.
  - To export the device's own logs separately, on the "Report Issue" page, locate the connected device name and click the "Retrive Device Logs" button below it.

## Firmware Update

### Upgrade via Client

Download and install the client software and connect the device to your computer using the official data cable.

Open the client, go to "More Settings" > "About Us" to check the current version.

When a new version is detected, click "Update Now" to download the latest firmware and follow the prompts to complete the installation.

### Upgrade via U-Disk Mode

1. Connect the device to the computer. Triple-tap the Touch Button and wait for the indicator light to flash, then long-press for 5 seconds. Once the indicator light turns solid blue, the camera has entered U-Disk Mode. Go to the Download page on the official Insta360 website and download the latest firmware version from the corresponding product page.
2. After downloading, open the folder and copy the file into the U-disk named after the device.

The indicator light will turn solid green once the firmware update is successful.

#### Tips:

- Do not disconnect the USB cable during the firmware update.
- Do not operate the device during the firmware update.

## Storage and Maintenance

- This product contains magnets. To avoid magnetization effects, please keep it away from devices susceptible to interference, such as pacemakers.
- Do not manually force, hit, or collide with this product.
- Do not submerge this product in water.
- Clean with a dry cloth. Do not use flammable liquid cleaners.
- Do not use this product in environments with extreme temperatures, high humidity, heavy dust or dirt, or in places where it may be exposed to moisture.

## Specifications

Visit the following website for specifications.

<https://www.insta360.com/specs/link2pro>

**Arashi Vision Inc.**

ADD: 11th Floor, Building 2, Jinlitong Financial Center, Bao'an District, Shenzhen,  
Guangdong, China

WEB: [www.insta360.com](http://www.insta360.com)

TEL: 400-833-4360 +1 800 6920 360

EMAIL: [service@insta360.com](mailto:service@insta360.com)

V1.1