

# Roomba Combo<sup>®</sup>

**Essential** robot

Owner's Guide

**iRobot**

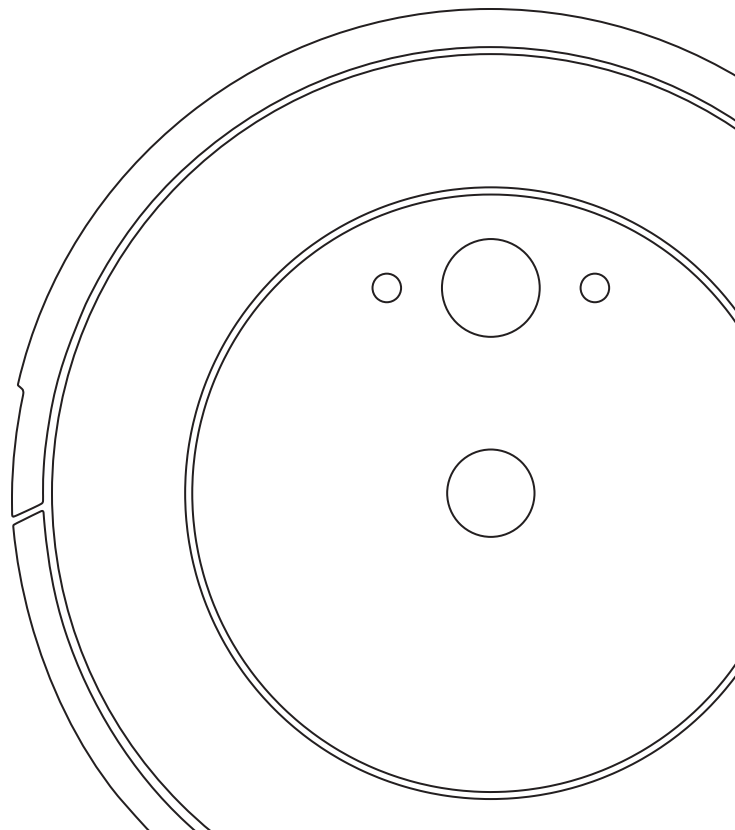

# Safety information

## Important safety information

This Owner's Guide includes information for regulatory model(s): Robot: RVG-Y1 | Dock: ADN-N1 | Battery: ABL-G | Robot Radio Module: ESP32-S3-WROOM-1

### SAVE THESE INSTRUCTIONS

 **WARNING:** When using an electrical appliance, basic precautions should always be followed, including the following:

### READ ALL INSTRUCTIONS

 **WARNING:** to reduce the risk of injury or damage, read and follow the safety precautions when setting up, using and maintaining your robot.

This appliance can be used by children aged from 8 years and above and persons with reduced physical, sensory, or mental capabilities or lack of experience and knowledge if they have been given supervision or instruction concerning use of the appliance in a safe way and understand the hazards involved. Children must not play with the appliance. Cleaning and user maintenance must not be carried out by children without supervision.

 This is the safety alert symbol. It is used to alert you to potential physical injury hazards. Obey all safety messages that follow this symbol to avoid possible injury or death.

 Risk of electric shock

 For indoor use only

 Rated power output, DC

 Read operator's manual

 General symbol for recycling

 Risk of fire

 Class II equipment

 Rated power input, DC

 Keep out of reach of children

 Separate supply unit

 Caution

 Class III equipment

 Rated power input, AC

**WARNING:** Indicates a hazardous situation that, if not avoided, could result in death or serious injury.

**CAUTION:** Indicates a hazardous situation that, if not avoided, could result in minor or moderate injury.

**NOTICE:** Indicates a hazardous situation that, if not avoided, could result in property damage.

#### GENERAL



## WARNING

- This product comes with a region-approved power supply cord and is designed to be plugged into a standard household AC power socket only. Do not use any other power supply cord. For replacement cords, please contact Customer Care to ensure the proper selection of a country-specific power supply cord.
- Do not disassemble or open this product other than instructed in the Owner's Guide. There are no user-serviceable parts inside. Refer servicing to qualified service personnel.
- Risk of electric shock; use indoors in dry locations only.
- Do not handle this product with wet hands.
- This product is not a toy. Small children and pets should be supervised when your robot is operating. Do not sit or stand on your robot or dock.
- Do not sit or stand on this product.
- Store and operate this product in room temperature environments only.
- Do not use unauthorised chargers. Use of an unauthorised charger could cause the battery to generate heat, smoke, catch fire or explode.
- If the room to be cleaned contains a balcony, a physical barrier should be used to prevent access to the balcony and ensure safe operation.
- If the room to be cleaned contains equipment, such as a stove, fan, portable heater or humidifier, remove the equipment before operation. There is a risk of injury, accident or malfunction if the robot comes into contact with and pushes the equipment.
- Do not allow your robot or charging station to become wet.
- Clean cliff sensors for build-up.
- Be aware that floors may be slippery after wet cleaning with your robot.

- Do not add liquids such as hot water, detergent or disinfectant, as they could damage the robot



## CAUTION

- Do not operate the robot in areas with exposed electrical sockets or gas shut-off valves in the floor.
- Do not use this device to pick up sharp objects, glass, or anything that is burning or smoking.
- Be aware that the robot moves on its own. Take care when walking in the area that the robot is operating in to avoid stepping on it.
- If the device passes over a power cord and drags it, there is a chance that an object could be pulled off a table or shelf. Before using this device, pick up objects like clothing, loose papers, pull cords for blinds or curtains, power cords and any fragile objects. Extinguish candles. Turn off portable heaters.
- Perform the required maintenance as per the Owner's Guide to ensure safe operation of the robot and charging station.
- If the robot is operating on a floor with stairs, please remove any clutter from the top step.
- Do not flip the robot over with the Combo Bin installed.

## NOTICE

- This robot is intended for dry floor use only. Do not use this device to clean up spills. Do not allow your robot or dock to become wet.
- Do not place anything on top of your robot or charging station.
- Failure to maintain the cleanliness of the charging contacts could result in the robot losing its ability to charge the battery and the contacts may become hot to the touch.
- Before running your robot on hard floors, please test your robot on a small section of the hard floor to ensure that it is compatible. Using your robot

on a hard floor that is not compatible could result in damage to your floor. Contact your hard floor manufacturer for questions about compatibility.

- Before running your robot on carpets or rugs, ensure that the carpets or rugs are compatible with the Multi-Surface Brush on your robot. Using your robot on a carpet or rug that is not compatible could result in damage to your carpet or rug. Contact your carpet or rug manufacturer with questions on compatibility.

#### CHARGING STATION



### WARNING

- If the appliance is not working as it should, has been dropped, damaged, left outdoors or dropped into water, return it to a service centre.
- Do not use a charging station with a damaged cord or plug. If the cord or plug is damaged, it must be replaced.
- Always disconnect your robot from the charging station before cleaning or maintaining it.
- Do not use the charging station as a step.
- Charge your robot only with the power supply provided. The provided power supply delivers safety extra-low voltage corresponding to the input marking on the robot which is required to maintain safe operation.
- To prevent the risk of your robot falling down stairs, ensure that the charging station is placed at least 1.2 metres (4 feet) away from stairs.
- Do not allow liquids to get on or into the charging station.

## NOTICE

- Product may not be used with any type of power converter. Use of power converters will immediately void the warranty.
- If you live in an area prone to electrical storms, it is recommended that you use additional surge protection. Your charging station may be protected with a surge protector in the event of severe electrical storms.

#### CLEANING SOLUTION



### WARNING

- Do not add liquids such as hot water, detergent or disinfectant, as they could damage the robot

#### BATTERY



### WARNING

- Do not open, crush, heat above 80°C (176°F) or incinerate. Follow the Owner's Guide instructions for proper use, maintenance, handling and disposal.
- Do not short-circuit the battery by allowing metal objects to come into contact with the battery terminals or by immersing it in liquid. Do not subject batteries to mechanical shock.
- Lithium ion batteries and products that contain lithium ion batteries are subject to stringent transportation regulations. If you need to post this product (with the battery included) for service, travel or any other reason, you must refer to the Troubleshooting section of your Owner's Guide or contact Customer Care for postage instructions.
- Do not charge damaged or leaking battery packs. Do not allow the liquid to come into contact with skin or eyes. If contact has been made, wash the affected area with large amounts of water and seek medical advice.

Keep the battery pack clean and dry. Wipe the cell/battery terminals with a clean dry cloth if they become dirty.

## ⚠ CAUTION ⚠

- Battery usage by children should be supervised. Seek medical advice immediately if a cell or a battery has been swallowed.

## NOTICE

- The battery pack must be removed from the robot before recycling or disposal.
- To access the battery for recycling or disposal, loosen the two screws. Remove the battery compartment cover and unplug the battery cable.

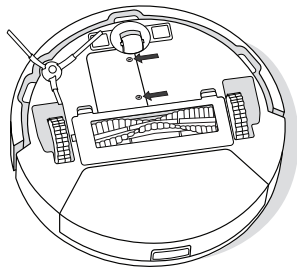

This symbol on the battery indicates that the battery must not be disposed of with unsorted common municipal waste. As the end user, it is your responsibility to dispose of the end-of-life battery in your appliance in an environmentally sensitive manner as follows:

- (1) returning it to the distributor/dealer from whom you purchased the product, or
- (2) depositing it at a designated collection point.

The separate collection and recycling of end-of-life batteries at the time of disposal will help to conserve natural resources and to ensure that they are recycled in a manner that protects human health and the environment. For more information, please contact your local recycling office or the dealer from whom you originally purchased the product. Failure to properly dispose of end-of-life batteries may result in the negative potential effects on the environment and human health due to the substances in the batteries and accumulators.

Information regarding the effects of problematic substances in the battery waste stream may be found at the following source:

<http://ec.europa.eu/environment/waste/batteries/>

# Getting started

## 1 Position the Charging dock

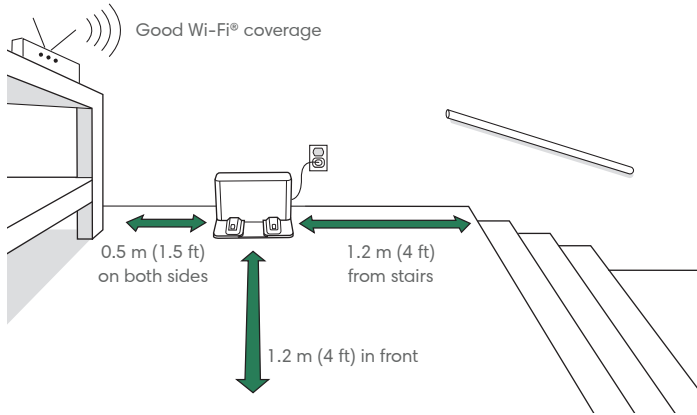

**NOTE:** Position your Charging dock on hard-surface flooring. Do not place it in direct sunlight. Ensure that the area around the dock or charging dock is free of clutter to improve docking performance.



**WARNING:** To prevent the risk of your robot falling down stairs, ensure that your Charging dock is placed at least 1.2 metres (4 feet) away from stairs.

## 2 Plug in the Charging dock

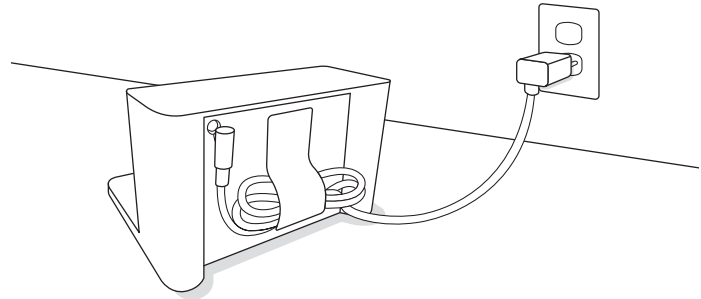

Plug the power cord into the Charging dock, then into the wall. Wrap the cord back so it won't get in the way of the robot as it comes and goes.

### 3 Wake up the robot

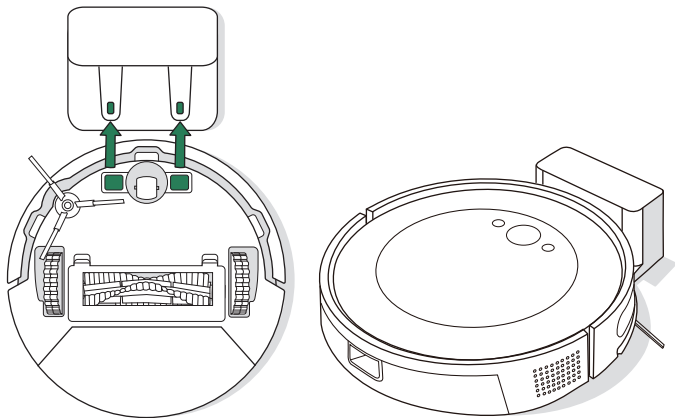

Place your robot on the Charging dock by lining up the metal charging contacts. After a few minutes, a sound will let you know it's awake.



**IMPORTANT:** Read the enclosed safety information guide first before using your robot.

### 4 Download the iRobot Home App

Scan the QR code with the camera on your mobile device or find the iRobot Home App in your app store.

- Follow the step-by-step instructions to set up your robot.
- Set an automatic cleaning schedule and customise cleaning preferences.
- Access to tips, tricks and answers to commonly asked questions.



#### NOTE:

5.0 GHz Wi-Fi is not compatible with this robot



# About your robot

## Top view

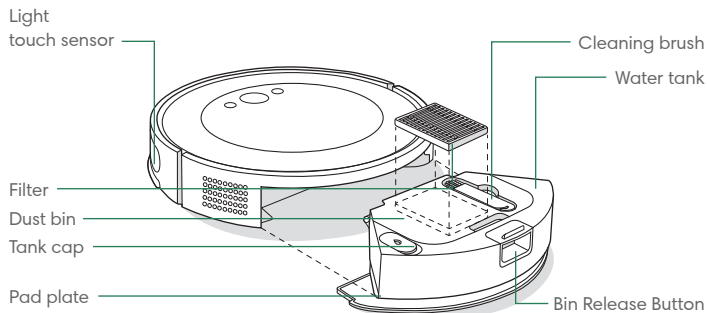

## Charging dock

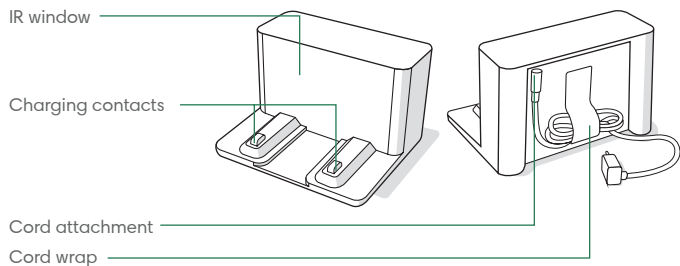

## Bottom view

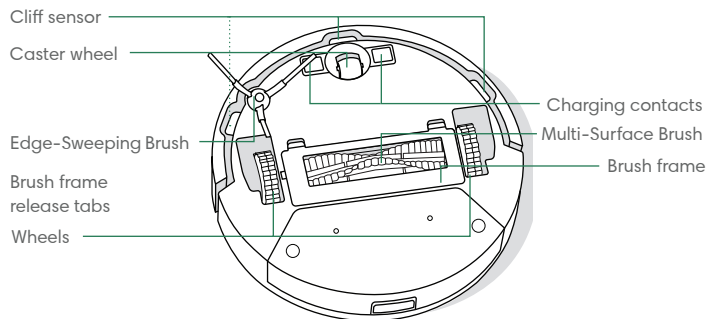

## Buttons and indicators

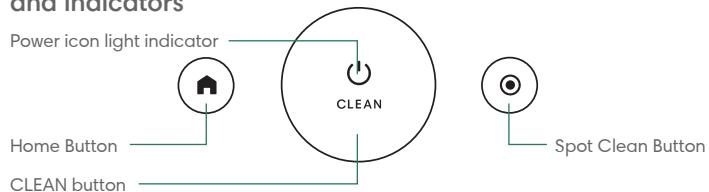



# Charging

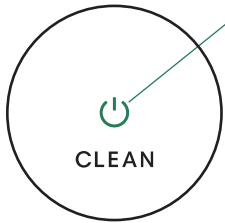

## Power icon indicator while charging

Solid white: fully charged

Pulsing white: charging

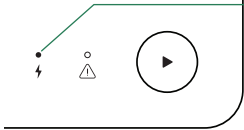

## Charging LED Indicator

On: Robot on dock charging

Off: Robot not on dock or robot not charging

Flashing: Mid-job charge & resume



**NOTE:** Your robot comes with a partial charge, but we recommend that you charge the robot for 4 hours prior to starting the first cleaning job.

Place the robot on the charging dock to activate the battery.

If your robot needs to recharge mid-clean, the cleaning job will be cancelled and it will return to its charging dock.

The robot uses a small amount of power whenever it is on the charging station. You can put the robot in a further-reduced power state when not in use. For instructions and more details on this Reduced Power Standby Mode, refer to the FAQ page on our website.

For long-term storage, turn off the robot by removing it from the charging station and holding down  for 9 seconds. Store the robot in a cool, dry place.

# Cleaning

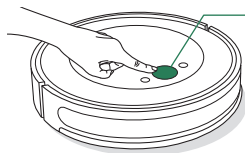

Press **CLEAN** on your robot

Tap to Start/Pause/Resume



Hold for 2–5 seconds to end a job

**CLEANING PATTERN:** Your robot will automatically explore and clean your home in neat rows. It will return to the charging station at the end of a cleaning job and whenever it needs to recharge.



Remove excess clutter from floors before cleaning. Use your robot frequently to maintain well-conditioned floors.

To end a job, hold the **CLEAN** button down for 2–5 seconds. To send the robot back to its charging dock, tap .

Tap  to spot clean a designated area. The robot will spiral outwards about 1 metre (3 feet) and then spiral inwards to end where it started. Please remove any obstacles from the spot clean path. After spot cleaning is complete, the robot will end the job. To send the robot back to its charging dock, tap .

**DO NOT DISTURB MODE:** In Do Not Disturb mode, the robot vacuum does not perform scheduled cleans, and the power icon light indicator turns off after one minute of charging. Do Not Disturb mode can be enabled or disabled in the app

# Vacuuming

- 1 Empty the robot tank and detach the mopping pad plate and mopping pad before starting a vacuum job.

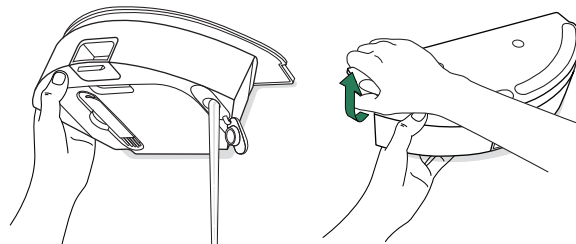

- 2 Place on the floor and press the **CLEAN** button on the robot.

## Vacuuming & mopping

Your robot is able to both vacuum and mop at the same time when the mopping pad plate and mopping pad are installed.

Before starting a vacuum and mop job, prepare the room by rolling up/removing any carpets in the area you want to mop.



**NOTE:** When the robot is operating with the mopping attachment, spot clean will not be available.



**IMPORTANT:** Do not add liquids such as hot water, detergent or disinfectant as they could damage the robot.

After completing your mopping and vacuum cleaning job, make sure that you empty the water tank and replace the mopping pad.

- 1 Press the Bin Release Button to remove the bin.

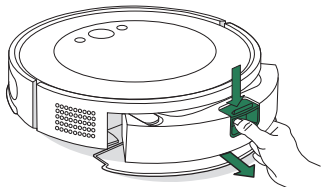

- 2 Remove the pad plate from the bin.

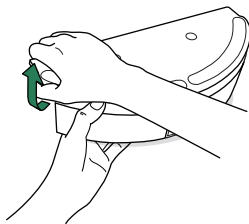

- 3 Lightly dampen a mopping pad and attach it to the pad plate.

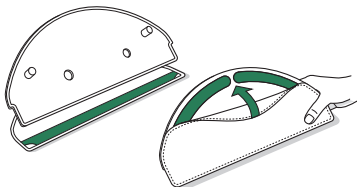

- 4 Reinstall the pad plate on the bin.

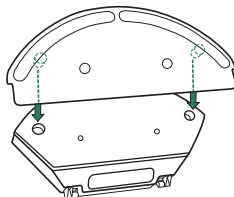

- 5 Fill the tank with water.

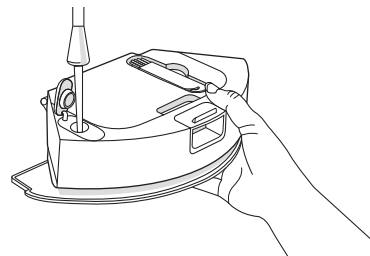

- 6 Place the bin back in the robot.

- 7 Place on the floor and press the CLEAN button on the robot.

# Care and maintenance for your robot

To keep your robot at optimal performance, make sure that you periodically perform the following basic care and maintenance. There are additional instructional videos in the iRobot Home App. If you notice the robot picking up less debris from your floor, empty the bin, clean the filter and clean the brushes.

Part	Care frequency	Replacement frequency*
Dry bin	Empty bin as needed	-
Water tank	Empty after each job	-
Filter	Clean once a week (twice a week if you have a pet)	Every 3–6 months
Edge-Sweeping Brush	Clean every 2 weeks or as needed	Every 3–6 months
Multi-Surface Brush	Clean once a week	Every 6–12 months
Front caster wheel	Clean every 2 weeks or as needed	-
Charging contacts	Clean every 2 weeks or as needed	-
Sensors	Clean once a month or as needed	-
Mopping pad	Clean after a mopping job	Every 3–6 months. Dispose in household waste when no longer usable

\* Replacement frequency may vary. Parts should be replaced if there is visible wear. If you think that you need a replacement part, please contact iRobot Customer Care for more information.

## Emptying the bin

- 1 Press the Bin Release Button to remove the bin.

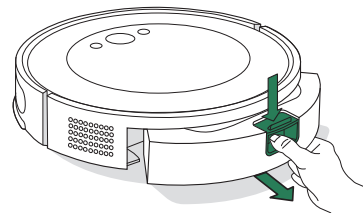

- 2 Open the door to empty and clean the dust bin with the cleaning brush.



- 3 Place the bin back in the robot.



**IMPORTANT:** Do not rinse or soak the bin. Regularly clean the bin to prevent dirt build-up.

## Cleaning the filter

- 1 Remove the bin. Open the bin door and remove the filter.

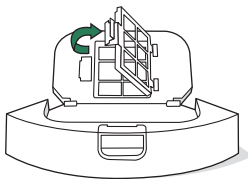

- 2 Remove debris with the cleaning brush.

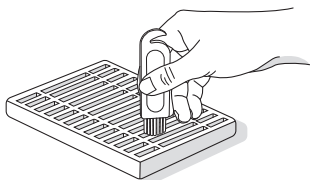

- 3 Reinsert the filter and place the bin back in the robot.



**NOTE:** The filter can be rinsed with water. Make sure that it is completely dry before reinstalling it. Frequent rinses are not recommended.

## Cleaning the charging contacts and sensors

Wipe the charging contacts and sensors with a clean, dry cloth.

### CHARGING CONTACTS

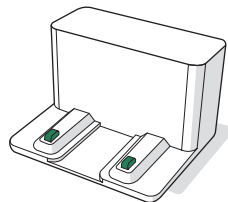
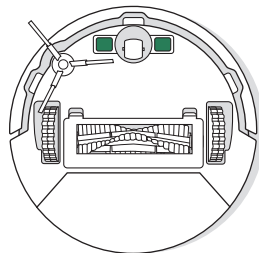

### SENSORS

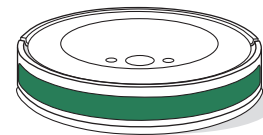
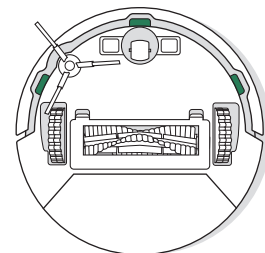

**IMPORTANT:** Do not spray cleaning solution or water onto the sensors or sensor openings.

## Cleaning the Edge-Sweeping Brush

Pull to remove the Edge-Sweeping Brush. Remove any hair or debris using the cleaning brush, then reinstall the Edge-Sweeping Brush.

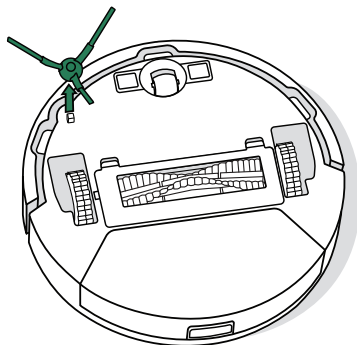

## Cleaning the Multi-Surface Brush

1 Press the brush frame release tabs and lift to remove the brush frame

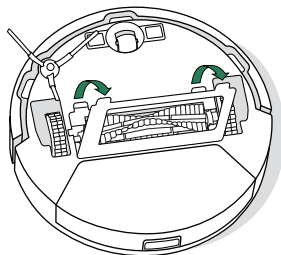

2 Remove the Multi-Surface Brush

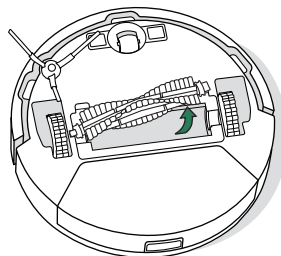

3 Remove any hair or debris from the Multi-Surface Brush using the cleaning brush

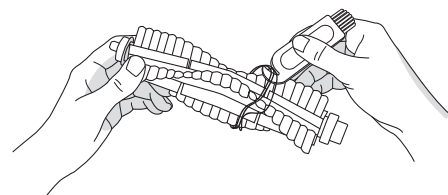

4 Reinstall the Multi-Surface Brush and brush frame in the robot

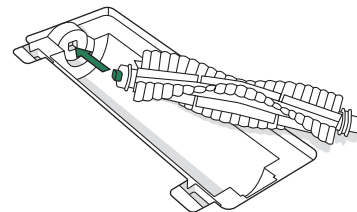

## Cleaning the front caster wheel

Use the cleaning brush to remove hair and debris from the front caster wheel.

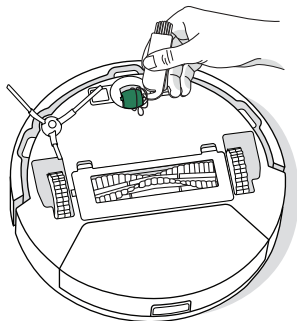

**IMPORTANT:** A front wheel clogged with hair and debris could result in damage to your floor. If the wheel is not spinning freely after you have cleaned it, please contact Customer Care.

## Cleaning the mopping pad

Thoroughly hand wash the mopping pad with cold water and let it air dry.

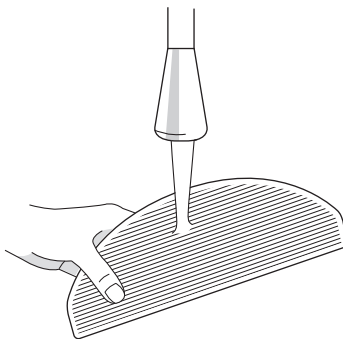

# Troubleshooting your robot

Your robot will tell you that something is wrong by playing an audio alert and the power icon light indicator will turn red. Press the CLEAN button for details. Check the iRobot Home App for further support.

Red power icon light indicator

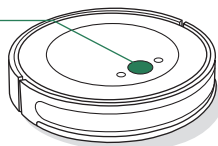

Low battery. Please charge.

If you are unsure if the robot has finished or paused, consult the iRobot Home App to check on its status.

## BATTERY SAFETY & POSTAGE



**WARNING:** Lithium ion batteries and products that contain lithium ion batteries are subject to stringent transportation regulations. If you need to post this product for service, travel or any other reason, you **MUST** follow the postage instructions below.

- Battery **MUST** be turned off before postage.
- Turn off the battery by removing the robot from the charging dock and holding down the  button for 9 seconds. All indicators will turn off.
- Package the robot securely for postage.

If you need further assistance, contact our Customer Care team or visit [global.irobot.com](https://global.irobot.com).



## Regulatory information



Hereby, iRobot Corporation declares that this robot vacuum and mop cleaner model RVG-Y1 is in compliance with the EU Radio Equipment Directive 2014/53/EU. The full text of the EU Declaration of Conformity is available at the following web address: [www.irobot.com/compliance](http://www.irobot.com/compliance)



Hereby, iRobot Corporation declares that this robot vacuum and mop cleaner model RVG-Y1 is in compliance with the Radio Equipment Regulations 2017. The full text of the UKCA Declaration of Conformity is available at the following web address: [www.irobot.com/compliance](http://www.irobot.com/compliance)

A chemical information report listing SVHC (substances of very high concern) per EU Regulation EU 1907/2006 can be found here: [www.irobot.com/compliance](http://www.irobot.com/compliance)



This symbol on the product indicates that the appliance must not be disposed of with unsorted common municipal waste. As the end user, it is your responsibility to dispose of the appliance at end of life in an environmentally sensitive manner, as follows:

- (1) returning it to the distributor/dealer from whom you purchased the product, or
- (2) depositing it at a designated collection point.

Disposing of this product correctly will help save valuable resources and prevent any potential negative effects on human health and the environment, which could otherwise arise from inappropriate waste handling. Please contact your local authority for further details or your nearest designated collection point. Penalties may be applicable for incorrect disposal of this waste, in accordance with your national legislation. More information may be found at the following source: [https://ec.europa.eu/environment/topics/waste-and-recycling/waste-electrical-and-electronic-equipment-weee\\_en](https://ec.europa.eu/environment/topics/waste-and-recycling/waste-electrical-and-electronic-equipment-weee_en)

Regulatory Model RVG-Y1 contains the Espressif module model: ESP32-S3-WROOM-1, which operates in the WLAN 2.4 GHz band. For the EU and UK, the 2.4 GHz band is limited to operate between 2.412 GHz and 2.472 GHz with a maximum EIRP output power of 19.98 dBm (99.5 mW) at 2412 MHz.

### External power supply

Only use the external power supply adapter model approved for your region.

MODEL NUMBER	REGION
APA-NA	NA
APA-EU	EU
APA-UK	UK
APA-JP	JP
APA-AS	AS/NZS
APA-BR	BR
APA-AG	AG
APA-IN	IN
APA-TH	TH

Recycle your end-of-life iRobot product responsibly as per local regulations. The following is a list of the WEEE recycling organisations contracted by iRobot at the time of product sale.

Location	Organisation	URL
Austria	UFH	<a href="http://www.elektro-ade.at/elektrogeraete-sammeln/liste-der-sammelstoesterreich/">http://www.elektro-ade.at/elektrogeraete-sammeln/liste-der-sammelstoesterreich/</a>
Belgium	Recupel	<a href="https://www.recupel.be/en/where-to-go/?searchcollectionPoints=&amp;categories=1%2C2%2C3%2C4#">https://www.recupel.be/en/where-to-go/?searchcollectionPoints=&amp;categories=1%2C2%2C3%2C4#</a>
Germany	Zentek	<a href="https://www.ear-system.de/ear-verzeichnis/sammel-und-ruecknahmestback">https://www.ear-system.de/ear-verzeichnis/sammel-und-ruecknahmestback</a>
Spain	Ecotic	<a href="https://punto-limpio.info/">https://punto-limpio.info/</a>
France	Eco-systèmes	<a href="https://www.eco-systemes.fr/france">https://www.eco-systemes.fr/france</a>
Ireland	WEEE Ireland	<a href="http://www.weeeireland.ie/household-recycling/where-can-i-recycle/">http://www.weeeireland.ie/household-recycling/where-can-i-recycle/</a>
Netherlands	Wecycle	<a href="https://www.watismijnapparaatwaard.nl/">https://www.watismijnapparaatwaard.nl/</a>
Portugal	Electrao	<a href="http://www.ondereciclar.pt/">http://www.ondereciclar.pt/</a>
United Kingdom	REPIC	<a href="http://www.responsible-recycling.co.uk/contact-us/find-your-local-recycling-centre/">http://www.responsible-recycling.co.uk/contact-us/find-your-local-recycling-centre/</a>

Manufacturer address: iRobot Corporation, 8 Crosby Drive, Bedford, MA 01730, USA



# iRobot Customer Care

## US & Canada

If you have questions or comments about your Clean Base™ Auto-Fill Dock, please contact iRobot before contacting a retailer.

You can start by visiting [global.irobot.com](https://global.irobot.com) for support tips, frequently asked questions, and information about accessories. This information can also be found in the iRobot Home App. If you need further assistance, call the US Customer Care team on +1 877 855 8593.

### iRobot USA Customer Care hours

Monday to Friday, 9 AM–6 PM Eastern Time

Saturday and Sunday 9 AM–6 PM Eastern Time

## Outside US & Canada

Visit [global.irobot.com](https://global.irobot.com) to:

- Learn more about iRobot in your country
- Get hints and tips to improve your product performance
- Get answers to your questions
- Contact your local support centre



©2023 iRobot Corporation, 8 Crosby Drive, Bedford, MA 01730 USA. All rights reserved. iRobot, Roomba and Roomba Combo are registered trademarks of iRobot Corporation. Wi-Fi and the Wi-Fi logo are registered trademarks of Wi-Fi Alliance. Apple and App Store are trademarks of Apple Inc., registered in the US and other countries. Google Play is a trademark of Google LLC.

WC# 4837890 vA