



5KSM125, 5KSM175PS 5K45SS, 5KSM45



KitchenAid



TABLE OF CONTENTS

PARTS AND FEATURES	6
Parts and accessories.....	6
STAND MIXER SAFETY	7
Important safeguards.....	7
Electrical requirements.....	9
Electrical equipment waste disposal.....	9
USING THE STAND MIXER	10
Speed control guide.....	10
Accessory guide.....	11
Attaching/removing the bowl.....	11
Lifting/lowering the motor head.....	12
Attaching/removing the flat beater, Flex Edge beater*, wire whip, or dough hook.....	12
Beater to bowl clearance.....	14
Placing/removing the pouring shield*.....	14
Using the pouring shield*.....	15
Operating the speed control.....	16
Optional attachments.....	16
TIPS FOR GREAT RESULTS	18
Egg whites.....	18
Whipped cream.....	18
Mixing tips.....	19
CARE AND CLEANING	20
TROUBLESHOOTING	21
WARRANTY AND SERVICE	22

* Included with select models only. Also available as optional accessory.

PARTS AND FEATURES

PARTS AND ACCESSORIES

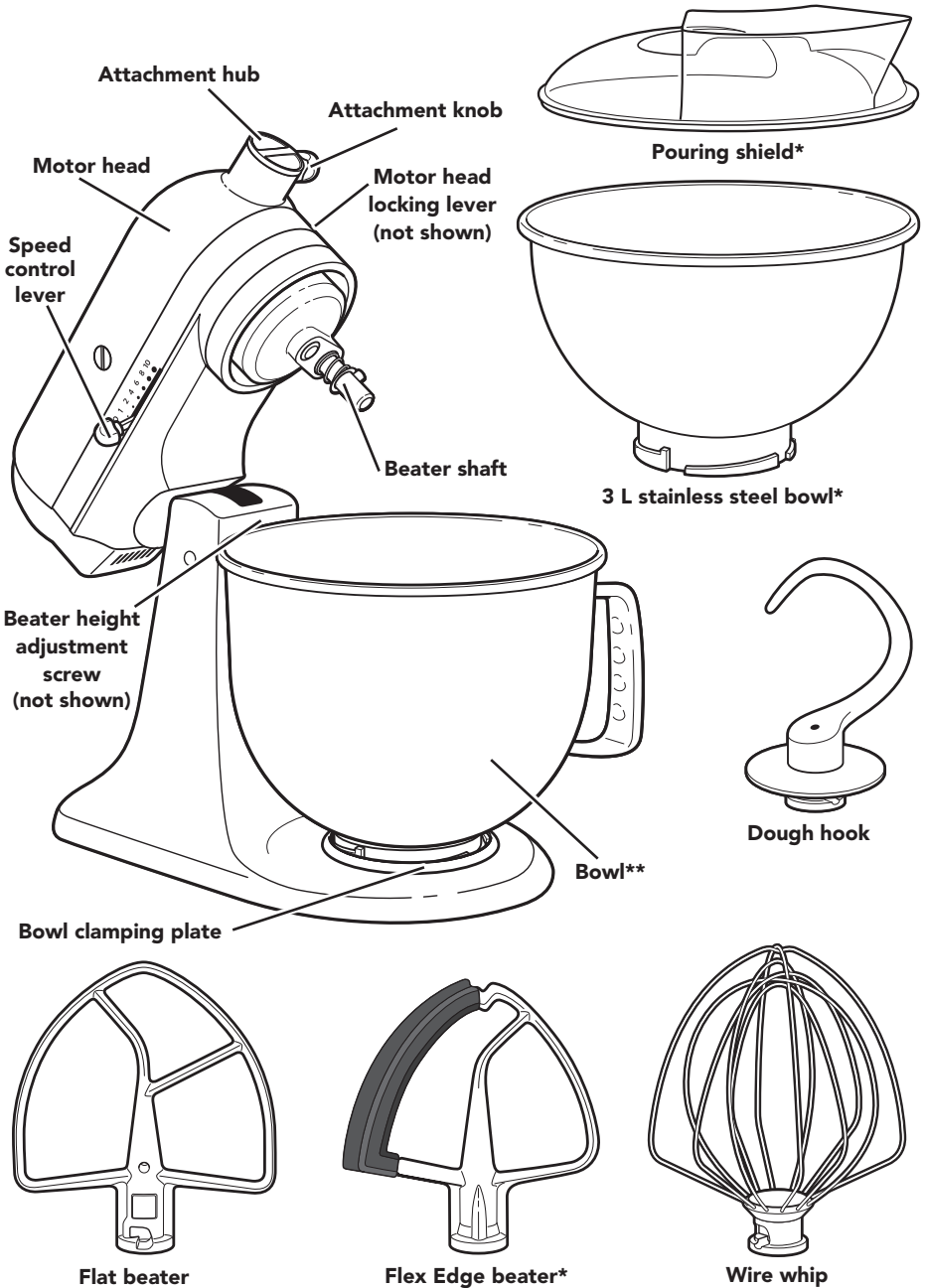

* Included with select models only. Also available as optional accessory.

** The bowl design and material depend on the Stand Mixer model.

Your safety and the safety of others are very important.

We have provided many important safety messages in this manual and on your appliance. Always read and obey all safety messages.



This is the safety alert symbol.

This symbol alerts you to potential hazards that can kill or hurt you and others.

All safety messages will follow the safety alert symbol and either the word “DANGER” or “WARNING.” These words mean:

! DANGER

You can be killed or seriously injured if you don't immediately follow instructions.

! WARNING

You can be killed or seriously injured if you don't follow instructions.

All safety messages will tell you what the potential hazard is, tell you how to reduce the chance of injury, and tell you what can happen if the instructions are not followed.

IMPORTANT SAFEGUARDS

When using electrical appliances, basic safety precautions should always be followed, including the following:

1. Read all instructions.
2. To protect against risk of electrical shock, do not put Stand Mixer in water or other liquid.
3. Unplug Stand Mixer from outlet when not in use, before putting on or taking off parts, and before cleaning.
4. Never leave the Stand Mixer unattended while it is in operation.

STAND MIXER SAFETY

5. This appliance can be used by children aged from 8 years and above and persons with reduced physical, sensory or mental capabilities or lack of experience and knowledge if they have been given supervision or instruction concerning use of the appliance in a safe way and understand hazards involved. Children shall not play with the appliance. Cleaning and user maintenance shall not be made by children without supervision.
6. Avoid contacting moving parts. Keep hands, hair, clothing, as well as spatulas and other utensils away from beater during operation to reduce the risk of injury to persons and/or damage to the Stand Mixer.
7. Do not operate Stand Mixer with a damaged cord or plug or after the Stand Mixer malfunctions, or is dropped or damaged in any manner. Return appliance to the nearest Authorised Service Centre for examination, repair or electrical or mechanical adjustment.
8. The use of attachments not recommended or sold by KitchenAid may cause fire, electric shock, or injury.
9. Do not use the Stand Mixer outdoors.
10. Do not let the cord hang over edge of table or counter.
11. Remove flat beater, wire whip or dough hook from Stand Mixer before washing.

SAVE THESE INSTRUCTIONS

This product is designed for household use only.

STAND MIXER SAFETY

ELECTRICAL REQUIREMENTS

WARNING



Electrical Shock Hazard

Plug into an earthed outlet.

Do not remove earth prong.

Do not use an adapter.

Do not use an extension cord.

Failure to follow these instructions can result in death, fire, or electrical shock.

Wattage:

300 Watts for models 5KSM125 and 5KSM175PS
275 Watts for models 5K45SS and 5KSM45

Voltage: 220-240 V

Hertz: 50-60 Hz

NOTE: If the plug does not fit in the outlet, contact a qualified electrician. Do not modify the plug in any way. Do not use an adapter.

Do not use an extension cord. If the power supply cord is too short, have a qualified electrician or serviceman install an outlet near the appliance.

ELECTRICAL EQUIPMENT WASTE DISPOSAL

Disposal of packing material

The packing material is 100% recyclable and is marked with the recycle symbol . The various parts of the packing must therefore be disposed of responsibly and in full compliance with local authority regulations governing waste disposal.

Scrapping the product

- This appliance is marked in compliance with European Directive 2012/19/EU, Waste Electrical and Electronic Equipment (WEEE).

- By ensuring this product is disposed of correctly, you will help prevent potential negative consequences for the environment and human health, which could otherwise be caused by inappropriate waste handling of this product.







- The symbol  on the product or on the accompanying documentation indicates that it should not be treated as domestic waste but must be taken to an appropriate collection Centre for the recycling of electrical and electronic equipment.

For more detailed information about treatment, recovery and recycling of this product, please contact your local city office, your household waste disposal service or the shop where you purchased the product.

USING THE STAND MIXER

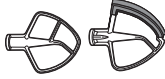
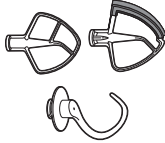
SPEED CONTROL GUIDE



All speeds have the Soft Start feature which automatically starts the Stand Mixer at a lower speed to help avoid ingredient splash-out and “flour puff” at start-up, then quickly increases to the selected speed for optimal performance.

SPEED	ACTION	ATTACHMENT	DESCRIPTION
1	STIR		For slow stirring, combining, mashing, starting all mixing procedures. Use to add flour and dry ingredients to batter, and to add liquids to dry ingredients. Do not use Speed 1 to mix or knead yeast doughs.
2	SLOW MIXING		For slow mixing, mashing, faster stirring. Use to mix and knead yeast doughs, heavy batters and candies, start mashing potatoes or other vegetables, cut shortening into flour, mix thin or splashy batters.
4	MIXING, BEATING		For mixing semi-heavy batters, such as cookies. Use to combine sugar and shortening and to add sugar to egg whites for meringues. Medium speed for cake mixes.
6	BEATING, CREAMING		For medium fast beating (creaming) or whipping. Use to finish mixing cake, doughnut, and other batters. High speed for cake mixes.
8	FAST BEATING, WHIPPING		For whipping cream, egg whites, and boiled frostings.
10	FAST WHIPPING		For whipping small amounts of cream, egg whites, or for final whipping of mashed potatoes.

NOTE: The speed control lever can be set between the speeds listed in the above chart to obtain speeds 3, 5, 7, and 9 if a finer adjustment is required. Do not exceed Speed 2 when preparing yeast doughs as this may cause damage to the Stand Mixer.

USING THE STAND MIXER

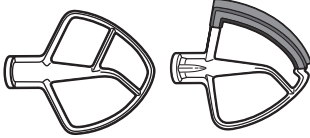
ACCESSORY GUIDE

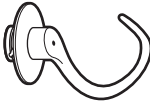
ACCESSORY		USES
Flat beater and Flex Edge beater* for normal to heavy mixtures:		Cakes, creamed frostings, candies, cookies, pie pastry, biscuits, meat loaf, mashed potatoes
Wire whip for mixtures that need air incorporated:		Eggs, egg whites, heavy cream, boiled frostings, sponge cakes, mayonnaise, some candies
Dough hook for mixing and kneading yeast doughs:		Breads, rolls, pizza dough, buns

* Included with select models only. Also available as optional accessory.

ATTACHING/REMOVING THE BOWL

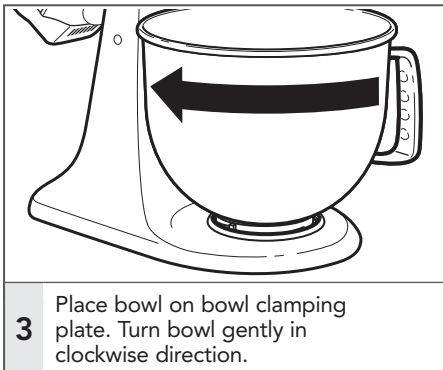
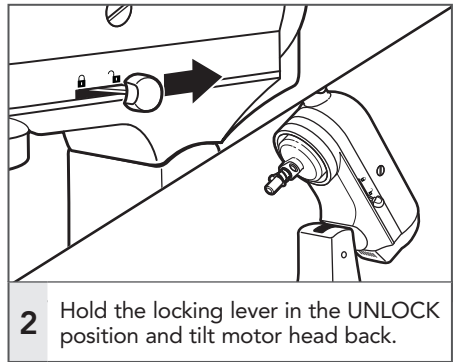
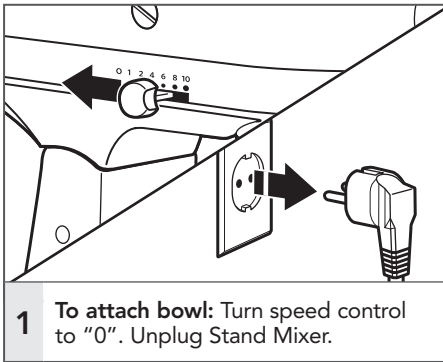

USING THE STAND MIXER

LIFTING/LOWERING THE MOTOR HEAD

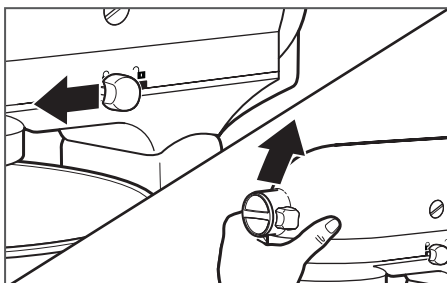

1

To lift motor head: Push the locking lever to the UNLOCK position and lift the head. Once lifted, the lever will automatically go back in LOCK position to keep the head lifted.

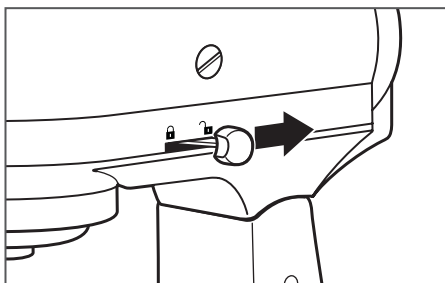

2

To put down motor head: Push the locking lever to UNLOCK and gently bring the head down. The locking lever will automatically go back in LOCK position when the head is down. Before mixing, test lock by attempting to raise motor head.

NOTE: Motor head should always be in LOCK position when using the Stand Mixer.

ATTACHING/REMOVING THE FLAT BEATER, FLEX EDGE BEATER*, WIRE WHIP, OR DOUGH HOOK

! WARNING

Injury Hazard

Unplug mixer before touching beaters.

Failure to do so can result in broken bones, cuts, or bruises.

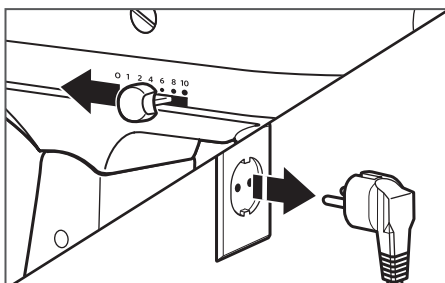

1

To attach accessory: Turn speed control to "0". Unplug Stand Mixer.

* Included with select models only. Also available as optional accessory.

USING THE STAND MIXER

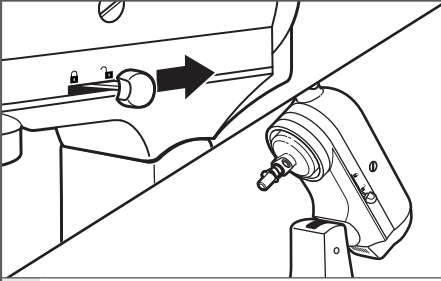

2 Hold the locking lever in the UNLOCK position and tilt motor head back.

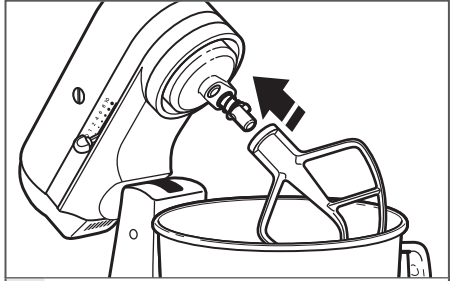

3 Slip accessory onto beater shaft and press upward as far as possible. Then, turn accessory to the right, hooking accessory over the pin on the shaft.

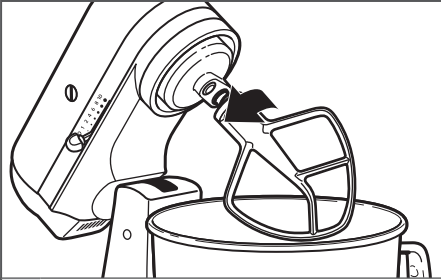

4 **To remove accessory:** Repeat steps 1 and 2. Press accessory upward as far as possible and turn to the left. Then pull accessory from the beater shaft.

USING THE STAND MIXER

BEATER TO BOWL CLEARANCE

Your Stand Mixer is adjusted at the factory so the flat beater just clears the bottom of the bowl. If, for any reason, the flat beater hits the bottom of the bowl or is too far away from the bowl, you can correct clearance easily.

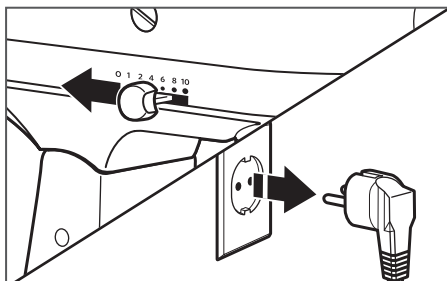

- 1 Turn speed control to "0". Unplug Stand Mixer.

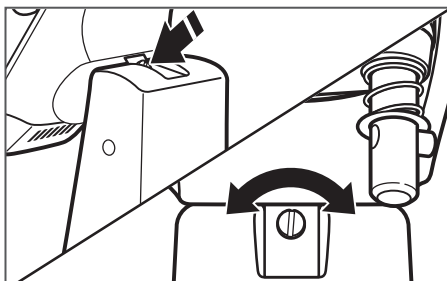

- 2 Lift motor head. Turn screw slightly counterclockwise (left) to raise flat beater or clockwise (right) to lower flat beater. Make adjustment with flat beater, so it just clears surface of bowl. If you over adjust the screw, the bowl lock lever may not lock into place.

NOTE: When properly adjusted, the flat beater will not strike on the bottom or side of the bowl. If the flat beater or the wire whip is so close that it strikes the bottom of the bowl, coating may wear off the beater or wires on whip may wear.

PLACING/REMOVING THE POURING SHIELD*

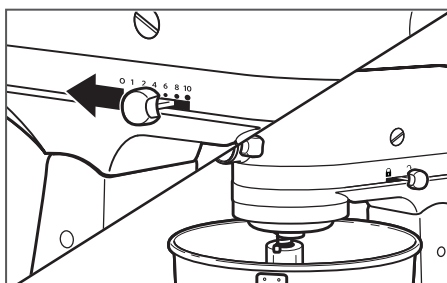

- 1 **To place pouring shield:** Turn speed control to "0". Unplug Stand Mixer. Attach your chosen accessory. See "Attaching/removing the flat beater, wire whip, or dough hook" section.

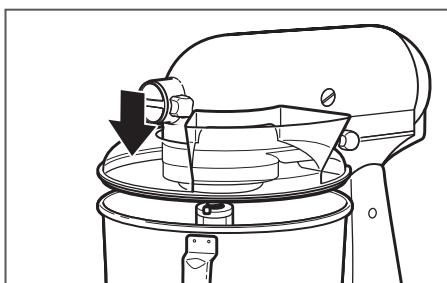

- 2 From the front of the Stand Mixer, slide the pouring shield over the bowl until the shield is centered. The bottom rim of the shield should fit within the bowl.

* Included with select models only. Also available as an optional accessory.

USING THE STAND MIXER

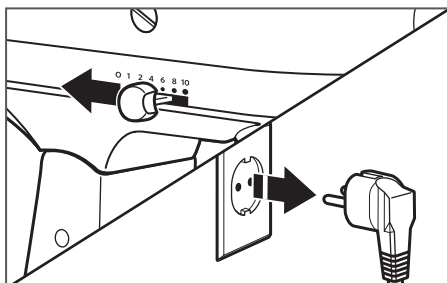

- 3** To remove pouring shield:
Turn speed control to "0".
Unplug Stand Mixer.

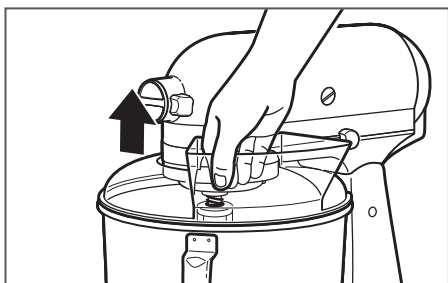

- 4** Lift the front of the pouring shield clear of the bowl rim and pull forward. Remove attachment and bowl.

USING THE POURING SHIELD*

Use the pouring shield to avoid having ingredients splashing out of the bowl when mixing, as well as to easily pour ingredients in the bowl while mixing.

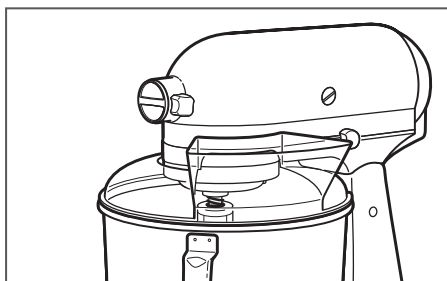

- 1** For best results, rotate the shield so the motor head covers the U-shaped gap in the shield. The pouring chute will be just to the right of the attachment hub as you face the Stand Mixer.

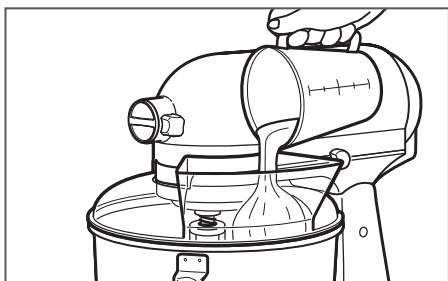

- 2** Pour the ingredients into the bowl through the pouring chute.

* Included with select models only. Also available as an optional accessory.

USING THE STAND MIXER

OPERATING THE SPEED CONTROL

NOTE: The Stand Mixer may warm up during use. Under heavy loads with extended mixing time, the top of the unit may become hot. This is normal.

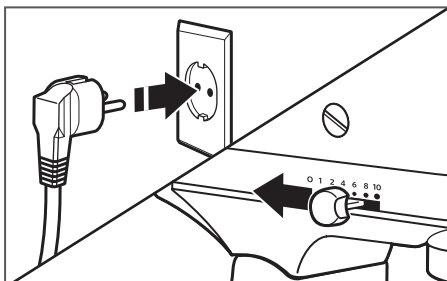

1

Plug Stand Mixer into proper electrical outlet. Always set speed control lever on lowest speed to start, then gradually increase speed to avoid splashing ingredients. See "Speed control guide" chart.

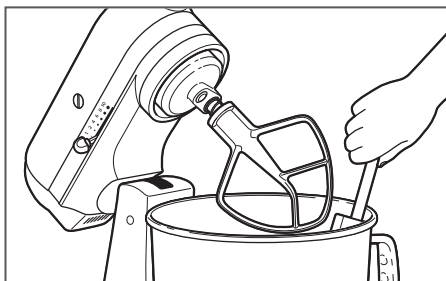

2

Do not scrape bowl while Stand Mixer is operating. The bowl and beater are designed to provide thorough mixing without frequent scraping. Scraping the bowl once or twice during mixing is usually sufficient.

OPTIONAL ATTACHMENTS

KitchenAid offers a wide range of optional attachments such as food grinders or pasta makers. They may be attached to the Stand Mixer attachment power shaft, as shown here.

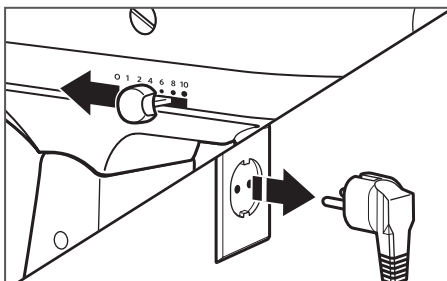

1

To attach: Turn speed control to "0". Unplug Stand Mixer.

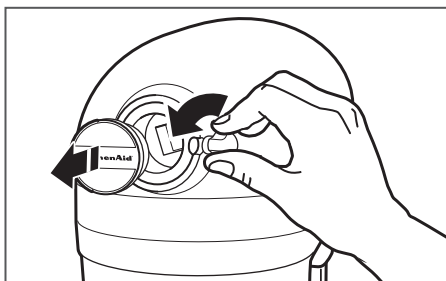

2

Loosen attachment knob by turning it counterclockwise. Remove attachment hub cover.

USING THE STAND MIXER

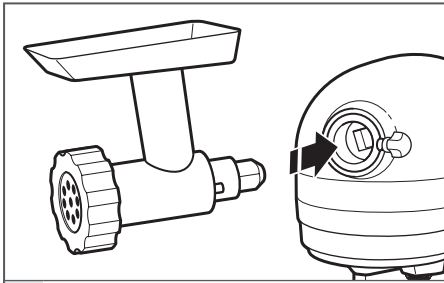

3 Insert attachment shaft housing into attachment hub, making certain that attachment power shaft fits into square attachment hub socket. It may be necessary to rotate attachment back and forth. When attachment is in proper position, the pin on the attachment will fit into the notch on the hub rim.

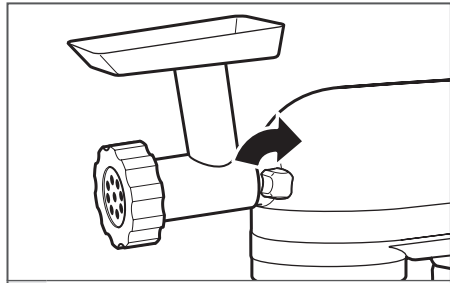

4 Tighten attachment knob by turning clockwise until attachment is completely secured to Stand Mixer.

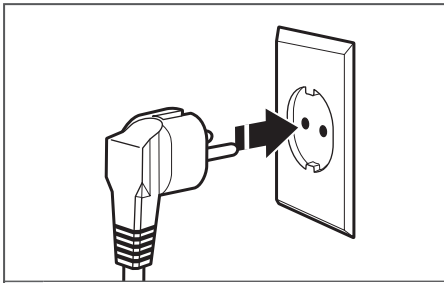

5 Plug into proper electrical outlet.

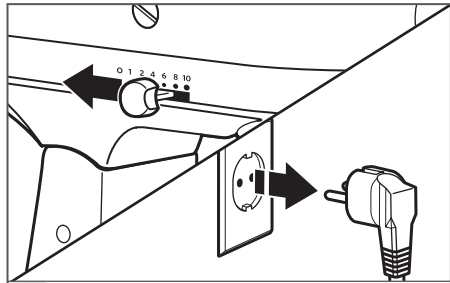

6 **To remove:** Turn speed control to "0". Unplug Stand Mixer.

USING THE STAND MIXER

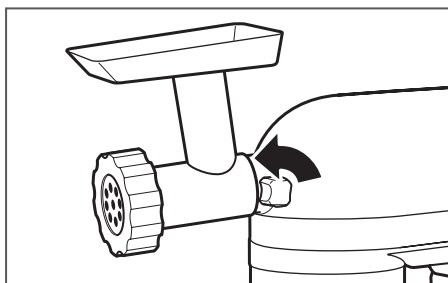

7

Loosen attachment knob by turning it counterclockwise. Rotate attachment slightly back and forth while pulling out.

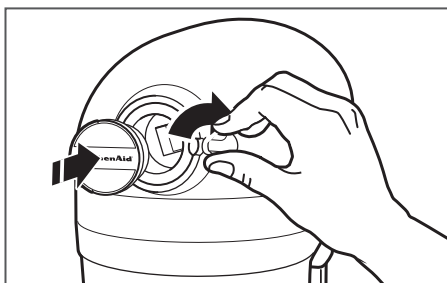

8

Replace attachment hub cover. Tighten attachment knob by turning it clockwise.

NOTE: See the Use and Care Guide of each specific attachment for recommended speed settings and operating times.

TIPS FOR GREAT RESULTS

EGG WHITES

Place room temperature egg whites in clean, dry bowl. Attach bowl and wire whip. To avoid splashing, gradually turn to designated speed and whip to desired stage.

AMOUNT	SPEED
1 egg white	GRADUALLY to 10
2 or more egg whites	GRADUALLY to 8

Whipping stages

With your KitchenAid Stand Mixer, egg whites whip quickly. Avoid over whipping.

WHIPPED CREAM

Pour cold whipping cream into chilled bowl. Attach bowl and wire whip. To avoid splashing, gradually turn to designated speed and whip to desired stage.

AMOUNT	SPEED
less than 200 ml (3/4 cup)	GRADUALLY to 10
more than 200 ml (3/4 cup)	GRADUALLY to 8

Whipping stages

Watch cream closely during whipping. Because your KitchenAid Stand Mixer whips so quickly, there are just a few seconds between whipping stages.

TIPS FOR GREAT RESULTS

MIXING TIPS

Mixing time

Your KitchenAid Stand Mixer will mix faster and more thoroughly than most other electric mixers. Therefore, the mixing time in most recipes must be adjusted to avoid over beating.

To help determine the ideal mixing time, observe the batter or dough and mix only until it has the desired appearance described in your recipe, such as “smooth and creamy.” To select the best mixing speeds, use the “Speed control guide” section.

Adding ingredients

The standard procedure to follow when mixing most batters, especially cake and cookie batters, is to add:

- 1/3 dry ingredients
- 1/2 liquid ingredients
- 1/3 dry ingredients
- 1/2 liquid ingredients
- 1/3 dry ingredients

Use Speed 1 until ingredients have been blended. Then gradually increase to desired speed.

Always add ingredients as close to side of bowl as possible, not directly into moving beater. The pouring shield can be used to simplify adding ingredients.

NOTE: If ingredients in very bottom of bowl are not thoroughly mixed, the beater is not far enough into the bowl. See the “Beater to bowl clearance” section.

Cake mixes

When preparing packaged cake mixes, use Speed 4 for medium speed and Speed 6 for high speed. For best results, mix for the time stated on the package directions.

Adding nuts, raisins, or candied fruits

Solid materials should be folded in the last few seconds of mixing on Speed 1. The batter should be thick enough to keep the fruit or nuts from sinking to the bottom of the pan during baking. Sticky fruits should be dusted with flour for better distribution in the batter.

Liquid mixtures

Mixtures containing large amounts of liquid ingredients should be mixed at lower speeds to avoid splashing. Increase speed only after mixture has thickened.

Kneading yeast doughs

ALWAYS use the dough hook to mix and knead yeast doughs. Use Speed 2 to mix or knead yeast doughs. Use of any other speed creates high potential for unit failure.

Do not use recipes calling for more than 900 g (7 cups) all-purpose flour or 800 g (6 cups) whole-wheat flour when making dough in a 4.3 L bowl.

Do not use recipes calling for more than 1 kg (8 cups) all-purpose flour or 800 g (6 cups) whole-wheat flour when making dough in a 4.8 L bowl.

CARE AND CLEANING

⚠ WARNING



Electrical Shock Hazard

Plug into an earthed outlet.

Do not remove earth prong.

Do not use an adapter.

Do not use an extension cord.

Failure to follow these instructions can result in death, fire, or electrical shock.

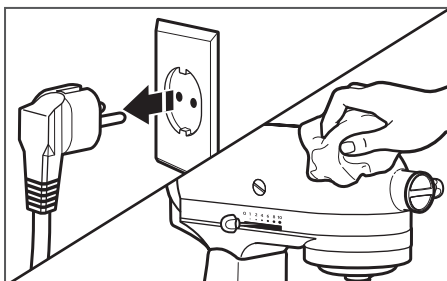

1

Always be sure to unplug Stand Mixer before cleaning. Wipe Stand Mixer with a soft, damp cloth. Do not use household/commercial cleaners. Wipe off beater shaft frequently, removing any residue that may accumulate. Do not immerse in water.

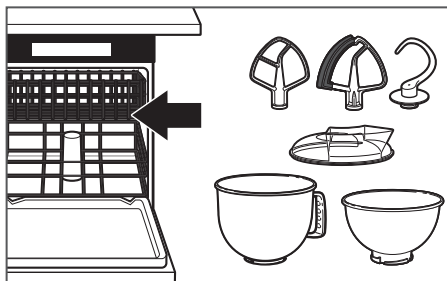

2

Bowl, pouring shield*, white flat beater, Flex Edge beater*, and white dough hook may be washed in a dishwasher. Or, clean them thoroughly in hot sudsy water and rinse completely before drying. Do not store beaters on shaft.

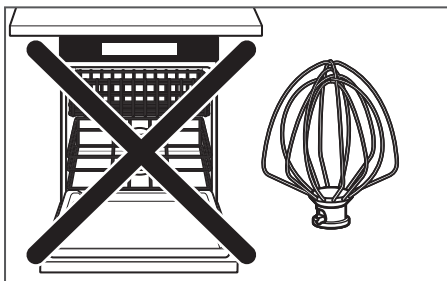

3

IMPORTANT: The wire whip is not dishwasher-safe. Clean it thoroughly in hot sudsy water and rinse completely before drying. Do not store wire whip on shaft.

* Included with select models only. Also available as an optional accessory.

⚠ WARNING



Electrical Shock Hazard

Plug into an earthed outlet.

Do not remove earth prong.

Do not use an adapter.

Do not use an extension cord.

Failure to follow these instructions can result in death, fire, or electrical shock.

Please read the following before calling your service centre.

1. The Stand Mixer may warm up during use. Under heavy loads with extended mixing time periods, you may not be able to comfortably touch the top of the unit. This is normal.
2. The Stand Mixer may emit a pungent odor, especially when new. This is common with electric motors.
3. If the flat beater hits the bowl, stop the Stand Mixer. See the "Beater to bowl clearance" section.

If your Stand Mixer should malfunction or fail to operate, please check the following:

- Is the Stand Mixer plugged in?
- Is the fuse in the circuit to the Stand Mixer in working order? If you have a circuit breaker box, be sure the circuit is closed.
- Turn off the Stand Mixer for 10-15 seconds, then turn it back on. If the Stand Mixer still does not start, allow it to cool for 30 minutes before turning it back on.
- If the problem is not due to one of the above items, see the "Warranty and service" section.

WARRANTY AND SERVICE

KITCHENAID STAND MIXER WARRANTY

Length of Warranty:	KitchenAid Will Pay For:	KitchenAid Will Not Pay For:
<p>Europe, Middle East and Africa: For Artisan models 5KSM125 and 5KSM175PS: five years full warranty from date of purchase.</p> <p>For models 5K45SS and 5KSM45: two years full warranty from date of purchase.</p>	<p>The replacement parts and repair labour costs to correct defects in materials or workmanship. Service must be provided by an Authorised KitchenAid Service Centre.</p>	<p>A. Repairs when Stand Mixer is used for operations other than normal household food preparation.</p> <p>B. Damage resulting from accident, alterations, misuse, abuse, or installation/operation not in accordance with local electrical codes.</p>

KITCHENAID DOES NOT ASSUME ANY RESPONSIBILITY FOR INDIRECT DAMAGES.

CUSTOMER SERVICE

In U.K. and Ireland:

For any questions, or to find the nearest KitchenAid Authorised Service Centre, please find our contact details below.

NOTE: All service should be handled locally by an Authorised KitchenAid Service Centre.

Contact number for U.K. and Northern Ireland:

Tollfree number 0800 988 1266 (calls from mobile phones are charged standard network rate) or call 0194 260 5504

Contact number for Ireland:

Tollfree number +44 (0) 20 8616 5148

E-mail contact for U.K. and Ireland:

Go to www.kitchenaid.co.uk, and click on the link "Contact Us" at the bottom of the page.

Address for U.K. and Ireland:

KitchenAid Europa, Inc.
PO BOX 19
B-2018 ANTWERP 11
BELGIUM

Number for general questions:



00800 3810 4026

In other countries:

For all product related questions and after sales matters, please contact your dealer to obtain the name of the nearest Authorised KitchenAid Service/Customer Centre.

For more information, visit our website at:

www.KitchenAid.co.uk
www.KitchenAid.eu

©2016 All rights reserved. KITCHENAID and the design of the Stand Mixer are trademarks in the U.S. and elsewhere.