

# KONFTEL



## The Konftel 300 User Guide

ENGLISH

## **OmniSound® HD – Optimal sound**

By incorporating full duplex audio, the patented audio technology OmniSound® guarantees the audio conference an impressive and crystal clear sound in both directions through a hypersensitive microphone with 360° sound pickup and speakers that provide powerful sound distribution to all participants.

OmniSound® HD offers HD audio transmission for VoIP calls. In addition features like echo cancellation, background noise suppression which minimizes distracting background noise and an equalizer for personal adjustment of the sound's various characteristics are also included. Move freely around the room, talk, discuss and debate while retaining great sound quality that is entirely free from irritating sound clipping, damping or echoes. It's as close as you can get to natural sound.



Konftel AB hereby declares that this conference unit complies with all essential requirements and other relevant provisions of Directive 1999/5/EC.

See [www.konftel.com/doc](http://www.konftel.com/doc) for a complete declaration.



### **Warning!**

do not expose the Konftel 300 to rain or moisture.



### **Warning!**

Do not open the case on the Konftel 300.



### **Warning!**

Only use the power adapter provided to connect the unit to the mains.

# TABLE OF CONTENTS

<b>Description</b>	<b>2</b>	Ending a recording.....	19
General.....	2	Listening to a recording.....	20
Maintenance .....	2	Managing recordings.....	21
Keypad.....	4	Adjusting the recording indicator.....	21
Navigation and selection in menus .....	5	Displaying recording feature status.....	21
<b>Connections</b>	<b>6</b>	<b>Settings</b>	<b>22</b>
Unpacking .....	6	Selecting languages.....	22
Connecting and installing.....	6	Select region.....	22
Select region and language.....	6	Deactivating keypad tones.....	22
Connectivity options.....	7	Adjusting date and time .....	22
<b>Answering and making calls</b>	<b>8</b>	Adjusting ring level volume .....	23
Answering calls.....	8	Adjusting the flash/R pulse duration .....	23
Ending calls.....	8	Selecting Caller ID standard .....	23
Making calls.....	8	Adjusting microphone volume with mobile phone connected .....	24
Making three-way calls on an analogue line	9	Adjusting sound (equalizer).....	24
VoIP calls.....	9	Settings for connecting external equipment (Aux).....	24
Calls via DECT and mobile phones.....	10	Settings for external PA system.....	24
<b>During a call</b>	<b>11</b>	Changing text on the display screen.....	25
Adjusting the speaker volume.....	11	Adjusting LCD contrast.....	25
Placing calls on temporary hold.....	11	Connect a remote control – pairing.....	25
Ending calls .....	11	Resetting.....	25
Switching lines during calls.....	12	Checking status.....	25
<b>Conference guide</b>	<b>13</b>	Settings during a call .....	26
Creating conference groups.....	13	<b>Upgrading software</b>	<b>27</b>
Making conference group calls .....	13	Installing Konftel Upgrade utility.....	27
Making multi-party calls .....	14	Upgrading software.....	27
Displaying conference group participants .....	14	<b>Technical specifications</b>	<b>28</b>
Editing conference groups .....	14	<b>Service and guarantee</b>	<b>30</b>
Deleting conference groups.....	15		
Delete all conference groups.....	15		
Conference guide settings .....	15		
Displaying conference guide status.....	16		
<b>Phonebook</b>	<b>17</b>		
Searching for contacts .....	17		
Adding contacts .....	17		
Editing contacts .....	17		
Deleting contacts.....	18		
Deleting all conference groups .....	18		
Displaying phonebook status.....	18		
<b>Recording</b>	<b>19</b>		
Starting a recording .....	19		
Mute function.....	19		
Hold.....	19		

# DESCRIPTION

## GENERAL

The Konftel 300 conference phone offers a host of innovative features:

- OmniSound® HD audio technology.
- USB connectivity allows the phone to be used to make VoIP calls.
- The line mode enables you to combine and switch easily between connectivity technologies – analogue, USB, mobile (GSM/DECT).
- Conference guide for easy set-up of multiparty calls.
- Record your meetings with an SD memory card so that you can listen to them later on.
- Expansion microphones can be added to increase the voice pickup range. (Optional.)
- A wireless headset or PA system can be connected. (Optional.)
- Can be upgraded with smart features, making it future-proof.
- 2 year guarantee.

The Konftel 300 is a future-proof product that is constantly evolving with smart new features.

## MAINTENANCE

Clean the equipment with a soft, dry cloth. Never use liquids.

# DESCRIPTION

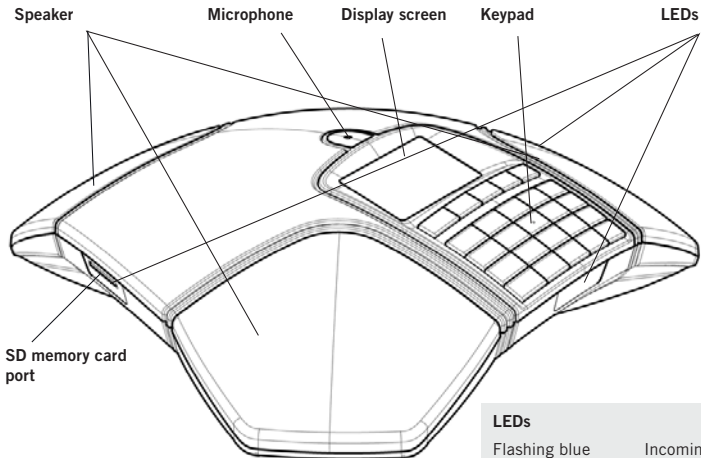

## LEDs

Flashing blue	Incoming call
Steady blue light	Call in progress
Flashing red	Hold, microphone and speaker turned off
Steady red light	Mute, microphone turned off

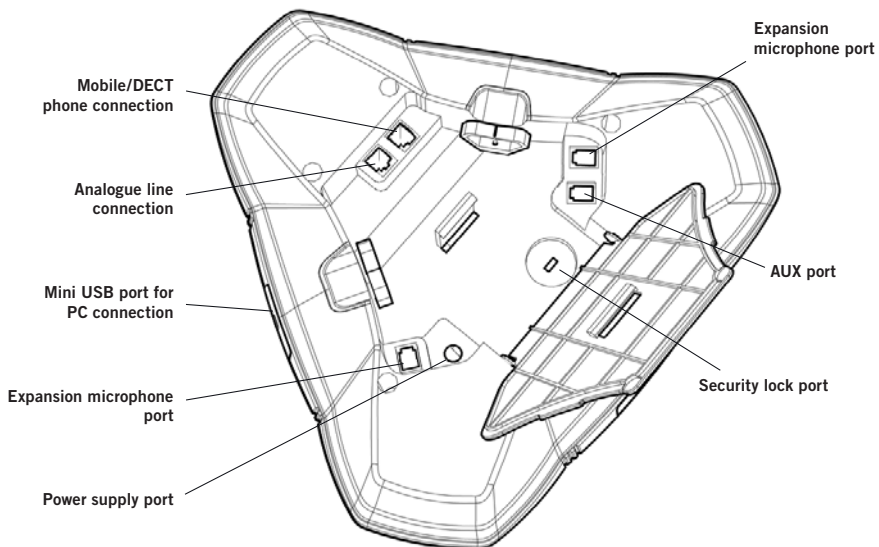

## KEYPAD

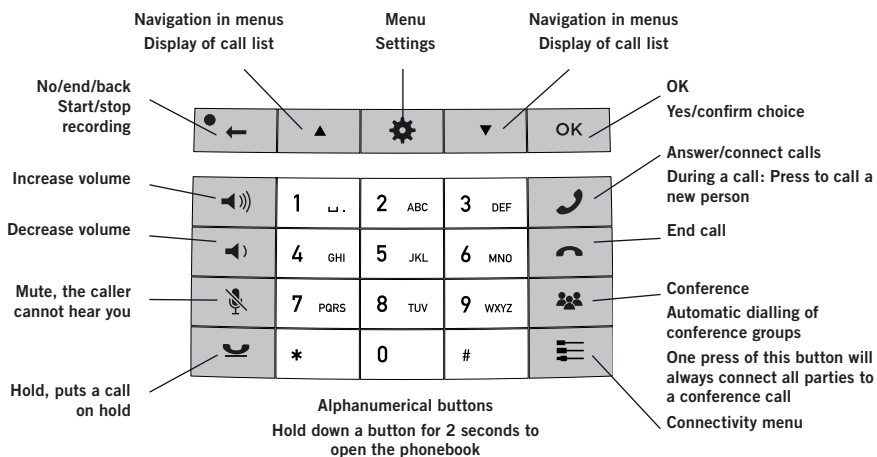

① Some Konftel 300M have a different keypad with other symbols. This does not affect the functions of the buttons.

## Writing text

Each button contains letters and characters – more than those shown on the button (see illustration below). Press the same button repeatedly to change to another character. If there are two letters under the same button that you want to enter one after the other, you need to pause slightly before entering the second letter.

Press the ● ← button to delete the last character you entered.

1 [space] . - 1	2 ABC A B C Ä Å 2	3 DE D E F É È 3
4 GHI G H I 4	5 JKL J K L 5	6 MN M N O Ö Ø Ñ 6
7 PQRS P Q R S 7	8 TUV T U V Ü Ú 8	9 WXYZ W X Y Z 9
* [asterisk]	0 0	# [hash]

# DESCRIPTION

## NAVIGATION AND SELECTION IN MENUS

- ⇒ Press **⚙**.
- ⇒ Select the option you want from the menu using the arrow buttons.
- ⇒ Confirm by pressing **OK** to select the marked option.
- ⇒ Cancel the setting or go back one level in the menu by pressing **⬅**.
- ⇒ Quit the menu by pressing **⚙** again.
- ① Note that after you have made changes to a setting, you must press **OK** to activate the setting.

### Writing style in instructions

In the instructions, **⚙ > SETTINGS** means you should:

- ⇒ Press **⚙**.
- ⇒ Mark the **SETTINGS** option using the arrow buttons and confirm by pressing **OK** to open the menu.

### Menu tree

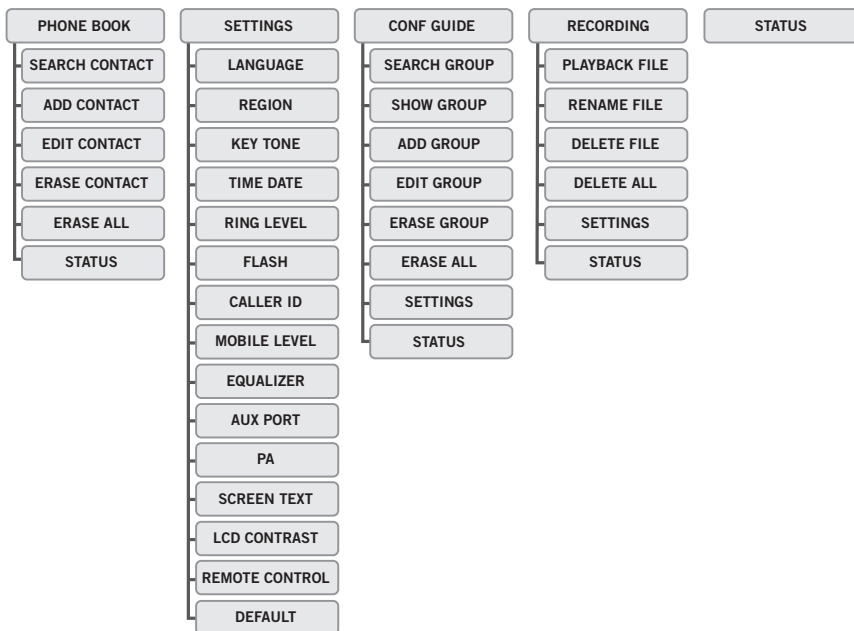

# CONNECTIONS

## UNPACKING

⇒ Check that all parts are included in the package. If any parts are missing, please contact your retailer.

- The Konftel 300 conference phone
- Power adapter with universal socket compatibility
- 7.5 metre cable for electric power and line connection
- 1.5 metre USB cable
- Intermediate plugs for analogue connection
- Quick reference guides in different languages

## CONNECTING AND INSTALLING

⇒ Connect to an analogue line, wireless DECT telephone/mobile phone or PC as illustrated.

ⓘ An optional phone cable is required for connection to DECT/mobile phones.

⇒ Plug the Konftel 300 into the mains using the power adapter as illustrated.

⇒ Place the conference phone in the middle of the table.

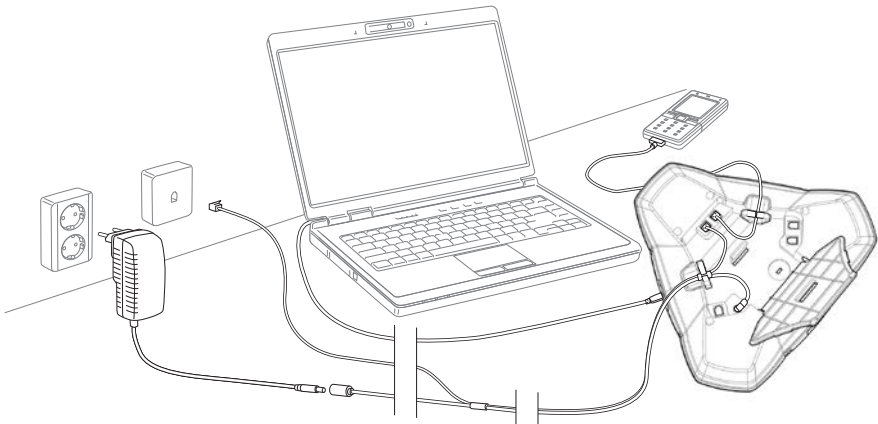

## SELECT REGION AND LANGUAGE

The first time the Konftel 300 is started, you will be required to select the region in which you are located. The Konftel 300 then automatically configures to the telecom network for that region.

⇒ Select the region in which you are located. Click **OK** to confirm your selection.

ⓘ You can use the arrow buttons to press an alphanumeric button to jump to the first region that starts with that letter in the list.

# CONNECTIONS

- ⇒ Select the language you want. Click **OK** to confirm your selection.
- ① Select  > **SETTINGS** if you want to set the date and time or make other adjustments.

## CONNECTIVITY OPTIONS

An analogue phone line is the pre-programmed option, but it is possible to switch between and combine two connectivity options.

- ⇒ Press the  key.
- ⇒ Use the arrow buttons to select a connectivity option and press **OK** to confirm your choice.

### Options

Connections:	The display screen shows:
• Analogue telephone line	ANALOGUE
• Mobile/DECT telephone	MOBILE
• Computer (VoIP)	USB
• Analogue telephone line+computer	ANALOGUE+USB
• Mobile/DECT telephone+computer	MOBILE+USB

Please turn to page 9 for instructions on using the Konftel 300 with a computer and a mobile/DECT telephone.

### Connection to a PC

You can hold group calls over the Internet using VoIP software (e.g. Skype®) with the Konftel 300. The Konftel 300 acts as a loudspeaker and microphone when making VoIP calls. In stand-by mode , it can also be used to play audio and music. When the Konftel 300 is in stand-by mode, the display screen shows that the microphone is turned off.

# ANSWERING AND MAKING CALLS

## ANSWERING CALLS

A ring tone is heard and the blue LEDs start flashing.

⇒ Press  to answer.

*The LEDs show a steady blue light. The duration of the call is shown on the display screen.*

## ENDING CALLS

⇒ End the call by pressing .

## MAKING CALLS

⇒ Dial the number.

⇒ Press .

*The number is called and the LEDs show a steady blue light. The duration of the call is shown on the display screen.*

Or:

⇒ Press .

⇒ Dial the number.

*The number is called and the LEDs show a steady blue light. The duration of the call is shown on the display screen.*

## Redialling

⇒ Press an arrow button.

*The last number that you dialled appears on the display screen.*

⇒ Use the arrow buttons to look through previously dialled numbers.

⇒ Press .

*The number you select is dialled.*

## Calling from the phonebook

Please turn to page 17 for instructions on adding and updating contacts in the phonebook.

⇒ Press and hold down a number button for two seconds.

*The phonebook appears on the display screen. The pre-programmed names appear in alphabetical order, starting with the number button's first letter.*

⇒ Use the arrow buttons to look through the phonebook.

⇒ Press .

*The contact you select is dialled.*

## MAKING THREE-WAY CALLS ON AN ANALOGUE LINE

The simplest way to set up a multi-party call is to use the conference guide (see page 13). You can connect another party to an on-going call as follows. During a call, the  button acts as R-pulse (flash), which means it transmits commands to the PBX.

① If you experience problems making multi-party calls: Different PBXs may require different signals. Please contact your telephone administrator or service provider. Turn to page 23 for more details.

⇒ Press .

*A second dialling tone is heard.*

⇒ Dial the second participant's number and wait for an answer.

⇒ Press the  button and then **3**.

*All three participants are now linked together in one call.*

🗣️ It is also possible to connect the lines by pressing the  (**Conference**) button, provided the settings for the Conference guide are correct, see page 15.

### If you don't get an answer when you dial the second number

⇒ Go back to the first call by pressing .

## VOIP CALLS

For these instructions, it is assumed that the computer is turned on, the VoIP software (e.g. Skype®) is running and the Konftel 300 is connected to the computer via the USB cable.

### Line mode

⇒ Press  and select USB as a phone line using the arrow buttons. Press **OK** to confirm.

### Connecting two lines

MOBILE+USB connects calls via mobile telephones with VoIP calls over the Internet.

ANALOGUE+USB connects calls on analogue lines with VoIP calls over the Internet.

### Making VoIP calls

⇒ Press .

*The Konftel 300 has now been put into call mode and the LEDs show a steady blue light.*

⇒ Indicate whether you want to connect a call with one user or several users in the computer's VoIP software.

*The Konftel 300 functions as a speaker and microphone for the computer.*

# ANSWERING AND MAKING CALLS

## Answering a VoIP call

- ⇒ Press .

*The Konftel 300 has now been put into call mode and the LEDs show a steady blue light.*

- ⇒ Indicate whether you want to start the call by answering in the computer's VoIP software.

*The Konftel 300 functions as a speaker and microphone for the computer.*

## Ending a VoIP call

- ⇒ End the call in the computer's VoIP software and put the Konftel 300 on stand-by by pressing .

*The Konftel 300 now only functions as a speaker for the computer.*

## CALLS VIA DECT AND MOBILE PHONES

For these instructions, it is assumed that the Konftel 300 is connected to a DECT or mobile telephone via a cable (optional accessory). Hereafter, both types of telephone are referred to as mobile phones.

### Select mobile as the telephone line

- ⇒ Press  and use the arrow buttons to select MOBILE as a phone line. Press **OK** to confirm.

If you select MOBILE+USB as the line mode in the Konftel 300, you will be able to combine the call with a call connected via the computer (see page 9).

### Making calls using a mobile phone

- ⇒ Press  and dial the number on the mobile phone as you normally would.



*The Konftel 300 now functions as a speaker and microphone for the mobile phone. The LEDs show a steady blue light.*

### Ending calls

- ⇒ Ending the call on the mobile phone.
- ⇒ Press  to turn off the Konftel 300.

# DURING A CALL

## ADJUSTING THE SPEAKER VOLUME



⇒ Adjust the speaker volume using the buttons  and .

### Adjusting the speaker volume when two lines are connected

If you have selected double lines, you can adjust the volume level for each line. This is useful if the lines have different volume levels.

⇒ Press the  button or the  button to display the current volume setting.

The current main volume appears on the display screen. Above it are two smaller volume indicators which can be used to adjust the two connection lines.

⇒ Increase or decrease the speaker volume for both lines in the normal way, using the  and  buttons.

⇒ Use the arrow buttons to mark either of the connected lines.

⇒ Select a line and adjust its speaker volume using the  and  buttons.

## PLACING CALLS ON TEMPORARY HOLD

### Mute

⇒ Press  to turn off the microphone.

*The LEDs change from blue to red. The other party cannot hear what you are saying.*

⇒ Press  to reconnect the call.

### Hold

⇒ Press  to put the call on hold.

*The LEDs change from blue to flashing red. Both the microphone and the speaker are turned off and the call is on hold.*

⇒ Press  to reconnect the call.

## ENDING CALLS

⇒ End the call by pressing .

## SWITCHING LINES DURING CALLS

### Connecting a new line during a call

You can add another line or switch between connected lines during a call.

⇒ Press the  button during the call.

*An indicator appears on the display screen in front of the selected line(s).*

⇒ Use the arrow buttons to mark the line you want to connect and confirm your choice by pressing .

*If you selected USB or MOBILE, this line will open. You then connect the call via the computer or mobile phone.*

*If you selected ANALOGUE, you will hear a dialling tone. You then dial the number on the Konftel 300 or use the Phonebook.*

ⓘ Please note that an analogue line and a mobile line cannot be used simultaneously. If you are using ANALOGUE or ANALOGUE+USB as a line connection and you wish to connect MOBILE during a call, the ANALOGUE line will be put on hold. This is indicated by a flashing LED on the display screen.

### Putting a line on hold during a call

⇒ Press the  button during the call.

⇒ Use the arrow buttons to mark the line you want to put on hold and press the  button.

*The indicator in front of the selected line starts to flash.*

⇒ Repeat the above to reconnect the line.

### Disconnecting a line during a call

⇒ Press the  button during the call.

⇒ Use the arrow buttons to mark the line you want to disconnect and confirm your choice by pressing .

*The indicator in front of the selected line goes out and the line is disconnected. The other calls can continue.*

# CONFERENCE GUIDE



The conference guide allows you to create 20 conference groups with up to six people in each. You can now call the participants in a meeting by simply pressing a few buttons.

You may need to adjust some settings in your Konftel 300 to make it compatible with your PBX. Please turn to page 16 in this User Guide for more details.

## Entering text with the keypad

Please turn to page 4 for instructions on using the keypad to enter text.





## CREATING CONFERENCE GROUPS

- ⇒ Select  > **CONF GUIDE** > **ADD GROUP**.
- ⇒ Enter a group name and press **OK** to confirm.
- ⇒ Press **OK** to enter the first person.
- ⇒ Write the name of the first person and press **OK** to confirm. Enter the number and press **OK** to confirm.
- ⇒ Press **OK** to add another person and repeat the above steps.
- ⇒ Conclude by pressing **•** .

## MAKING CONFERENCE GROUP CALLS

- ⇒ Press the  (**Conference**) button.
- ⇒ Select the conference group you want to call.  
*The Konftel 300 dials the first person and asks you to confirm when the person answers.*
- ⇒ Press **OK** when the first person has answered.
- ⇒ Continue in the same way for each person in the group.

### If you don't get an answer

- ⇒ Press **•**  if one of the persons you are trying to call does not answer.  
*The conference guide will ask you if you want to redial that person.*
  - ⇒ Either press **OK** or **•** .
  - If you decide not to redial (**•** ) you will be asked if you want to end the conference guide or continue to the next person.*
  - ⇒ Press **OK** to continue and **•**  to end the guide.  
*When the guide has ended, you will be connected with up to six people and ready to start your conference.*
-  Please note that you can also call a conference group via **SEARCH GROUP** in the **CONF GUIDE** menu.

## MAKING MULTI-PARTY CALLS

- ⇒ Press the  (**Conference**) button.
- ⇒ Select QUICK GUIDE with the arrow buttons. Press **OK** to confirm.  
*The Quick Guide asks you to dial the first number.*
- ⇒ Dial the first person's telephone number. Press **OK** to confirm.
- ⇒ Press **OK** when the first person has answered.
- ⇒ Press **OK** to call another person and repeat the above steps. Press **• ←** when you have called all the persons you want for your meeting.

If one of the persons does not answer, follow the steps for calling a saved conference group (see above).

## DISPLAYING CONFERENCE GROUP PARTICIPANTS

- ⇒ Select  > **CONF GUIDE** > **SHOW GROUP**.
- ⇒ Mark the group you want and press **OK**.  
*The names of the conference group participants are displayed.*

## EDITING CONFERENCE GROUPS

- ⇒ Select  > **CONF GUIDE** > **EDIT GROUP**.

Here, you can change the name of a conference group, add or delete a person from a group and change a person's name and phone number.

- ⇒ Mark your choice of option in the menu using the arrow buttons and press **OK** to confirm.  
*The names of the conference groups are displayed.*
- ⇒ Mark the group you want to change and press **OK** to confirm.
- ⇒ Mark a person you want to change and press **OK** to confirm.
- ⇒ Make the change and press **OK** to confirm.
- ① Delete a number or a letter in a name by pressing **• ←**. If you want to cancel the change you are making and leave the name or number as they were, press **• ←** until the CONFERENCE GUIDE menu appears.

## DELETING CONFERENCE GROUPS

- ⇒ Select **⚙** > **CONF GUIDE** > **ERASE GROUP**.
- ⇒ Mark the group you want to delete and press **OK**.
- ⇒ Confirm that you really want to delete the group by pressing **OK** or cancel the deletion of a group by pressing **• ←**.

## DELETE ALL CONFERENCE GROUPS

- ⇒ Select **⚙** > **CONF GUIDE** > **ERASE ALL**.
- ⇒ Confirm that you really want to delete all groups by pressing **OK** or cancel the deletion of all groups by pressing **• ←**.

## CONFERENCE GUIDE SETTINGS

When a multi-party call is going to be connected, a special signal (flash or R-pulse) is produced which transmits the command (request, return and conference) to the PBX. It may be necessary to change the type of signal if calls are connected via a PBX. Different PBXs may require different signals. These requirements should be specified in the technical data for the PBX. Settings for the most common PBXs are listed on Konftel's website.

- ⇒ Select **⚙** > **CONF GUIDE** > **SETTINGS**.
- ⇒ Enter the command for a request for a new dialling tone and press **OK** to confirm. ("F" is the default setting)
- ⇒ Enter the command to connect everyone to a multi-party call and press **OK** to confirm. ("F3" is the default setting)
- ⇒ Enter the command to return to your original call and press **OK** to confirm. ("F" is the default setting)

### If you experience problems making multi-party calls

It may be necessary to change the duration of the Flash/R-pulse so that it works with your PBX. Read "ADJUSTING FLASH/R-PULSE DURATION" on page 23.

Your PBX may not be programmed to admit multi-party calls or the procedure may be different. Please contact your telephone administrator or service provider.

## DISPLAYING CONFERENCE GUIDE STATUS

⇒ Select  > **CONF GUIDE** > **STATUS**.

*The display screen indicates the number of conference groups already stored plus how many more groups can be added.*

# PHONEBOOK

The Konftel 300 has a phonebook that holds up to 50 entries. See page 8 for making calls via the phonebook.

## Entering text with the keypad

Please turn to page 4 for instructions on using the keypad to enter text.

## SEARCHING FOR CONTACTS

- 🔍 The simplest way to search for a contact in the address book is to hold down a number button for two seconds (see page 8). You can also search for a contact via the PHONEBOOK menu.
- ⇒ Select **☛** > **PHONE BOOK** > **SEARCH CONTACT**.
- ⇒ Mark the contact you want.
- 📄 You can use the arrow buttons to press an alphanumeric button to jump to the first name that starts with that letter in the list.
- ⇒ Press **OK** or **📞** to dial the selected contact, **•** **←** to return to the PHONEBOOK menu or **☛** to exit the menu.

## ADDING CONTACTS

- ⇒ Select **☛** > **PHONE BOOK** > **ADD CONTACT**.
- ⇒ Enter the name of the contact and press **OK** to confirm.
- ⇒ Write the number and press **OK** to confirm.
- ⇒ Press **OK** to add another contact or **☛** to exit the menu.

## EDITING CONTACTS

- ⇒ Select **☛** > **PHONE BOOK** > **EDIT CONTACT**.
- ⇒ Mark the contact you want to change. Press **OK** to confirm.
- ⇒ Make the change and press **OK** to confirm.
- 📄 Delete a number or a letter in a name by pressing **•** **←**. If you want to cancel the change you are making and leave the name or number as they were, press **•** **←** until the PHONEBOOK menu appears.

## DELETING CONTACTS

- ⇒ Select **⚙** > **PHONE BOOK** > **ERASE CONTACT**.
- ⇒ Mark the contact you want to delete and press **OK**.
- ⇒ Confirm that you really want to delete the contact by pressing **OK** or cancel the deletion of a contact by pressing **•** **←**.

## DELETING ALL CONFERENCE GROUPS

- ⇒ Select **⚙** > **PHONE BOOK** > **ERASE ALL**.
- ⇒ Confirm that you really want to delete all contacts by pressing **OK** or cancel the deletion of a contact by pressing **•** **←**.

## DISPLAYING PHONEBOOK STATUS

- ⇒ Select **⚙** > **PHONE BOOK** > **STATUS**.

*The display screen indicates the number of contacts already stored plus how many more contacts can be added.*

# RECORDING

It is possible to record a phone conference on an SD (Secure Digital) memory card so you can listen to it later on.

A flashing symbol appears on the display screen during recording. A beep is heard every 20 seconds so that other parties in the call know it is being recorded. The beep can be turned off (see page 21).

The recorded call is saved on the memory card. The document is named after the time at which the recording began (e.g. 14-35-01.wav) and is saved in a folder with the current date. This name can be changed after the recording has ended (see page 21).

## STARTING A RECORDING

Remember to notify all parties in the call before you start recording.

⇒ Press the **• ←** button for two seconds and press **OK** to confirm.

*The recording symbol flashes on the display screen.*

## MUTE FUNCTION

⇒ Press the **🔇** button during a call to turn the microphone off.

*The LEDs change from blue to red.*

*The other party cannot hear what you are saying and only the called party is recorded.*

## HOLD

⇒ Press **📞** during the call to put the call on hold.

*The LEDs change from blue to flashing red.*

*Both the microphone and the speaker are turned off and the call is on hold. None of the parties will now be recorded.*

## ENDING A RECORDING

⇒ Press the **• ←** button for two seconds and press **OK** to confirm.

*The recording symbol is no longer displayed on the screen.*

## LISTENING TO A RECORDING

You can listen to a recorded phone conference on your Konftel 300 or a computer using an SD memory card reader. Recordings are saved in .wav format and can be played back on your choice of media player.

Listening to recordings on the Konftel 300:

⇒ Select **☛** > **RECORDING** > **PLAYBACK FILE**.

⇒ Mark the folder you want (date) and press **OK** to confirm.

*A list of all recordings for the specified date is displayed. Names, date, time and length are displayed for each recording.*

⇒ Mark the recording you want and start the playback by pressing **OK**.

### Adjusting the speaker volume

⇒ Increase the volume using the **⏮**) button and lower it using **⏭**).

### Pause playback

⇒ Pause the playback by pressing **OK**.

⇒ Restart playback by pressing **OK** again.

### Move forward in the recording during playback

⇒ Move forward in the recording by pressing arrow down or backward by pressing arrow up.

① The recording advances about 10 seconds every time you press the button.

You can also jump further forward in the recording:

Key 3 – forward 1 minute

Key 6 – forward 10 minutes

Key 1 – backward 1 minute

Key 4 – backward 10 minutes

### Stop playback

⇒ Stop the playback by pressing **• ←**.

## MANAGING RECORDINGS

### Editing the name of a recording

① The recording is named by default with the time at which the recording started.

⇒ Select **⚙** > **RECORDING** > **RENAME FILE**.

⇒ Mark the folder you want and press **OK** to confirm.

⇒ Mark the recording to be edited and press **OK**.

⇒ Make the change and press **OK** to confirm.

① Delete a number or a letter in a name by pressing **•** ←.

If you want to cancel the change you are making and leave the name or number as they were, press **•** ← several times until the **RECORDING** menu appears.

### Deleting a recording

⇒ Select **⚙** > **RECORDING** > **DELETE FILE**.

⇒ Mark the folder you want and press **OK**.

⇒ Mark the recording to be deleted and press **OK**.

⇒ Confirm that you really want to delete the recording by pressing **OK** again, or cancel the deletion of a recording by pressing **•** ←.

### Deleting all recordings

⇒ Select **⚙** > **RECORDING** > **DELETE ALL**.

⇒ Confirm that you really want to delete all recordings by pressing **OK** again, or cancel the deletion of a recording by pressing **•** ←.

## ADJUSTING THE RECORDING INDICATOR

A short beep is heard every 20 seconds so that all the parties in the call know it is being recorded. This feature can be turned off.

⇒ Select **⚙** > **RECORDING** > **SETTINGS**.

⇒ Select your choice and press **OK** to confirm.

## DISPLAYING RECORDING FEATURE STATUS

⇒ Select **⚙** > **RECORDING** > **STATUS**.

*The display screen indicates the number of recordings, the total length of recorded calls and how many hours of recording time are left before the memory card is full.*

# SETTINGS

## SELECTING LANGUAGES

- ⇒ Select **⚙** > **SETTINGS** > **LANGUAGE**.
- ⇒ Select the language you want and press **OK** to confirm.

## SELECT REGION

The first time the Konftel 300 is started, you will be required to select the region in which you are located. The Konftel 300 then automatically configures to the telecom network for that region. Your selected entries can be changed later via this menu.

- ⇒ Select **⚙** > **SETTINGS** > **REGION**.
- ⇒ Select the region in which you are located.

## DEACTIVATING KEYPAD TONES

You can select whether or not you want a tone to be heard when you press a button. Note that this setting does not affect the tone you hear when you dial a number in call mode.

- ⇒ Select **⚙** > **SETTINGS** > **KEY TONE**.
- ⇒ Select your choice and press **OK** to confirm.

## ADJUSTING DATE AND TIME

### Changing the date

- ⇒ Select **⚙** > **SETTINGS** > **TIME DATE** > **DATE**.
- ⇒ Change the flashing figures for the year using the arrow buttons or by entering the figures on the keypad. Press **OK** to confirm and to continue to the month, and then proceed in the same way for the day.

### Changing the time

- ⇒ Select **⚙** > **SETTINGS** > **TIME DATE** > **TIME**.
- ⇒ Change the flashing figures for the hour using the arrow buttons or by entering the figures on the keypad. Press **OK** to confirm and to continue to minutes.

### Changing the time format

- ⇒ Select **⚙** > **SETTINGS** > **TIME DATE** > **TIME FORMAT**.
- ⇒ Select either a 12-hour or a 24-hour format using the arrow buttons and press **OK** to confirm your choice.

## ADJUSTING RING LEVEL VOLUME

⇒ Select **⚙** > **SETTINGS** > **RING LEVEL**.

⇒ Select your choice and press **OK** to confirm.

① There are six volume levels plus a silent mode. You will hear the ring tone for each level you select. If you select silent mode, an LED on the phone flashes when an incoming call is received.

## ADJUSTING THE FLASH/R PULSE DURATION

The Flash/R pulse (Register recall) is used to request a new line from the PBX. Different countries and PBXs may require different durations for activating the Flash/R pulse. Duration requirements should be specified in the technical data for the PBXs.

⇒ Select **⚙** > **SETTINGS** > **FLASH**.

⇒ Select your choice and press **OK** to confirm.

Examples of suitable settings are:

100 ms – Scandinavia, Europe, Siemens HiPath

300 ms – Germany, France, Israel

500 ms – USA

## SELECTING CALLER ID STANDARD

Konftel 300 needs to be configured to match the Caller ID standard in your country.

Note that in some cases even individual states/provinces within a country use different standards. The table below is a guideline for choosing the correct setting. If the caller ID is not working properly, select another setting or contact your telephone service provider for further information.

Caller ID standard	Country
Bellcore (Telcordia)	Canada (usually), USA, Australia, New Zealand, China, Hong Kong, Singapore
ETSI	Austria, Belgium, Czech Republic, France, Germany, Italy, Luxemburg, Norway, Poland, Spain, Slovenia, Switzerland, Turkey, South Africa, Taiwan
BT (British Telecom)	United Kingdom
DTMF	Denmark, Finland, Greece, Iceland, Netherlands, Portugal, Sweden, China, India, Saudi Arabia, Brazil, Uruguay

⇒ Select **⚙** > **SETTINGS** > **CALLER ID**.

⇒ Select your choice and press **OK** to confirm.

## ADJUSTING MICROPHONE VOLUME WITH MOBILE PHONE CONNECTED

The Konftel 300 microphone has seven volume settings, so if the volume of calls via DECT/mobile phones is too soft or too loud, you can easily adjust it to the right level.

- ⇒ Select **⚙** > **SETTINGS** > **MOBILE LEVEL**.
- ⇒ Select your choice and press **OK** to confirm.

## ADJUSTING SOUND (EQUALIZER)

The sound reproduction can be adjusted to the required pitch (SOFT, NEUTRAL and BRIGHT).

- ⇒ Select **⚙** > **SETTINGS** > **MOBILE LEVEL**.
- ⇒ Select your choice and press **OK** to confirm.

## SETTINGS FOR CONNECTING EXTERNAL EQUIPMENT (AUX)

The Konftel 300 can be connected to a wireless headset or an external PA system. An optional PA interface box is required for PA system connection.

- ⇒ Select **⚙** > **SETTINGS** > **AUX PORT**.
- ⇒ Select the PA option to activate features for external microphone mixer and PA system.
- ⓘ Do not select the PA option unless a PA system is connected. This option turns off the internal microphone and internal speakers. The HEADSET option may be selected whether or not a headset is connected.

## SETTINGS FOR EXTERNAL PA SYSTEM

It is assumed that the PA option has been activated in the previous menu before making these settings.

- ⇒ Select **⚙** > **SETTINGS** > **PA**.
- ⇒ Select INTERNAL MIC and press **OK** to switch between on (shaded box) and off.
- ⓘ To ensure maximum audio quality, do not use the internal microphone and external microphones connected via the PA interface box at the same time.
- ⓘ Only the internal microphone is turned off. Any external microphones connected to the Konftel 300 are still turned on.
- ⇒ Select INTERNAL SPKR and press **OK** to switch between on (shaded box) and off.
- ⓘ To ensure maximum audio quality, do not use the internal speakers and external speakers connected via the PA interface box at the same time.

## CHANGING TEXT ON THE DISPLAY SCREEN

The text on the display screen can be changed when the Konftel 300 is on hook.

- ⇒ Select **⚙** > **SETTINGS** > **SCREEN TEXT**.
- ⇒ Delete existing text using **•** **←** and enter your new text. Press **OK** to confirm.

## ADJUSTING LCD CONTRAST

- ⇒ Select **⚙** > **SETTINGS** > **LCD CONTRAST**.
- ⇒ Select your choice and press **OK** to confirm.

## CONNECT A REMOTE CONTROL – PAIRING

- ⇒ Select **⚙** > **SETTINGS** > **REMOTE CONTROL** on the conference phone.
- ⇒ Press **OK** to set the conference phone in pairing mode.
- ⇒ Press and hold down the **↵** and **⏪** buttons on the remote control at the same time for three seconds.

*The red LEDs on the remote control start to flash. A confirmation of successful pairing is displayed on the Konftel 300.*

The buttons on the remote control work in same way as the conference phone buttons.

## RESETTING

There is a menu option under SETTINGS that resets all settings to default. Please note that this also deletes all contacts in the phonebook and all groups saved in the conference guide.

- ⇒ Select **⚙** > **SETTINGS** > **DEFAULT**.
- ⇒ Confirm that you really want to reset the settings to default by pressing **OK** again, or cancel the resetting procedure by pressing **•** **←**.

## CHECKING STATUS

If you need to check the software version or serial number.

- ⇒ Select **⚙** > **STATUS**.

## SETTINGS DURING A CALL

The HEADSET/PA, PHONE BOOK, MOBILE LEVEL and EQUALIZER menus may be accessed during a call and are displayed when the **⚙** button is pressed. The first option is either HEADSET or PA depending on whether PA is activated or not.

① These HEADSET/PA settings can only be accessed when a call is connected.

### Turn off the internal speakers when using a headset

① PA should not be activated when using the HEADSET menu option.

A wireless headset can be used if a person needs to move far away from the conference phone (e.g. during a seminar or presentation). The internal speakers can be turned off temporarily if you wish to use the Konftel 300 as a personal telephone with a headset.

⇒ Select **⚙** > **HEADSET**.

⇒ Select YES when asked “SPEAKER OFF?”.

① The speakers come on automatically when the call is ended.

### Adjusting PA calibration manually

It is possible to calibrate the duplex performance of the conference phone when it is connected to a PA system. The calibration level can be set automatically by the Konftel 300 or adjusted manually to any value between 0 and 5 (0 being full duplex).

- Increase the calibration if the remote party experiences disturbing echoes.
- Decrease the calibration if the remote party experiences low duplex, i.e. your voice is muted or clipped when the other party is speaking.

① The position of the PA system's microphones and speakers and the amplifier's settings may affect full duplex performance.

⇒ Select **⚙** > **PA** > **CALIBRATION**.

① AUTO is the default setting and is recommended in most cases. The figure shown in brackets is the measured calibration value.

⇒ Select different levels and compare the audio quality to achieve your preferred setting.

① NB. You must ask the person you are calling to assess the effect of the adjustments you make.

### Adjusting microphone volume from PA system

① PA should be activated when using the PA menu option.

⇒ Select **⚙** > **PA** > **PA MONITOR**.

⇒ Adjust the microphone volume from the mixer so that the level on the display screen is around 10–12 when speaking in a normal tone.

# UPGRADING SOFTWARE

The Konftel 300 is continually being developed with smart features. You will first need to install Konftel Upgrade utility on your computer before you can upgrade your Konftel 300. Find out more at [www.konftel.com/upgrades](http://www.konftel.com/upgrades).

## INSTALLING KONFTEL UPGRADE UTILITY

- ⇒ Go to the website [www.konftel.com/upgrades](http://www.konftel.com/upgrades) and select Konftel 300.
- ⇒ Click to download Konftel Upgrade utility.
- ⇒ Install the software on your computer.
  - Follow the instructions given by the installation program.
  - We recommend that you open the installation instructions document (PDF).

## UPGRADING SOFTWARE

- ⇒ Connecting the Konftel 300 to the computer using the USB cable.
- ⇒ Start the Konftel Upgrade utility software on your computer from the Start menu.
  - Follow the instructions that the software guide gives you.
  - We recommend that you open and read the installation instructions document (PDF).

# TECHNICAL SPECIFICATIONS

Size	Diameter 240 mm, height 77 mm
Weight	1 kg
Colour	Charcoal black
Display screen	Illuminated graphics (LCD), 128x64
Keypad	Alphanumerical 0–9, *, off hook/F, on hook, mute, hold, volume up, volume down, 5 buttons for menu navigation, line mode, conference guide
Anti-theft protection	Kensington security slot
Memory	Support for SD memory cards up to 2 GB
Upgrades	The Konftel Upgrade utility upgrades Konftel 300 software via the USB connection

## Connectivity

Analogue telephone connectivity	Modular 6/6 modular (RJ11) to a public analogue telecommunication network or an analogue PBX
PC connectivity	USB 2.0 Mini B
Mobile/DECT connectivity	6/6 DEC
Power supply	AC adapter 100–240 V AC/14 V DC
Expansion microphones	2 modular 4/4
Auxiliary	Modular 4/4 for wireless headset

## Audio

Technology	OmniSound® HD
Microphone	Omni-directional
Reception area	Up to 30 metres <sup>2</sup> , >10 people
Speakers	Frequency band 200–3300 Hz, analogue line 200–7000 Hz, USB VoIP 150–15000 Hz, USB playback
Sound level	90 dB SPL 0.5 m
Equalizer	Three pitches: soft, neutral, bright

# TECHNICAL SPECIFICATIONS

## Environment

Temperature	5°–40°C
Relative humidity	20–80% condensation free
Recommended acoustic conditions	Reverberation period: 0.5 S Rt 60 Background noise: 45 dBA

# SERVICE AND GUARANTEE

If anything is wrong with your Konftel unit, please contact the place of purchase.

## **Guarantee**

We give a two-year guarantee on our conference telephones.

## **Service**

Service is offered after the expiration of the guarantee. Please contact your retailer and ask for a cost estimate.

## **Konftel support**

If you have any questions about the guarantee and service, please contact your Konftel support centre

Europe: +46(0)90-706 489 (Monday–Friday 8.00–17.00 GMT+1)

E-mail: [rma@konftel.com](mailto:rma@konftel.com)

### **USA and Canada:**

+1 866-606-4728 (Monday–Friday 08.00–17.00 GMT-8)

E-mail: [konftel.usa@konftel.com](mailto:konftel.usa@konftel.com)

Konftel is a leading company and the world's fastest growing brand, within audio conferencing equipment. Since 1988, our mission has been to help people around the world to conduct meetings despite distances. Based on our success, we know that audio conferencing is a great way to save time, money and at the same time contribute to a better environment. High audio quality is essential for efficient meetings, this is why our patented audio technology OmniSound®, is built into all Konftel Conference phones. The products are sold globally under the Konftel brand and our head-quarter is based in Sweden. Read more about the company and products on [www.konftel.com](http://www.konftel.com)



Konftel AB, Box 268, SE-901 06 Umeå, Sweden  
Phone: +46 90 706 489 Fax: +46 90 131 435 E-mail: [info@konftel.com](mailto:info@konftel.com)

[www.konftel.com](http://www.konftel.com)