

IDOLA

ISTRUZIONI PER L'USO
OPERATING INSTRUCTIONS
MODE D'EMPLOI
BEDIENUNGSANLEITUNG
INSTRUCCIONES DE USO
INSTRUÇÕES DE UTILIZAÇÃO



LEGGERE
ATTENTAMENTE
LE ISTRUZIONI

READ THE
INSTRUCTIONS
CAREFULLY

LIRE
ATTENTIVEMENT
LES INSTRUCTIONS

DIE
BEDIENUNGSANLEITUNG
AUFMERKSAM LESEN

LEER ATENTAMENTE
LAS INSTRUCCIONES

LER ATENTAMENTE
AS INSTRUÇÕES

Congratulazioni!

Gentile Cliente ci congratuliamo per aver scelto la macchina da caffè espresso Lavazza A MODO MIO e la ringraziamo per la fiducia accordataci.

Prima di mettere in funzione la macchina, consigliamo di leggere attentamente le istruzioni per l'uso che spiegano come utilizzarla, pulirla e mantenerla in perfetta efficienza. Non ci resta che augurarle la preparazione di tanti ottimi caffè grazie a Lavazza!

Welcome!

Dear Customer thank you for purchasing the Lavazza A MODO MIO espresso coffee machine and for choosing our company.

Before operating the machine, we recommend you carefully read the operating instructions that explain how to use, clean and maintain it in perfect working order. We hope you enjoy brewing authentic Italian coffee, thanks to Lavazza!

Félicitations!

Cher Client, vous avez choisi le système expresso Lavazza A MODO MIO et nous vous remercions de votre confiance. Avant de mettre votre machine en marche, nous vous recommandons de lire attentivement ce mode d'emploi. Il vous explique comment utiliser, nettoyer et conserver votre machine en parfait état de fonctionnement. Nous vous souhaitons d'intenses moments de dégustations.

Herzlichen Glückwunsch!

Sehr geehrter Kunde, wir gratulieren Ihnen zum Kauf dieser Espresso-Maschine Lavazza A MODO MIO und wir danken Ihnen für das Vertrauen, das Sie uns entgegenbringen. Bevor Sie die Maschine in Betrieb nehmen, empfehlen wir Ihnen, die Gebrauchsanweisung aufmerksam zu lesen, in der der Gebrauch, die Reinigung und die Pflege beschrieben werden. Nun wünschen wir Ihnen viel Spaß bei der Zubereitung von vielen köstlichen Kaffees mit Lavazza!

¡Enhorabuena!

Estimado cliente, enhorabuena por haber elegido la máquina de café expreso Lavazza A MODO MIO y gracias por confiar en Lavazza. Antes de poner la cafetera en marcha, le aconsejamos que lea atentamente las instrucciones de uso, donde se explica cómo utilizarla, limpiarla y mantenerla en condiciones óptimas.

¡Le deseamos que disfrute preparando infinidad de cafés excepcionales gracias a Lavazza!

Parabéns!

Estimado cliente, felicitamo-lo por ter escolhido a máquina de café expreso Lavazza A MODO MIO e agradecemos a confiança que depositou em nós.

Antes de colocar a máquina em funcionamento, aconselhamos que leia atentamente as instruções de utilização que explicam como a mesma deve ser utilizada, limpa e mantida de forma perfeitamente eficiente. Só nos resta desejar-lhe a preparação de muitos ótimos cafés graças à Lavazza!

⚠ Destinazione d'uso:

Questo apparecchio è destinato ad essere utilizzato nelle applicazioni domestiche e similari quali:

- nelle zone per cucinare riservate al personale nei negozi, negli uffici e in altri ambienti professionali;
- nelle fattorie;
- utilizzo da parte di clienti di alberghi, motel e altri ambienti a carattere residenziale;
- negli ambienti tipo bed and breakfast.

È vietato qualunque utilizzo improprio (non descritto nelle presenti istruzioni).

È vietato apportare modifiche tecniche. L'apparecchio può essere utilizzato da bambini di età non inferiore a 8 anni e da persone con ridotte capacità fisiche, sensoriali o mentali, o prive di esperienza o della necessaria conoscenza, purché sotto sorveglianza oppure dopo che le stesse abbiano ricevuto istruzioni relative all'uso sicuro dell'apparecchio e alla comprensione dei pericoli ad esso inerenti.

I bambini non devono giocare con l'apparecchio.

La pulizia e la manutenzione destinata ad essere effettuata dall'utente non deve essere eseguita da bambini senza sorveglianza.





⚠ Ubicazione:

Sistemare la macchina per caffè in un posto sicuro, dove nessuno possa rovesciarla o venirne ferito. Non tenere la macchina a temperatura inferiore a 5°C poiché il gelo potrebbe danneggiarla. Non usare la macchina per caffè all'aperto.

Non posare la macchina su superfici molto calde e/o nelle vicinanze di fiamme libere. La macchina per caffè quando è in uso non deve essere collocata in un armadio.

⚠ Alimentazione di corrente:

Collegare la macchina per caffè soltanto ad una presa di corrente adeguata. La tensione deve corrispondere a quella indicata sulla targhetta della macchina.

-  **Cavo d'alimentazione:**
Non usare la macchina per caffè se il cavo d'alimentazione è difettoso.
Se il cavo d'alimentazione è danneggiato, esso deve essere sostituito dal costruttore o dal suo servizio di assistenza tecnica o comunque da una persona con qualifica simile, in modo da prevenire ogni rischio. Non far passare il cavo d'alimentazione per angoli e su spigoli vivi, sopra oggetti molto caldi e proteggerlo dall'olio.
Non portare o tirare la macchina per caffè tenendola per il cavo.
Non estrarre la spina tirandola per il cavo; non toccarla con le mani bagnate.
Evitare che il cavo d'alimentazione cada liberamente da tavoli o scaffali.
-  **Pericolo di folgorazione:**
Non mettere mai a contatto dell'acqua le parti sotto tensione e/o corrente.
Questo apparecchio non deve essere immerso nell'acqua.
-  **Protezione bambini al di sotto degli 8 anni:**
Tenere i bambini sotto supervisione, per evitare che giochino con l'apparecchio.
I bambini non si rendono conto del pericolo connesso agli elettrodomestici.
Non lasciare alla loro portata i materiali utilizzati per imballare la macchina.
-  **Pericolo di ustioni:**
Non toccare le parti calde (gruppo porta-capsula, etc.) subito dopo l'uso dell'apparecchio. Durante l'erogazione della bevanda prestare attenzione ad eventuali schizzi di liquido caldo.
-  **Pulizia:**
Prima di pulire la macchina, è indispensabile scollegare la spina dalla presa di corrente ed aspettare che la macchina si raffreddi. Non immergere la macchina nell'acqua! È severamente vietato cercare d'intervenire all'interno della macchina. Sostituire l'acqua nel serbatoio dopo 3 giorni di inutilizzo.
Per evitare di danneggiare l'apparecchio non utilizzare detergenti alcalini per la pulizia, bensì un panno morbido e un detergente delicato.



Custodia della macchina:

Quando la macchina rimane inutilizzata per un periodo prolungato, staccare la spina dalla presa e custodirla in luogo asciutto e non accessibile ai bambini. Proteggerla dalla polvere e dallo sporco.



Riparazioni / Manutenzione:

Nel caso di guasti, difetti o sospetto di difetto dopo una caduta, staccare subito la spina dalla presa. Non mettere in funzione una macchina difettosa. Soltanto i Centri di Assistenza Autorizzati possono effettuare interventi e riparazioni. Nel caso di interventi non eseguiti a regola d'arte, si declina ogni responsabilità per eventuali danni.



Serbatoio acqua:

Immettere nel serbatoio soltanto acqua fresca potabile non gasata. Non mettere in funzione la macchina se non c'è acqua a sufficienza nel serbatoio.



Vano capsule:

Nel vano capsule devono essere inserite solo capsule Lavazza **A MODO MIO** o compatibili; non inserire le dita o qualsiasi altro oggetto. Le capsule sono da usarsi una sola volta.



Smaltimento della macchina a fine vita:

INFORMAZIONE AGLI UTENTI: il simbolo del cassonetto barrato riportato sull'apparecchiatura o sulla sua confezione indica che il prodotto alla fine della propria vita utile deve essere raccolto separatamente dagli altri rifiuti.

L'utente dovrà, pertanto, conferire l'apparecchiatura giunta a fine vita agli idonei centri di raccolta differenziata dei rifiuti elettrici ed elettronici.

L'adeguata raccolta differenziata per l'avvio successivo dell'apparecchiatura dismessa al riciclo, al trattamento e allo smaltimento ambientalmente compatibile contribuisce ad evitare possibili effetti negativi sull'ambiente e sulla salute e favorisce il reimpiego e/o riciclo dei materiali di cui è composta l'apparecchiatura.

Lo smaltimento abusivo del prodotto da parte dell'utente comporta l'applicazione delle sanzioni amministrative previste dalla normativa vigente.

CONTENUTO DELLA CONFEZIONE *

- Macchina IDOLA
- Kit di benvenuto composto da 9 capsule assortite Lavazza **A MODO MIO** e brochure Lavazza **A MODO MIO**

- Libretto di istruzioni
- Guida rapida
- Foglio garanzia

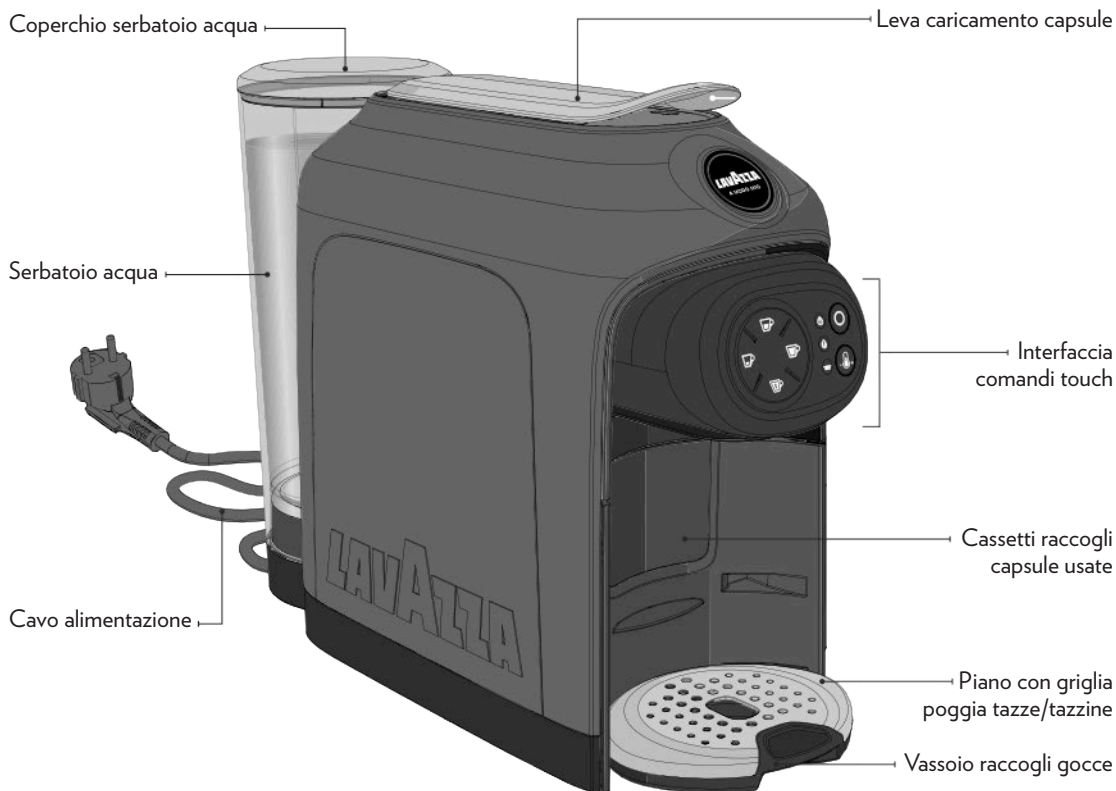







































* Le caratteristiche ed il contenuto della confezione possono variare in base al mercato di riferimento.







INTERFACCIA COMANDI TOUCH

- | | | | |
|----------|---------------------------------|----------|--------------------------------|
| 1 | Tasto erogazione ESPRESSO | 6 | Spia mancanza acqua |
| 2 | Tasto erogazione ESPRESSO LUNGO | 7 | Spia cassetto raccogli capsule |
| 3 | Tasto erogazione CAFFÈ LUNGO | 8 | Tasto On / Stand-by |
| 4 | Tasto erogazione DOSE LIBERA | 9 | Tasto Boost TEMPERATURA |
| 5 | Spia decalcificazione | | |

STATO INTERFACCIA								
Stand-by								
Accensione								
Riscaldamento								
Macchina pronta (in temperatura)								
Erogazione espresso (tasto 1)								
Erogazione espresso lungo (tasto 2)								
Erogazione caffè lungo (tasto 3)								
Erogazione dose libera (tasto 4)								
Mancanza acqua nel serbatoio								

STATO INTERFACCIA							
Cassetto raccogli capsule usate pieno 							
							 
Cassetto raccogli capsule usate posizionato male o rimosso 							
							 
Decalcificazione richiesta							
							 
Blocco macchina 							
							  Rossa

 = Spento
  = Acceso
  = Lampeggiante
  = Feedback acustico

! Non si assumono responsabilità per eventuali danni in caso di:

- impiego errato e non conforme agli scopi previsti;
- riparazioni eseguite presso centri d'assistenza non autorizzati;
- manomissione del cavo d'alimentazione;
- manomissione di qualsiasi componente della macchina;
- impiego di pezzi di ricambio e accessori non originali;
- mancata decalcificazione;
- stoccaggio in locali al di sotto di 4°C;
- utilizzo al di sotto di 5°C;
- utilizzo al di sopra di 40°C;
- utilizzo in locali con umidità relativa superiore al 95%;
- utilizzo di capsule non compatibili.

In questi casi viene a decadere la garanzia.

AVVIAMENTO MACCHINA

! Posizionare la macchina su una superficie piana e stabile, lontano da acqua e fonti di calore. I danni causati alla macchina a causa della mancata osservanza di queste indicazioni non sono coperti da garanzia.

- 1** Sollevare e rimuovere il coperchio, dopodiché estrarre il serbatoio dell'acqua.
- 2** Risciacquare il serbatoio prima di utilizzarlo.
- 3** Riempire il serbatoio dell'acqua fino al livello MAX indicato, usando soltanto acqua fresca potabile non gasata. Rimontare il serbatoio e richiudere con il coperchio.

i È possibile sollevare il coperchio e riempire direttamente il serbatoio.

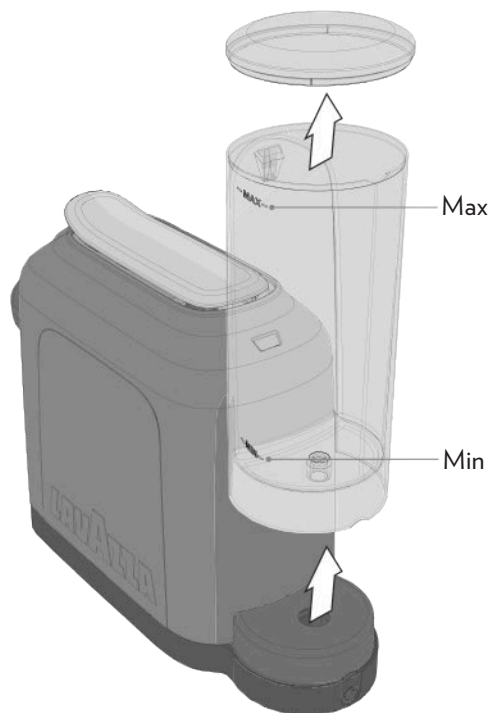

! Il livello dell'acqua non deve mai superare il MAX. Utilizzare esclusivamente acqua fresca potabile non gasata. Acqua calda e altri liquidi possono danneggiare il serbatoio e la macchina. Non mettere in funzione la macchina senza acqua: accertarsi che ve ne sia a sufficienza all'interno del serbatoio.

! Assicursi che le mani, la macchina, il cavo e la superficie d'appoggio della macchina non siano bagnati.

- 4** Inserire la spina di alimentazione nella presa di corrente.

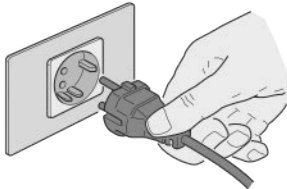

- 5** Premere il tasto On/Stand-by  per accendere la macchina. La macchina emetterà un segnale acustico. Tutti i tasti si accendono con luce fissa bianca, le spie di allarme si accendono con luce fissa arancione per un istante.



- 6** La macchina inizia il ciclo di riscaldamento. Il tasto On/Stand-by  comincia a lampeggiare con luce bianca.

- 7** La macchina è pronta quando il tasto On/Stand-by  termina di lampeggiare e i tasti di erogazione sono accesi con luce fissa.

i *Premendo uno dei pulsanti di erogazione durante il ciclo di riscaldamento è possibile prenotare la bevanda che verrà erogata al termine del riscaldamento.*

- 8** Al primo avviamento erogare 0,5 litri d'acqua senza capsula, mantenendo la leva abbassata. Posizionare una tazza sotto il beccuccio erogatore.

- 9** Premere il pulsante DOSE LIBERA  e attendere la fine dell'erogazione.

i *Aprire e chiudere la leva prima di rimuovere e svuotare la tazza.*

- 10** Svuotare la tazza ed effettuare una seconda erogazione premendo nuovamente il pulsante DOSE LIBERA .



! Quando viene selezionata un'erogazione la macchina attiva l'elettropompa dell'acqua per 7 secondi.



Se è presente l'acqua all'interno del circuito idraulico la macchina effettua l'erogazione normalmente.

Se non è presente l'acqua all'interno del circuito idraulico, la macchina interrompe l'erogazione per 5 secondi e ritenta l'erogazione per un massimo di 5 volte.

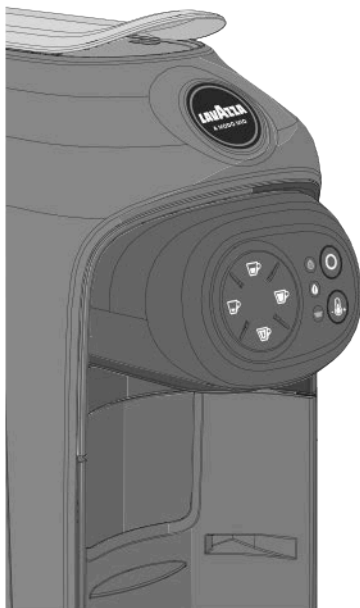
Superati i 5 tentativi la macchina accenderà la spia mancanza acqua **i** con luce fissa arancione per segnalare l'assenza di acqua, ed emetterà un segnale acustico.





ATTIVAZIONE/DISATTIVAZIONE SEGNALE ACUSTICO

- 1** Portare la macchina in modalità stand-by.
- 2** Premere e mantenere premuto contemporaneamente i tasti di erogazione ESPRESSO  e CAFFÈ LUNGO  per almeno 5 secondi.

i La macchina emetterà un lungo segnale acustico per segnalare la disabilitazione del segnale acustico. Due segnali acustici brevi per segnalare l'attivazione.

- 3** Terminata la procedura la macchina ritorna in modalità stand-by.

FUNZIONE STAND-BY

i Per garantire il risparmio energetico, dopo 9 minuti di inutilizzo la macchina passerà automaticamente alla modalità **Stand-by**. È possibile portare la macchina in modalità stand-by manualmente, prima dei 9 minuti, premendo il tasto On/Stand-by , la macchina emetterà un segnale acustico. In modalità stand-by i tasti sono spenti e il tasto On/Stand-by  è acceso con luminosità ridotta. Premendo nuovamente il tasto On/Stand-by  è possibile riattivare la macchina.

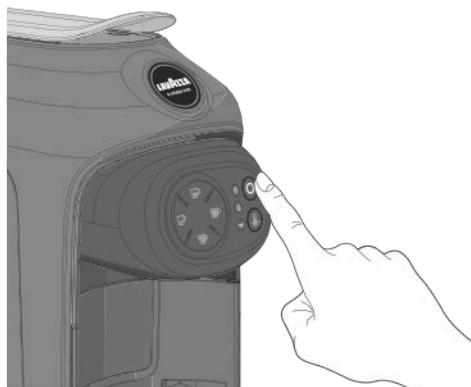

PREDISPOSIZIONE ALLA PREPARAZIONE CAFFÈ

La macchina dispone di due posizioni per la preparazione del caffè: tazzina o tazza grande.

- 1** Per utilizzare una tazzina da caffè espresso: estrarre il piano poggia tazze/tazzine. Inserire il piano poggia tazze nell'apposita fessura in alto.



- 2** Inserire il piano poggia tazze nell'apposita fessura in alto.

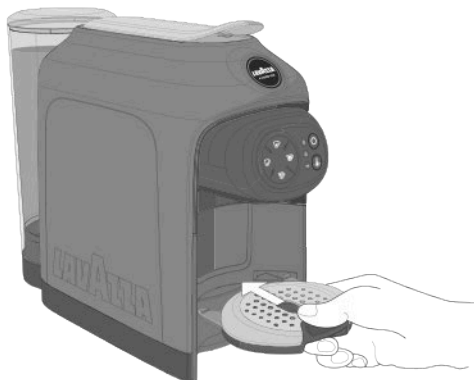

- 3** Appoggiare la tazzina sul piano.



- 4** Per utilizzare la tazza grande, appoggiare la tazza o il bicchiere direttamente sul piano in basso.



EROGAZIONE ESPRESSO / ESPRESSO LUNGO

i Accertarsi che i pulsanti di erogazione caffè siano accesi con luce fissa bianca.

1 Posizionare la tazzina come indicato (vedi **PREDISPOSIZIONE ALLA PREPARAZIONE CAFFÈ**).

2 Sollevare la leva fino al suo blocco per aprire il vano inserimento capsule.

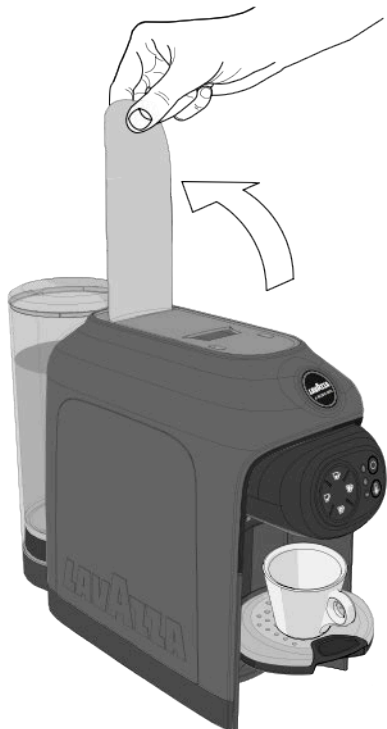

! Non introdurre mai le dita o oggetti nel vano di inserimento capsula. Nel vano inserimento capsula devono essere inserite esclusivamente capsule Lavazza **A MODO MIO** o compatibili.

Le capsule monodoso sono predisposte per erogare un solo caffè/prodotto. **NON** riutilizzare le capsule dopo il loro impiego.

L'inserimento di 2 o più capsule contemporaneamente provoca il malfunzionamento della macchina.

3 Inserire una capsula Lavazza **A MODO MIO** o compatibile nel vano inserimento capsule.



- 4** Abbassare la leva per chiudere il vano inserimento capsule.



- i** Se si desidera un caffè più caldo, è possibile aumentare la temperatura della bevanda premendo il tasto Boost TEMPERATURA . La macchina alla pressione del tasto emette un segnale acustico e aumenta l'intensità d'illuminazione del tasto.



- i** Se si desidera ritornare alla temperatura standard, premere nuovamente il tasto Boost TEMPERATURA . La macchina alla pressione del tasto emette un segnale acustico e diminuisce l'intensità d'illuminazione del tasto.

- !** Non è possibile cambiare la temperatura durante l'erogazione.

- 5** Per iniziare un'erogazione:
premere il tasto ESPRESSO ☕ (30 ml) o
premere il tasto ESPRESSO LUNGO ☕ (45 ml).

La macchina termina l'erogazione una volta raggiunta la dose di caffè programmata.



i Durante l'erogazione il pulsante selezionato è acceso con luce lampeggiante bianca. È possibile interrompere l'erogazione premendo nuovamente il tasto di erogazione.

- !** Se durante il ciclo di erogazione viene interrotta l'alimentazione elettrica procedere come segue:
- Ripristinare l'alimentazione elettrica.
 - Premere il pulsante di On/Stand-by; attendere che sia acceso con luce fissa bianca.
 - Sostituire la capsula all'interno del cassetto porta capsule con una nuova.
 - Ricominciare la procedura di erogazione caffè.

- !** Se durante il ciclo di erogazione si esaurisce l'acqua all'interno del serbatoio procedere come segue:
- Riempire il serbatoio acqua fino a livello MAX indicato.
 - Sostituire la capsula all'interno del cassetto porta capsule con una nuova.
 - Ricominciare la procedura di erogazione caffè.

- !** Erogando senza capsula le dosi possono non rispettare la quantità programmata.

- 6** Al termine dell'erogazione sollevare e abbassare la leva caricamento capsule per scaricare la capsula utilizzata.
- 7** Per una nuova erogazione attendere che i tasti di erogazione e il tasto On/Stand-by siano accesi con luce fissa bianca.

EROGAZIONE CAFFÈ LUNGO

! Eseguire passaggi: **1**, **2**, **3** e **4** del paragrafo EROGAZIONE ESPRESSO.

5 Premere il tasto CAFFÈ LUNGO  (90 ml) per iniziare l'erogazione. La macchina termina automaticamente l'erogazione una volta raggiunta la dose di caffè programmata.



i Durante l'erogazione il pulsante selezionato è acceso con luce lampeggiante bianca. È possibile interrompere l'erogazione premendo nuovamente il tasto di erogazione.

6 Al termine dell'erogazione sollevare e abbassare la leva caricamento capsule per scaricare la capsula utilizzata.

7 Per una nuova erogazione attendere che i tasti di erogazione e il tasto On/Stand-by siano accesi con luce fissa bianca.

EROGAZIONE DOSE LIBERA

! Eseguire passaggi: **1**, **2**, **3** e **4** del paragrafo EROGAZIONE ESPRESSO.

i In caso di capsule solubili, per gustare al meglio il prodotto si consiglia una breve erogazione a vuoto (con sola acqua) prima di inserire la capsula.

5 Premere il tasto DOSE LIBERA  per iniziare l'erogazione. Una volta raggiunta la quantità desiderata di caffè erogato premere nuovamente il tasto per terminare l'erogazione.



i Durante l'erogazione il pulsante selezionato è acceso con luce lampeggiante bianca. È possibile interrompere l'erogazione premendo nuovamente il tasto di erogazione.

6 Al termine dell'erogazione sollevare e abbassare la leva caricamento capsule per scaricare la capsula utilizzata.

7 Per una nuova erogazione attendere che i tasti di erogazione e il tasto On/Stand-by siano accesi con luce fissa bianca.

PULIZIA MACCHINA

! Mai utilizzare solventi, alcool o sostanze aggressive o forni per l'asciugatura dei componenti della macchina. Lavare i componenti (esclusi quelli elettrici) con acqua fredda/tiepida e panni/spugne non abrasive. Tutti i componenti smontabili sono lavabili in lavastoviglie.

Non lasciare l'acqua nel circuito e nel serbatoio per più di 3 giorni; se questo dovesse accadere svuotare, sciacquare e riempire nuovamente il serbatoio con acqua fresca, quindi effettuare un'erogazione (senza capsula) prima di erogare il caffè o una bevanda.

PULIZIA EROGATORE CAFFÈ

Per la pulizia dell'erogatore eseguire settimanalmente la procedura **EROGAZIONE CAFFÈ** senza inserire la capsula.



PULIZIA VASSOIO RACCOGLI GOCCE E CASSETTO RACCOGLI CAPSULE USATE

i L'accensione della spia cassetto raccogli capsule  indica che il cassetto capsule usate è pieno ed occorre svuotarlo e reinserirlo.

1 Estrarre il vassoio raccogli gocce e il cassetto raccogli capsule usate.

i La macchina emette un segnale acustico per segnalare la rimozione del cassetto raccogli capsule.



i Estrahendo il cassetto per più di 5 secondi, la macchina azzerà il conteggio delle capsule inserite.

- 2** Rimuovere il vassoio raccogli gocce e il cassetto raccogli capsule. Svuotare le capsule usate e i liquidi presenti nel vassoio raccogli gocce.

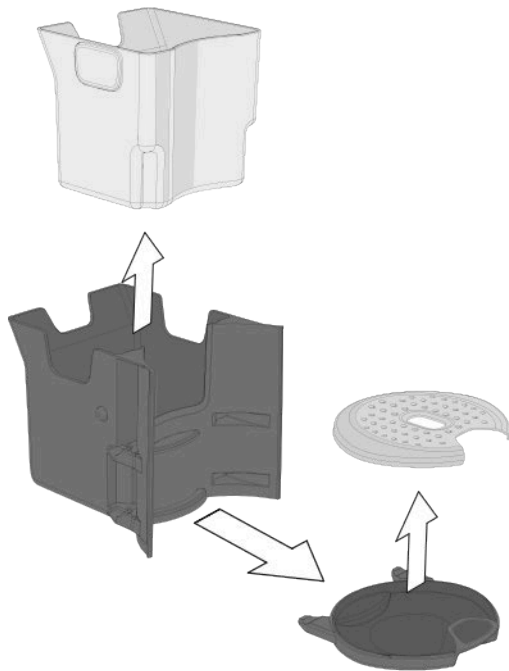

- 3** Lavare tutti i componenti con acqua fredda o tiepida oppure in lavastoviglie. Asciugarli e rimontarli correttamente.

i *Verificare periodicamente che il piano raccogli gocce non sia pieno al fine di evitare fuoriuscite di liquido.*

DECALCIFICAZIONE

- !** Leggere attentamente le istruzioni per la decalcificazione.

La formazione di calcare è una normale conseguenza dell'uso della macchina; la decalcificazione è necessaria ogni 2-3 mesi di utilizzo della macchina e/o quando si osserva una difficoltà di erogazione.

Il ciclo di decalcificazione viene richiesto dalla macchina attraverso l'accensione dell'apposita spia di segnalazione .

- !** Non spegnere la macchina durante il ciclo di decalcificazione. Non andare via durante il ciclo di decalcificazione. Una volta avviato, il ciclo deve essere eseguito fino alla fine.

- !** Verificare che non siano presenti capsule all'interno del vano inserimento capsule.

- 1** Rimuovere e svuotare il serbatoio dell'acqua.

- !** Non bere la soluzione decalcificante e i prodotti erogati fino al completamento del ciclo. Non utilizzare in nessun caso l'aceto come decalcificante.

i *Per eseguire la decalcificazione, si raccomanda di utilizzare il **DECALCIFICANTE LAVAZZA**.*

- 2** Riempire il serbatoio con il contenuto del **DECALCIFICANTE LAVAZZA** (250 ml) e acqua (250 ml). Rimontare il serbatoio sulla macchina.



i Pulire eventuali schizzi o gocce con un panno umido.

- 3** Posizionare sotto l'erogatore un contenitore con capacità superiore a 0,5 litri.

- 4** Collegare la macchina alla rete elettrica senza accenderla.

- 5** Premere e mantenere premuto contemporaneamente i tasti di erogazione **ESPRESSO** ☕ e **ESPRESSO LUNGO** ☕ per almeno 5 secondi.





i L'apparecchio emette un lungo segnale acustico e si accendono con luce fissa i tasti: On/Stand-by ○, DOSE LIBERA ☕ e la spia decalcificazione ☘.

- 6** Premere il tasto **DOSE LIBERA** ☕ per avviare il ciclo di decalcificazione.

! Se il tasto **DOSE LIBERA** ☕ non viene premuto entro 9 minuti dal segnale acustico, la macchina tornerà in modalità stand-by e sarà necessario ripetere il passaggio **6** della procedura, per avviare il ciclo.



7 La macchina comincia la fase di riscaldamento e il tasto DOSE LIBERA  comincia a lampeggiare.

8 La macchina inizierà automaticamente la decalcificazione dopo aver terminato il ciclo di riscaldamento.





i Durante il ciclo di decalcificazione il tasto DOSE LIBERA  è acceso con luce lampeggiante, la spia di decalcificazione  è accesa con luce fissa.



! Durante il ciclo di decalcificazione la macchina effettua automaticamente dei cicli di erogazione intermittenti per consentire lo svuotamento del contenitore.

i È possibile sospendere momentaneamente il ciclo di decalcificazione premendo il tasto DOSE LIBERA  o il tasto On/Stand-by . Per riprendere il ciclo premere il tasto DOSE LIBERA .

9 Quando la macchina avrà esaurito il liquido nel serbatoio, il ciclo viene momentaneamente sospeso. Svuotare il contenitore utilizzato per la raccolta della soluzione.

i Tasto On/Stand-by , DOSE LIBERA  e spia mancanza acqua  accesi con luce fissa. Spia decalcificazione  accesa con luce lampeggiante.

10 Rimuovere il serbatoio acqua, risciacquarlo e lavarlo accuratamente. Riempirlo con acqua fresca potabile non gasata fino al livello MAX.



! In caso di interruzione dell'alimentazione la macchina alla prima accensione richiederà il ciclo di risciacquo.

11 Inserire il serbatoio con l'acqua. Posizionare sotto l'erogatore un contenitore con capienza superiore a 0,5 litri.

12 Premere il tasto DOSE LIBERA  per avviare il ciclo di risciacquo.

i Per terminare il ciclo di risciacquo è necessario che venga erogato un quantitativo minimo di acqua. In caso di mancanza acqua il ciclo viene interrotto momentaneamente, la macchina emette un lungo segnale acustico e si accende con luce fissa la spia mancanza acqua . Rabboccare il serbatoio.

13 Al termine dell'erogazione pulire la macchina con un panno morbido, inumidito. Terminata la pulizia, il processo di decalcificazione è completo. La macchina è pronta all'uso.

Problema riscontrato	Cause possibili	Soluzione
<p>La macchina non si accende. Spia On/Stand-by spenta.</p> 	<ul style="list-style-type: none"> » Macchina non collegata alla rete elettrica. » La macchina è collegata a prese multiple o ad una ciabatta non funzionante. » Alimentazione non presente nella rete elettrica/domestica. 	<ul style="list-style-type: none"> » Collegare la macchina alla rete elettrica. » Collegare la macchina direttamente alla rete elettrica. » Verificare la presenza di corrente collegando un altro dispositivo elettrico all'alimentazione. <p>SE IL PROBLEMA PERSISTE RIVOLGERSI AL SERVIZIO CLIENTI LAVAZZA.</p>
<p>Premendo il tasto On/Stand-by la macchina non si accende.</p> 	<ul style="list-style-type: none"> » Interfaccia touch non reattiva. » Errata pressione contemporanea di 2 tasti. 	<ul style="list-style-type: none"> » Verificare che la superficie dell'interfaccia e la mano dell'utilizzatore siano asciutte e pulite. » Attendere qualche secondo e premere solo il tasto On/Stand-by. <p>SE IL PROBLEMA PERSISTE RIVOLGERSI AL SERVIZIO CLIENTI LAVAZZA.</p>
<p>Percezione tempo di riscaldamento eccessivo (maggiore di 40 secondi).</p>	<ul style="list-style-type: none"> » Stoccaggio macchina in ambiente troppo freddo (es: cantina/garage). 	<ul style="list-style-type: none"> » Mantenere la macchina in ambiente adeguato per almeno 1 ora. Successivamente collegare la macchina alla presa elettrica e tentare l'accensione. <p>SE IL PROBLEMA PERSISTE RIVOLGERSI AL SERVIZIO CLIENTI LAVAZZA.</p>

Problema riscontrato	Cause possibili	Soluzione
Macchina rumorosa.	<ul style="list-style-type: none"> » Piano di appoggio non stabile. » Cavo alimentazione mal posizionato. » Parti mobili non inserite correttamente. » Manca acqua nel serbatoio. » Capsula non presente. 	<ul style="list-style-type: none"> » Verificare il piano di appoggio. » Verificare il corretto posizionamento del cavo nella base della macchina. » Inserire correttamente le parti mobili. » Rabboccare con acqua fresca potabile non gasata. » Inserire una capsula Lavazza A MODO MIO o compatibile. <p>SE IL PROBLEMA PERSISTE RIVOLGERSI AL SERVIZIO CLIENTI LAVAZZA.</p>
La macchina pronta all'uso non recepisce la pressione dei tasti.	<ul style="list-style-type: none"> » Errata pressione/attivazione tasti. » Cassetto raccogli capsule usate non inserito correttamente. 	<ul style="list-style-type: none"> » Premere uno dei tasti illuminati con il polpastrello e verificare la presenza del segnale acustico e il corretto lampeggio dell'icona selezionata. » Verificare il corretto inserimento del cassetto ed il conseguente spegnimento della spia d'allarme, in seguito avviare l'erogazione. <p>SE IL PROBLEMA PERSISTE RIVOLGERSI AL SERVIZIO CLIENTI LAVAZZA.</p>
La leva rimane chiusa dopo l'erogazione.	<ul style="list-style-type: none"> » Cassetto capsule esauste pieno. 	<ul style="list-style-type: none"> » Svuotare il cassetto e provare ad aprire la leva. <p>SE IL PROBLEMA PERSISTE RIVOLGERSI AL SERVIZIO CLIENTI LAVAZZA.</p>

Problema riscontrato	Cause possibili	Soluzione
<p>La macchina non eroga (si accende ma non eroga né caffè né acqua).</p>	<ul style="list-style-type: none"> » Manca acqua nel serbatoio. » Serbatoio non inserito correttamente. » Leva caricamento capsula sollevata o non abbassata correttamente. » Assenza flusso acqua nel circuito idraulico (mancato innesco). » Capsula non idonea. » Presenza calcare. 	<ul style="list-style-type: none"> » Rabboccare con acqua fresca e potabile il serbatoio e verificare la corretta erogazione. » Inserire correttamente il serbatoio e verificare la corretta erogazione. » Abbassare la leva caricamento capsule fino a battuta e verificare la corretta erogazione. » Scollegare il cavo di alimentazione, attendere 10 secondi e ricollegare il cavo. Accendere la macchina ed attendere il termine del riscaldamento. Verificare la corretta erogazione (la macchina effettua in automatico tentativi di riempimento circuito). » Provare con un' altra capsula presa da una scatola differente. » Effettuare la decalcificazione con il decalcificante Lavazza. <p>SE IL PROBLEMA PERSISTE RIVOLGERSI AL SERVIZIO CLIENTI LAVAZZA.</p>
<p>La macchina perde acqua.</p>	<ul style="list-style-type: none"> » Serbatoio danneggiato. » Cassetto porta capsule pieno. » Capsula incastrata. » Utilizzo capsule non idonea. 	<ul style="list-style-type: none"> » Verificare la presenza di perdite nel serbatoio tenendolo separato dalla macchina. » Svuotare cassetto porta capsule. » Aprire e chiudere la leva per far cadere la capsula. Estrarre il cassetto porta-capsule e svuotarlo. » Utilizzare capsule idonee (Lavazza A MODO MIO o compatibili). <p>SE IL PROBLEMA PERSISTE RIVOLGERSI AL SERVIZIO CLIENTI LAVAZZA.</p>

Problema riscontrato	Cause possibili	Soluzione
Tasto on/off lampeggiante di rosso.	» Condizioni stoccaggio macchina non idonea/Blocco Temporaneo.	» Staccare la spina della macchina dalla presa di corrente. Lasciare la macchina a temperatura ambiente per un periodo sufficiente (massimo 1 ora). Collegare nuovamente la macchina alla presa di corrente e premere il pulsante di accensione. (provare una sola volta). SE IL PROBLEMA PERSISTE RIVOLGERSI AL SERVIZIO CLIENTI LAVAZZA.
La leva caricamento non raggiunge la posizione di erogazione o richiede un'eccessiva forza di chiusura.	» Cassetto capsule esauste pieno. » Capsula incastrata.	» Svuotare il cassetto e provare a chiudere la leva. » Aprire e chiudere la leva per far cadere la capsula. SE IL PROBLEMA PERSISTE RIVOLGERSI AL SERVIZIO CLIENTI LAVAZZA.
Il caffè sgorga troppo velocemente, non viene erogato un caffè cremoso.	» Utilizzo di capsula già usata. » Capsula non inserita. » Capsula non idonea.	» Utilizzare una capsula nuova. » Inserire la capsula. » Provare con un'altra capsula presa da una scatola differente. SE IL PROBLEMA PERSISTE RIVOLGERSI AL SERVIZIO CLIENTI LAVAZZA.
Caffè freddo.	» Erogazione lenta con circuito idraulico intasato di calcare.	» Effettuare la decalcificazione con il decalcificante Lavazza. SE IL PROBLEMA PERSISTE RIVOLGERSI AL SERVIZIO CLIENTI LAVAZZA.

Problema riscontrato	Cause possibili	Soluzione
La macchina non emette alcun suono.	» Segnale acustico disattivato.	» Portare la macchina in stand-by e successivamente tenere premuto contemporaneamente i tasti di erogazione Caffè espresso e Caffè Lungo per almeno 5 secondi. (vedi sezione PREDISPOSIZIONE MACCHINA). SE IL PROBLEMA PERSISTE RIVOLGERSI AL SERVIZIO CLIENTI LAVAZZA.
Il caffè sgorga lentamente a gocce.	» Utilizzo capsula non idonea. » Utilizzo di capsula usata. » Erogatore intasato. » Circuito idraulico intasato a causa di calcare.	» Provare con un'altra capsula presa da una scatola differente. » Rimuovere la capsula usata ed utilizzare capsula nuova. » Effettuare pulizia erogatore (vedi sezione MANUTENZIONE E PULIZIA). » Effettuare la decalcificazione con il decalcificante Lavazza. SE IL PROBLEMA PERSISTE RIVOLGERSI AL SERVIZIO CLIENTI LAVAZZA.

Per qualsiasi problematica non riportata nei casi sopra elencati rivolgersi al Servizio Clienti Lavazza

CARATTERISTICHE TECNICHE

- Voltaggio: 220-240V / 50-60Hz
- Potenza totale: 1500W
- Dimensioni: Altezza Larghezza Profondità
280 mm 145 mm 380 mm
- Peso: 4 kg
- Serbatoio acqua estraibile: 1,1 L
- Materiali impiegati per la carrozzeria: Termoplastico
- Lunghezza cavo: 0,8 m

⚠ Intended use:

This appliance is intended to be used in household and similar applications such as:

- staff kitchen areas in shops, offices and other working environments;
- farm houses;
- by clients in hotels, motels and other residential type environments;
- bed and breakfast type environments.

It is prohibited to make any technical changes to the machine.

Do not use the machine for unauthorized purposes since this would create serious hazards.

The machine may not be used by children under 8 years of age or persons with physical, sensory or mental impairment, or lacking the necessary experience, unless supervised or after being instructed in the safe use of the machine and understanding the potential dangers.

Do not let children play with the machine. The necessary cleaning and maintenance must not be carried out by children if not under direct supervision.

⚠ Installation site:

Place the coffee machine in a safe place, where nobody may overturn it or be injured by it. Do not keep the machine at a temperature below 5°C (41°F) as freezing may damage it.

Do not use the coffee machine outdoors. Do not place the machine on very hot surfaces or close to flames.

The machine shall not be placed in a cabinet when in use.

⚠ Power supply:

Connect the coffee machine to a suitable mains socket.

The voltage must match the one on the appliance identification plate.

 **Power supply cable:**

Do not operate the coffee machine if the power cord is damaged. If the power cord is damaged, it must be replaced by the manufacturer (or the latter's technical service staff) or, in any case, by a person duly qualified to do that, in order to prevent any risk. Do not pass the power cable for angles and sharp edges, over very hot objects, and protect it from oil. Do not carry or pull the coffee machine holding it by the power cord. Do not remove the plug by pulling the power cord, do not touch it with wet hands. Power cord should not hang loose from tables or shelves.

 **Danger of electrocution:**

Live parts should never come into touch with water. Do not immerse the machine.

 **Protect children under 8 years of age:**

Prevent children from playing with the machine. Children are not aware of the risks related to electric household appliances. Do not leave the machine packaging materials within the reach of children.

 **Danger of burns:**

Do not touch the hot parts (cartridge holder group) of the machine immediately after use. While dispensing the drink, pay attention to any possible splashes of hot liquid.

 **Cleaning:**

Before cleaning, unplug the machine and let it cool down. Do not immerse the machine in water! It is strictly forbidden to tamper with the internal parts of the machine. Change the water in the tank if not used for 3 days. To prevent damage to the appliance do not use alkaline cleaning agents when cleaning, use a soft cloth and a mild detergent.

 **Storing the machine:**

If the machine remains inactive for a long time, unplug it and store it in a dry place out of reach of children. Keep it protected from dust and dirt.

 **Servicing / Maintenance:**

In case of failure, problems or a suspected fault resulting from falling of the machine, immediately unplug the machine.

Do not attempt to operate a faulty machine. Servicing and repairs can only be performed by Authorized Service Centres. All liability for damages resulting from work not carried out by professionals is declined.

 **Water tank:**

Fill the tank only with fresh, non-sparkling, drinking water. Do not operate the machine if the water is not at least above the minimum level indicated on the tank.

 **Capsule compartment:**

Only Lavazza **A MODO MIO** or compatible capsules must be introduced in the capsule-holder; do not put in your fingers or any other object.

The capsules shall be used only once.

 **Machine disposal at the end of its operational life:**

INFORMATION FOR THE USER: the symbol of the crossed-out wheeled bin on the appliance or its packaging indicates that the product must be disposed of separately from other waste at the end of its operational life.

The user must therefore take the appliance to be disposed of to an appropriate separate collection centre for electrical and electronic equipment.

Appropriate separate waste collection, in view of the decommissioned equipment's recycling, processing and environment-friendly disposal, helps avoiding possible adverse effects both on the environment and the public health and, also, promotes the reuse and/or recycling of the materials the machine is made up of. Specific administrative sanctions provided for by current regulations will be applied for illicit disposal of the product by the user.

PACKAGE CONTENT *

- IDOLA machine
- Welcome kit consisting of 9 assorted Lavazza **A MODO MIO** capsules and a Lavazza **A MODO MIO** leaflet
- Instruction booklet
- Quick guide
- Warranty sheet

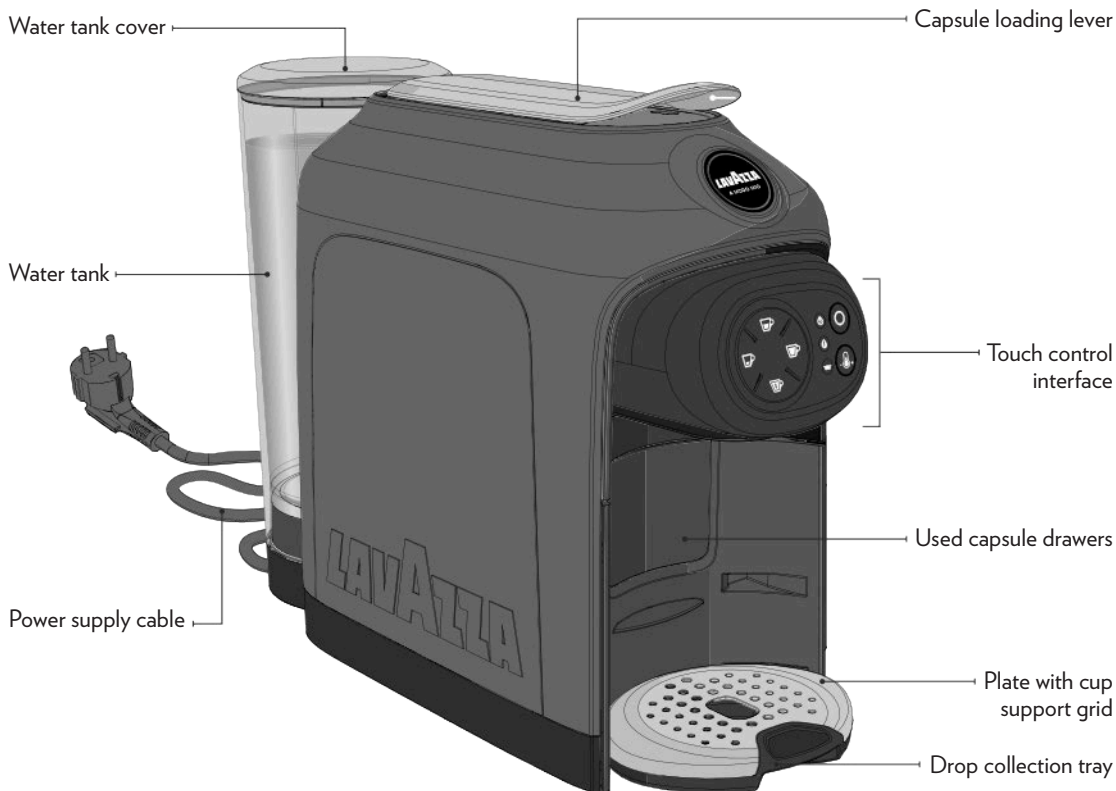

































































































* The characteristics and the package content can vary according to the target market.



TOUCH CONTROL INTERFACE

- | | |
|---|---|
| 1 ESPRESSO supply button | 6 Warning light no water |
| 2 LONG ESPRESSO supply button | 7 Warning light drip tray drawer |
| 3 LONG COFFEE supply button | 8 On / Stand-by button |
| 4 FREE DOSE BEVERAGE supply button | 9 TEMPERATURE boost button |
| 5 Warning light decalcification | |

INTERFACE STATE									
Stand-by									
									
Power on 									
									
Heating									
									
Machine ready (temperature reached)									
									
Delivering espresso (button 1) 									
									
Delivering long espresso (button 2) 									
									
Delivering long coffee (button 3) 									
									
Delivering free dose beverage (button 4) 									
									
No water in the tank 									
									

INDICATOR LIGHTS

EN

INTERFACE STATE							
Used capsule drawer filled 🔊							
Used capsule drawer positioned incorrectly or absent 🔊							
Descaling required							
Machine block 🔊							
							Red

= Off
 = On
 = Flashing
 🔊 = Acoustic feedback

- !** We are not liable for any damages in case of:
- incorrect use and other uses than the intended purposes;
 - repairs performed at unauthorised service centres;
 - tampering with the power cord;
 - tampering with any part of the machine;
 - use of spare parts and accessories which are not original;
 - failure to descale;
 - storage in rooms below 4° C (39,2° F);
 - use below 5° C (41° F);
 - use over 40° C (104° F);
 - use in places with relative humidity above 95%;
 - using non-compatible capsules.
- In any of these cases, the warranty is cancelled.

STARTING THE MACHINE

- !** Place the coffee machine on a flat and stable surface, far from water and heat sources. Machine damages due to non-observance of these indications are not covered by warranty.

- 1** Lift and remove the cover, then the water tank itself.
- 2** Rinse the tank before using it.
- 3** Fill the water tank up to the MAX level indicated, using only fresh drinking water. Fit the tank back into place, then close by using the cover.

i *The cover can be lifted to fill the tank directly.*

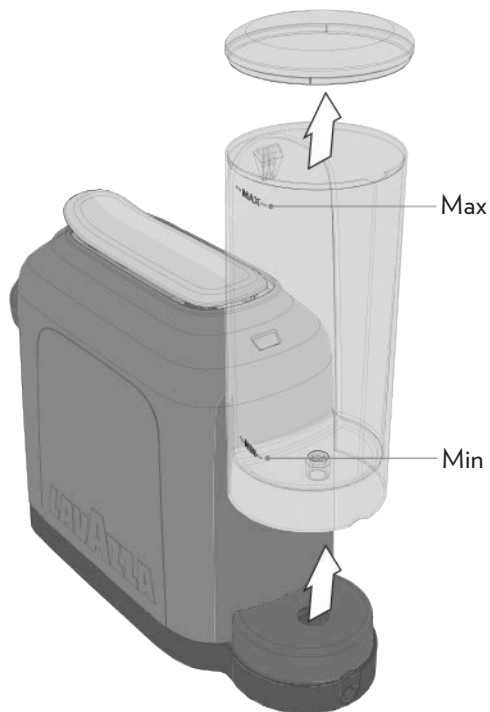

- !** The water level should never exceed the MAX indication. Only use non-carbonated fresh water. Hot water and other liquids can damage the tank and the machine. Do not operate the machine without water: make sure that there is enough water in the tank.

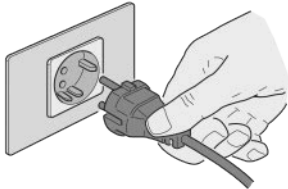

- !** Make sure that the hands, the machine, the cord and the support surface of the machine are not wet.

- 4** Fit the supply plug into the power outlet.



- 5** Press the On/Stand-by button  to switch the machine on. The machine will emit an acoustic signal. All buttons will come on to a steady white light, whereas the alarm warning lamps will come on to a steady orange light over an instant.



- 6** The coffee machine starts the heating cycle. The On/Stand-by button  will start blinking to a light white.
- 7** The machine will be ready when the On/Stand-by button  stops blinking and the supply button lights are steadily.

i *By pressing one of the supply buttons during the heating cycle, you can reserve the beverage that will be supplied at the end of the heating cycle.*

- 8** Upon the first machine start-up, you shall supply 0.5 litres of water, with no capsule inserted and keeping the lever lowered. Place a cup under the supplying spout.
- 9** Press the FREE DOSE  button and wait for the supply to end.

i *Open and close the lever before removing and emptying the cup.*

- 10** Empty the cup and supply one more time, by pressing the FREE DOSE  button again.



! When a supply is selected, the machine will activate the electric water pump over 7 seconds.



If water is found inside the hydraulic circuit, the machine will normally supply.

If no water is found inside the hydraulic circuit, the machine will stop supplying over 5 seconds and will try to supply again up to a maximum of 5 time.

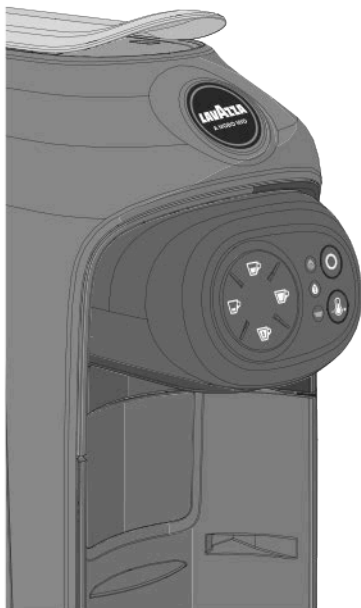
After 5 attempts have been made, the machine will cause the “No water” **i** warning lamp to come on to a steady orange light, to inform that water is missing, and will also emit an acoustic signal.





ACOUSTIC SIGNAL ACTIVATION / DEACTIVATION

- 1** Set the machine to the stand-by mode.
- 2** Simultaneously keep the ESPRESSO  LONG COFFEE  buttons depressed over at least 5 seconds.

i The machine will emit a prolonged acoustic signal to notify the acoustic signal deactivation, and two brief acoustic signals to notify the activation.

- 3** Once the procedure has been completed, the machine will go back to the stand-by mode.

STAND-BY FUNCTION

i To ensure the energy conservation the machine automatically passes to the **Stand-by mode** after 9 minutes of not being used. The machine can be manually set to the stand-by mode, before a 9 minutes' time, by pressing the On/Stand-by  button: the machine will emit an acoustic signal. In the “Stand-by” mode, the buttons will be OFF, and the On/Stand-by button  will come on to a less intense light. The machine can be activated again by pressing the On/Stand-by  button again.



PREPARATION FOR COFFEE BREWING

The coffee machine features two positions for preparing the coffee: espresso cup/mug.

- 1** To use an espresso coffee cup, remove the cup support plate.



- 2** Fit the cup support plate into the slot available at the top.

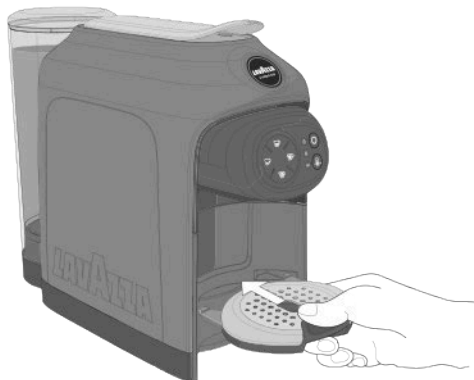

- 3** Place the cup onto the plate.



- 4** To use a big cup, place the cup (or glass) directly onto the plate at the bottom.



ESPRESSO / LONG ESPRESSO DELIVERY

i Make sure that the coffee supply buttons have come on to a steady white light.

1 Place the mug/cup as shown (see PREPARATION FOR COFFEE BREWING).

2 Lift the capsule loading lever until it locks into position to open the capsule fitting compartment.

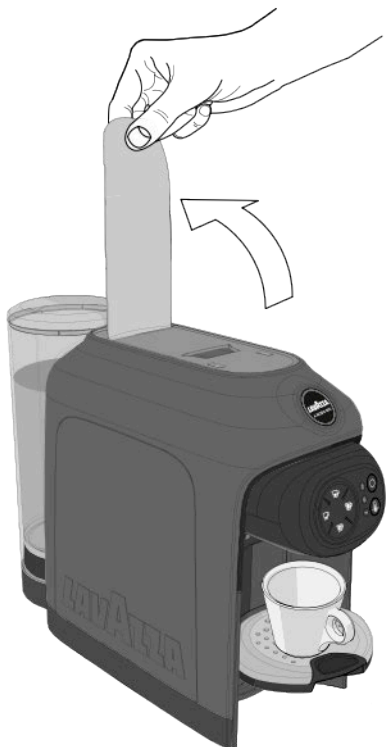

! Never put fingers or objects in the capsule-holder. Only Lavazza **A MODO MIO** or compatible capsules must be introduced in the capsule-holder.

Single-dose capsules are prepared to dispense one coffee/product. **DO NOT** use the capsules more than once. Inserting two or more capsules can cause the machine to malfunction.

3 Put a Lavazza **A MODO MIO** capsule into the capsule fitting compartment.



- 4** Lower the capsule loading lever to close the capsule fitting compartment.



- i** If you wish a hotter coffee, you can increase the beverage temperature by pressing the “TEMPERATURE boost” button .

The machine will, when the button is pressed, emit an acoustic signal and the button light will get brighter.



- i** If you wish to go back to the standard temperature, press the “TEMPERATURE boost” button  again.

The machine will, when the button is pressed, emit an acoustic signal and the button light will get dimmer.

- !** The temperature cannot be changed during the supply phase.

- 5** To start supplying:
press the ESPRESSO ☕ (30 ml) or
press the LONG ESPRESSO ☕ (45 ml).

The machine will stop delivery automatically when the programmed measure is reached.



- i** *The supply button will light up to a blinking white light when the product is being supplied. You can stop supplying by pressing the supply button again.*

- !** If, during the dispensing cycle power supply is interrupted proceed as follows:
- Restore the power supply.
 - Press the On/Stand-by and wait for the button to light up to a steady white light.
 - Replace the capsule inside the capsule fitting compartment with a new one.
 - Restart the coffee dispensing.

- !** If, during the dispensing cycle water is exhausted within the tank proceed as follows:
- Fill the water tank up to the indicated MAX level.
 - Replace the capsule inside the capsule fitting compartment with a new one.
 - Restart the coffee dispensing.

- !** Supplying without a capsule the doses may not respect the programmed quantity.

- 6** Once supply is over, lift and then lower the capsule loading lever to unload the exhausted capsule.

- 7** To supply again, wait until both the supply button and the On/Stand-by button come on to a steady white light.

LONG COFFEE DELIVERY

! Do steps: **1**, **2**, **3** and **4** in paragraph ESPRESSO DELIVERY.

5 Press the LONG COFFEE  (90 ml) button to start delivery. The machine will stop delivery automatically when the programmed measure is reached.



i The supply button will light up to a blinking white light when the product is being supplied. You can stop supplying by pressing the supply button again.

6 Once supply is over, lift and then lower the capsule loading lever to unload the exhausted capsule.

7 To supply again, wait until both the supply button and the On/Stand-by button come on to a steady white light.

FREE DOSE BEVERAGE DELIVERY

! Do steps: **1**, **2**, **3** and **4** in paragraph ESPRESSO DELIVERY.

i In case of soluble capsules, it is recommended that a brief plain (i.e. by using only water) supply should be dispensed before inserting the capsule, so that you can best enjoy the product.

5 Press the FREE DOSE BEVERAGE  button to start delivery. Once the desired amount of brewed coffee is reached, press the button again to stop brewing.



i The supply button will light up to a blinking white light when the product is being supplied. You can stop supplying by pressing the supply button again.

6 Once supply is over, lift and then lower the capsule loading lever to unload the exhausted capsule.

7 To supply again, wait until both the supply button and the On/Stand-by button come on to a steady white light.

CLEANING THE MACHINE

! Never use solvents, alcohol or other aggressive substances or ovens for drying the coffee machine components.

Wash machine components (electric components excluded) with cold/lukewarm water and non-abrasive clothes/sponges. All removable components can be cleaned by using a dishwasher.

Do not leave water in the tank and water circuit for more than 3 days.

If this is the case, drain the tank and circuit, rinse it and refill it with fresh water, then carry out a delivery without capsule before making any coffee or other beverage.

COFFEE DISPENSER CLEANING

To clean the dispenser, perform a weekly **COFFEE BREWING** procedure without inserting the capsule.



CLEANING THE DROP COLLECTION TRAY AND THE USED CAPSULE COLLECTION TRAY

i The capsule collection tray warning lamp  will come on when the used capsule tray is full and, therefore, has to be emptied and fitted back into place again.

1 Remove the drop collection tray and the used capsule collection tray.

i The machine will emit an acoustic signal to inform that the capsule collection tray has been removed.



i If the drawer is removed for more than 5 seconds, the machine will zero the capsules inserted count.

- 2** Remove the drop collection tray and the capsule collection tray, then empty the used capsules and the fluids found in the drop collection tray.

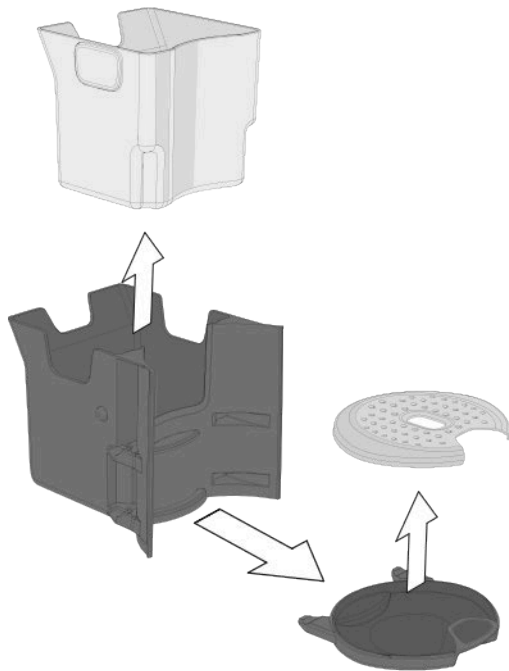

- 3** Wash all the components with cold or warm water, or in a dishwasher, then dry them up and fit them back into place correctly.

i Regularly check that the drop collection tray is not full, so as to prevent fluid leakage.

DESCALING

! Carefully read the descaling instructions.

Lime-scale normally builds up with extended use of the appliance; the machine needs descaling every 2 months and/or whenever a reduction in water flow is noticed. The descaling cycle will be requested by the machine through the switching-on of the special warning lamp available .

! Do not switch the machine off when the descaling cycle is under way. Do not move away from the machine when the descaling cycle is under way. The cycle will have, once it has been started, to be performed completely.

! Check there is no capsule inside the capsule containing compartment.

1 Remove and empty the water tank.

! Do not drink the descaling solution and products dispensed until the completion of the cycle. Never use vinegar as a descaling solution.

i To decalcify the machine, it is recommended that the **LAVAZZA DESCALING** agent should be used.

- 2** Fill the tank with the **LAVAZZA DESCALING** agent (250 ml) and water (250 ml). Fit the tank back into place on the machine.



i Use a moist cloth to wipe off the squirts or drops, if any.

- 3** Place a container with a capacity of at least 0.5 litres under the supplying device.

- 4** Connect the machine to the electric mains - do not switch it on.

- 5** Simultaneously keep the **ESPRESSO** ☕ and **LONG ESPRESSO** ☕ buttons depressed over at least 5 seconds.





i The machine will emit a prolonged acoustic signal, then the: **On/Stand-by** ⏻ and **FREE DOSE** ☕ buttons and the descaling warning lamp will all come on to a steady light 🟡.

- 6** Press the **FREE DOSE** ☕ button to start the descaling cycle.

! If the **FREE DOSE** ☕ button is not pressed within 9 minutes after the acoustic signal has been emitted, the machine will go back to the "Stand-by" mode and the step in the procedure shall be repeated, to start the cycle.



7 The machine will activate the heating phase and the FREE DOSE button  will start blinking.

8 The machine will automatically activate the descaling process, after the heating cycle is over.

i During the descaling cycle, the FREE DOSE button  will be ON and blinking and the descaling warning lamp  will be ON to a steady light.



! During the descaling cycle, the machine will automatically perform intermittent supply cycles, to allow the container to be emptied.

i The descaling cycle can be temporarily interrupted by pressing either the FREE DOSE button  On/Stand-by button . To start the cycle again, press the FREE DOSE button .

9

9 The cycle will be temporarily interrupted when the fluid runs out in the machine tank. Empty the container used to collect the solution.

i On/Stand-by , FREE DOSE button  and “No water” warning lamp  will be ON to a steady light. Descaling warning lamp  will be ON and blinking.

10 Remove the water tank, rinse and wash it accurately. Fill it with drinking fresh non-carbonated water up to the MAX. level.



! In case of power supply interruption, the machine will, upon the first power-on, request the rinsing cycle.

11 Fit the tank with water. Place a container with a capacity of at least 0.5 litres under the supply device.

12 Press the FREE DOSE button  to start the rinsing cycle.

i To end the rinsing cycle, a minimum amount of water will have to be supplied. In case of lack of water, the cycle will be temporarily interrupted, the machine will emit a prolonged acoustic signal and the “No water” warning lamp  will come on to a steady light. Top the tank up.

13 Then the supply has been completed, clean the machine by means of a moist, soft cloth. After cleaning the machine, the descaling process will be over. The machine will be ready for use.

Problem encountered	Possible causes	Solution
<p>Machine does not turn on. On/Stand-by warning lamp OFF.</p> 	<ul style="list-style-type: none"> » Machine is not connected to the power source. » The machine is connect to power strip not working. » Power supply not available in the electric/household mains. 	<ul style="list-style-type: none"> » Connected the machine to the power source. » Connected the machine directly to the power source. » Connect another device to check the power supply. <p>IF THE PROBLEM REMAIN PLEASE CONTACT LAVAZZA CUSTOMER SERVICE.</p>
<p>The machine will not switch on after the “On/Stand-by” button is pressed.</p> 	<ul style="list-style-type: none"> » Touch interface fails to respond. » Wrong simultaneous pressure of 2 buttons. 	<ul style="list-style-type: none"> » Verify that the interface surface and the user's hands are clean and dry. » Wait a few seconds, then press the “On/Stand-by” button only. <p>IF THE PROBLEM REMAIN PLEASE CONTACT LAVAZZA CUSTOMER SERVICE.</p>
<p>Excessive heating time perceived (i.e. more than 40 seconds).</p>	<ul style="list-style-type: none"> » Machine storage at low temperatures (e.g.: cellar/garage). 	<ul style="list-style-type: none"> » Keep the machine in a suitable place over at least 1 hour. Then, plug the machine into the mains socket and try to switch it on. <p>IF THE PROBLEM REMAIN PLEASE CONTACT LAVAZZA CUSTOMER SERVICE.</p>

Problem encountered	Possible causes	Solution
The machine is very noisy.	<ul style="list-style-type: none"> » Machine not is on a flat and stable surface. » Power supply cable incorrectly positioned. » Movable parts not fitted properly. » No water in the tank. » Capsule not present 	<ul style="list-style-type: none"> » Check the surface. » Check the correct position of the cable into the base of the machine. » Fit the movable parts properly. » Top up the tank with fresh drinking water. » Insert Lavazza A MODO MIO capsule or compatible. <p>IF THE PROBLEM REMAIN PLEASE CONTACT LAVAZZA CUSTOMER SERVICE.</p>
Unit ready for use and failing to acknowledge the button press.	<ul style="list-style-type: none"> » Wrong button press/activation. » Used capsule collection tray not fitted. 	<ul style="list-style-type: none"> » Press one of the illuminated buttons with your fingertip, then check the availability of the acoustic signal (if activated) and the proper blinking of the selected icon. » Check the correct insertion of the tray, with the resulting alarm warning lamp switch-off. Check for correct supplying. <p>IF THE PROBLEM REMAIN PLEASE CONTACT LAVAZZA CUSTOMER SERVICE.</p>
The lever remains closed after the supply.	<ul style="list-style-type: none"> » Used capsule tray full. 	<ul style="list-style-type: none"> » Empty the tray and try to open the lever. <p>IF THE PROBLEM REMAIN PLEASE CONTACT LAVAZZA CUSTOMER SERVICE.</p>

Problem encountered	Possible causes	Solution
<p>No supply (the machine is switched on, yet it supplies no coffee or water).</p>	<ul style="list-style-type: none"> » No water in the tank. » Tank not inserted correctly. » Capsule loading lever lifted or not lowered correctly. » No water flow in the hydraulic circuit (no activation). » Capsule not compatible. » Presence of lime-scale. 	<ul style="list-style-type: none"> » Top the tank up with drinking fresh water, then check for correct supplying. » Correctly fit the tank in, then check for correct supplying. » Lower the capsule loading lever up to the stop, then check for correct supplying. » Disconnect the power cord, wait 10 seconds, then connect the power cord again. Switch the machine on and wait for the heating cycle to be over. Check for correct supplying (the machine will automatically make attempts at filling the hydraulic circuit). » Try again by using another capsule from a different package. » Perform the descaling procedure by means of the Lavazza descaling agent. <p>IF THE PROBLEM REMAIN PLEASE CONTACT LAVAZZA CUSTOMER SERVICE.</p>
<p>Water leaks in the coffee machine.</p>	<ul style="list-style-type: none"> » Tank damaged. » Spent capsule drawer filled. » Capsule stuck. » Capsule not compatible. 	<ul style="list-style-type: none"> » Check for leaks in the tank keeping it separate from the machine. » Empty the spent capsule drawer. » Open and close the lever to drop the capsule. Remove and empty the capsule collection tray. » Use suitable capsules (i.e. Lavazza A MODO MIO capsules or any compatible capsule). <p>IF THE PROBLEM REMAIN PLEASE CONTACT LAVAZZA CUSTOMER SERVICE.</p>

Problem encountered	Possible causes	Solution
ON/OFF button blinking red.	» Inadequate machine storing conditions / Temporary lock.	<p>» Unplug the machine from the power socket and allow it to rest at room temperature enough time (Max. 1 hour). Plug the machine in again, then press the switch-on button (make one attempt only).</p> <p>IF THE PROBLEM REMAIN PLEASE CONTACT LAVAZZA CUSTOMER SERVICE.</p>
The loading lever does not reach the supply position or requires an excessive closing effort.	<p>» Spent capsule drawer filled.</p> <p>» Capsule stuck.</p>	<p>» Empty the tray and make an attempt at closing the lever.</p> <p>» Open and close the lever to drop the capsule.</p> <p>IF THE PROBLEM REMAIN PLEASE CONTACT LAVAZZA CUSTOMER SERVICE.</p>
Coffee is dispensed too fast and, therefore, it is not so creamy.	<p>» A previously used capsule is used.</p> <p>» Capsule not present.</p> <p>» Capsule not compatible.</p>	<p>» Use a new capsule.</p> <p>» Insert the capsule.</p> <p>» Try again by using another capsule from a different package.</p> <p>IF THE PROBLEM REMAIN PLEASE CONTACT LAVAZZA CUSTOMER SERVICE.</p>
The coffee is cold.	» Slow supplying, hydraulic circuit clogged with lime-scale.	<p>» Perform the descaling procedure by means of the Lavazza descaling agent.</p> <p>IF THE PROBLEM REMAIN PLEASE CONTACT LAVAZZA CUSTOMER SERVICE.</p>

Problem encountered	Possible causes	Solution
The machine emits no sound	» Acoustic signal OFF.	» Set the machine to the stand-by mode, then simultaneously keep the “Espresso coffee” and “Weak coffee” buttons depressed over at least 5 seconds (refer to the “GETTING THE MACHINE READY” section). IF THE PROBLEM REMAIN PLEASE CONTACT LAVAZZA CUSTOMER SERVICE.
Coffee flows out slowly drop by drop.	» Capsule not compatible. » An inadequate pod has been used. » Supplying device clogged. » Hydraulic circuit clogged with lime-scale.	» Try again by using another capsule from a different package. » Remove the used capsule and use a new capsule. » Clean the coffee dispensing spout (see MAINTENANCE AND CLEANING). » Perform the descaling procedure by means of the Lavazza descaling agent. IF THE PROBLEM REMAIN PLEASE CONTACT LAVAZZA CUSTOMER SERVICE.

Contact Lavazza Customer Service for any problem or failure not included in the above list.

TECHNICAL SPECIFICATIONS

- Power supply: 220-240V / 50-60Hz
- Nominal power: 1500W
- Sizes:

Height	Width	Depth
280 mm	145 mm	380 mm
11.02 in	5.70 in	14.96 in

- Weight: 4 kg (8,81 lb)
- Water tank removable type: 1,1 L (38,71 oz)
- Housing materials: Thermoplastic
- Cable Length: 0,8 m (31.49 in)

⚠ Destination d'usage:

Cet appareil est destiné à être utilisé dans les applications ménagères et similaires, telles que:

- dans les zones servant de cuisine, réservées au personnel, dans les magasins, dans les bureaux et dans d'autres milieux professionnels;
- dans les usines;
- utilisation par les clients des hôtels, motels, et autres endroits à caractère résidentiel;
- dans les pièces de type bed and breakfast.

Il est interdit d'apporter des modifications techniques.

Tout emploi illicite est interdit, à cause des risques que ceux-ci comportent! L'appareil peut être utilisé par des enfants à partir de 8 ans ou par des personnes avec des capacités physiques, sensorielles ou mentales réduites ou encore par des personnes inexpérimentées ou ne possédant pas les connaissances nécessaires, à condition qu'elles soient surveillées ou qu'elles aient reçu des consignes relatives à l'utilisation de l'appareil en toute sécurité et aux risques qu'il comporte.

Les enfants ne doivent pas jouer avec l'appareil. Les opérations de nettoyage et de maintenance de l'appareil du ressort de l'utilisateur ne doivent pas être exécutées par des enfants sans surveillance.

⚠ Emplacement:

Placer la machine dans un endroit sûr, où elle ne risque pas de se renverser ou de blesser quelqu'un. Ne pas conserver la machine à une température inférieure à 5°C car le gel pourrait l'endommager. Ne pas utiliser la machine en plein air.

Ne pas poser la machine sur des surfaces très chaudes et/ou à proximité de flammes libres.

La machine lors de l'utilisation, ne doit pas être placée dans un cabinet.

⚠ Alimentation:

Raccorder la machine uniquement à une prise de courant adéquate.

La tension doit correspondre à celle indiquée sur la plaquette de la machine.

 **Câble d'alimentation:**

Ne pas utiliser la machine si le câble d'alimentation est défectueux. Si le câble d'alimentation est endommagé, il doit être remplacé par le fabricant ou par son service d'assistance technique, afin d'éviter tout risque. Ne pas faire passer le câble d'alimentation par les coins, sur des angles vifs ou au-dessus d'objets très chauds. Ne pas porter ou tirer la machine en la tenant par le câble. Ne pas extraire la fiche en la tirant par le câble; ne pas la toucher avec les mains mouillées. Éviter que le câble d'alimentation ne pende de tables ou d'étagères.

 **Danger d'électrocution:**

Les parties soumises à tension électrique ne doivent pas entrer en contact avec de l'eau. Ne pas plonger l'appareil dans l'eau.

 **Protection des enfants en-dessous de 8 ans:**

Les enfants doivent être surveillés pour faire en sorte qu'ils ne jouent pas avec l'appareil. Les enfants ne se rendent pas compte du danger lié aux appareils électroménagers. Ne pas laisser à leur portée les matériels utilisés pour emballer la machine.

 **Danger de brûlures:**

Ne pas toucher les parties chaudes (groupe porte-capsules, etc.) immédiatement après l'utilisation de l'appareil. Pendant la distribution de la boisson, prêter attention à d'éventuels jets de liquide chaud.

 **Nettoyage:**

Avant de nettoyer la machine, il est indispensable de débrancher la fiche de la prise de courant et attendre que la machine refroidisse. Ne pas immerger la machine dans l'eau! Il est strictement interdit de tenter d'ouvrir la machine. Remplacer l'eau dans le réservoir au bout de 3 jours d'inutilisation. Pour éviter d'endommager l'appareil lors du nettoyage, ne pas utiliser de détergents alcalins mais un chiffon souple imbibé d'un détergent délicat.

 **Conservation de la machine:**

Quand la machine reste inutilisée pendant une longue période, détacher la fiche de la prise et la conserver en lieu sec et non accessible aux enfants. La protéger contre la poussière et la saleté.

 **Réparations / Entretien:**

En cas de pannes, défauts avérés ou suspectés après une chute, débrancher immédiatement la fiche de la prise. Ne pas allumer une machine défectueuse. Seuls les Centres de Service Agréés peuvent effectuer des interventions et des réparations. Dans le cas d'interventions non exécutées selon les règles de l'art, nous déclinons toute responsabilité pour d'éventuels dommages.

 **Réservoir d'eau:**

Introduire dans le réservoir uniquement de l'eau fraîche potable non gazeuse. Ne pas mettre en service la machine s'il n'y a pas suffisamment d'eau dans le réservoir.

 **Compartiment capsules:**

Vous devez exclusivement insérer dans le réceptacle d'insertion de la capsule des capsules Lavazza **A MODO MIO** ou compatibles; ne pas y introduire les doigts ou un objet quelconque. Les capsules ne doivent être utilisées qu'une seule fois.

 **Élimination de la machine en fin de vie:**

INFORMATIONS AUX UTILISATEURS: le symbole de la poubelle barrée sur l'appareil ou sur son emballage indique qu'à la fin de son cycle de vie, ce produit doit être traité séparément des autres déchets. Lors de la fin de vie de l'appareil, l'utilisateur devra par conséquent le remettre à un centre de collecte spécialisé en déchets électriques et électroniques. Le tri sélectif des composants de la machine qui seront destinés au recyclage, au traitement ou à l'élimination écologiquement compatible contribue à éviter des effets négatifs sur l'environnement et la santé et favorise la réutilisation et/ou le recyclage des matériaux. L'élimination abusive du produit de la part de son utilisateur implique l'application des sanctions administratives prévues par la réglementation en vigueur.

CONTENU DE L'EMBALLAGE *

- Machine IDOLA
- Kit de bienvenue composé de 9 capsules assorties **A MODO MIO** et brochure Lavazza **A MODO MIO**

- Mode d'emploi
- Guide rapide
- Garantie

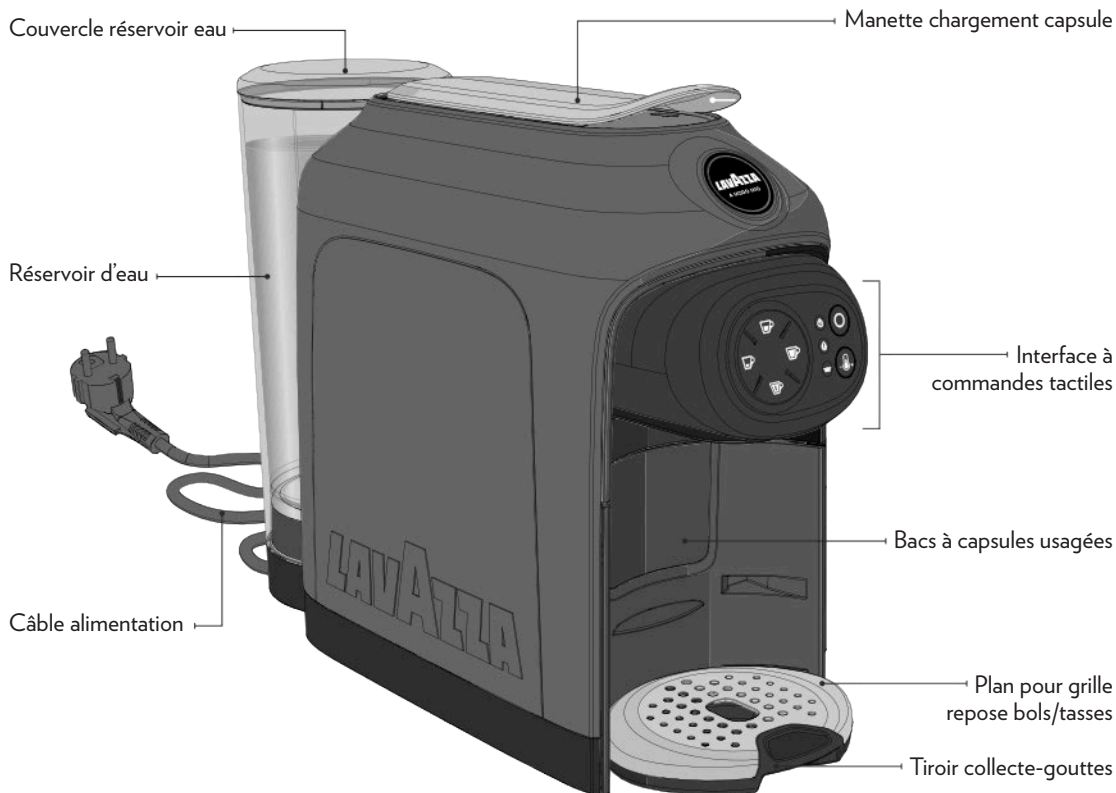

* Les caractéristiques et le contenu de l'emballage peuvent varier en fonction du marché de référence



INTERFACE À COMMANDES TACTILES

- | | |
|--|--|
| 1 Touche de préparation EXPRESSO | 6 Voyant manque d'eau |
| 2 Touche de préparation EXPRESSO LONG | 7 Voyant bac de collecte des capsules |
| 3 Touche de préparation CAFÉ LONG | 8 Touche On / Stand-by |
| 4 Touche de préparation DOSE LIBRE | 9 Bouton Boost TEMPÉRATURE |
| 5 Voyant décalcification | |

ÉTAT INTERFACE									
Stand-by									
Allumage									
Réchauffement									
Machine prête (en température)									
Préparation expresso (touche 1)									
Préparation expresso long (touche 2)									
Préparation café long (touche 3)									
Préparation dose libre (touche 4)									
Manque d'eau dans le réservoir									

ÉTAT INTERFACE							
Bac à capsules usagées plein 🔊							
Bac à capsules usagées mal positionné ou absent 🔊							
Décalcification requise							
Blocage machine 🔊							
							Rouge

= Éteint
 = Allumé
 = Clignotant
 🔊 = Retour sonores

! Nous déclinons toute responsabilité pour d'éventuels dommages en cas de:

- utilisation non conforme;
- réparations exécutées auprès des centres de Service Agréés;
- altération du câble d'alimentation;
- altération de tout composant de la machine;
- emploi de pièces de rechange et accessoires non originaux;
- non détartrage;
- stockage dans des locaux au-dessous de 4 °C;
- utilisation en dessous de 5 °C;
- utilisation au dessus de 40 °C;
- utilisation dans des locaux avec humidité relative supérieure à 95%;
- utilisation de capsules non compatibles.

Tous ces cas rendent la garantie caduque.

DÉMARRAGE MACHINE

! Placer la machine sur une surface plate et stable, loin d'eau et de sources de chaleur. Les dommages causés à la machine à cause du non respect de ces indications ne sont pas couverts par la garantie.

- 1** Soulever et enlever le couvercle, puis extraire le réservoir de l'eau.
- 2** Rincer le réservoir avant de l'utiliser.
- 3** Remplir le réservoir d'eau jusqu'au niveau MAX indiqué, en utilisant uniquement de l'eau fraîche potable non gazeuse. Remonter le réservoir et mettre le couvercle.

i Vous pouvez soulever le couvercle et remplir directement le réservoir.

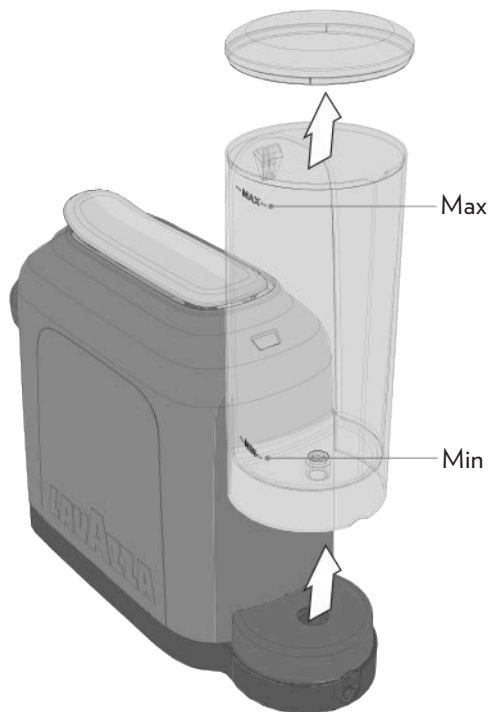

! Le niveau d'eau ne doit jamais dépasser le niveau MAX. Utiliser exclusivement de l'eau fraîche potable non gazeuse. De l'eau chaude ou d'autres liquides peuvent endommager le réservoir et la machine. Ne pas mettre en service la machine en l'absence d'eau: vérifier qu'il y en ait assez d'eau à l'intérieur du réservoir.

! Vérifiez que vos mains, la machine, le câble et la surface d'appui de la machine ne soient pas mouillés.

- 4 Insérer la fiche d'alimentation dans la prise de courant.

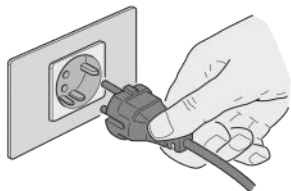

- 5 Enfoncer le bouton On/Stand-by  pour allumer la machine. La machine émettra un signal sonore. Tous les boutons s'allument fixe en blanc, les voyants d'alarme s'allument fixe en orange pendant un instant.



- 6 La machine commence le cycle de chauffage. Le bouton On/Stand-by  commence à clignoter en blanc.

- 7 La machine est prête quand le bouton On/Stand-by  cesse de clignoter et les boutons de distribution sont allumés fixe.

-  *En enfonceant l'un des boutons de distribution pendant le cycle de chauffage, il est possible de réserver la boisson qui sera distribuée au terme du chauffage.*

- 8 Au premier démarrage, faire sortir 0,5 litres d'eau sans insérer une capsule, garder le levier abaissé. Mettre une tasse sous le distributeur.

- 9 Enfoncer le bouton DOSE LIBRE  et attendre la fin de la distribution.

-  *Ouvrir et fermer le levier avant de retirer et de vider la tasse.*

- 10 Vider la tasse et effectuer une deuxième distribution en appuyant de nouveau sur le bouton DOSE LIBRE .



! Quand on sélectionne une distribution, la machine active l'électropompe de l'eau pendant 7 secondes.



S'il y a de l'eau dans le circuit hydraulique, la machine effectue normalement la distribution.

S'il n'y a pas d'eau dans le circuit hydraulique, la machine interrompt la distribution pendant 5 secondes puis elle fait 5 tentatives de distribution.

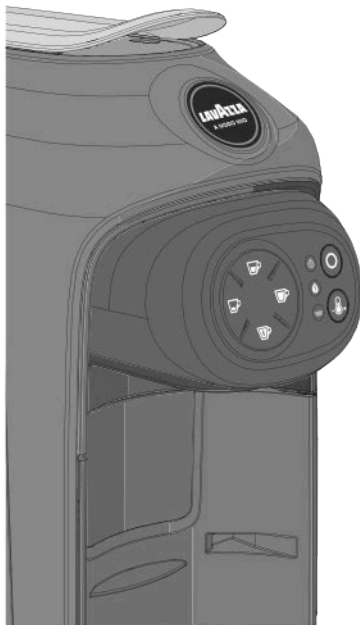
Au terme des 5 tentatives, le voyant de manque d'eau **!** s'allumera fixe en orange pour signaler cet état et la machine émettra un signal sonore.





ACTIVATION/DÉSACTIVATION SIGNAL SONORE

- 1** Mettre la machine en mode stand-by.
- 2** Maintenir simultanément enfoncé les boutons de distribution EXPRESSO  et CAFÉ LONG  pendant 5 secondes au moins.

i La machine émettra un long signal sonore pour indiquer la désactivation du signal sonore. Elle émettra deux signaux sonores brefs pour indiquer l'activation du signal sonore.

- 3** Au terme de la procédure, la machine revient en mode stand-by.

FONCTION STAND-BY

i Pour garantir une économie d'énergie, après 9 minutes de non utilisation la machine passera automatiquement en mode **Stand-by**. Il est possible de mettre manuellement la machine en mode stand-by, avant 9 minutes ; pour ce faire, enfoncer le bouton On/Stand-by . La machine émettra un signal sonore. En mode On/Stand-by, les boutons sont éteints sauf le bouton On/Stand-by  qui est allumé avec une luminosité réduite. Pour rallumer la machine, il suffit d'enfoncer de nouveau le bouton On/Stand-by .

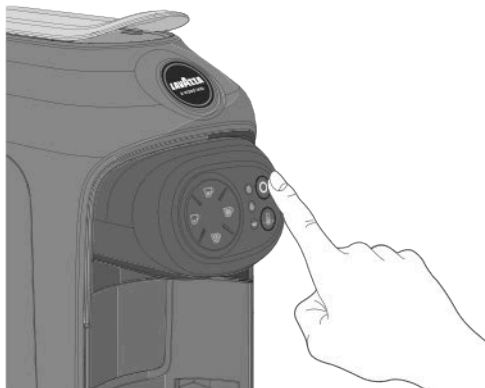

DISPOSITION POUR LA PRÉPARATION DU CAFÉ

La machine dispose de deux positions pour la préparation du café: petite tasse/grande tasse.

- 1** Pour utiliser une tasse de café expresso, extraire le plan repose bols/tasses.

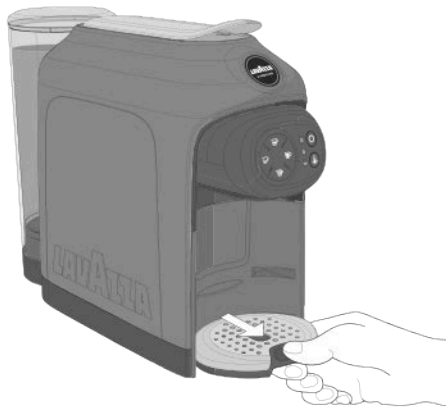

- 2** Introduire le plan repose bols/tasses dans la fissure appropriée en haut.

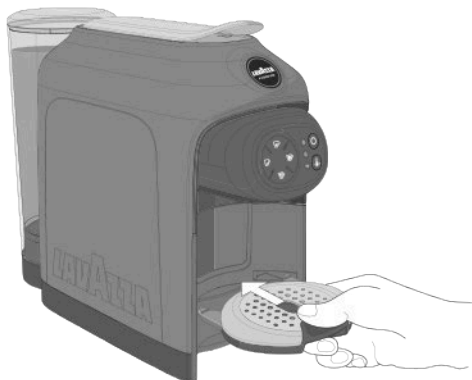

- 3** Poser la tasse sur le plan.



- 4** Pour utiliser une grande tasse, poser la tasse ou le verre directement sur le plan du bas.



PRÉPARATION DU EXPRESSO / EXPRESSO LONG

i S'assurer que les boutons de distribution du café sont allumés fixe en blanc.

- 1** Placer la grande ou petite tasse comme indiqué (voir DISPOSITION POUR LA PRÉPARATION DU CAFÉ).
- 2** Soulever le levier de chargement des capsules jusqu'en butée pour ouvrir le logement à capsules.



! Ne jamais mettre les doigts ou tout autre objet dans le réceptacle d'insertion de la capsule. Vous devez exclusivement insérer dans le réceptacle d'insertion de la capsule des capsules Lavazza **A MODO MIO** ou compatibles. Les capsules mono-dose sont préparées pour distribuer un seul café/produit. **NE PAS** réutiliser les capsules après leur emploi. L'introduction de 2 capsules ou plus simultanément provoque le mauvais fonctionnement de la machine.

- 3** Insérer une capsule Lavazza **A MODO MIO** dans le logement à capsules.



- 4** Baisser le levier de chargement des capsules pour fermer le logement à capsules.



- i** Pour obtenir un café plus chaud, augmenter la température de la boisson en enfonçant le bouton Boost TEMPÉRATURE ☹️, la machine émettra un signal sonore et l'intensité d'éclairage du bouton augmentera.



- i** Pour revenir à la température standard, enfoncer de nouveau le bouton Boost TEMPÉRATURE ☹️, la machine émettra un signal sonore et l'intensité d'éclairage du bouton diminuera.

- !** Il n'est pas possible de modifier la température pendant la distribution.

- 5** Pour commencer une distribution:
appuyer sur la touche EXPRESSO ☕ (30 ml) ou
appuyer sur la touche EXPRESSO LONG ☕ (45 ml).

La machine s'arrêtera automatiquement une fois que la dose de café programmée aura été atteinte.



- i** Pendant la distribution, le bouton sélectionné de distribution clignote en blanc. Il est possible d'interrompre la distribution en enfonçant de nouveau le bouton de distribution.

- !** Si pendant le cycle de distribution, l'alimentation électrique est interrompue procéder comme suit:

- Rétablir l'alimentation électrique.
- Enfoncer le bouton On/Stand-by; attendre qu'il soit allumé fixe en blanc.
- Retirer la capsule usagée et insérer une capsule neuve dans le logement à capsules.
- Recommencer la procédure de distribution de café.

- !** Si pendant le cycle de distribution, l'eau à l'intérieur du réservoir est terminée, procéder comme suit:

- Remplir le réservoir d'eau jusqu'au niveau MAX indiqué.
- Retirer la capsule usagée et insérer une capsule neuve dans le logement à capsules.
- Recommencer la procédure de distribution de café.

- !** Quand la distribution se fait sans capsule, les doses peuvent ne pas respecter la quantité programmée.

- 6** Au terme de la distribution, soulever et baisser le levier de chargement des capsules pour évacuer la capsule usée.

- 7** Pour une nouvelle distribution, attendre que les boutons de distribution et le bouton On/Stand-by soient allumés fixe en blanc.

PRÉPARATION CAFÉ LONG

⚠ Exécuter les opérations: 1, 2, 3 et 4 du paragraphe PRÉPARATION DU EXPRESSO.

- 5 Appuyer sur la touche CAFÉ LONG ☕ (90 ml) pour lancer la préparation. La machine s'arrêtera automatiquement une fois que la dose de café programmée aura été atteinte.

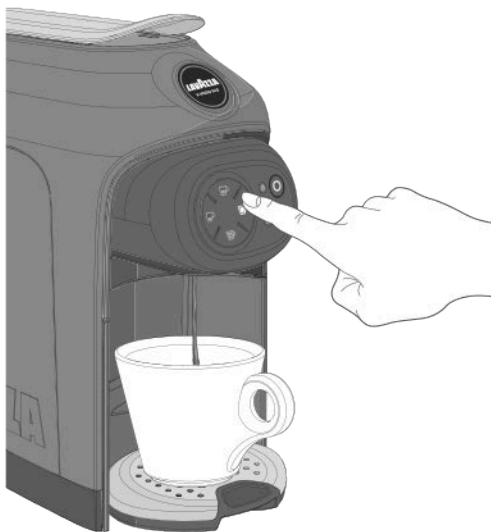

i Pendant la distribution, le bouton sélectionné de distribution clignote en blanc. Il est possible d'interrompre la distribution en enfonçant de nouveau le bouton de distribution.

- 6 Au terme de la distribution, soulever et baisser le levier de chargement des capsules pour évacuer la capsule usée.

- 7 Pour une nouvelle distribution, attendre que les boutons de distribution et le bouton On/Stand-by soient allumés fixe en blanc.

PRÉPARATION DU DOSE LIBRE

⚠ Exécuter les opérations: 1, 2, 3 et 4 du paragraphe PRÉPARATION DU EXPRESSO.

i En cas d'utilisation de capsules solubles, pour mieux savourer le produit, il est conseillé d'effectuer une brève distribution à vide (avec de l'eau seulement) avant d'introduire la capsule.

- 5 Appuyer sur la touche DOSE LIBRE ☕ pour lancer la préparation. Lorsque la quantité désirée de café distribué est atteinte, appuyer de nouveau sur la touche pour terminer la distribution.



i Pendant la distribution, le bouton sélectionné de distribution clignote en blanc. Il est possible d'interrompre la distribution en enfonçant de nouveau le bouton de distribution.

- 6 Au terme de la distribution, soulever et baisser le levier de chargement des capsules pour évacuer la capsule usée.

- 7 Pour une nouvelle distribution, attendre que les boutons de distribution et le bouton On/Stand-by soient allumés fixe en blanc.

NETTOYAGE DE LA MACHINE

! Ne jamais utiliser de solvants, alcools ou substances agressives pour le séchage des composants de la machine.

Laver les composants (sauf ceux électriques) à l'eau froide/tiède et à l'aide de chiffons/éponges non abrasives. Tous les composants démontables peuvent être lavés dans un lave-vaisselle.

Ne pas laisser l'eau dans le circuit et dans le réservoir pendant plus de 3 jours; si tel est le cas, vider, rincer et remplir le réservoir d'eau fraîche puis effectuer une distribution sans capsule avant de sélectionner un café ou une boisson.

NETTOYAGE DISTRIBUTEUR CAFÉ

Pour le nettoyage du distributeur exécuter chaque semaine la procédure DISTRIBUTION CAFÉ sans introduire la capsule.



NETTOYAGE DU BAC DE COLLECTE DES GOUTTES ET DU TIROIR DE COLLECTE DES CAPSULES USÉES

i Le voyant du tiroir de collecte des capsules  s'allume pour indiquer que le tiroir est plein; il faut alors le vider et le remettre en place.

1 Extraire le bac de collecte des gouttes et le tiroir de collecte des capsules usées.

i La machine émet un signal sonore pour signaler le retrait du tiroir de collecte des capsules.



i En retirant le bac pendant plus de 5 secondes, la machine remettra à zéro le compteur de capsules introduites.

- 2** Retirer le bac de collecte des gouttes et le tiroir de collecte des capsules. Jeter les capsules usées et vider les liquides présents dans le bac de collecte des gouttes.

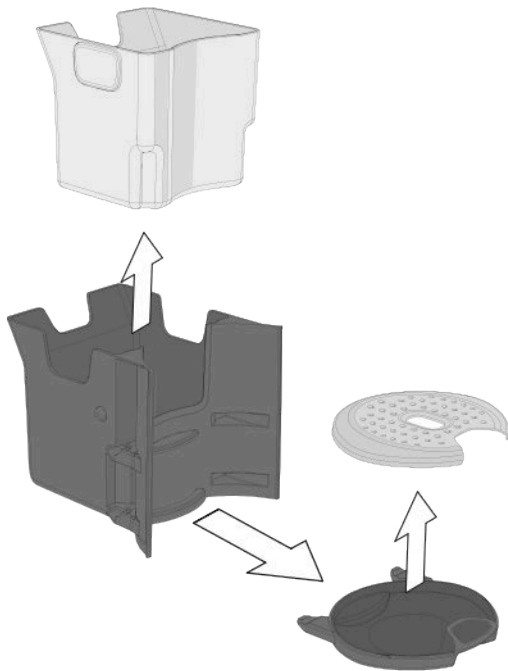

- 3** Laver tous les composants à l'eau froide ou tiède ou bien dans un lave-vaisselle. Les sécher et les remonter correctement.

i Vérifier périodiquement que le bac de collecte des gouttes n'est pas plein pour éviter que le liquide déborde.

DÉTARTRAGE

- !** Lire attentivement les instructions pour le détartrage.

La formation de calcaire est une conséquence normale de l'utilisation de la machine; le détartrage est nécessaire tous les 2-3 mois d'utilisation de la machine et/ou quand on observe une réduction du débit de l'eau.

La machine allume le voyant approprié pour demander d'exécuter le cycle de détartrage ☼.

- !** Ne pas éteindre la machine pendant le cycle de détartrage. Ne pas s'éloigner pendant le cycle de détartrage. Quand le cycle est lancé, il doit être exécuté jusqu'à la fin.

- !** Vérifier qu'il n'y a pas de capsules dans le logement d'insertion des capsules.

- 1** Enlever et vider le réservoir d'eau.

- !** Ne pas boire la solution détartrante et les produits distribués jusqu'au terme du cycle. N'utiliser en aucun cas du vinaigre comme détartrant.

i Pour exécuter le détartrage, il est recommandé d'utiliser le **DÉTARTEUR LAVAZZA**.

- 2** Mettre dans le réservoir le contenu du **DÉTAR-
TREUR LAVAZZA** (250 ml) et de l'eau (250 ml).
Remettre le réservoir sur la machine.



- i** Nettoyer les éventuels giclements ou gouttes à l'aide d'un chiffon humide.

- 3** Mettre sous le distributeur un conteneur d'une capacité supérieure à 0,5 litres.

- 4** Brancher la machine au secteur sans l'allumer.

- 5** Appuyer simultanément sur les boutons de distribution **EXPRESSO** ☕ et **EXPRESSO LONG** ☕ pendant 5 secondes au moins.



- i** La machine émet un long signal sonore tandis que les boutons **On/stand-by** ⏻, **DOSE LIBRE** ☕ et le voyant **détartrage** s'allument fixe.

- 6** Enfoncer le bouton **DOSE LIBRE** ☕ pour lancer le cycle de détartrage.

- !** Si le bouton **DOSE LIBRE** ☕ n'est pas enfoncé dans un délai de 9 minutes à compter du signal sonore, la machine se remettra en mode stand-by et il sera nécessaire de répéter le passage **6** de la procédure pour lancer le cycle.



7 La machine commence la phase de chauffage et le bouton DOSE LIBRE  commence à clignoter.

8 Au terme du cycle de chauffage, la machine lancera automatiquement le détartrage.

i Pendant le cycle de détartrage, le bouton DOSE LIBRE  clignotent et le voyant de détartrage  allumés fixe.



! Pendant le cycle de détartrage, la machine effectue automatiquement des cycles de distribution intermittents pour permettre de vider le conteneur.

i Il est possible de suspendre momentanément le cycle de détartrage en enfonçant le bouton DOSE LIBRE  ou le bouton On/stand-by . Pour reprendre le cycle, enfoncer le bouton DOSE LIBRE .

9 Quand le liquide présent dans le réservoir sera épuisé, le cycle sera momentanément suspendu. Vider le conteneur utilisé pour récolter la solution.

i Bouton On/stand-by , DOSE LIBRE  et le voyant de manque d'eau  s'allument fixe. Voyant de détartrage  est clignotent.

10 Retirer le réservoir d'eau, le rincer et le laver avec soin. Le remplir d'eau fraîche potable plate jusqu'au niveau MAX.

! En cas de coupure d'alimentation, au prochain allumage la machine demandera d'exécuter le cycle de rinçage.



11 Introduire le réservoir avec l'eau. Mettre sous le distributeur un conteneur de capacité supérieure à 0,5 litres.

12 Enfoncer le bouton DOSE LIBRE  pour lancer le cycle de rinçage.

i Pour terminer le cycle de rinçage, une quantité d'eau minimum doit sortir du distributeur. En cas de manque d'eau, le cycle est interrompu momentanément, la machine émet un long signal sonore et le voyant de manque d'eau  s'allume fixe. Remplir le réservoir.

13 Au terme de la distribution, nettoyer la machine à l'aide d'un chiffon humecté.

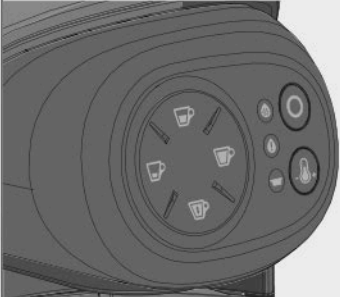
Après le nettoyage, le processus de détartrage est complet. La machine est prête à l'utilisation.

Problème rencontré	Causes possibles	Solution
<p>La machine ne s'allume pas, Voyant On/Stand-by éteint.</p> 	<ul style="list-style-type: none"> » Machine non raccordée au réseau électrique. » La machine est connectée à bloc multiprises qui ne fonctionne pas. » Alimentation secteur/domestique absente. 	<ul style="list-style-type: none"> » Raccorder la machine au réseau électrique. » Raccordez la machine directement à la source de courant » Raccordez un' autre appareil au réseau électrique pour vérifier, s'il y a de source de courant. <p>SI LE PROBLÈME PERSISTE CONTACTER LES SERVICE CLIENTS LAVAZZA.</p>
<p>En enfouçant le bouton On/Stand-by la machine ne s'allume pas.</p> 	<ul style="list-style-type: none"> » L'interface tactile ne réagit pas. » Mauvaise pression simultanée de 2 boutons. 	<ul style="list-style-type: none"> » Vérifier que la surface de l'interface et la main de l'utilisateur sont sèches et propres. » Attendre quelques secondes et enfoucer le bouton On/Stand-by. <p>SI LE PROBLÈME PERSISTE CONTACTER LES SERVICE CLIENTS LAVAZZA.</p>
<p>Perception du délai de chauffage excessif (supérieur à 40 secondes).</p>	<ul style="list-style-type: none"> » Stockage de la machine dans des locaux trop froid (exemple: sous-sol/ garage). 	<ul style="list-style-type: none"> » Laisser la machine dans un milieu approprié pendant au moins 1 heure puis la brancher à la prise secteur et essayer de l'allumer. <p>SI LE PROBLÈME PERSISTE CONTACTER LES SERVICE CLIENTS LAVAZZA.</p>

Problème rencontré	Causes possibles	Solution
La machine il est très bruyant.	<ul style="list-style-type: none"> » La machine ne se trouve pas sur une surface plate et stable. » Câble d'alimentation mal positionné. » Parties mobiles non insérées correctement. » Absence d'eau dans le réservoir. » Il n'y a pas la capsule. 	<ul style="list-style-type: none"> » Vérifier la surface de support. » Vérifier la position du Câble d'alimentation. » Insérer correctement les parties mobiles. » Faire l'appoint d'eau fraîche potable. » Insérer une capsule Lavazza A MODO MIO ou compatible. <p>SI LE PROBLÈME PERSISTE CONTACTER LES SERVICE CLIENTS LAVAZZA.</p>
La machine prête à l'utilisation ne réagit pas à la pression des boutons.	<ul style="list-style-type: none"> » Mauvaise pression/activation des boutons. » Le tiroir de collecte des capsules usées n'est pas inséré. 	<ul style="list-style-type: none"> » Enfoncer l'un des boutons allumés puis vérifier si la machine émet un signal sonore (s'il est activé) et si l'icône sélectionnée clignote effectivement. » Vérifier que le tiroir est bien inséré et que le voyant d'alarme s'éteint. Vérifier si la distribution est effectuée. <p>SI LE PROBLÈME PERSISTE CONTACTER LES SERVICE CLIENTS LAVAZZA.</p>
Le levier reste fermé après la distribution.	<ul style="list-style-type: none"> » Le tiroir des capsules usées est plein. 	<ul style="list-style-type: none"> » Vider le tiroir et essayer d'ouvrir le levier. <p>SI LE PROBLÈME PERSISTE CONTACTER LES SERVICE CLIENTS LAVAZZA.</p>

Problème rencontré	Causes possibles	Solution
La machine n'effectue pas la distribution (elle s'allume mais elle ne distribue ni café ni eau).	<ul style="list-style-type: none"> » Absence d'eau dans le réservoir. » Réservoir non inséré correctement. » Le levier de chargement des capsules est soulevé ou est mal baissé. » Absence de flux d'eau dans le circuit hydraulique (pas de déclenchement). » La capsule il n'est pas compatible. » Présence de calcaire. 	<ul style="list-style-type: none"> » Remplir le réservoir d'eau fraîche potable et vérifier si la distribution est effectuée correctement. » Introduire correctement le réservoir et vérifier si la distribution est bien effectuée. » Baisser le levier de chargement des capsules jusqu'en butée et vérifier si la distribution est bien effectuée. » Débrancher le câble d'alimentation, attendre 10 secondes puis rebrancher le câble. Allumer la machine et attendre la fin du chauffage. Vérifier que la distribution est correcte (la machine effectue automatiquement des tentatives de remplissage du circuit). » Essayer avec une autre capsule prise dans une autre boîte. » Effectuer le détartrage avec le détartréur Lavazza. <p>SI LE PROBLÈME PERSISTE CONTACTER LES SERVICE CLIENTS LAVAZZA.</p>
La machine perd de l'eau.	<ul style="list-style-type: none"> » Le réservoir est endommagé. » Le bac à capsules usagées est plein. » Capsule bloquée. » La capsule il n'est pas compatible. 	<ul style="list-style-type: none"> » Vérifier s'il y a des fuites dans le réservoir en le tenant éloigné de la machine. » Vider le tiroir des dosettes usagées. » Ouvrir et fermer le levier pour faire tomber la capsule. Extraire le tiroir porte-capsules et le vider. » Utiliser des capsules adéquates (Lavazza A MODO MIO ou compatibles). <p>SI LE PROBLÈME PERSISTE CONTACTER LES SERVICE CLIENTS LAVAZZA.</p>

Problème rencontré	Causes possibles	Solution
Bouton on/off clignotant rouge.	» Conditions de stockage machine non adéquates/Blocage temporaire.	» Détacher la fiche de la machine de la prise secteur. Laisser la machine à température ambiante pendant une période suffisante (1 heure maximum). Brancher la machine à la prise secteur et enfoncer le bouton d'allumage (essayer une seule fois). SI LE PROBLÈME PERSISTE CONTACTER LES SERVICE CLIENTS LAVAZZA.
Le levier de chargement n'atteint pas la position de distribution ou requiert une force de fermeture excessive.	» Le bac à capsules usagées est plein. » Capsule bloquée.	» Vider le tiroir et essayer de soulever le levier. » Ouvrir et fermer le levier pour faire tomber la capsule. SI LE PROBLÈME PERSISTE CONTACTER LES SERVICE CLIENTS LAVAZZA.
Le café est distribué trop rapidement et il n'est pas assez crémeux.	» Utilisation d'une capsule déjà utilisée. » Capsule non insérée. » La capsule il n'est pas compatible.	» Utiliser une capsule neuve. » Insérer la capsule. » Essayer avec une autre capsule prise dans une autre boîte. SI LE PROBLÈME PERSISTE CONTACTER LES SERVICE CLIENTS LAVAZZA.
Le café il est froid.	» Distribution lente avec circuit hydraulique obstrué par le calcaire.	» Effectuer le détartrage avec le détartreur Lavazza. SI LE PROBLÈME PERSISTE CONTACTER LES SERVICE CLIENTS LAVAZZA.

Problème rencontré	Causes possibles	Solution
La machine n'émet aucun son.	» Signal sonore désactivé.	» Mettre la machine en stand-by puis enfoncer simultanément les boutons de distribution Café Espresso et Café Long pendant 5 secondes au moins. (voir la section PRÉDISPOSITION MACHINE). SI LE PROBLÈME PERSISTE CONTACTER LES SERVICE CLIENTS LAVAZZA.
Le café sort lentement en gouttes.	» Utilisation d'une capsule non adéquate. » Utilisation d'une capsule déjà utilisée. » Distributeur obstrué. » Circuit hydraulique obstrué par le calcaire	» Essayer avec une autre capsule prise dans une autre boîte. » Retirez la capsule utilisée et utilisez une nouvelle capsule. » Exécuter le cycle de lavage distributeur café (voir ENTRETIEN et NETTOYAGE). » Effectuer le détartrage avec le détartreur Lavazza. SI LE PROBLÈME PERSISTE CONTACTER LES SERVICE CLIENTS LAVAZZA.

Pour tout problème ne figurant pas dans les cas mentionnés ci-dessus, s'adresser au Service Clients Lavazza

CARACTÉRISTIQUES TECHNIQUES

- Voltage: 220-240V / 50-60Hz
- Puissance totale: 1500W
- Dimensions: Hauteur 280 mm Largeur 145 mm Profondeur 380 mm
- Poids: 4 kg
- Réservoir eau extractible: 1,1 L
- Matériels utilisés pour la carrosserie: Thermoplastique
- Longueur câble: 0,8 m

⚠️ Gebrauchsbestimmung:

Dieses Gerät ist für den Einsatz in häuslichen und vergleichbaren Umgebungen bestimmt, wie:

- Personalküchen in Geschäften, Büros und sonstige Arbeitsbereiche;
- Bauernhöfe;
- Verwendung durch Hotel- und Moteltkunden sowie in sonstigen Wohnbereichen;
- Beherbergungsbetriebe (z.B. Bed & Breakfast).

Technische Änderungen daran sind untersagt. Jeglicher Missbrauch ist auf Grund der damit verbundenen Risiken untersagt!

Die Maschine kann von Kindern ab 8 Jahren sowie von Personen mit eingeschränkten körperlichen, sensorischen oder geistigen Fähigkeiten bzw. von Personen ohne Erfahrung und ohne entsprechende Kenntnisse benutzt werden, sofern sie beaufsichtigt werden oder bezüglich des sicheren Gebrauchs der Maschine unterwiesen wurden und die damit verbundenen Gefahren verstanden haben. Kinder dürfen nicht mit der Maschine spielen.





Die vom Benutzer auszuführende Reinigung und Wartung dürfen nicht von unbeaufsichtigten Kindern durchgeführt werden.

⚠️ Aufstellung:

Die Kaffeemaschine an einem sicheren Ort aufstellen, wo niemand sie umwerfen oder davon verletzt werden kann. Die Maschine nicht bei Temperaturen unter 5°C benutzen, da Frost sie beschädigen würde. Die Kaffeemaschine nicht im Freien benutzen. Die Maschine nicht auf sehr warme Flächen und/oder in die Nähe von offenen Flammen stellen. Die Kaffeemaschine darf bei der Benutzung nicht in einen Schrank gestellt werden.

⚠️ Stromversorgung:

Die Kaffeemaschine nur an geeignete Steckdosen anschließen. Die Spannung muss dem auf dem Maschinenschild angegebenen Wert entsprechen.

-  **Stromkabel:**
Die Kaffeemaschine nicht benutzen, wenn das Netzkabel defekt ist. Bei Schäden am Netzkabel muss dieses vom Hersteller oder seinem technischen Kundendienst oder jedenfalls von einer ähnlich qualifizierten Person ersetzt werden, um allen Risiken vorzubeugen. Das Netzkabel soll nicht über Ecken, scharfe Kanten oder über sehr heißen Gegenständen verlaufen. Die Kaffeemaschine nicht am Kabel ziehen oder tragen. Den Stecker nicht durch Zug am Kabel ausziehen oder mit nassen Händen berühren. Das Netzkabel sollte nicht frei vom Tisch oder von Regalen herunter hängen.
-  **Schlaggefahr:**
Die unter Strom stehenden Teile dürfen nicht mit Wasser in Berührung kommen. Diese Maschine darf nicht in Wasser getaucht werden.
-  **Schutz für Kinder unter 8 Jahren:**
Ganz besonders auf die Kinder aufpassen, damit diese nicht mit dem Gerät spielen, Kinder verstehen nicht die mit Haushaltsgeräten verbundenen Gefahren. Auch das Verpackungsmaterial der Maschine sollte nicht in Reichweite von Kindern gelassen werden.
-  **Verbrennungsgefahr:**
Die heißen Teile (Kapselaufnahmegruppe usw.) nicht sofort nach Benutzung des Gerätes berühren. Während der Abgabe des Getränks Vorsicht wegen eventuellem Ausspritzen der heißen Flüssigkeit.
-  **Reinigung:**
Vor Reinigung der Maschine muss unbedingt der Stecker aus der Steckdose abgezogen und abgewartet werden, dass sich die Maschine abkühlt. Die Kaffeemaschine nicht in Wasser tauchen! Es ist streng untersagt, Einschnitte im Maschineninneren durchzuführen. Das Wasser im Tank ersetzen, wenn die Maschine 3 Tage lang nicht verwendet wird. Um Schäden am Gerät zu vermeiden, keine alkalischen Reinigungsmittel, sondern ein weiches Tuch und ein schonendes Reinigungsmittel verwenden.

**Aufbewahrung der Maschine:**

Wird die Maschine für längere Zeit nicht benutzt, den Stecker aus der Dose ziehen und die Maschine an einem trockenen, für Kinder unzugänglichen und vor Staub und Schmutz geschützten Ort aufbewahren.

**Reparaturen / Wartung:**

Bei Havarien, Defekten oder Verdacht auf Beschädigung nach einem Fall, sofort den Stecker aus der Dose ziehen. Eine defekte Maschine nicht in Betrieb setzen. Allein die autorisierten Kundendienstzentren dürfen Einschritte und Reparaturen ausführen. Bei Einschritten, die nicht fachgerecht ausgeführt wurden, wird bei eventueller Beschädigung jegliche Haftung hinfällig.

**Wasserbehälter:**

Nur stilles, nicht sprudelndes Trinkwasser in den Behälter füllen. Die Maschine nicht in Betrieb setzen, wenn nicht genügend Wasser im Behälter vorhanden ist.

**Kapselraum:**

Es dürfen nur Lavazza **A MODO MIO** oder kompatible Kapseln in das Kapselwurfloch eingelegt werden; nicht die Finger oder sonstige Gegenstände einführen. Die Kapseln dürfen nur einmal verwendet werden.

**Entsorgung der Maschine nach Beendigung ihrer Lebensdauer:**

BENUTZERINFORMATIONEN: das Symbol mit dem durchgestrichenen Müllimer auf dem Gerät oder auf seiner Verpackung gibt an, dass das Produkt zum Ende seines Betriebslebens getrennt vom Hausmüll entsorgt werden muss. Der Benutzer muss das außer Betrieb genommene Gerät aus diesem Grunde entsprechenden Entsorgungsstellen für Elektro- und Elektronikmüll. Die angemessene getrennte Abfallentsorgung für die folgende Zustellung des ausgedienten Geräts zum umweltfreundlichen Recycling, zur Behandlung und/oder Entsorgung trägt dazu bei, mögliche negative Wirkungen auf die Umwelt und die Gesundheit zu vermeiden und fördert die Wiederverwendung und/oder das Recycling der Materialien, aus denen das Gerät zusammengesetzt ist. Die ungesetzliche Entsorgung des Produkts durch den Besitzer zieht die Verhängung von Verwaltungsstrafen gemäß der geltenden Gesetzgebung nach sich.

INHALT DER VERPACKUNG *

- IDOLA-Maschine
- Willkommensset mit 9 gemischten Kapseln Lavazza **A MODO MIO** und der Broschüre Lavazza **A MODO MIO**

- Gebrauchsanleitung
- Schnellanleitung
- Garantieblatt

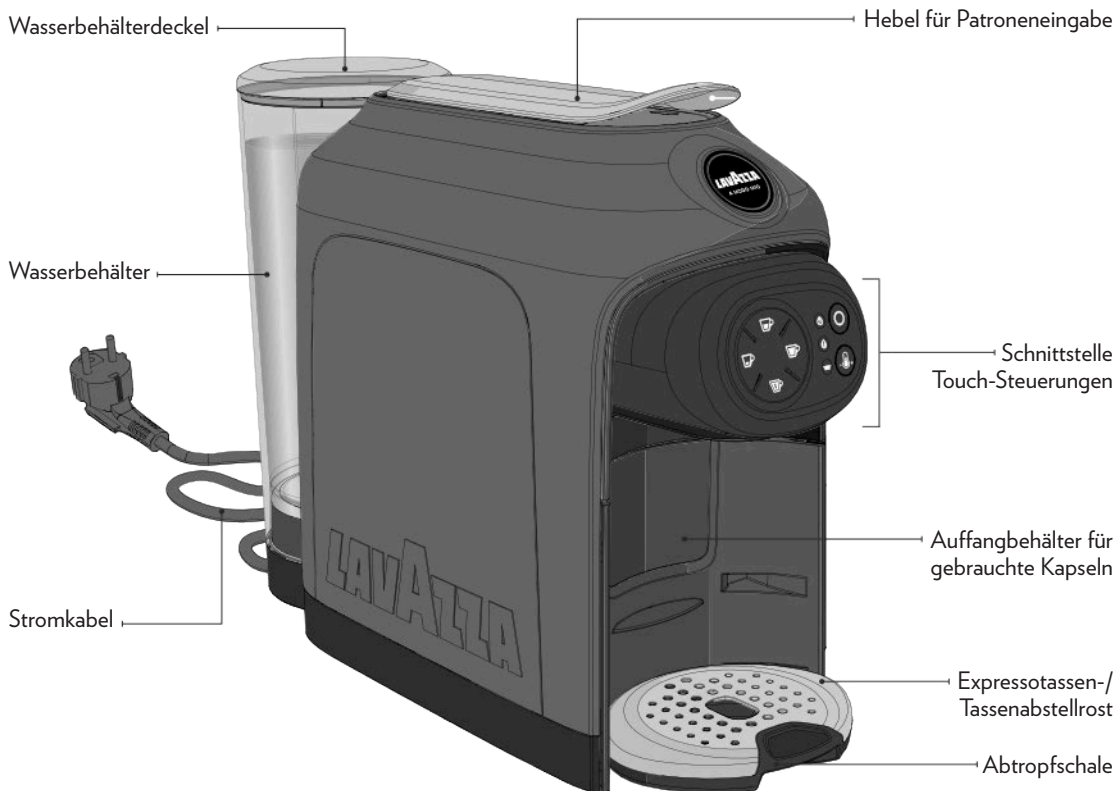

































































































* Die Eigenschaften und der Inhalt der Packung können je nach dem Bezugsmarkt unterschiedlich sein



SCHNITTSTELLE TOUCH-STEUERUNGEN

- | | | | |
|----------|----------------------------------|----------|-------------------------------|
| 1 | Ausgabetaste für ESPRESSO | 6 | Kontrollleuchte Kein Wasser |
| 2 | Ausgabetaste für LANGE ESPRESSO | 7 | Kontrollleuchte Abtropfschale |
| 3 | Ausgabetaste für LANGE KAFFEE | 8 | On / Stand-by taste |
| 4 | Ausgabetaste für FREIE DOSIERUNG | 9 | Taste Boost TEMPERATUR |
| 5 | Entkalkungsleuchte | | |

STATUS DER SCHNITTSTELLE			
Stand-by			
			
			  
Einschalten 			
			
			  
Erhitzung			
			
			  
Maschine bereit (in Temperatur)			
			
			  
Ausgabe Espresso (Taste 1) 			
			
			  
Ausgabe lange Espresso (Taste 2) 			
			
			  
Ausgabe lange Kaffee (Taste 3) 			
			
			  
Ausgabe freie Dosierung (Taste 4) 			
			
			  
Kein Wasser im Tank 			
			
			  

STATUS DER SCHNITTSTELLE

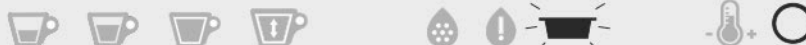
Behälter für verbrauchte Kapseln voll Behälter für verbrauchte Kapseln schlecht positioniert oder nicht vorhanden 

Entkalkung erforderlich

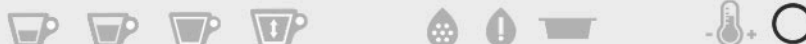
Maschine blockiert 

Rot

 = Aus
  = An
  = Blinken
  = Akustisches Feedback

! In den nachstehenden Fällen wird keinerlei Haftung übernommen:

- falsche oder nicht dem Zweck entsprechende Benutzung;
- nicht in den autorisierten Kundendienstzentren ausgeführte Reparaturen;
- einschritte auf das Stromkabel;
- einschritte auf jegliche Komponente der Maschine;
- Verwendung von nicht Original Ersatzteilen oder Zubehör;
- fehlende Entkalkung;
- Lagerung in Räumen unter 4° C;
- Verwendung unter 5° C;
- Verwendung über 40° C;
- Benutzung in Räumen mit relativer Luftfeuchtigkeit über 95%;
- Verwendung von anderen als den angegebenen Kapseln.

In diesen Fällen werden Garantieleistungen hinfällig.

START DER MASCHINE

! Die Maschine auf eine ebene und stabile Fläche stellen, fern von Wasser und Wärmequellen. Eventuelle Beschädigungen der Maschine, die durch Nichtbeachtung dieser Weisungen verursacht werden, fallen nicht unter die Garantieleistungen.

- 1** Den Deckel heben und entfernen, dann den Wasserbehälter ausziehen.
- 2** Den Behälter vor der Verwendung spülen.
- 3** Den Behälter bis zur MAX-Standanzeige mit Wasser auffüllen, wozu frisches, nicht sprudelndes Trinkwasser verwandt wird. Den Tank wieder einsetzen, und mit dem Deckel wieder schließen.

i *Der Deckel kann geöffnet werden, um den Behälter direkt zu füllen.*

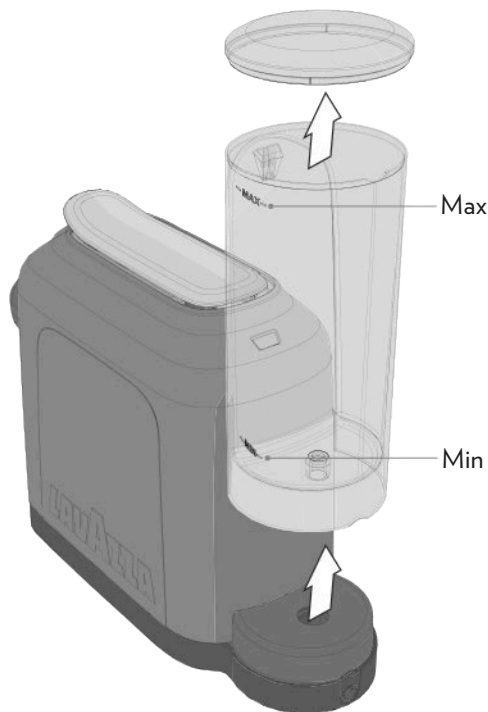

! Der Wasserstand darf den Höchstwasserstand (MAX). Ausschließlich frisches Trinkwasser ohne Kohlensäure verwenden. Heißes Wasser und andere Flüssigkeiten können den Behälter und die Maschine beschädigen. Die Maschine erst dann in Betrieb setzen, wenn sichergestellt wurde, dass genügend Wasser im Behälter vorhanden ist.

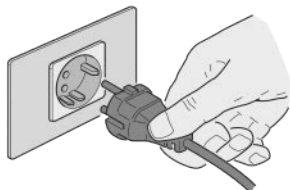

! Vergewissern Sie sich, dass Ihre Hände, die Maschine, das Kabel und die Auflagefläche der Maschine nicht nass sind.

- 4** Den Stecker in die Stromsteckdose einführen.



- 5** On/Stand-by taste  drücken, um die Maschine einzuschalten.
Alle Tasten schalten sich mit weißem Dauerlicht ein, die Alarmleuchten schalten sich einen Augenblick mit gelbem Dauerlicht ein.



- 6** Die Maschine startet den Heizzyklus. Die On/Stand-by taste  beginnt, mit weißem Licht zu blinken.
7 Die Maschine ist einsatzbereit, wenn die Taste On/Standby  aufhört zu blinken, und die Ausgabetasten mit Dauerlicht eingeschaltet sind.

i *Durch Drücken einer der Ausgabetasten während des Erhitzungszyklus kann das Getränk bestellt werden, das am Ende der Erhitzung ausgegeben wird.*

- 8** Bei der ersten Einschaltung 0,5 Liter Wasser ohne Kapsel ausgeben, den Hebel gesenkt halten. Einen Becher unter den Ausgießer stellen.

- 9** Die Taste FREIE DOSIERUNG  drücken, und das Ende der Ausgabe abwarten.

i *Vor der Entfernung und Entleerung der Tasse, den Hebel öffnen und schließen.*

- 10** Den Becher entleeren, und eine zweite Ausgabe durch erneutes Drücken der Taste FREIE DOSIERUNG  ausführen.



! Wenn eine Ausgabe ausgewählt wird, aktiviert die Maschine 7 Sekunden lang die Elektropumpe des Wassers.



Wenn Wasser im Wasserkreislauf vorhanden ist, führt die Maschine die Ausgabe.

Wenn kein Wasser im Wasserkreislauf vorhanden ist, unterbricht die Maschine 5 Sekunden lang die Ausgabe und versucht maximal 5 Mal wieder, die Ausgabe auszuführen.



Nachdem 5 Versuche überschritten wurden, schaltet die Maschine die Kontrollleuchte Kein Wasser **i** mit orange Dauerlicht ein, um anzuzeigen, dass kein Wasser vorhanden ist, und gibt ein akustisches Signal aus.



AKTIVIERUNG/DEAKTIVIERUNG DES AKUSTISCHEN SIGNALS

- 1** Die Maschine in die Standby-Modalität versetzen.
- 2** Die Ausgabebtasten ESPRESSO  und LANGE ESPRESSO  gleichzeitig mindestens 5 Sekunden lang anhaltend drücken.
- i** Die Maschine gibt ein langes akustisches Signal aus, um die Deaktivierung des akustischen Signals anzuzeigen. Zwei kurze akustische Signale zur Anzeige der Aktivierung.
- 3** Nach Beendigung des Verfahrens kehrt die Maschine in die Standby-Modalität zurück.

STANDBY-FUNKTION

- i** Zur Stromersparnis geht die Maschine nach 9 Minuten Nichtgebrauch automatisch auf **Standby**. Die Maschine kann vor Ablauf der 9 Minuten durch Drücken der Taste On/Standby , manuell in die Standby-Modalität versetzt werden, die Maschine gibt ein akustisches Signal aus. In der Standby-Modalität sind die Tasten ausgeschaltet, und die Taste  ist mit reduzierter Helligkeit eingeschaltet. Durch erneutes Drücken der Taste On/Standby  kann die Maschine wieder gestartet werden.

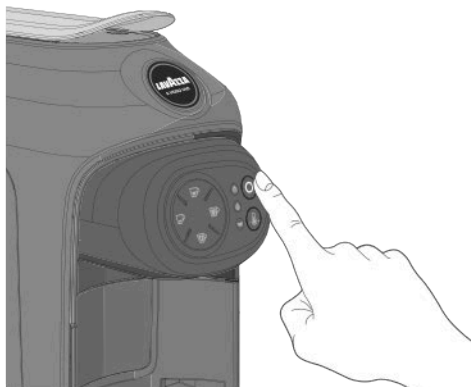

VORBEREITUNG FÜR KAFFEEZUBEREITUNG

Die Maschine verfügt über zwei Positionen für die Zubereitung des Kaffees: Tasse/Große Tasse.

- 1 Für die Verwendung einer Espressotasse: Den Espressotassen-/Tassenabstellrost herausziehen.

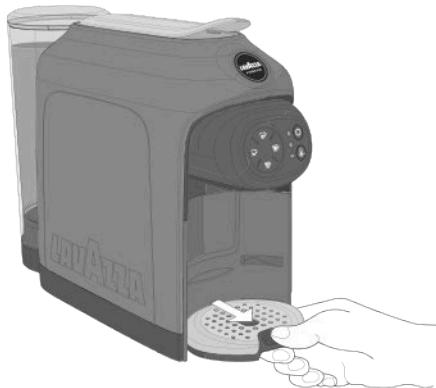

- 2 Den Tassenabstellrost in die entsprechende obere Öffnung einführen.

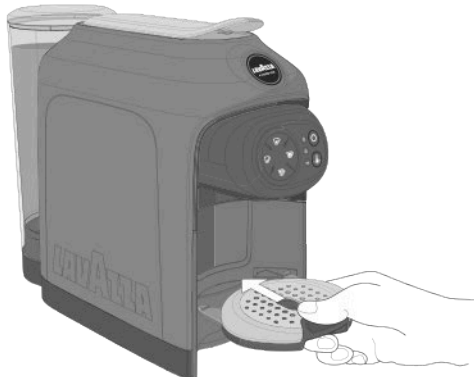

- 3 Die Espressotasse auf dem Rost abstellen.



- 4 Um die große Tasse zu verwenden, die Tasse oder den Becher direkt auf dem unteren Rost abstellen.



AUSGABE EINES ESPRESSO / LANGE ESPRESSO

i Sicherstellen, dass die Kaffee-Ausgabetasten mit weißem Dauerlicht eingeschaltet sind.

1 Platzieren Sie den Becher/die Tasse wie gezeigt (siehe **VORBEREITUNG FÜR KAFFEEZUBEREITUNG**).

2 Den Ladehebel der Kapseln bis zu seiner Blockierung anheben, um das Kapselwurfloch zu öffnen.

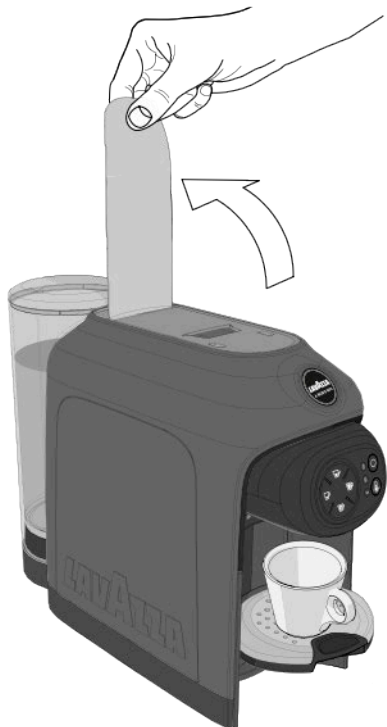

! Niemals die Finger oder Gegenstände in das Kapselwurfloch stecken. Es dürfen nur Lavazza **A MODO MIO** oder kompatible Kapseln in das Kapselwurfloch eingelegt werden. Die Monodosiskapseln sind für die Abgabe nur eines Kaffees/Produktes ausgelegt. Die Kapseln nach einmaligem Gebrauch **NICHT** wieder verwenden. Die gleichzeitige Einlage von 2 oder mehr Kapseln bewirkt Maschinenstörungen.

3 Eine Kapsel Lavazza **A MODO MIO** in das Kapselwurfloch einlegen.



- 4** Den Ladehebel der Kapseln absenken, um das Kapsleinwurfloch zu schließen.



- i** Wenn ein heißerer Kaffee gewünscht wird, kann die Getränketemperatur durch Drücken der Taste Boost TEMPERATUR  erhöht werden. Die Maschine gibt bei Tastendruck ein akustisches Signal aus und erhöht die Leuchtstärke der Taste.



- i** Wenn gewünscht wird, auf die Standardtemperatur zurückzukehren, erneut die Taste Boost TEMPERATUR  drücken. Die Maschine gibt bei Tastendruck ein akustisches Signal aus und reduziert die Leuchtstärke der Taste.

- !** Es ist nicht möglich, die Temperatur während der Ausgabe zu ändern.

- 5** Für den Start einer Ausgabe:
die Taste für ESPRESSO ☕ (30 ml) oder
die Taste für LANGE ESPRESSO ☕ (45 ml).

Die Maschine stoppt die Ausgabe automatisch, sobald die programmierte Kaffeemenge erreicht ist.



- i** Während der Ausgabe leuchtet die ausgewählte Ausgabetaсте mit blinkendem weißem Licht. Es ist möglich, die Ausgabe durch erneutes Drücken der Ausgabetaсте zu unterbrechen.

- !** Sollte sich während der Abgabe ein Stromausfall ergeben, gehen Sie so vor:

- Die Stromversorgung wieder herstellen.
- Die On/Stand-by taste drücken; warten, bis sie mit weißem Dauerlicht eingeschaltet ist.
- Die Kapsel im Kapselwurfbehälter durch eine neue Kapsel ersetzen.
- Den Kaffeeabgabevorgang erneut starten.

- !** Sollte sich während der Abgabe aber kein Wasser mehr im Tank vorhanden sein, gehen Sie so vor:

- Wasserbehälter bis auf die MAX-Anzeige auffüllen.
- Die Kapsel im Kapselwurfbehälter durch eine neue Kapsel ersetzen.
- Den Kaffeeabgabevorgang erneut starten.

- !** Durch die Ausgabe ohne Kapsel entsprechen die Dosen möglicherweise nicht der programmierten Menge.

- 6** Nach der Ausgabe den Ladehebel der Kapseln heben und senken, um die verwendete Kapsel zu entfernen.

- 7** Für eine neue Ausgabe warten, bis die Ausgabetaсте und die Taste On/Standby mit weißem Dauerlicht eingeschaltet sind.

AUSGABE EINES LANGE KAFFEE

! Die Schritte: **1**, **2**, **3** und **4** des Abschnitts **AUSGABE EINES ESPRESSO** ausführen.

5 Die Taste für **LANGE KAFFEE** ☕ (90 ml) drücken, um die Ausgabe zu starten. Die Maschine stoppt die Ausgabe automatisch, sobald die programmierte Kaffeemenge erreicht ist.

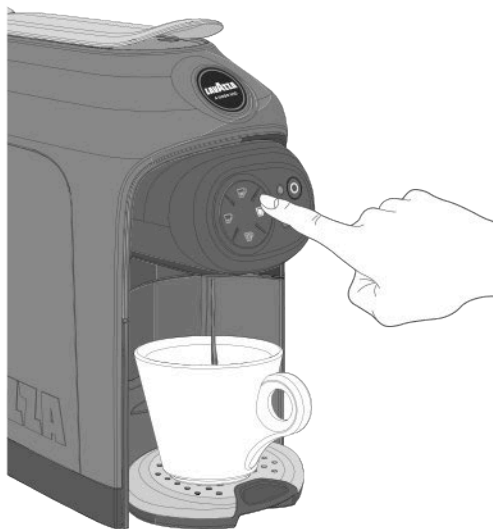

i Während der Ausgabe leuchtet die ausgewählte Ausgabetaste mit blinkendem weißem Licht. Es ist möglich, die Ausgabe durch erneutes Drücken der Ausgabetaste zu unterbrechen.

6 Nach der Ausgabe den Ladehebel der Kapseln heben und senken, um die verwendete Kapsel zu entfernen.

7 Für eine neue Ausgabe warten, bis die Ausgabetasten und die Taste On/Standby mit weißem Dauerlicht eingeschaltet sind.

AUSGABE EINES FREIE DOSIERUNG

! Die Schritte: **1**, **2**, **3** und **4** des Abschnitts **AUSGABE EINES ESPRESSO** ausführen.

i Für einen besseren Genuss löslicher Kapseln empfiehlt sich vor Einlage der Kapsel selbst die Maschine ein Mal kurz leer laufen zu lassen (d.h. nur mit Wasser).

5 Die Taste für **FREIE DOSIERUNG** ☕ drücken, um die Ausgabe zu starten. Beenden Sie die Ausgabe indem Sie die Taste wiederum drücken, nachdem die gewünschte Kaffeemenge erreicht ist.



i Während der Ausgabe leuchtet die ausgewählte Ausgabetaste mit blinkendem weißem Licht. Es ist möglich, die Ausgabe durch erneutes Drücken der Ausgabetaste zu unterbrechen.

6 Nach der Ausgabe den Ladehebel der Kapseln heben und senken, um die verwendete Kapsel zu entfernen.

7 Für eine neue Ausgabe warten, bis die Ausgabetasten und die Taste On/Standby mit weißem Dauerlicht eingeschaltet sind.

REINIGUNG DER MASCHINE

- !** Nie Lösungsmittel, Alkohol oder angreifende Substanzen noch den Ofen für das Trocknen der Maschinenbestandteile benutzen. Die Komponenten (mit Ausnahme der elektrischen) mit kaltem/lauwarmem Wasser und nicht abreibenden Lappen/Schwämmen reinigen. Alle ausbaubaren Bestandteile können in der Spülmaschine gewaschen werden. Nie Lösungsmittel, Alkohol oder angreifende Substanzen noch den Ofen für das Trocknen der Maschinenbestandteile benutzen. Die Komponenten (mit Ausnahme der elektrischen) mit kaltem/lauwarmem Wasser und nicht abreibenden Lappen/Schwämmen reinigen. Alle ausbaubaren Bestandteile können in der Spülmaschine gewaschen werden.

REINIGUNG DER KAFFEEABGABEDÜSE

Für die Reinigung der Abgabedüse wird einmal pro Woche der KAFFEEABGABE- Vorgang ohne Einlage der Kapsel ausgeführt.



REINIGUNG DER ABTROPFSCHALE UND BEHÄLTER DER VERBRAUCHTEN KAPSELN

- i** Die Einschaltung der Kontrollleuchte des Kapselbehälters  zeigt an, dass der Behälter der verbrauchten Kapseln voll ist und dass er entleert und wieder eingesetzt werden muss.
- 1** Die Abtropfschale und den Behälter der verbrauchten Kapseln herausziehen.
- i** Die Maschine gibt ein akustisches Signal aus, um die Entfernung des Behälters der verbrauchten Kapseln anzuzeigen.



- i** Bleibt der Auffangbehälter länger als 5 Sekunden herausgezogen, setzt die Maschine die Zählung der eingesetzten Kapseln zurück.

- 2** Die Abtropfschale und den Behälter der verbrauchten Kapseln entfernen. Die verbrauchten Kapseln und die in der Abtropfschale vorhandenen Flüssigkeiten entleeren.

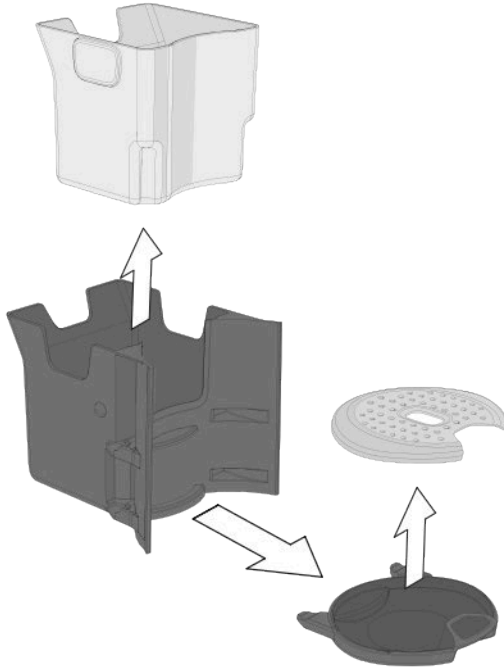

- 3** Alle Komponenten mit kaltem oder lauwarmem Wasser oder in der Geschirrspülmaschine waschen. Abtrocknen und korrekt wieder einbauen.

i Regelmäßig prüfen, ob die Abtropfschale voll ist, um ein Austreten der Flüssigkeit zu vermeiden.

ENTKALKEN

- !** Aufmerksam die für die Entkalkung angegebenen Anweisungen durchlesen.

Die Kalkablagerung ist eine normale Folge der Benutzung der Maschine. Ein Entkalken wird alle 2-3 Monate Benutzung der Maschine notwendig, oder aber wenn eine geringere Wasserförderleistung bemerkt wird.

Der Entkalkungszyklus wird von der Maschine durch die Einschaltung der entsprechenden Anzeileuchte angefordert .

- !** Die Maschine während des Entkalkungszyklus nicht ausschalten. Während des Entkalkungszyklus nicht weggehen. Nach dem Start muss der Zyklus bis zum Ende ausgeführt werden.

- !** Prüfen, ob Kapseln im Kapselwurfbehälter vorhanden sind.

- 1** Den Wasserbehälter entfernen und entleeren.

- !** Die Entkalkungslösung und die bis zum Zyklusende abgegebenen Produkte nicht trinken. Es darf keinesfalls Essig als Entkalkungsmittel verwendet werden.

- i** Zur Ausführung der Entkalkung wird das **ENTKALKUNGSMITTEL LAVAZZA** empfohlen.

- 2** Den Tank mit dem Inhalt des **ENTKALKUNGS-MITTELS LAVAZZA** (250 ml) und Wasser (250 ml) füllen. Den Tank wieder auf der Maschine montieren.



- i** Mögliche Spritzer oder Tropfen mit einem feuchten Tuch reinigen.

- 3** Einen Behälter mit einem Fassungsvermögen von über 0,5 Litern unter dem Ausgabelahn positionieren.

- 4** Die Maschine mit der Netzversorgung verbinden, ohne diese einzuschalten.

- 5** Die Ausgabetaste **ESPRESSO** ☕ und **LANGE ESPRESSO** ☕ gleichzeitig mindestens 5 Sekunden lang anhaltend drücken.





- i** Das Gerät gibt ein langes akustisches Signal aus, und es schalten sich folgende Tasten mit Dauerlicht ein: On/Standby ○, **FREIE DOSIS** ☕ und die Entkalkungsleuchte ☼.

- 6** Die Taste **FREIE DOSIS** ☕ drücken um den Entkalkungszyklus zu starten.



- !** Wenn die Taste **FREIE DOSIS** ☕ nicht innerhalb von 9 Minuten nach dem akustischen Signal gedrückt wird, kehrt die Maschine in die Standby-Modalität zurück, und der Verfahrensschritt muss wiederholt werden um den Zyklus zu starten.

- 7** Die Maschine startet die Erhitzungsphase, und die Taste FREIE DOSIS  fängt an zu blinken.
- 8** Nach der Beendigung des Erhitzungszyklus startet die Maschine automatisch die Entkalkung.

i Während des Entkalkungszyklus ist die Taste FREIE DOSIS  mit Blinklicht eingeschaltet, die Entkalkungsleuchte  ist mit Dauerlicht eingeschaltet.



! Während des Entkalkungszyklus führt die Maschine automatisch intermittierende Ausgabesyklen aus, um die Entleerung des Behälters zu ermöglichen.

i Es ist möglich, den Entkalkungszyklus vorübergehend durch Drücken der Taste FREIE DOSIS  oder der Taste  abbrechen. Für die Wiederaufnahme die Taste FREIE DOSIS  drücken.

- 9** Wenn die Maschine die Flüssigkeit im Tank erschöpft hat, wird der Zyklus vorübergehend abgebrochen. Den für das Auffangen der Lösung verwendeten Behälter entleeren.

i Die Taste On/Standby , FREIE DOSIS  und Kontrollleuchte Kein Wasser  sind mit Dauerlicht eingeschaltet. Entkalkungsleuchte  mit Blinklicht eingeschaltet.

- 10** Den Wassertank entfernen, spülen und sorgfältig waschen. Den Behälter mit frischem Trinkwasser ohne Kohlensäure bis zum MAX Füllstand füllen.



! Bei einem Stromausfall erfordert die Maschine bei der ersten Einschaltung einen Spülzyklus.

- 11** Den Tank mit Wasser einsetzen. Einen Behälter mit einem Fassungsvermögen von über 0,5 Litern unter dem Ausgabehahn positionieren.

- 12** Die Taste FREIE DOSIS  drücken, um den Spülzyklus zu starten.

i Für die Beendigung des Spülzyklus muss eine Mindestmenge Wasser ausgegeben werden. Wenn kein Wasser vorhanden ist, wird der Zyklus vorübergehend unterbrochen, die Maschine gibt ein langes akustisches Signal aus, und die Kontrollleuchte Kein Wasser  schaltet sich mit Dauerlicht ein. Den Tank nachfüllen.

- 13** Die Maschine nach Beendigung der Ausgabe mit einem weichen angefeuchteten Tuch reinigen. Nach Beendigung der Reinigung ist das Entkalkungsverfahren beendet. Die Maschine ist einsatzbereit.

Vorgefundenes Problem	Mögliche Ursache	Lösung
<p>Die Maschine lässt sich nicht einschalten, Kontrollleuchte On/Standby ausgeschaltet.</p> 	<ul style="list-style-type: none"> » Die Maschine ist nicht an das Stromnetz angeschlossen. » Die Maschine ist an Steckdosenleisten oder an einen nicht funktionierenden Mehrfachstecker angeschlossen. » Keine Stromversorgung im Strom-/Hausnetz. 	<ul style="list-style-type: none"> » Die Maschine an das Stromnetz anschließen. » Die Maschine direkt an das Stromnetz anschließen. » Überprüfen, ob Strom vorhanden ist, indem ein anderes elektrisches Gerät an die Stromversorgung angeschlossen wird. <p>SOLLTE DAS PROBLEM WEITERHIN BESTEHEN, DEN LAVAZZA-KUNDENDIENST KONTAKTIEREN.</p>
<p>Wenn die Taste On/Standby gedrückt wird, schaltet sich die Maschine nicht ein.</p> 	<ul style="list-style-type: none"> » Touch-Schnittstelle nicht reaktiv. » Falscher gleichzeitiger Druck von 2 Tasten. 	<ul style="list-style-type: none"> » Prüfen, ob die Oberfläche der Schnittstelle und die Hand des Benutzers trocken und sauber sind. » Einige Sekunden warten, und nur die Taste On/Standby drücken. <p>SOLLTE DAS PROBLEM WEITERHIN BESTEHEN, DEN LAVAZZA-KUNDENDIENST KONTAKTIEREN.</p>
<p>Die Erhitzungszeit scheint zu lang zu sein (länger als 40 Sekunden).</p>	<ul style="list-style-type: none"> » Lagerung der Maschine in zu kalten Umgebungen (Bsp.: Keller/Garage). 	<ul style="list-style-type: none"> » Die Maschine mindestens 1 Stunde lang in einem angemessenen Raum lassen. Danach die Maschine an der Steckdose anschließen und versuchen, sie einzuschalten. <p>SOLLTE DAS PROBLEM WEITERHIN BESTEHEN, DEN LAVAZZA-KUNDENDIENST KONTAKTIEREN.</p>

Vorgefundenes Problem	Mögliche Ursache	Lösung
Laute Maschine.	<ul style="list-style-type: none"> » Instabile Auflageebene. » Stromkabel schlecht positioniert. » Bewegliche Teile nicht korrekt eingesetzt. » Kein Wasser im Tank. » Kapsel nicht vorhanden. 	<ul style="list-style-type: none"> » Die Auflageebene überprüfen. » Die korrekte Positionierung des Kabels in der Basis der Maschine überprüfen. » Die beweglichen Teile korrekt einsetzen. » Frisches Trinkwasser nachfüllen. » Eine Lavazza-Kapsel A MODO MIO oder kompatible Kapsel einlegen. <p>SOLLTE DAS PROBLEM WEITERHIN BESTEHEN, DEN LAVAZZA-KUNDENDIENST KONTAKTIEREN.</p>
Die einsatzbereite Maschine erfasst nicht den Tastendruck.	<ul style="list-style-type: none"> » Tastendruck/Aktivierung falsch. » Behälter für verbrauchte Kapseln nicht eingesetzt. 	<ul style="list-style-type: none"> » Eine der Leuchttasten mit der Fingerkuppe drücken, und die Anwesenheit des akustischen Signals (sofern aktiviert) und das korrekte Blinken des ausgewählten Symbols prüfen. » Den korrekten Einsatz des Behälters mit darauf folgender Ausschaltung der Alarmleuchte prüfen. Die Ausgabe prüfen. <p>SOLLTE DAS PROBLEM WEITERHIN BESTEHEN, DEN LAVAZZA-KUNDENDIENST KONTAKTIEREN.</p>
Der Hebel bleibt nach der Ausgabe geschlossen.	<ul style="list-style-type: none"> » Behälter der verbrauchten Kapseln voll. 	<ul style="list-style-type: none"> » Den Behälter entleeren und versuchen, den Hebel zu öffnen. <p>SOLLTE DAS PROBLEM WEITERHIN BESTEHEN, DEN LAVAZZA-KUNDENDIENST KONTAKTIEREN.</p>

Vorgefundenes Problem	Mögliche Ursache	Lösung
Es erfolgt keine Ausgabe der Maschine (sie schaltet sich ein, gibt aber weder Kaffee noch Wasser aus).	<ul style="list-style-type: none"> » Kein Wasser im Tank. » Tank nicht korrekt eingesetzt. » Kapselladehebel angehoben oder nicht korrekt abgesenkt. » Kein Wasserdurchfluss im Wasserkreislauf (keine Füllung). » Kapsel nicht geeignet. » Kalk vorhanden. 	<ul style="list-style-type: none"> » Frisches Trinkwasser im Tank nachfüllen, und die korrekte Ausgabe prüfen. » Den Tank korrekt einsetzen, und die korrekte Ausgabe prüfen. » Den Kapselladehebel bis zum Anschlag absenken, und die korrekte Ausgabe prüfen. » Das Stromkabel abziehen, 10 Sekunden warten, und das Kabel wieder anschließen. Die Maschine einschalten, und das Ende der Erhitzung abwarten. Die korrekte Ausgabe prüfen (die Maschine führt automatisch Befüllungsversuche des Kreislaufs aus. » Mit einer anderen Kapsel aus einem anderen Behälter versuchen. » Die Entkalkung der Maschine mit dem Entkalkungsmittel Lavazza ausführen. <p>SOLLTE DAS PROBLEM WEITERHIN BESTEHEN, DEN LAVAZZA-KUNDENDIENST KONTAKTIEREN.</p>
Die Maschine verliert Wasser.	<ul style="list-style-type: none"> » Beschädigter Tank. » Behälter für verbrauchte Kapseln voll. » Kapsel eingeklemmt. » Kapsel nicht geeignet. 	<ul style="list-style-type: none"> » Den Tank auf Lecks überprüfen, indem dieser von der Maschine getrennt gehalten wird. » Den Behälter für verbrauchte Kapseln leeren. » Den Hebel öffnen und schließen, damit die Kapsel herunterfällt. Den Kapselbehälter herausziehen und entleeren. » Geeignete Kapseln verwenden (Lavazza-Kapsel A MODO MIO oder compatible Kapseln). <p>SOLLTE DAS PROBLEM WEITERHIN BESTEHEN, DEN LAVAZZA-KUNDENDIENST KONTAKTIEREN.</p>

Vorgefundenes Problem	Mögliche Ursache	Lösung
Taste on/off blinkt rot.	» Lieferungsbedingungen der Maschine nicht angemessen/ Vorübergehende Blockierung.	» Den Stecker der Maschine aus der Steckdose ziehen. Die Maschine für einen ausreichenden Zeitraum (maximal 1 Stunde) bei Raumtemperatur lassen. Die Maschine wieder an der Steckdose anschließen, und die Einschalttaste drücken. (Nur einmal versuchen). SOLLTE DAS PROBLEM WEITERHIN BESTEHEN, DEN LAVAZZA-KUNDENDIENST KONTAKTIEREN.
Der Ladehebel erreicht nicht die Ausgabeposition oder erfordert eine exzessive Schließkraft.	» Behälter für verbrauchte Kapseln voll. » Kapsel eingeklemmt.	» Den Behälter entleeren und versuchen, den Hebel zu schließen. » Den Hebel öffnen und schließen, damit die Kapsel herunterfällt. SOLLTE DAS PROBLEM WEITERHIN BESTEHEN, DEN LAVAZZA-KUNDENDIENST KONTAKTIEREN.
Der Kaffee wird zu schnell ausgegeben und ist nicht besonders cremig.	» Gebrauch einer schon verwendeten Kapsel. » Kapsel nicht eingesetzt. » Kapsel nicht geeignet.	» Eine neue Kapsel verwenden. » Die Kapsel einsetzen. » Mit einer anderen Kapsel aus einem anderen Behälter versuchen. SOLLTE DAS PROBLEM WEITERHIN BESTEHEN, DEN LAVAZZA-KUNDENDIENST KONTAKTIEREN.
Der Kaffee ist kalt.	» Langsame Ausgabe bei durch Kalk verstopftem Kreislauf.	» Die Entkalkung der Maschine mit dem Entkalkungsmittel Lavazza ausführen. SOLLTE DAS PROBLEM WEITERHIN BESTEHEN, DEN LAVAZZA-KUNDENDIENST KONTAKTIEREN.

Vorgefundenes Problem	Mögliche Ursache	Lösung
Die Maschine gibt keinen Ton aus.	» Akustisches Signal deaktiviert.	» Die Maschine in Standby versetzen, und danach gleichzeitig und anhaltend die Ausgabebasten Expressokaffee und Langer Kaffee mindestens 5 Sekunden lang drücken. (siehe VORBEREITUNG DER MASCHINE). SOLLTE DAS PROBLEM WEITERHIN BESTEHEN, DEN LAVAZZA-KUNDENDIENST KONTAKTIEREN.
Der Kaffee tritt langsam und tröpfelnd aus.	» Verwendung einer nicht angemessenen Kapsel. » Gebrauch einer schon verwendeten Kapsel. » Ausgießer verstopft. » Wasserkreislauf durch Kalk verstopft.	» Mit einer anderen Kapsel aus einem anderen Behälter versuchen. » Entfernen Sie die gebrauchte Kapsel und verwenden Sie eine neue Kapsel. » Den Zyklus der Kaffeeabgabereinigung durchführen (siehe WARTUNG UND REINIGUNG). » Die Entkalkung der Maschine mit dem Entkalkungsmittel Lavazza ausführen. SOLLTE DAS PROBLEM WEITERHIN BESTEHEN, DEN LAVAZZA-KUNDENDIENST KONTAKTIEREN.

Für beliebige Probleme, die in den oben genannten Fällen nicht aufgeführt sind, den Lavazza-Kundendienst kontaktieren.

TECHNISCHE EIGENSCHAFTEN

- Spannung: 220-240V / 50-60Hz
- Gesamtleistung: 1500W
- Ausmaße: Höhe Breite Tiefe
 280 mm 145 mm 380 mm
- Gewicht: 4 kg
- Behälterkapazität ausziehbar: 1,1 L
- Für die Außenstruktur verwendete Materialien: Thermoplast
- Kabellänge: 0,8 m

⚠ Uso previsto:

Este aparato está destinado para ser utilizado en aplicaciones domésticas y similares, como:

- zonas para cocinar reservadas al personal en las tiendas, en las oficinas y en otros ambientes profesionales;
- granjas;
- hoteles, moteles y otros ambientes con carácter residencial, para ser utilizado por los clientes;
- ambientes tipo “Bed and Breakfast.

Se prohíbe cualquier modificación técnica y cualquier uso indebido a causa de los riesgos que conllevan.

El aparato puede ser utilizado por niños de edad no inferior a 8 años y por personas con capacidades físicas, sensoriales o mentales limitadas, sin experiencia o cuyos conocimientos son insuficientes, siempre que estén bajo la supervisión de un adulto o bien después de haber recibido las instrucciones necesarias para utilizar en condiciones seguras el aparato y estar enterados de los peligros que el uso del mismo conlleva. Los niños no deben jugar con el aparato. La limpieza y el mantenimiento son operaciones a cargo del usuario y no deberán ser realizadas por niños sin la supervisión de una persona adulta.

⚠ Ubicación:

Sitúe la máquina de café en un lugar seguro, donde nadie pueda volcarla ni resultar herido. No coloque la máquina en lugares con una temperatura inferior a 5°C, ya que el hielo podría estropearla.

No utilice la máquina de café a la intemperie. No instale la máquina sobre superficies muy calientes y/o cerca de fuentes de calor. La máquina de café cuando está en uso, no se debe colocar en un armario.

⚠ Alimentación eléctrica:

Conecte la máquina de café únicamente a una toma de corriente apropiada. La tensión debe corresponderse con la indicada en la placa de datos técnicos de la máquina.

 **Cable de alimentación:**

No utilice la máquina de café si el cable de alimentación es defectuoso. Si el cable de alimentación está dañado, debe ser sustituido por el fabricante, por el servicio de asistencia técnica, para evitar cualquier riesgo. No dejar que el cable de alimentación pase por esquinas o aristas cortantes o sobre objetos muy calientes. No transportar o tirar de la máquina de café sujetándola por el cable. No desconectar la clavija tirando del cable; no tocarla con las manos mojadas. Evitar que el cable de alimentación caiga libremente desde mesas o estanterías.

 **Peligro de electrocución:**

No permitir que las partes sujetas a tensión eléctrica entren en contacto con el agua. No sumergir este aparato en el agua.

 **Proteger a los niños menores de 8 años de edad:**

Vigile a los niños para evitar que jueguen con el aparato. Los niños no se dan cuenta del peligro que entrañan los electrodomésticos. No deje a su alcance los materiales utilizados para embalar la máquina.

 **Peligro de quemaduras:**

No toque las piezas calientes (porta cápsulas, etc.) justo después de utilizar el aparato. Durante la preparación del café, tenga cuidado con las posibles salpicaduras de líquido caliente.

 **Limpieza:**

Antes de limpiar la máquina, es indispensable que desconecte la clavija de la toma de corriente y que espere a que la máquina se enfríe. ¡No sumerja la máquina en agua! Está totalmente prohibido manipular el interior de la máquina. Cambiar el agua en el depósito después de 3 días de no utilizar la máquina de café. Para no dañar el aparato durante la limpieza, no utilizar detergentes alcalinos sino un paño suave y un detergente delicado.

 **Almacenamiento de la máquina:**

Cuando la máquina permanezca en desuso durante un periodo de tiempo prolongado, desconecte la clavija de la toma de corriente y guárdela en un lugar seco al que los niños no puedan acceder. Protéjala del polvo y la suciedad.

 **Reparaciones/mantenimiento:**

En caso de averías, defectos o sospecha de avería después de una caída, desconecte inmediatamente la clavija de la toma de corriente. No utilice una máquina defectuosa. Solo los Centros de Asistencia Técnica autorizados pueden manipular la máquina y repararla. En caso de que se manipule la máquina en centros no autorizados, se declina cualquier responsabilidad por los posibles daños que puedan producirse.

 **Depósito de agua:**

Vierta en el depósito únicamente agua fresca potable sin gas. No ponga en marcha la máquina si no hay suficiente agua en el depósito.

 **Ranura para la inserción de cápsulas:**

En la ranura para la inserción de cápsulas se deben colocar únicamente cápsulas Lavazza **A MODO MIO** o compatibles; evitando introducir los dedos o cualquier otro objeto. Las cápsulas son descartables y se usan una sola vez.

 **Eliminación de la máquina al final de su vida útil:**

INFORMACIÓN PARA LOS USUARIOS: el símbolo del cubo de la basura tachado presente en el aparato y/o en el embalaje del mismo indica que el producto al final de su vida útil, deberá ser eliminado de modo diferente a los demás residuos normales. Por lo tanto, una vez finalizada la vida útil, la máquina se deberá llevar a un centro de recogida diferenciada específico para residuos eléctricos y electrónicos. La recogida diferenciada adecuada del aparato fuera de servicio para su posterior reciclaje, tratamiento y eliminación ambientalmente compatible, contribuye a evitar posibles efectos nocivos sobre el medioambiente y sobre la salud, y favorece la reutilización y/o el reciclaje de los materiales que componen la máquina. La eliminación abusiva del producto por parte del usuario conlleva a sanciones administrativas previstas por la normativa vigente.

CONTENIDO DE LA CAJA *

- Máquina IDOLA
- Kit de bienvenida compuesto por 9 cápsulas surtidas Lavazza **A MODO MIO** y manual Lavazza **A MODO MIO**
- Manual de instrucciones
- Guía
- Hoja de la garantía

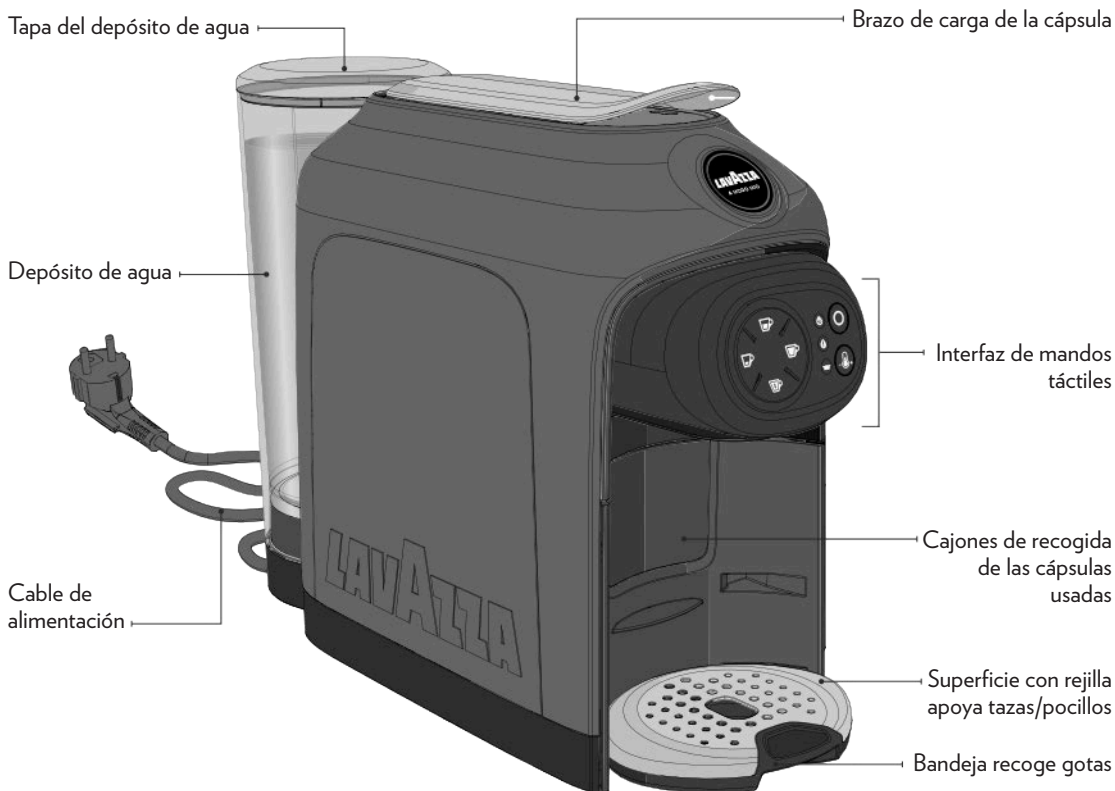

* Las características y el contenido pueden variar en función del mercado de referencia





INTERFAZ DE MANDOS TÁCTILES

- | | |
|--|--|
| 1 Botón erogación EXPRESO | 6 Testigo falta de agua |
| 2 Botón erogación EXPRESO LARGO | 7 Testigo cajón de recogida de cápsulas |
| 3 Botón erogación CAFÉ LARGO | 8 Botón On / Stand-by |
| 4 Botón erogación DOSIS LIBRE | 9 Botón Boost TEMPERATURA |
| 5 Testigo de descalcificación | |

ESTADO INTERFAZ							
Stand-by							
Encendido							
Calentamiento							
Máquina lista (en temperatura)							
Erogación expreso (botón 1)							
Erogación expreso largo (botón 2)							
Erogación café largo (botón 3)							
Erogación dosis libre (botón 4)							
Falta de agua en el depósito							

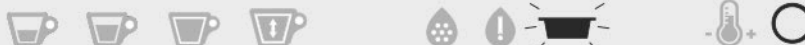
ESTADO INTERFAZ

Cajón recoge cápsulas usadas lleno Cajón recoge cápsulas ausente o en posición incorrecta 

Pedido de descalcificación

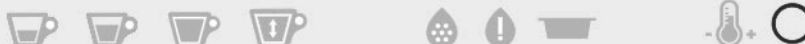
Bloqueo máquina 

Rojo

 = Apagado
  = Encendido
  = Intermitente
  = Feedback acústico

- !** No somos responsables de ningún daño en caso de:
- el uso incorrecto y otros usos diferentes de los fines previstos;
 - las reparaciones no realizadas en los centros autorizados de servicio;
 - alteración del cable de alimentación;
 - alteración a cualquier parte de la máquina;
 - el uso de repuestos y accesorios que no sean los originales;
 - falta de descalcificación;
 - almacenamiento en locales por debajo de 4 °C;
 - uso por debajo de 5 °C;
 - uso por encima de 40 °C;
 - utilización en lugares con una humedad relativa superior al 95%;
 - uso de las cápsulas no compatibles.

En estos casos se cancela la garantía.

PUESTA EN MARCHA DE LA MÁQUINA

- !** Coloque la máquina en una superficie plana y estable, alejada del agua y de fuentes de calor. Los daños causados a la máquina a causa del incumplimiento de estas indicaciones no quedan cubiertos por la garantía.

- 1** Levante y quite la tapa del depósito de agua. A continuación, extraiga el depósito.
- 2** Enjuagar el depósito antes de utilizarlo.
- 3** Llene el depósito de agua hasta el nivel MÁX. indicado. Utilice únicamente agua potable fresca sin gas. Montar nuevamente el depósito y cerrar con la tapa.

i Se puede levantar la tapa para llenar el depósito directamente.

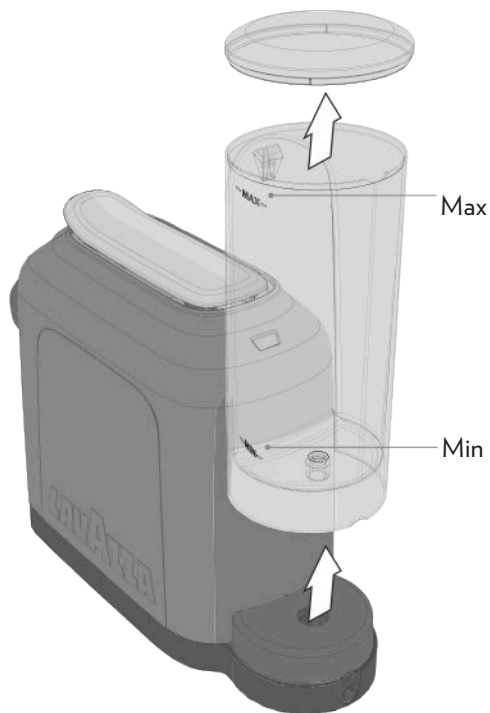

- !** El nivel del agua nunca debe exceder la indicación MÁX. Utilizar exclusivamente agua fresca potable sin gas. El uso de agua caliente y otros líquidos podría dañar el depósito y la máquina. No ponga en marcha la cafetera sin agua: asegurarse de que haya una cantidad suficiente dentro del depósito.

- !** Asegúrese de que las manos, la máquina, el cable y la superficie de apoyo de la máquina no estén mojados.

- 4** Introduzca la clavija del cable de alimentación en la toma de corriente.

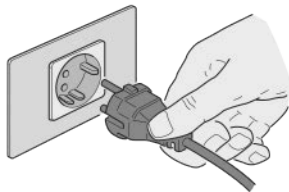

- 5** Presionar el pulsador On/Stand-by  para encender la máquina. La máquina emitirá una señal acústica. Todos los botones se encienden con luz fija blanca y los testigos de alarma, con luz fija anaranjada por un instante.



- 6** La máquina inicia el ciclo de calentamiento. El pulsador On/Stand-by  comienza a parpadear con luz de color blanco.

- 7** La máquina está lista cuando el botón On/Stand-by  deja de parpadear y los botones de suministro se encienden con luz fija.

i Presionando uno de los botones de erogación durante el ciclo de calentamiento, es posible seleccionar la bebida que se suministrará al finalizar dicho ciclo.

- 8** En el primer encendido, erogar 0,5 litro de agua sin cápsula, manteniendo la palanca baja. Colocar una taza grande debajo de la boquilla de suministro.

- 9** Presionar el botón DOSIS LIBRE  y aguardar a que finalice el suministro.

i Abrir y cerrar la perilla antes de girar y vaciar la taza.

- 10** Vaciar la taza y realizar una segunda erogación, presionando nuevamente el botón DOSIS LIBRE .



! Cuando se selecciona una erogación, la máquina activa la electro-bomba del agua por 7 segundos.



Si hay agua dentro del circuito hidráulico, la máquina realiza la erogación normalmente.

Si no hay agua en el circuito hidráulico, la máquina interrumpe el suministro por 5 segundos y vuelve a intentar realizar la erogación por un máximo de 5 veces.

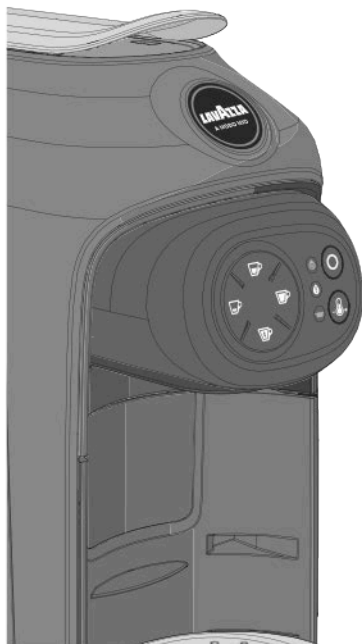
Tras superarse los 5 intentos, la máquina encenderá el testigo de falta de agua **i** con luz fija naranja, para indicar la falta de agua, y emitirá una señal acústica.



ACTIVACIÓN/DES-ACTIVACIÓN SEÑAL ACÚSTICA



- 1** Colocar la máquina en modalidad de espera.
- 2** Presionar y mantener presionados, simultáneamente, los botones de erogación EXPRESO  y CAFÉ LARGO  durante al menos 5 segundos.

i La máquina emitirá una señal acústica prolongada para indicar que se ha deshabilitado la señal acústica. Dos señales acústicas breves indican la activación.

- 3** Al finalizar el procedimiento, la máquina vuelve al modo stand-by.

FUNCIÓN DE ESPERA

i Para garantizar el ahorro energético, tras 9 minutos de desuso la máquina pasará automáticamente a la **Modalidad de espera**. La máquina también se puede poner en **Modalidad de espera** manualmente, antes de los 9 minutos, presionando el botón , la máquina emitirá una señal acústica.

En **Modalidad de espera**, los botones se apagan y el botón **On/Stand-by**  se enciende con luz más tenue. Presionando nuevamente el botón  se puede reactivar la máquina.

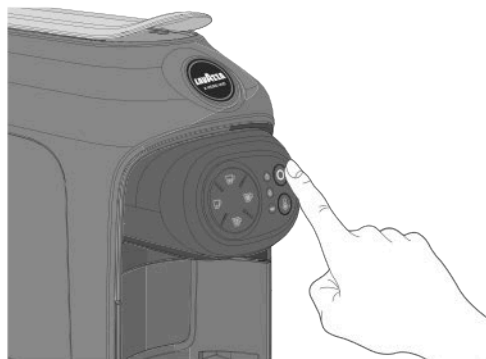

PASOS PARA LA PREPARACIÓN DEL CAFÉ

La máquina cuenta con dos posiciones para la preparación de café: taza/taza grande.

- 1** Para utilizar una taza de café expreso: extraer la superficie apoya tazas/pocillos.



- 2** Montar la superficie apoya tazas en la ranura superior correspondiente.

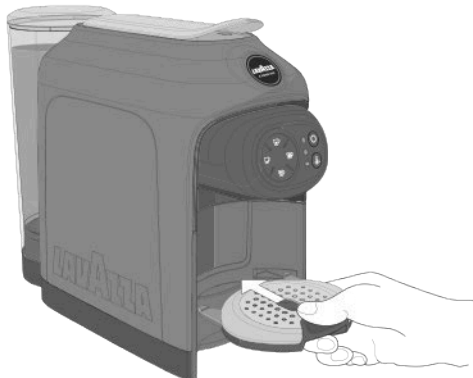

- 3** Apoyar el pocillo en la superficie.



- 4** Para utilizar la taza grande, apoyar la taza o el vaso directamente en la superficie inferior.



EROGACIÓN EXPRESO / EXPRESO LARGO

i Asegurarse de que los pulsadores de erogación de café estén encendidos con luz fija blanca.

1 Coloque el recipiente / vaso de café como se muestra (ver PASOS PARA LA PREPARACIÓN DEL CAFÉ).

2 Levantar la palanca de carga de cápsulas hasta que se bloquee para abrir el compartimento de introducción de cápsulas.

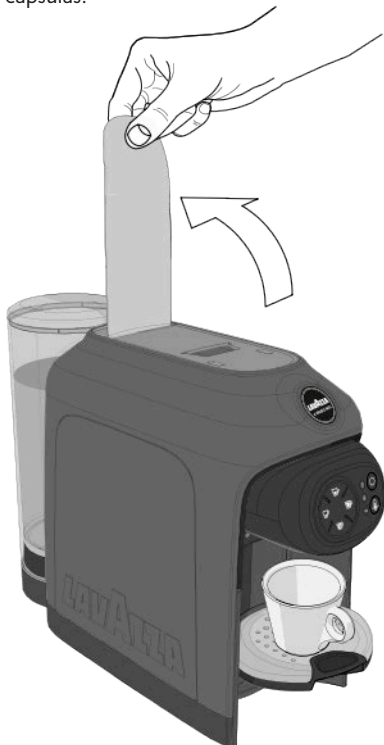

! No introduzca los dedos u otros objetos en el porta cápsulas. En el compartimento de las cápsulas se deben colocar únicamente cápsulas Lavazza **A MODO MIO** o compatibles. Las cápsulas mono-dosis han sido diseñadas para ofrecer un único café/bebida. **NO** reutilice las cápsulas tras su uso. La inserción de 2 o más cápsulas a la vez provocará el mal funcionamiento de la máquina.

3 Introducir una cápsula Lavazza **A MODO MIO** en el compartimento de introducción de cápsulas.



- 4** Bajar la palanca de carga de cápsulas para cerrar el compartimento de introducción de cápsulas.



- i** Si se desea un café más caliente, se puede aumentar la temperatura de la bebida presionando el botón Boost TEMPERATURA . Al presionarse el botón, la máquina emite una señal acústica y aumenta la intensidad de iluminación del botón.



- i** Si se desea volver a la temperatura estándar, presionar nuevamente el botón Boost TEMPERATURA . Al presionarse el botón, la máquina emite una señal acústica y disminuye la intensidad de iluminación del botón.

- !** No es posible modificar la temperatura durante la erogación.

- 5** Para iniciar una erogación: presionar el botón EXPRESO ☕ (30 ml) o presionar el botón EXPRESO LARGO ☕ (45 ml).

La máquina termina automáticamente la erogación cuando alcanza la dosis de café programada.



- i** Durante el suministro, el pulsador seleccionado de suministro está encendido con luz blanca intermitente. Es posible interrumpir la erogación, presionando nuevamente el respectivo botón.

- !** Si durante el ciclo de suministro se interrumpe la alimentación eléctrica proceder como se indica a continuación:

- Restablecer la alimentación eléctrica.
- Presionar el pulsador On/Stand-by; aguardar a que se encienda con luz fija blanca.
- Sustituir la cápsula dentro del compartimiento de introducción de cápsulas con una nueva.
- Comenzar nuevamente con los procedimientos de suministro de café.

- !** Si durante el ciclo de suministro se agota el agua dentro del depósito, proceder como se indica a continuación:

- Llenar el depósito de agua hasta el nivel MÁX indicado.
- Sustituir la cápsula dentro del compartimiento de introducción de cápsulas con una nueva.
- Comenzar nuevamente con los procedimientos de suministro de café.

- !** Dispensando sin cápsula, las dosis pueden no respetar la cantidad programada.

- 6** Al finalizar la erogación, levantar y bajar la palanca de carga de las cápsulas para descargar la cápsula utilizada.

- 7** Para una nueva erogación, esperar hasta que los botones de erogación y el botón On/stand-by estén encendidas con luz fija blanca.

EROGACIÓN CAFÉ LARGO

! Llevar a cabo los pasos: **1**, **2**, **3** y **4** del párrafo EROGACIÓN EXPRESO.

5 Presionar el botón CAFÉ LARGO  (90 ml) para empezar la erogación. La máquina termina automáticamente la erogación cuando alcanza la dosis de café programada.



i Durante el suministro, el pulsador seleccionado de suministro está encendido con luz blanca intermitente. Es posible interrumpir la erogación, presionando nuevamente el respectivo botón.

6 Al finalizar la erogación, levantar y bajar la palanca de carga de las cápsulas para descargar la cápsula utilizada.

7 Para una nueva erogación, esperar hasta que los botones de erogación y el botón On/stand-by estén encendidas con luz fija blanca.

EROGACIÓN DOSIS LIBRE

! Llevar a cabo los pasos: **1**, **2**, **3** y **4** del párrafo EROGACIÓN EXPRESO.

i En el caso de cápsulas solubles, para disfrutar mejor el producto, se aconseja un breve suministro en vacío (solo con agua) antes de introducir la cápsula.

5 Presionar el botón DOSIS LIBRE  para empezar la erogación. La máquina termina automáticamente la erogación cuando alcanza la dosis de café programada.



i Durante el suministro, el pulsador seleccionado de suministro está encendido con luz blanca intermitente. Es posible interrumpir la erogación, presionando nuevamente el respectivo botón.

6 Al finalizar la erogación, levantar y bajar la palanca de carga de las cápsulas para descargar la cápsula utilizada.

7 Para una nueva erogación, esperar hasta que los botones de erogación y el botón On/stand-by estén encendidas con luz fija blanca.

LIMPIEZA DE LA MÁQUINA

! Nunca utilice disolventes, alcohol, sustancias agresivas u hornos para secar los componentes de la máquina. Lave los componentes (excepto los eléctricos) con agua fría/templada y paños o esponjas no abrasivos.

Todos los componentes desmontables pueden lavarse en lavavajillas.

No dejar el agua en el circuito o en el depósito durante más de 3 días. En caso contrario vaciar, enjuagar y llenar nuevamente el depósito con agua fresca y luego efectuar una erogación (sin cápsula) antes de preparar el café o una bebida.

LIMPIEZA DEL SURTIDOR DE CAFÉ

Para limpiar el surtidor de café, realice una vez por semana la operación de SUMINISTRO DE CAFÉ sin introducir ninguna cápsula.



LIMPIEZA BANDEJA RECOGE GOTAS Y CAJÓN RECOGE CÁPSULAS USADAS

i *El encendido del testigo del cajón de recogida de cápsulas  significa que este está lleno de cápsulas usadas y que es necesario vaciarlo y volver a colocarlo.*

1 Extraer la bandeja recoge gotas y el cajón recoge cápsulas usadas.

i *La máquina emite una señal acústica para indicar la extracción del cajón recoge cápsulas.*



i *Extrañdo el cajón durante más de 5 segundos, la máquina reajusta el cálculo de las cápsulas introducidas.*

- 2** Retirar la bandeja recoge gotas y el cajón recoge cápsulas usadas. Vaciar las cápsulas usadas y los líquidos presentes en el cajón recoge gotas.

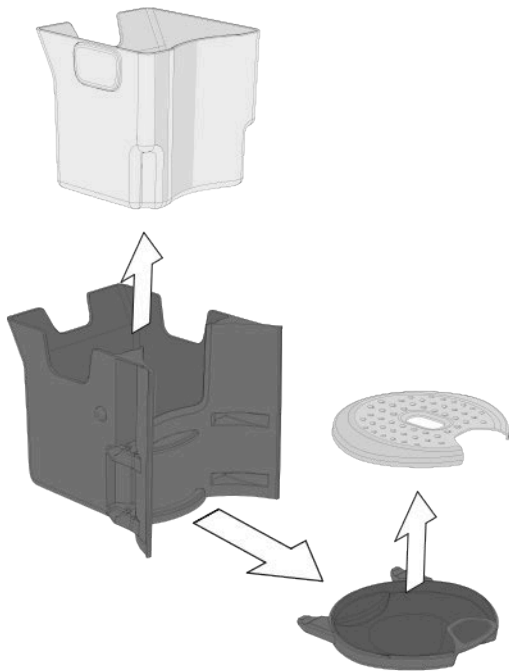

- 3** Lavar todos los componentes con agua fría o tibia, secarlos o en lavaplatos. Secarlos y montarlos correctamente.

i Controlar periódicamente que la bandeja recoge gotas no esté llena a fin de evitar pérdidas de líquido.

DESCALCIFICACIÓN

- !** Leer atentamente las instrucciones para la descalcificación.

La formación de cal es una consecuencia normal del uso de la máquina. Es necesario realizar una descalcificación después de cada 2 o 3 meses de uso de la máquina o cuando se observa una reducción del caudal de agua.

El ciclo de descalcificación es requerido por la máquina a través del encendido del testigo de indicación correspondiente .

- !** No apagar la máquina durante el ciclo de descalcificación. No dejar la máquina sin vigilancia durante el ciclo de descalcificación. Una vez iniciado, el ciclo debe continuarse hasta su finalización.

- !** Verificar que el interior del compartimiento de introducción de cápsulas esté vacío.

- 1** Extraiga y vacíe el depósito del agua.

- !** No ingiera la solución descalcificante o el líquido que brote del surtidor hasta que se haya completado el ciclo. No utilice en ningún caso vinagre como descalcificante.

i Para llevar a cabo la descalcificación, se recomienda utilizar el producto **DESCALCIFICANTE LAVAZZA**.

- 2** Llenar el depósito con el contenido del **DESCALCIFICANTE LAVAZZA** (250 ml) y agua (250 ml). Volver a montar el depósito en la máquina.



- i** Limpiar eventuales salpicaduras o gotas con un paño húmedo.

- 3** Colocar debajo de la boquilla de suministro un recipiente con una capacidad superior a 0,5 litros.

- 4** Conectar la máquina a la red eléctrica sin encenderla.

- 5** Presionar y mantener presionados, simultáneamente, los botones de erogación **EXPRESO** ☕ y **EXPRESO LARGO** ☕ durante al menos 5 segundos.





- i** La máquina emite una señal acústica prolongada y se encienden con luz fija los botones: **On/Stand-by** Ⓞ, **DOSIS LIBRE** ☕ y el testigo de descalcificación ☘.

- 6** Presionar el botón **DOSIS LIBRE** ☕ para activar el ciclo de descalcificación.



- !** Si el botón **DOSIS LIBRE** ☕ no se presiona dentro de los 9 minutos de emitida la señal acústica, la máquina volverá a la modalidad de stand-by y será necesario repetir el paso **6** del procedimiento, para iniciar el ciclo.

- 7** La máquina comienza la fase de calentamiento y el botón DOSIS LIBRE  comienza a parpadear.
- 8** La máquina comenzará automáticamente la descalcificación tras concluir el ciclo de calentamiento.





i Durante el ciclo de descalcificación, el botón DOSIS LIBRE  se enciende con luz intermitente y el testigo de descalcificación  se enciende con luz fija.



! Durante el ciclo de descalcificación, la máquina efectúa automáticamente ciclos de erogación intermitentes para permitir que el contenedor se vacíe.

i Es posible suspender momentáneamente el ciclo de descalcificación presionando el botón DOSIS LIBRE  o el botón On/Stand-by . Para continuar el ciclo, presionar el botón DOSIS LIBRE .

- 9** Cuando la máquina agota el líquido en el depósito, el ciclo se suspende momentáneamente. Vaciar el contenedor utilizado para recoger la solución.

i Botón On/stand-by , DOSIS LIBRE  y testigo de falta de agua  se encienden con luz fija. Testigo de descalcificación  se enciende con luz intermitente.

- 10** Retirar el depósito de agua, enjuagarlo y lavarlo cuidadosamente. Llenarlo con agua fresca potable sin gas hasta el nivel MÁX.

! En caso de interrupción de la alimentación, la máquina en el primer encendido solicitará el ciclo de enjuague.



- 11** Introducir el depósito con el agua. Colocar debajo de la boquilla de suministro un recipiente con una capacidad superior a 0,5 litros.

- 12** Presionar el botón DOSIS LIBRE  para activar el ciclo de enjuague.

i Para terminar el ciclo de enjuague, se debe suministrar una cantidad mínima de agua. En caso de falta de agua, el ciclo se interrumpe momentáneamente; la máquina emite una señal acústica prolongada y se enciende con luz fija el testigo de falta de agua . Rellenar el depósito.

- 13** Al finalizar la erogación, limpiar la máquina con un paño suave y húmedo.

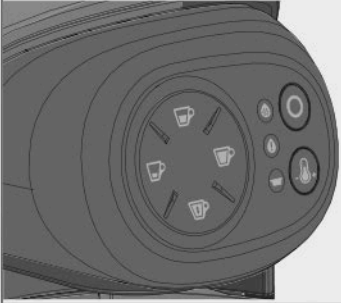
Al finalizar la limpieza, el proceso de descalcificación se completa. La máquina está lista para el uso.

Problema encontrados	Posibles causas	Solución
<p>La máquina no se enciende. Testigo On/Stand-by apagado.</p> 	<ul style="list-style-type: none"> » La máquina no está conectada a la red eléctrica. » La máquina está conectada a una toma múltiple o a una regleta que no funcionan. » Alimentación no presente en la red eléctrica/doméstica. 	<ul style="list-style-type: none"> » Conecte la máquina a la red eléctrica. » Conecte la máquina directamente a la red eléctrica. » Asegurarse de contar con corriente eléctrica conectando otro dispositivo eléctrico en la toma de alimentación. <p>SI EL PROBLEMA PERSISTE DIRIGIRSE AL SERVICIO A CLIENTES LAVAZZA.</p>
<p>Al presionar el botón On/Stand-by, la máquina no se enciende.</p> 	<ul style="list-style-type: none"> » Interfaz táctil sin reacción. » Se han presionado simultáneamente 2 botones de manera incorrecta. 	<ul style="list-style-type: none"> » Controlar que la superficie de la interfaz y la mano del usuario estén secas y limpias. » Aguardar algunos segundos y presionar solo el botón On/Stand-by. <p>SI EL PROBLEMA PERSISTE DIRIGIRSE AL SERVICIO A CLIENTES LAVAZZA.</p>
<p>Percepción de tiempo de calentamiento excesivo (mayor a 40 segundos).</p>	<ul style="list-style-type: none"> » Almacenamiento de la máquina en un ambiente demasiado frío (ej.: sótano/garaje). 	<ul style="list-style-type: none"> » Mantener la máquina en un ambiente adecuado por al menos 1 hora. Luego, conectar la máquina a la toma eléctrica e intentar encenderla. <p>SI EL PROBLEMA PERSISTE DIRIGIRSE AL SERVICIO A CLIENTES LAVAZZA.</p>

Problema encontrados	Posibles causas	Solución
La máquina es muy ruidosa.	<ul style="list-style-type: none"> » La máquina no esta en una superficie estable. » Cable eléctrico mal colocado. » Partes móviles colocadas incorrectamente. » Falta agua en el depósito. » Cápsula no introducida. 	<ul style="list-style-type: none"> » Comprobar el plano de apoyo. » Comprobar que el cable esté colocado correctamente en la base de la máquina. » Colocar correctamente las partes móviles. » Rellene el depósito con agua fresca y potable. » Introducir una cápsula Lavazza A MODO MIO o compatible. <p>SI EL PROBLEMA PERSISTE DIRIGIRSE AL SERVICIO A CLIENTES LAVAZZA.</p>
La máquina lista para el uso no detecta que se han presionado los botones.	<ul style="list-style-type: none"> » Presión incorrecta/activación de las teclas. » Cajón recoge cápsulas usadas no introducido. 	<ul style="list-style-type: none"> » Presionar uno de los botones encendidos con la yema de los dedos, y verificar la presencia de la señal acústica (si está habilitada) y que el icono seleccionado parpadee correctamente. » Verificar que el cajón se haya introducido correctamente, con el consiguiente apagado del testigo de alarma. Controlar la erogación. <p>SI EL PROBLEMA PERSISTE DIRIGIRSE AL SERVICIO A CLIENTES LAVAZZA.</p>
La palanca permanece cerrada después de la erogación.	<ul style="list-style-type: none"> » Cajón de las cápsulas usadas lleno. 	<ul style="list-style-type: none"> » Vaciar el cajón e intentar abrir la palanca. <p>SI EL PROBLEMA PERSISTE DIRIGIRSE AL SERVICIO A CLIENTES LAVAZZA.</p>

Problema encontrados	Posibles causas	Solución
<p>La máquina no efectúa el suministro (se enciende pero no suministra ni café ni agua).</p>	<ul style="list-style-type: none"> » Falta agua en el depósito. » Depósito colocado incorrectamente. » Palanca de carga de cápsula levantada o bajada incorrectamente. » Ausencia de flujo de agua en el circuito hidráulico (falta de activación). » Cápsula no apta. » Presencia de sarro. 	<ul style="list-style-type: none"> » Rellenar con agua fresca y potable el depósito y controlar que la erogación sea correcta. » Introducir correctamente el depósito y controlar que la erogación sea correcta. » Bajar la palanca de carga de cápsulas hasta hacer tope y controlar que la erogación sea correcta. » Desconectar el cable de alimentación, aguardar 10 segundos y volver a conectar el cable. Encender la máquina y aguardar a que finalice el calentamiento. Controlar que la erogación sea correcta (la máquina realiza automáticamente intentos para llenar el circuito). » Intentar con otra cápsula procedente de una caja diferente. » Descalcificar la máquina con descalcificante Lavazza. <p>SI EL PROBLEMA PERSISTE DIRIGIRSE AL SERVICIO A CLIENTES LAVAZZA.</p>
<p>La máquina pierde agua</p>	<ul style="list-style-type: none"> » Depósito dañado. » El cajón de las cápsulas usadas está lleno. » Cápsula atascada. » Uso de cápsula no adecuada. 	<ul style="list-style-type: none"> » Comprobar que el depósito no tenga pérdidas cuando está separado de la máquina. » Vacíe el cajón de las cápsulas usadas. » Abrir y cerrar la palanca para hacer caer la cápsula. Extraer el cajón porta-cápsulas y vaciarlo. » Utilizar cápsulas adecuadas (Lavazza A MODO MIO o compatibles). <p>SI EL PROBLEMA PERSISTE DIRIGIRSE AL SERVICIO A CLIENTES LAVAZZA.</p>

Problema encontrados	Posibles causas	Solución
Botón on/off intermitente rojo.	» Condiciones de almacenamiento de la máquina no adecuadas/Bloqueo Temporal.	» Desconectar la clavija de la máquina de la toma de corriente. Dejar la máquina a temperatura ambiente por un período suficiente (máximo 1 hora). Conectar nuevamente la máquina a la toma de corriente y presionar el pulsador de encendido. (intentar una sola vez). SI EL PROBLEMA PERSISTE DIRIGIRSE AL SERVICIO A CLIENTES LAVAZZA.
La palanca de carga no alcanza la posición de suministro o se requiere de fuerza excesiva para cerrarla.	» El cajón de las cápsulas usadas está lleno. » Cápsula atascada.	» Vaciar el cajón e intentar cerrar la palanca. » Abrir y cerrar la palanca para hacer caer la cápsula. SI EL PROBLEMA PERSISTE DIRIGIRSE AL SERVICIO A CLIENTES LAVAZZA.
El café sale demasiado rápido y es poco cremoso.	» Uso de cápsula ya usada. » Cápsula no introducida. » Cápsula no apta.	» Introducir una cápsula nueva. » Introducir la cápsula. » Intentar con otra cápsula procedente de una caja diferente. SI EL PROBLEMA PERSISTE DIRIGIRSE AL SERVICIO A CLIENTES LAVAZZA.
El café está frío.	» Suministro lento con circuito obstruido por sarro.	» Effettuare la decalcificazione con il decalcificante Lavazza. SI EL PROBLEMA PERSISTE DIRIGIRSE AL SERVICIO A CLIENTES LAVAZZA.

Problema encontrados	Posibles causas	Solución
La máquina no emite ningún sonido.	» Señal acústica desactivada.	» Colocar la máquina en stand-by y, luego, mantener presionados, simultáneamente, los botones de erogación Café expreso y Café Largo, por al menos 5 segundos. (véase la sección PREPARACIÓN DE LA MÁQUINA). SI EL PROBLEMA PERSISTE DIRIGIRSE AL SERVICIO A CLIENTES LAVAZZA.
El café sale lentamente a gotas.	» Uso de cápsula no adecuada. » Uso de cápsula ya usada. » Boquilla de suministro obstruida. » Circuito hidráulico obstruido debido al sarro.	» Intentar con otra cápsula procedente de una caja diferente. » Retire la cápsula usada y use una nueva cápsula. » Limpie el surtidor de café (consulte el apartado MANTENIMIENTO Y LIMPIEZA). » Descalcificar la máquina con descalcificante Lavazza. SI EL PROBLEMA PERSISTE DIRIGIRSE AL SERVICIO A CLIENTES LAVAZZA.

En caso de problemas no contemplados en los casos listados anteriormente, dirigirse al Servicio a Clientes Lavazza.

CARACTERÍSTICAS TÉCNICAS

- Fuente de alimentación: 220-240V / 50-60Hz
- Potencia nominal: 1500W
- Dimensiones: Altura Anchura Profundidad
280 mm 145 mm 380 mm
- Peso: 4 kg
- Depósito de agua extraíble: 1,1 L
- Materiales empleados para el cuerpo: Termo-plástico
- Longitud del cable: 0,8 m

⚠ Indicações de uso:

Este aparelho foi projectado para ser utilizado em ambientes domésticos e semelhantes, tais como:

- nas áreas para cozinhar reservadas ao pessoal em lojas, escritórios e em outros ambientes profissionais;
- nas quintas;
- utilização por clientes de hotéis, motéis e outros ambientes de carácter residencial;
- nos ambientes de tipo bed and breakfast.

É proibido realizar modificações técnicas ou efectuar qualquer utilização ilícita, devido aos riscos que tal implica!

A máquina pode ser utilizada por crianças com idade inferior aos 8 anos e por pessoas com capacidades físicas, sensoriais ou mentais reduzidas, ou sem experiência ou conhecimentos necessários, desde que sob vigilância ou depois de as mesmas receberem as instruções relativas à utilização em segurança da máquina e à compreensão dos perigos inerentes à mesma. As crianças nunca devem brincar com a máquina. A limpeza e a manutenção a ser efectuada pelo utilizador não deve ser realizada por crianças sem supervisão.

⚠ Localização:

Instalar a máquina de café num local seguro, onde ninguém se possa magoar ou fazê-la tombar. Não ter a máquina em locais com temperatura inferior a 5°C uma vez que o gelo a pode danificar. Não utilizar a máquina de café ao ar livre.

Não pousar a máquina sobre superfícies muito quentes e/ou na proximidade de chamas livres. A máquina de café quando em uso, não deve ser colocado em um armário.

⚠ Ligação à corrente:

Ligar a máquina de café apenas numa tomada de corrente adequada. A tensão deve corresponder à indicada na placa da máquina.

 **Cabo de corrente:**

Não usar a máquina de café se o cabo de corrente tiver defeito.

Se o cabo de corrente estiver danificado, deve ser substituído pelo fabricante ou pelo seu serviço de assistência técnica, a fim de evitar qualquer risco.

Não faça passar o fio de alimentação por ângulos, em cantos vivos e sobre objectos muito quentes. Não coloque ou puxe a máquina para café segurando-a pelo fio. Não extrair a tomada puxando-a pelo fio; não toca-la com as mãos molhadas. Evite que o fio de alimentação caia livremente de mesas ou prateleiras.

 **Perigo de electrocussão:**

Não faça entrar em contacto com a água as partes submetidas à voltagem eléctrica. Este aparelho não deve ser mergulhado em água.

 **Proteger as crianças com menos de 8 anos de idade:**

Manter as crianças sob vigilância para evitar que brinquem com o aparelho.

As crianças não se dão conta do perigo associado aos electrodomésticos.

Não deixar ao alcance das crianças os materiais utilizados para embalar a máquina.

 **Perigo de queimaduras:**

Não tocar nas partes quentes (grupo porta-cápsulas, etc.) imediatamente após a utilização do aparelho.

Durante a saída da bebida, ter atenção a eventuais salpicos de líquido quente.

 **Limpeza:**

Antes de limpar a máquina, é indispensável desligar a ficha da tomada de corrente e esperar que a máquina arrefeça. Não mergulhar a máquina em água!

É rigorosamente proibido tentar efectuar qualquer intervenção no interior da máquina. Substituir a água no depósito após 3 dias de inutilização.

Para evitar de danificar o aparelho não utilizar detergentes alcalinos para a limpeza, mas utilize um pano macio e um detergente delicado.



Arrumação da máquina:

Quando a máquina não for utilizada durante um período de tempo prolongado, retirar a ficha da tomada e arrumar a máquina num lugar seco e não acessível a crianças. Proteger a máquina do pó e da sujidade.



Reparações/Manutenção:

Em caso de avaria, defeitos ou suspeita de defeitos depois de uma queda, retirar de imediato a ficha da tomada. Não colocar em funcionamento uma máquina com defeito. Apenas os Centros de Assistência Técnica Autorizados podem efectuar intervenções e reparações. Caso ocorram intervenções que não estejam em conformidade com as normas do sector, declina-se qualquer responsabilidade por eventuais danos.



Reservatório de água:

Deitar no reservatório apenas água fria potável, não gaseificada. Não pôr a máquina em funcionamento se não existir água suficiente no reservatório.



Vão de introdução de cápsula:

No vão de introdução de cápsula devem ser introduzidas exclusivamente cápsulas **A MODO MIO** ou compatíveis; não introduza os dedos ou qualquer outro objecto. As cápsulas devem ser utilizadas somente uma vez.



Eliminação da máquina em fim de vida:

INFORMAÇÃO PARA OS USUÁRIOS: o símbolo da lixeira barrada ilustrado no aparelho ou na sua confecção indica que o produto no fim da própria vida útil deve ser coletado separadamente dos outros lixos. O usuário deverá, portanto, entregar o aparelho que chegou no seu fim de vida aos idóneos centros de coleta diferenciada dos lixos eléctricos e electrónicos. Uma apropriada coleta separada para o início subsequente do equipamento em desuso para a reciclagem, ao tratamento e a eliminação ambientalmente compatível contribui em evitar os possíveis efeitos negativos no meio ambiente e na saúde e favorece a reutilização e/a reciclagem dos materiais de cujo é composto o equipamento. A eliminação abusiva do produto pelo usuário comporta a aplicação das sanções administrativas previstas pela normativa vigente.

CONTEÚDO DA EMBALAGEM *

- Máquina IDOLA
- Kit de bem-vindo composto de 9 cápsulas sortidas Lavazza **A MODO MIO** e folhetos Lavazza **A MODO MIO**

- Livro de instruções
- Guia rápido
- Folheto de garantia

Tampa do reservatório de água

Reservatório de água

Cabo de alimentação

Alavanca de carregamento da cápsula

Interface dos comandos touch

Gavetas para cápsulas

Superfície com grade de apoio de xícaras/xícaras de café

Bandeja de coleta de gotas

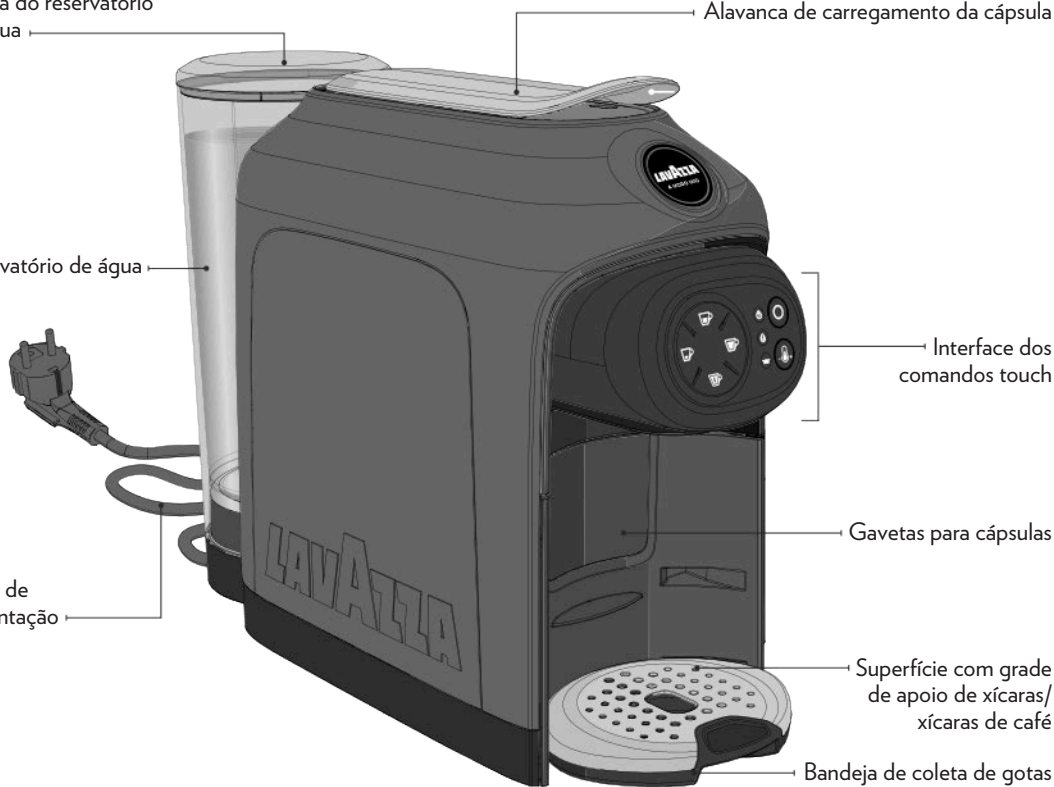

* As características e o conteúdo da confecção podem variar em base ao mercado de referência.



INTERFACE DOS COMANDOS TOUCH

- | | | | |
|----------|-------------------------------------|----------|---|
| 1 | Botão EXPRESSO | 6 | Luz avisadora de falta de água |
| 2 | Botão EXPRESSO LONGO | 7 | Luz sinalizadora da gaveta de recolha de cápsulas |
| 3 | Botão CAFÉ LONGO | 8 | Botão On / Stand-by |
| 4 | Botão DOSE LIVRE | 9 | Tecla Boost TEMPERATURA |
| 5 | Luz sinalizadora de descalcificação | | |

ESTADO INTERFACE							
Stand-by							
							+
Acendimento							
							+
Aquecimento							
							+
Máquina pronta (em temperatura)							
							+
Expresso (botão 1)							
							+
Expresso longo (botão 2)							
							+
Café longo (botão 3)							
							+
Dose livre (botão 4)							
							+
Falta de água no reservatório							
							+

SESTADO INTERFACE							
Gaveta de coleta de cápsulas utilizadas cheia 🔊							
Gaveta de coleta de cápsulas posicionada de modo errado ou ausente 🔊							
Descalcificação solicitada							
Bloqueio da máquina 🔊							Vermelho

= Desligado
 = Ligado
 = Intermitente
 🔊 = Feedback acústico

! Não assumimos qualquer responsabilidade por eventuais danos causados por:

- utilização incorrecta ou não conforme com os fins previstos;
- reparações não efectuadas em centros de assistência autorizados;
- deterioração do cabo de corrente;
- deterioração de qualquer componente da máquina;
- utilização de peças sobresselentes e acessórios não originais;
- falta de descalcificação;
- armazenamento em locais com temperatura inferior a 4°C;
- utilização abaixo de 5°C;
- utilização acima de 40°C;
- utilização em locais com humidade relativa superior a 95%;
- utilização de cápsulas não compatíveis.

Nestes casos, a garantia perde a validade.

ARRANQUE DA MÁQUINA

! Colocar a máquina sobre uma superfície plana, horizontal e estável, afastada da água. Os danos causados na máquina devido ao não cumprimento destas indicações não estão cobertos pela garantia.

1 Levantar e retirar a tampa e, depois, extrair o reservatório de água.

2 Enxague o reservatório antes de utiliza-lo.

3 Encher o reservatório de água até ao nível MAX indicado, usando apenas água fria potável, sem gás. Montar novamente o reservatório e fechar com a tampa.

i A tampa pode ser levantada para abastecer o reservatório directamente.

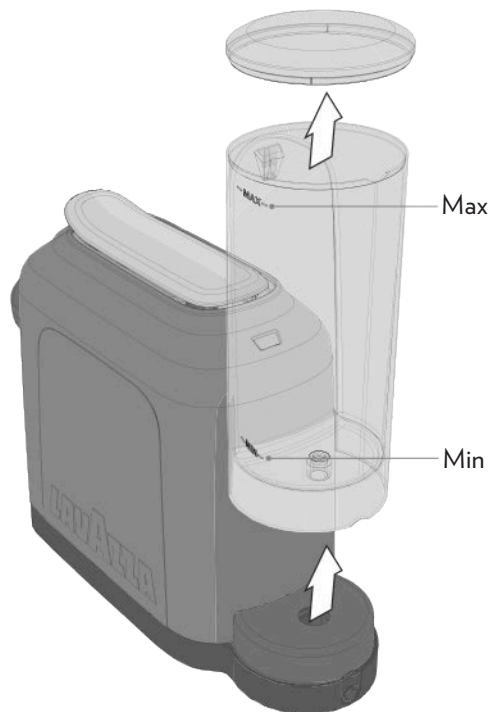

! O nível de água nunca deve exceder a indicação MAX. Utilize exclusivamente água fresca potável sem gás. A água quente e outros líquidos podem danificar o reservatório e a máquina. Não colocar a máquina em funcionamento sem água: certifique-se que exista em suficiência no interno do reservatório.

! Certificar-se de que as suas mãos, a máquina, o cabo e a superfície de suporte da máquina não estão molhadas.

- 4** Introduza a tomada de alimentação na tomada de corrente.

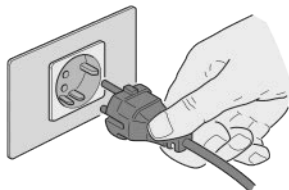

- 5** Pressionar o botão On/Stand-by  para ligar a máquina. A máquina emitirá um sinal acústico. Todas as teclas se acendem com luz fixa branca, as luzes avisadoras de alarme se acendem com luz fixa cor-de-laranja por um instante.



- 6** A máquina inicia o ciclo de aquecimento. O botão On/Stand-by  começa a lampear com luz de cor branca.

- 7** A máquina esta pronta quando a tecla On/Stand-by  termina de piscar e as teclas de fornecimento estão acesas com luz fixa.

- i** *Pressionando um dos botões de fornecimento durante o ciclo de aquecimento é possível reservar a bebida que será fornecida no fim do aquecimento.*

- 8** Ao primeiro arranque fornecer 0,5 litros de água sem cápsula, mantendo a alavanca abaixada. Posicionar uma xícara sob o bico distribuidor.

- 9** Pressionar o botão DOSE LIVRE  e aguardar o fim do fornecimento.

- i** *Abriu e fechar a alavanca antes de remover e esvaziar a xícara.*

- 10** Esvaziar a xícara e efectuar um segundo fornecimento pressionando novamente o botão DOSE LIVRE .



! Quando é seleccionado um fornecimento, a máquina activa a bomba eléctrica da água por 7 segundos.



Se é presente água dentro do circuito hidráulico, a máquina efectua o fornecimento normalmente.

Se não é presente água dentro do circuito hidráulico, a máquina interrompe o fornecimento por 5 segundos e tenta novamente o fornecimento por um máximo de 5 vezes.

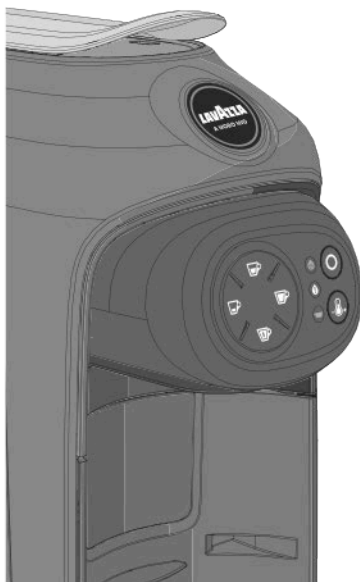

Após superar os 5 tentativos, a máquina acenderá a luz avisadora de falta de água **!** com luz fixa laranja para sinalizar a ausência de água, e emitirá um sinal acústico.



ACTIVAÇÃO/DESACTIVAÇÃO DO SINAL ACÚSTICO

- 1** Coloque a máquina na modalidade de stand-by.
- 2** Pressione e segure pressionada ao mesmo tempo as teclas de fornecimento EXPRESSO  e CAFÉ LONGO  por pelo menos 5 segundos.
- i** A máquina emitirá um longo sinal acústico para sinalizar a desactivação do sinal acústico. Dois sinais acústicos breves para sinalizar a activação.
- 3** Após terminar o procedimento, a máquina retorna na modalidade de stand-by.

FUNÇÕES STAND-BY

- i** Para garantir a poupança de energia, depois de 10 minutos sem uso, a máquina passa automaticamente ao modo de **Stand-by**. É possível colocar a máquina na modalidade de stand-by manualmente, antes dos 9 minutos, pressionando a tecla On/Stand-by , a máquina emitirá um sinal acústico. Na modalidade stand-by as teclas estão apagadas e a tecla On/Stand-by  está acesa com luminosidade reduzida. Pressionando novamente a tecla On/Stand-by  é possível reativar a máquina.

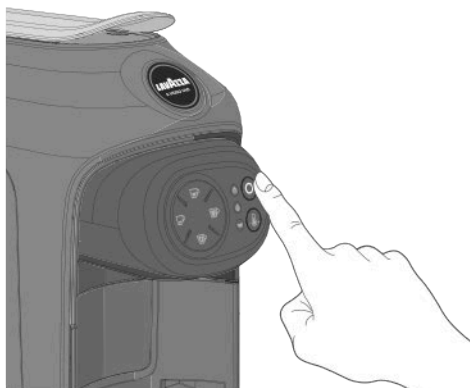

PROCEDIMENTOS ANTES DE PREPARAR UM CAFÉ

A máquina dispõe de duas posições para a preparação do café: xícara/xícara grande.

- 1** Para utilizar uma xícara de café expresso: extrair a superfície de apoio de xícaras/xícaras de café.



- 2** Introduzir a superfície de apoio de xícaras na adequada sede em alto.

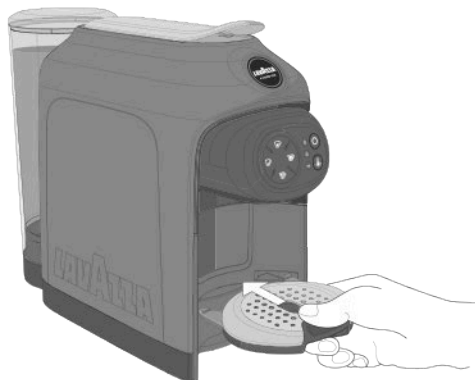

- 3** Apoiar a xícara sobre a superfície.



- 4** Para utilizar uma xícara grande, apoiar a xícara de café ou o copo directamente sobre a superfície em baixo.



EXPRESSO / EXPRESSO LONGO

i Certifique-se que os botões de fornecimento de café estejam acesos com luz fixa branca.

1 Coloque a chávena/chávena de café conforme mostrado (consulte PROCEDIMENTOS ANTES DE PREPARAR UM CAFÉ).

2 Levantar a alavanca de carregamento das cápsulas até ao seu bloqueio para abrir o vão de introdução de cápsulas.

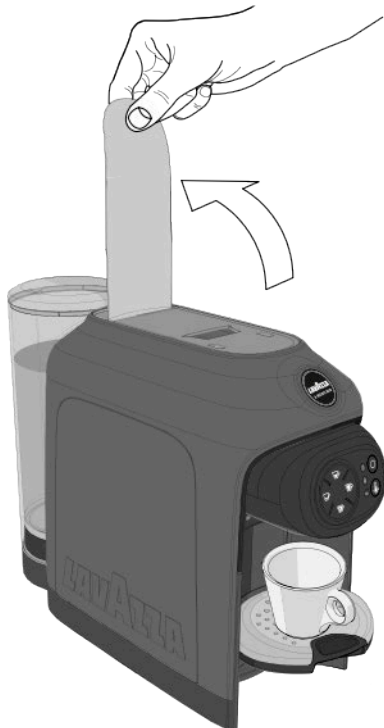

! Nunca coloque os dedos ou objectos no suporte de cápsulas. No vão de introdução de cápsula devem ser introduzidas exclusivamente cápsulas **A MODO MIO** ou compatíveis. As cápsulas monodose estão preparadas para servir apenas um café/produto. **NÃO** reutilizar as cápsulas depois da sua utilização. A inserção de 2 ou mais cápsulas ao mesmo tempo provoca o mau funcionamento da máquina.

3 Introduzir uma cápsula Lavazza **A MODO MIO** no vão de introdução de cápsulas.



- 4** Abaixar a alavanca de carregamento de cápsulas para fechar o vão de introdução de cápsulas.



- i** Quando se deseja um café mais quente, é possível aumentar a temperatura da bebida pressionando a tecla Boost TEMPERATURA . A máquina, ao pressionar da tecla emite um sinal acústico e aumenta a intensidade de iluminação da tecla.



- i** Quando se deseja retornar à temperatura de tipo padrão, pressione novamente a tecla Boost TEMPERATURA . A máquina, ao pressionar da tecla emite um sinal acústico e diminui a intensidade de iluminação da tecla.

- !** Não é possível mudar a temperatura durante o fornecimento.

- 5 Para iniciar um fornecimento:
 premir o botão EXPRESSO ☕ (30 ml) ou
 premir o botão EXPRESSO LONGO ☕ (45 ml).

A máquina termina automaticamente a saída de café uma vez alcançada a dose de café programada.



- i Durante o fornecimento o botão de fornecimento selecionado é aceso com luz intermitente branca. É possível interromper o fornecimento pressionando novamente a tecla de fornecimento.

- ! Se durante o ciclo de fornecimento é interrompida a alimentação elétrica proceder como indicado a seguir:

- Reinicie a alimentação elétrica.
- Pressionar o botão de On/Stand-by; espere que esteja aceso com luz fixa branca.
- Substituir a cápsula dentro do vão de introdução das cápsulas com uma nova.
- Reinicie o procedimento de fornecimento de café.

- ! Se durante o ciclo de fornecimento é termina a água no interno do reservatório proceder como indicado a seguir:

- Encha o reservatório de água até o nível MÁX. indicado.
- Substituir a cápsula dentro do vão de introdução das cápsulas com uma nova.
- Reinicie o procedimento de fornecimento de café.

- ! Distribuindo sem cápsula, as doses podem não respeitar a quantidade programada.

- 6 Ao término do fornecimento, levantar e abaixar a alavanca de carregamento de cápsulas para descarregar a cápsula utilizada.

- 7 Para um novo fornecimento espere que as teclas de fornecimento e a tecla On/stand-by estejam acesas com luz fixa branca.

CAFÉ LONGO

⚠ Executar as etapas: 1, 2, 3 e 4 do parágrafo EXPRESSO.

5 Premir o botão CAFÉ LONGO ☕ (90 ml) para iniciar a tirar o café. A máquina termina automaticamente a saída de café uma vez alcançada a dose de café programada.



i Durante o fornecimento o botão de fornecimento selecionado é aceso com luz intermitente branca. É possível interromper o fornecimento pressionando novamente a tecla de fornecimento.

6 Ao término do fornecimento, levantar e abaixar a alavanca de carregamento de cápsulas para descarregar a cápsula utilizada.

7 Para um novo fornecimento espere que as teclas de fornecimento e a tecla On/stand-by estejam acesas com luz fixa branca.

DOSE LIVRE

⚠ Executar as etapas: 1, 2, 3 e 4 do parágrafo EXPRESSO.

i Em caso de cápsulas solúveis, para melhor saborear o produto, se aconselha um breve fornecimento à vazio (com somente água) antes de introduzir a cápsula.

5 Premir o botão DOSE LIVRE ☕ para iniciar a tirar o café. Assim que for atingida a quantidade de café pretendida, prima o botão novamente para parar a preparação.



i Durante o fornecimento o botão de fornecimento selecionado é aceso com luz intermitente branca. É possível interromper o fornecimento pressionando novamente a tecla de fornecimento.

6 Ao término do fornecimento, levantar e abaixar a alavanca de carregamento de cápsulas para descarregar a cápsula utilizada.

7 Para um novo fornecimento espere que as teclas de fornecimento e a tecla On/stand-by estejam acesas com luz fixa branca.

LIMPEZA DA MÁQUINA

! Nunca utilizar solventes, álcool ou substâncias agressivas ou fornos para secar os componentes da máquina. Lavar os componentes (à excepção dos eléctricos) com água fria/morna e panos/esponjas não abrasivas.

Todos os componentes desmontáveis são laváveis na máquina de lavar louças.

Não deixe a água no circuito e no reservatório por mais de 3 dias, se isto devesse acontecer, esvazie, enxágue e encha novamente o reservatório com água fresca, em seguida, efetue um fornecimento (sem cápsula) antes de fornecer o café ou uma bebida.

LIMPEZA DO BICO DE SAÍDA DE CAFÉ

Para a limpeza do bico de saída, efectuar semanalmente o procedimento SAÍDA DE CAFÉ sem inserir a cápsula.



LIMPEZA DA BANDEJA DE COLETA DE GOTAS E DA GAVETA DE COLETA DE CÁPSULAS UTILIZADAS

i O acendimento da luz avisadora da gaveta de coleta de cápsulas  indica que a gaveta de cápsulas utilizadas está cheia e ocorre esvaziar-la e reintroduzi-la.

1 Extrair a bandeja de coleta de gotas e a gaveta de coleta de cápsulas utilizadas.

i A máquina emite um sinal acústico para sinalizar a remoção da gaveta de coleta de cápsulas.



i Ao extrair a gaveta por mais de 5 segundos, a máquina reinicia a contagem das cápsulas.

- 2** Remover a bandeja de coleta de gotas e a gaveta de coleta de cápsulas. Esvazie as cápsulas utilizadas e os líquidos presentes na bandeja de coleta de gotas.

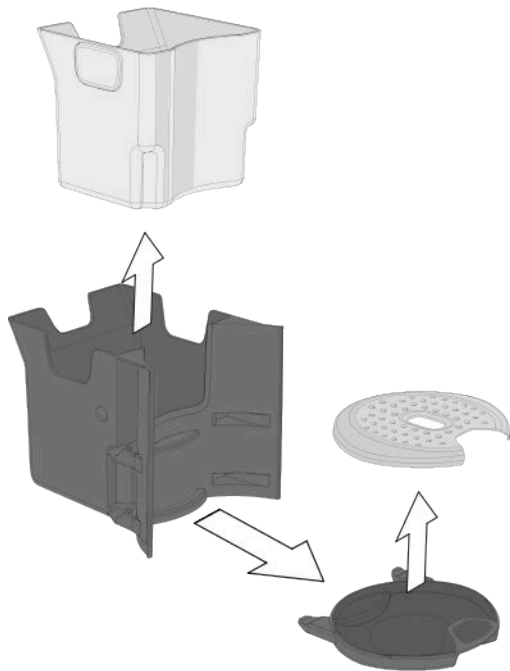

- 3** Lavar todos os componentes com água fria ou morna ou então na máquina de lavar louças. Seca-os e monta-os correctamente.

i Verificar de tempos em tempos que a bandeja de coleta de gotas não esteja cheia com a finalidade de evitar a fuga de líquidos.

DESCALCIFICAÇÃO

! Ler com muita atenção as instruções para a descalcificação.

A formação de calcário é uma consequência normal da utilização da máquina; é necessário efectuar a descalcificação a cada 3 ou 4 meses de utilização da máquina e/ou quando se observa uma redução na pressão da água.

O ciclo de descalcificação é requerido pela máquina através do acendimento da adequada luz avisadora de sinalização.

! Não desligue a máquina durante o ciclo de descalcificação. Não afaste-se da máquina durante o ciclo de descalcificação. Após ter iniciado o ciclo deve ser realizado até o fim.

! Verificar que não sejam presentes cápsulas no interior do vão de introdução de cápsulas.

1 Retirar e esvaziar o reservatório de água.

! Não beber a solução descalcificante nem os produtos servidos pela máquina até à conclusão do ciclo. Não utilizar nunca vinagre como descalcificante.

i Para executar a descalcificação, se recomenda de utilizar o produto **DESCALCIFICANTE DA LAVAZZA**.

- 2** Encher o reservatório com o conteúdo do **DESCALCIFICANTE DA LAVAZZA** (250 ml) e água (250 ml). Montar novamente o reservatório na máquina.



- i** Limpar os eventuais borrijo ou gotas com um pano umedecido

- 3** Posicionar sob o distribuidor um recipiente com capacidade superior aos 0,5 litros.

- 4** Ligar a máquina na rede elétrica sem activar a mesma.

- 5** Pressione e segure pressionado ao mesmo tempo as teclas de fornecimento **ESPRESSO** ☕ e **ESPRESSO LONGO** ☕ por pelo menos 5 segundos.





- i** O aparelho emite um longo sinal acústico e se acendem com luz fixa as teclas: On/Stand-by ○, DOSE LIVRE ☕ e a luz avisadora de descalcificação ☕.

- 6** Pressione a tecla DOSE LIVRE ☕ para iniciar o ciclo de descalcificação.

- !** Se a tecla DOSE LIVRE ☕ não é pressionada dentro os 9 minutos desde o sinal acústico, a máquina retornará na modalidade de stand-by e será necessário repetir a passagem **6** do procedimento, para iniciar o ciclo.



7 A máquina inicia a fase de aquecimento e a tecla DOSE LIVRE  inicia a piscar.

8 A máquina iniciará automaticamente a descalcificação depois de haver terminado o ciclo de aquecimento.





i Durante o ciclo de descalcificação a tecla DOSE LIVRE  se acende com luz intermitente e a luz avisadora de descalcificação  se acende com luz fixa.



! Durante o ciclo de descalcificação a máquina efetua automaticamente alguns ciclos de fornecimento intermitentes para consentir o esvaziamento do recipiente.

i É possível suspender momentaneamente o ciclo de descalcificação pressionando a tecla DOSE LIVRE  ou a tecla On/stand-by . Para reiniciar o ciclo pressione a tecla DOSE LIVRE .

9 Quando a máquina houver esgotado o líquido no reservatório, o ciclo é momentaneamente suspenso. Esvazie o recipiente utilizado para a coleta da solução.

i Tecla On/stand-by  , DOSE LIVRE  e luz avisadora de falta de água  estão acesas com luz fixa. Luz avisadora de descalcificação  se acende com luz intermitente.

10 Remover o reservatório de água, enxágue-o e lave-o cuidadosamente. Encher o recipiente com água fresca potável e sem gás até ao nível MÁX.



! Em caso de interrupção da alimentação, a máquina na sua primeira ignição solicitará o ciclo de enxágue.

11 Introduzir o reservatório com o água. Posicione sob o distribuidor um recipiente com capacidade superior aos 0,5 litros.

12 Pressione a tecla DOSE LIVRE  para iniciar o ciclo de enxágue.

i Para terminar o ciclo de enxágue é necessário que seja fornecido um quantitativo mínimo de água. Em caso de falta de água o ciclo é interrompido momentaneamente, a máquina emite um longo acústico e se a luz avisadora de falta de água  se acende com luz fixa. Reabastecer o reservatório.

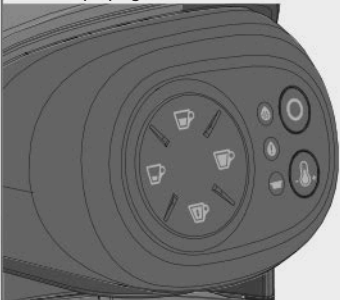
13 Ao término do fornecimento, limpar a máquina com um pano macio e umedecido. Após ter terminado a limpeza, o processo de descalcificação é completo. A máquina está pronta para o uso.

Problema	Causa possível	Resolução
<p>A máquina não liga. Luz avisadora On/Stand-by apagada.</p> 	<ul style="list-style-type: none"> » Máquina não ligada à rede eléctrica. » A máquina está ligada com tomadas múltiplas ou extensões que não funcionam corretamente. » Alimentação não presente na rede eléctrica/doméstica. 	<ul style="list-style-type: none"> » Ligar a máquina à rede eléctrica. » Ligue a máquina diretamente na rede eléctrica. » Verifique a presença de corrente eléctrica ligando outro dispositivo eléctrico na corrente eléctrica de alimentação. <p>SE O PROBLEMA PERSISTE CONSULTE O SERVIÇO DE CLIENTES LAVAZZA.</p>
<p>Pressionando a tecla On/Stand-by a máquina não se ativa.</p> 	<ul style="list-style-type: none"> » Interface touch não reativa. » Pressão errada e contemporânea de 2 teclas. 	<ul style="list-style-type: none"> » Verificar que a superfície da interface e a mão do utilizador estejam secas e limpas. » Aguardar alguns segundos e pressionar somente a tecla On/Stand-by. <p>SE O PROBLEMA PERSISTE CONSULTE O SERVIÇO DE CLIENTES LAVAZZA.</p>
<p>Percepção do tempo de aquecimento excessivo (maior de 40 segundos).</p>	<ul style="list-style-type: none"> » Estocagem da máquina em ambiente muito frio (por ex.: adega/garagem). 	<ul style="list-style-type: none"> » Conservar a máquina em um ambiente adequado por pelo menos 1 hora. Sucessivamente ligar a máquina na tomada eléctrica e tentar a ignição. <p>SE O PROBLEMA PERSISTE CONSULTE O SERVIÇO DE CLIENTES LAVAZZA.</p>

Problema	Causa possível	Resolução
Máquina ruidosa.	<ul style="list-style-type: none"> » Plano de apoio não estável. » Fio elétrico mal posicionado. » Partes móveis não introduzidas corretamente. » Falta água no reservatório. » Cápsula não presente. 	<ul style="list-style-type: none"> » Verifique o plano de apoio. » Verifique o correto posicionamento do fio na base da máquina. » Introduzir corretamente as partes móveis. » Atestar com água fria potável. » Introduzir uma cápsula Lavazza A MODO MIO ou compatível. <p>SE O PROBLEMA PERSISTE CONSULTE O SERVIÇO DE CLIENTES LAVAZZA.</p>
A máquina pronta para o uso não recebe a pressão das teclas.	<ul style="list-style-type: none"> » Errada pressão/ativação das teclas. » Gaveta de coleta de cápsulas utilizadas não introduzida. 	<ul style="list-style-type: none"> » Pressione uma das teclas iluminadas com a ponta dos dedos e verifique a presença do sinal acústico (se ativado) e o correto lampejo do ícone selecionado. » Verificar a correta introdução da gaveta com o consequente apagamento da luz avisadora de alarme. Verificar o fornecimento. <p>SE O PROBLEMA PERSISTE CONSULTE O SERVIÇO DE CLIENTES LAVAZZA.</p>
A alavanca permanece fechada depois do fornecimento.	<ul style="list-style-type: none"> » Gaveta de cápsulas esgotadas cheia. 	<ul style="list-style-type: none"> » Esvazie a gaveta e tentar abrir a alavanca. <p>SE O PROBLEMA PERSISTE CONSULTE O SERVIÇO DE CLIENTES LAVAZZA.</p>

Problema	Causa possível	Resolução
<p>A máquina não realiza o fornecimento (se acende mas não distribui, nem café e nem água).</p>	<ul style="list-style-type: none"> » Falta água no reservatório. » Reservatório não introduzido corretamente. » Alavanca de carregamento de cápsula elevada ou não abaixada corretamente. » Ausência de fluxo de água no circuito hidráulico (falha no engate). » Cápsula de tipo não adequado. » Presença de calcar. 	<ul style="list-style-type: none"> » Reabastecer com água fresca e potável o reservatório e verificar o correto fornecimento. » Introduzir corretamente o reservatório e verificar o correto fornecimento. » Abaixar a alavanca de carregamento de cápsulas até o fim e verificar o correto fornecimento. » Desligue o fio de alimentação, espere 10 segundos e ligue o fio novamente. Ligue a máquina e espere o fim do aquecimento. Verifique o correto fornecimento (a máquina efetua em automático tentativas de enchimento do circuito). » Provar com outra cápsula pertencente à uma caixa diferente. » Efetuar a descalcificação com o descalcificante da Lavazza. <p>SE O PROBLEMA PERSISTE CONSULTE O SERVIÇO DE CLIENTES LAVAZZA.</p>
<p>A máquina perde água.</p>	<ul style="list-style-type: none"> » Reservatório danificado. » Gaveta de cápsulas esgotadas cheia. » Cápsula enroscada. » Cápsula de tipo não adequado. 	<ul style="list-style-type: none"> » Verifique a presença de perdas no reservatório segurando-o separado da máquina. » Esvazie a gaveta e tentar abrir a alavanca. » Abrir e fechar a alavanca para fazer cair a cápsula. Extrair a gaveta porta-cápsulas e esvazie-la. » Utilize cápsulas adequadas (Lavazza A MODO MIO ou compatíveis). <p>SE O PROBLEMA PERSISTE CONSULTE O SERVIÇO DE CLIENTES LAVAZZA.</p>

Problema	Causa possível	Resolução
Tecla on/off intermitente vermelha.	» Condições de estocagem da máquina não adequada/Bloqueio Temporário.	» Desligue a tomada da máquina desde a tomada de corrente. Deixar a máquina em temperatura ambiente por um período suficiente (máximo 1 hora). Ligue novamente a máquina na tomada de corrente e pressionar o botão de ignição. (provar somente uma vez). SE O PROBLEMA PERSISTE CONSULTE O SERVIÇO DE CLIENTES LAVAZZA.
A alavanca de carregamento não alcança a posição de fornecimento ou requer uma excessiva força de fechamento.	» Gaveta de cápsulas esgotadas cheia. » Cápsula enroscada.	» Esvaziar a gaveta e provar a fechar a alavanca. » Abrir e fechar a alavanca para fazer cair a cápsula. SE O PROBLEMA PERSISTE CONSULTE O SERVIÇO DE CLIENTES LAVAZZA.
O café é fornecido muito rapidamente e portanto, resulta pouco cremoso.	» Uso de cápsula já utilizada. » Cápsula não introduzida. » Cápsula de tipo não adequado.	» Utilizar uma cápsula nova. » Introduzir a cápsula. » Provar com outra cápsula pertencente à uma caixa diferente. SE O PROBLEMA PERSISTE CONSULTE O SERVIÇO DE CLIENTES LAVAZZA.
O café está frio.	» Fornecimento lento com circuito hidráulico entupido de calcar.	» Efetuar a descalcificação com o descalcificante da Lavazza. SE O PROBLEMA PERSISTE CONSULTE O SERVIÇO DE CLIENTES LAVAZZA.

Problema	Causa possível	Resolução
A máquina não emite nenhum som.	» Sinal acústico desactivado.	» Colocar a máquina em stand-by e sucessivamente segurar pressionado-ao mesmo tempo as teclas de fornecimento Café expresso e Café Longo por pelo menos 5 segundos. (consultar a secção PREDISPOSIÇÃO DA MÁQUINA). SE O PROBLEMA PERSISTE CONSULTE O SERVIÇO DE CLIENTES LAVAZZA.
O café jorra lentamente em gotas.	» Cápsula de tipo não adequado. » Uso de cápsula já utilizada. » Distribuidor entupido. » Circuito hidráulico entupido a causa de calcar.	» Provar com outra cápsula pertencente à uma caixa diferente. » Retire a cápsula usada e use uma nova cápsula. » Executar o ciclo de lavagem do bico de saída de café (ver MANUTENÇÃO E LIMPEZA). » Efectuar a descalcificação com o descalcificante da Lavazza. SE O PROBLEMA PERSISTE CONSULTE O SERVIÇO DE CLIENTES LAVAZZA.

Para qualquer problemática não indicada nos casos acima elencados, consulte o Serviço de Clientes Lavazza.

CARACTERÍSTICAS TÉCNICAS

- Alimentação de corrente: 220-240V / 50-60Hz
- Potência nominal: 1500W
- Tamanho: Altura Largura Profundidade
280 mm 145 mm 380 mm
- Peso: 4 kg
- Reservatório de água extraível: 1,1 L
- Materiais utilizados na estrutura: termo-plástico
- Comprimento do cabo: 0,8 m



Il produttore si riserva il diritto d'apportare qualsiasi modifica senza preavviso.

The manufacturer reserves the right to make changes without prior notice.

Le producteur se réserve le droit d'apporter des modifications sans aucun préavis.

Der Hersteller behält sich das Recht vor, Änderungen jeder Art ohne Vorankündigung vorzunehmen.

El fabricante se reserva el derecho a realizar modificaciones sin previo aviso.

O fabricante reserva-se o direito de efectuar qualquer alteração sem aviso prévio.