





FR
DONNEZ
OU
RECYCLEZ



OU



OU



ASSOCIATION

MAGASIN

DÉCHÈTERIE

Adresses sur quefairedemesdechets.fr



LEGO.com/sustainable-packaging



MILAN MADGE
*Model Designer at
the LEGO Group*

WILD ABOUT FLOWERS

🌸 'Whether you are growing your LEGO® Botanical Collection or this is your first LEGO flower arrangement, you are probably as wild about flowers as we are. This bouquet is a fresh mix of flowers you might pick for yourself in a field or garden, and we paired colours and complementary species from all over the world to celebrate our planet's biodiversity and the soothing beauty we cherish in nature.

Enjoy building!'

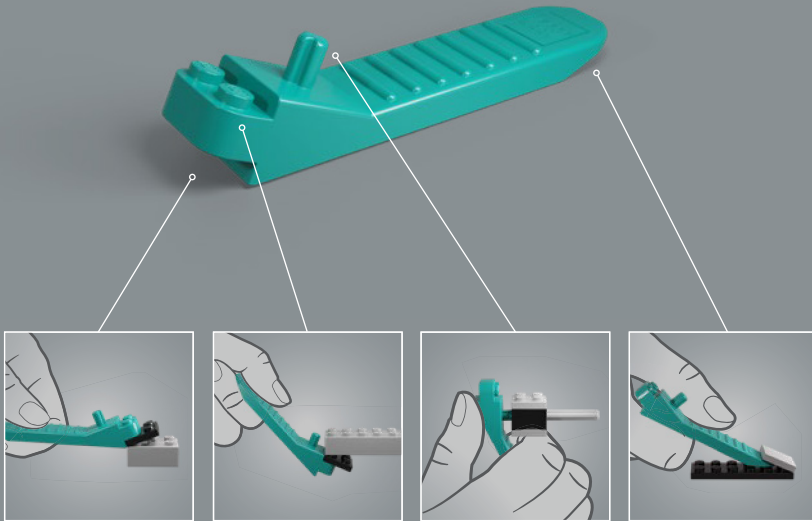

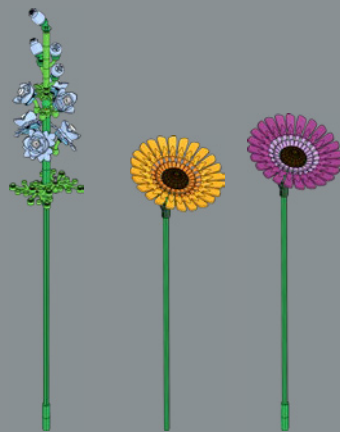
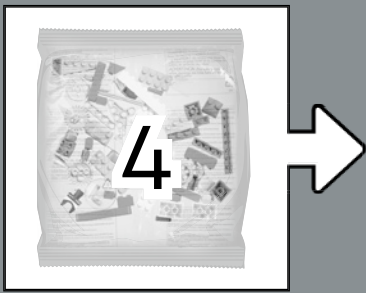
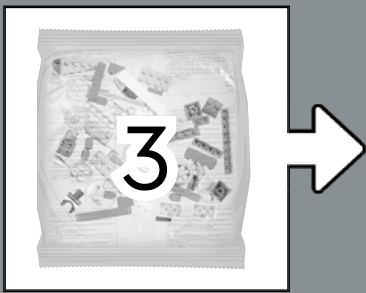
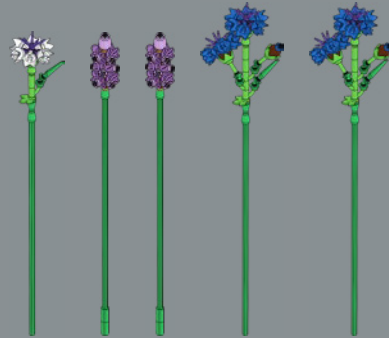
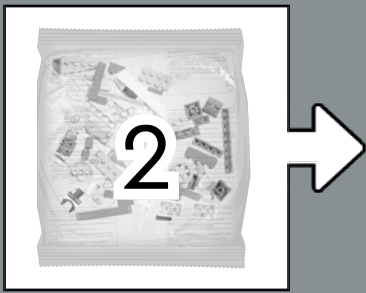
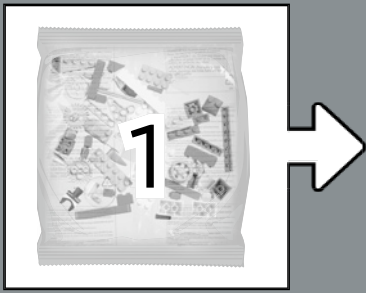

LEATHERLEAF FERN

(Rumohra adiantiformis)

✿ The lush, bushy Leatherleaf Fern, native to most tropical climates in the Southern Hemisphere, has become popular with garden owners all over the world. Although it does not produce flowers, the feathery foliage is also a beloved favourite in the cut flower industry as a decorative filler in floral arrangements.

COW PARSLEY/ QUEEN ANNE'S LACE

(Anthriscus Sylvestris)

✿ This airy, cloudlike umbrella of tiny white flowers is commonly found in shady areas all over Europe, in Asia and Africa. Its blossom fireworks are a treat for bees, moths, butterflies and other insects looking for pollen in the early spring. Did you know it is also often used as a mosquito repellent?

WELSH POPPY

*(Meconopsis cambrica/
Papaver cambricum)*

✿ A sure sign of spring and summer in the British Isles and Western Europe is the arrival of the soft, golden Welsh Poppy in hedgerows, fields and roadsides. Despite its tender frame and petals, it also thrives in rocky environments with very little soil and in cracks in your paved garden or city sidewalks.



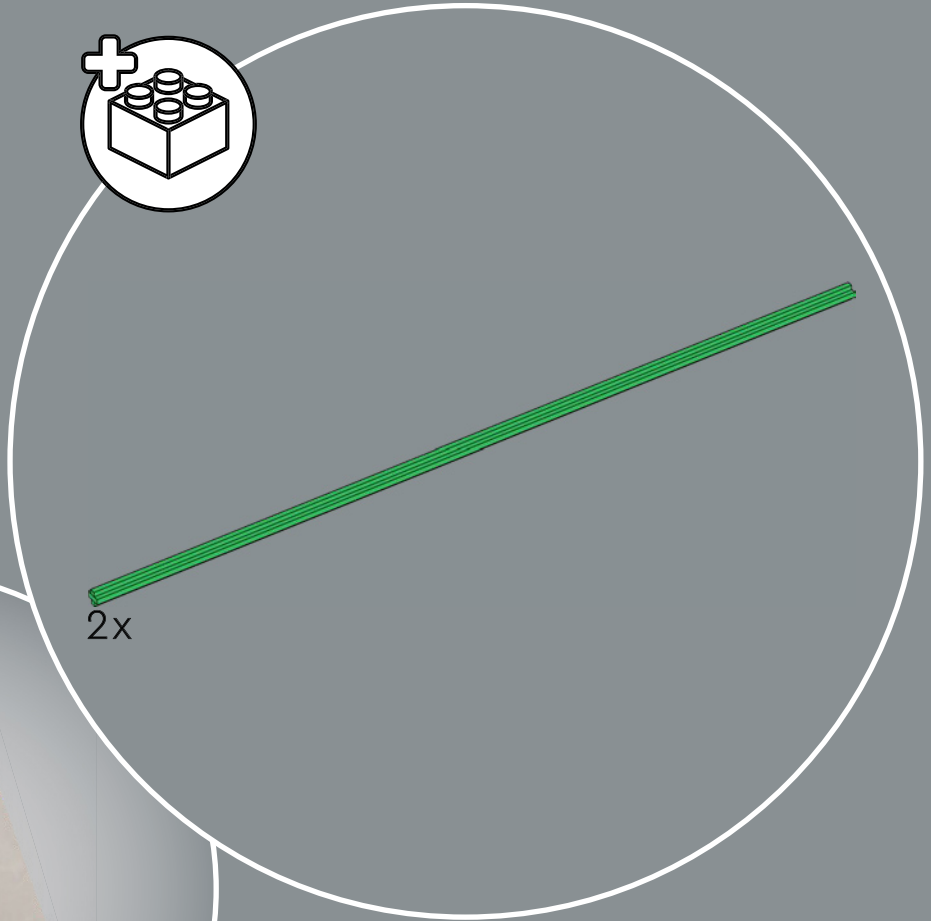
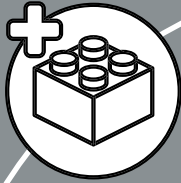

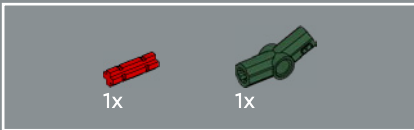

1

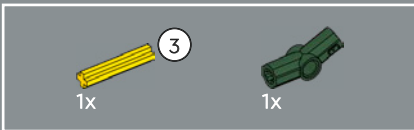
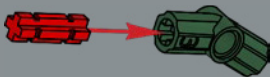

2

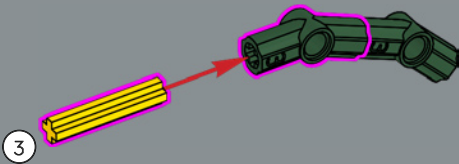

3

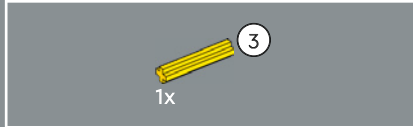
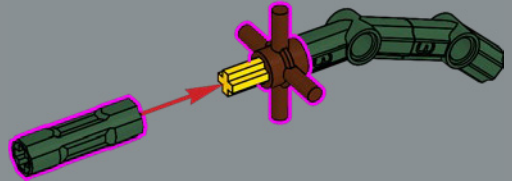

4

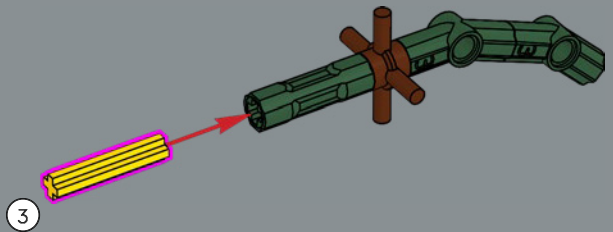

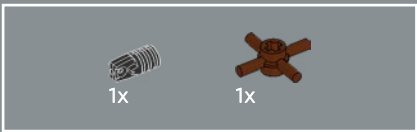

5

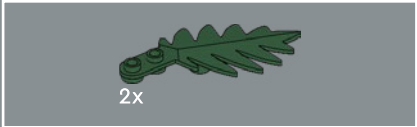
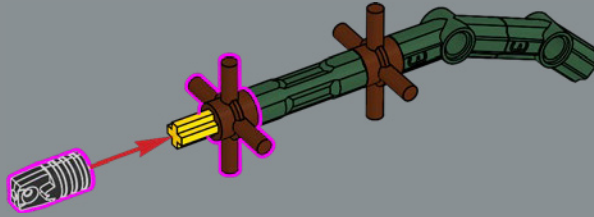

6

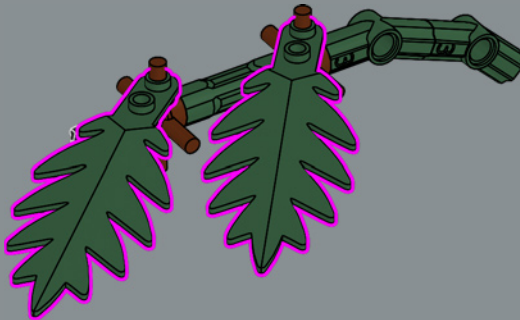

The palm leaf element was first introduced in our LEGO® Pirates theme in the 1990s. Now it is repurposed to create the Leatherleaf Fern.

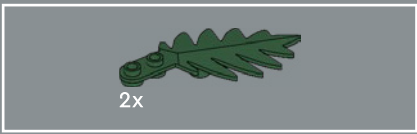

7

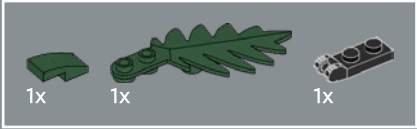

8

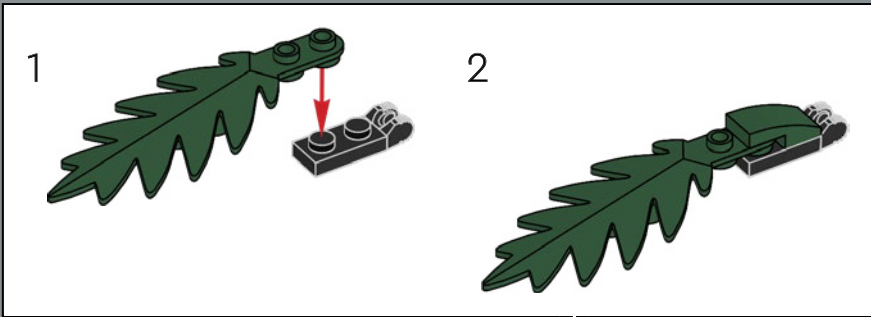

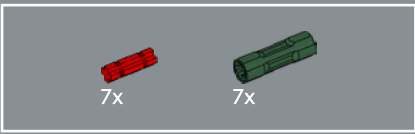

9

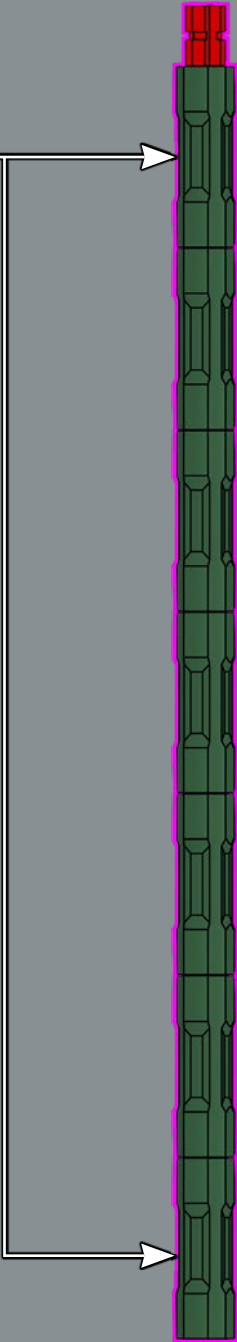
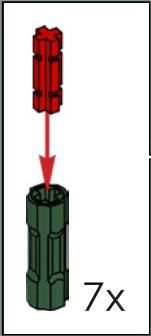

1:1

10

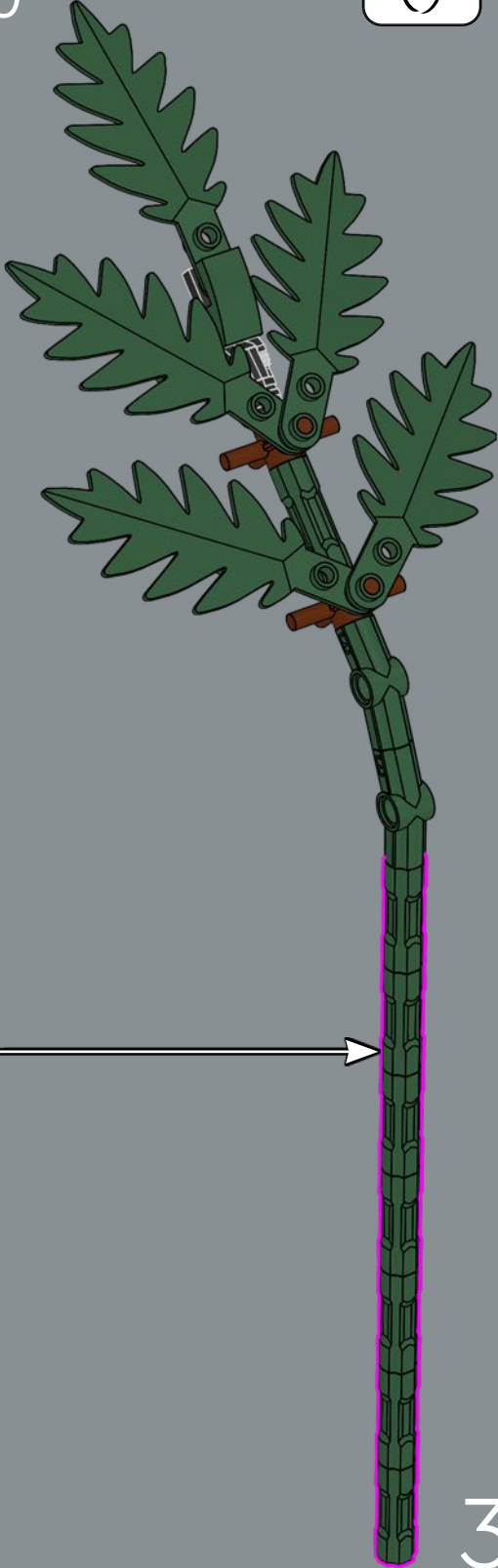

3x

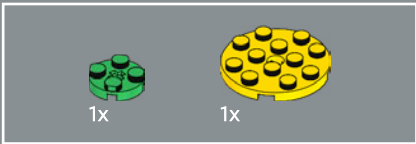
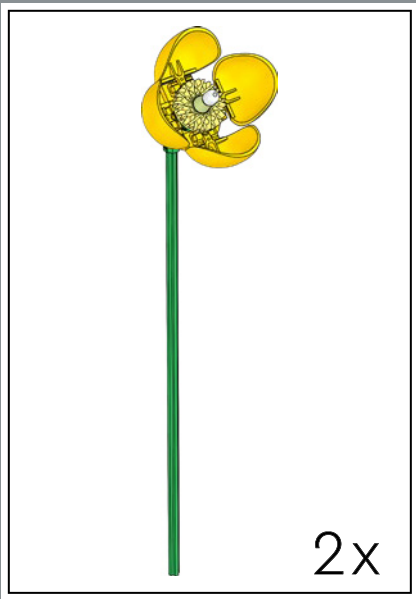

1

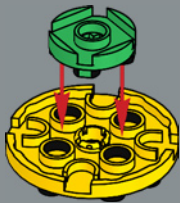

2



3

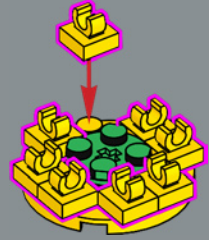

4

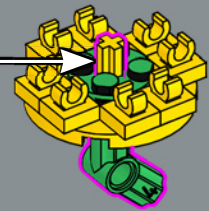
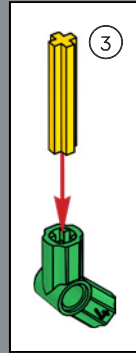

5

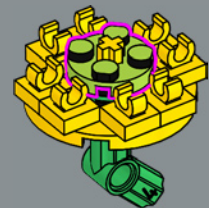



Using existing elements in unusual ways is at the heart of LEGO® building. Here a car hub is used to represent the stigma at the centre of the Welsh Poppy.

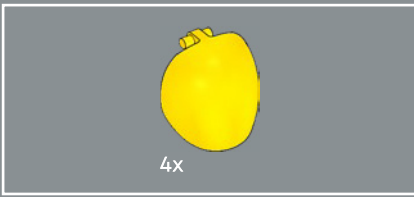

6

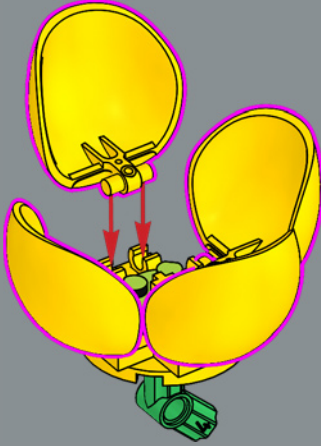

7

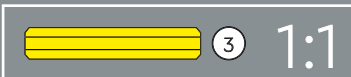
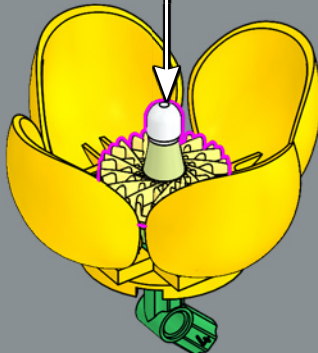
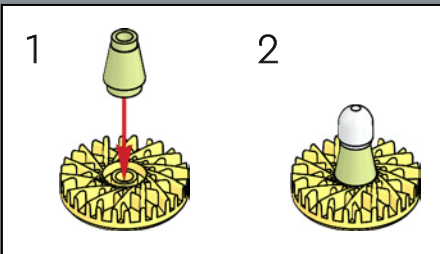

8

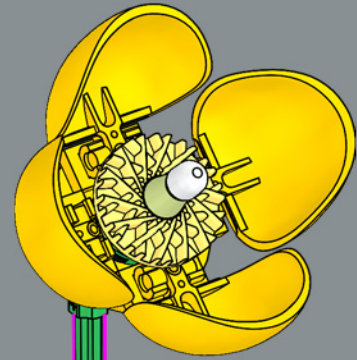

32

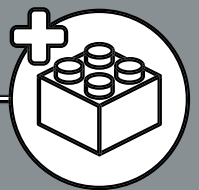

2x

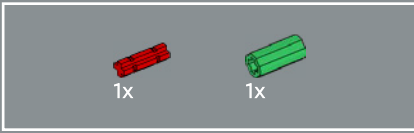
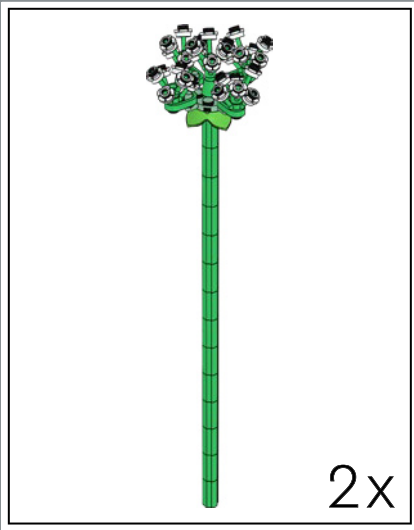

1

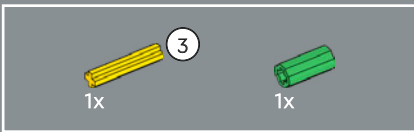

2

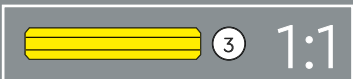

3

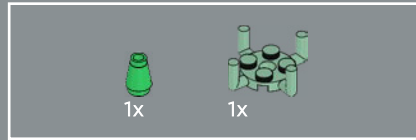

4

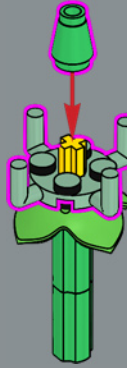

5

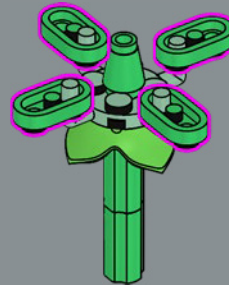

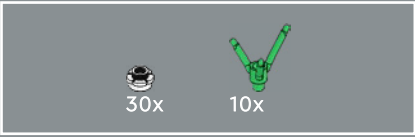
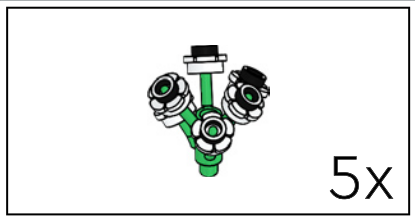

6

1

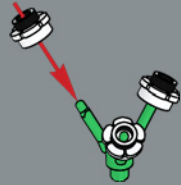

2

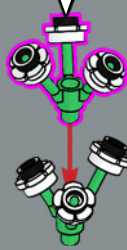

5x

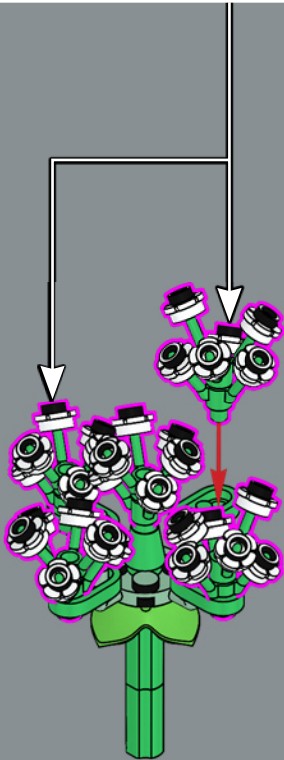
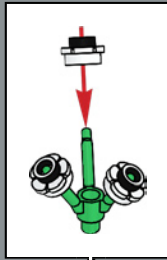

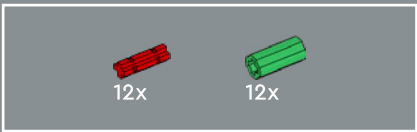

7

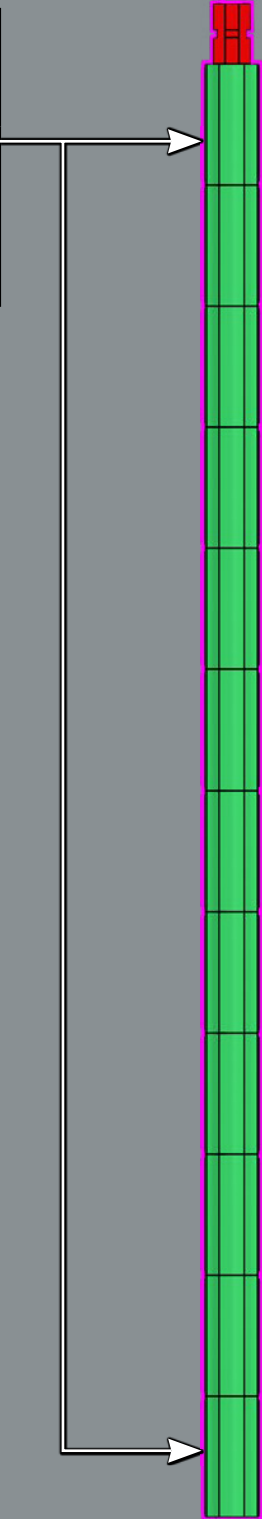
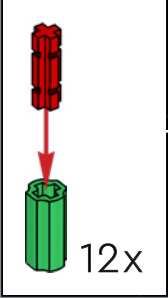

1:1



The nickname Queen Anne's Lace traces back to an old saying that flowers would bloom for Anne, Queen of Great Britain (1702-1707) and her ladies-in-waiting as a complement to their lace dresses.

8

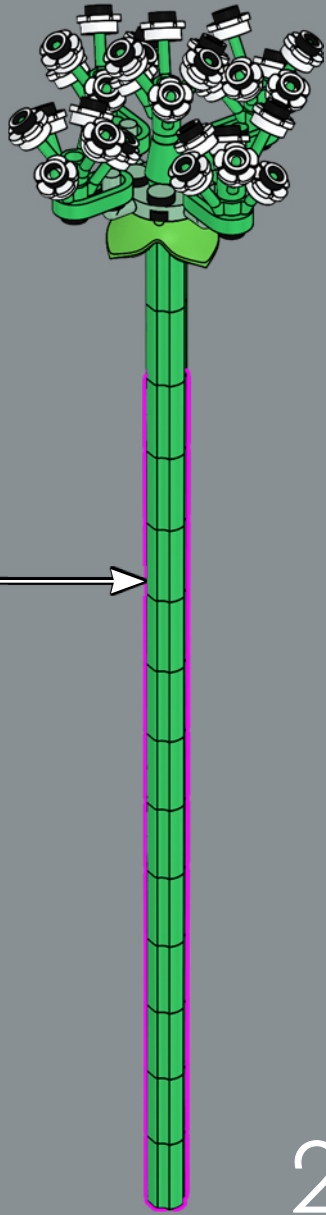

2x



CORNFLOWER

(Centaurea cyanus)

✿ The brightly coloured, paper-light Cornflower decorates fields and gardens alike in white, pink and blue from early to mid-summer, particularly in Europe, North America and Asia. Its delicate fragrance and nectar attract butterflies and bees, making the Cornflower an alluring companion to your vegetable garden or orchard.



LAVENDER

(Lavandula)

✿ An evergreen shrub with bursting pops of purple colours and a soothing aroma, the ornamental Lavender is as purposeful as it is decorative. Native to the Mediterranean, the Middle East and North Africa, it is widely used as an aromatic culinary herb, for the distillation of essential oils for cosmetics and in herbal medicines.

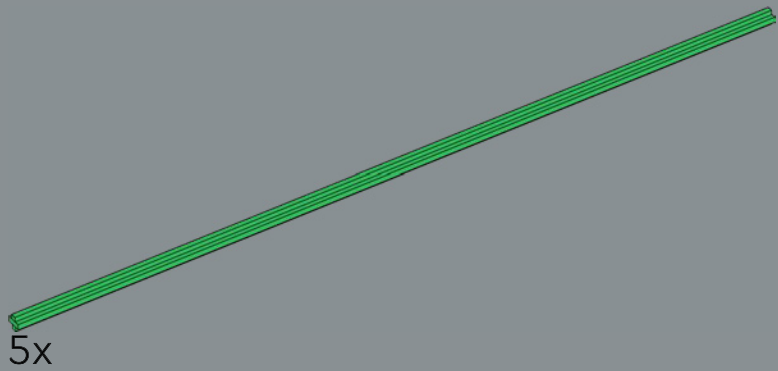
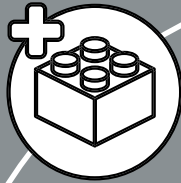

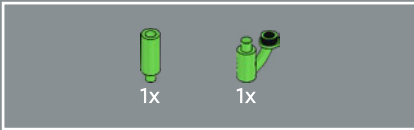
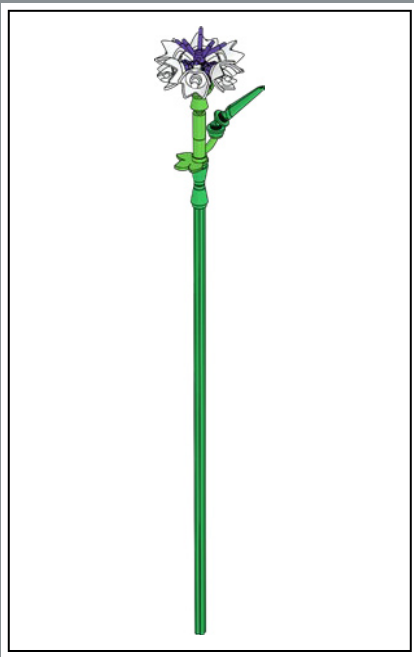

1

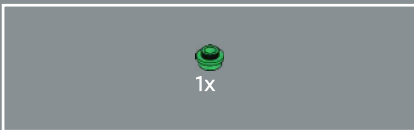

2

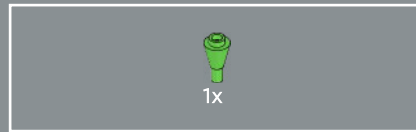
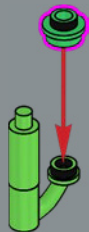

3

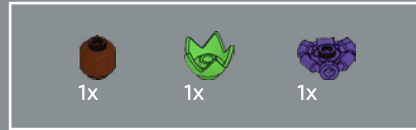
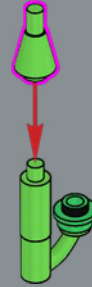

4

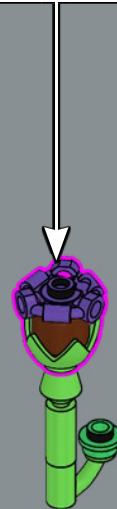
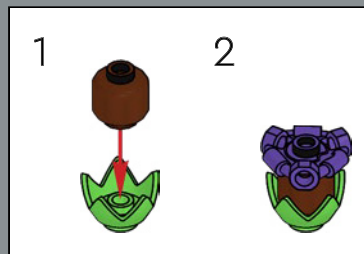



3x



3x

5

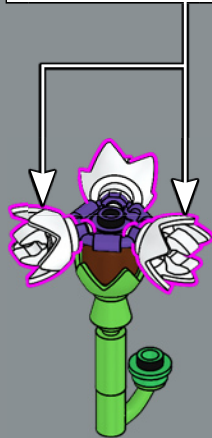
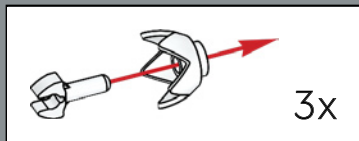

3x

6

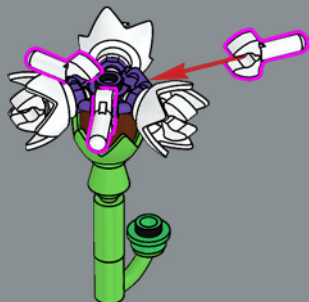

3x

7

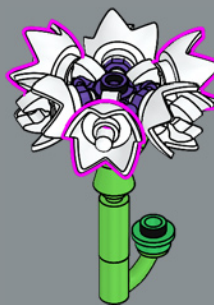

1x

8

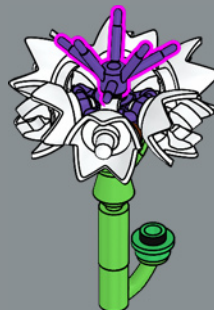

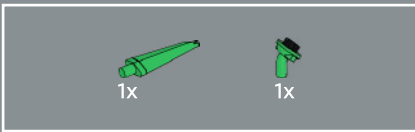

9

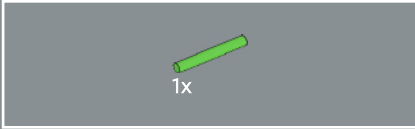
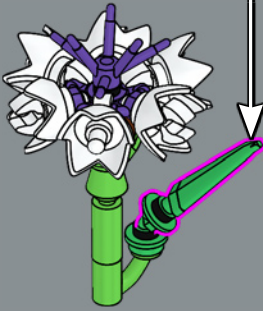
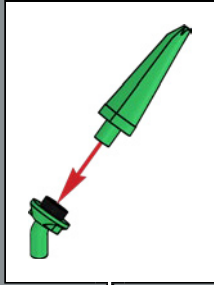

10

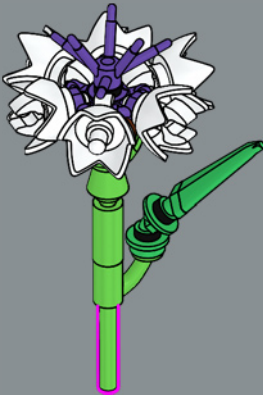

11

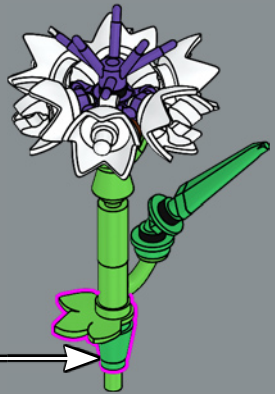
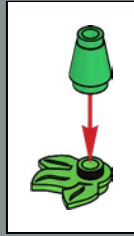



12

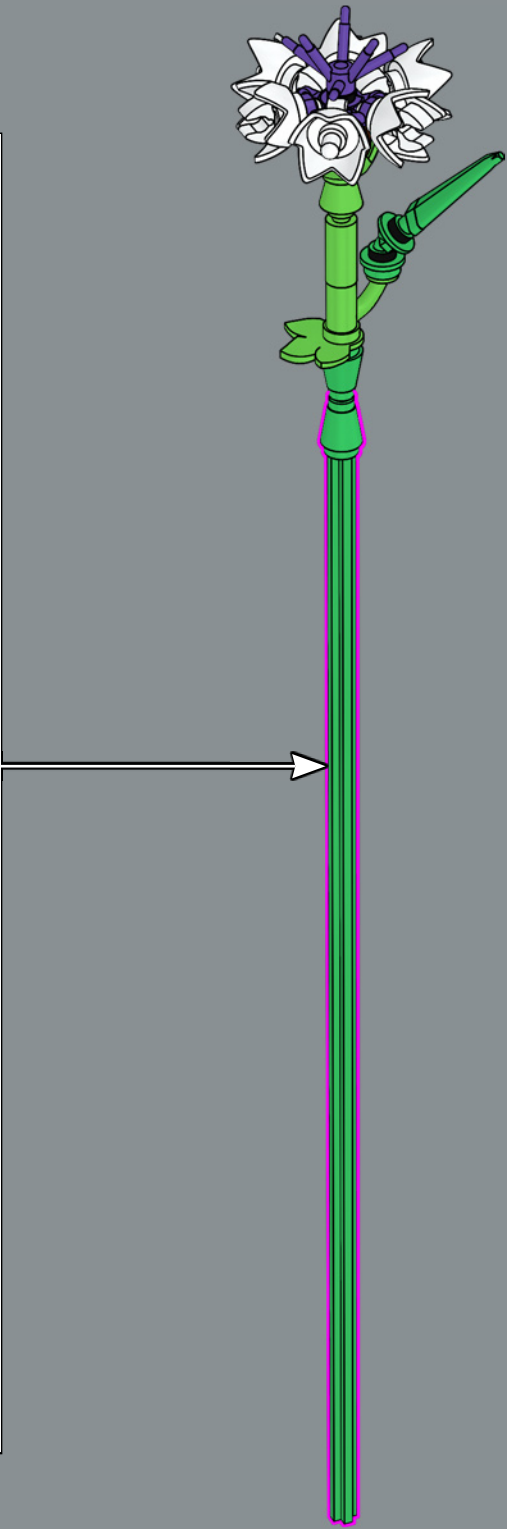
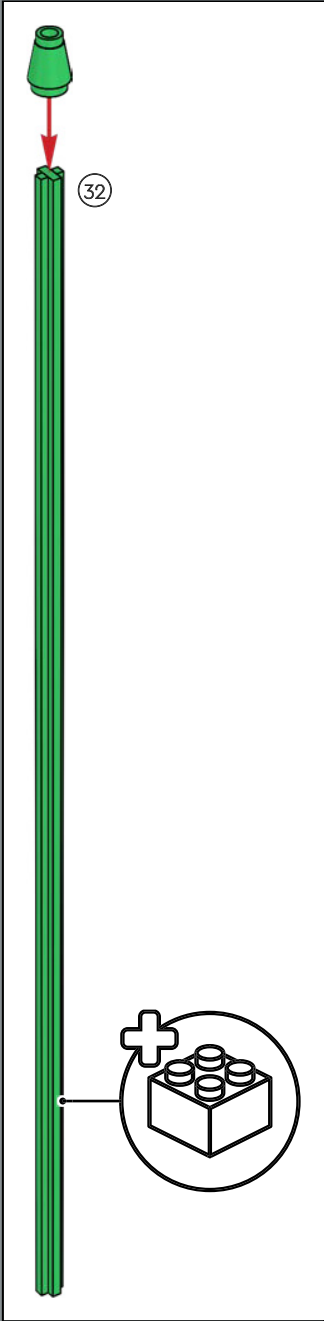

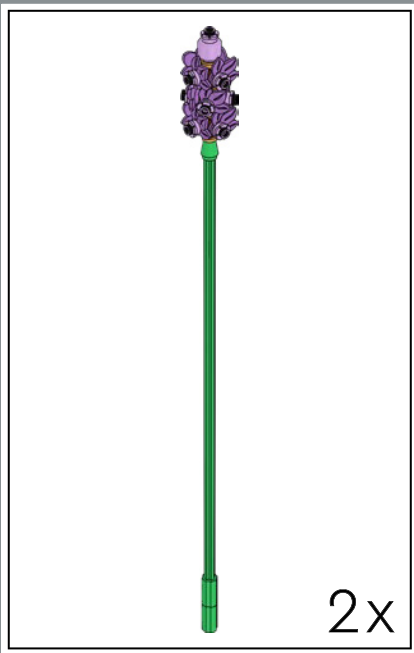

1



2



3

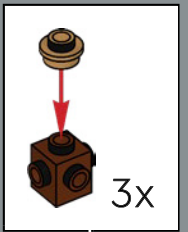

4

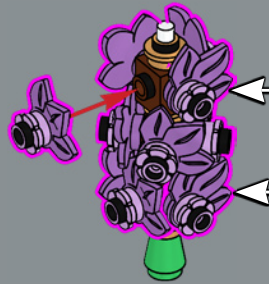
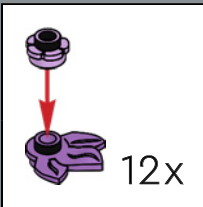

5





6

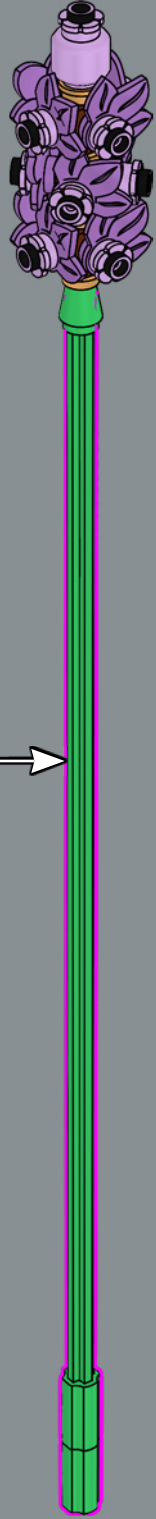
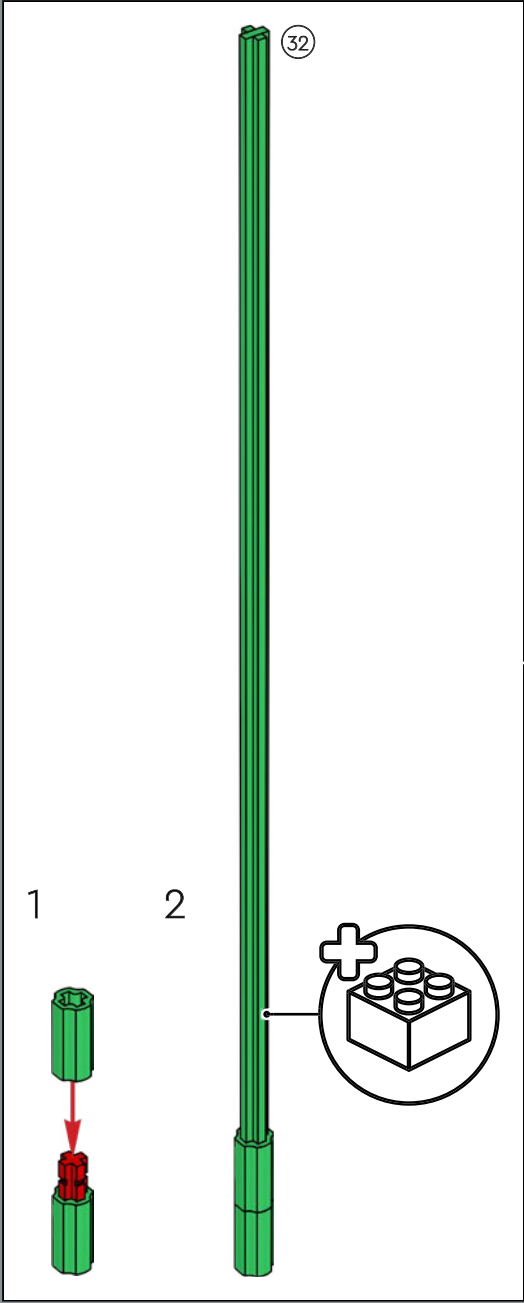

2x



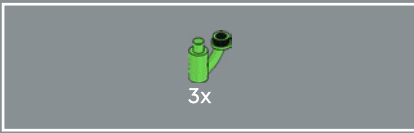
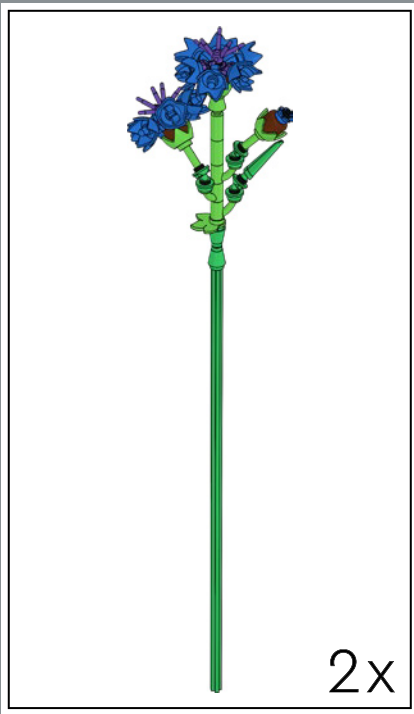

1

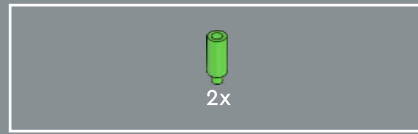

2

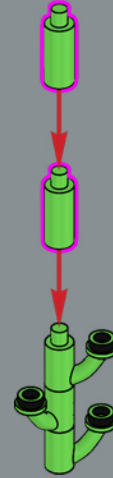

3

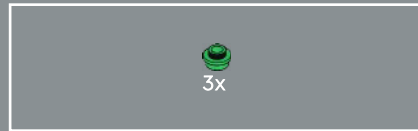
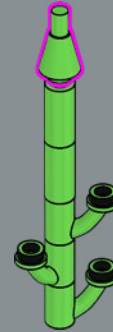

4

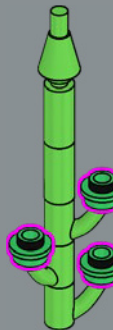

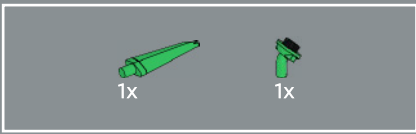

5

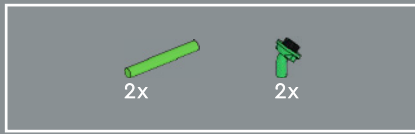
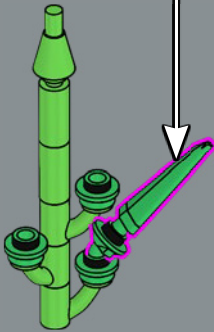
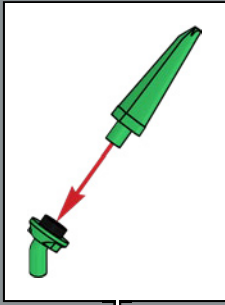

6

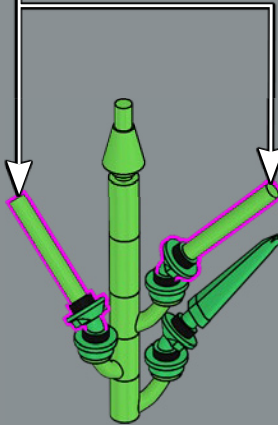
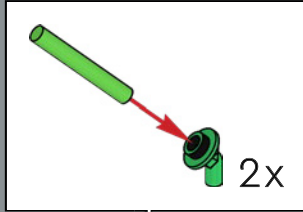

7

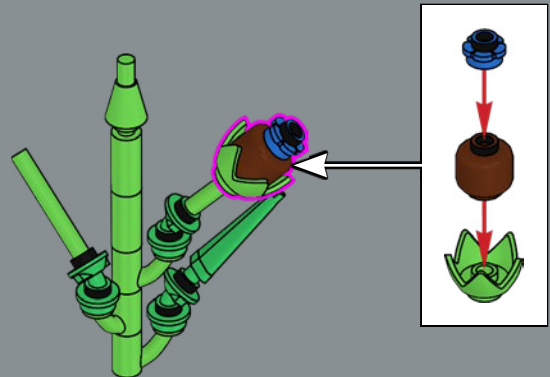

The LEGO Group is working to build a more sustainable future for children. Currently more than 80 LEGO® elements including trees, leaves and bushes are made from a plant-based plastic, produced using sustainably sourced sugarcane, Plants from Plants! These elements represent the first steps of a bigger mission to make LEGO bricks from sustainable sources by 2030.



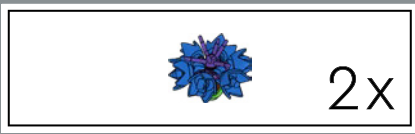

8



9



10

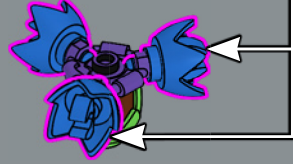
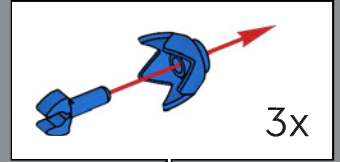

11

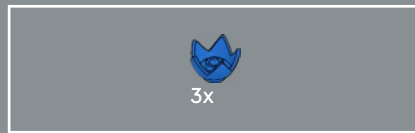
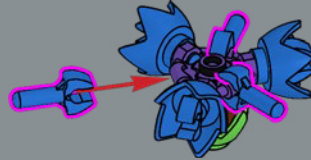

12

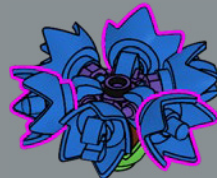



13

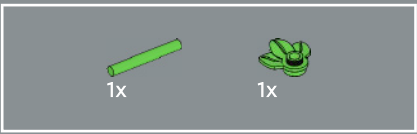
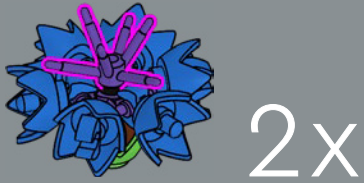

15

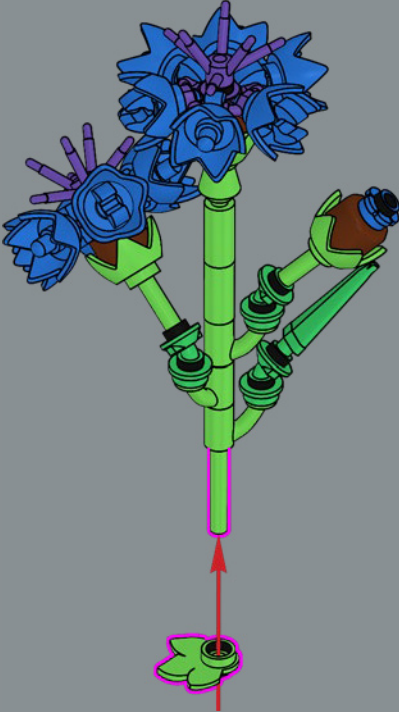

14

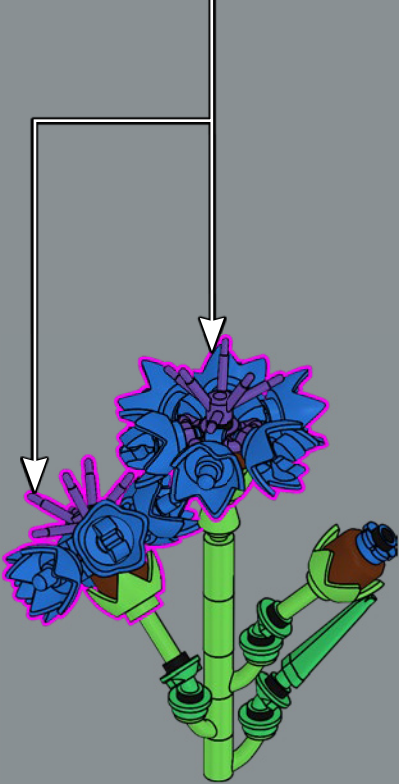

16

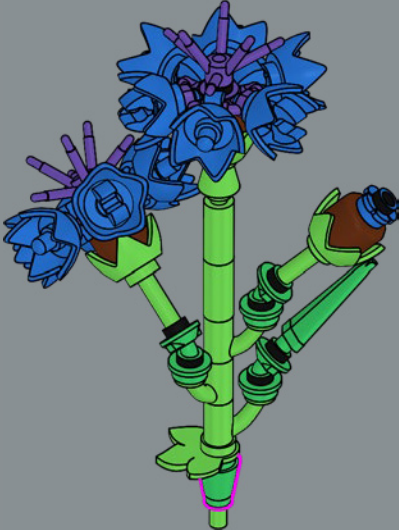



17

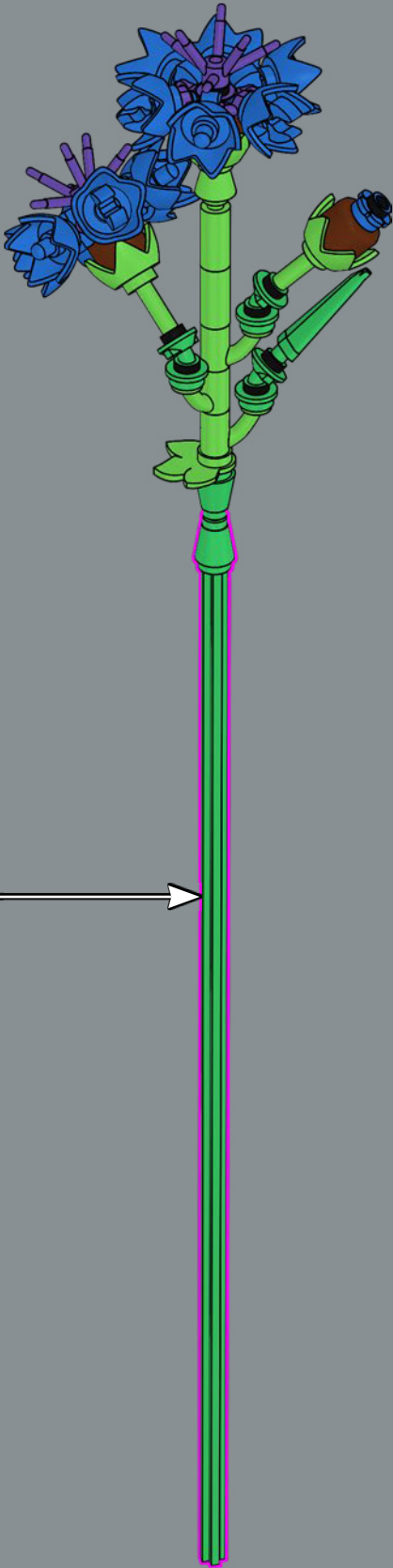
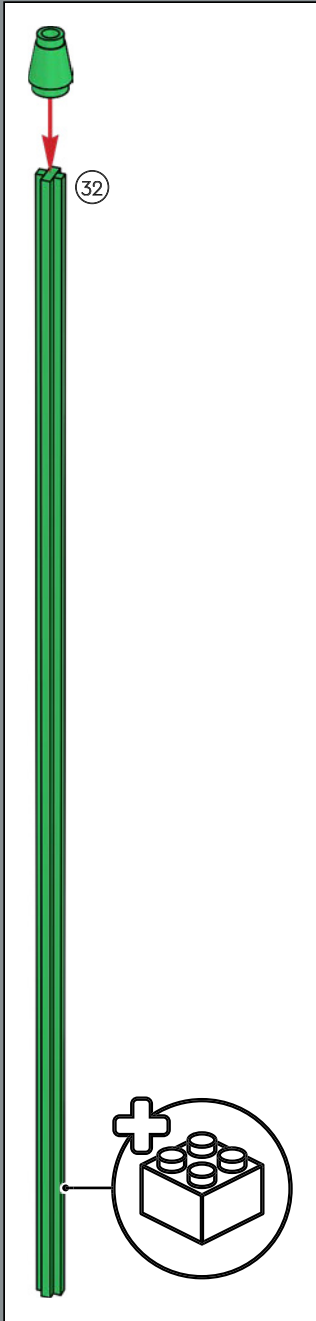



LUPIN

(Lupinus)

🌸 Originally native to North America, Lupins also thrive in the wild in the Mediterranean and Europe. Wildly diverse in colour, their ombré spikes climb tall to attract pollinators' attention – and ours – across the North American prairie, along roads and in gardens all over the world.

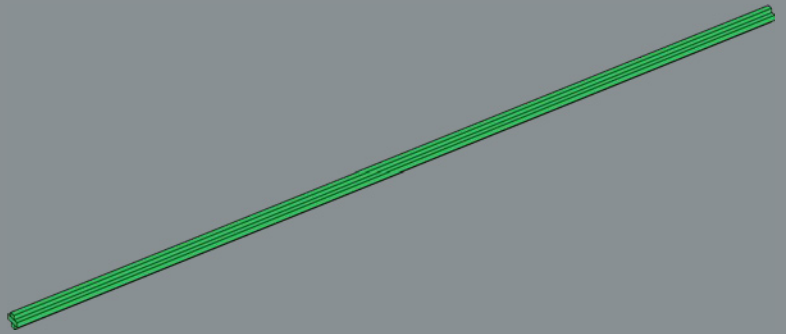
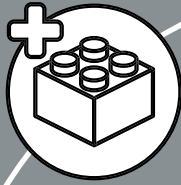

2x



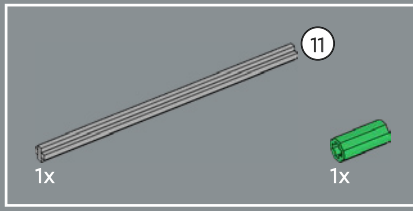
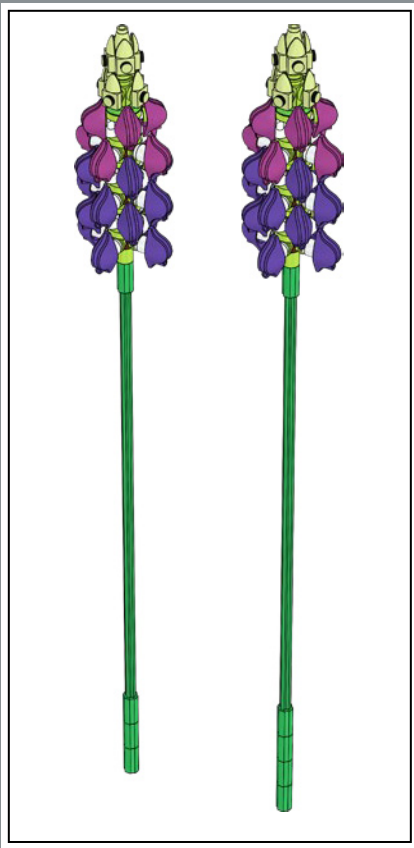

1

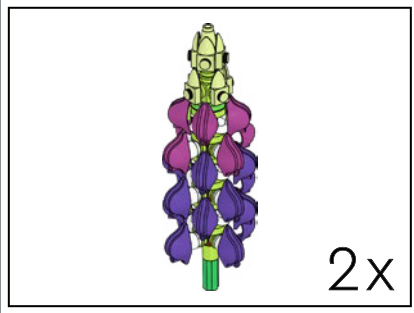
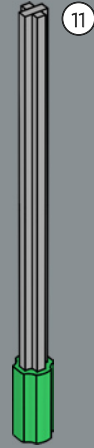

2

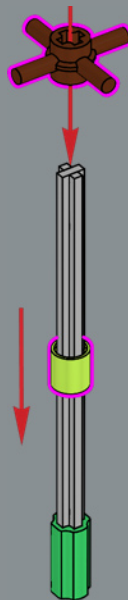



3

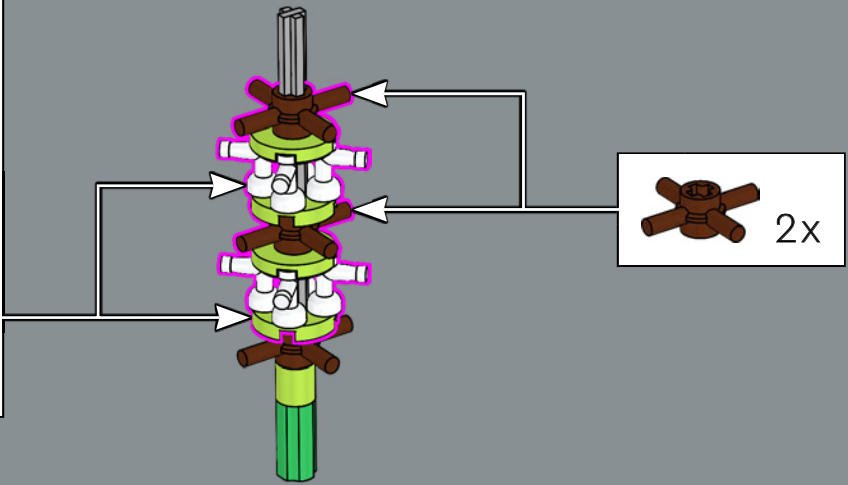
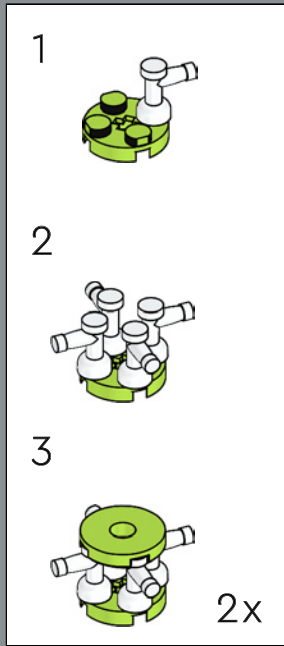

4

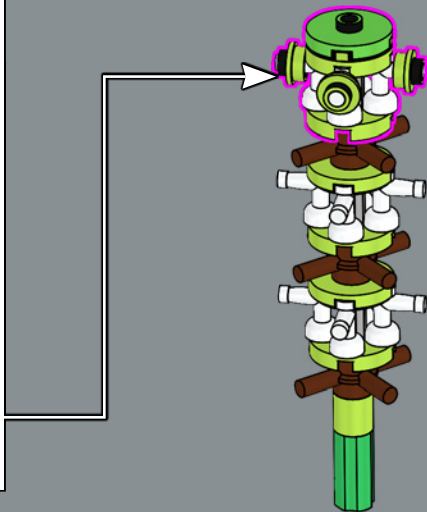
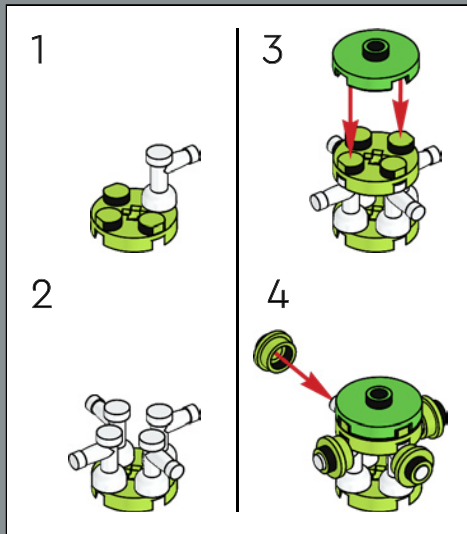

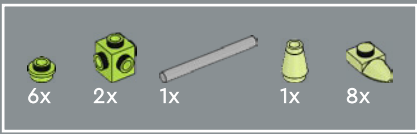

5

1



2

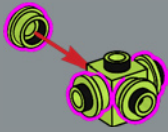

3



4

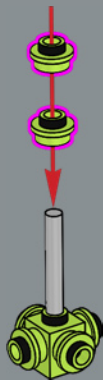

5



6



7

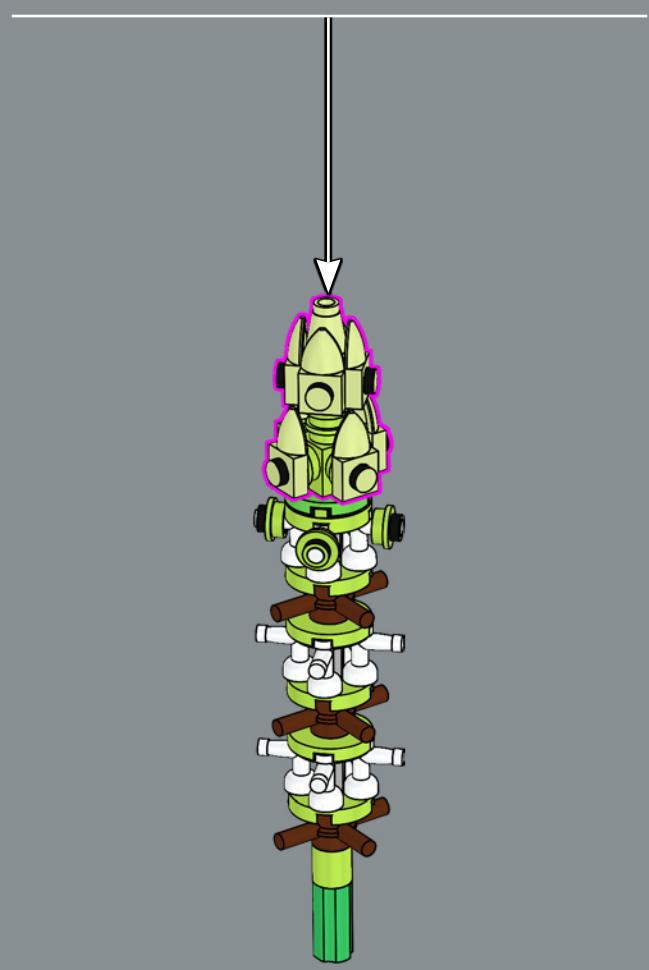



6

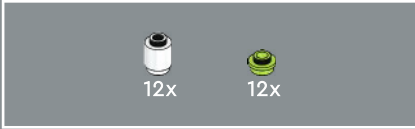
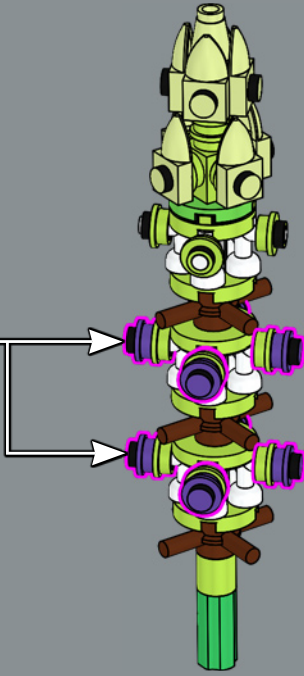
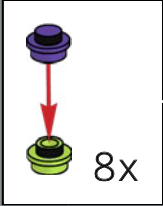

7

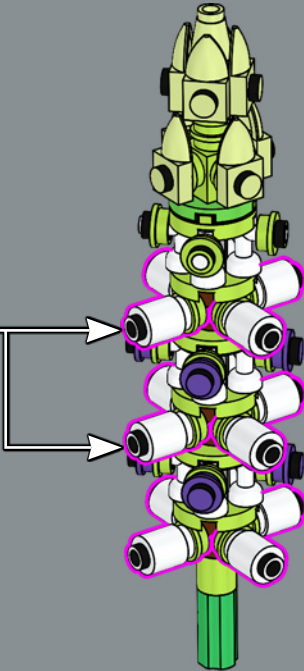
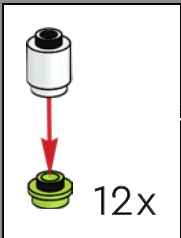

8

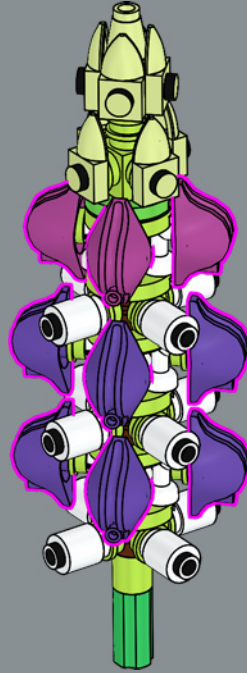

9

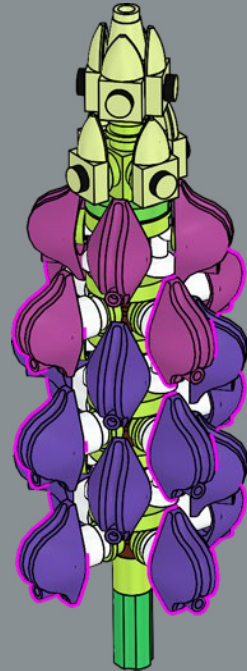

2x

10



32

32



The minifigures who wore these pirate hats back in 1989 could never have imagined that their fancy headgear would one day be used as Lupin petals!

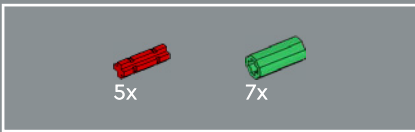

11

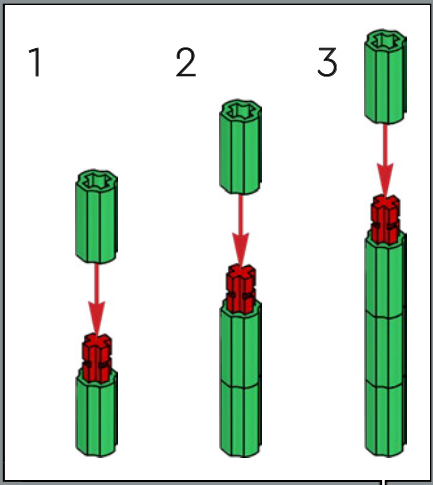
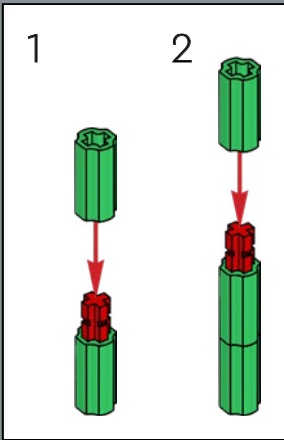
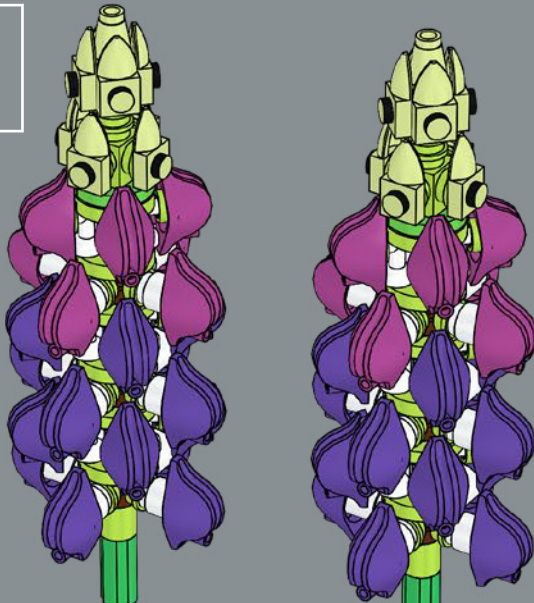

A collection of LEGO flowers. At the top is a tall, thin green stem with several blue buds and two blue flowers. Below it are two more blue flowers. In the middle is a large yellow sunflower with a brown center. At the bottom are two pink gerbera daisies with purple centers and green stems.

LARKSPUR

(Consolida ajacis)

✿ The Larkspur gifts us eye-catching wildflower seas in blooming hues of blues across fields and gardens throughout the Northern Hemisphere. An annual species, it arrives in early spring and, along with its close relative the perennial Delphinium, adds height and an airy, elegant pop of colour to your bouquet.

GERBERA DAISY

(Gerbera jamesonii)

✿ A cousin to the sunflower, the lustrous Gerbera comes in a rainbow of colour variations. Native to South Africa, it is also known as the African daisy, Transvaal daisy, or Hilton daisy. With its soft scent and majestic, elevated crown brimmed with velvet-like petals, it radiates light in any garden, field or bouquet.

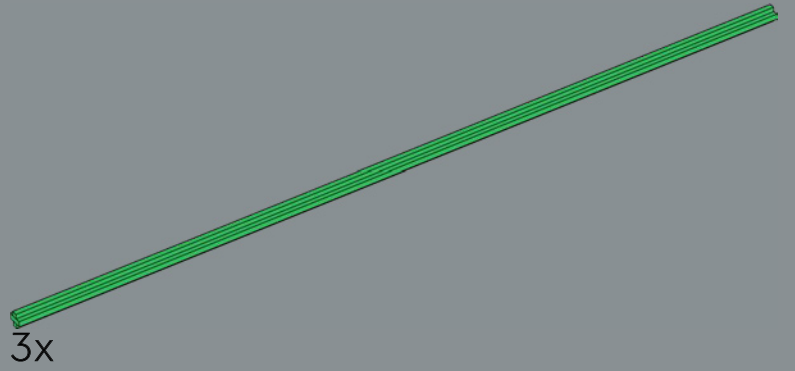
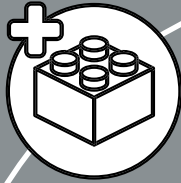

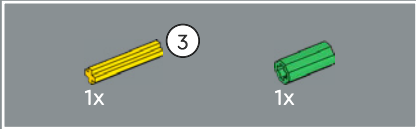
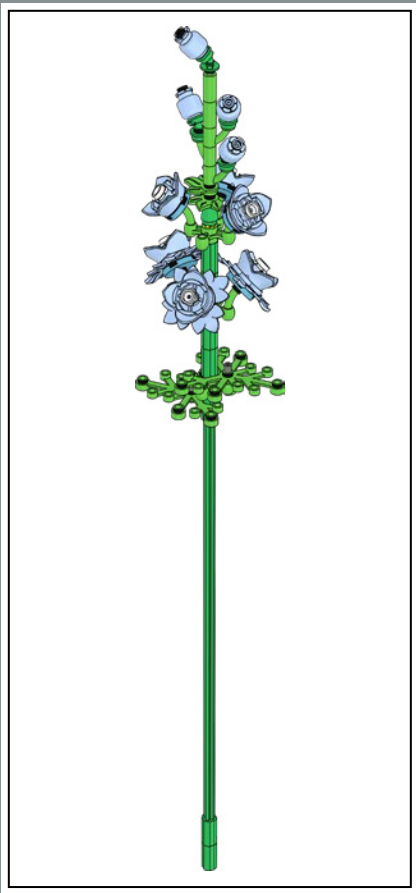

1

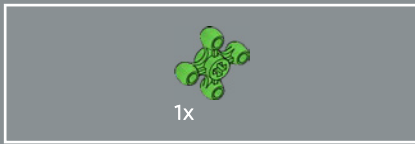
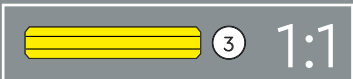
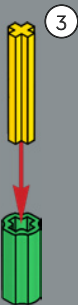

2

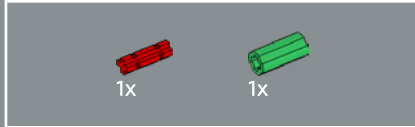
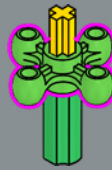

3

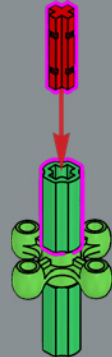

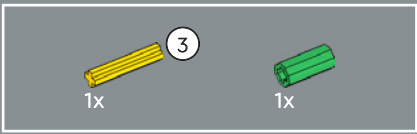

4

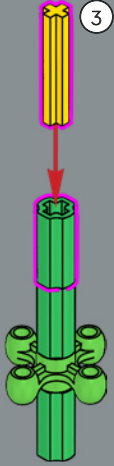

5

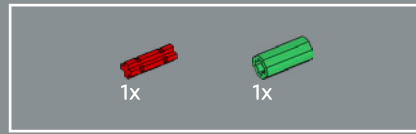
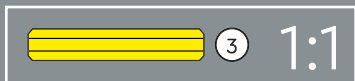
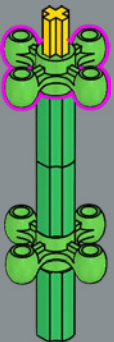

6

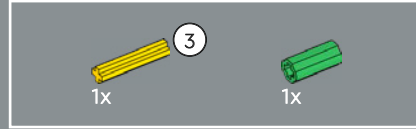
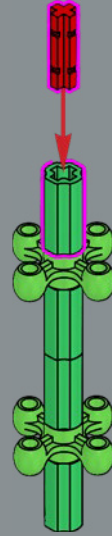

7

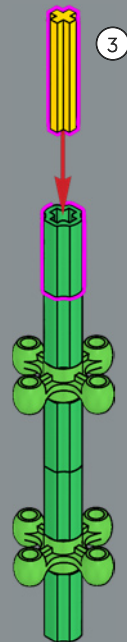

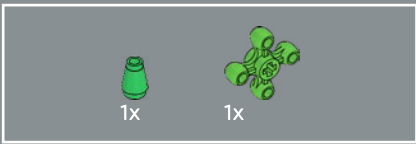

8

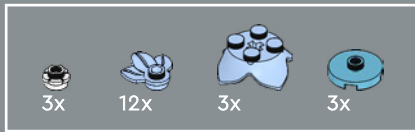
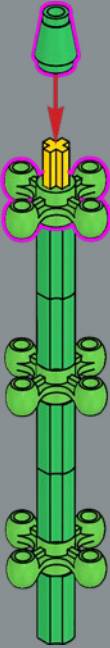

10

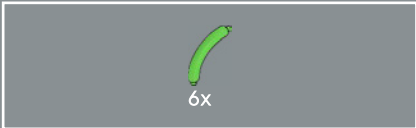
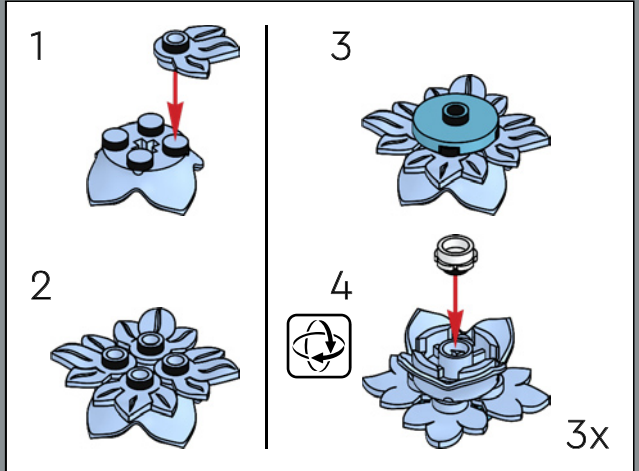

9

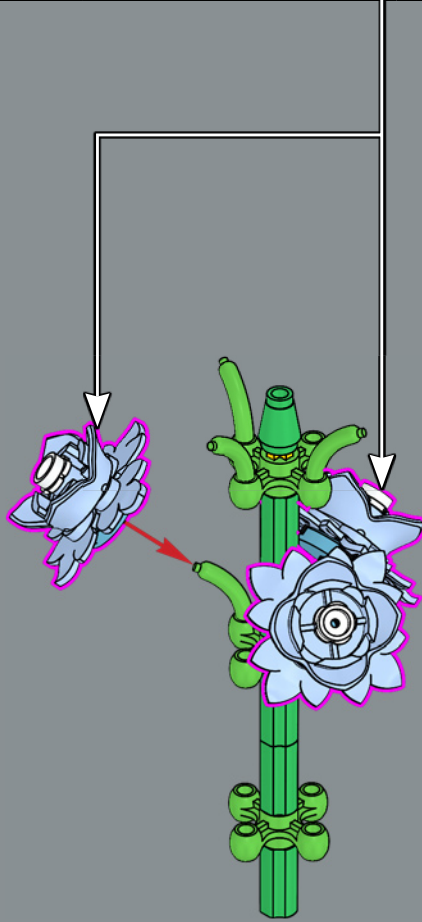
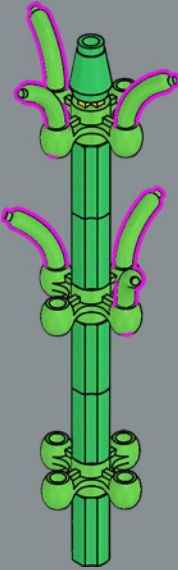



11

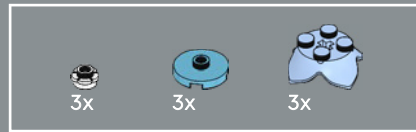
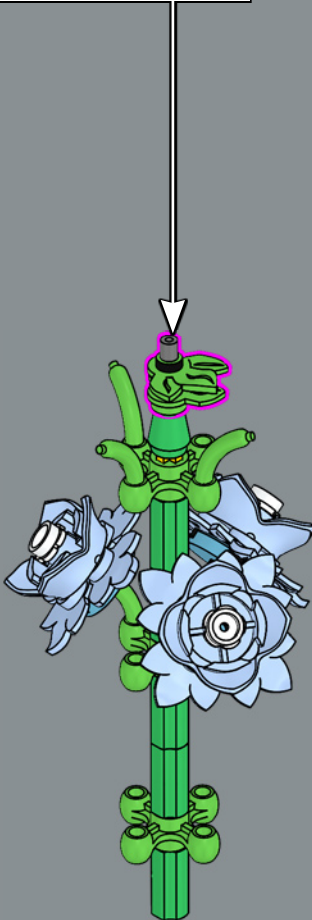
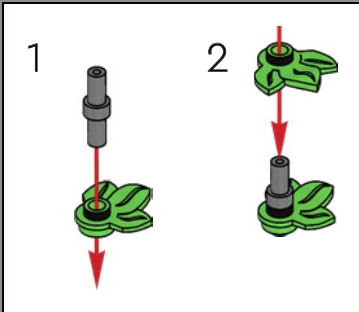

12

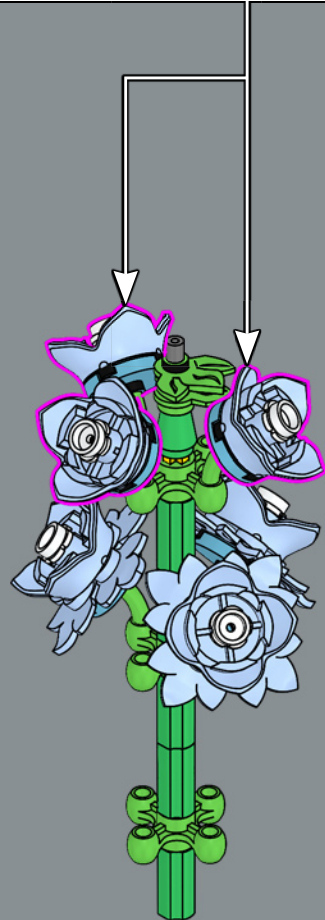
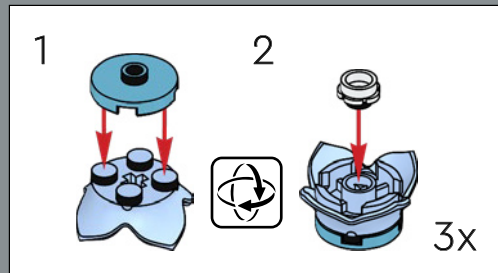

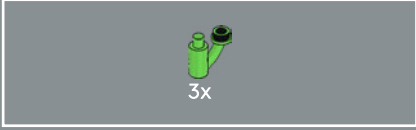
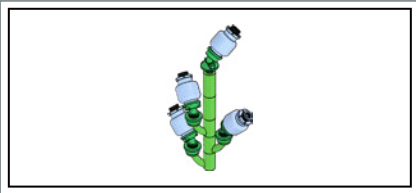

13

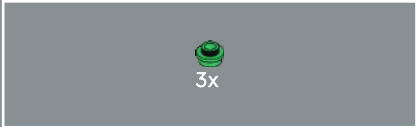

14

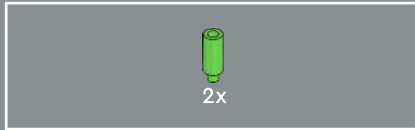
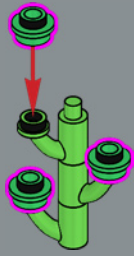

15

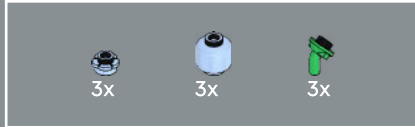
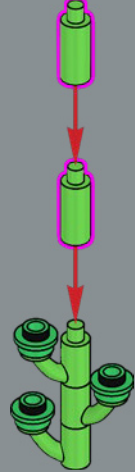

16

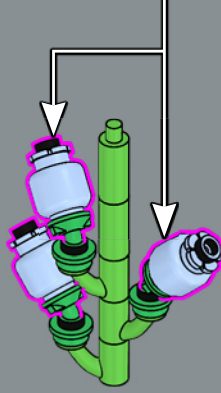
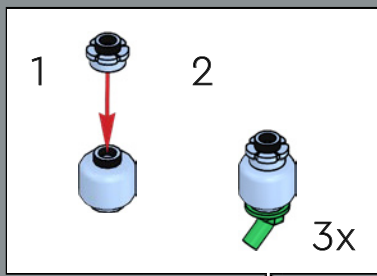



17

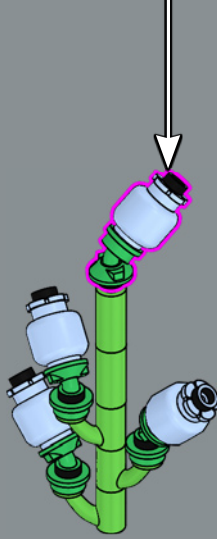
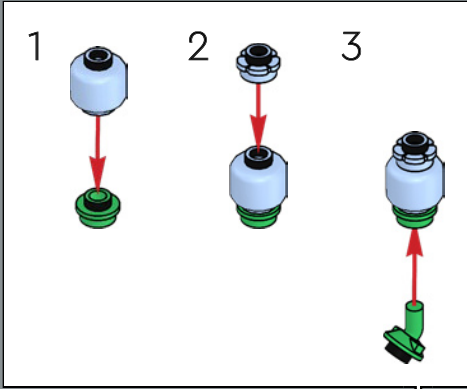

18

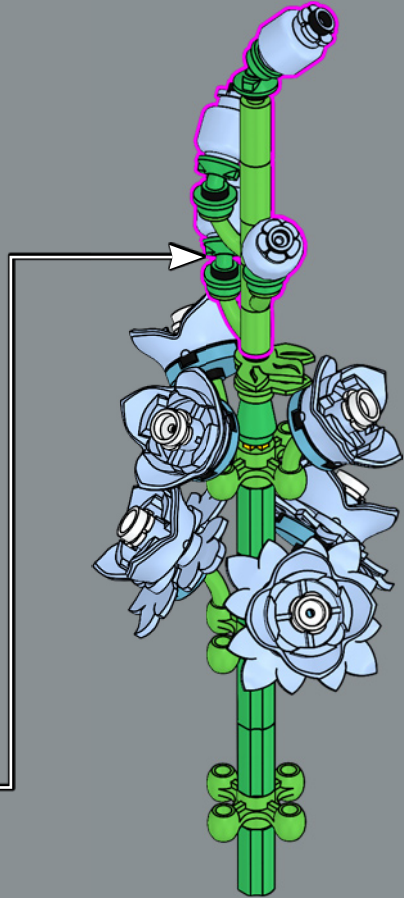

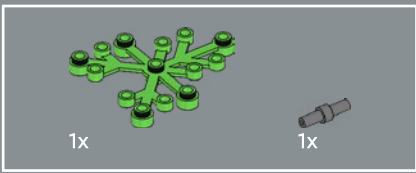

19

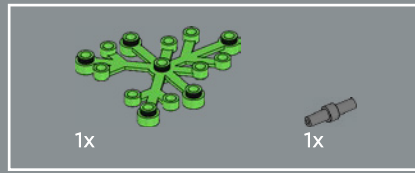
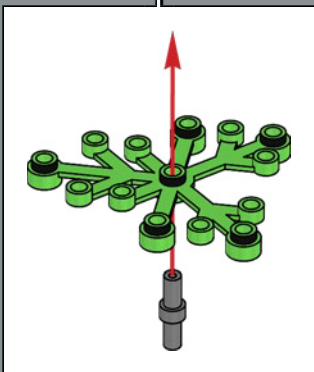
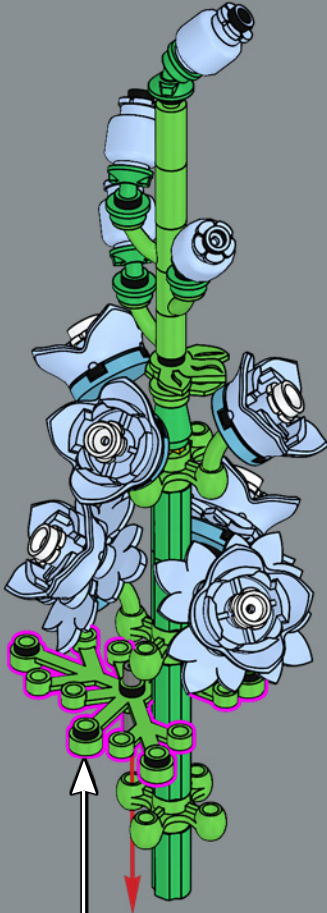

20

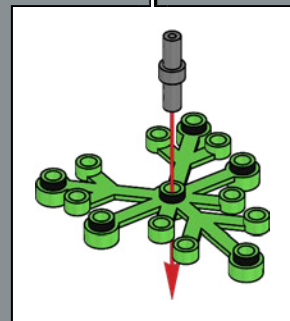
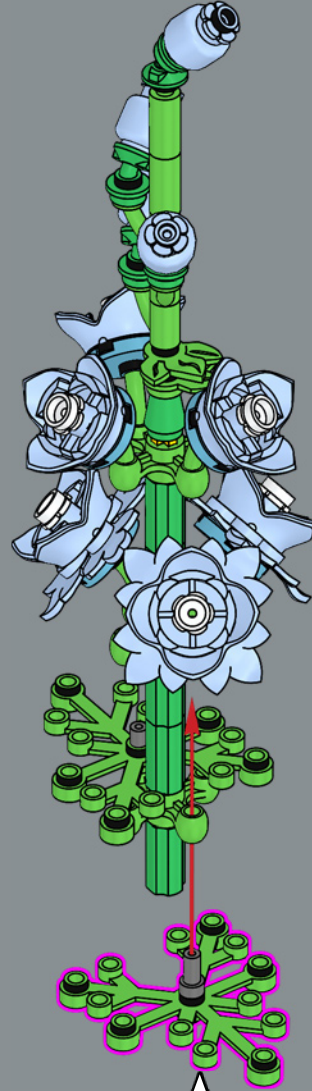

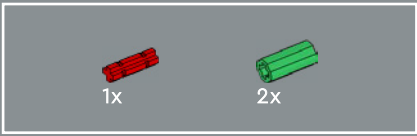

21

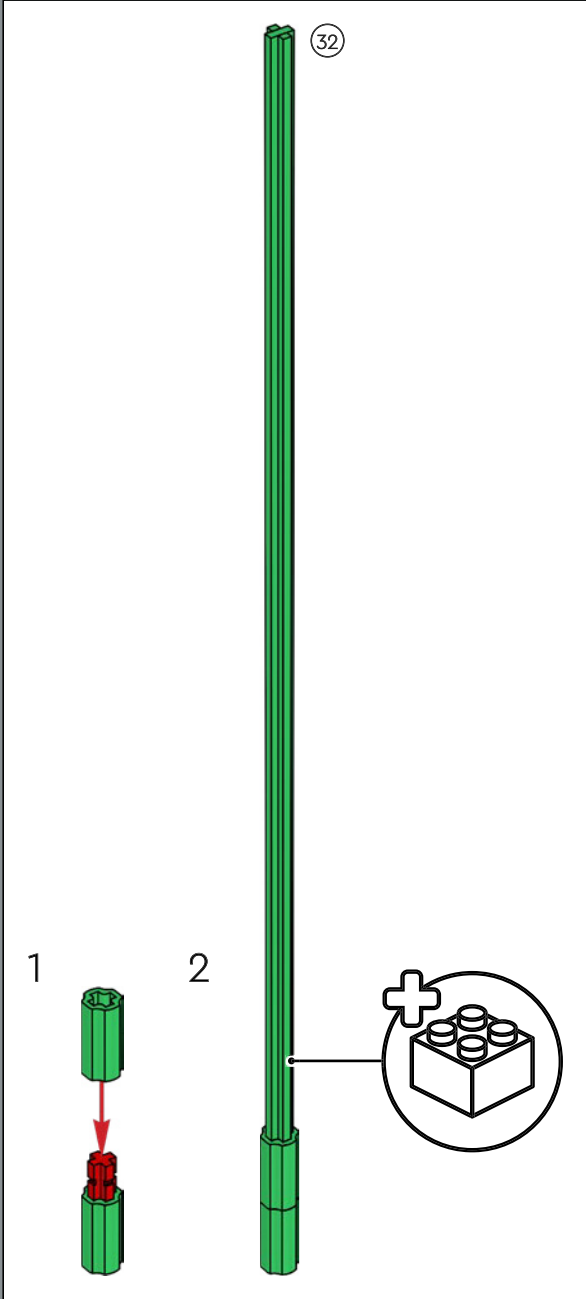
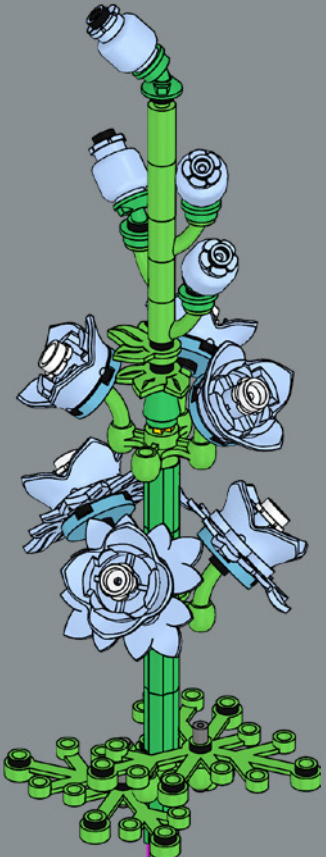

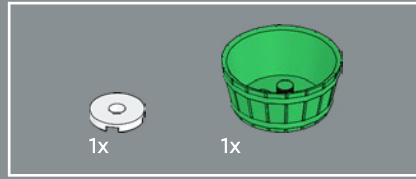
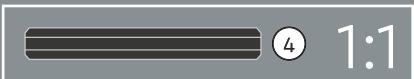
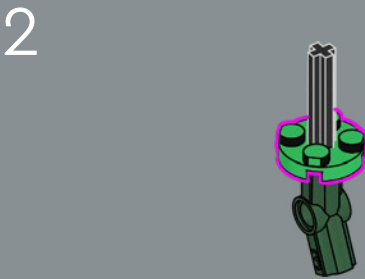
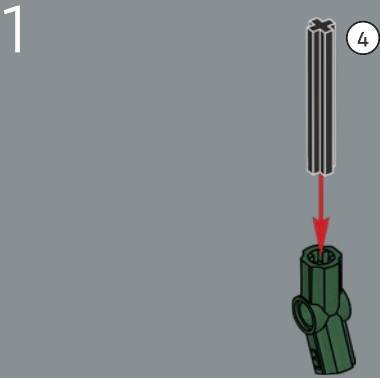
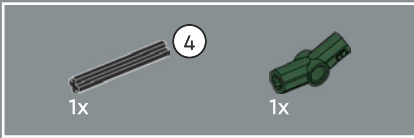

3

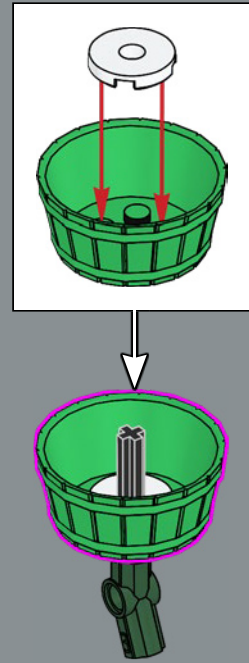

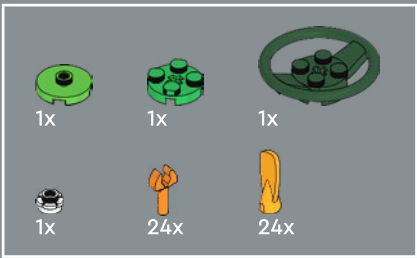

4

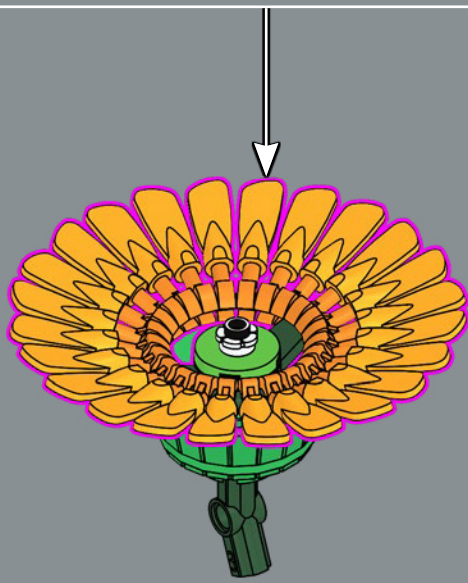
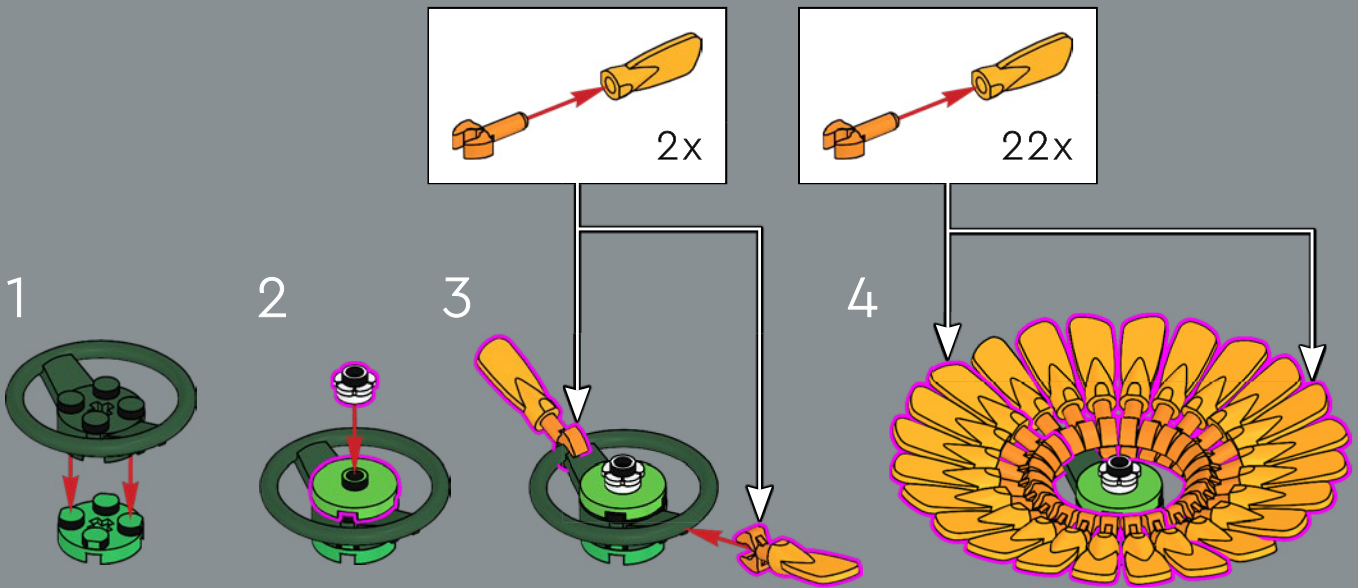

These delicate little petals are actually minifigure oars!



5



6



32

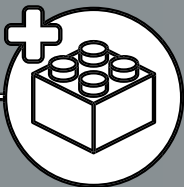



First introduced in 1983 as part of the LEGO® Fabuland theme, this bucket has been used in everything from rocket engines to flower receptacles.

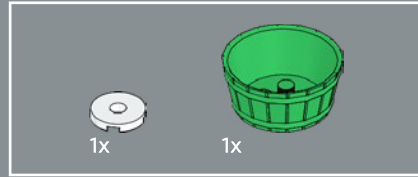
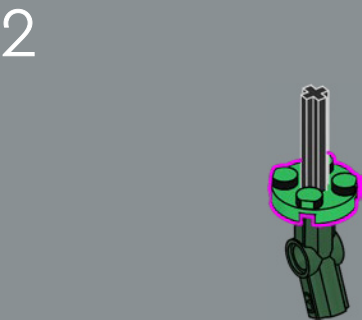
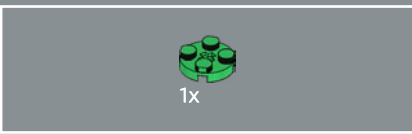
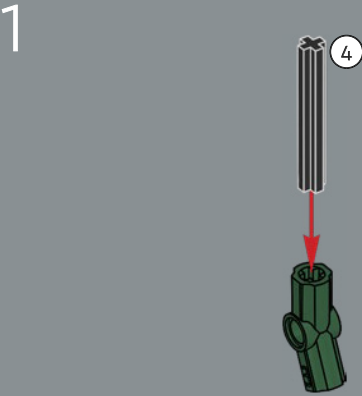
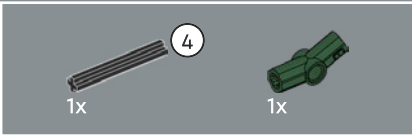

3

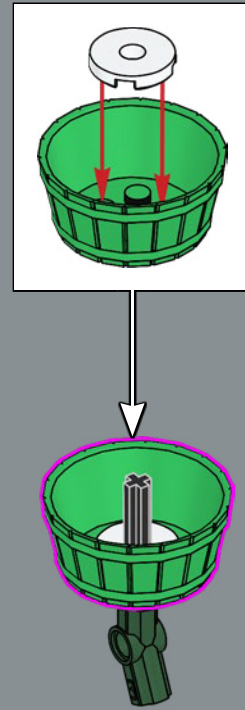

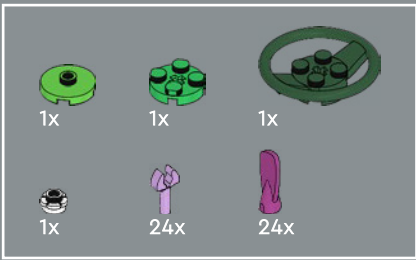

4

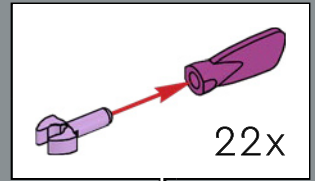
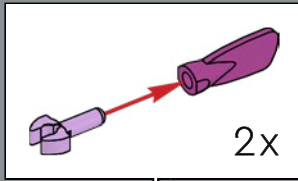

1

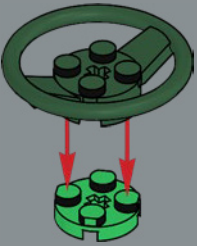

2

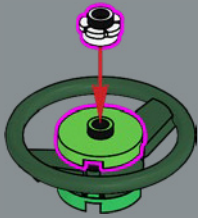

3

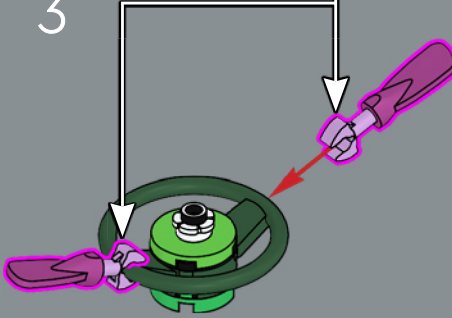

4

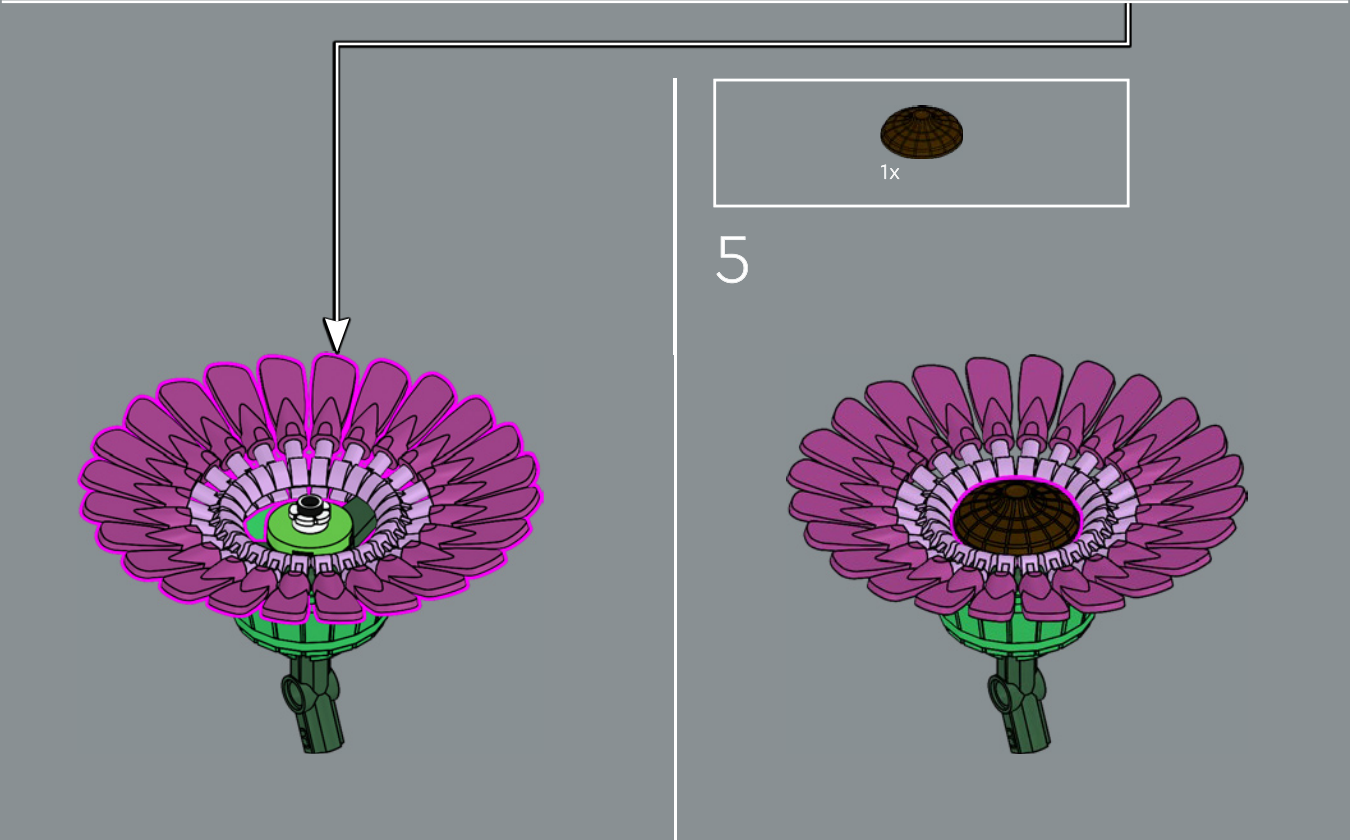
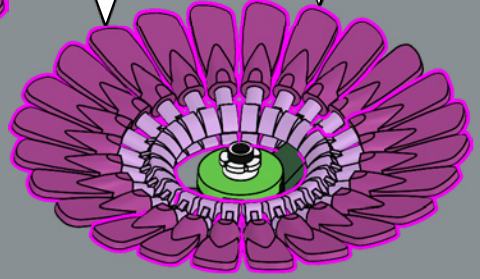

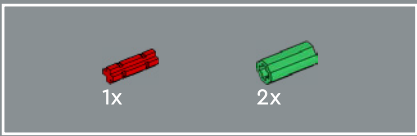

6

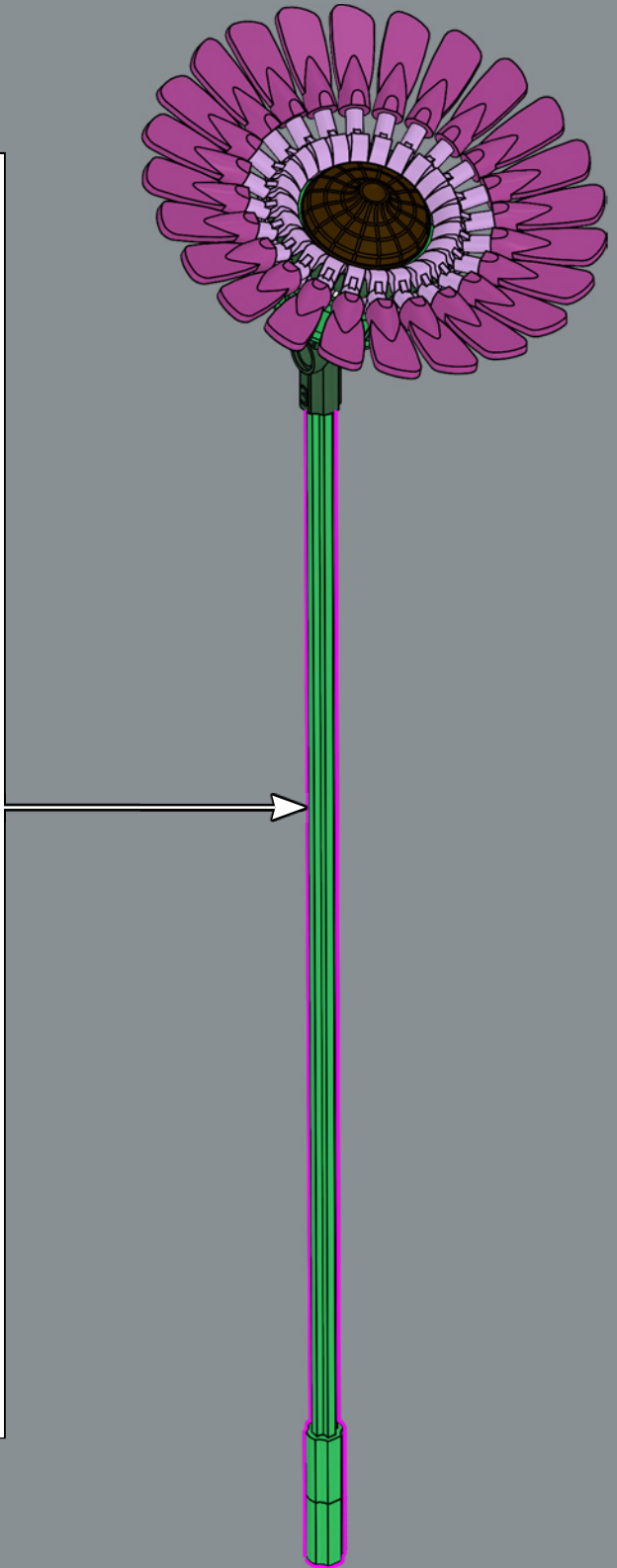
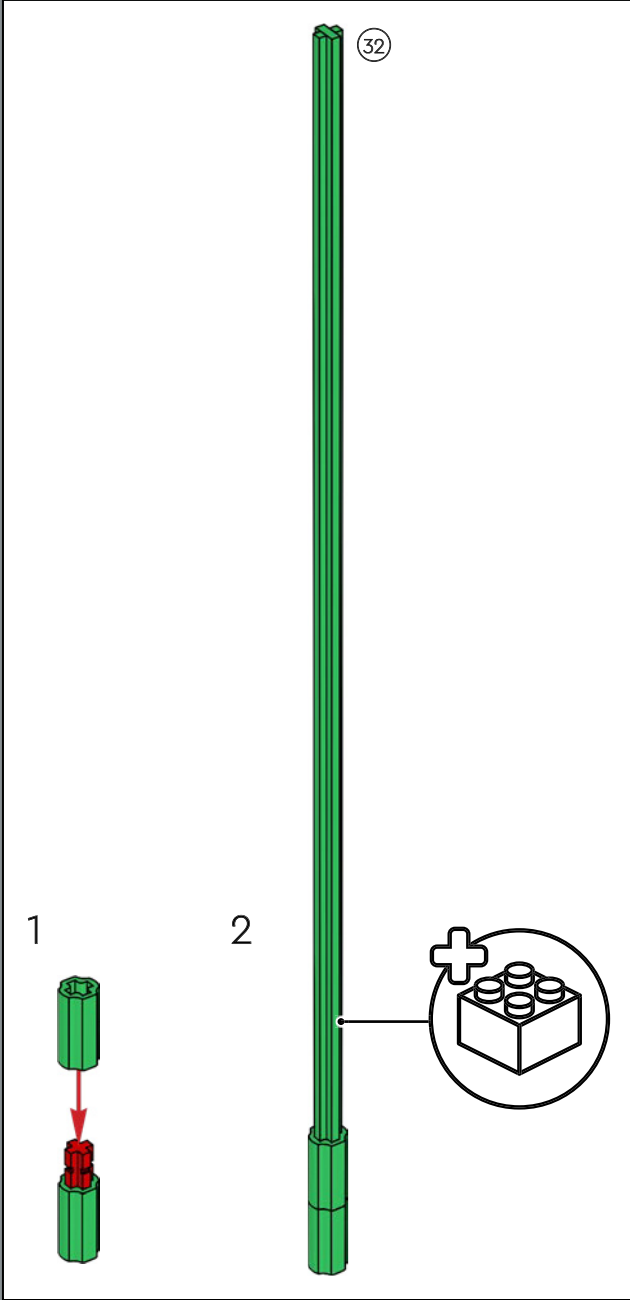

24x
306201

2x
6310185

24x
459901

68x
6206149

2x
6170419

2x
6194512

6x
6259700

6x
6339183

16x
6348056

2x
4515349

8x
6420923

13x
6130007

61x
4142865

3x
6055225

15x
6420219

2x
6329283

8x
6344177

24x
6330196

2x
6329274

24x
6424588

6x
6133765

7x
4211218

12x
6316697

2x
6382540

24x
6420229

24x
6420230

3x
6350724

2x
6116608

11

2x
6178172

4x
6209683

12x
6420914

6x
6420921

4x
6294900

2x
6420922

16x
4566522

5x
6420217

32x
6420916

5x
6420218

8x
6190252

2x
6416732

6x
6136419

24x
6210460

26x
6214235

2x
6329317

24x
6420920

4x
6420918

16x
6267420

11x
4529239

11x
6338221

8x
6210271

8x
403228

2x
6420221

2x
6266964

20x
6269971

11x
6382575

3x
6270084

50x
6374076

2x
6420635

12x
6420964

4x
6380676

10x
6388070

5x
6182261

2x
6345196

7x
6161772

7x
6328327

7x
6420228

3x
6331087

6x
6430093

3x
6420915

1x
6254100

24x
6278159

4x
6174006

2x
6302741

60x
6190251

10x
6314224

4x
6167483

16x
6420919

24x
6420220

3x
6267045

3x
6265699

2x
370526

32



LEGO.com/service



YOU COULD WIN



YOU COULD WIN

Your feedback will help shape the future development of this product series.

Visit:

DU KÖNNTEST GEWINNEN

Dein Feedback trägt zur Weiterentwicklung dieser Produktreihe bei.

Geh auf:

VOUS POURRIEZ GAGNER

Vos commentaires nous aideront à concevoir les futurs produits de cette gamme.

Visitez :

POTRESTI VINCERE TU

La tua opinione ci aiuterà a migliorare la creazione futura di questa linea di prodotti.

Visita:

PUEDES GANAR

Tu opinión contribuirá al futuro de esta serie de productos.

Visita:

轻松获奖

您的反馈将有助于我们在今后改进本产品系列。

请访问:

LEGO.com/productfeedback

You also have the chance to win a LEGO® set.

Terms and conditions apply.*

Außerdem hast du die Chance, ein LEGO® Set zu gewinnen.

Es gelten die Teilnahmebedingungen.*

Vous pourriez également gagner un ensemble LEGO®.

Des conditions s'appliquent.*

Hai anche la possibilità di vincere un set LEGO®.

Termini e condizioni sono applicabili.*

También tienes la oportunidad de ganar un set LEGO®.

Aplican términos y condiciones.*

您还有机会赢取乐高®套装。

条款和条件适用。*

*LEGO.com/productfeedback-terms

