





21308



-  Booklet available in English on
-  Heft in deutscher Sprache erhältlich auf
-  Livret disponible en français sur
-  Folheto disponível em espanhol en
-  Folheto disponível em português em
-  A füzet magyarul ezen a honlapon olvasható
-  Libretto disponibile in italiano su
-  如需中文版手册，请访问 [www.LEGO.com/ideas](http://www.LEGO.com/ideas)

# It's Adventure Time™!

Finn and his best friend and adopted brother, Jake, roam the Land of Ooo, righting wrongs and battling evil. Along the way, they make friends with a whole range of wacky characters such as Princess Bubblegum, Lady Rainicorn and Marceline the Vampire Queen. They also have to deal with the grumpy Ice King, the mean ruler of the Ice Kingdom, who really needs to chill out.

The animated television series created by Pendleton Ward has achieved both cult status and widespread popularity, and is now also the 16th set in the LEGO® Ideas series.





## Finn

Finn is a silly kid who wants to become a great hero one day. He might not look too tough, but if there's evil around, he'll slay it. That's his deal.



## Jake

Finn's best friend is a wise old dog with a big heart. Jake has the magical ability to stretch and grow. When evil's not running amok, he plays viola with his girlfriend, Lady Rainicorn.

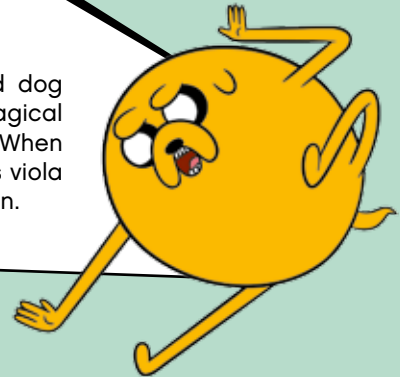



## BMO

BMO is much more than just Finn and Jake's roommate. Beemo is also their friend, camera, alarm clock and video game system.

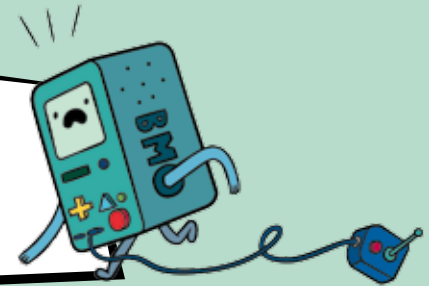

## Marceline

Marceline is a wild rocker girl. Centuries of wandering the Land of Ooo have made her a Fearless daredevil.





## Lady Rainicorn

Lady Rainicorn is Princess Bubblegum's loyal and majestic pet. Her love of the viola makes her a perfect match for Jake.



## Princess Bubblegum

As a millionaire geek enthusiast, Princess Bubblegum immerses herself in every branch of geekdom from rocket science to turtle farming.





## Ice King

Armed with a magic crown and an icy heart, the Ice King has only one goal: to secure a wife by any means necessary.



## Gunter

Gunter is the name the Ice King gives to all of his penguin servants, yet he pronounces it differently depending on the penguin's personality.





[LEGO.com/brickseparator](https://LEGO.com/brickseparator)

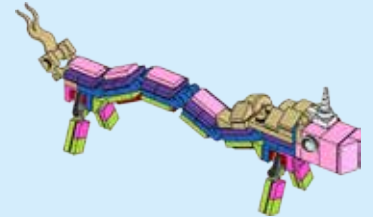
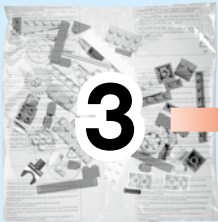
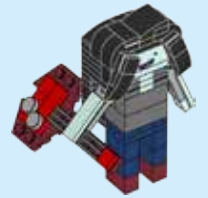
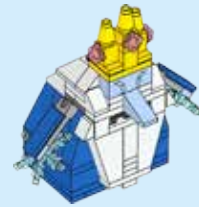
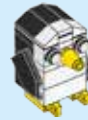
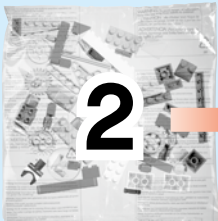
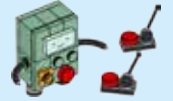

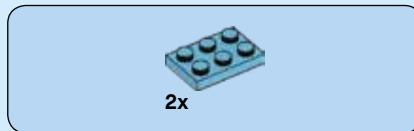
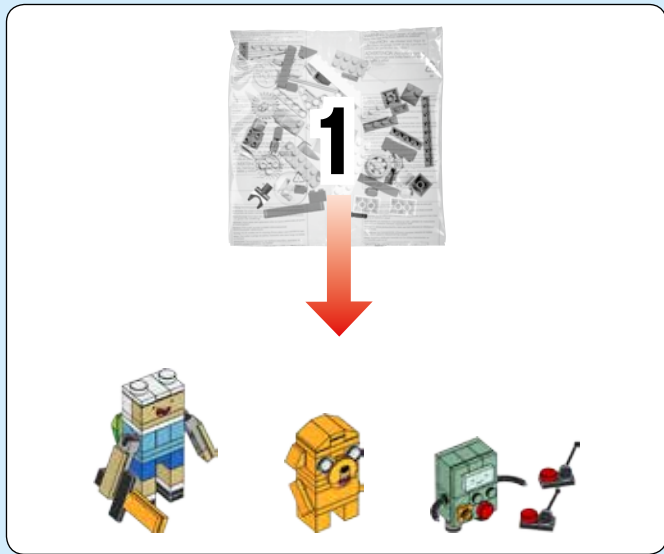

1

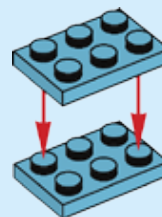



2

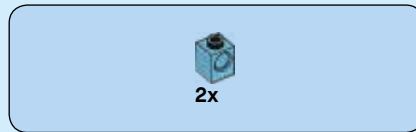
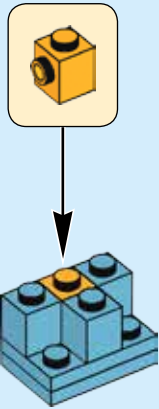

3

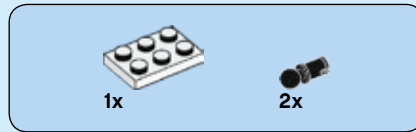
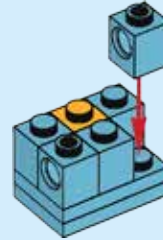

4

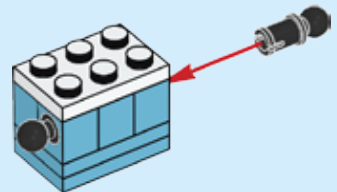

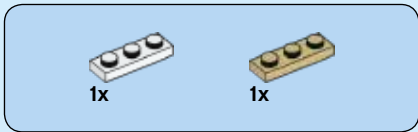

5

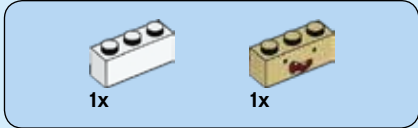
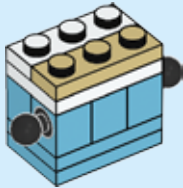

6

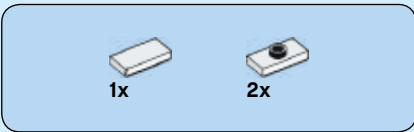
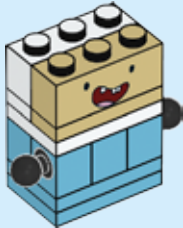

7

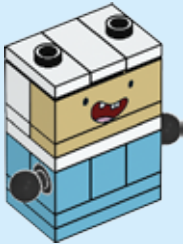

8

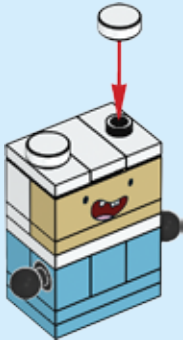



9

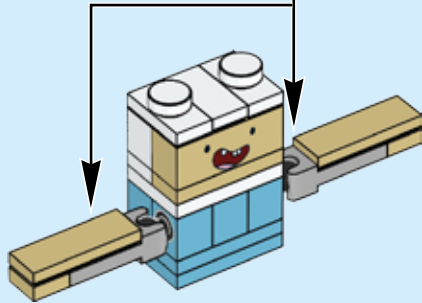
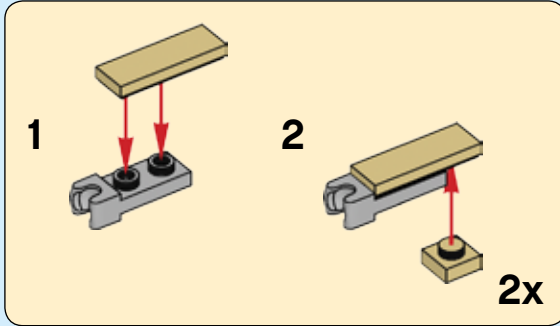

10

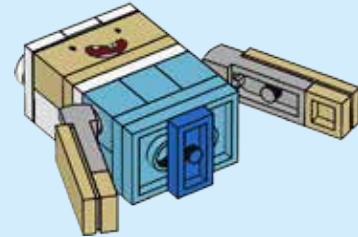
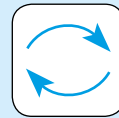

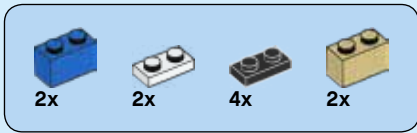

11

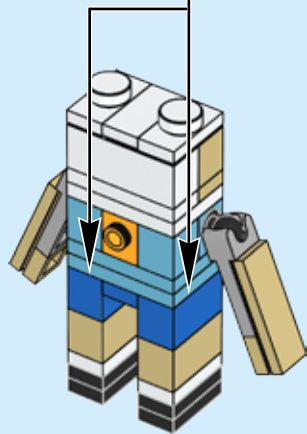
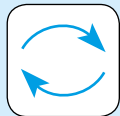
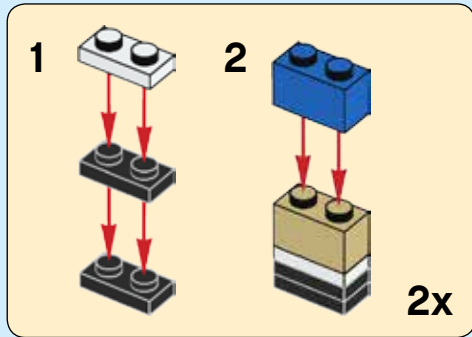

12

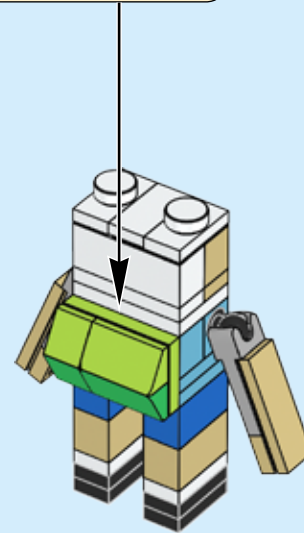
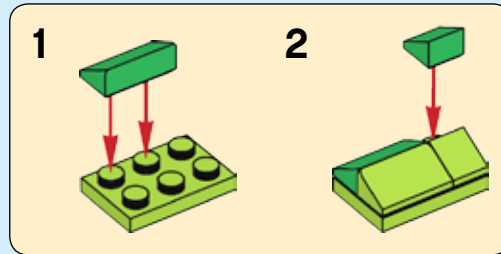

*"You're beautiful on the inside,  
like, your brain and stuff"*

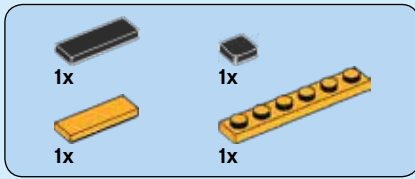

**13**

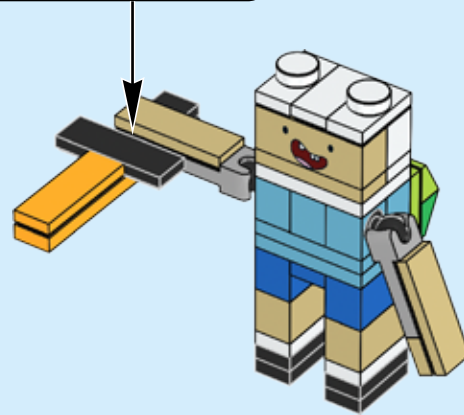
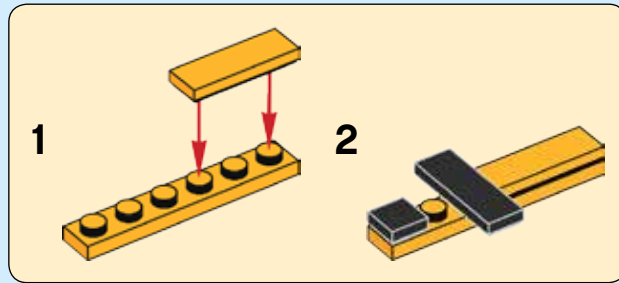
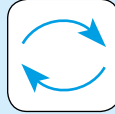



14



15

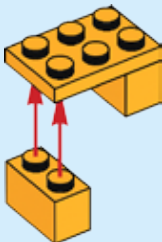

16

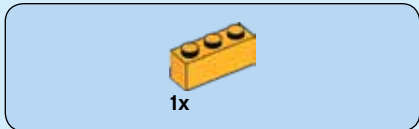
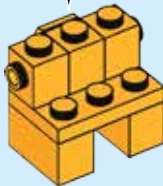
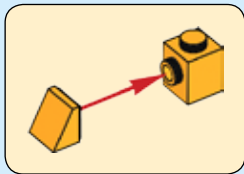

17





18

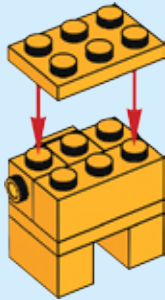

19

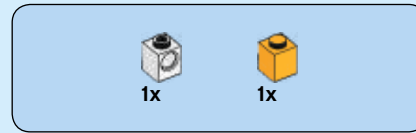
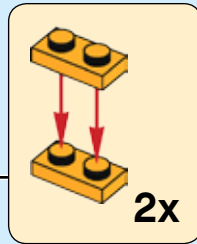
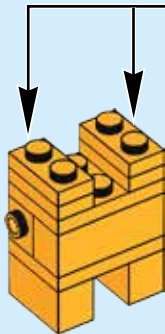

20

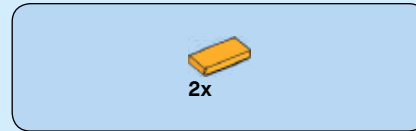

21

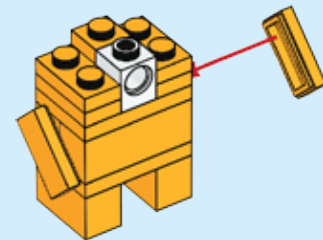



2x

22

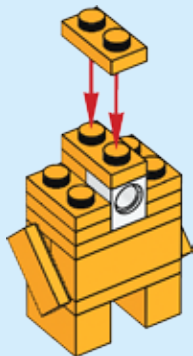

4x

23

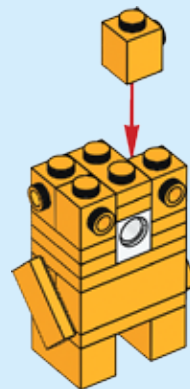



24

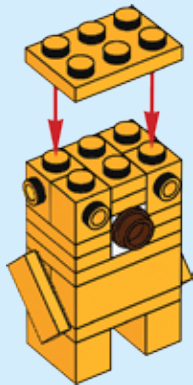

25

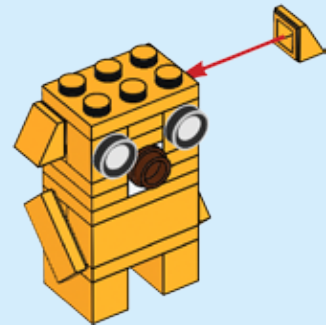



26

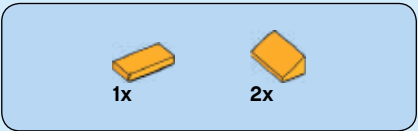

27

"Just do whatever you want, man.  
As long as it comes from the inside"

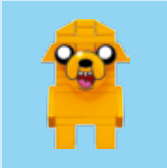

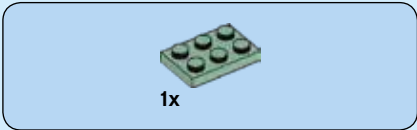
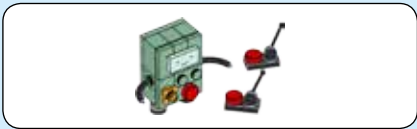

1x

**28**

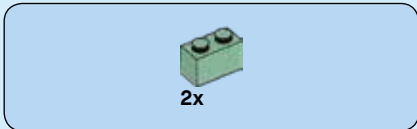
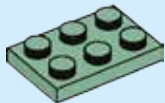

2x

**29**

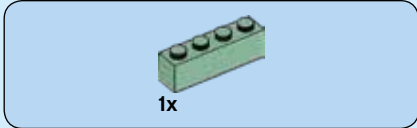
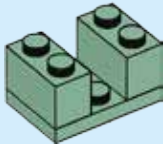

1x

**30**

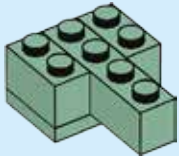



1x

31

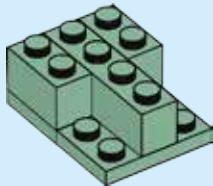

4x

32

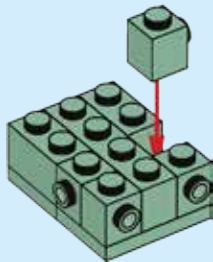

2x



1x



3x

33

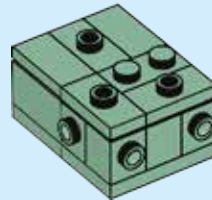

2x



1x



1x



1x

34

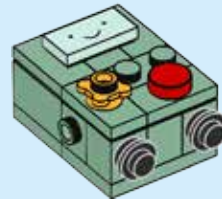



35

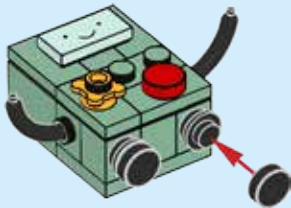

"Let's play video games!"



36

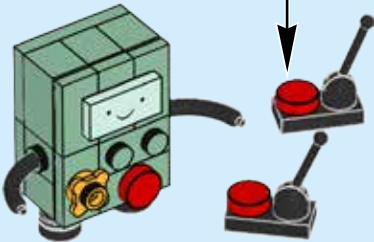
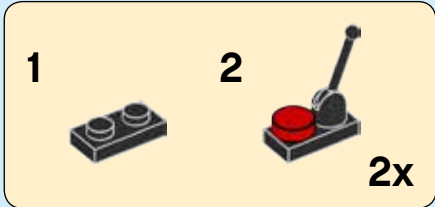
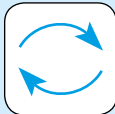

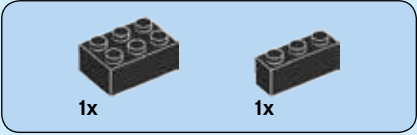
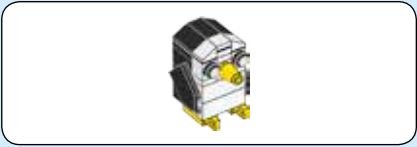
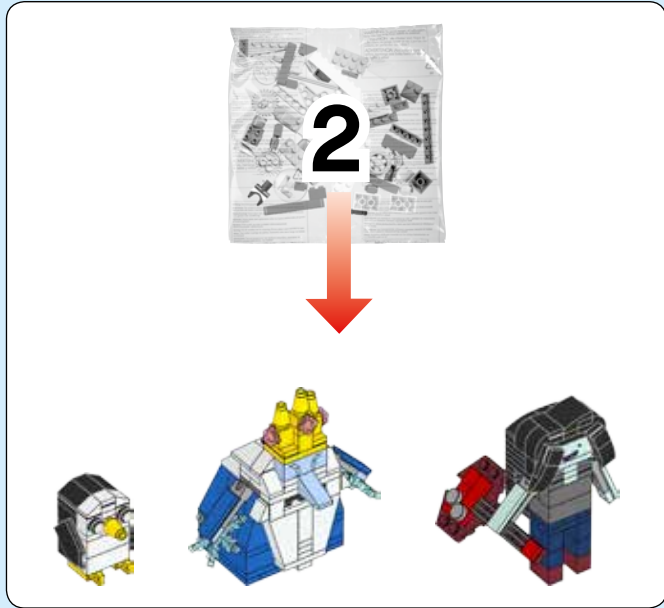

**37**

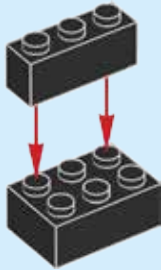



2x

38

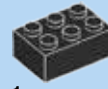
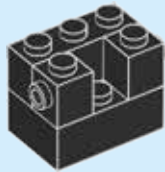

1x

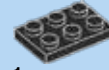

1x

39

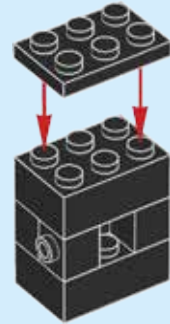

1x

40

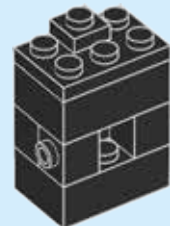

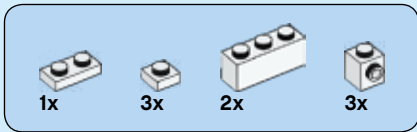

# 41

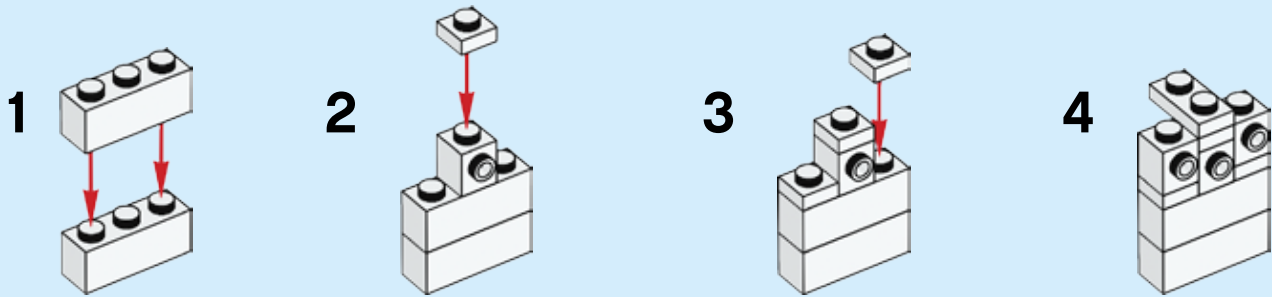

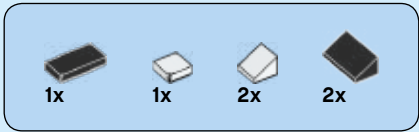

42

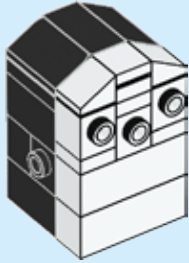
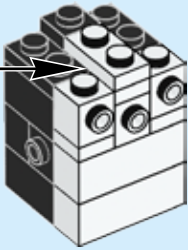



2x

43

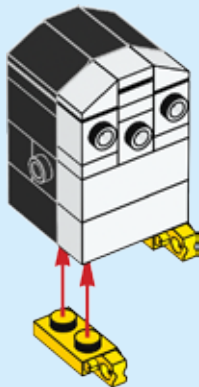

2x

44

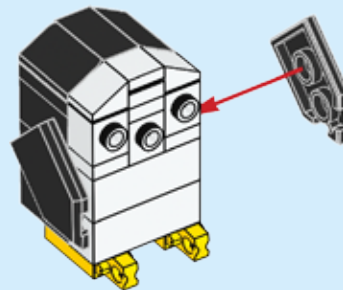



1x



2x

45

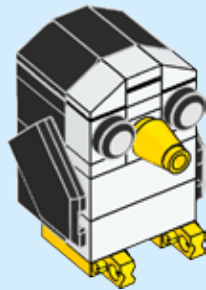

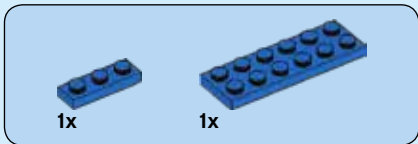
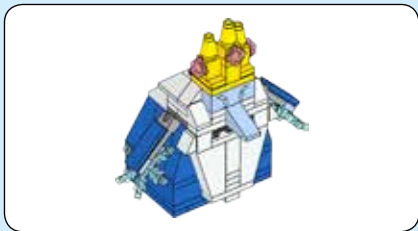

46

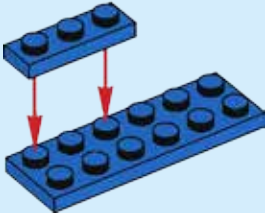

47

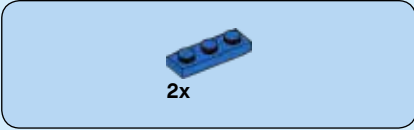
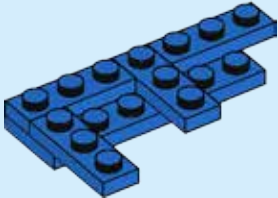

48

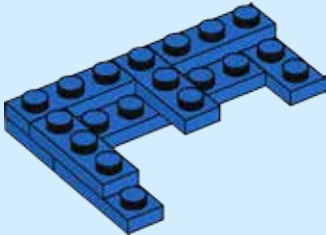

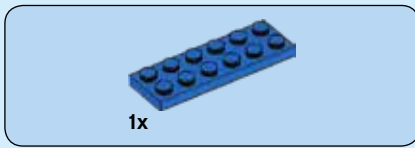

**49**

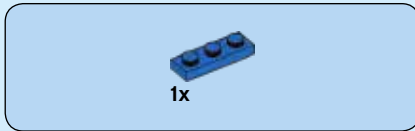
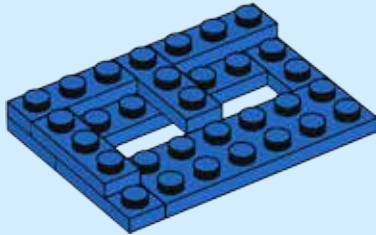

**50**

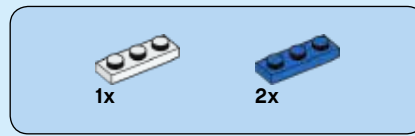
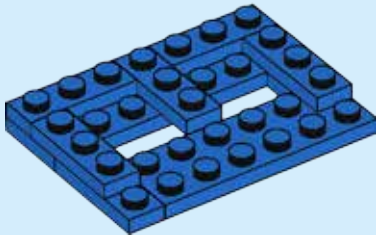

**51**

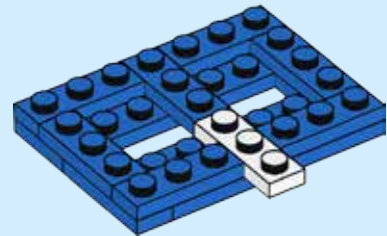

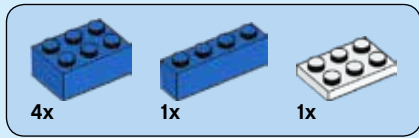

52

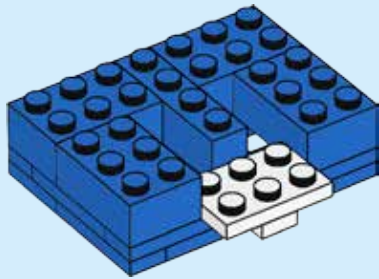

53

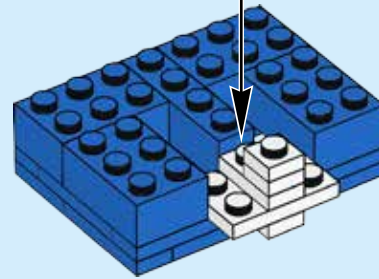
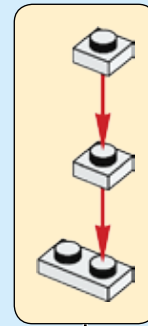

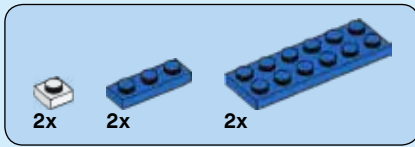

54

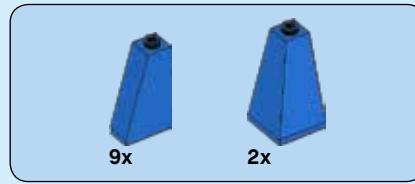
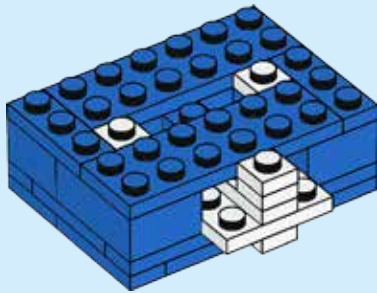

55

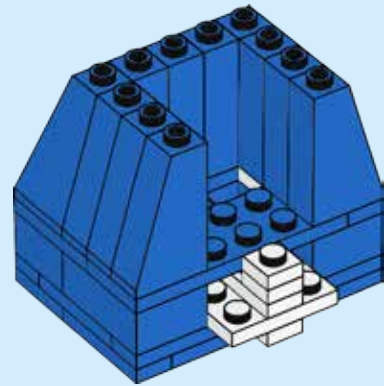

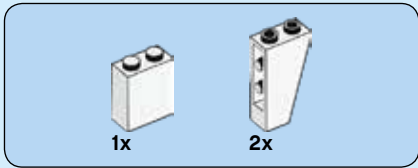

56

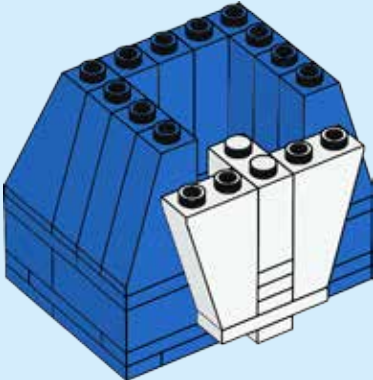

57

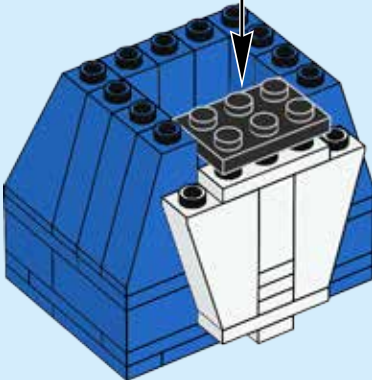
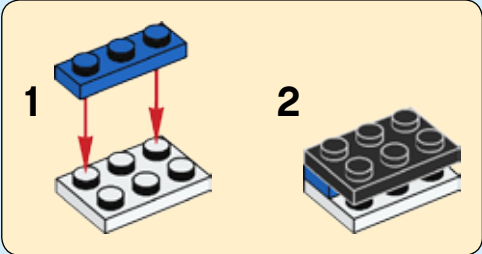

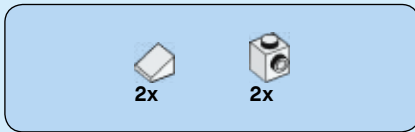

58

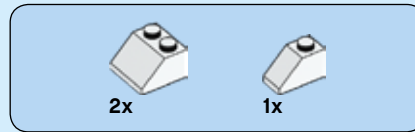
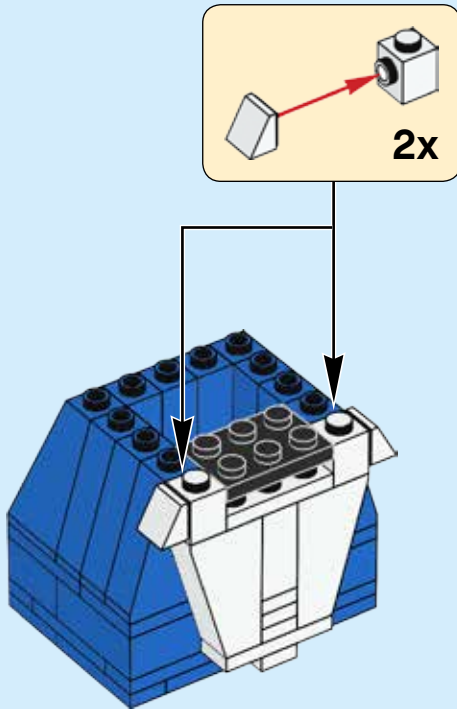

59

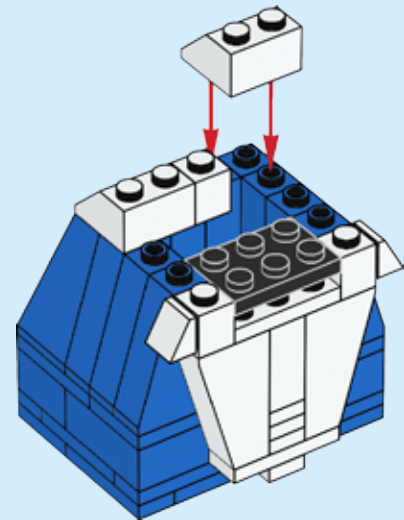

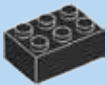

1x

60

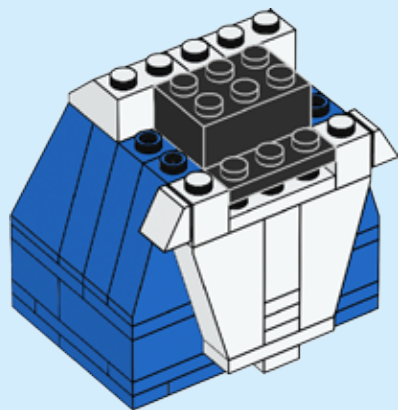

2x



2x

61

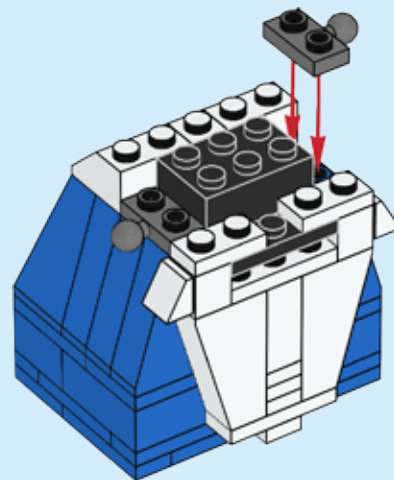

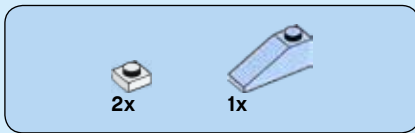

62

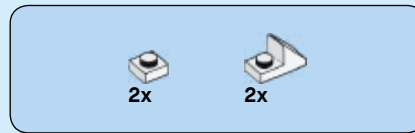
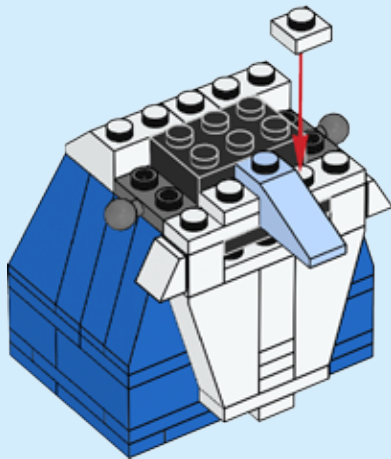

63

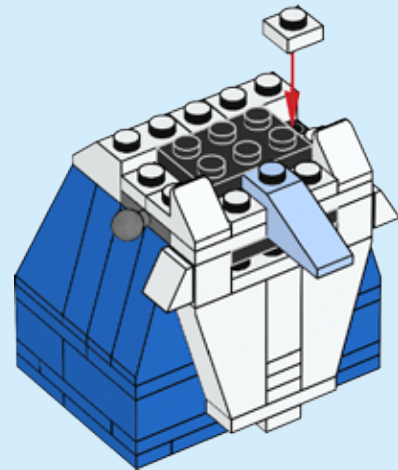

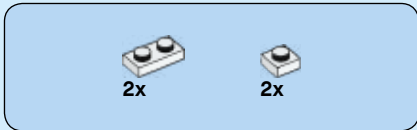

# 64

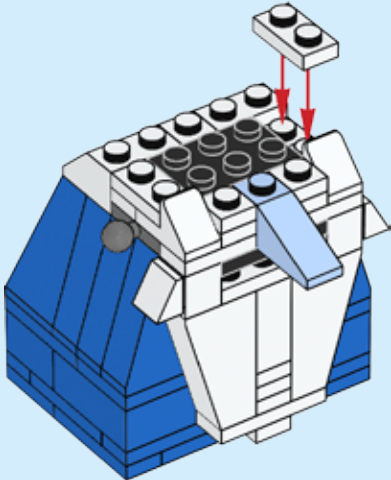

# 65

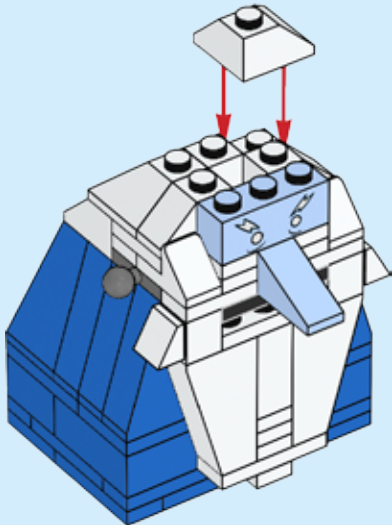



66

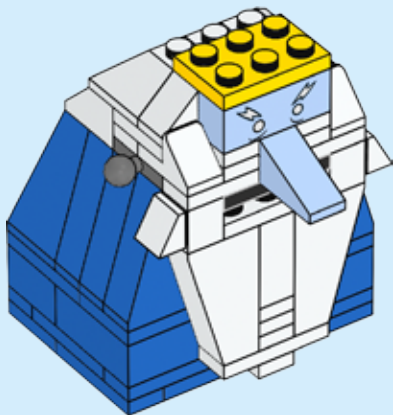

67

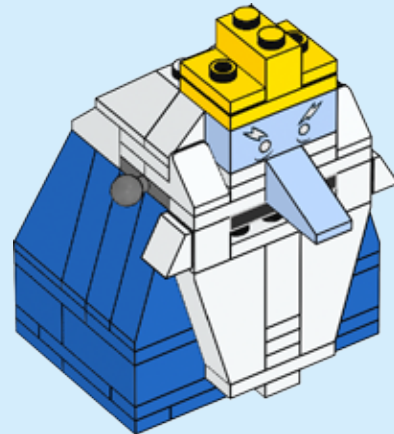



68

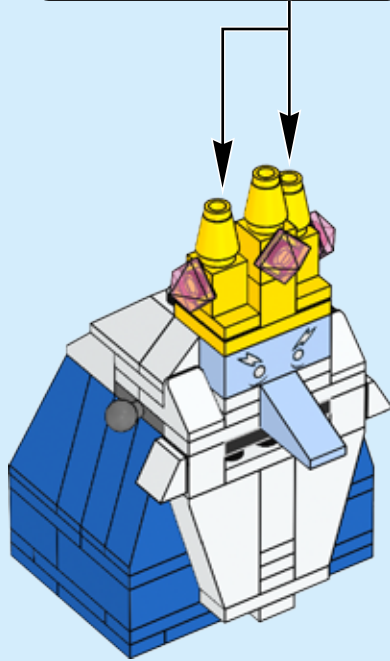
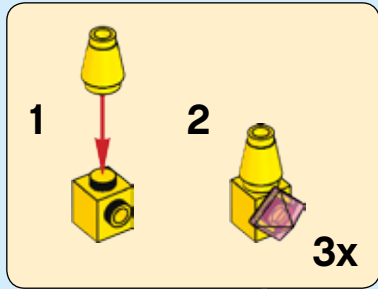

"I love you everything burrito"

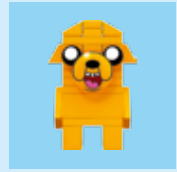

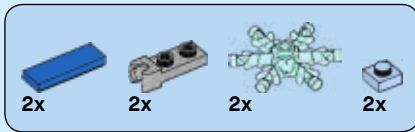

69

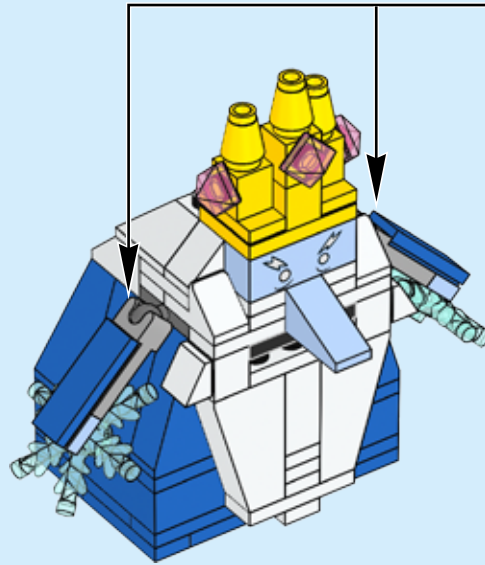
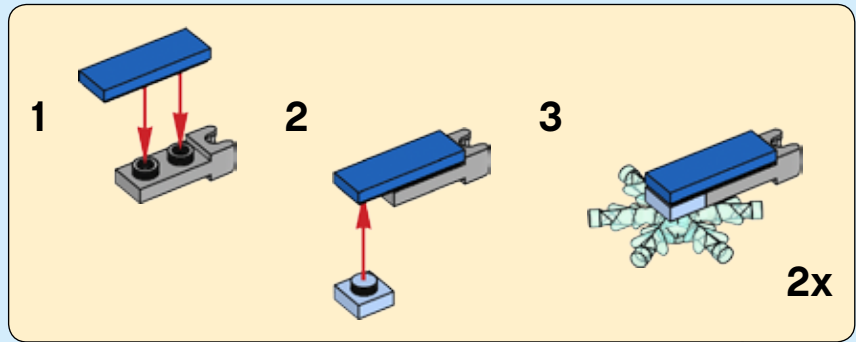

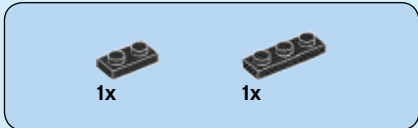
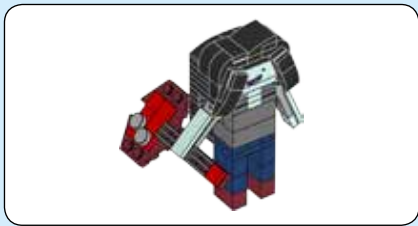

70

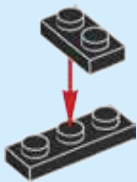

71

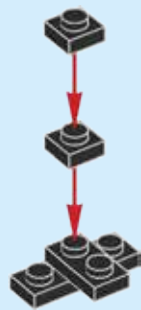

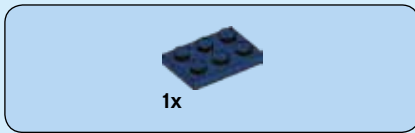

72

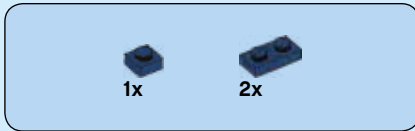
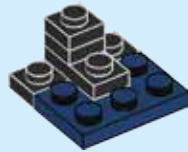

73

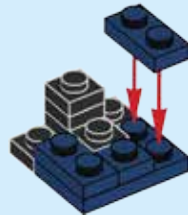

74

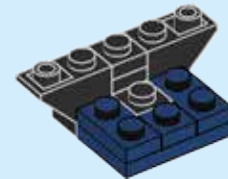

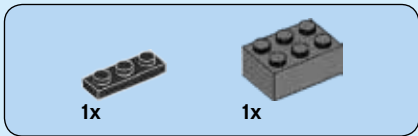

75

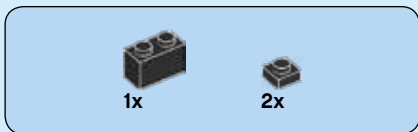
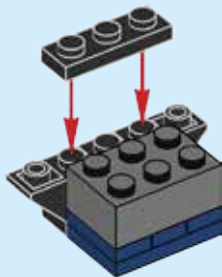

76

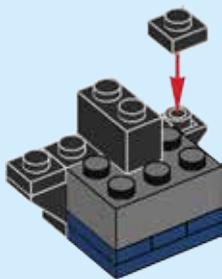

77

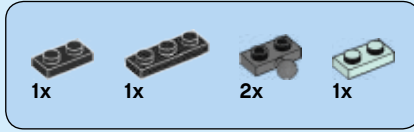
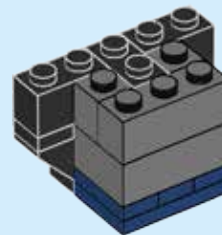

78

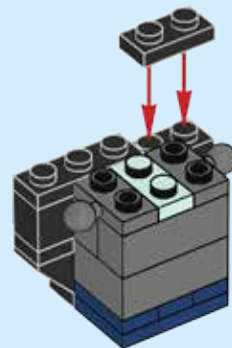

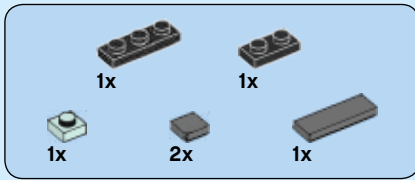

79

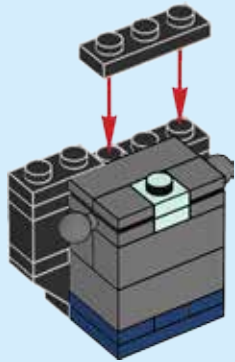

80

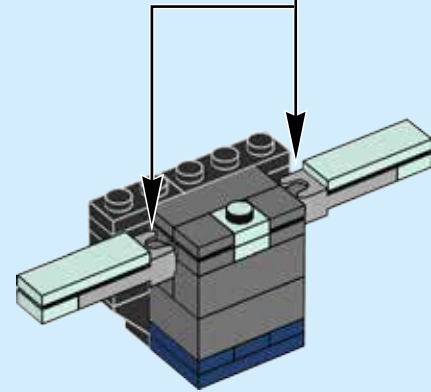
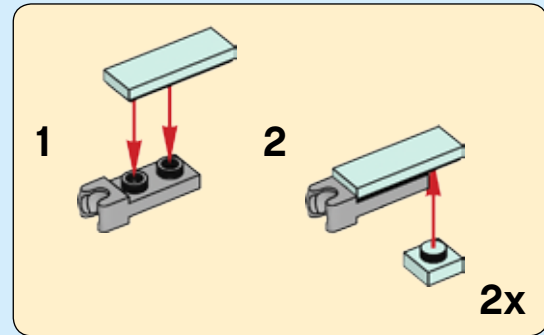



1x



1x

# 81

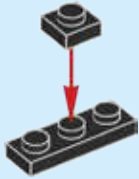

2x

# 82

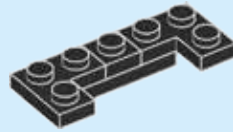

2x

# 83

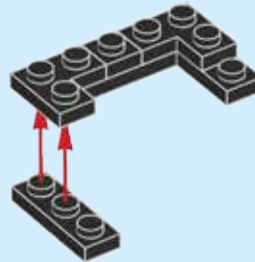

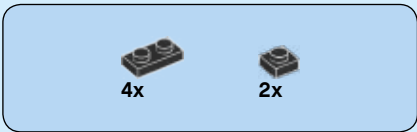

84

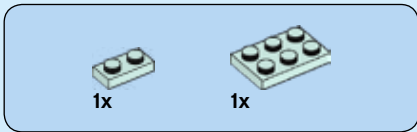
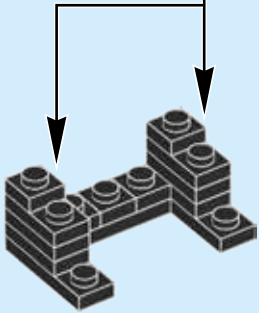
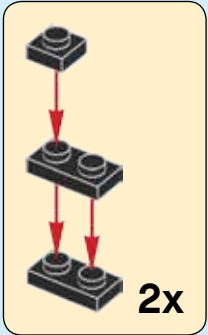

85

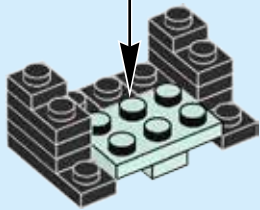
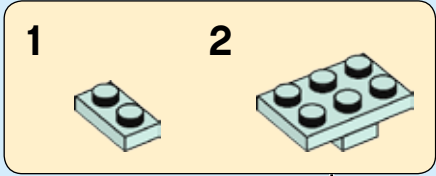

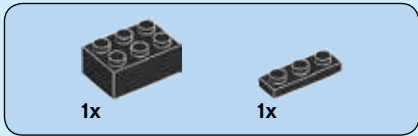

86

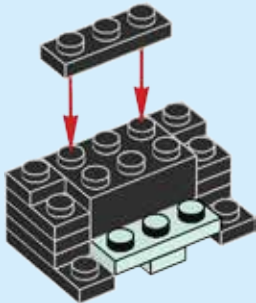

87

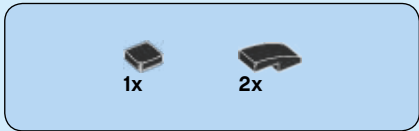
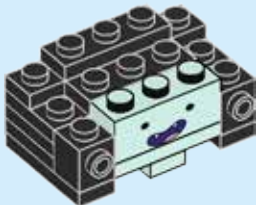

88

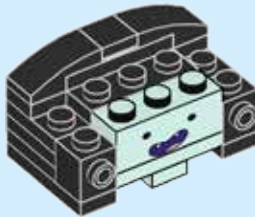

89

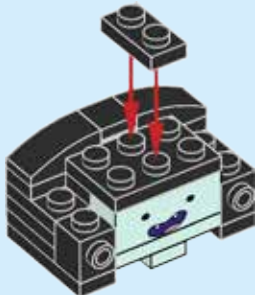



90

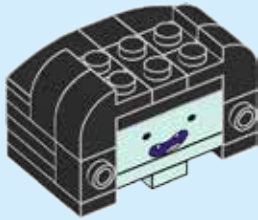

91

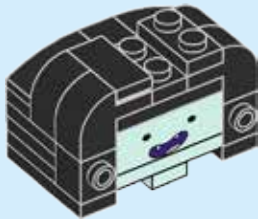

92

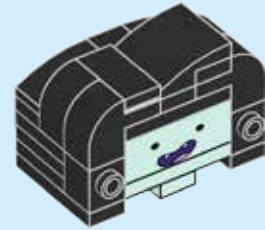

93

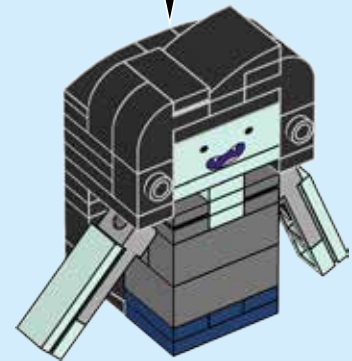



94

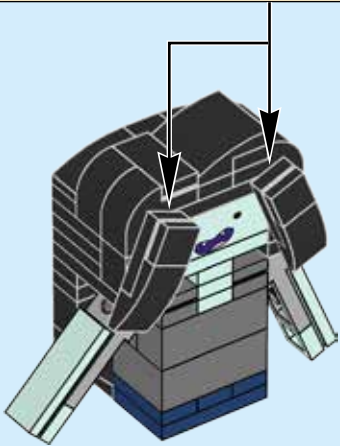
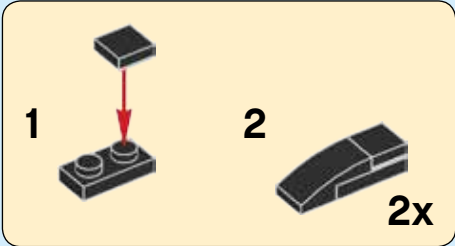

95

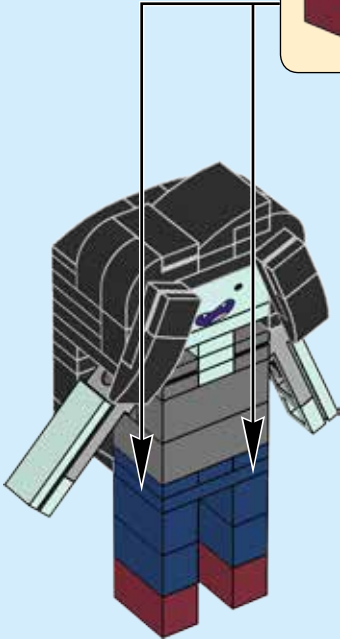
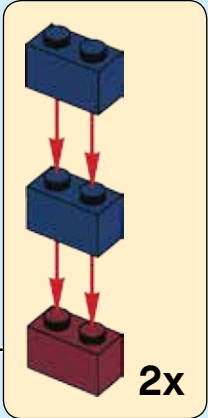



96



97

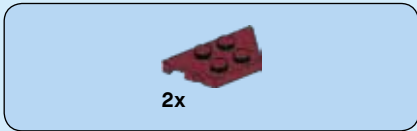
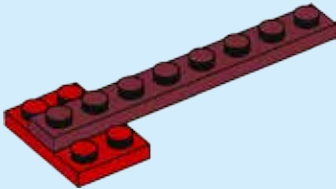

98

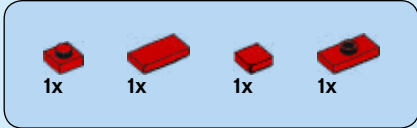
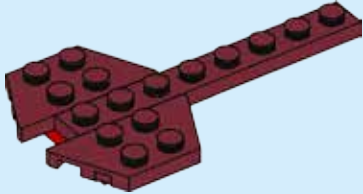

99

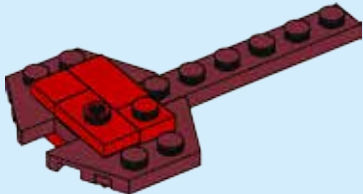

1x 2x 2x

100

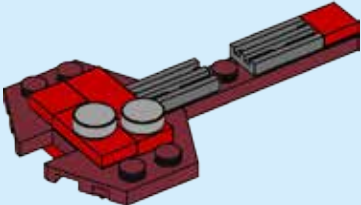

101

"Sorry I'm not made of sugar"

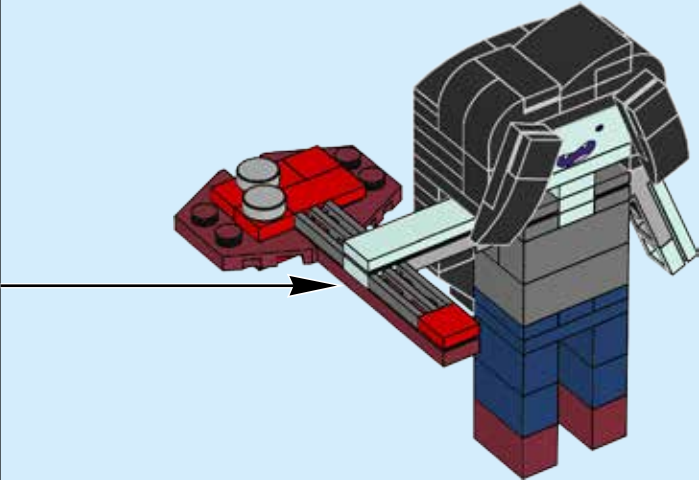
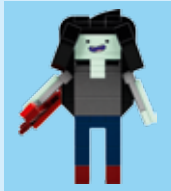

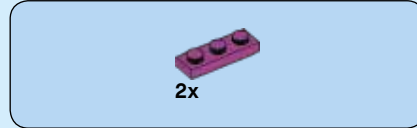
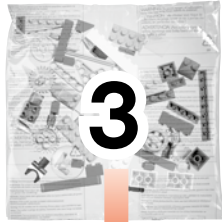

102

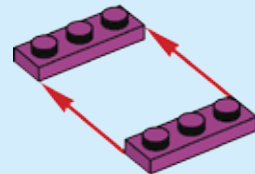



2x

103

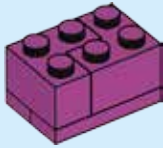

2x

104



2x



1x

105

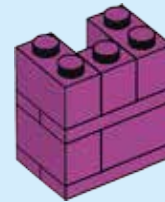

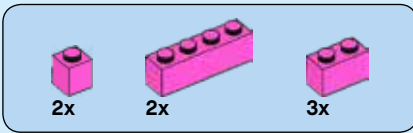

# 106

1

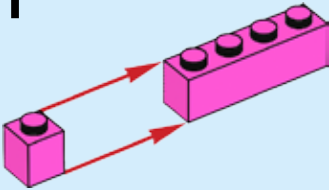

2

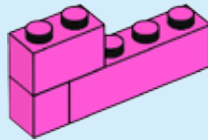

3

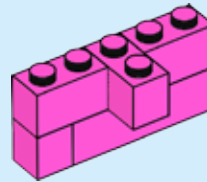

4

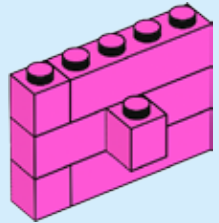

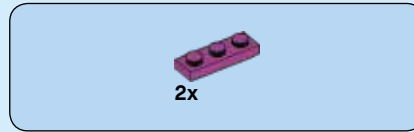
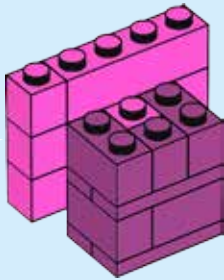

**107**

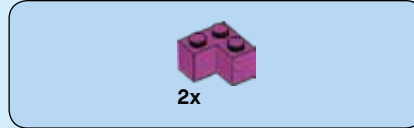
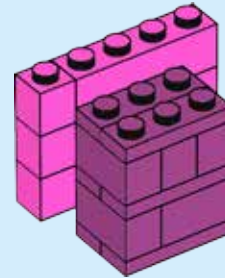

**108**

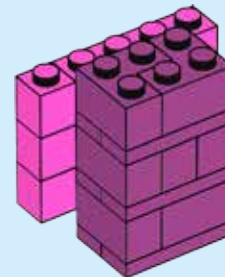

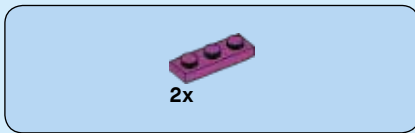

109

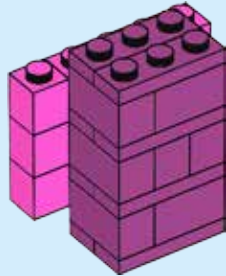

110

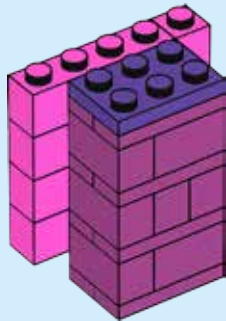

111



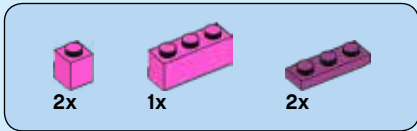

112

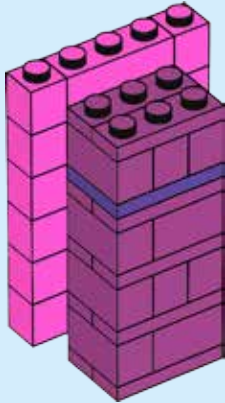

113

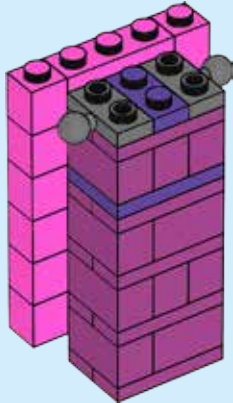

114

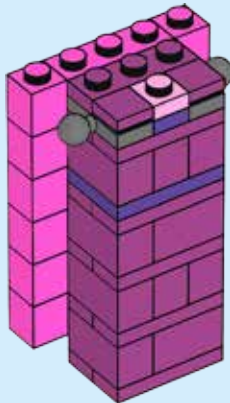



115

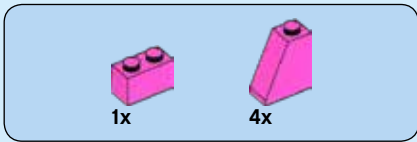
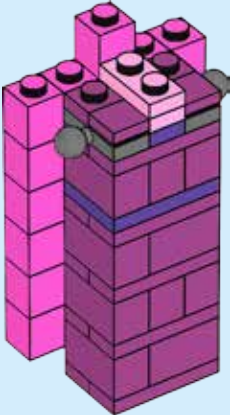

116

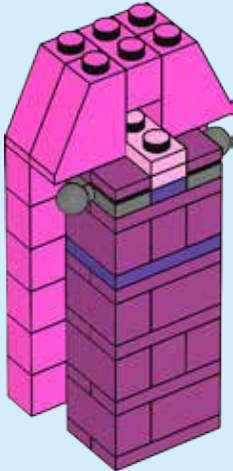

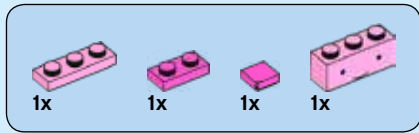

117

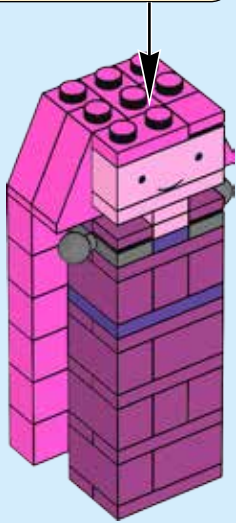
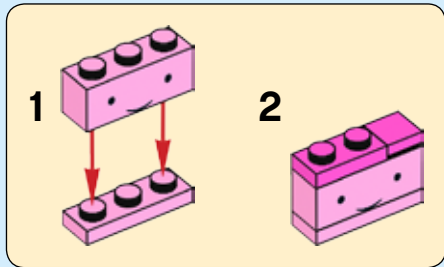

118

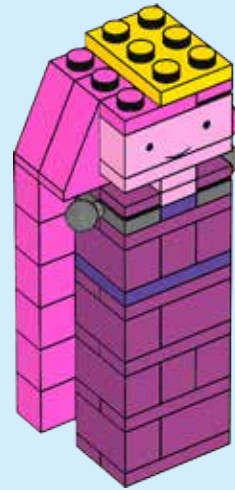



119

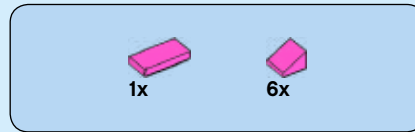
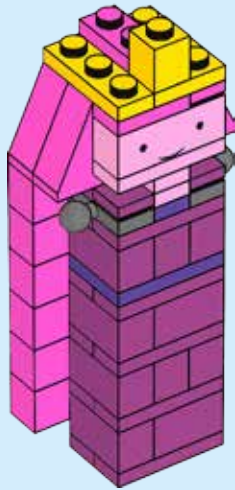

120

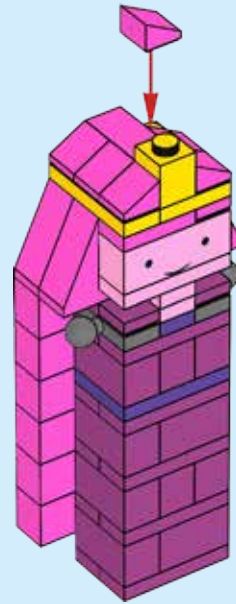



1x



1x

# 121

"Princess Power"

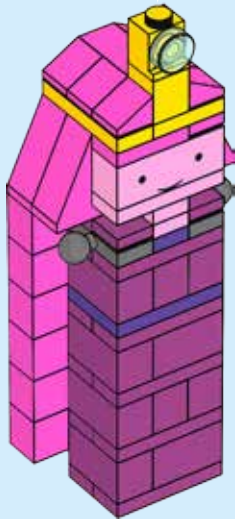
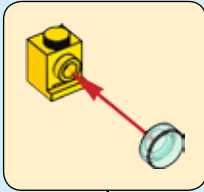

2x



2x



2x

# 122

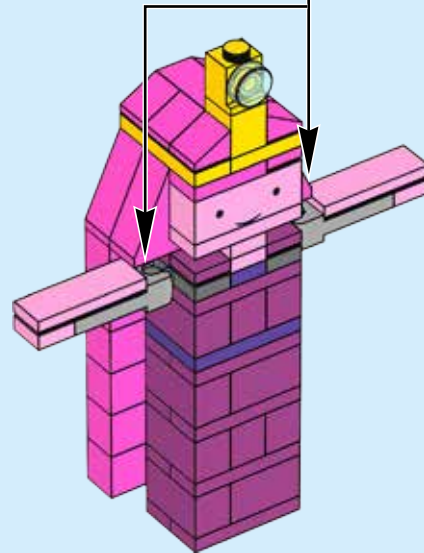
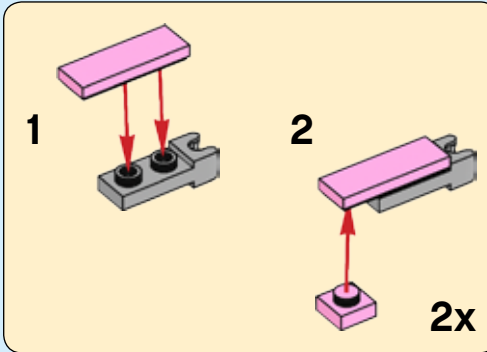

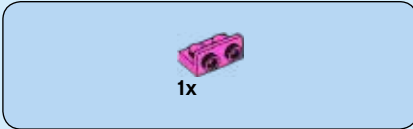
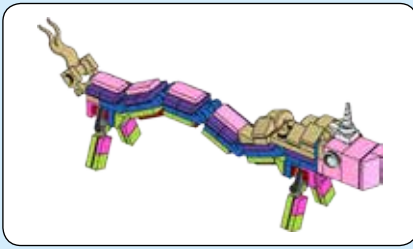

123



124



125



2x

126

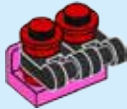

1x

1x

127

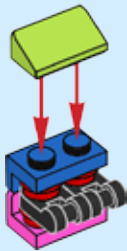

1x

1x

128

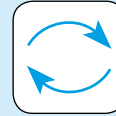

1x

2x

129

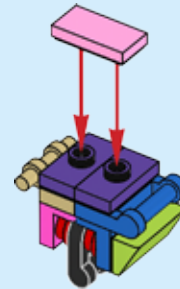

"Get your hero on, Dude!"

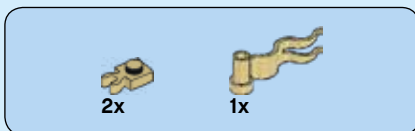
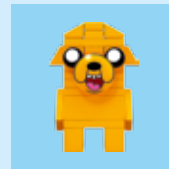

# 130

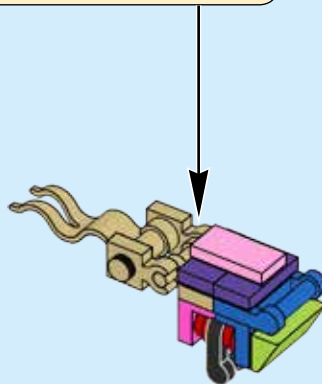
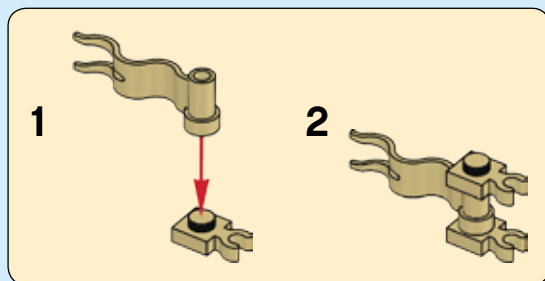



# 131

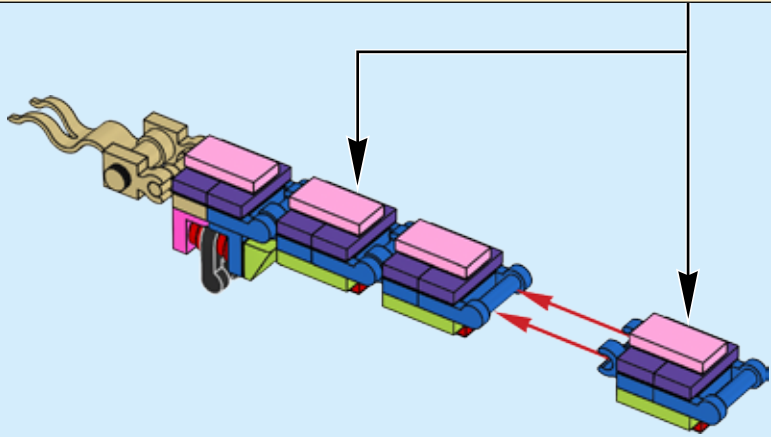
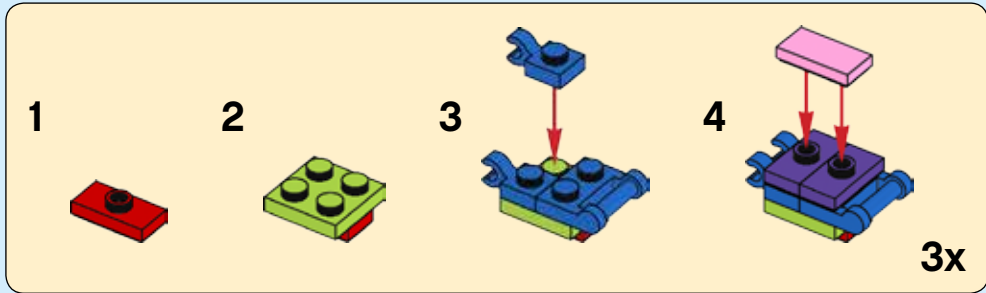



1x

# 132



1x

# 133



1x

2x

# 134

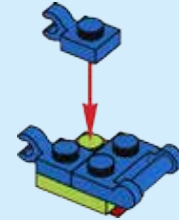

1x

1x

# 135

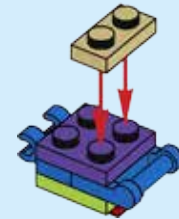



2x

136

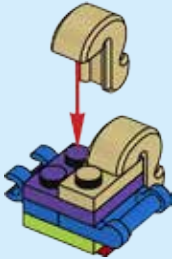

2x

137

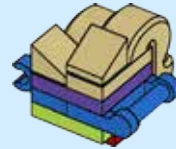

138

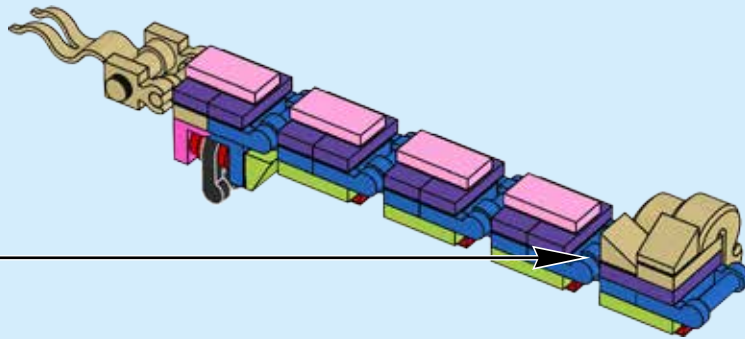



1x

139



2x

140



2x

141



2x

142

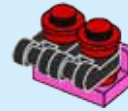



143

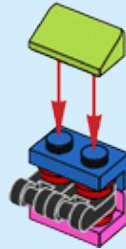

144

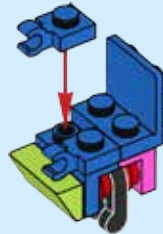
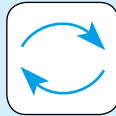

145

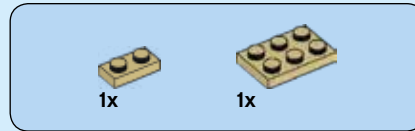
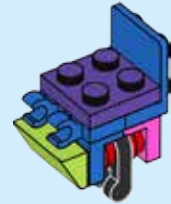

146

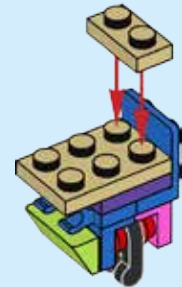



2x

147

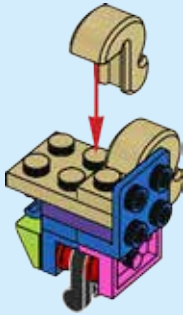

2x

148

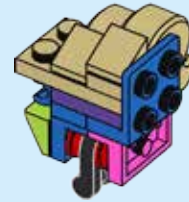



149

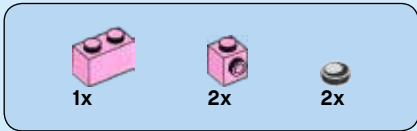
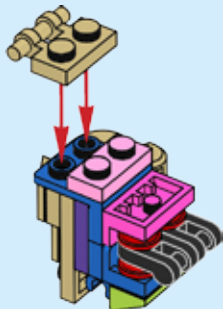
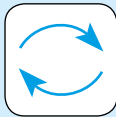

150

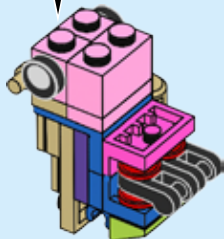
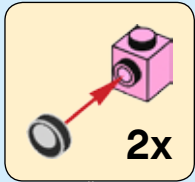



1x

151

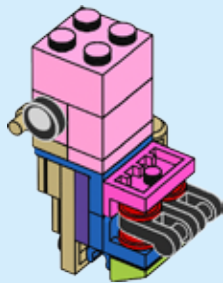

2x

152

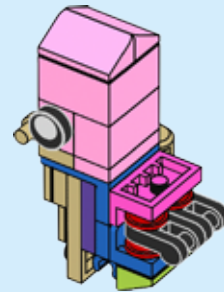

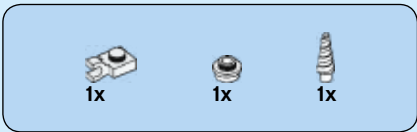

# 153

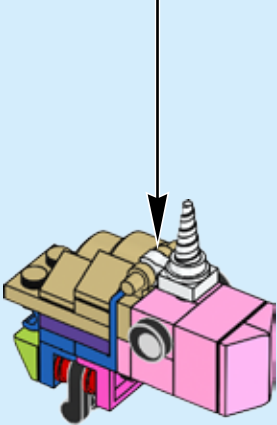
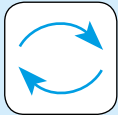
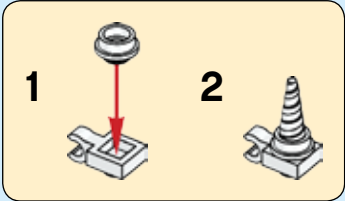

"Adventure 'til you drop"

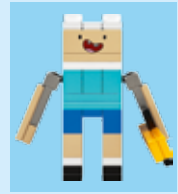

154

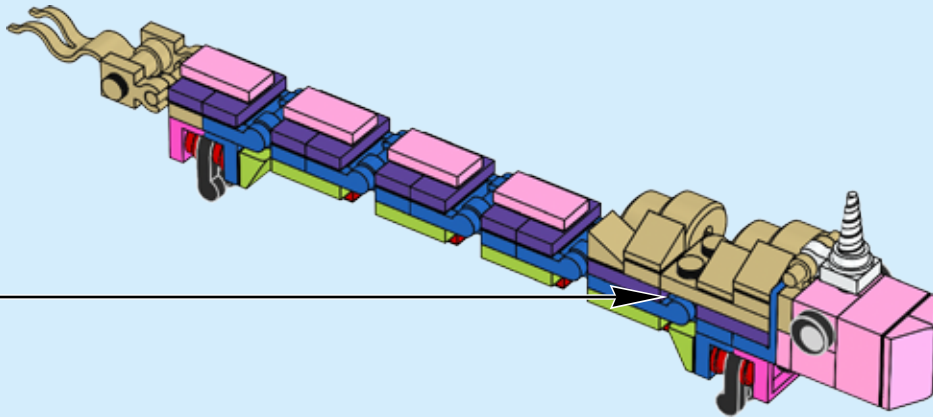

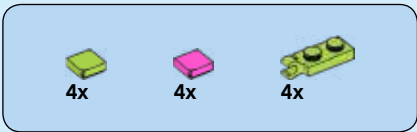

155

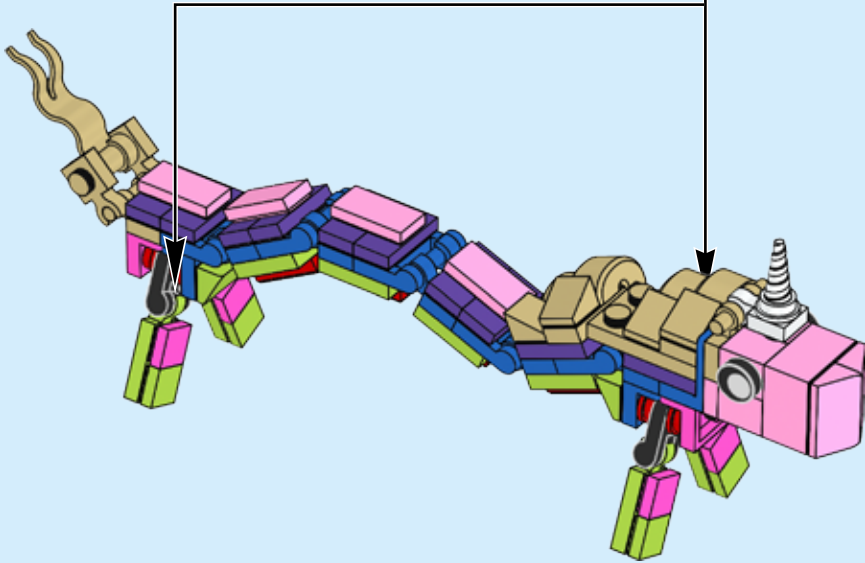
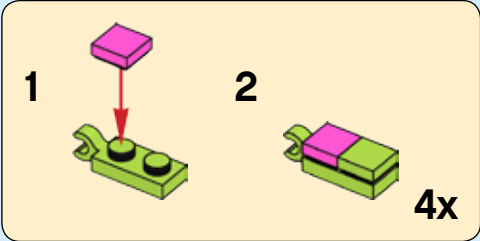

## Fan designer

As a fan of both Adventure Time and LEGO® building, recreating the characters from the iconic cartoon series was a tough, but very satisfying task for Ludovic Piraud.

“I discovered Adventure Time after I’d read an article about a wacky cartoon series and decided to give the show a try. At first I was puzzled by it, then intrigued and finally completely hooked by its colorful universe and story.”

“The design of the characters in Adventure Time uses very round shapes, therefore LEGO® bricks don’t instantly feel like a good fit to reproduce these rounded shapes. However,

other elements like colors and proportions between shapes are often enough to make a character recognizable, so I thought I’d try to make block-like characters.”

“I’m just an occasional LEGO® builder, so I asked for input from other LEGO Ideas users. The feedback I received was very constructive. The last project update is the most accomplished and that’s all thanks to the support from the community.”



## LEGO® designer

As a LEGO® designer, it was Adrian Florea's role to ensure the final model measured up to the exacting standards expected of all LEGO sets.

"I have followed the series since its first season and instantly liked the characters and the situations they found themselves in, so I was glad to be asked to work on this project."

"As Ludovic's original model was submitted as a 3D rendering and included some elements that were no longer available, I had to find ways to make everything work with the options we had. The same goes for colors, I had to make sure all the right elements were in the proper color."

"I love the line up of characters, but Marceline is my favorite. She has her own bass axe and she's a vampire. I'm from Transylvania and I play the bass in my spare time."





1x  
4113261



3x  
362201



5x  
4558952



1x  
654101



4x  
4504369



2x  
6069002



4x  
4121932



2x  
4532972



2x  
4233370



2x  
303901



2x  
303901

80



1x  
307001



13x  
302401



8x  
302301



1x  
306901



2x  
6051511



2x  
362301



3x  
302101



1x  
4538353



1x  
4547649



2x  
4646844



1x  
6156242



2x  
4109995



1x  
6182793



4x  
4516055



2x  
4159553



2x  
4113917



2x  
6131896



1x  
4121921



1x  
4118790



2x  
6029889



2x  
4140593



1x  
6150130

4x  
6109586



2x  
300423



4x  
300223



1x  
301023



9x  
4121925



2x  
6184480



1x  
302323



12x  
362323



2x  
4587840



2x  
4587840



4x  
379523



4x  
379523



10x  
4520946



2x  
6163471



1x  
6133720



5x  
4514398



1x  
300524



1x  
300424



3x  
4624985



1x  
407024



4x  
4525464



2x  
6092583



1x  
362324

2x  
302124

2x  
4588025



3x  
300426



1x  
362226



4x  
300226



4x  
4558954



2x  
4548180



2x  
366526



4x  
6047276



4x  
609126



1x  
6053077



6x  
6182792



4x  
307026

8x  
302426



2x  
306926



17x  
302326



2x  
242026



2x  
6128992



8x  
362326



1x  
4558170



3x  
302126



4x  
6157554



2x  
614126



2x  
6139403



2x  
73587

2x  
6156414

2x  
4184169



1x  
302421



2x  
307021



1x  
306921



5x  
6092565



1x  
302121



8x  
614121



3x  
6063445



1x  
4504372



3x  
6025026



4x  
4537251



4x  
4537937

1x  
6013530

4x  
6138122

1x 6022171	2x 4616581	1x 6061685	2x 4211098	6x 4492224	1x 4517993	8x 6092604	1x 6182795
2x 6136391	1x 4521947	2x 6003003	1x 4211104	7x 4621545	1x 4550359	1x 4655695	3x 6058016
1x 4546705	4x 6009656	1x 6061688	1x 4211105	1x 4618655	1x 6182796	2x 6047422	2x 6146701
1x 6000071	3x 6184432	8x 6092035	2x 4210848	3x 4621542	2x 4621554	1x 4225142	1x 6182789
2x 6022035	2x 4616578	3x 6023173	2x 4210848	6x 6127601	2x 4649749	3x 4619652	1x 6182789
4x 4519195	1x 4655080	2x 6024286	2x 4210631	4x 6062343	3x 6031883	2x 6145253	2x 6184485
4x 6109979	2x 6184348	3x 4622062	1x 4568734	4x 6062343	4x 4580010	2x 4619513	2x 6184485
2x 6099364	2x 4539102	7x 6028736	6x 6039479	5x 6133726	2x 4654128	1x 4619513	1x 6192108
11x 6022048	1x 4541507	1x 6099725	6x 6039479	1x 6133726	2x 6070317	1x 4654448	3x 6172693
4x 4249891	2x 4541544	3x 6097503	1x 6182794	1x 6056381	2x 6070317	1x 4654448	3x 6172693
1x 4184108	1x 4216581	1x 6020074	1x 6182794	2x 6057387	1x 6036788	1x 4654448	3x 6172693
2x 4528981	2x 4650260	1x 6182797	1x 6056239	2x 6057387	1x 6036788	1x 4654448	3x 6172693
1x 4530028	8x 6043639	1x 6170304	2x 6184484	2x 6099449	1x 6036788	1x 4654448	3x 6172693

Customer Service

Kundenservice

Service Consommateurs

Servicio Al Consumidor

LEGO.com/service or dial



: 00800 5346 5555

: 1-800-422-5346

SHARE YOUR IDEA  
TEILE DEINE IDEE  
PARTAGE TON IDÉE  
COMPARTÉ TU IDEA  
PARTILHA A TUA IDEIA  
TEDD KÖZZÉ AZ ÖTLETED  
分享您的观点

LEGO® REVIEW  
LEGO® PRÜFUNG  
EXAMEN PAR LEGO®  
REVISIÓN DE LEGO®  
AVALIAÇÃO LEGO®  
LEGO® VÉLEMÉNYEZÉS  
乐高®评论



GATHER SUPPORT  
HOL' DIR UNTERSTÜTZUNG  
RASSEMBLE DES VOTES  
GANA APOYOS  
OBTÉM APOIO  
SZEREZZ TÁMOGATÁST  
获得更多支持



NEW LEGO® PRODUCT  
NEUES LEGO® PRODUKT  
NOUVEAU PRODUIT LEGO®  
NUEVO PRODUCTO LEGO®  
NOVO PRODUTO LEGO®  
ÚJ LEGO® TERMÉK  
新的乐高®产品



[LEGO.COM/IDEAS](http://LEGO.COM/IDEAS)



# IDEAS

## Do you like this LEGO® Ideas set?

The LEGO® Group would like your opinion on the new product you have just purchased. Your feedback will help shape the future development of this product series. Please visit:

[LEGO.com/productsurvey](https://www.lego.com/productsurvey)



By completing our short feedback survey, you will be automatically entered into a drawing to win a LEGO® prize. See website for official rules and details. Open to all countries where not prohibited.

LEGO and the LEGO logo are trademarks of the LEGO Group. ©2017 The LEGO Group.

ADVENTURE TIME, CARTOON NETWORK, the logos, and all related characters and elements are trademarks of and © Cartoon Network. (s16)

6194759