



76958





 **FR**  
**DONNEZ**  
OU  
**RECYCLEZ**

 OU  OU 

ASSOCIATION MAGASIN DÉCHÈTERIE

Adresses sur [quefairedemesdechets.fr](http://quefairedemesdechets.fr)



[LEGO.com/sustainable-packaging](http://LEGO.com/sustainable-packaging)



# BUILDER



Apple and the Apple logo are trademarks of Apple Inc., registered in the U.S. and other countries and regions. App Store is a service mark of Apple Inc. Google Play and the Google Play logo are trademarks of Google LLC. Tencent and the Tencent logo are trademarks of Tencent Inc.

Q [LEGO.com/devicecheck](https://www.lego.com/devicecheck)

**EN** Ask parents' permission before going online | **DE** Eltern um Erlaubnis bitten, bevor du online gehst | **FR** Demande l'autorisation d'un parent avant d'aller en ligne | **IT** Chiedi il permesso ai tuoi genitori prima di andare online | **ES** Pídeles permiso a tus papás antes de conectarte a Internet | **PT** Peça autorização aos pais antes de acederes online | **ZH** 上网前应先征得父母的同意 | **PL** Poproś rodziców o zgodę, zanim wejdiesz do Internetu | **CS** Než půjdeš na internet, požádej rodiče o svolení | **SK** Skôr než pôjdeš na internet, vypýtaj si povolenie od rodičov | **HU** Kérj szülői engedélyt, mielőtt online csatlakoznál! | **RO** Cere permisiunea părinților înainte de a te conecta online | **BG** Поискайте разрешение от родител, преди да влезете онлайн | **LV** Pirms došanās tiešsaistē palūdz atļauju vecākiem | **ET** Enne Interneti kasutamist küsi vanematelt luba | **LT** Prieš prisijungdami prie interneto, atsiklauskite tėvų

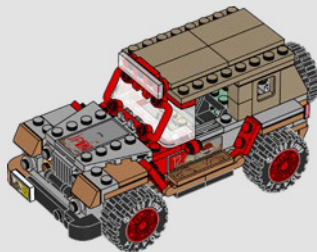
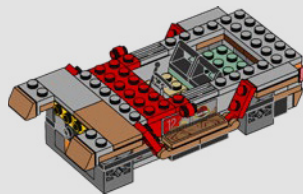



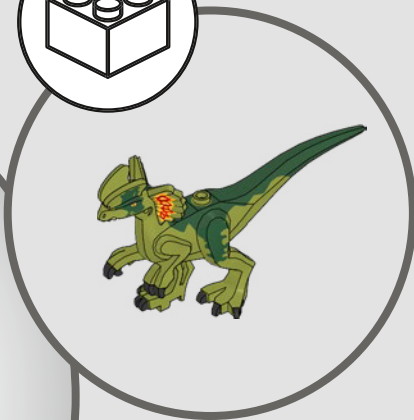
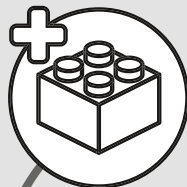

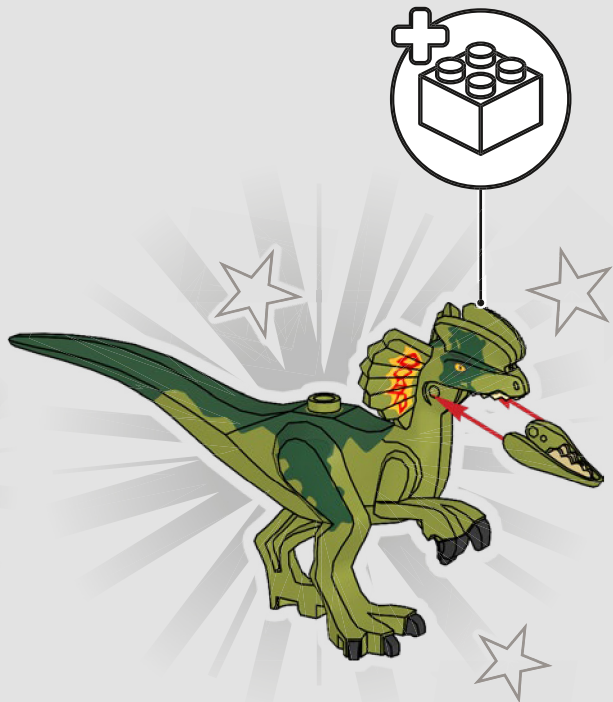
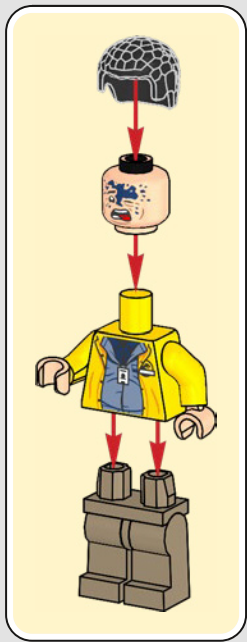

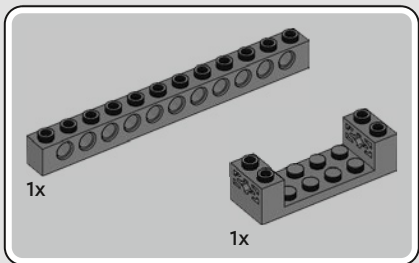
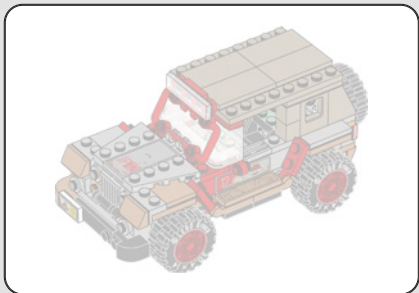

1

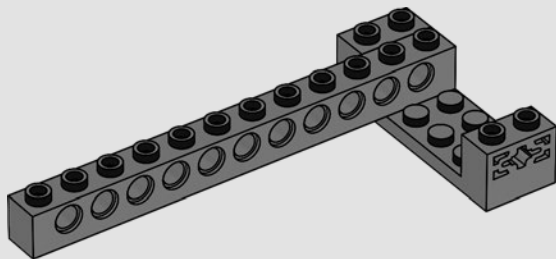

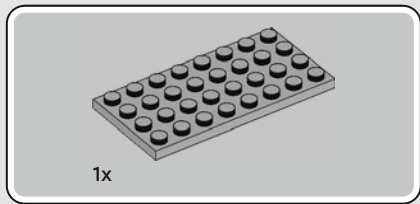

2

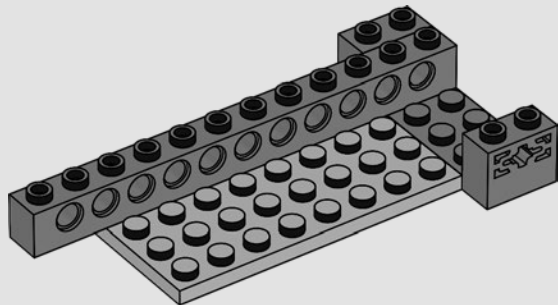

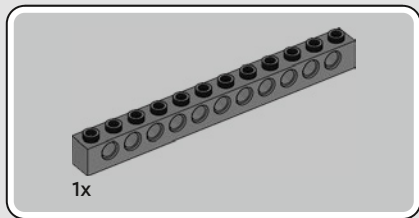

3

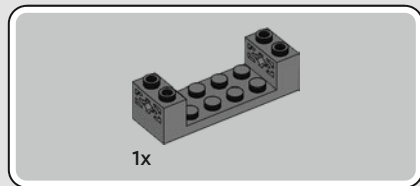
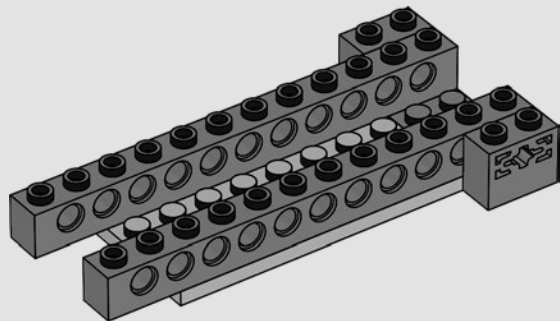

4

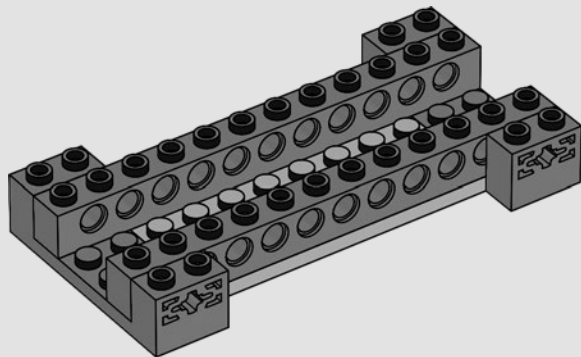



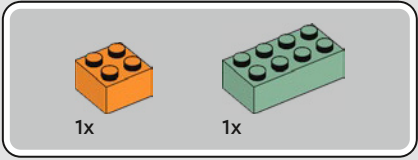

5

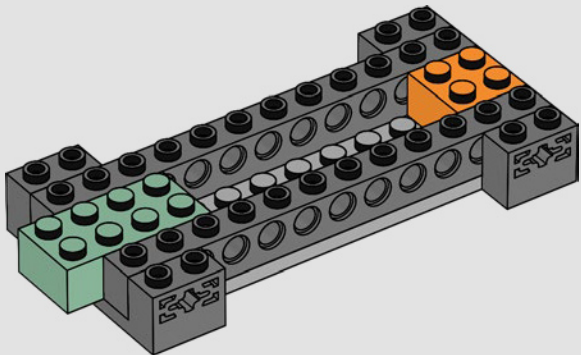

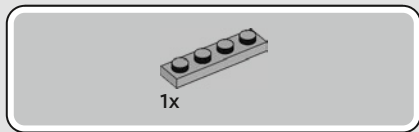

6

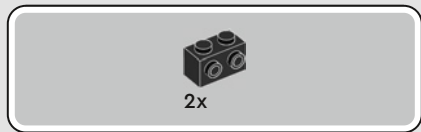
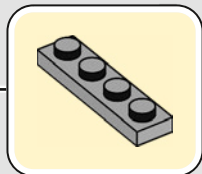
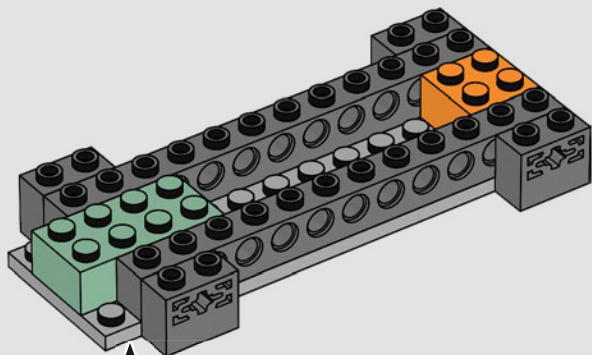

7

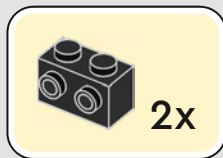
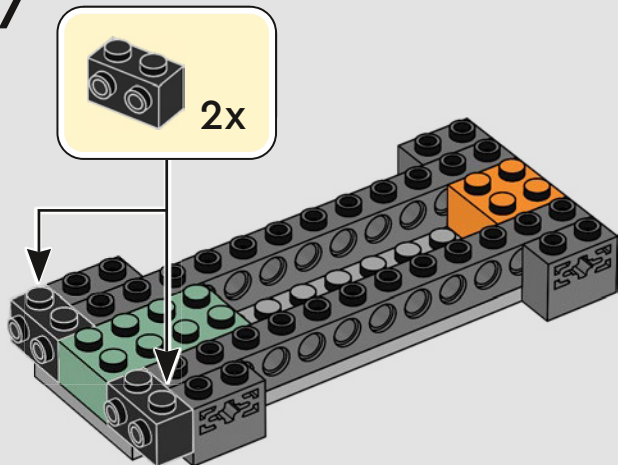

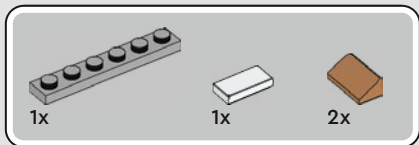

8

1

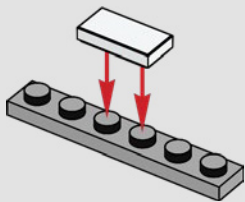

2

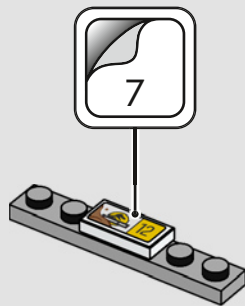

3

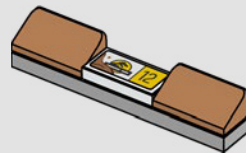



4

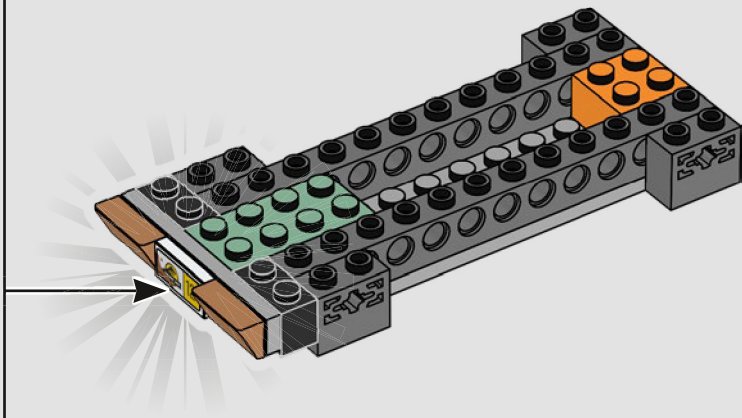







2x

10

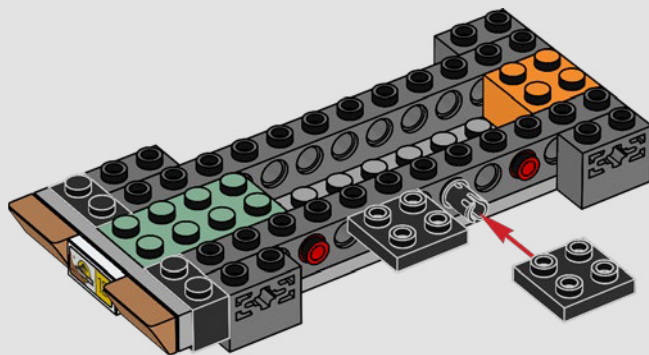



2x



2x

11

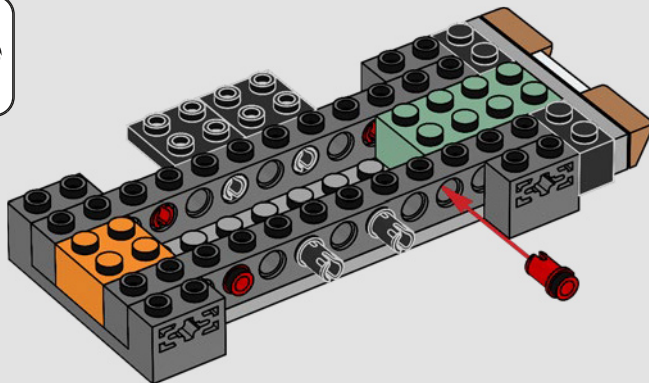



2x

# 12

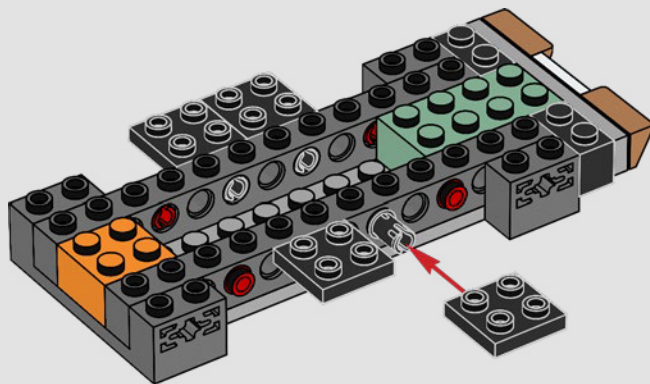

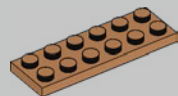

1x

13

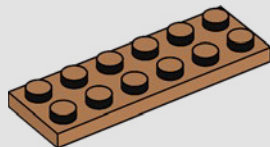

1x



1x

14

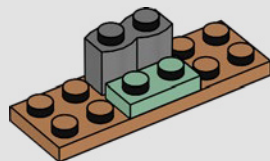



2x

15

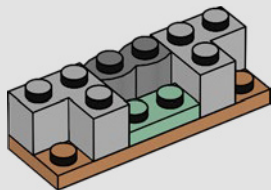

2x



2x

16

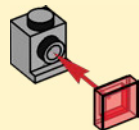

2x

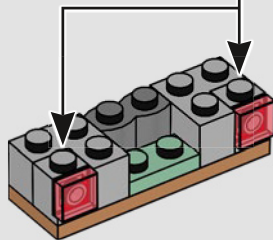





1x

17

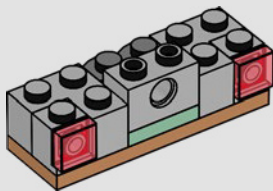

2x

18

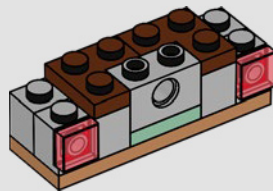



19

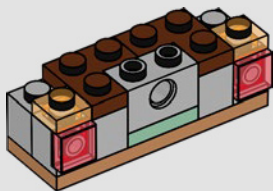

20

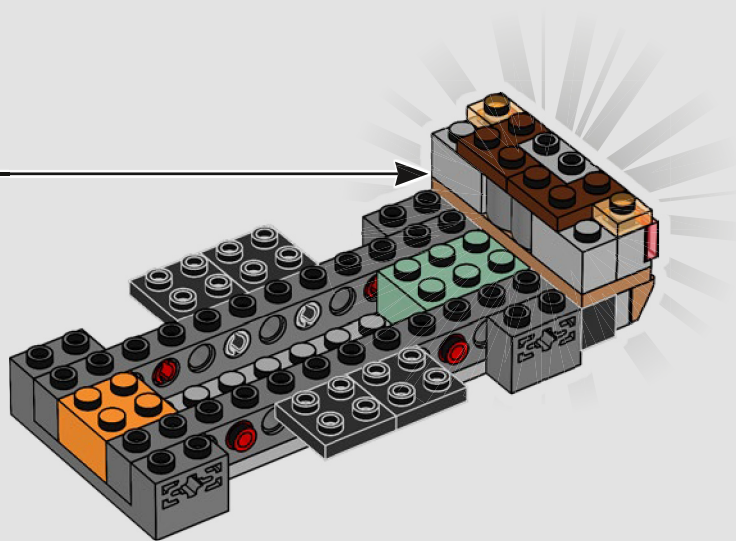

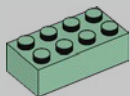

2x

21

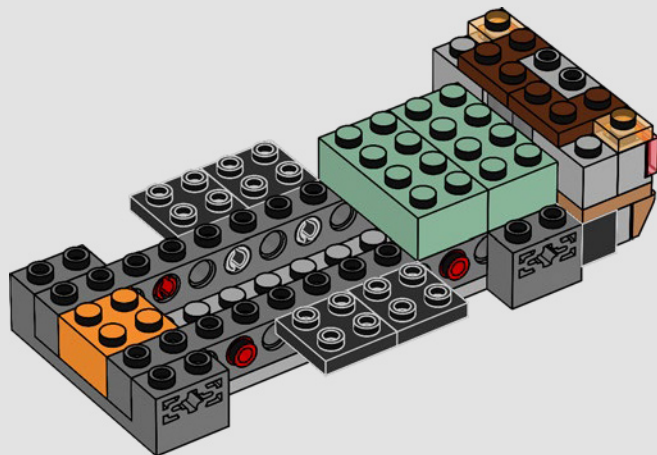

22



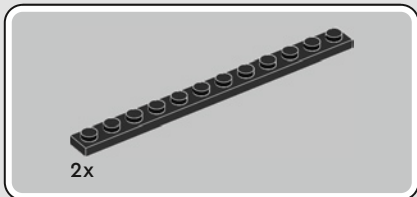

22

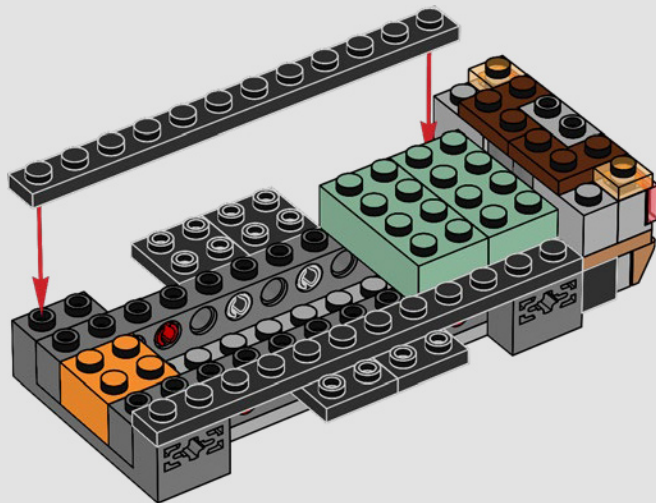



2x

23

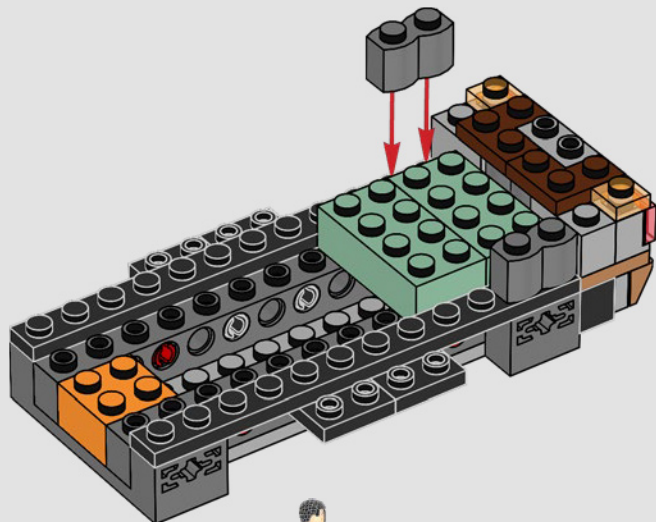

24



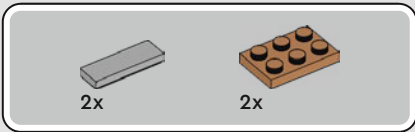

24

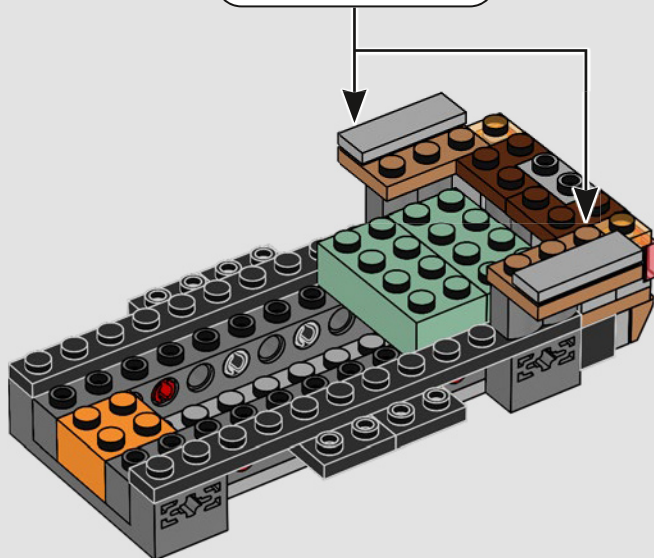
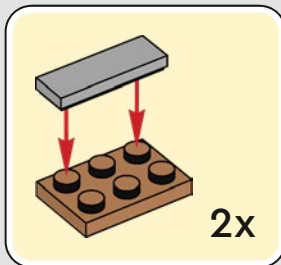



1x

25

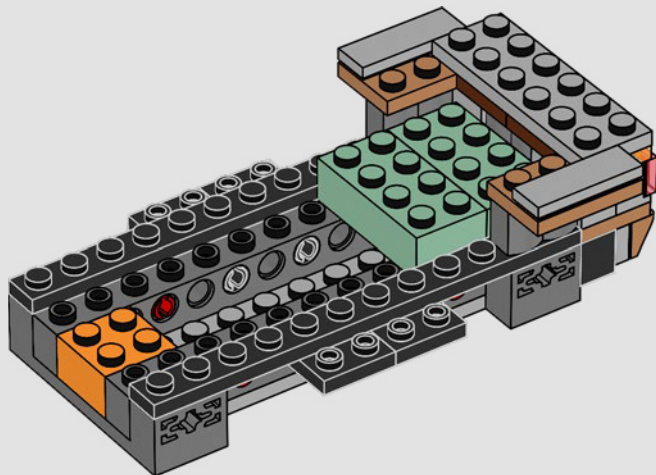

26









2x



2x

27

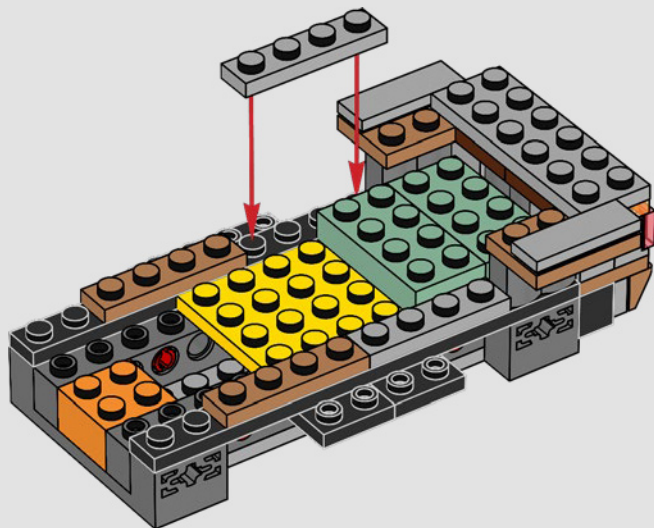



2x

28

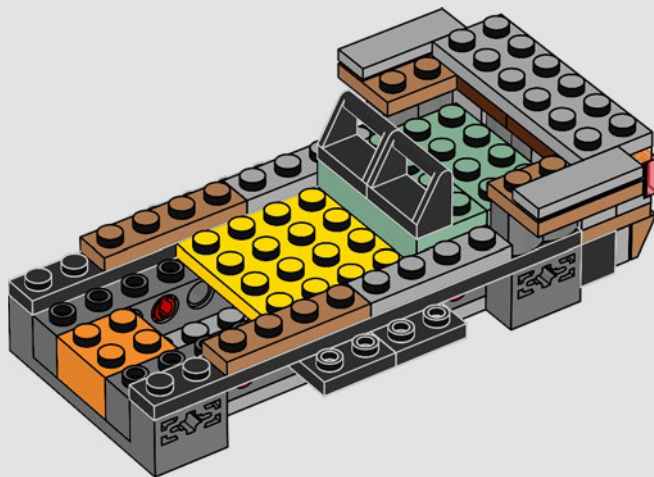



2x

29

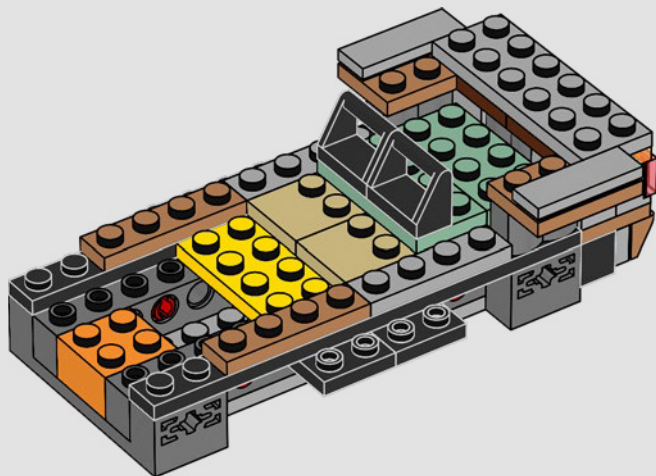



1x

30

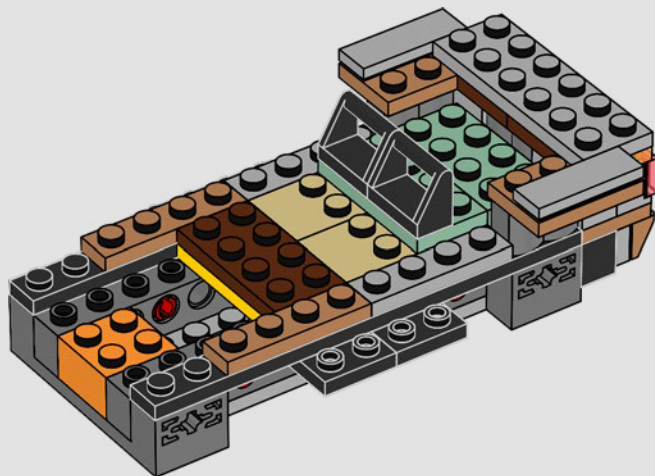

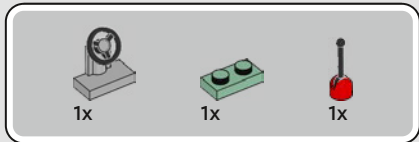

31

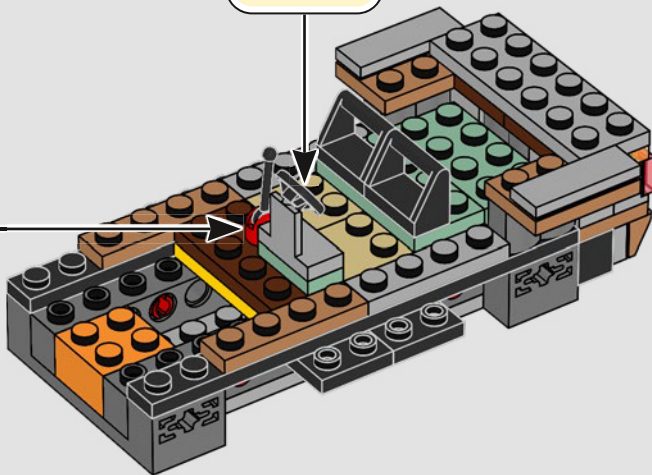
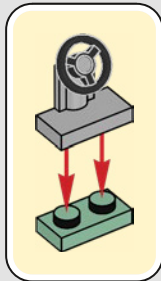



2x

32

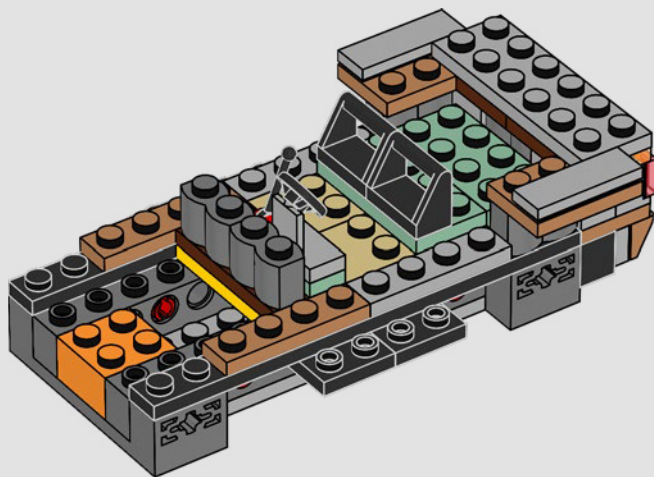

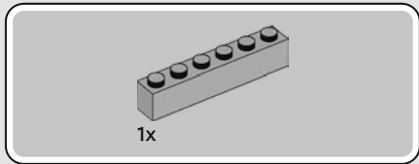

33

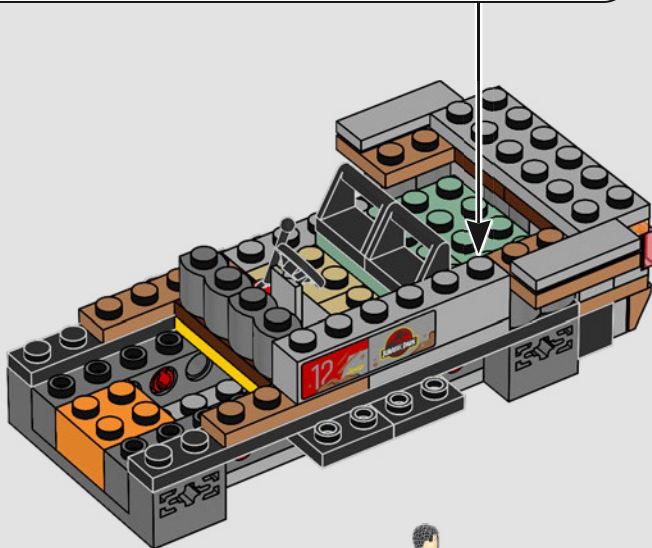
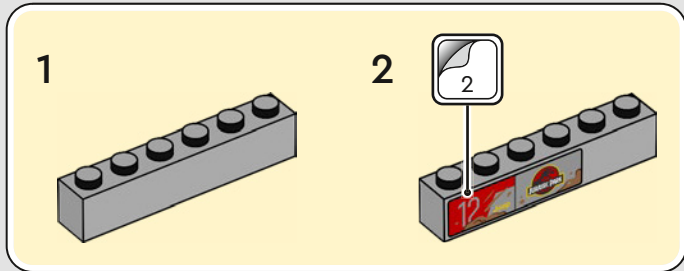

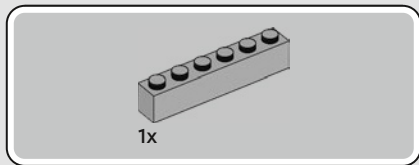

34

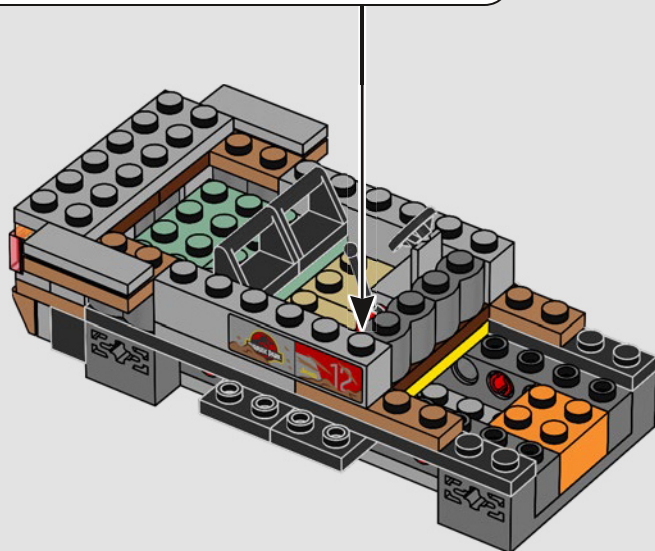
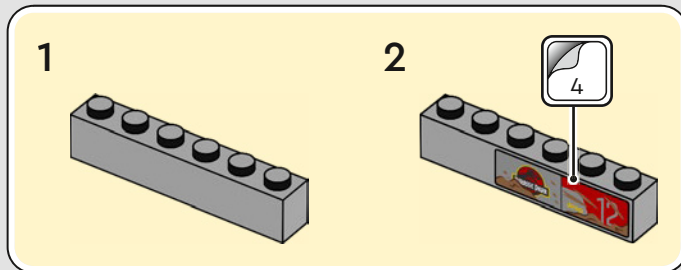



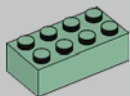

1x

35

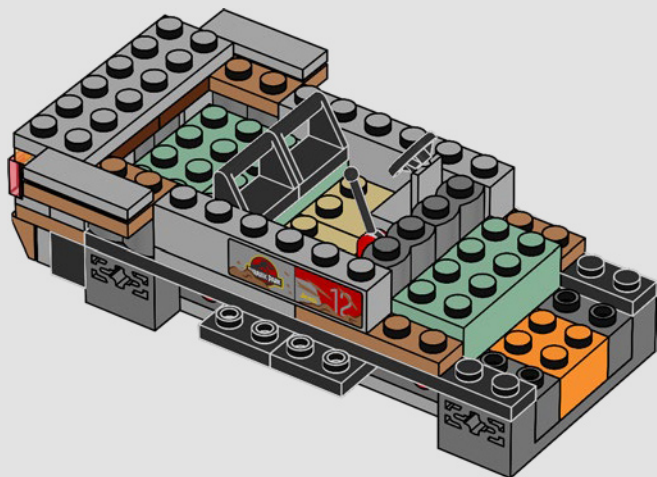



2x

# 36

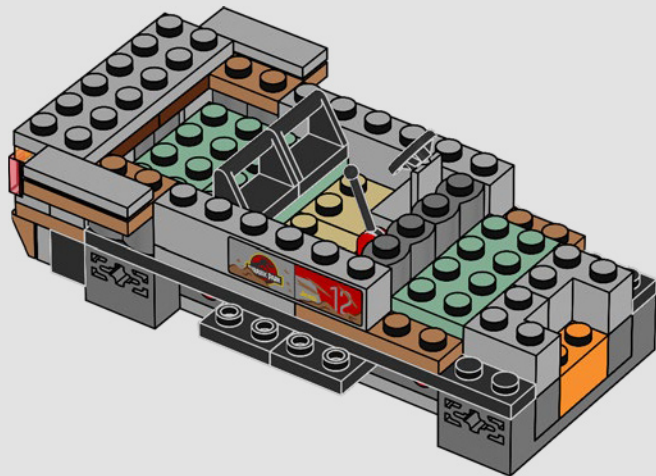



1x

37

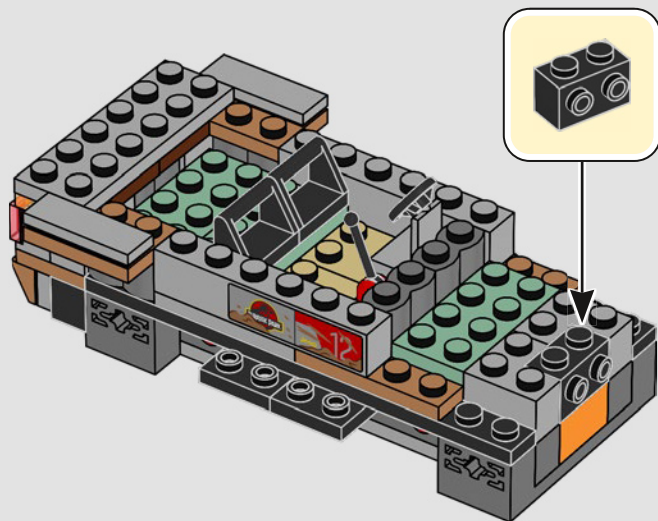



1x



1x

# 38

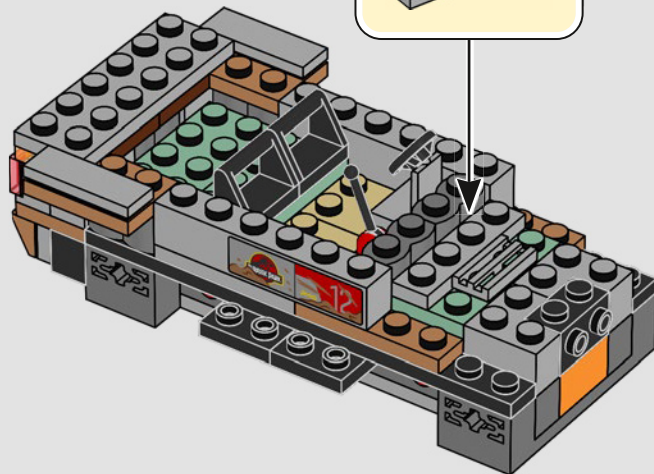
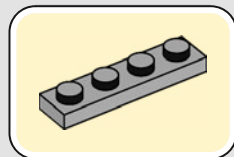



2x



2x

# 39

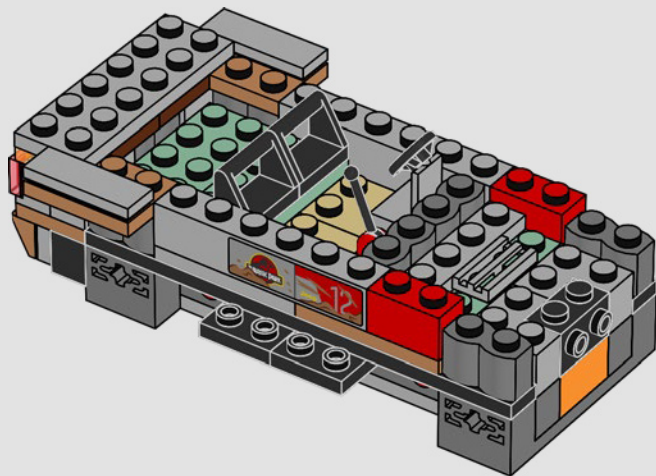



2x

40

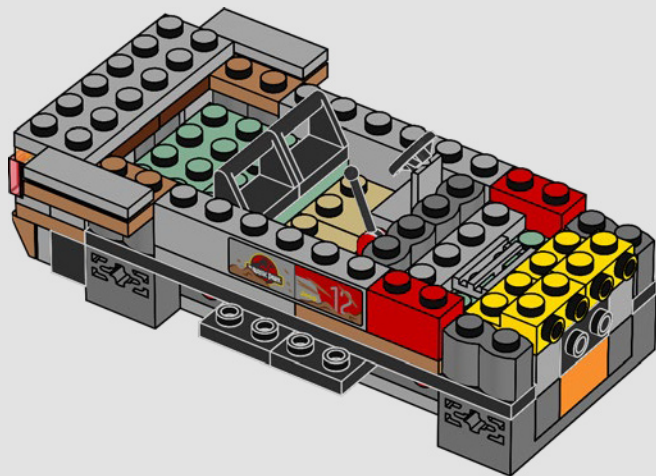



2x

41

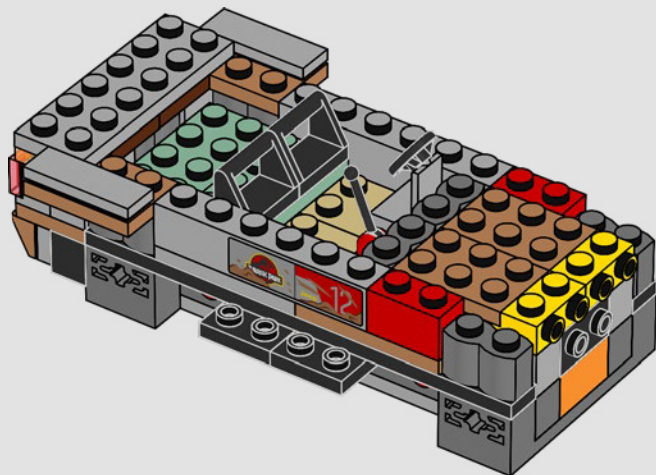

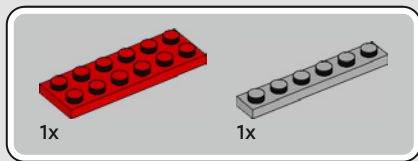

42

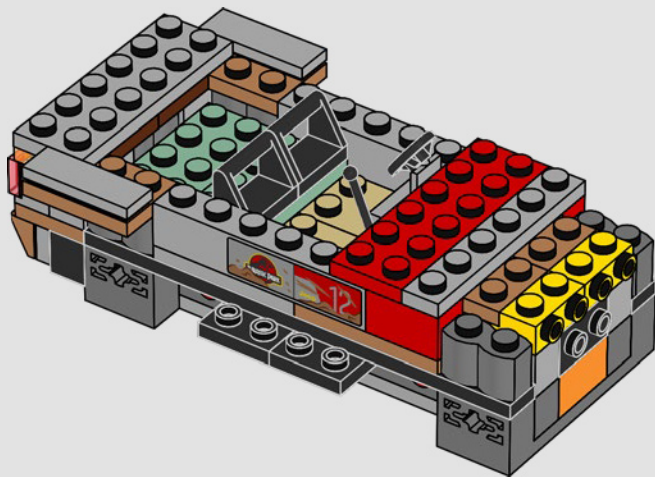





2x

43

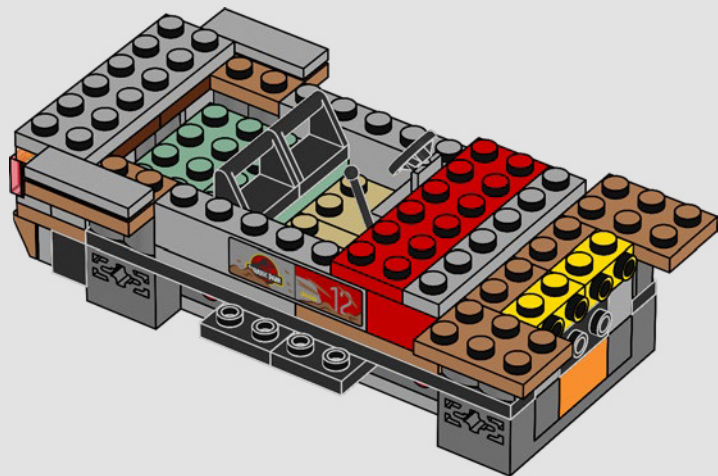

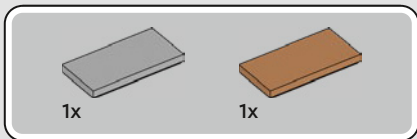

44

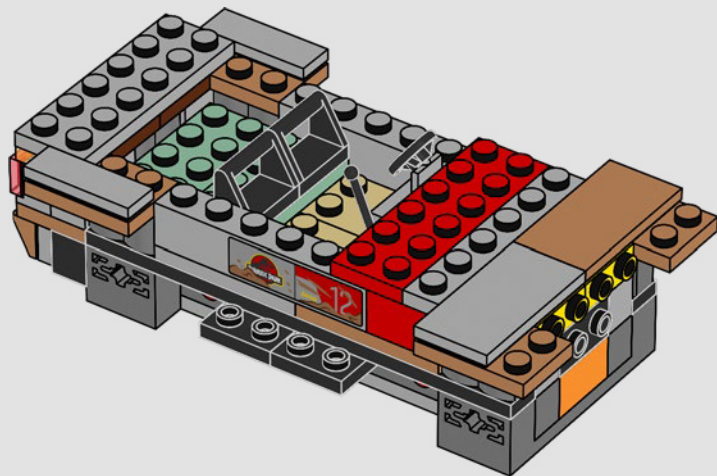



2x

45

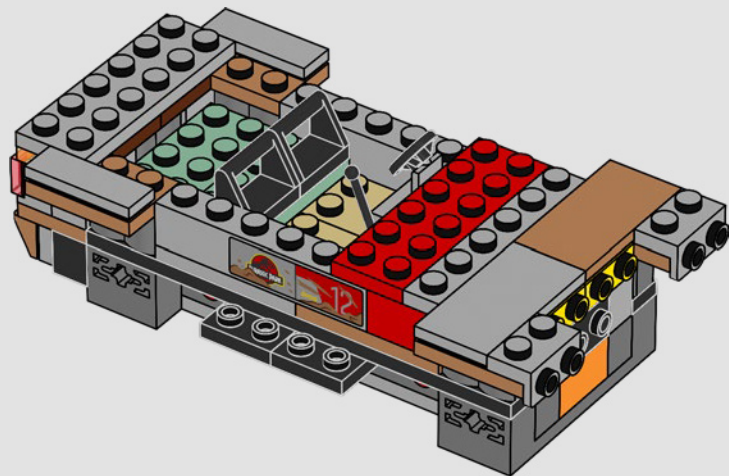



2x

46

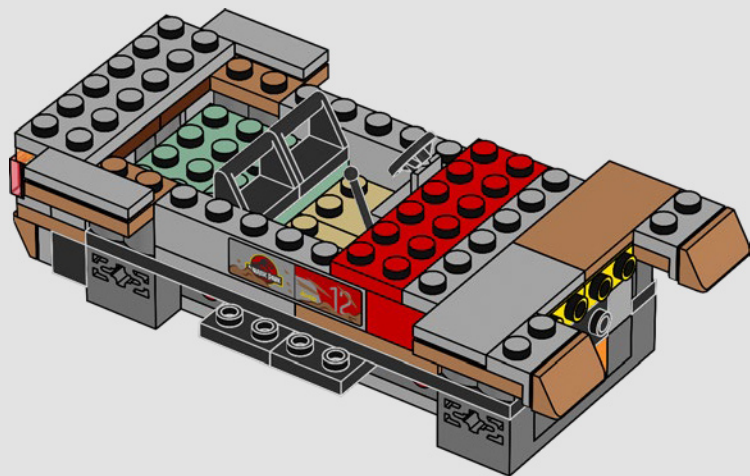

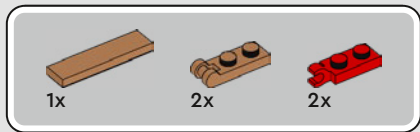

47

1

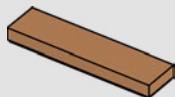

2

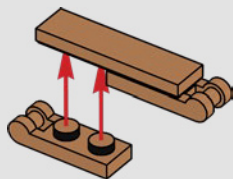

3

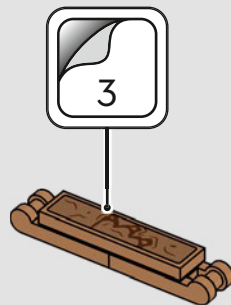

4

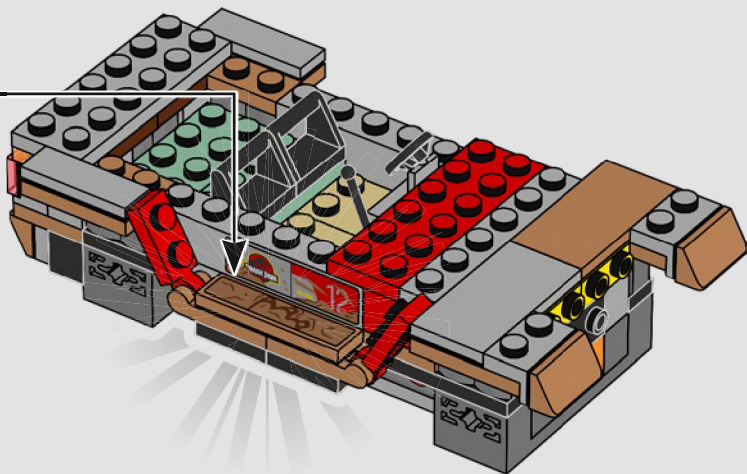
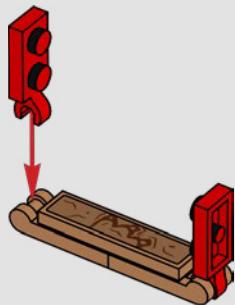

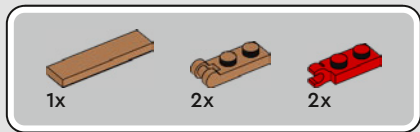

48

1

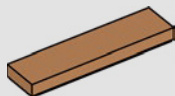

2

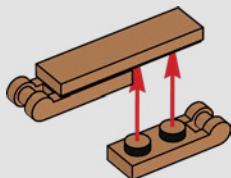

3



4

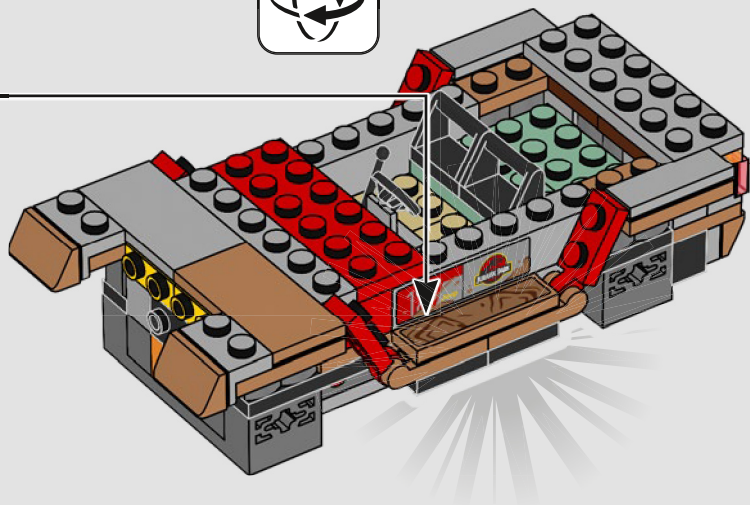
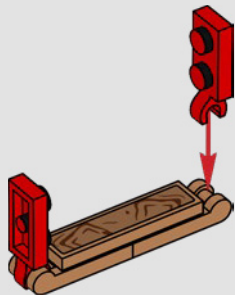





2x

49

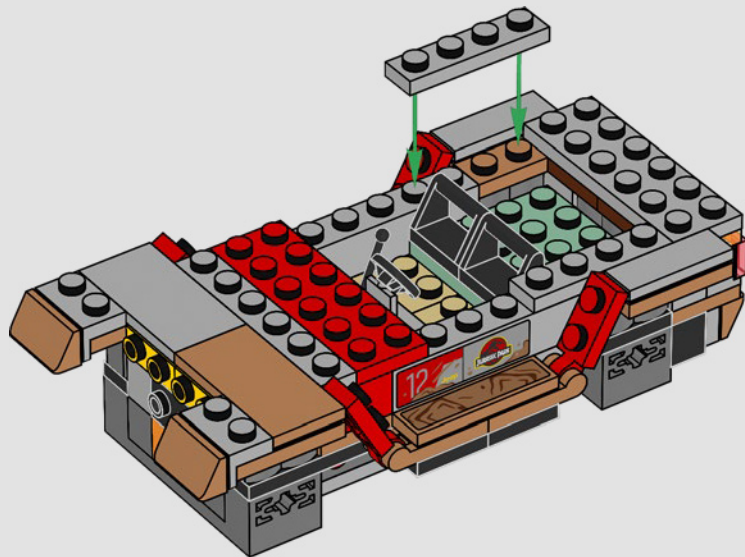



2x



2x

# 50

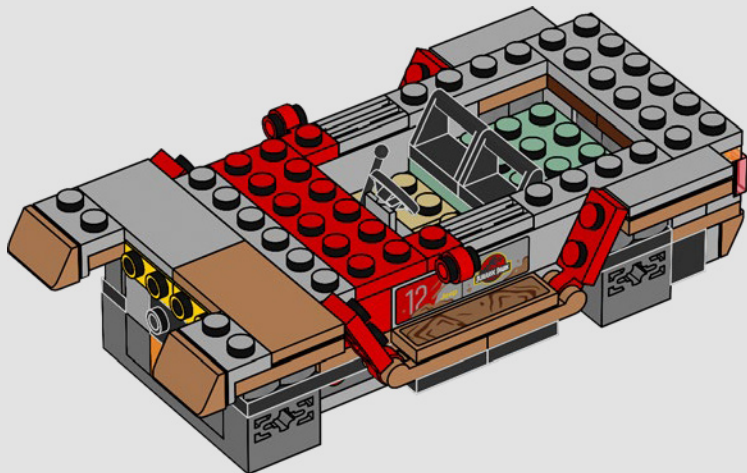

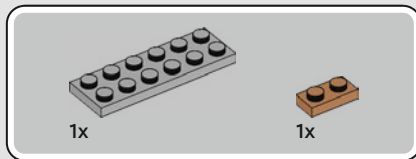
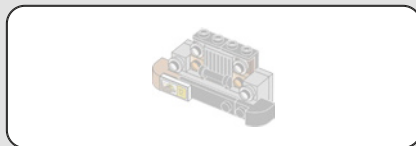

51

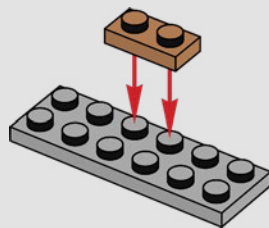



1x

52

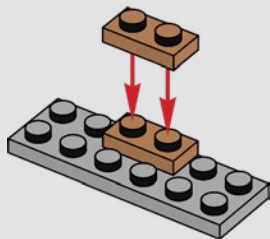

1x

53

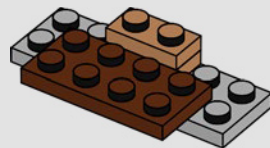



2x

# 54

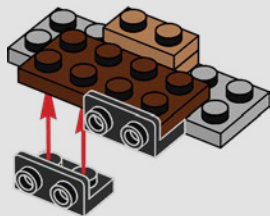



1x

55

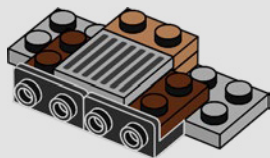

2x



2x

56

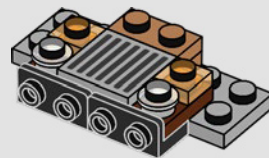



2x



1x

57

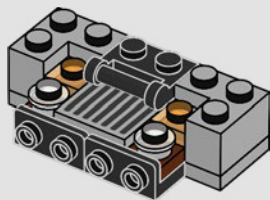

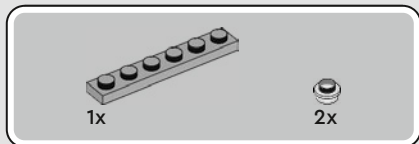

58

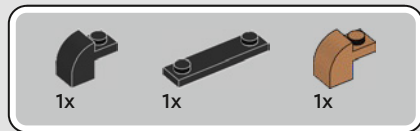
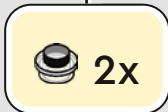
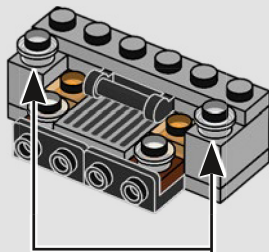

59

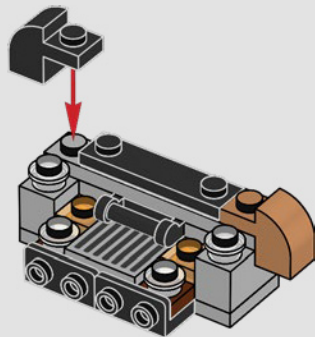





1x

60

1



2

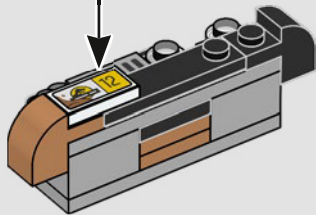

61

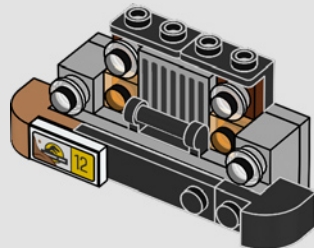

62

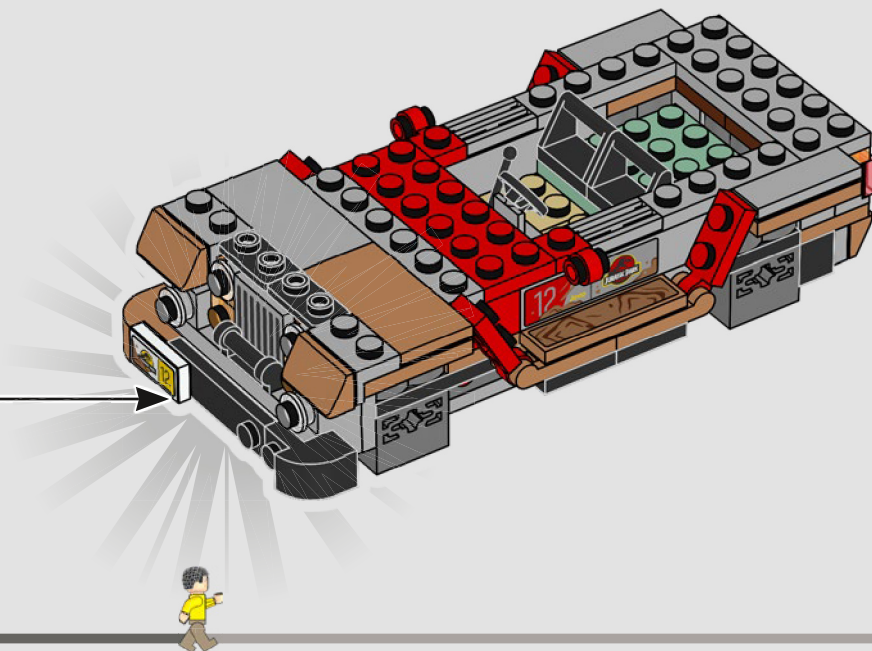

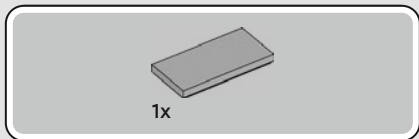

63

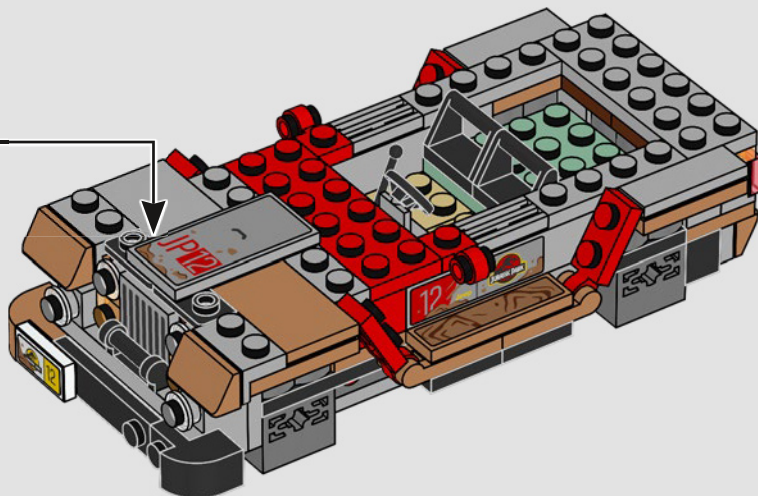
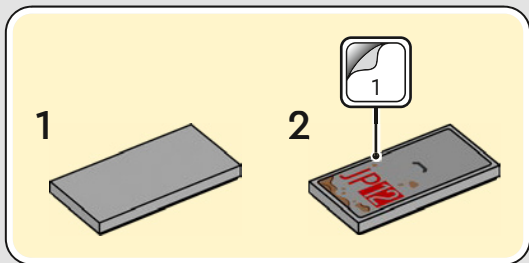

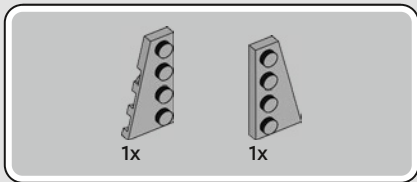

64

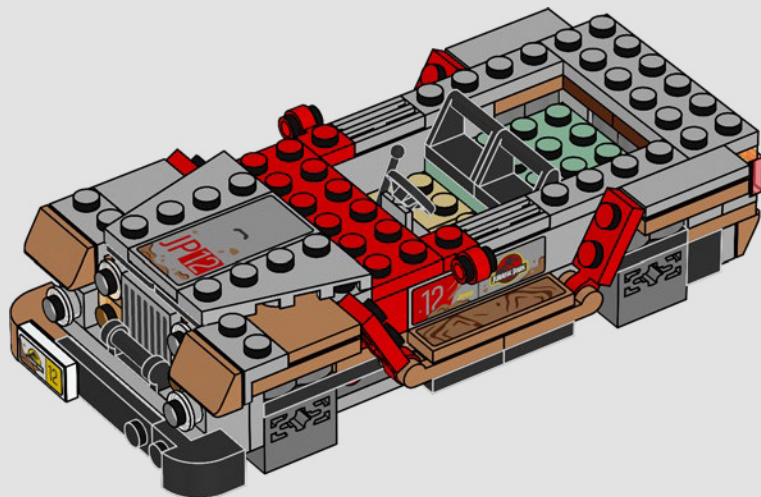



2x

65



2x

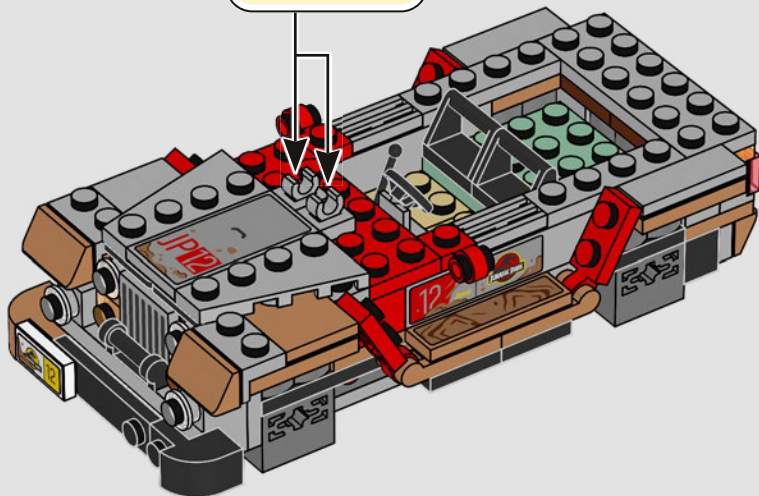

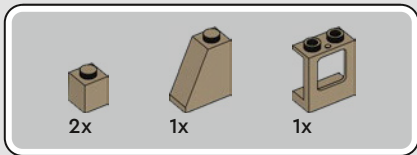

66

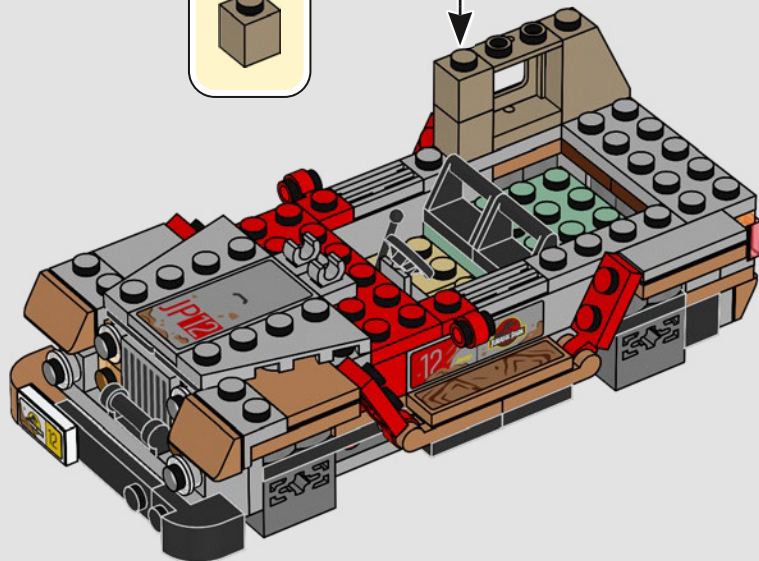
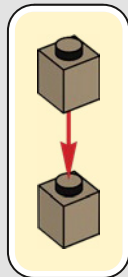

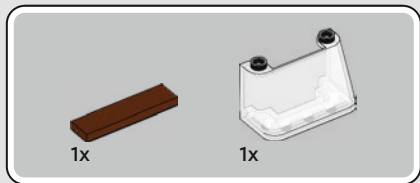

67

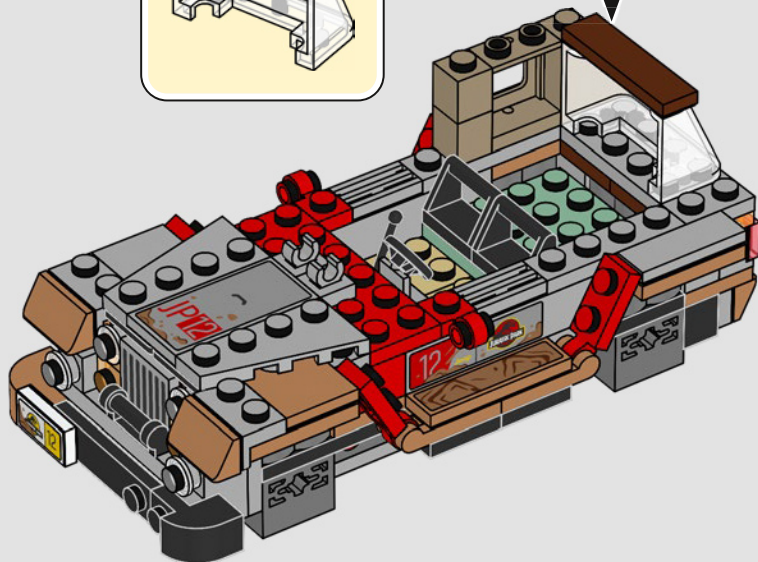
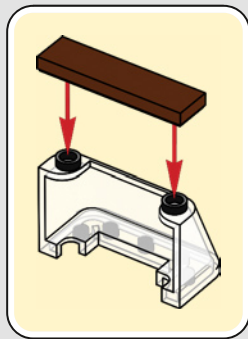

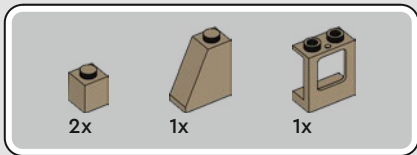

68

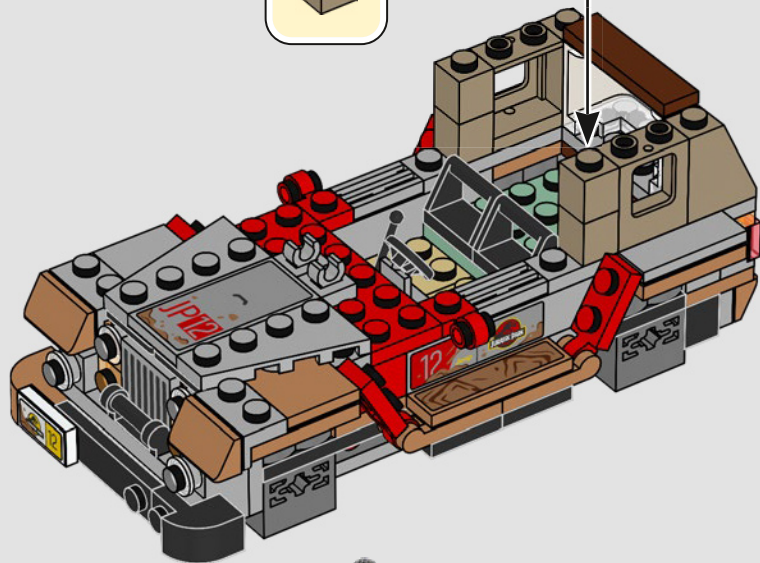
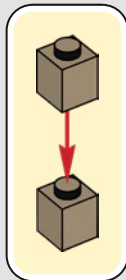





2x

69

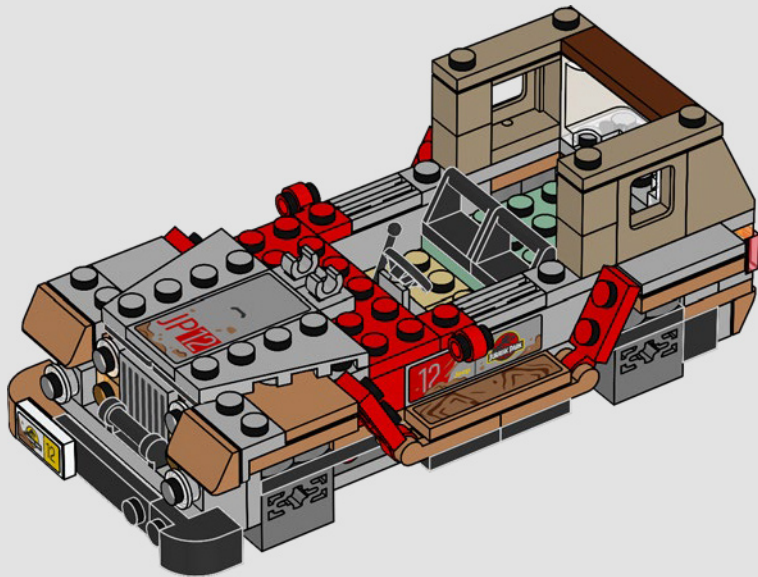

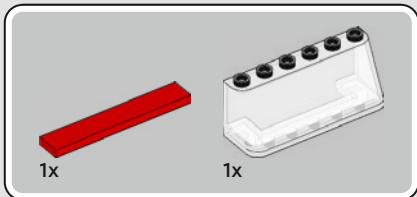

70

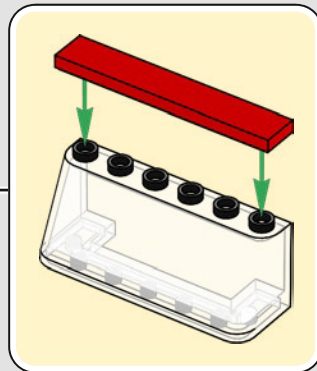
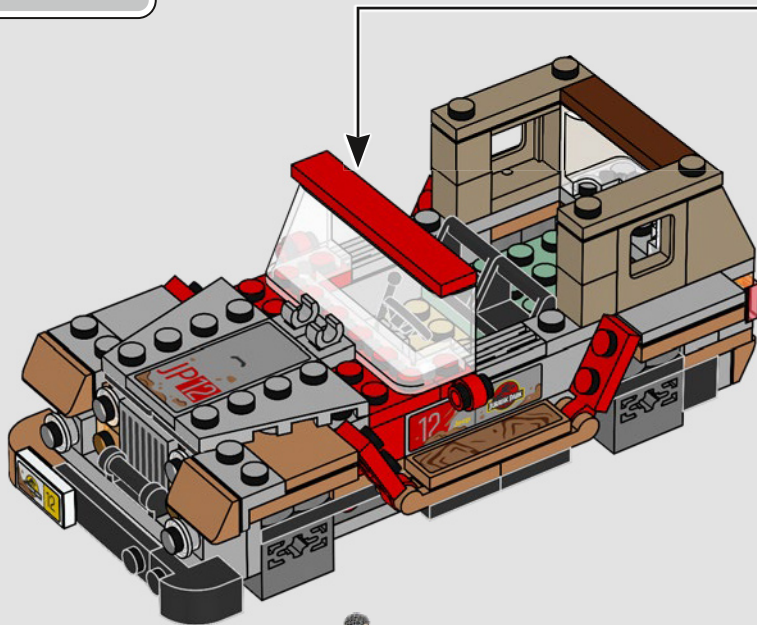

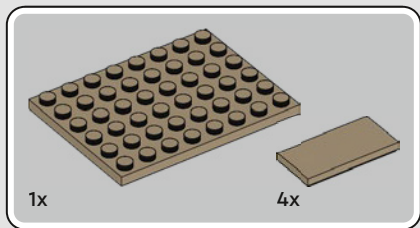

71

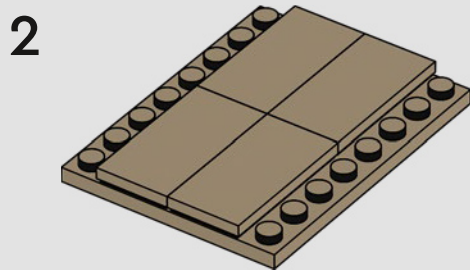
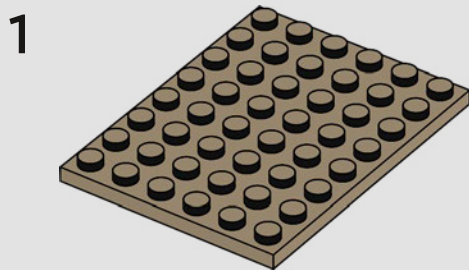

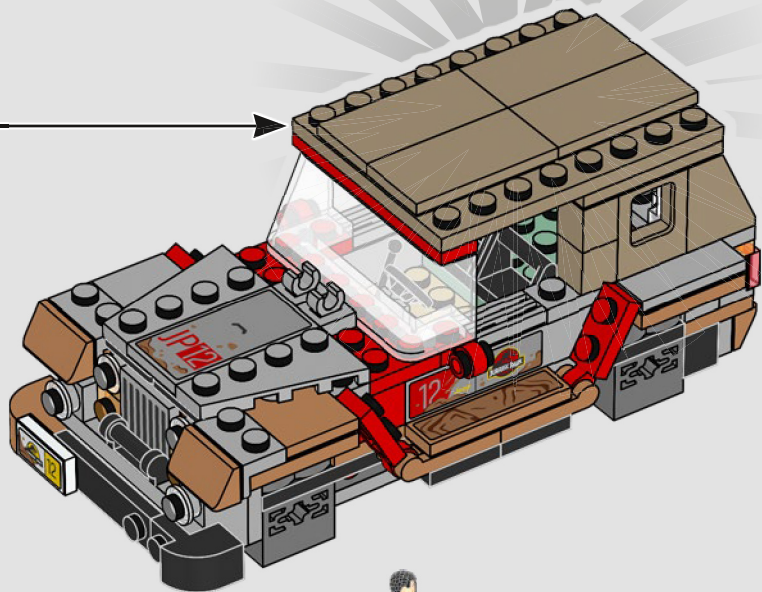

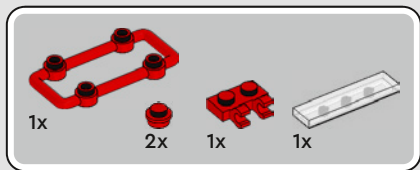

72

1



2

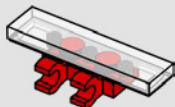

3

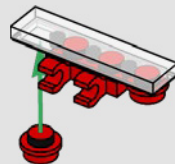

4

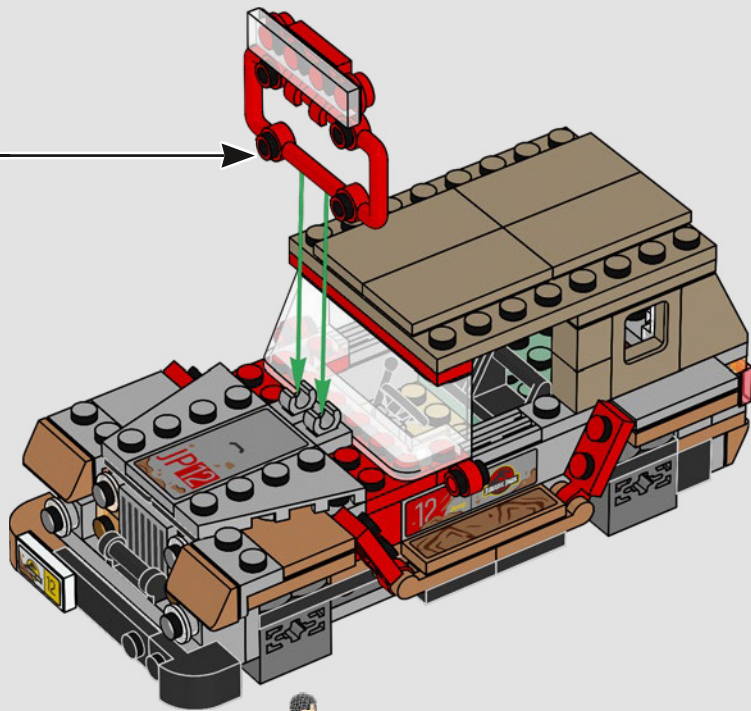
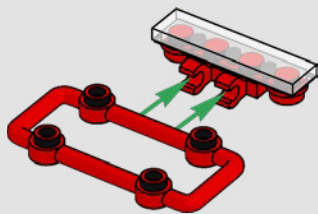

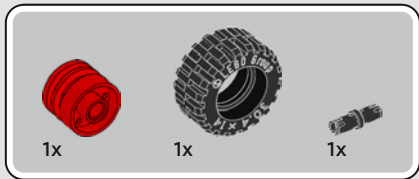

73

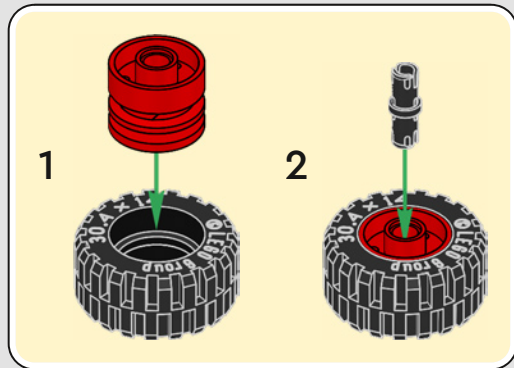
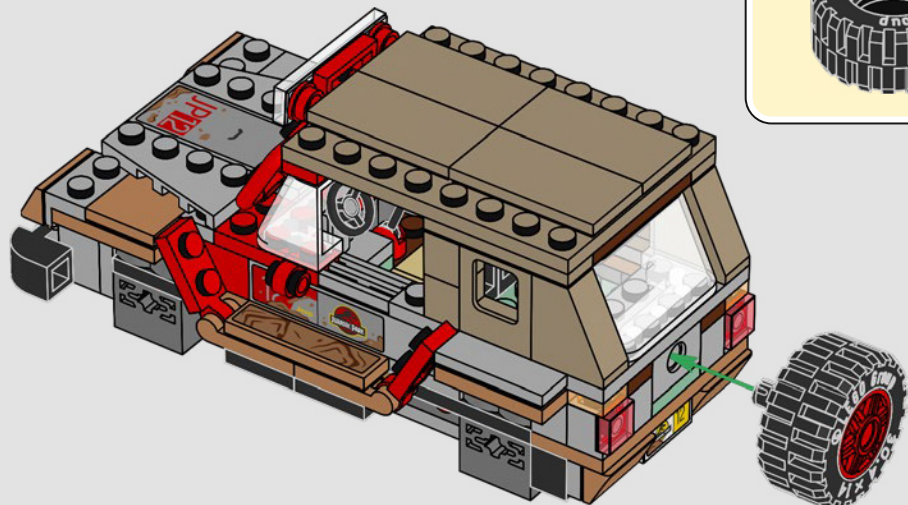



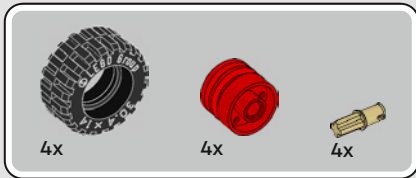

74

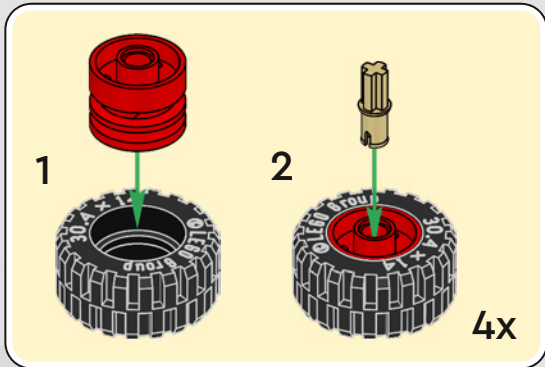
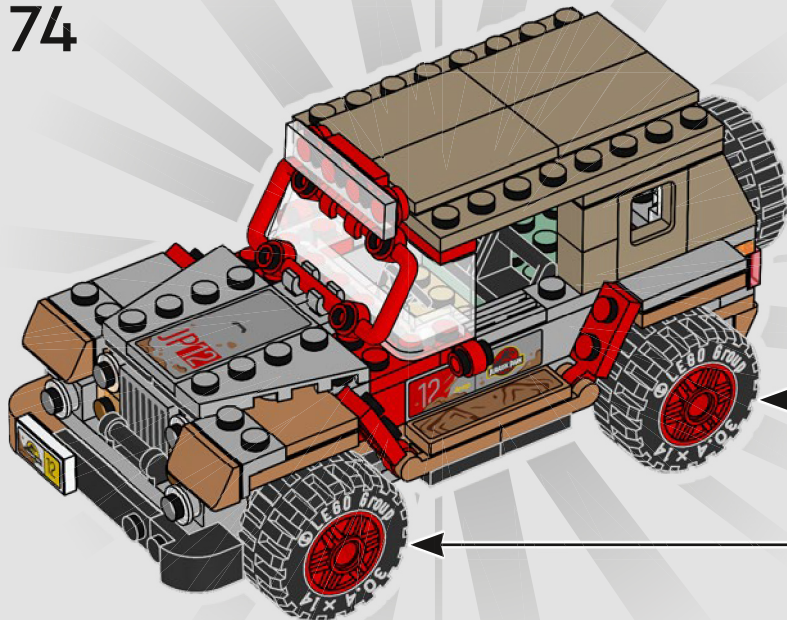



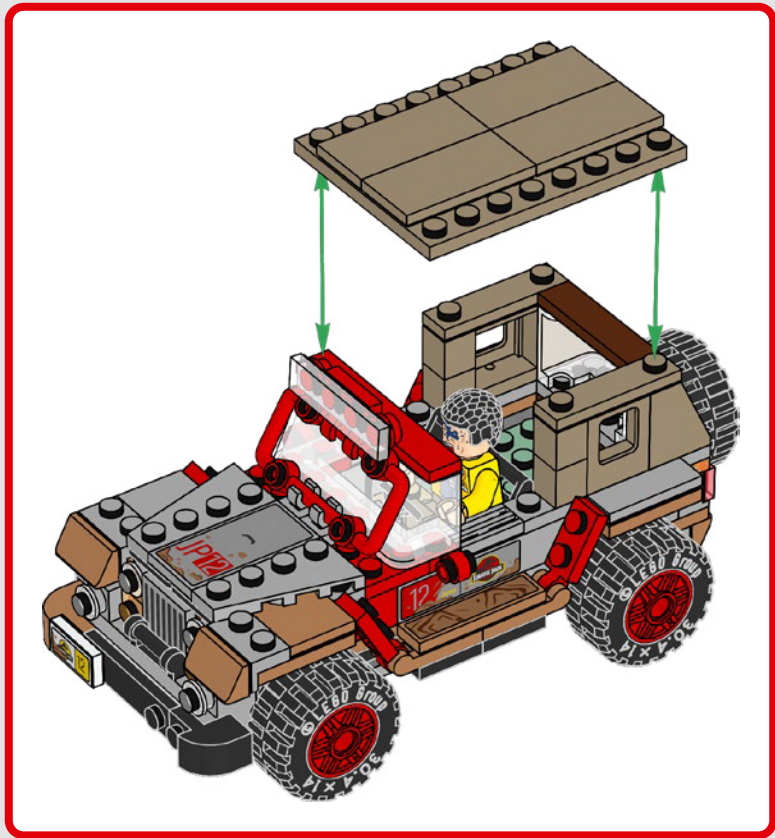

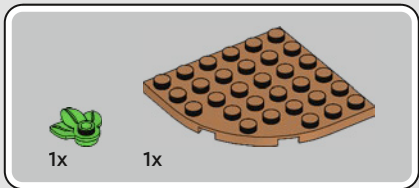

1

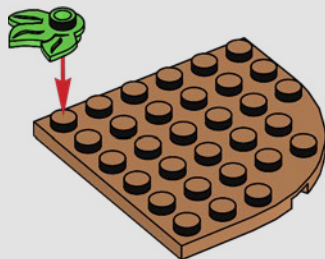



1x



1x

2

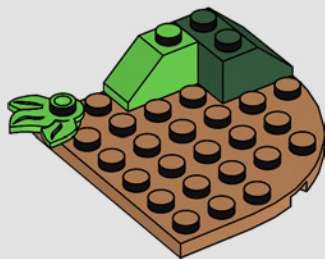

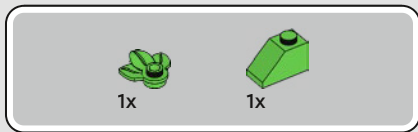

3

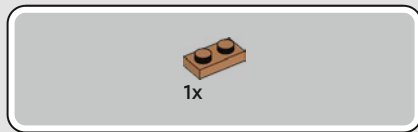
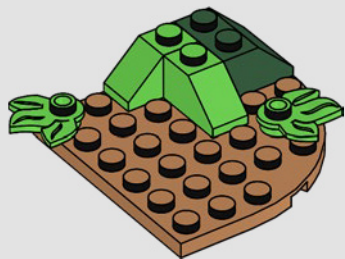

4

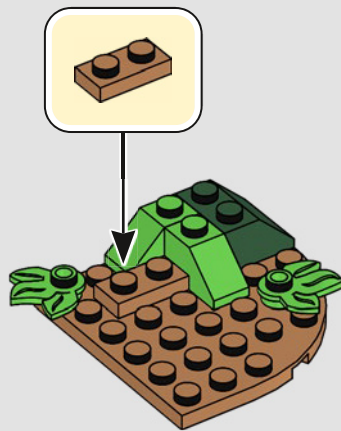



1x



2x

5

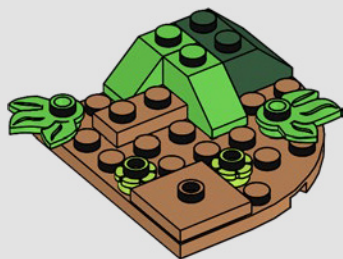



1x



1x

6



1x



1x

7

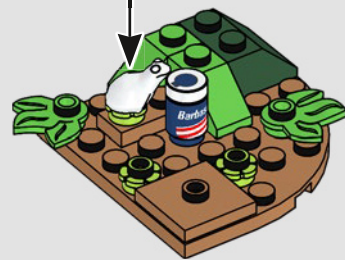
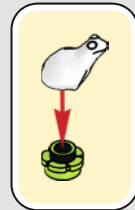



1x

8



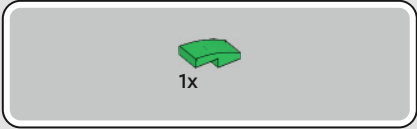

9

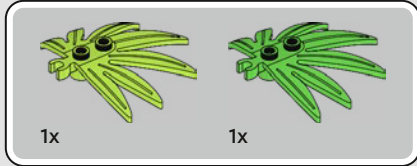

10





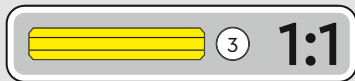
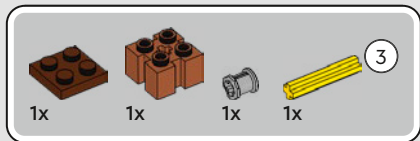

11

1



2

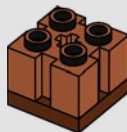

3

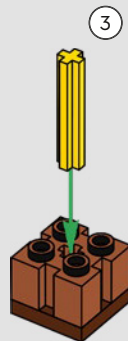

4

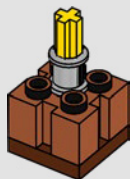

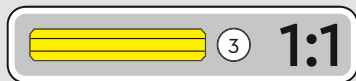
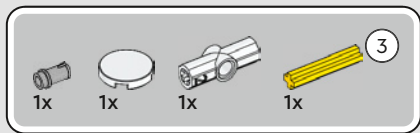

# 12

1



2

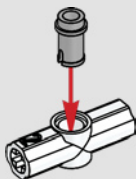

3

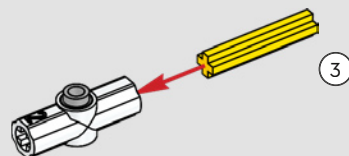

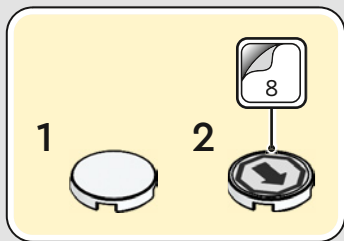

4

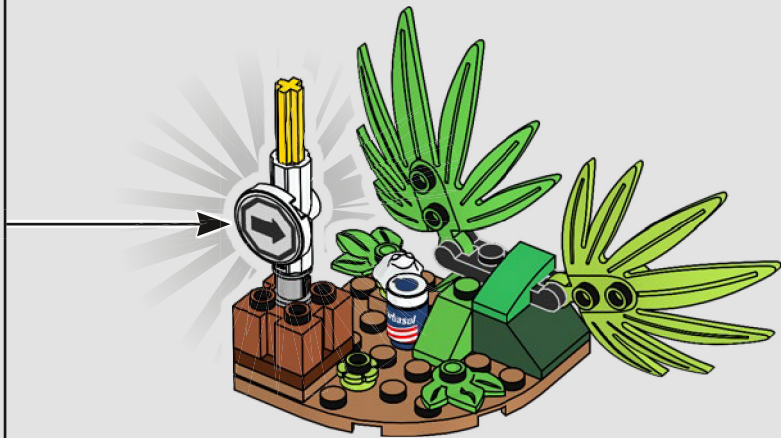



2x

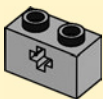

2x

13





1x

14



1x

15

1

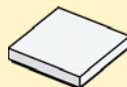

2



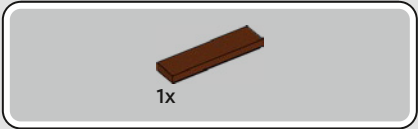

16

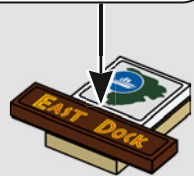
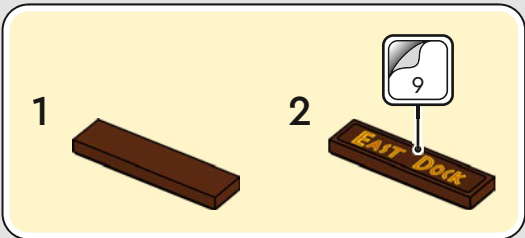

17

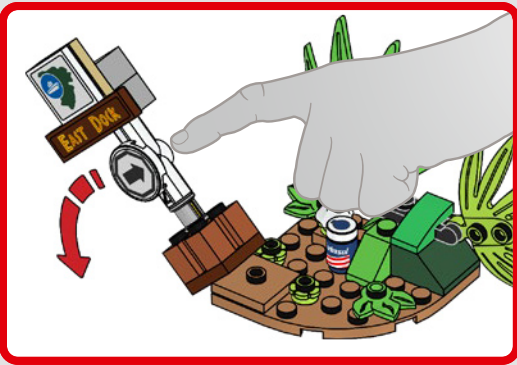







76961









4x  
6001824



1x  
4524098



2x  
6442915



2x  
6354068



2x  
6257599



4x  
6164288



1x  
4251796



1x  
6443351



1x  
6298930



1x  
6044691



2x  
306901



1x  
306801



1x  
6271870



4x  
6240030



1x  
6289455



1x  
6253681



1x  
6245195



1x  
6245195



1x  
6245195



1x  
6245195



1x  
74335



2x  
614121



4x  
6378120



2x  
6281994



2x  
300421



1x  
6360036



4x  
6346804



5x  
6256881



1x  
6439693



1x  
6439693



1x  
4113858



1x  
4113858



1x  
379521



2x  
6254248



4x  
6218358



3x  
6218360



1x  
6360296



1x  
6102994



4x  
6167699



6x  
6334099



2x  
6102998



2x  
6102998



2x  
6167700



2x  
6167700



1x  
6218359



1x  
6313600



1x  
6346466



1x  
6315198



1x  
4153825



4x  
6252040



4x  
4666579



2x  
6221467



1x  
4118790



1x  
6047426



2x  
6182261



2x  
6300148



1x  
6347460



3x  
6209692



1x  
6313098



1x  
6223304



2x  
4655080



4x  
6075626



3

2x  
6130007



2x  
6248833



1x  
6441115

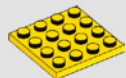

1x  
4243817



2x  
4211257



1x  
4216695



2x  
4211194



2x  
4211186



1x  
6275844



1x  
4211483



2x  
4211476



2x  
6308012



1x  
4211735



1x  
4211732



1x  
4211440



2x  
6206249



2x  
4654582



6x  
4211349



2x  
4558169



6x  
4211445



2x  
4560183



3x  
4211438



2x  
4211393



2x  
4211452

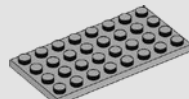

1x  
4211407



3x  
4211350



1x  
6444487



1x  
4226995



2x  
6020193



1x  
4225201



4x  
6061032



1x  
6099483



1x  
6254045



3x  
6138173



2x  
243226



1x  
6122096



5x  
6279875



1x  
6184784



5x  
4619323



2x  
4514845



2x  
4210963



2x  
6454959



7x  
4211095



1x  
6436296



1x  
6436346



1x  
6302448



1x  
6436298

 [LEGO.com/service](https://www.LEGO.com/service)



YOU COULD  
**WIN**



Scan this QR code or go to  
**LEGO.COM/PRODUCTFEEDBACK** and give  
us your short feedback about this LEGO® set  
for a chance to win a cool LEGO prize.

Terms and Conditions apply\*

**EN: YOU COULD WIN.** Terms and Conditions apply\* **DE: Du könntest GEWINNEN.** Es gelten die Teilnahmebedingungen\* **FR: Tu pourrais GAGNER.** Des conditions s'appliquent\* **IT: Potresti VINCERE tu.** Termini e condizioni sono applicabili\* **ES: Puedes GANAR.** Aplican términos y condiciones\* **PT: Poderá GANHAR.** Aplicam-se termos e condições\* **ZH: 轻松获奖. 条款和条件适用\*** **PL: Szansa na WYGRANĄ.** Obowiązują warunki korzystania\* **CS: Máte šanci VYHRÁT.** Platí všeobecné smluvní podmínky\* **SK: Máte šancu VYHRAŤ.** Platia všeobecné zmluvné podmienky\* **HU: TE IS NYERHETSZ.** Felhasználási feltételek érvényesek\* **RO: Ai putea CÂȘTIGA.** Se aplică termenii și condiții\* **BG: Можете да СПЕЧЕЛИТЕ.** Има определени правила и условия\* **LV: Tu vari LAIMĒT.** Ir spēkā noteikumi un nosacījumi.\* **ET: Sul on võimalus VÕITA.** Kehtivad tingimused\* **LT: Jūs galite LAIMĖTI.** Taikomos sąlygos\*

\*[LEGO.com/productfeedback-terms](https://www.lego.com/productfeedback/terms)

LEGO and the LEGO logo and are trademarks of the LEGO Group. ©2023 The LEGO Group. 6500726

© Universal City Studios LLC and Amblin Entertainment, Inc. All Rights Reserved.

Jeep, the Jeep grille and related logos, vehicle model names and trade dress are trademarks of FCA US LLC and used under license by the LEGO Group. ©2023 FCA US LLC.