

Lenco

STEREO FM RADIO WITH CD PLAYER SCD-24 / SCD-27

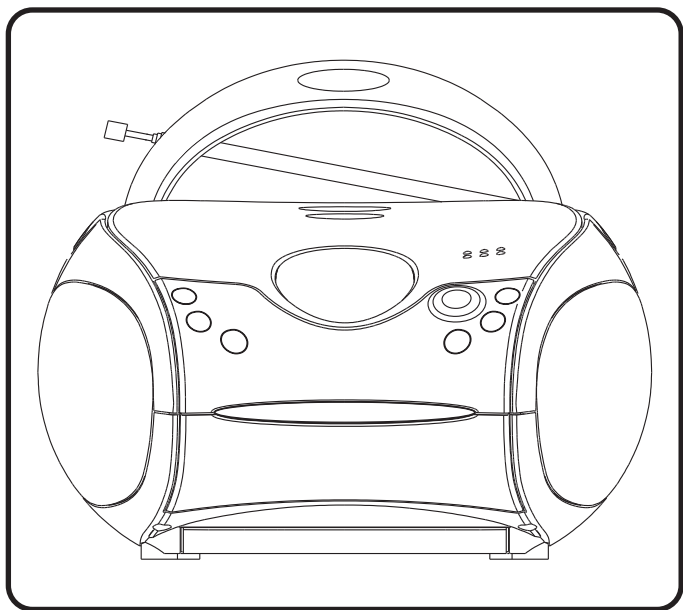

INSTRUCTION MANUAL

For information and support, www.lenco.com

WARNING

CLASS 1 LASER PRODUCT

CLASS 1 LASER PRODUCT
APPAREIL À LASER DE CLASSE 1
PRODUCTO LASER DE CLASE 1

CAUTION
INVISIBLE LASER RADIATION
WHEN OPEN AND INTERLOCKS
DEFEATED.
AVOID EXPOSURE TO BEAM



This product contains a low power laser device.

Warning: Do not touch the lens.

DO NOT THROW BATTERIES IN FIRE !

CAUTION

Usage of controls or adjustments or performance of procedures other than those specified herein may result in hazardous radiation exposure.

PRECAUTIONS BEFORE USE

KEEP THESE INSTRUCTIONS IN MIND:

1. Do not cover or block any ventilation openings. When placing the device on a shelf, leave 5 cm (2") free space around the whole device.
2. Install in accordance with the supplied user manual.
3. Keep the device away from heat sources such as radiators, heaters, stoves, candles and other heat-generating products or naked flame. The device can only be used in moderate climates. Extremely cold or warm environments should be avoided. Working temperature between 0° and 35°C.
4. Avoid using the device near strong magnetic fields.
5. Electrostatic discharge can disturb normal usage of this device. If so, simply reset and restart the device following the instruction manual. During file transmission, please handle with care and operate in a static-free environment.
6. Warning! Never insert an object into the product through the vents or openings. High voltage flows through the product and inserting an object can cause electric shock and/or short circuit internal parts. For the same reason, do not spill water or liquid on the product.
7. Do not use in wet or moist areas such as bathrooms, steamy kitchens or near swimming pools.
8. The device shall not be exposed to dripping or splashing and make sure that no objects filled with liquids, such as vases, are placed on or near the apparatus.
9. Do not use this device when condensation may occur. When the unit is used in a warm wet room with damp, water droplets or condensation may occur inside the unit and the unit may not function properly; let the unit stand in power OFF for 1 or 2 hours before turning on the power: the unit should be dry before getting any power.
10. Although this device is manufactured with the utmost care and checked several times before leaving the factory, it is still possible that problems may occur, as with all electrical appliances. If you notice smoke, an excessive build-up of heat or any other unexpected phenomena, you should disconnect the plug from the main power socket immediately.
11. This device must operate on a power source as specified on the specification label. If you are not sure of the type of power supply used in your home, consult your dealer or local power company.
12. Keep away from animals. Some animals enjoy biting on power cords.
13. To clean the device, use a soft dry cloth. Do not use solvents or petrol based fluids. To remove severe stains, you may use a damp cloth with dilute detergent.
14. The supplier is not responsible for damage or lost data caused by malfunction, misuse, modification of the device or battery replacement.
15. Do not interrupt the connection when the device is formatting or transferring files. Otherwise, data may be corrupted or lost.
16. If the unit has USB playback function, the USB memory stick should be plugged into the unit directly. Don't use an USB extension cable because it can cause interference resulting in failing of data.
17. The rating label has been marked on the bottom or back panel of the device.
18. This device is not intended for use by people (including children) with physical, sensory or mental disabilities, or a lack of experience and knowledge, unless they're under supervision or have received instructions about the correct use of the device by the person who is responsible for their safety.
19. This product is intended for non professional use only and not for commercial or industrial use.
20. Make sure the unit is adjusted to a stable position. Damage caused by using this product in an unstable position vibrations or shocks or by failure to follow any other warning or precaution contained within this user manual will not be covered by warranty.
21. Never remove the casing of this device.
22. Never place this device on other electrical equipment.

23. Do not allow children access to plastic bags.
24. Only use attachments/accessories specified by the manufacturer.
25. Refer all servicing to qualified service personnel. Servicing is required when the device has been damaged in any way, such as the power supply cord or the plug, when liquid has been spilled or objects have fallen into the device, when the device has been exposed to rain or moisture, does not operate normally, or has been dropped.
26. Long exposure to loud sounds from personal music players may lead to temporary or permanent hearing loss
27. If the product is delivered with power cable or AC power adaptor:
If any trouble occur, disconnect the AC power cord and refer servicing to qualified personnel.
Don't step on or pinch the power adaptor. Be very careful, particularly near the plugs and the cable's exit point. Do not place heavy items on the power adaptor, which may damage it. Keep the entire device out of children's reach! When playing with the power cable, they can seriously injure themselves.
Unplug this device during lightning storms or when unused for a long period.
The socket outlet must be installed near the equipment and must be easily accessible.
Do not overload ac outlets or extension cords. Overloading can cause fire or electric shock.
Devices with class 1 construction should be connected to a main socket outlet with a protective earthed connection.
Devices with class 2 construction do not require a earthed connection.
Always hold the plug when pulling it out of the main supply socket. Do not pull the power cord. This can cause a short circuit. Do not use a damaged power cord or plug or a loose outlet. Doing so may result in fire or electric shock.
28. If the product contains or is delivered with a remote control containing coin/cell batteries:
Warning: "Do not ingest battery, Chemical Burn Hazard" or equivalent wording.
[The remote control supplied with] This product contains a coin/button cell battery. If the battery is swallowed, it can cause severe internal burns in just 2 hours and can lead to death.
Keep new and used batteries away from children.
If the battery compartment does not close securely, stop using the product and keep it away from children.
If you think batteries might have been swallowed or placed inside any part of the body, seek immediate medical attention.
29. Caution about the use of Batteries:
Danger of explosion if battery is incorrectly replaced. Replace only with the same or equivalent type.
Battery cannot be subjected to high or low extreme temperatures, low air pressure at high altitude during use, storage or transportation.
Replacement of a battery with an incorrect type that can result in an explosion or the leakage of flammable liquid or gas.
Disposal of a battery into fire or a hot oven, or mechanically crushing or cutting of a battery, that can result in an explosion.
Leaving a battery in an extremely high temperature surrounding environment that can result in an explosion or that leakage of flammable liquid or gas.
A battery subjected to extremely low air pressure that may result in an explosion or the leakage of flammable liquid or gas.
Attention should be drawn to the environmental aspects of battery disposal.

INSTALLATION

Unpack all parts and remove protective material.

Do not connect the unit to the mains before checking the mains voltage and before all other connections have been made.

LOCATION OF CONTROLS

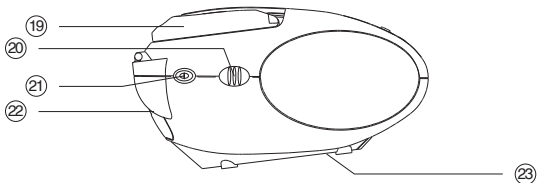
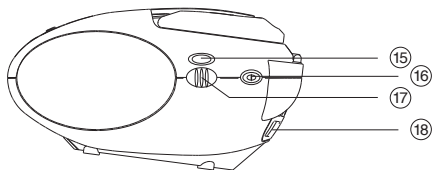
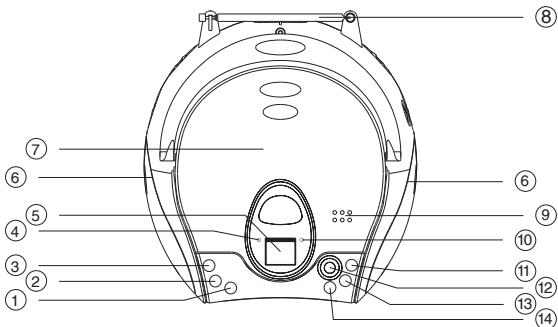

1. CD PROGRAM BUTTON
2. CD REPEAT BUTTON
3. BBS BUTTON
4. POWER INDICATOR
5. CD DISPLAY
6. SPEAKER
7. CD DOOR
8. TELESCOPIC ANTENNA
9. OPEN / CLOSE CD BUTTON
10. FM STEREO INDICATOR
11. CD NEXT BUTTON **▶▶**

12. CD PLAY / PAUSE BUTTON **▶▶||**
13. CD BACK BUTTON **◀◀**
14. CD STOP BUTTON **■**
15. DIAL SCALE
16. MODE SWITCH
17. TUNING CONTROL
18. AC SOCKET
19. CARRYING HANDLE
20. VOLUME CONTROL
21. FUNCTION SWITCH
22. PHONES JACK
23. BATTERY COMPARTMENT

POWER SUPPLY

USING HOUSE CURRENT

Before use, check that the rated voltage of your unit matches your local voltage.

Note: plug is used as the disconnect device.
the disconnect device shall remain readily operable.

USING BATTERIES

Disconnect the AC power cord from the AC inlet of the unit. Battery power is cut automatically by the cord while it is connected.

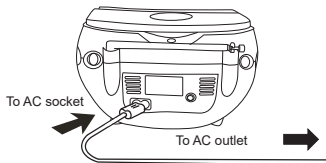

When the volume decrease, or the sound distorts, replace all of the batteries with new ones.

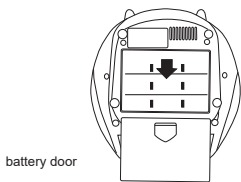

Insert 6 UM-2
(size C) batteries.

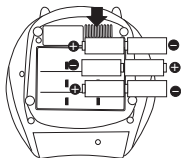

ADJUSTING THE SOUND

TO ADJUST THE VOLUME

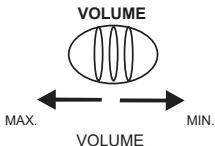

FOR PRIVATE LISTENING

Plug in headphones (ø3.5 mm stereo mini-plug) to the PHONES jack.

When headphones are plugged in, the speakers are automatically disconnected.

LISTENING TO THE RADIO

1. Set to RADIO



3. Tune in to a station.

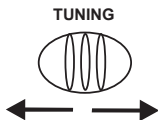

2. Select a MODE.

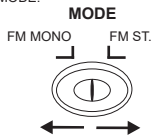

4. Adjust the sound.

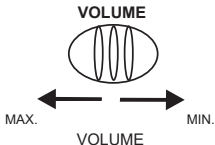

FOR BETTER RECEPTION



FM

- NOTE :**
1. FM stereo LED indicator lights if receive FM stereo broadcast and the MODE switch set on "FM STEREO".
 2. When too much noise is heard during FM STEREO reception, set MODE switch to FM mono.

AFTER LISTENING

Set the FUNCTION selector to OFF.

COMPACT DISC PLAYBACK

1. Set to CD



2. Open the CD door by pushing CD Door Open / Close button.

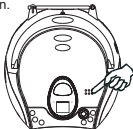

3. Insert a disc with the label side facing up.

4. Close the CD door.
The disc will rotate and the total tracks of the disc will show on the display.



5. Press the Play / Pause button. Track number "01" & "PLAY" will be shown.



TO INTERRUPT PLAYBACK

Press the Play/Pause button and the symbol "PLAY" will be flashed.

Press the button again to resume playback.



TO SKIP TO THE BEGINNING OF A TRACK

- Press either one of the skip buttons according to the desired skip direction.
- Play/back resumes from the selected track.
- When the skip back button is pressed once during play, the previous track starts again.
- When the skip forward button is pressed once during play, the next track plays.



SEARCHING FOR A PASSAGE WITHIN A TRACK

- Keep the skip back or skip forward button pressed during playback, and release the button as soon as you recognise the desired passage. Then normal CD playback will resume from this point.

Unit will be automatically off at about 15 mins without any operation (in stop mode / CD door open).

After auto off, slide the FUNCTION selector to OFF position and then slide to RADIO / CD position for listening.

REPEAT PLAYBACK

This function allows a single track or all tracks on a disc to be played repeatedly.

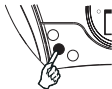

TO REPEAT THE SAME TRACK

Press the REPEAT button once during playback, the CD display will indicate " REPEAT ".

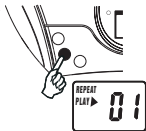

TO REPEAT THE WHOLE DISC

Press the REPEAT button twice until " REPEAT ALL " displays.

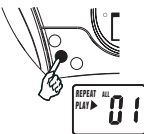

TO CANCEL REPEAT PLAYBACK FUNCTION

Press the REPEAT button again until " REPEAT " or " REPEAT ALL " disappears from the display.



Note on CD-R/RW discs

- Because of non-standardized format definition/ production of CD-R/RW, playback quality and performance are not guaranteed.
- Manufacturer is not responsible for the playability of CD-R/RW due to recording conditions, such as PC performance, writing software, media ability, etc.
- Do not attach a seal or label to either side of the CD-R/RW disc. It may cause a malfunction.
- It is recommended to record only audio files on CD-R/RW discs for easy reading.

BASS BOOST

To enjoy a BASS BOOST sound effect, press BBS button.

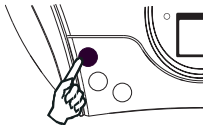

PROGRAM PLAYBACK

PROGRAMMED PLAYBACK

Programmed playback enables tracks on a disc to be played in the desired order. Up to 20 tracks can be programmed.

1. Press the " PROGRAM " button.
2. Press the " NEXT ►►► " and " BACK ◀◀◀ " buttons to select the desired track number.
3. Press " PROGRAM " button again to memorize the track.
4. Repeat steps 2 and 3 until all desired tracks are programmed.
5. Press the " PLAY/PAUSE " button to start. " PLAY ► ", " PROGRAM " & track number are shown on the CD display.
6. Press " STOP " button to stop programmed playback.

7. Press " PLAY/PAUSE " buttons to resume programmed playback.
8. Open the CD door, turn off the CD player or press " STOP " button twice to clear the programmed memory.

Note : Programming can only be made when the player is in stop mode.

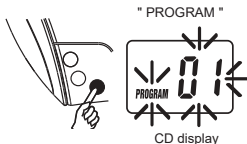

MAINTENANCE

CLEANING A CD

If the CD skips or will not play, the disc may need cleaning. Before playing, wipe the disc from the centre out with a cleaning cloth. After playing, store the disc in its case.



CLEANING THE CD LENS

If the CD lens is dusty, clean it with a brush-blower. Blow several times on the lens and remove the dust with the brush. Finger prints may be removed with a cotton swab moistened with alcohol.

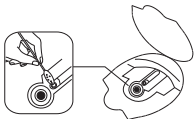

CLEANING THE UNIT

Do not use volatile chemicals on this unit. Clean by lightly wiping with a soft cloth.

IMPORTANT NOTE

If an abnormal display indication or an operating problem occurs, disconnect the AC power cord and remove the batteries. Wait at least 5 seconds, then reconnect the AC power cord or reinstall the batteries.

WARNING

Should the CD door be opened before the reading of the CD is completed, a jamming noise may occur. This is resolved by closing the CD door.

SPECIFICATIONS

CD

S/R ratio:	58 dB
Sample frequency:	44.1 kHz 8x oversampling
Quantization:	1 bit DA converter
Laser wavelength:	790 nm

Radio

Frequency range:	FM: 87.5 - 108Mhz
Antenna:	Telescopic

General

Input voltage:	AC 230V- 50Hz
Power consumption:	13.5W
Output power:	1W + 1W (RMS)
Speaker size:	3"
Speaker impedance:	8 Ohm
Phones output:	3.5mm Jack
Battery specification:	6x 1.5V LR14/C/UM2
Dimensions:	224 x 234 x 126mm (wxdxh)
Weight:	1.45Kg

Commox International reserves the right to change the contents of this document without notice.

Guarantee

Lenco offers service and warranty in accordance with the European law, which means that in case of repairs (both during and after the warranty period) you should contact your local dealer.

Important note: It is not possible to send products that need repairs to Lenco directly.

Important note: If this unit is opened or accessed by a non-official service center in any way, the warranty expires.

This device is not suitable for professional use. In case of professional use, all warranty obligations of the manufacturer will be voided.

Disclaimer

Updates to Firmware and/or hardware components are made regularly. Therefore some of the instruction, specifications and pictures in this documentation may differ slightly from your particular situation. All items described in this guide for illustration purposes only and may not apply to particular situation. No legal right or entitlements may be obtained from the description made in this manual.

Disposal of the Old Device



This symbol indicates that the relevant electrical product or battery should not be disposed of as general household waste in Europe. To ensure the correct waste treatment of the product and battery, please dispose them in accordance to any applicable local laws of requirement for disposal of electrical equipment or batteries. In so doing, you will help to conserve natural resources and improve standards of environmental protection in treatment and disposal of electrical waste (Waste Electrical and Electronic Equipment Directive).

DECLARATION OF CONFORMITY

Hereby, Commaxx declares that the radio equipment type [Lenco SCD-24] is in compliance with directive 2014/53/EU. The full text of the EU declaration of conformity is available at the following internet address:
https://commaxx-certificates.com/doc/scd-24_doc.pdf

Type RF	Frequency range (MHz)	Power (dBm)
FM	87.5 - 108	—



WARNING:

To prevent possible hearing damage, do not listen at high volume levels for long periods.

Service

For more information and helpdesk support, please visit www.lenco.com
Commaxx B.V. Wiebachstraat 37, 6466 NG Kerkrade, The Netherlands.