

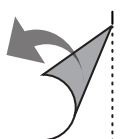

OLED48CX\*

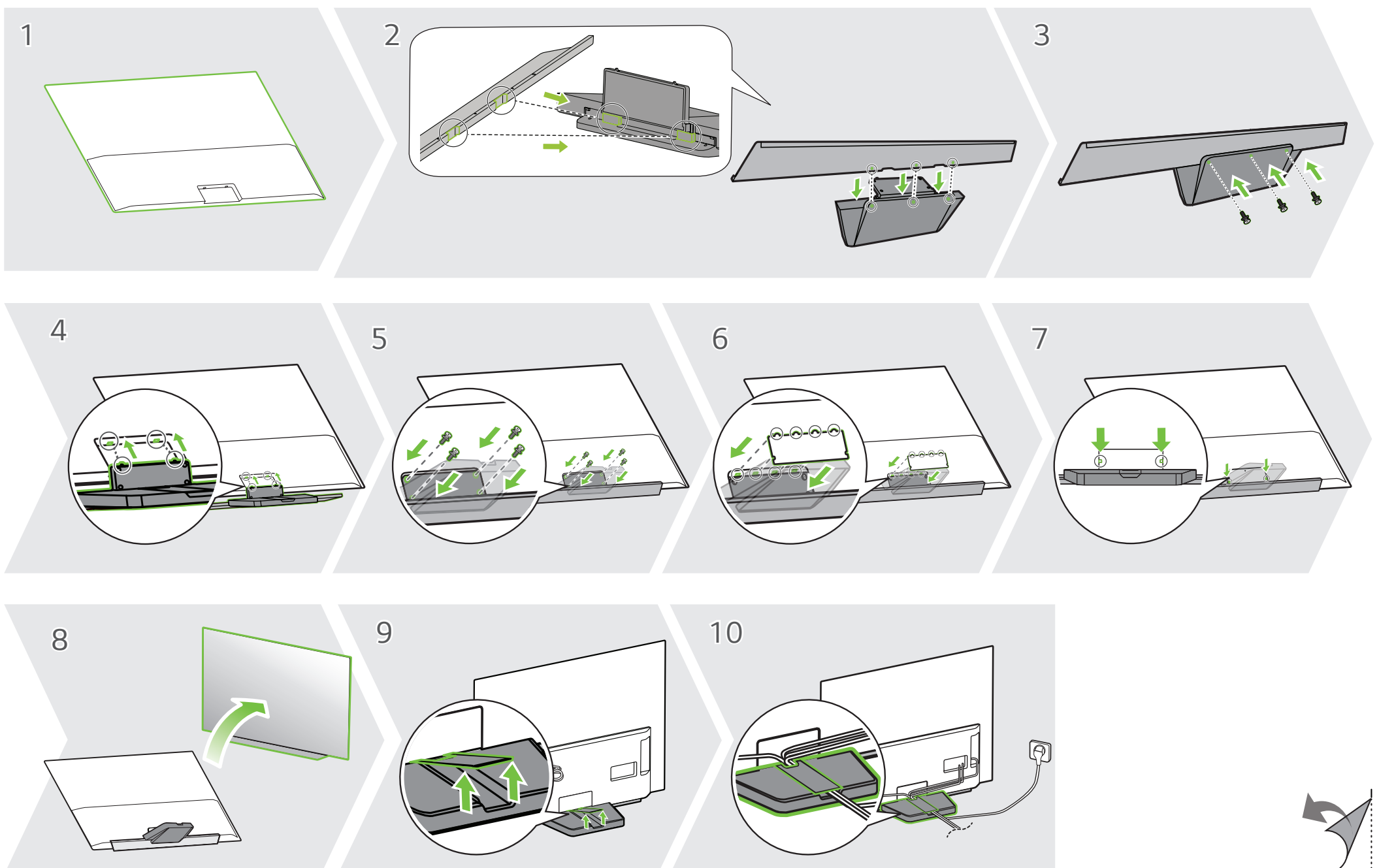

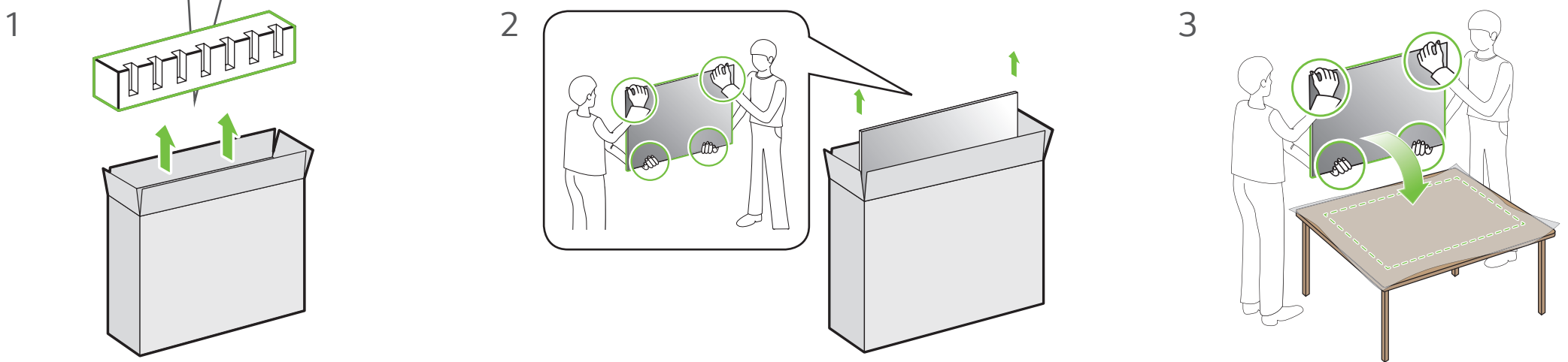
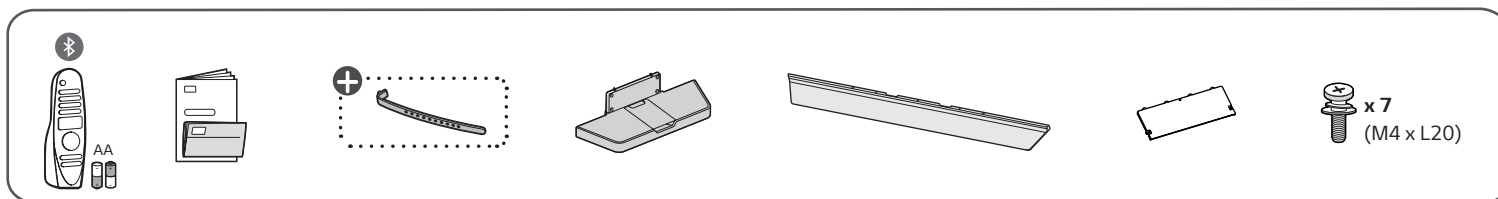
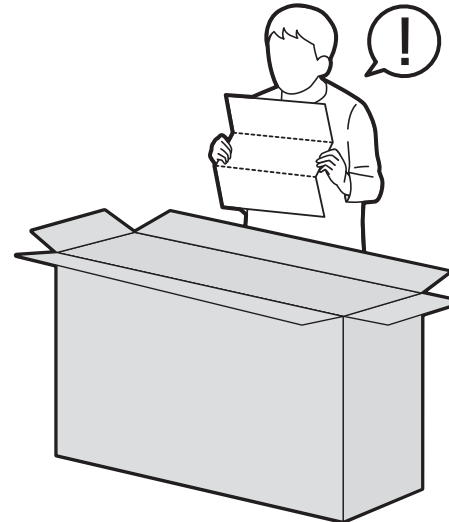
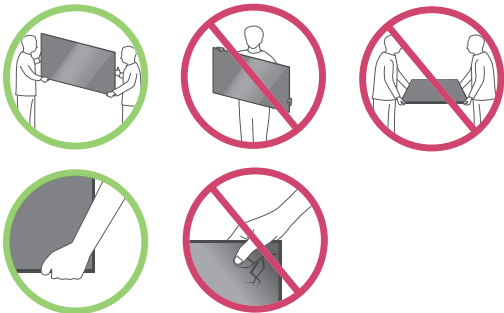
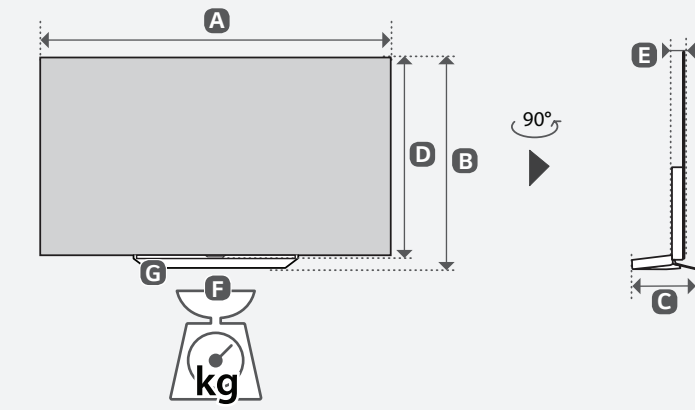
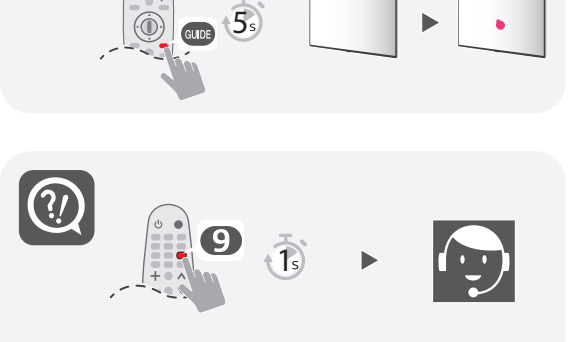
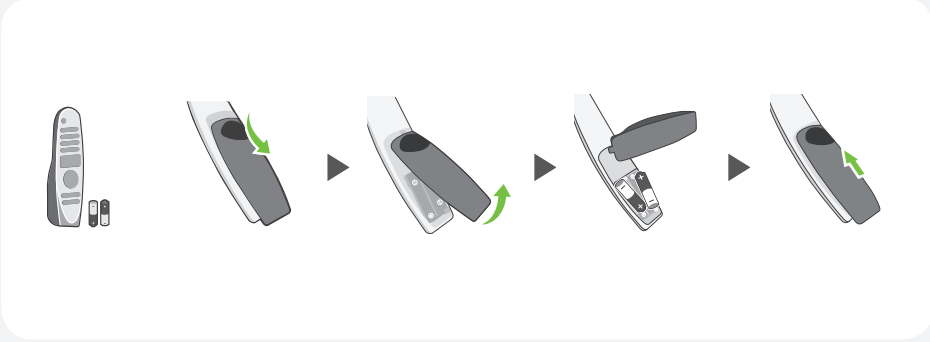
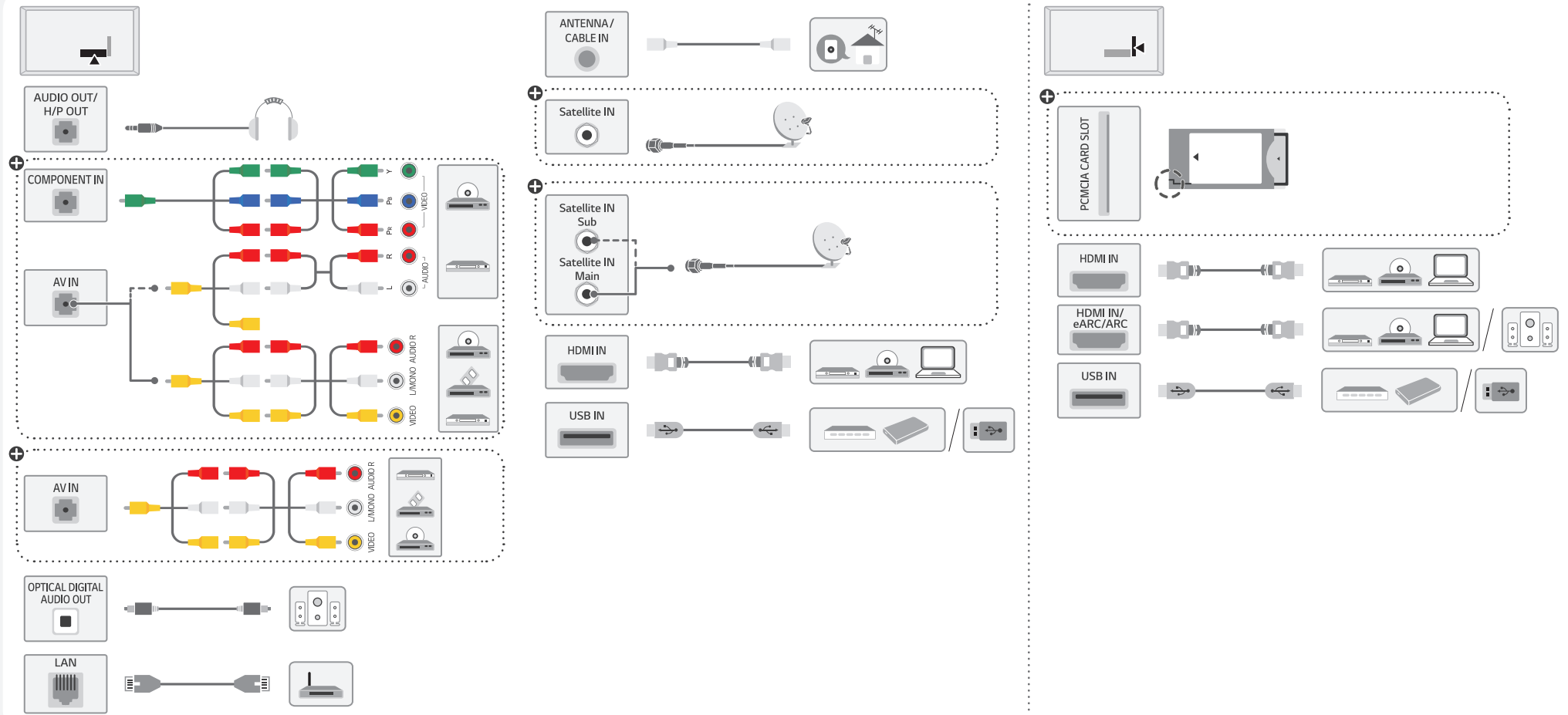

	A	B	C	D	E	F	F-G
	(mm)					(kg)	
OLED48CX3LB	1071	650	251	618	46.9	18.9	14.9
OLED48CX6LB							
OLED48CX9LB							
OLED48CX5LC							
OLED48CX8LC							
Power requirement	AC 100-240 V ~ 50 / 60 Hz						



- |             |   |            |   |             |   |
|-------------|---|------------|---|-------------|---|
| English     | ·Read Safety and Regulatory.  | Hrvatski   | ·Pročitajte <b>Sigurnost i usklađenost s propisima.</b>                           | Română      | ·Consultați manualul referitor la <b>siguranță și reglementare.</b> |
| Deutsch     | ·Lesen Sie die <b>Sicherheitsanweisungen und Richtlinien.</b>       | Shqip      | ·Lexoni paragrafin " <b>Siguria dhe rregullimi.</b> "                             | Български   | ·Прочетете <b>Безопасност и регулаторни стандарти.</b>              |
| Français    | ·Lire le document <b>Sécurité et mesures réglementaires.</b>        | Bosanski   | ·Pročitajte dio <b>Sigurnost i propisi.</b>                                       | Eesti       | ·Lugege <b>ohutus- ja normatiivteavet.</b>                          |
| Italiano    | ·Leggere il manuale <b>Sicurezza e normativa.</b>                   | Македонски | ·Прочитajte за <b>безбедноста и регулативата.</b>                                 | Lietuvių k. | ·Perskaitykite <b>Saugos ir norminius reikalavimus.</b>             |
| Español     | ·Leer <b>Seguridad y normativa.</b>                                 | Svenska    | ·Läs <b>Säkerhet och föreskrifter.</b>  | Latviešu    | ·Izlasiet sadaļu <b>Drošība un normatīvi.</b>                       |
| Português   | ·Ler informações sobre a <b>Segurança e Regulamentos.</b>           | Magyar     | ·Biztonsági szabályzat megtekintése.  | Srpski      | ·Pročitajte odeljak <b>Bezbednost i regulatorna pitanja.</b>        |
| Nederlands  | · <b>Veiligheidsinformatie en regelgeving</b> lezen.                | Polski     | ·Prosimy o przeczytanie <b>Zasad bezpieczeństwa i uwag dotyczących przepisów.</b> | Norsk       | ·Les <b>sikkerhet og forskrifter.</b>                               |
| Ελληνικά    | ·Διαβάστε τις <b>οδηγίες για την ασφάλεια και τους κανονισμούς.</b> | Česky      | ·Přečtěte si část <b>Bezpečnost a zákonné předpisy.</b>                           | Dansk       | ·Læs <b>sikkerhed og lovmæssige bestemmelser.</b>                   |
| Slovenščina | ·Preberite <b>varnostne in regulativne vidike.</b>                  | Slovenčina | ·Přečítajte si <b>bezpečnostné a regulačné informácie.</b>                        | Suomi       | ·Lue <b>Turvallisuus ja säännökset</b> -osio.                       |

+ : Depending on model / Abhängig vom Modell / Selon le modèle / In base al modello / En función del modelo / Dependendo do modelo / Afhankelijk van het model / Αν λογα με το μοντ λο / Odvisno od modela / Tipusfüggő / Zależnie od modelu / Závisí na modelu / V závislosti od modelu / În funcție de model / в зависимости от модели / Sõltub mudelist / Priklauso nuo modelio / Atkarībā no modeļa / U zavisnosti od modela / Ovisno o modelu / Né varəsi tē modelit / Ovisno o modelu / во зависност од моделот / Beroende på modell / Avhengig av modell / Afhängigt af modellen / Mallin mukaan