

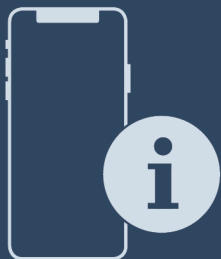

User Guide

Quality, Design and Innovation





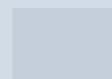















home.liebherr.com/fridge-manuals







LIEBHERR



Contents

1	The appliance at a glance	3
1.1	Delivered contents.....	3
1.2	Appliance and equipment overview.....	3
1.3	Range of appliance use.....	3
1.4	Conformity.....	4
1.5	EPREL Database.....	4
2	General safety instructions	4
3	Start-up	5
3.1	Turning on the appliance.....	5
3.2	Insert the equipment.....	6
4	Food management	6
4.1	Storing food.....	6
4.2	Storage times.....	6
5	Energy saving	7
6	Use	7
6.1	Controls and displays.....	7
6.1.1	Status display.....	7
6.1.2	Navigation.....	7
6.1.3	Operating structure.....	7
6.1.4	Display symbols.....	8
6.2	Operating logic.....	8
6.2.1	Activating/deactivating settings.....	8
6.2.2	Selecting function value.....	8
6.2.3	Activating/deactivating settings.....	8
6.2.4	Selecting the setting value.....	8
6.2.5	Calling up the customer menu.....	9
6.3	Functions.....	9
	Temperature.....	9
	SuperFrost.....	9
	PartyMode.....	9
	E-Saver.....	9
	IceMaker*.....	10
	MaxIce*.....	10
6.4	Settings.....	10
	Setting up the WLAN connection.....	10
	Entry lock.....	11
	Display brightness.....	11
	Door alarm.....	11
	Temperature unit.....	11
	Info.....	11
	SabbathMode.....	11
	TubeClean*.....	12
	Ice cubes*.....	12

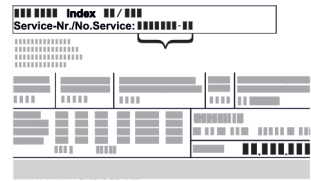
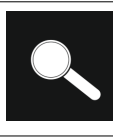
	Reminder.....	12
	Reset.....	12
	Turn off appliance.....	12
6.5	Error messages.....	12
6.5.1	Warnings.....	12
6.5.2	Message.....	13
6.5.3	DemoMode.....	13
7	Equipment	13
7.1	Drawers.....	13
7.2	Pull-out board with IceTower*.....	13
7.5	VarioSpace.....	16
7.6	Accessories.....	16
8	Maintenance	16
8.1	Defrosting the appliance.....	16
8.2	Cleaning the appliance.....	16
9	Customer support	18
9.1	Technical specifications.....	18
9.2	Operating noises.....	18
9.3	Technical faults.....	19
9.4	Customer service.....	20
9.5	Rating plate.....	20
10	Decommissioning	20
11	Disposal	20
11.1	Preparing appliance for disposal.....	20
11.2	Disposing of the appliance in an environmentally friendly manner.....	21

The manufacturer is constantly working to improve all types and models. Therefore, please be aware that we reserve the right to make changes to the shape, equipment and technology.

Symbol	Explanation
	Read instructions Please read the information in these instructions carefully to understand all of the benefits of your new appliance.
	Full instructions on the internet You can find detailed instructions on the internet using the QR code on the front of these instruction or by entering the service number at home.liebherr.com/fridge-manuals . The service number can be found on the serial tag:  <i>Fig. Example illustration</i>
	Check appliance Check all parts for transport damage. If you have any complaints, please contact your agent or customer service.
	Differences These instructions apply to a range of models, so there may be differences. Sections that apply to certain models only are indicated by an asterisk (*).

Symbol	Explanation
	Instructions and results Instructions are marked with a ▶. Results are marked with a ▷.
	Videos Videos about the appliances are available on the YouTube channel of Liebherr-Hausgeräte.

These operating instructions apply to:

FN d/e/f	42/46/50/52...
FN c/d	66/70/72...
FN sf e	5227
SFN (bd/sd/sf) e	52...
GNeu	1460-e
LTGN-234	

Note

If your appliance has an N in its appliance designation, it is a NoFrost appliance.

1 The appliance at a glance

1.1 Delivered contents

Check all parts for damage during transport. If you have any complaints, please contact the dealer or Customer Service (see 9.4 Customer service).

Delivery contains the following parts:

- Standalone appliance
- Equipment (depending on your model)
- Installation parts (depending on your model)
- "Quick Start Guide"
- "Installation Guide"
- Service brochure

1.2 Appliance and equipment overview

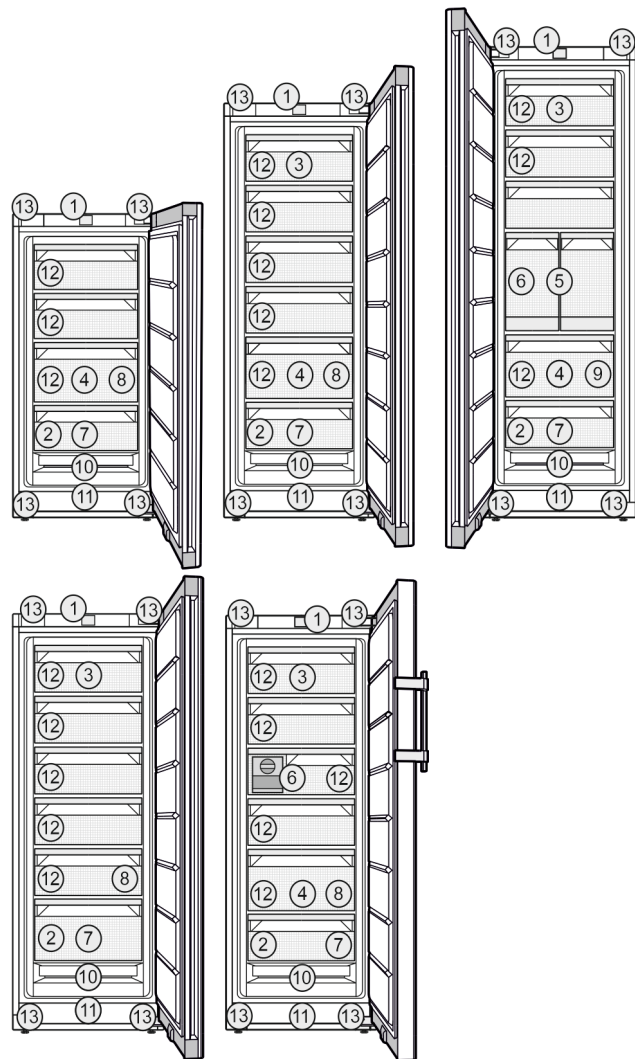

Fig. 1 Example illustration

Equipment

- | | |
|--|--|
| (1) Control elements | (8) Ice cube tray* |
| (2) Serial tag | (9) Ice cube scoop* |
| (3) Tilting drawer* | (10) NoFrost |
| (4) SpaceBox* | (11) Ventilation slit |
| (5) IceTower* | (12) VarioSpace |
| (6) IceMaker* / EasyTwist-Ice* | (13) Adjustable feet (front),
transport castors (rear),
transport handles at the
top (rear) and bottom
(front) |
| (7) Freezer tray*, cold
storage accumulators* | |

Note

- ▶ The shelves, drawers, and baskets are arranged for optimal energy efficiency in the factory configuration. However, changes to the arrangement within the given insertion options – for example the arrangement of shelves in the fridge compartment – have no effect on energy consumption.

1.3 Range of appliance use

Normal use

The appliance is only suitable for cooling food for residential or other similar environments. This includes the following types of uses

General safety instructions

- in staff kitchens, bed and breakfasts,
- by guests in country homes, hotels, motels and other types of accommodations,
- for catering and similar wholesale services.

The appliance is not suitable as a built-in unit;

All other types of uses are not permitted.

Foreseeable misuse

The following uses are specifically prohibited:

- Storage and cooling of medication, blood plasma, laboratory preparations or similar substances and products in accordance with the Medical Device Directive 2007/47/EC
- Use in areas at risk of explosion

Incorrect appliance use can cause damage to the stored products or cause them to spoil.

Climate ratings

The appliance is set to operate within specific ambient temperature limits according to its climate rating. The climate rating for your appliance is printed on the rating plate.

Note

► To guarantee trouble-free operation, comply with the indicated ambient temperatures.

Climate rating	for ambient temperatures
SN, N	to 32 °C
ST	to 38 °C
T	to 43 °C

If your appliance has a fixed water connection, then the appliance is guaranteed to function correctly down to a lower ambient temperature of 0 °C.*

If your appliance does not have a fixed water connection, then the appliance is guaranteed to function correctly down to a lower ambient temperature of -15 °C.*

1.4 Conformity

The refrigerant circuit has been tested for leaks. The appliance complies with the applicable safety regulations and with the directives 2014/35/EU, 2014/30/EU, 2009/125/EC, 2011/65/EU, 2010/30/EU and 2014/53/EU.

The full text of the EU Declaration of Conformity is available on the following website: www.Liebherr.com

1.5 EPREL Database

Details about energy labeling and ecodesign requirements will be available on the European product database (EPREL) from March 1, 2021. You can access the product database at the following link: <https://eprel.ec.europa.eu/> You will be asked to enter the model ID. You can find the model ID on the type plate.

2 General safety instructions

Please keep these operating instructions in a safe place so you can refer back to them at any time.

If you pass the appliance on, please hand these operating instructions to the new owner.

Read these operating instructions before use in order to use the appliance safely and correctly. Follow the instructions, safety instructions and warning messages included at all times. They are important for ensuring you can operate and install the appliance safely and without any problems.

Dangers for the user:

- This appliance can be operated by children as well as by persons with reduced physical, sensory or mental capabilities or lack of experience and knowledge if they are supervised or have been instructed in the safe use of the appliance and understand the associated risks. Children must not play with the appliance. Cleaning and user maintenance must not be performed by children unless they are supervised. Children between the ages of 3 and 8 may load and unload the appliance. Children under the age of 3 must be kept away from the appliance if they are not constantly supervised.
- The socket must be easily accessible so that the appliance can be disconnected quickly from the electricity in an emergency. It must not be located in the area behind the appliance.
- When disconnecting the appliance from the outlet, always take hold of the plug. Do not pull on the cable.
- Disconnect the power plug or switch off the power if a fault occurs.
- Do not damage the mains power line. Do not operate the appliance from a defective mains power line.
- Repairs and work on the appliance may only be carried out by after sales service or other specifically trained qualified personnel.
- The appliance should only be assembled, connected and disposed of in accordance with the instructions.
- The manufacturer is not liable for damage arising from incorrect connection to the water supply.*

Risk of fire:

- The refrigerant contained within the appliance (specifications on the rating plate) is environ-

mentally friendly, but flammable. Leaking refrigerant can ignite.

- Do not damage the pipes of the refrigerant circuit.
- Do not handle ignition sources inside the appliance.
- Do not use electrical devices inside the appliance (e.g. steam cleaners, heaters, ice cream makers, etc.).
- If refrigerant leaks: Remove naked flames or ignition sources located near the area of the leak. Air the room well. Contact the customer service department.
- Do not store explosive materials or spray cans with flammable propellants, such as e.g. butane, propane, pentane, etc. in the appliance. You can recognize such spray cans by the printed contents or a flame symbol. Any leaking gasses can be ignited by electrical components.
- Keep lit candles, lamps and other objects with naked flames away from the appliance so they do not cause a fire.
- Alcoholic beverages or other containers holding alcohol must always be tightly sealed for storage purposes. Any leaking alcohol can be ignited by electrical components

Tipover hazard:

- Do not stand or climb on the base, drawers, doors, etc. This applies in particular to children.

Risk of food poisoning:

- Do not consume food that has passed its best before date.

Danger of frostbite, feelings of numbness and pain:

- Avoid prolonged skin contact with cold surfaces or chilled/frozen food or take protective measures, e.g. wear gloves.

Risk of injury and damage:

- Hot steam may lead to injuries. Do not use any electrical heating or steam cleaning equipment, naked flames or defrosting sprays for defrosting
- Do not remove ice with sharp objects

Risk of crushing:

- Do not reach into the hinge when opening and closing the door. Fingers may get trapped.

Symbols on the device:



The symbol can be on the compressor. It refers to the oil in the compressor and refers to the following danger: Can be lethal if swallowed or inhaled. This notice only applies for recycling. There is no danger during normal operation.



The symbol is located on the compressor and indicates the danger of flammable materials. Do not remove the label.



This label or a similar one can be located on the rear of the appliance. It refers to the foamed-in panels in the door and/or the housing. This notice only applies for recycling. Do not remove the label.

Observe the warning messages and other detailed information in the other sections:

	DANGER	indicates a hazardous situation, which if not avoided, will result in death or serious injury.
	WARNING	indicates a hazardous situation, which if not avoided, could result in death or serious injury.
	CAUTION	indicates a hazardous situation, which if not avoided, will result in minor or moderate injury.
	NOTICE	indicates a hazardous situation, which if not avoided, could result in damage to property.
	Note	indicates useful advice and tips.

3 Start-up

3.1 Turning on the appliance

Make sure that the following requirements are met:

- Appliance is set up and connected according to installation instructions.
- All adhesive strips, adhesive and protective films, as well as transport safety devices in and on the appliance are removed.
- All advertising material has been removed from the drawers.

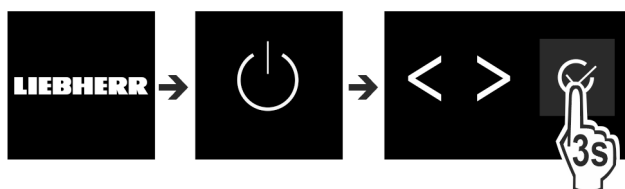

Fig. 2

- ▶ Switch on the appliance using the control panel next to the display.
- ▷ The status display appears.

The appliance starts in DemoMode:

If the appliance starts in DemoMode, you can deactivate DemoMode within the next 5 minutes.

Food management

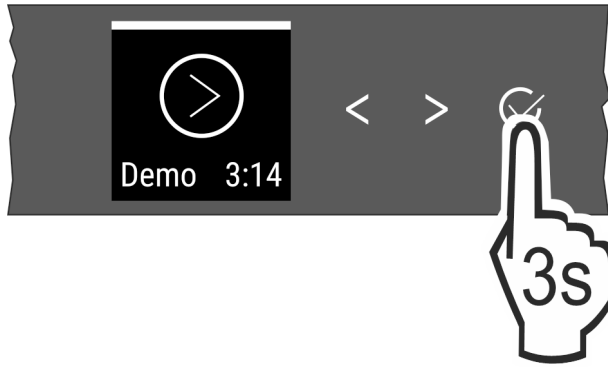

Fig. 3

- ▶ Press Confirm next to the display for 3 seconds.
- ▷ DemoMode is deactivated.

Note

The manufacturer recommends:

- ▶ **Store frozen foods** at -18 °C or colder.

3.2 Insert the equipment

- ▶ Insert the supplied equipment to help you make the most of the appliance.
- ▶ Purchase the SmartDevice Box and insert it (see smartdevice.liebherr.com).
- ▶ Install the SmartDevice app (see apps.home.liebherr.com).

Note

You can purchase accessories from the Liebherr household appliance store (home.liebherr.com).

4 Food management

4.1 Storing food



WARNING

Danger of fire

- ▶ Do not use electrical appliances inside the food storage compartments of the appliance, unless they are of the type recommended by the manufacturer.

Note

Insufficient ventilation results in an increase in energy consumption and reduction of the refrigerating performance

- ▶ Always keep the air slots unobstructed.

When storing food, remember these basic rules:

- Do not obstruct the air vents on the back wall.
- Do not obstruct the air vents on the fan.
- Food is well sealed.
- Raw meat or fish is in clean, sealed containers so that other food cannot be touched or drip on them.
- Food is stored spaced apart to ensure good air circulation.

Note

Failure to follow these guidelines can lead to food perishing.

4.1.1 Freezer

This provides a dry, frosty storage climate at -18 °C. A frosty climate is suitable for storing frozen food and goods for several months, preparing ice cubes, or freezing fresh food.

Freezing food

You can freeze as many kilograms of fresh food within 24 hours as indicated on the nameplate (see 9.5 Rating plate) under "freezing capacity ... kg/24h".

To ensure that the food freezes quickly to the core, keep to the following quantities per pack:

- Fruit, vegetables up to 1 kg
- Meat up to 2.5 kg

Before freezing, please note the following:

- SuperFrost is activated (see 6.3 Functions) when the amount of food to freeze exceeds approx. 2 kg.
- With a small volume of frozen goods: SuperFrost is activated approx. 6 hours prior.
- With the maximum volume of frozen goods: SuperFrost is activated approx. 24 hours prior.

Arranging the food:



CAUTION

There is a risk of injury from pieces of broken glass!

Bottles and cans containing drinks can split or crack when frozen. This applies in particular to carbonated drinks.

- ▶ The *BottleTimer* function must be used when freezing bottles and cans with drinks.

With a small amount of frozen goods:

- ▶ Place packaged groceries in the top drawer.
- ▶ If possible, place groceries at the back of the drawer near the rear wall.

With the maximum amount of frozen goods:

- ▶ Distribute packaged groceries across all drawers, but do not place any groceries in the lowest drawer.

- ▶ If possible, place groceries at the back of the drawer near the rear wall.

With the maximum amount of frozen goods:

- ▶ Once SuperFrost activates automatically, place food into the drawer.

Defrosting food

- in the fridge compartment
- in the microwave
- in the oven/fan oven
- at room temperature



WARNING

Danger of food poisoning!

- ▶ Do not re-freeze defrosted food.

- ▶ Remove only the food you need for now.
- ▶ Use defrosted food as quickly as possible

Freezer tray*

Use the freezer tray for berries, herbs, vegetables and other small goods without them freezing together in the process. The food keeps its shape and is easier to separate into portions later on.

You can also store the freezer packs in the freezer tray to save space.*

- ▶ Spread food, unsealed, at a good distance apart, over the whole surface of the freezer tray.

4.2 Storage times

The storage times given are guidelines

Food with a "use by" date must still be consumed by the date indicated on the package

Guidelines for storage periods for various foods		
Ice cream	at -18 °C	2 to 6 months
Sausage, ham	at -18 °C	2 to 3 months
Bread, bakery products	at -18 °C	2 to 6 months
Game, pork	at -18 °C	6 to 9 months
Fish, fatty	at -18 °C	2 to 6 months
Fish, lean	at -18 °C	6 to 8 months
Cheese	at -18 °C	2 to 6 months
Poultry, beef	at -18 °C	6 to 12 months
Vegetables, fruit	at -18 °C	6 to 12 months

5 Energy saving

- Always ensure good ventilation. Do not obstruct ventilation openings or grilles.
- Never block air slits in the fan.
- Do not install the appliance in direct sunlight or next to a stove, heater or similar heat source.
- Energy consumption depends on installation conditions such as the ambient temperature (see 1.3 Range of appliance use) . A warmer ambient temperature can increase the energy consumption.
- Avoid opening the appliance door for any longer then necessary
- The lower the temperature is set the higher the energy consumption.
- All food stored in the appliance should be well wrapped and covered. This prevents frost buildup.
- Insertion of warm foods: first let the food cool down to room temperature.

6 Use

6.1 Controls and displays

The display provides a quick overview of the temperature setting and the status of functions and settings. You can control the functions and settings either by deactivating/activating them or by selecting a value.

6.1.1 Status display



Fig. 4

(1) Temperature display

The Status display shows the set temperatures and is the home display. From there, you can navigate to the options and settings.

6.1.2 Navigation

Navigate in the menu to access the individual functions. An audible signal sounds after confirming a function or setting. If no selection is made after 10 seconds the display switches to the Status display.

The appliance is operated with the buttons next to the display.



Fig. 5

(1) Left/right navigation arrow (2) Confirm

Left/right navigation arrow Fig. 5 (1):

- Navigating in the menu. After the last menu page, it goes back to the first one.

Confirm Fig. 5 (2):

- Activating/deactivating a function.
- Opening a submenu.
- Confirming a selection. After confirmation the display switches back to the menu.

Back to the Status display: in the fastest possible manner:

- Close and open the door.
- or wait 10 seconds. The display changes to the Status display.

6.1.3 Operating structure

The controls are explained by a template. The display changes depending on the function or settings.

Menu without submenu

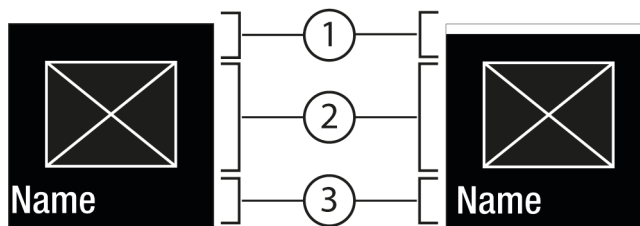

Fig. 6

(1) Status deactivated / status activated white bar in the top area (2) Symbol or selected value (3) Menu: Function name or menu: Setting name

Menu with submenu

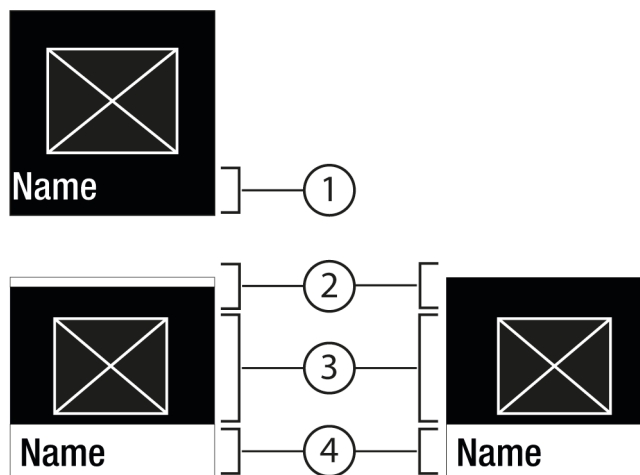

Fig. 7

(1) Menu: Function name or menu: Setting name (2) Status (3) Symbol or selected value (4) Submenu: Function name or submenu: Setting name

Use





(2) Off / On

You can navigate as follows:

- Navigate with the left/right navigation arrow *Fig. 5 (1)*.
- Press Confirm *Fig. 5 (2)* to go to the submenu *Fig. 7 (4)*.
 - Navigate with the left/right navigation arrow *Fig. 5 (1)*.
 - Set new level: Press Confirm *Fig. 5 (2)* to select a deselected value *Fig. 6 (1)*.
 - Back to menu: Press Confirm *Fig. 5 (2)* to select the selected value *Fig. 6 (2)*.

6.1.4 Display symbols





The display symbols provide information about the current appliance status.

Symbol	Appliance status
	Standby The appliance or temperature zone is turned off.
	Flashing number Appliance is working. Temperature flashes, until the set value is reached.
	Flashing symbol Appliance is working. Setting is made.
	Bar grows steadily Function is activated.

6.2 Operating logic

6.2.1 Activating/deactivating settings

You can activate/deactivate the following functions:

Symbol	Function
	SuperFrost ^x
	IceMaker and MaxIce ^{x*}
	PartyMode ^x
	E-Saver

^x When a function is on, the appliance works harder. This means the appliance could make louder noises and consume more energy.

- ▶ Press the navigation arrows *Fig. 5 (1)* until appears.
- ▶ Press Confirm *Fig. 5 (2)*.
- ▷ You hear the confirmation tone.
- ▷ Status appears in the menu.
- ▷ Function is on/off.

6.2.2 Selecting function value

With the following functions you can set a value in the submenu:

Symbol	Function
	Setting the temperature
	Switch the appliance on/off







- ▶ Press the navigation arrows *Fig. 5 (1)* repeatedly until the function is displayed.
- ▶ Press Confirm *Fig. 5 (2)*.
- ▶ Select the setting value with the navigation arrows *Fig. 5 (1)*.

Setting the temperature

- ▶ Press *Fig. 5 (2)* confirm.
- ▷ You hear the confirmation tone.
- ▷ Status: on *Fig. 6 (1)* appears briefly in the submenu *Fig. 7 (4)*.
- ▷ Display switches back to the menu.

6.2.3 Activating/deactivating settings

You can activate/deactivate the following settings:

Symbol	Setting
	WiFi ¹
	Entry lock ²
	SabbathMode ²
	Reminders ¹
	Reset ²
	Switch off ²

- ▶ Press the navigation arrows *Fig. 5 (1)* repeatedly until the settings  are displayed.
- ▶ Press Confirm *Fig. 5 (2)*.
- ▶ Press the navigation arrows *Fig. 5 (1)* repeatedly until the desired setting is displayed.

¹ Activate setting (short press)



- ▶ Press Confirm *Fig. 5 (2)*.
- ▷ You hear the confirmation tone.
- ▷ Status appears in the menu.
- ▷ Setting is activated / deactivated.

² Activate setting (long press)

- ▶ Press Confirm *Fig. 5 (2)* for 3 seconds.
- ▷ You hear the confirmation tone.
- ▷ Status appears in the menu.
- ▷ Display changes.

6.2.4 Selecting the setting value

With the following settings you can set a value in the submenu:



Symbol	Settings
	Brightness
	Door alarm
	Temp. unit



- ▶ Press the navigation arrows *Fig. 5 (1)* repeatedly until the settings  are displayed.
- ▶ Press Confirm *Fig. 5 (2)*.
- ▶ Press the navigation arrows *Fig. 5 (1)* repeatedly until the desired setting is displayed.

- ▶ Press Confirm *Fig. 5 (2)*.
- ▶ Select the setting value with the navigation arrows *Fig. 5 (1)*.
- ▶ Press Confirm *Fig. 5 (2)*.
- ▷ You hear the confirmation tone.
- ▷ Status appears briefly in the submenu.
- ▷ Display switches back to the menu.

6.2.5 Calling up the customer menu

The customer menu provides the following settings:

Symbol	Function
	TubeClean ^{2*}
	Ice cube ^{1*}
	Software

- ▶ Press the navigation arrows *Fig. 5 (1)* repeatedly until the settings  appear.
- ▶ Press Confirm *Fig. 5 (2)*.
- ▶ Press the navigation arrows *Fig. 5 (1)* repeatedly until appliance information  appears in the display.
- ▶ Press Confirm *Fig. 5 (2)*.
- ▶ Enter the numerical code 151.
- ▷ The customer menu appears.
- ▶ Press the navigation arrows *Fig. 5 (1)* repeatedly until the desired setting appears.

¹ Select the setting value

- ▶ Press Confirm *Fig. 5 (2)*.
- ▷ You hear the confirmation tone.
- ▷ Status appears briefly in the display.
- ▷ The display switches back to the menu.

² Activate setting

- ▶ Press Confirm *Fig. 5 (2)* for 3 seconds.
- ▷ You hear the confirmation tone.
- ▷ Status appears in the display.
- ▷ The symbol flashes as long as the appliance is working.

6.3 Functions

Temperature

The temperature depends on the following factors:

- the number of times the door is opened
- The duration the door is opened
- the room temperature of the installation location
- the type, temperature and amount of food

Freezer compartment	Recommended setting
	-18 °C

Setting the temperature

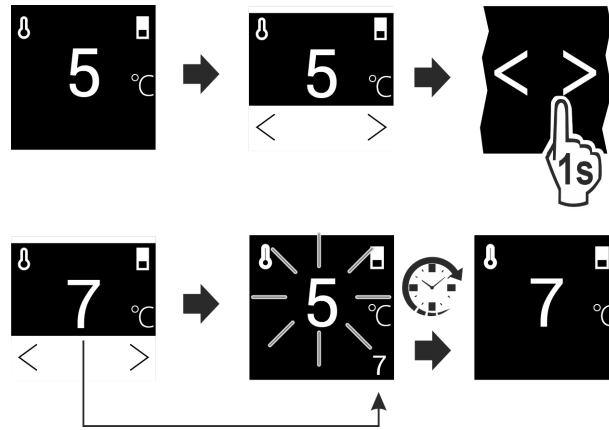

Fig. 8

- ▶ Set the value. (see 6.2 Operating logic) .
- ▷ The set temperature is shown on the bottom right of the display.

SuperFrost

Select this function for the maximum freezing setting, to reach lower freezing temperatures.

Use:

- To freeze more than 2 kg fresh food a day.
- Freezing fresh food quickly to the core.
- Increasing the cold reserves in the stored goods before defrosting the appliance.

Activating/deactivating settings

With a small volume of frozen goods:

- ▶ Activate 6 hours before use.

With the maximum volume of frozen goods:

- ▶ Activate 24 hours before use.
- ▶ Activating/deactivating (see 6.2 Operating logic) .

The function automatically turns off. The appliance goes back to normal mode. The temperature adjusts itself to the set level.

PartyMode

This option offers an assortment of special functions and settings that are useful if you are having a party.

The following functions are activated:

- *SuperFrost*
- *IceMaker* and *MaxIce**

You can set any functions you like. Your changes are lost when the option is switched off.

Activating/deactivating settings

- ▶ Activating/deactivating (see 6.2 Operating logic) .
- ▷ On: All functions are activated at the same time.
- ▷ Deactivated: Previously set temperatures are restored.

The function is automatically switched off after 24 hours.

E-Saver

This function reduces energy consumption. If you activate this function, the cooling temperature increases.

Use

Temperature zone	Recommended setting (see Temperature)	Temperature when E-Saver activated
-18 °C	-18 °C	-16 °C

Use:

- Save energy.

Activating/deactivating settings

- ▶ Activating/deactivating (see 6.2 Operating logic).
- ▷ Activated: Higher temperatures are set in all temperature zones.
- ▷ Deactivated: Previously set temperatures are restored.



IceMaker*

This function activates the production of ice cubes.*

Use:*

- Producing ice cubes

The ice cube size can be set with the **ice cube** function. (see Ice cubes*) *

You can increase the number of ice cubes produced with the **MaxIce** function. (see MaxIce*) *

The lines can be cleaned with the **TubeClean** function. (see TubeClean*) *

Activating the function*

Make sure that the following requirements are fulfilled:

- The water supply is established at the fixed water connection. See Assembly Manual.*
- IceMaker is put into operation.
- ▶ Activate the function. (see 6.2 Operating logic)
- ▷ It can take up to 24 hours for the first ice cubes to be made.

Deactivating the function*

- ▶ Deactivate the function. (see 6.2 Operating logic)
- ▷ If ice cubes are currently being made, the system completes the process. After that, the IceMaker switches off.



MaxIce*

Using the MaxIce function, ice cubes can quickly be produced at 1.5 kg of ice cubes in 24 hours.*

Use:*

- Produces many ice cubes in a short period of time.

Activate/deactivate the function*

- ▶ Activate/deactivate (see 6.2 Operating logic).

6.4 Settings



Setting up the WLAN connection

This setting connects the appliance to the internet. The connection is managed in the SmartDevice Box. You can use the SmartDevice-App to add your appliance to a SmartHome-System. Use the SmartDevice-App or other compatible partner networks to enjoy advanced options and settings.

Note

The SmartDevice Box is available from the [Liebherr Residential Appliances Store \(https://home.liebherr.com/shop/de/deu/smartdevicebox.html\)](https://home.liebherr.com/shop/de/deu/smartdevicebox.html).

More information about the availability, prerequisites and individual options can be found on the Internet at <https://smartdevice.liebherr.com/install>.

Use:

- Manage the appliance with the SmartDevice-App or a compatible partner network.
- Enjoy advanced functions and settings.
- Check the appliance status on the SmartDevice-App.

- Purchase the SmartDevice Box and insert it (see <https://smartdevice.liebherr.com/install>).
- Install the SmartDevice app (see <https://apps.home.liebherr.com/>).

Setting up the WLAN connection

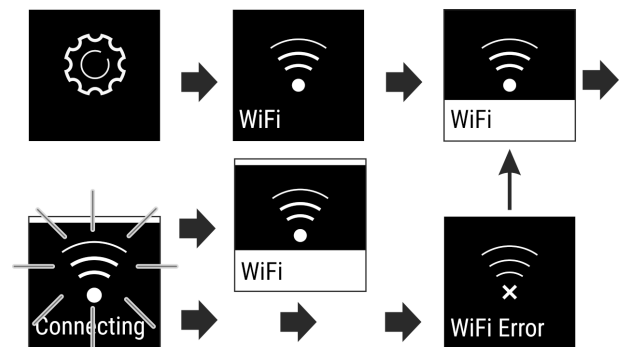

Fig. 9

- ▶ Activate (see 6.2 Operating logic).
- ▷ The connection is set up: Status: on Fig. 6 (1) and WiFi connecting appears. The symbol flashes.
- ▷ The connection is set up: Status: on Fig. 6 (1) appears.
- ▷ The connection failed: Status and Connect appears. The symbol appears permanently.

Disconnecting

- ▶ Deactivate the setting (see 6.2 Operating logic).

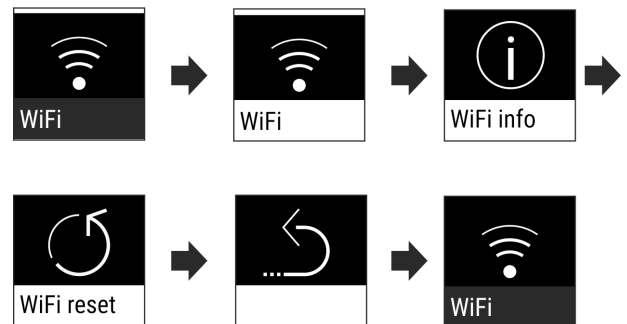



Fig. 10

- ▷ There is no connection: The symbol  is displayed constantly.

Restoring the connection

- ▶ Restore settings (see 6.2 Operating logic).

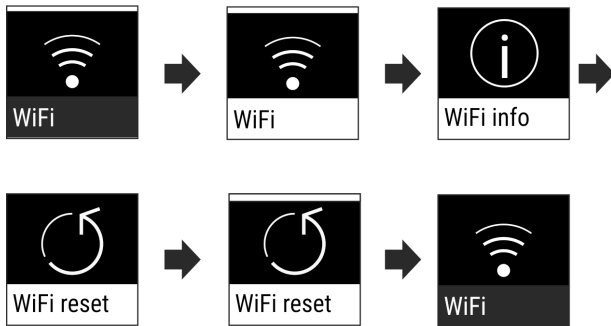

Fig. 11

- ▷ Connection and other settings are restored to factory settings.



Entry lock

This setting avoids accidental operation of the appliance, e.g. by children.

Use:

- Avoid unintentional changing of settings and functions.
- Avoid unintentional switching off of the appliance.
- Avoid unintentional temperature adjustments.

Activating/deactivating settings

- ▶ Activating/deactivating (see 6.2 Operating logic) .



Display brightness

With this setting, you can choose a brightness level for the display.

You can set the following brightness levels:

- 40%
- 60%
- 80%
- 100%

Choosing the setting

- ▶ Set the level (see 6.2 Operating logic) .



Door alarm

Set the time before the door alarm (see Close the door) sounds.

Options are as follows:

- 1 min
- 2 min
- 3 min
- Off

Choosing the setting

- ▶ Set the level (see 6.5 Error messages) .



Temperature unit

This setting allows you to change between Celsius and Fahrenheit as the temperature unit.

Selecting the setting value

- ▶ Set the value (see 6.2 Operating logic) .



Info

This setting allows the appliance information to be read out as well as access to the customer menu.

It provides the following information:

- Model name
- Index
- Serial number
- Service number

View appliance data

- ▶ Press the navigation arrows Fig. 5 (1) repeatedly until the settings  are displayed.
- ▶ Press Confirm Fig. 5 (2).
- ▶ Press the navigation arrows Fig. 5 (1) repeatedly until the information display appears.
- ▶ Read the appliance data.



SabbathMode

This setting meets the religious requirements on the Sabbath and Jewish festivals. Turn on SabbathMode to switch off certain controls. This means you can use the appliance without anyone changing any settings.

You can find a list of Star-K-certified appliances at www.star-k.org/appliances.



WARNING

Danger of food poisoning!

If there is a power outage when SabbathMode is on, this message is not saved. When the power is restored, the appliance continues in SabbathMode. Afterwards, the temperature display does not show a message about the power outage.

If there was a power outage during SabbathMode:

- ▶ Check the quality of the food. Do not consume spoiled food!

What happens on the appliance when in SabbathMode:

- The Status display permanently shows SabbathMode.
- The display is locked for all functions apart from turning off SabbathMode.
- Any functions/settings that are already on, remain active.
- The display stays bright when the door is closed.
- Reminders are disabled. The set timer interval is also stopped. The function is no longer executed in SabbathMode.
- Reminders and warnings are not displayed. No acoustic signals are emitted and the display does not show warnings / settings such as temperature alarm or door alarm.
- IceMaker is out of use.*
- The defrost cycle only works for the specified time without taking account of fridge use.
- After a power cut the appliance automatically returns to SabbathMode.

Activating/deactivating SabbathMode

- ▶ To activate this function, click the arrows next to the display until you see the Settings  menu item and then confirm. The menu shows the available settings.
- ▶ Click the arrows next to the display until you see the SabbathMode (Menora) symbol. Confirm the symbol.
- ▷ A white bar appears in the top part of the display.
- ▷ SabbathMode has been activated.

Use

To deactivate this function, press the confirmation button next to the display for 3 seconds.

SabbathMode has been deactivated.



TubeClean*

This setting cleans the IceMaker pipes.*

Make sure that the following requirements are met:*

- IceMaker cleaning process is ready (see 8.2.6 Cleaning the IceMaker*).

Activate setting*

- ▶ Activate the setting in the customer menu (see 6.2 Operating logic).
- ▷ TubeClean is prepared (max. 60 min.): The symbol flashes.
- ▷ Water pipes are rinsed: Symbol flashes.
- ▷ Rinsing process is complete: Function turns off automatically.



Ice cubes*

With this setting, you can choose the ice cube size.*

Choosing the setting*

- ▶ Make your settings in the Customer menu (see 6.2 Operating logic).



Reminder

Reminders are displayed acoustically by a beep and visually by a symbol in the display. The signal gets louder until the alert stops.

Activate setting

- ▶ Activating/deactivating (see 6.2 Operating logic).



Reset

This function resets all settings to the factory settings. All settings that you have made thus far will be reset to their original values.

Activate the setting

- ▶ Activating (see 6.2 Operating logic).



Turn off appliance

This setting turns off the whole appliance.

Switch off whole appliance

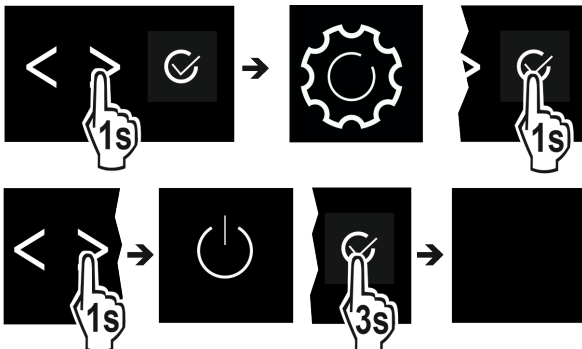

Fig. 12

- ▶ Turning off the IceMaker.*

- ▶ Activating/deactivating (see 6.2 Operating logic).
- ▷ Off: Display turns black.

6.5 Error messages

Error messages appear in the display. There are two categories of error message:

Category	Meaning
Message	Reminder of general procedures. You can carry out these procedures to eliminate the message.
Warning	Appears when there are malfunctions. A signal sounds in addition to the display. The signal becomes louder until you acknowledge by tapping the display. You can eliminate simple defects yourself. For more serious defects, you must contact customer service.

6.5.1 Warnings



Close the door

This message appears if the door is open too long.

You can set the time before this message appears.

- ▶ Stop alarm: Confirm the message.

-or-

- ▶ Close the door.



Power failure.

This message appears if the freezer temperature rises after a power outage. When the power outage is over, the appliance will continue to operate at the last temperature setting.

- ▶ Stop alarm: Confirm the message.

- ▷ Temperature alarm appears (see Temperature alarm).



Temperature alarm

This message appears if the temperature does not match the set temperature.

Temperature differences may be caused by:

- Hot fresh food was placed in the appliance.
- When sorting and removing food from the appliance, too much warm ambient air got in.
- There has been a prolonged power outage.
- The appliance is faulty.

When the cause is eliminated, the appliance will continue to operate at the last temperature setting.

- ▶ Confirm the display.

- ▷ Warmest temperature is displayed.

- ▶ Confirm the display again.

- ▷ The status display is displayed.

- ▷ Current temperature is displayed.



Error

This message appears when there is a fault with the appliance. An appliance component has an error.

- ▶ Open the door.

- ▶ Take note of the error code.

- ▶ Confirm the message.

- ▷ The signal tone stops.

- ▷ The status display appears.

- ▶ Close the door.

- ▶ Contact customer service. (see 9.4 Customer service)

6.5.2 Message



Insert IceMaker drawer*

This message appears if the IceMaker drawer is open.

- ▶ Push in the IceMaker drawer.
- ▷ The message disappears.
- ▷ The IceMaker produces ice cubes.

6.5.3 DemoMode

If "D" appears in the display, demo mode is on. This feature is designed for retailers. The cooling features are disabled.

Switching off DemoMode

When you see a time counting down:

- ▶ Confirm within the countdown.
- ▷ DemoMode is off.

If there is no countdown:

- ▶ Disconnect the power plug.
- ▶ Reconnect the power plug.
- ▷ DemoMode is off.

7 Equipment

7.1 Drawers

You can remove the drawers for cleaning.

How the drawers are removed and inserted differs depending on the pull-out system. Your appliance can include a variety of pull-out systems.

Note

Insufficient ventilation results in an increase in energy consumption and reduction of the refrigerating performance.

- ▶ Leave the bottom drawer in appliance!
- ▶ Never obstruct the vents on the interior rear wall!

7.1.1 Remove the drawer

Drawer on molded ribs

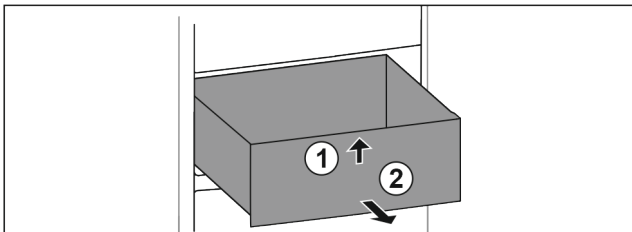

Fig. 13

- ▶ Pull drawer out completely.
- ▶ Lift at the front Fig. 13 (1).
- ▶ Remove to the front Fig. 13 (2).

Tilting top drawer*

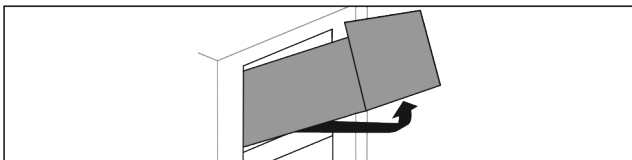

Fig. 14

- ▶ Pull drawer out completely.
- ▶ Lift at the front.
- ▶ Lift from below.
- ▶ Remove to the front.

7.1.2 Inserting the drawer

Drawer on molded ribs

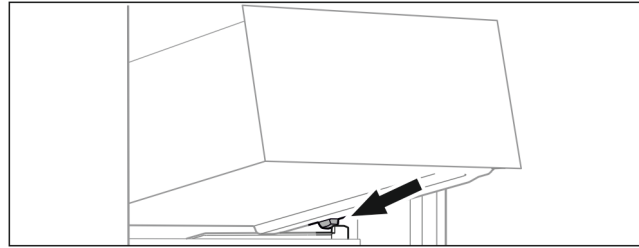

Fig. 15

- ▶ Place drawer on the molded ribs behind the stoppers with the drawer tilted up at the front Fig. 15 (1).
- ▶ Lower drawer.
- ▶ Slide to the rear.

Tilting top drawer*

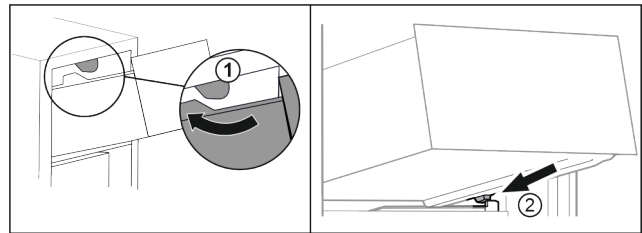

Fig. 16

- ▶ Guide the drawer around the upper stoppers Fig. 16 (1).
- ▶ Place the drawer on the molded ribs behind the lower stoppers with the drawer tilted up at the front Fig. 16 (2).
- ▶ Lower drawer.
- ▶ Slide to the rear.

7.2 Pull-out board with IceTower*

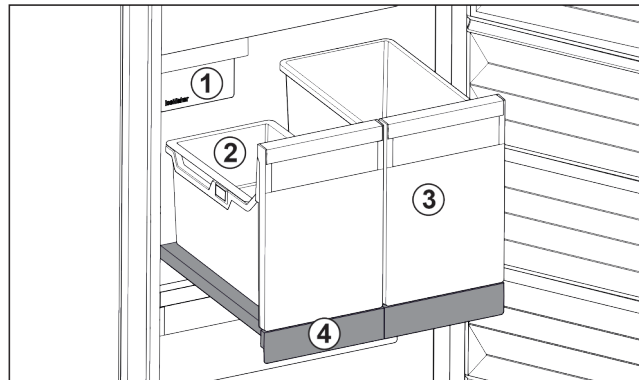

Fig. 17 Pull-out board with IceTower

- | | |
|--------------------------------|---|
| (1) IceMaker | (3) Container for pizza or alcoholic beverages, for example |
| (2) Hang-on tray for ice cubes | (4) Pull-out board |

On the pull-out board are two tall containers (IceTower). Ice cubes from the IceMaker are collected and stored in the container Fig. 17 (2). The container Fig. 17 (3) is suitable for storing tall foodstuffs or beverages such as pizzas or alcoholic drinks.

The pull-out board with IceTower is mounted on a glass shelf with pull-out rails. You can dismantle the pull-out board for cleaning.

Equipment

7.2.1 Dismantling the pull-out board with IceTower

Removing the container

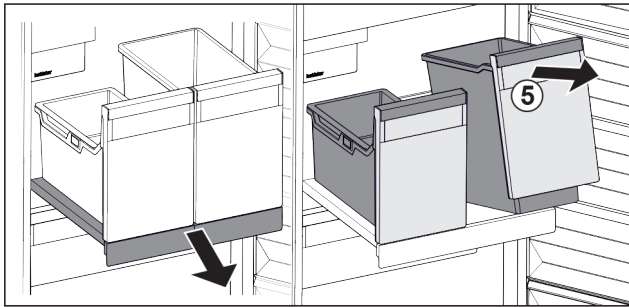

Fig. 18

- ▶ Remove the pull-out board.
- ▶ Lift the container Fig. 18 (5) at the front.
- ▶ Remove the container.

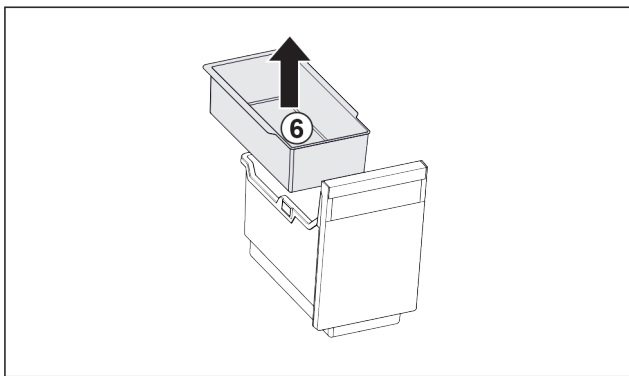

Fig. 19

- ▶ Remove the hang-on tray Fig. 19 (6).
- ▶ If there are ice cubes in the hang-on tray: Empty the hang-on tray.
- ▷ The container and hang-on tray have been removed and you can clean them. (see 8.2.4 Cleaning the equipment)

Removing the pull-out board

Make sure that the following requirements are fulfilled:

- Containers have been removed. (see 7.2.1.1 Removing the container)

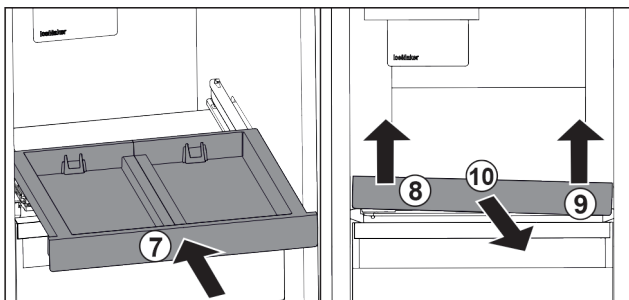

Fig. 20

- ▶ Slide in the pull-out board. Fig. 20 (7)
- ▶ Lift the pull-out board at the front left. Fig. 20 (8)
- ▶ Lift the pull-out board at the front right. Fig. 20 (9)
- ▷ The pull-out board is detached from the attachment at the front.
- ▶ Take out the pull-out board to the front. Fig. 20 (10)
- ▷ The pull-out board has been removed and you can clean it. (see 8.2.4 Cleaning the equipment)

7.2.2 Inserting the pull-out board with IceTower

Inserting the pull-out board

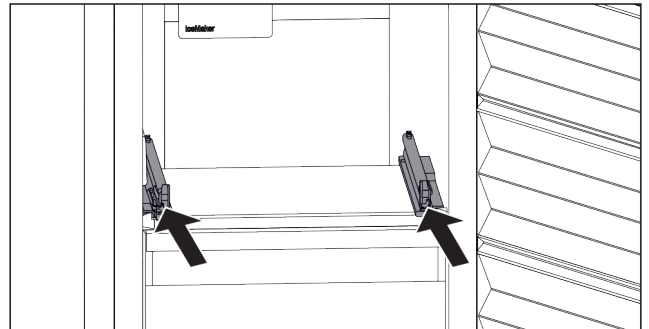

Fig. 21

- ▶ Slide the rails in.

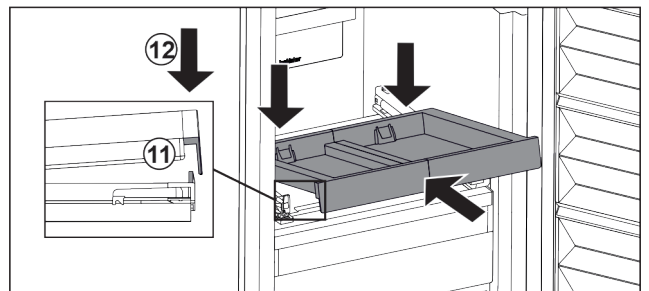

Fig. 22

- ▶ Place the pull-out board in at an angle behind the front lug.
- ▶ Slide it in at an angle. Make sure that the stop is behind the lug on both sides. Fig. 22 (11)
- ▶ Lower the pull-out board at the front. Fig. 22 (12)

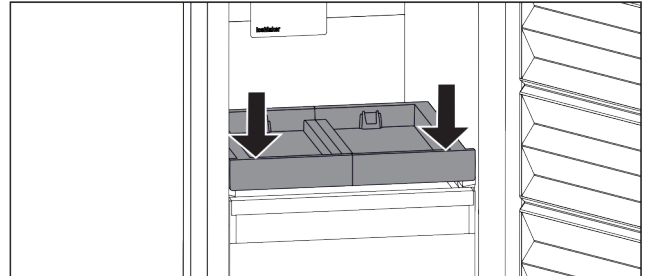

Fig. 23

- ▶ Push the pull-out board down at the front.
- ▷ The pull-out board clicks into place.

Inserting the container

Make sure that the following requirements are fulfilled:

- The pull-out board is inserted. (see 7.2.2.1 Inserting the pull-out board)

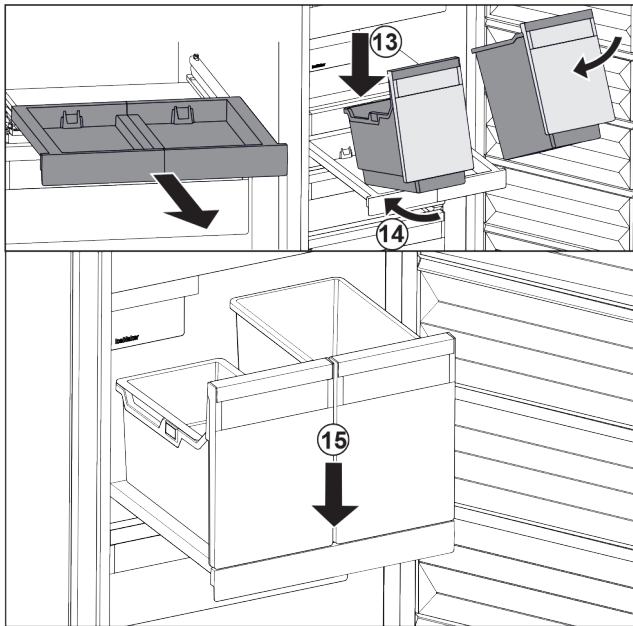

Fig. 24

- ▶ Remove the pull-out board.
- ▶ Hold the pull-out board with one hand.

Note

The containers are shaped in a way that they cannot be interchanged.

- ▶ Place the container at an angle on the pull-out board. Fig. 24 (13)
- ▶ Slide in the container at an angle to the back. Fig. 24 (14)
- ▶ Place container at the front. Fig. 24 (15)

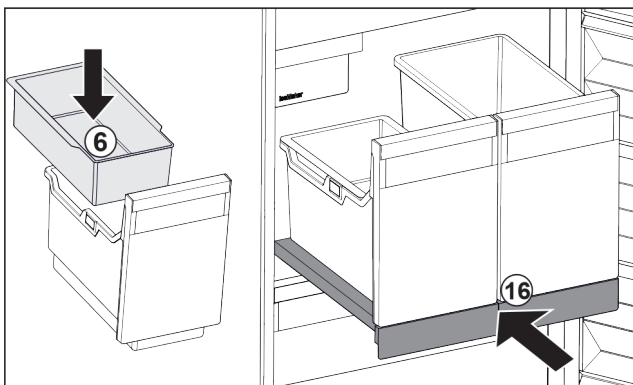

Fig. 25

- ▶ Insert hang-on tray Fig. 25 (6) for ice cubes.
- ▶ Slide in the pull-out board with container (IceTower). Fig. 25 (16)
- ▷ Pull-out board with IceTower is fully inserted.

EasyTwist-Ice

The EasyTwist-Ice produces ice cubes when the water tank is inserted.

The EasyTwist-Ice is used exclusively for the production of ice cubes in standard household quantities.

Note

Do not change the position of the EasyTwist-Ice.

Make sure that the following conditions are met:*

- The EasyTwist-Ice has been cleaned (see 8.2.5 Cleaning the EasyTwist-Ice*)
- The water tank has been cleaned.
- The EasyTwist-Ice drawer is fully inserted.

7.3.1 Filling the water tank



WARNING

Contaminated water!
Poisoning.

- ▶ Fill with potable water only.

NOTICE

Sugary liquids!
Damage to the EasyTwist-Ice.

- ▶ Fill with cold drinking water only.

Note

Using filtered, decarbonized water ensures the best-tasting drinking water for your ice cubes.

This water quality can be achieved using a table water filter of the kind available in trade retail outlets.

- ▶ Always fill the water tank only with filtered, decarbonized drinking water.

The water for the EasyTwist-Ice is supplied from a water tank.

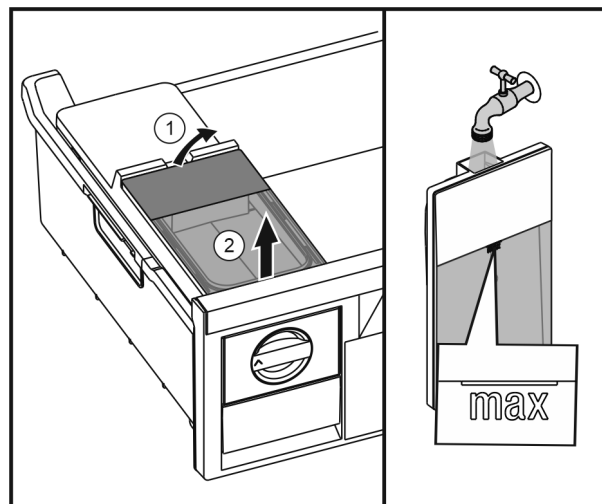

Fig. 26

- ▶ Lift up the water tank at the rear Fig. 26 (1) and take it out upwards Fig. 26 (2).
- ▶ Fill with drinking water up to the mark.
- ▶ Insert the water tank by reversing the steps described above.

7.3.2 Producing ice cubes

The production capacity depends on the freezer temperature. The lower the temperature, the more ice cubes that can be produced in a certain period.

Maximum capacity of the ice cube drawer – 40 cubes (2x ice cube production).

Time required for ice cube production – at least 5 hours.

Releasing the ice cubes

- ▶ Turn the knob to the right to its stop limit.
- ▶ If necessary, repeat several times and turn the knob a little more.

IceMaker

The IceMaker is used exclusively for the production of ice cubes in household quantities.

Make sure that the following conditions are fulfilled*

- IceMaker is cleaned (see 8 Maintenance) .
- IceMaker drawer is fully inserted.

Maintenance

7.4.1 Producing ice cubes

The production capacity depends on the freezer temperature. The lower the temperature, the more ice cubes can be produced in a certain period.

Once IceMaker is switched on for the first time, it can take up to 24 hours to produce the first ice cubes.

- ▶ Activate the IceMaker (see 6.2 Operating logic).
- ▶ To make a large quantity of ice cubes: Activate the MaxIce (see 6.2 Operating logic).
- ▶ Distribute ice cubes evenly in the drawer to increase its capacity.
- ▶ Close the drawer: The IceMaker starts making ice again.

Note

When a certain level is reached in the IceMaker drawer, it stops making ice cubes. The IceMaker does not fill the drawer to the very top.

7.5 VarioSpace

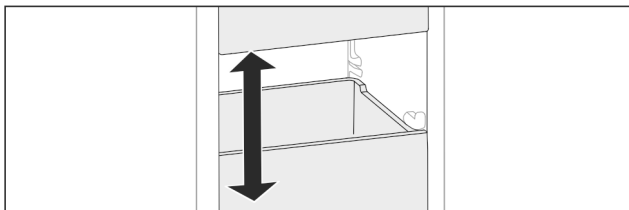

Fig. 27

You can remove drawers and glass panels from your appliance. This provides more room for large food items such as poultry, joints of meat, large game and bulky baked goods. You can then freeze these items whole for later preparation.

- ▶ Note the load limits on the drawers and glass panels (see 9.1 Technical specifications).

7.6 Accessories

7.6.1 Freezer packs*

The freezer packs prevent the temperature from rising too fast in the event of a power failure.

The freezer packs are in the drawer.

You can store the cold storage accumulators in the freezer tray.*

Using the freezer packs

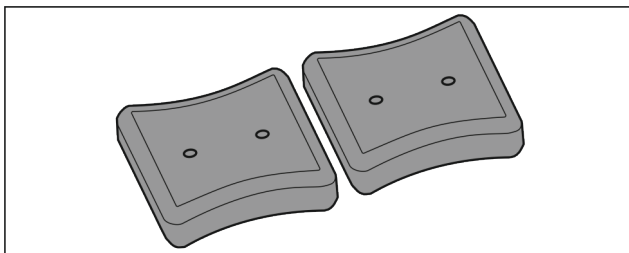

Fig. 28

When the freezer packs are fully frozen:

- ▶ Place on the frozen goods in the top, front part of the freezer.

8 Maintenance

8.1 Defrosting the appliance

8.1.1 Defrosting with NoFrost

Defrosting is performed automatically by the NoFrost system. The moisture condenses on the evaporator and is periodically defrosted and evaporated.

The appliance does not have to be defrosted.

Note

Water droplets may collect on the bottom of the appliance.

When you decommission the appliance:

- ▶ Place a towel in front of the appliance to catch any water that may run out. (see 10 Decommissioning)

8.2 Cleaning the appliance

8.2.1 Preparation



WARNING

Danger of electric shock.

- ▶ Unplug refrigerator or disconnect power.



WARNING

Danger of fire

- ▶ Do not damage the refrigerant circuit.

- ▶ Empty appliance.

- ▶ Pull out the power plug.

8.2.2 Cleaning the housing

NOTICE

Improper cleaning!

Damage to the appliance.

- ▶ Only use soft cleaning cloths and ph-neutral all-purpose cleaners.

- ▶ Do not use steel wool or sponges that scour or scratch.

- ▶ Do not use caustic or abrasive cleaning materials or those containing sand, chloride, or acids.



WARNING

Risk of injury or damage due to hot steam.

Hot steam can cause scalding/burns and damage to surfaces.

- ▶ Do not use steam cleaners.

- ▶ Wipe the housing down with soft, clean cloth. If very dirty, use lukewarm water with a neutral cleaner. Glass surfaces can also be cleaned with glass cleaner.

8.2.3 Cleaning the interior

NOTICE

Improper cleaning!

Damage to the appliance.

- ▶ Only use soft cleaning cloths and ph-neutral all-purpose cleaners.

- ▶ Do not use steel wool or sponges that scour or scratch.

- ▶ Do not use caustic or abrasive cleaning materials or those containing sand, chloride, or acids.

- ▶ Plastic surfaces: clean by hand with a soft clean cloth, lukewarm water and a little detergent.

- ▶ Metal surfaces: clean by hand with a soft clean cloth, lukewarm water and a little detergent.

- ▶ Press the lug *Fig. 30 (1)*, lift up the EasyTwist-Ice at the back and take it out of the freezer drawer.

8.2.4 Cleaning the equipment

NOTICE

Improper cleaning!
Damage to the appliance.

- ▶ Only use soft cleaning cloths and ph-neutral all-purpose cleaners.
- ▶ Do not use steel wool or sponges that scour or scratch.
- ▶ Do not use caustic or abrasive cleaning materials or those containing sand, chloride, or acids.

Clean with a soft, clean cloth, lukewarm water and a little washing up liquid:

- IceTower pull-out board*
- Drawer
Please note: Do not remove the magnet on the drawer. The magnet ensures that the IceMaker functions.*
- Freezer tray*

Clean in the dishwasher up to 60 °C:

- Ice cube tray*
- Ice cube scoop*
- ▶ Disassemble the equipment: see the relevant section.
- ▶ Clean the equipment.

8.2.5 Cleaning the EasyTwist-Ice*

Cleaning must be conducted in the following situations:

- Operating for the first time
- Non-use for longer than 48 hours
- When the appliance requires cleaning

When operating for the first time, longer periods of disuse and when the appliance requires cleaning

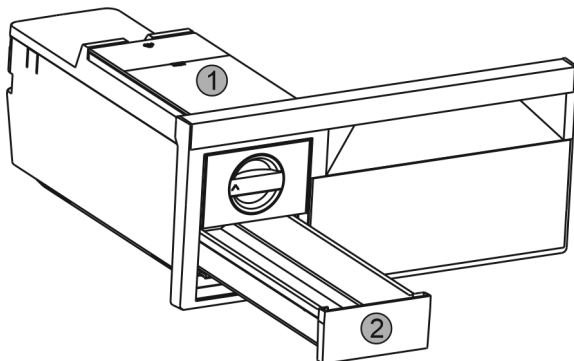

Fig. 29

- ▶ Take out the water tank *Fig. 29 (1)* and ice cube drawer *Fig. 29 (2)*.
- ▶ Take out the freezer drawer with EasyTwist-Ice.

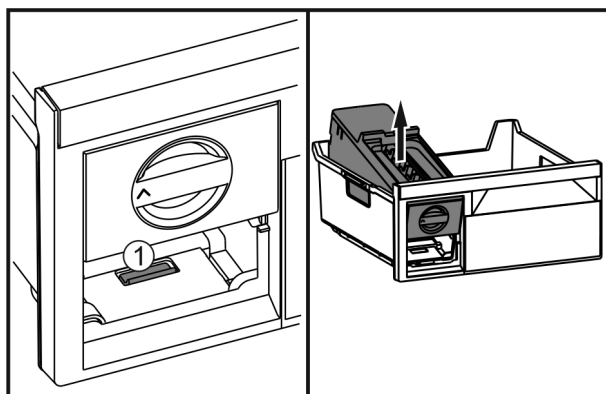

Fig. 30

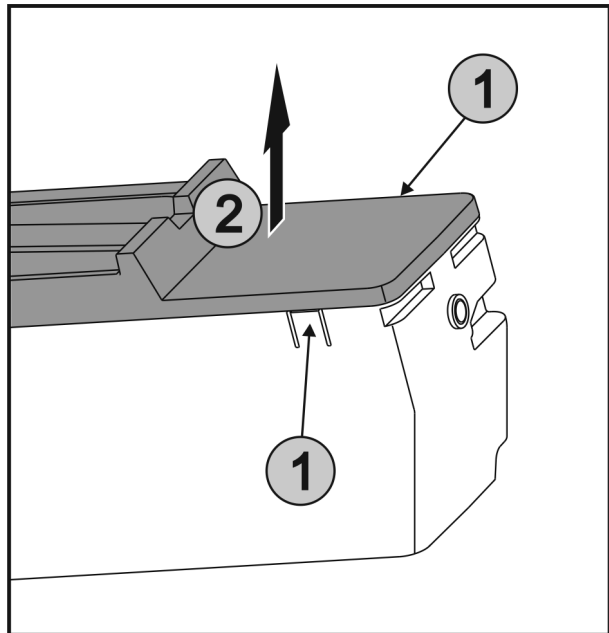

Fig. 31

- ▶ Press the lugs *Fig. 31 (1)* on both sides of the EasyTwist-Ice simultaneously and take off the cover *Fig. 31 (2)* upwards.

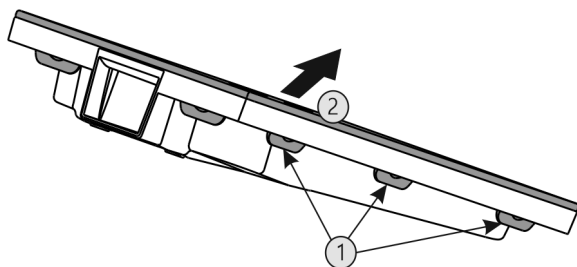

Fig. 32

- ▶ Press all lugs *Fig. 32 (1)* one after another and remove the cover *Fig. 32 (2)*.
- ▶ Clean the Ice cube drawer, water tank and EasyTwist-Ice with water and a little detergent.
- ▶ Assemble the EasyTwist-Ice.

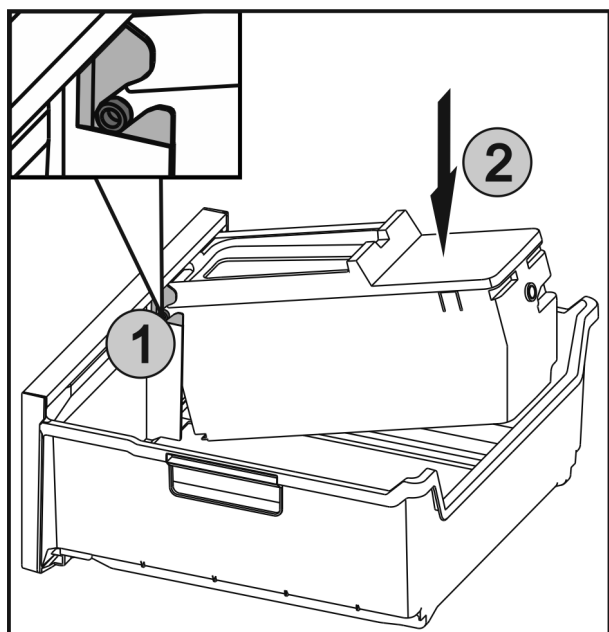

Fig. 33

Customer support

- ▶ Insert the axles *Fig. 33 (1)* on the EasyTwist-Ice in the guides and push the rear side *Fig. 33 (2)* until the lug engages.
- ▶ Push in the EasyTwist-Ice drawer.



WARNING

Contaminated water!
Poisoning.

- ▶ Fill with potable water only.

- ▶ Fill the water tank and insert it. (see 7.3.1 Filling the water tank)

With unfiltered water:

- ▶ Dispose of ice cubes that were produced within 24 hours of the first ice cube production.

With filtered water:

- ▶ Dispose of ice cubes that were produced within 48 hours of the first ice cube production.

8.2.6 Cleaning the IceMaker*

There are various options for cleaning the IceMaker.

We recommend cleaning in the following situations:

- Initial commissioning
- If out of use for longer than 5 days.*

Make sure that the following requirements are met:

- IceMaker drawer is emptied.
- IceMaker drawer is fully inserted.
- The IceMaker has been activated. (see 6.2 Operating logic)

On first use or if not used for prolonged periods

Clean the IceMaker with TubeClean.

- ▶ Place a 1.5 l empty container (max. height 10 cm) in the drawer under the IceMaker.
- ▶ Activate the TubeClean function. (see 6.2 Operating logic)
- ▷ The rinse process is prepared (max. 60 min.): The symbol flashes.
- ▷ Water pipes are rinsed: Symbol flashes.
- ▷ Rinsing process is complete: Function turns off automatically.
- ▶ Take out the IceMaker drawer and remove the container.
- ▶ Clean the IceMaker drawer with warm water and a little detergent.
- ▶ Push in the IceMaker drawer.
- ▷ Ice cube production starts automatically.
- ▶ Dispose of any ice cubes that are produced within 24 hours of the first ice cube production.

When cleaning is required

Clean the IceMaker manually.

- ▶ Remove the IceMaker drawer and clean with warm water and a little detergent.
- ▶ Push in the IceMaker drawer.
- ▷ Ice cube production starts automatically.

8.2.7 After cleaning

- ▶ Wipe dry the appliance and items of equipment
- ▶ Connect and switch on the appliance.
- ▶ Activate SuperFrost (see 6.3 Functions) . When the temperature is sufficiently cold
- ▶ Place the food inside.
- ▶ Repeat cleaning regularly.

9 Customer support

9.1 Technical specifications

Temperature zone	
Freezing	-28 °C to -15 °C

Maximum freezing capacity / 24 hrs	
Freezer	See nameplate, "Freezing capacity ... / 24h"

Max. equipment capacity			
Equipment	Appliance width 550 mm (see installation instructions, appliance dimensions)	Appliance width 600 mm (see installation instructions, appliance dimensions)	Appliance width 700 mm (see installation instructions, appliance dimensions)
Drawer on molded rib	14 kg	19 kg	25 kg
Bottom drawer	--	11 kg	19 kg
Top tilting drawer*	--*	19 kg*	19 kg*

Ice cube production with IceMaker*	
Ice cube production / 24 h	At a temperature of -18 °C: 0.8 kg of ice cubes
Maximum ice cube production / 24 h	When the MaxIce function is active: 1.2 kg of ice cubes

Ice cube production with EasyTwist-Ice*	
Time required at -18 °C	approx. 5.5 h
Time required with SuperFrost activated	approx. 3 h

9.2 Operating noises

The appliance makes noises while in operation.

- At **less cooling output** the appliance saves energy but takes longer to cool items. The volume is **lower**.
- At a **higher cooling output** the food cools more quickly. The volume is **higher**.

Examples:

- Activated functions (see 6.3 Functions)
- Running fan
- Freshly sorted food
- High ambient temperature
- Door opened for long periods

Noise	Possible cause	Type of noise
Bubbling and splashing	Coolant is flowing into the cooling circuit.	Normal noise
Spitting and hissing	Coolant is spraying into the cooling circuit.	Normal noise

Noise	Possible cause	Type of noise
Humming	The appliance cools. The volume depends on the cooling output.	Normal noise
Whirring and murmuring	The fan is running.	Normal operating noise
Clicking	Components are being switched on and off.	Normal switching noise
Rattling or humming	Valves are active.	Normal switching noise

Noise	Possible cause	Type of noise	How to resolve
Vibration	Unsuitable setup	Error noise	Adjust the feet to make sure the appliance is horizontal.

Noise	Possible cause	Type of noise	How to resolve
Clattering	Equipment, Objects inside the appliance	Error noise	Secure equipment parts. Leave a gap between items.

9.3 Technical faults

Your appliance is designed and manufactured for reliable operation and a long service life. If a malfunction nonetheless occurs during operation, please check whether the malfunction is due to an operating error. In this case, you will have to be charged for the costs incurred, even during the warranty period.

You may be able to rectify the following faults yourself.

9.3.1 Appliance function

Defect	Cause	Remedy
The appliance does not work.	→ The appliance is not switched on.	▶ Switch on the appliance.
	→ The power plug is not properly inserted in the wall socket.	▶ Check the power plug.
	→ The powerfuse in the wall socket is not OK.	▶ Check the fuse.
	→ Power failure.	▶ Keep the appliance closed. ▶ Protect your food: Lay freezer packs on top of the food or use another freezer if the power is off for a prolonged period. ▶ Do not re-freeze defrosted food.
	→ The appliance connector is not correctly inserted in the appliance.	▶ Check the appliance connector.
The temperature is not cold enough	→ This means that the door of the appliance is not closed properly	▶ Close the appliance door
	→ Insufficient ventilation	▶ Clear and clean the ventilation grille.
	→ The ambient temperature is too high	▶ Solution: (see 1.3 Range of appliance use) .
	→ The appliance was opened too frequently or for too long	▶ Wait to see whether the required temperature resets itself by itself. If not, contact Customer Service (see 9.4 Customer service) .
	→ Too much fresh food was placed inside without SuperFrost.	▶ Solution: (see SuperFrost)
	→ The temperature is incorrectly set	▶ Set to a colder temperature and check after 24 hours.
→ The appliance is too near to a heat source (stove, heater etc).	▶ Change location of appliance or the heat source.	
The door seal is defective or should be replaced for other reasons.	→ The door seal is interchangeable. You can replace it without the use of any special tools.	▶ Contact Customer Service (see 9.4 Customer service) .
The appliance is iced up or condensation is building.	→ The door seal may have slipped out of its groove.	▶ Check the door seal is well placed in the groove.

Decommissioning

Defect	Cause	Remedy
The outside surfaces of the appliance are hot*.	→ The heat of the refrigerant circuit is used to prevent condensate from forming	▶ This is normal.

9.3.2 Equipment

Defect	Cause	Remedy
The IceMaker cannot be switched on.*	→ The appliance and therefore the IceMaker are not connected.	▶ Connect the appliance (see Installation Guide).
The IceMaker is not making any ice cubes.*	→ The IceMaker is not switched on.	▶ Activate the IceMaker.
	→ The drawer of the IceMaker is not properly closed	▶ Close the drawer properly
	→ The water connection is not open	▶ Open the water connection*

9.4 Customer service

First check if you can fix the error yourself (see 9 Customer support) . If this is not the case, please contact customer service.

Please refer to the enclosed "Liebherr Service" brochure for the address.



WARNING

Unprofessional repair!
Injuries.

- ▶ Repairs and work on the appliance and the power supply cable not described in the Manual (see 8 Maintenance) should only be carried out by a qualified service provider.
- ▶ A damaged power cable may only be replaced by the manufacturer, the manufacturer's Customer Service or a similarly qualified person.
- ▶ For appliances with an IEC connector, the change can be made by the customer.

9.4.1 Contact Customer Service

Make sure to have the following appliance information to hand:

- Appliance name (model and index)
- Service no. (service)
- Serial no. (S no.)

▶ Showing appliance info on the display (see Info) .

-or-

▶ Referring to appliance info on the nameplate (see 9.5 Rating plate) .

- ▶ Take note of the appliance information.
- ▶ Inform Customer Service: Tell us the problem and the appliance details.
- ▷ This will help us give you fast and accurate support.
- ▶ Further instructions from customer service will follow.

9.5 Rating plate

The nameplate is located behind the drawers on the inside of the appliance.

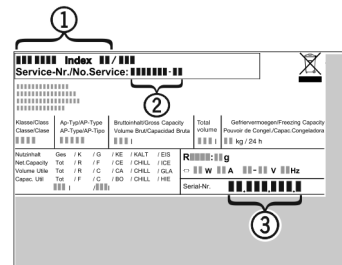

Fig. 34

- (1) Appliance name
- (2) Service no.
- (3) Serial no.

▶ Information from the nameplate.

10 Decommissioning

- ▶ Empty appliance.
- ▶ Switch off the IceMaker .*
- ▶ Switch off the appliance (see 6.4 Settings) .
- ▶ Pull out the power plug.
- ▶ Remove the appliance connector if necessary: Pull it out and, at the same time, move it from the left to the right.
- ▶ Place a towel in front of the appliance to catch any water that may run out.
- ▶ Clean the appliance (see 8.2 Cleaning the appliance) .
- ▶ Leave the door open to prevent bad smells

11 Disposal

11.1 Preparing appliance for disposal



Liebherr uses batteries in some of its appliances. In the EU, for environmental reasons, legislation obliges the end user to remove these batteries before disposing of the old appliances. If your appliance contains batteries, a corresponding notice is attached to the appliance.

Lamps If you can remove the lamps yourself without destroying them, also remove these before disposal.

- ▶ Take the appliance out of operation.
- ▶ Appliance with batteries: Remove the batteries. For description, see Maintenance chapter.

- ▶ If possible: Remove lamps without destroying them.

11.2 Disposing of the appliance in an environmentally friendly manner



The appliance still contains valuable materials and must be collected separately from unsorted municipal waste so it can be recycled.



Li-Ion



Li-Ion

Dispose of batteries separately from the old appliance. You can do this by returning the batteries free of charge to retailers or taking them to recycling centers and collection centers for recyclable materials.

Lamps

Dispose of removed lamps via the respective collection systems.

For Germany:

You can dispose of the appliance free of charge via the class 1 collection containers at the local recycling and recyclable material collection centers. When purchasing a new fridge/freezer, if the sales area > 400 m², retailers will also take back the old appliance free of charge.



WARNING

Leaking refrigerant and oil!

Fire. The refrigerant contained within the appliance is environmentally friendly, but flammable. The oil contained within the appliance is flammable. Escaping refrigerant and oil can ignite if they are of high enough concentration and are exposed to an external heat source.

- ▶ Do not damage the pipelines of the coolant circuit and the compressor.
- ▶ Transport the appliance away without damaging it.
- ▶ Dispose of batteries, lamps, and the appliance according to the above specifications.



home.liebherr.com/fridge-manuals

EN Freezer

Issue date: 20220707

Part number index: 7088347-00

Liebherr-Hausgeräte Ochsenhausen GmbH
Memminger Straße 77-79
88416 Ochsenhausen
Deutschland