



Questo manuale d'istruzione è fornito da trovaprezzi.it. Scopri tutte le offerte per [MOZA AB9 FFB Base AS001](#) o cerca il tuo prodotto tra le [migliori offerte di Accessori Gaming](#)

MOZA
FLIGHT



Quick Guide



售后客服

AB9 Force Feedback Base



01 Product Introduction

- MCLS Force Feedback Algorithm
- 12N·m Peak Torque
- Dual Servo Motors
- Aviation-Grade Aluminum Alloy Body
- High-resolution Encoder
- Compatible with Leading Flight Sim Games
- Quiet and Seamless Design
- MOZA Cockpit Control Software

02 Base Connection Ports

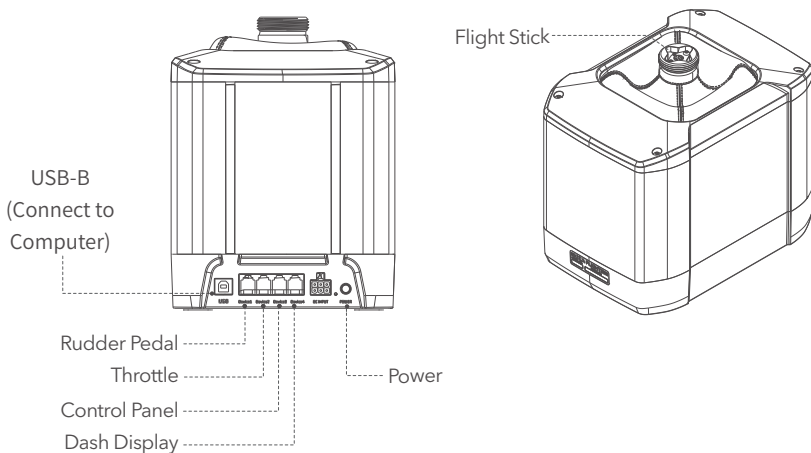

03 Parameters

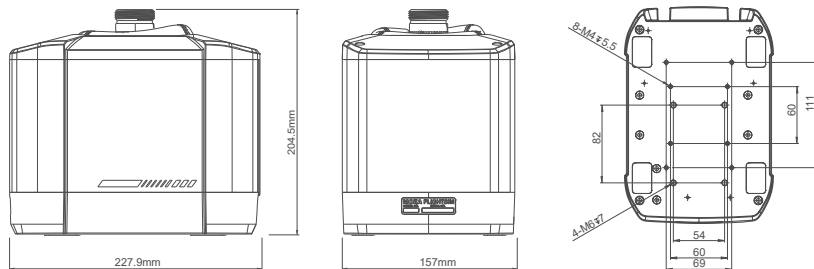

04 Installation Guide

Installing the Flight Stick

1. Connect the flight stick to the base aviation connector in the direction indicated by the forward facing arrow (refer to diagram1).
2. Rotate the nut ring on the flight stick clockwise to tighten (refer to diagram2).
3. Use the provided wrench to further tighten until the flight stick is securely connected to the base (refer to diagram3).

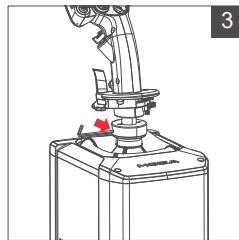
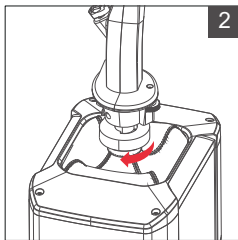
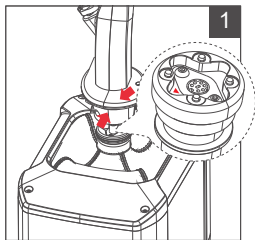

Mounting the Base

1. Desktop Clamp Mode (Desk clamp requires separate purchase):
 - a. Secure the MOZA AB9 base to the desktop clamp using 4-6 screws at the bottom.
 - b. Place the desktop clamp on the desk and tighten the star-shaped handle until the clamp is securely attached to the desk.
2. Desktop Clamp Hanging Mode (Desk clamp requires separate purchase):
 - a. Adjust the height as desired, then secure the desktop clamp's 4 screws onto the nuts on the AB9's side groove.
 - b. Tighten the star-shaped handle of the desktop clamp until it is secure.
3. Alternative Installation Methods:

The base can also be secured to some pre-made simulator brackets using the screw hole spacing at the bottom.

Using the Product

1. Connect the power cable and USB Type-B cable to their respective ports at the back of the AB9 Force Feedback Base. Plug the power cable into a 220V outlet. Press the switch briefly to power on (short press for on, long press for off). A quick flashing of the power indicator confirms successful power connection.
2. Connect the USB Type-A end to your PC. Once connected, the power indicator will remain lit. Visit www.mozaracing.com to download and install the MOZA software from the help center to begin your flight experience. For additional information and tutorial videos, please visit the official website.

05 Software Introduction

The main page displays the status of connected devices, including the base, flight stick, throttle, and rudder pedals.

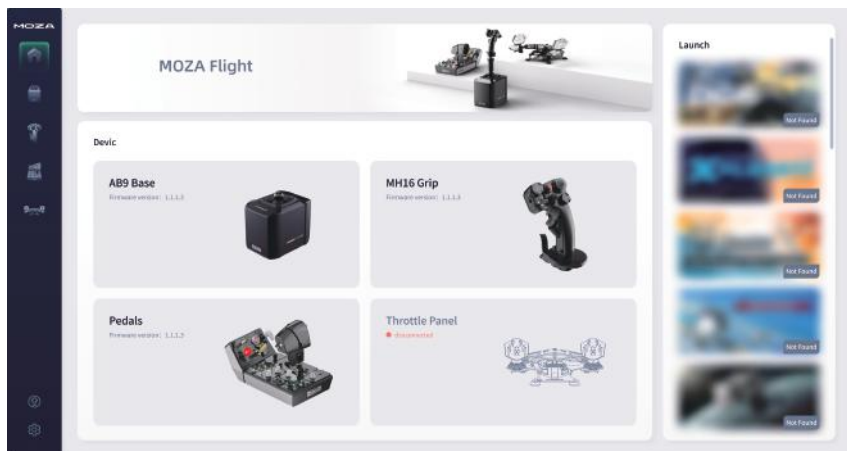

Basic Settings: Easily access game settings and choose preset force feedback modes, ideal for beginner players to quickly get setup and flying. Real-time monitoring of the flight stick's coordinate position is also available.

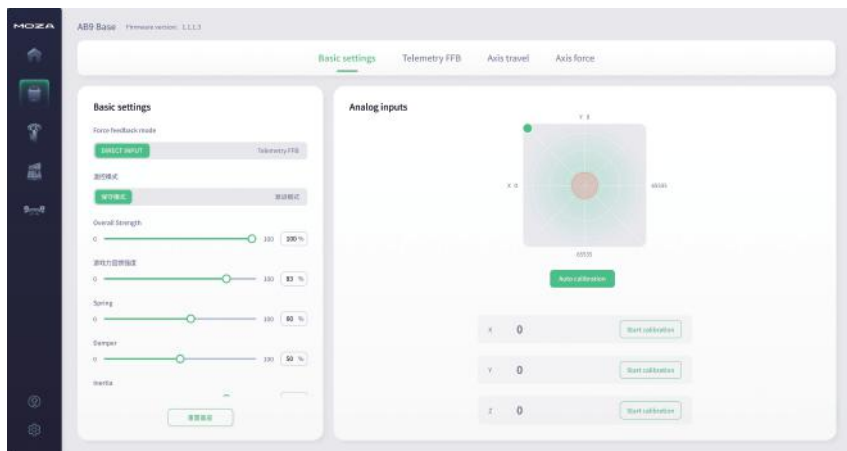

Axis Range Settings: Adjust the sensitivity and dead zone of individual motors to match personal preferences.

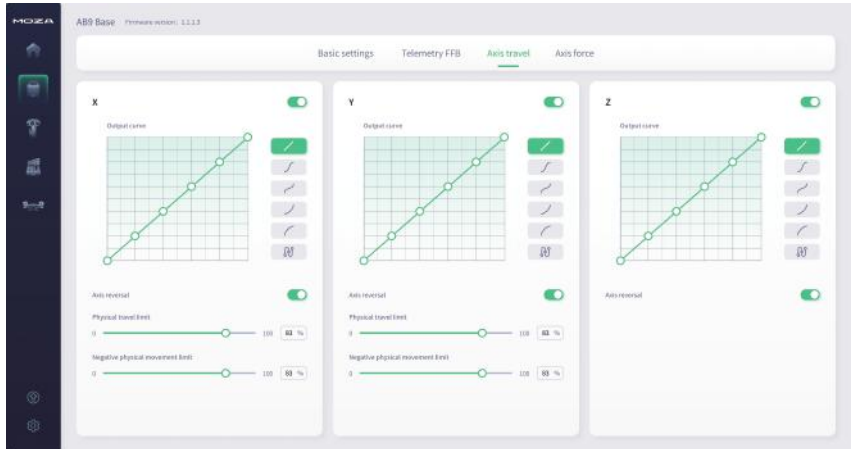

Axis Force Feedback Settings: Allow users to finely adjust the force feedback intensity of each segment to match the flight characteristics of specific aircraft.

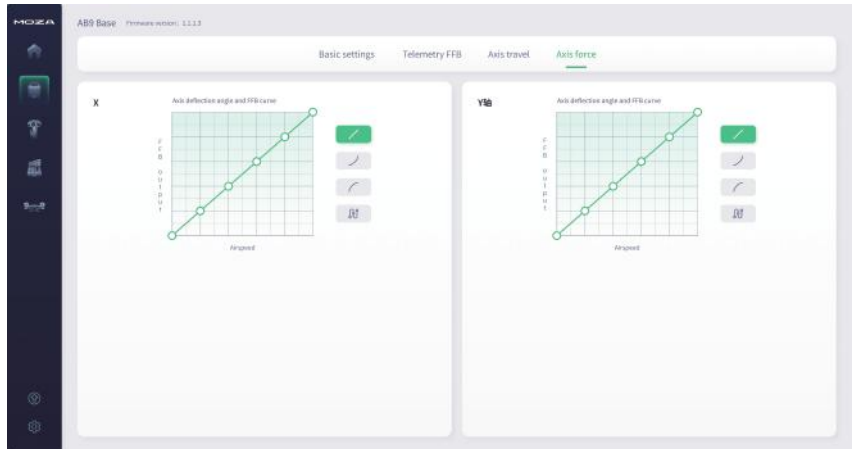

One-Click Firmware Upgrade: Easily update the MOZA flight simulation ecosystem with the latest features in one click.

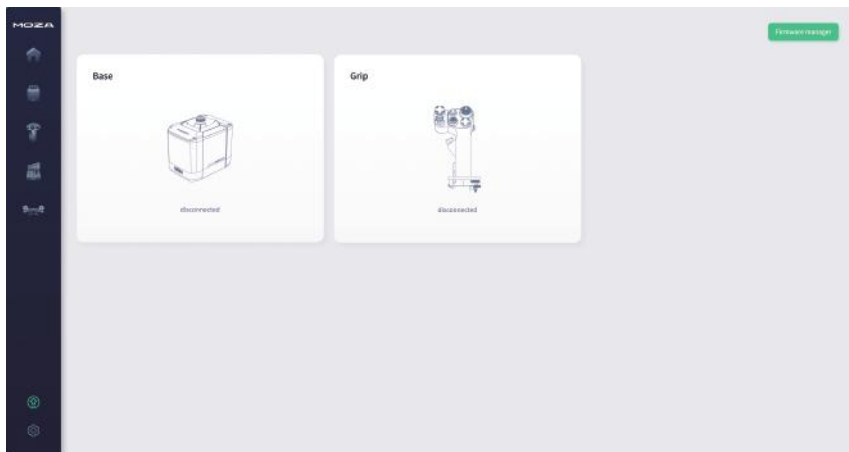

For detailed software instructions, please visit the MOZA Racing official website (www.mozaracing.com) help center page.

06 Specs

Supported Platform: PC

Maximum Limit Angle: $\pm 20^\circ$

Main Body Material: Aviation-Grade Aluminum Alloy

Peak Torque: 12N·m

Rated Voltage: 110V~220V AC > 36V DC

Rated Current: 6A

Rated Power: 216W

USB Refresh Rate: 1000Hz

Base Indicator Light: Supports displaying base status

Connection Ports: Power, data, throttle, rudder pedals, etc.

Installation Method: desktop or rig

Desktop Clamp: Optional

07 Precautions

- Do not expose the device to liquids or humidity as it may cause fire or electric shock.
- Avoid using the device in direct sunlight.
- Do not use MOZA flight sim gear with the MOZA racing gear.
- Recommended indoor temperature: 5°C ~ 35°C.
- For your safety and well-being, please monitor your gaming time and take breaks as needed.
- The device is not suitable for children under the age of 6, small accessories may pose a choking hazard!
- Children under 13 should have adult supervision.
- It is strictly forbidden to disassemble the equipment by yourself, failure to adhere to this will result in loss of warranty.
- The equipment must be connected with the factory-supplied power supply to ensure the electrical safety and the protection of user rights and interests.
- In order to ensure user safety, parts repair or replacement can only be carried out by officially authorized repair centers.
- Non-standard power supplies are strictly prohibited even if data such as related voltages match.
- Use only AC power provided by a standard wall outlet to avoid damage to the product.
- Do not expose the device to heat sources.
- Unplug the power cord of the device if it will not be used for a long time.
- If you find any abnormality, please stop using it immediately and seek help from MOZA representatives or authorized repair centers.
- Stay tuned to our official website and social media platforms for the latest product updates.

01 产品介绍

- MCLS力反馈算法
- 12N·m 峰值扭矩
- 双伺服电机
- 航空级铝合金机身
- 高分辨编码器
- 兼容主流游戏
- 静音顺滑结构
- MOZA Cockpit控制软件

02 基座接口介绍

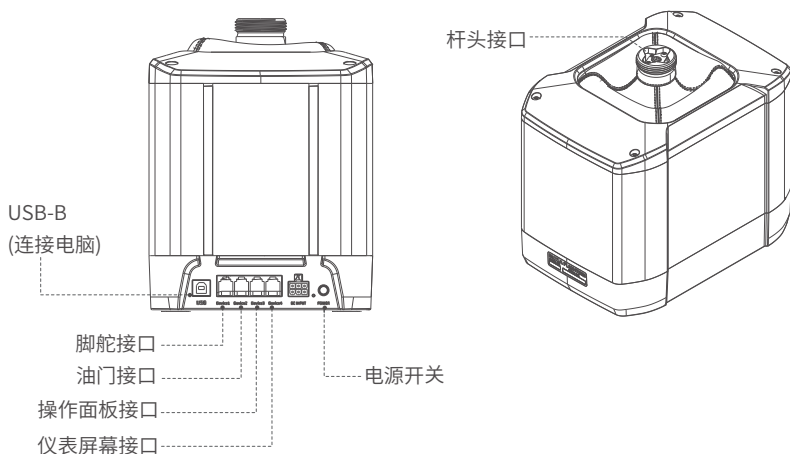

03 基本参数

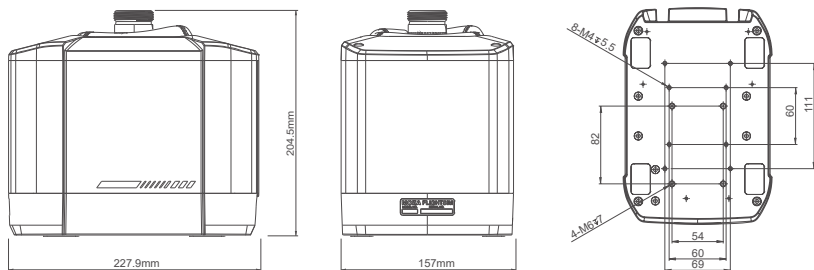

04 使用教程

安装操纵杆

1. 抽出操纵杆的连接线, 将连接线航空头上的箭头与基座刻度线对齐后插入到底, 保证连接线稳固(示意图1)
2. 顺时针方向旋紧操纵杆上的螺母环(示意图2)
3. 用附赠的扳手进一步增大旋紧力, 直到操纵杆与基座之间的连接稳固(示意图3)

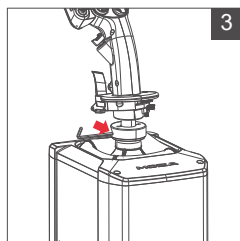
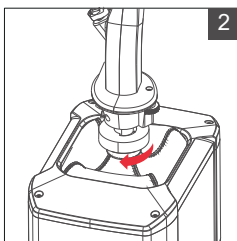
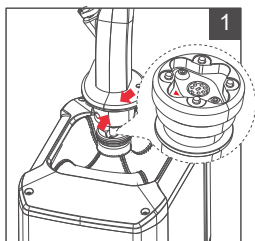

固定基座

1. 桌面夹桌面模式(桌面夹需另外选购):
 - a. 将MOZA AB9基座通过底部4~6个螺丝孔固定到桌面夹上。
 - b. 将桌面夹放置在桌面上, 拧紧星形手柄, 直到桌面夹稳固地紧固在桌面上。
2. 桌面夹悬挂模式(桌面夹需另外选购):
 - a. 根据自己想要的高度, 将桌面夹的4颗螺丝紧固在AB9侧面滑槽的滑槽螺母上。
 - b. 拧紧桌面夹星形手柄, 直到桌面夹稳固。
3. 除了桌面夹安装方式, 还可根据底部螺丝孔距将基座固定在部分成品模拟支架上。

产品使用

1. 将电源适配器的DC电源线、USB线Type-B端分别插入AB9基座尾部对应接口上, 适配器AC电源线接入220V电源插口, 短按开关开机(短按开机, 长按3S关机), 若成功连接则电源灯快闪。
2. USB线Type-A端接入PC, 若成功连接则电源灯常亮。
在MOZA官网(www.mozaracing.com)的帮助中心下载MOZA软件并安装, 即可开启您的飞行之旅。

05 软件介绍

主页面可以查看已连接的设备工作状态, 包含底座, 操纵杆, 油门, 脚舵等, 同时可以快捷启动游戏



基础设置: 帮助入门玩家轻松选择预设的力反馈模式, 确保能够迅速找到最适合自己的手感, 并且能够实时监控操纵杆的坐标位置

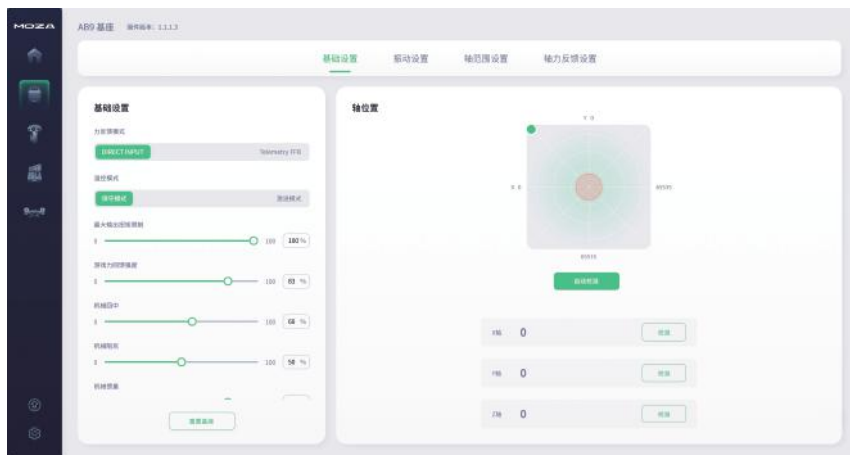

轴范围设置: 辅助调整单个方向的灵敏度、死区, 让操作更符合玩家个人体验

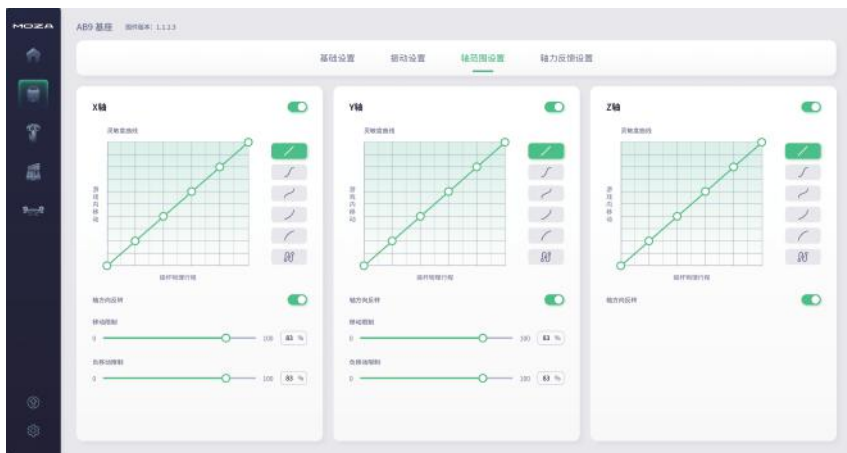

轴力反馈设置: 允许用户精细调节每段行程的力反馈强度, 以匹配特定飞机的飞行感受



一键完成MOZA飞行模拟生态系统固件升级, 轻松享受最新的功能体验

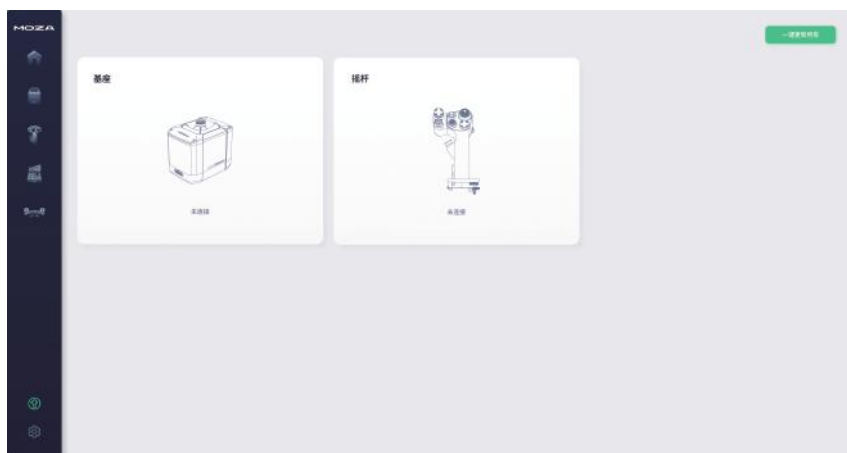

更多信息和教学视频请登录官网(www.mozaracing.com)进行查阅。

06 规格表

支持平台:PC

最大限位角:±20°

主体材料:航空级铝合金

最大扭矩:12N·m

额定电压:110V~220V AC>36V DC

额定电流:6A

额定功率:216W

USB刷新率:1000Hz

底座指示灯:支持显示底座状态

接口:电源、数据、油门、脚舵等附件

固定方式:配合桌面夹(选配)分为桌面模式或悬挂模式,亦可配合专业模拟舱支架

桌面夹:选装

07 注意事项

- 严禁将设备暴露在雨水以及潮湿的环境中, 以避免发生火灾/电击
- 严禁在太阳直射的条件下使用设备
- 严禁接入MOZA赛车模拟器生态产品
- 建议室内温度:5°C ~ 30°C
- 为了您的健康, 请合理控制游戏时间
- 设备不适用于6岁以下儿童, 小配件可能造成窒息的危险!
- 13岁以下孩童需在家长陪同下使用
- 严禁自行拆解设备, 否则将失去质保资格
- 设备必须使用配套出厂的电源进行连接, 以保障用电安全及用户权益得到保障
- 为保障相关安全, 零部件维修或者更换只能由官方授权维修中心进行
- 即使相关电压等数据匹配, 亦禁止使用非标准电源
- 只能使用标准壁式电源插座提供的交流电源以避免对产品造成损坏
- 禁止将设备暴露在热源中
- 长期不使用的情况下, 请拔出设备电源线断电
- 如发现有任何异常, 请立即停止使用并寻求 MOZA 官方或相关授权中心的帮助
- 请关注 MOZA 官网及公众平台以了解最新的相关产品信息

产品保修卡

| | | | |
|------|--|------|--|
| 产品型号 | | 购买日期 | |
| 用户姓名 | | 用户电话 | |
| 产品条码 | | 通讯地址 | |

经销商信息(签章)

产品保修条例

保修期

自购机日起, 基座主体, 方向盘, 踏板和仪表显示屏保修12个月。设备外壳、说明书、线材、螺丝、扳手、包装等不在"一年免费保修服务"范围内, 但您可以选择有偿服务。

购买者在以下条件下不享受免费保修服务, 但您可以选择有偿服务。

1. 超过三包有效期的；
2. 无三包凭证及有效发票的, 但能够证明该产品在三包有效期内的除外；
3. 包修凭证上的型号与修理产品型号不符或者涂改的；
4. 非本公司特约维修人员拆动造成损坏的；
5. 因不可抗力造成损坏的；
6. 未按产品使用说明书要求使用、维护、保养而造成损坏的。

保修期限鉴于产品部位、不同国家法律法规等差异, 将有所不同。相关国家与区域的保修期限, 请咨询MOZA官方或购买时联系的MOZA授权经销商。

