

MSI Graphics Card Quick User's Guide

Dragon Center Introduction

MSI Current Promotions

Installation Guide (NVIDIA)

Installation Guide (AMD)

Part No.: G52-XXXXX2BG

MSI Afterburner is the world's most recognized and widely used graphics card control utility. For more information please visit: <http://www.msi.com/page/afterburner>

MSI Afterburner is the world's most recognized and widely used graphics card control utility. For more information please visit: <http://www.msi.com/page/afterburner>

Package Contents

- Graphics card
- User Manual or Quick Guide (depends on the product)

System Requirements

- Minimum system requirements
- Operating system
- Power supply
- Storage

Auxiliary Tools

- Driver
- Software

English

Package Contents

- Graphics card
- User Manual or Quick Guide (depends on the product)

System Requirements

- Minimum system requirements
- Operating system
- Power supply
- Storage

Auxiliary Tools

- Driver
- Software

Deutsch

Lieferumfang

- Graphics card
- User Manual or Quick Guide (depends on the product)

Voraussetzungen für die Nutzung

- Minimum system requirements
- Operating system
- Power supply
- Storage

Systemerfordernisse

- Minimum system requirements
- Operating system
- Power supply
- Storage

Hardware-Installation

- Driver
- Software

Français

Contenu de l'emballage

- Graphics card
- User Manual or Quick Guide (depends on the product)

Préconditions d'usage

- Minimum system requirements
- Operating system
- Power supply
- Storage

Préconditions d'usage

- Minimum system requirements
- Operating system
- Power supply
- Storage

Configuration système requise

- Minimum system requirements
- Operating system
- Power supply
- Storage

Installation logiciel

- Driver
- Software

Русский

Комплектация

- Graphics card
- User Manual or Quick Guide (depends on the product)

Требования к системе

- Minimum system requirements
- Operating system
- Power supply
- Storage

Требования к системе

- Minimum system requirements
- Operating system
- Power supply
- Storage

Установка программного обеспечения

- Driver
- Software

Українська

Комплектація

- Graphics card
- User Manual or Quick Guide (depends on the product)

Вимоги до системи

- Minimum system requirements
- Operating system
- Power supply
- Storage

Вимоги до системи

- Minimum system requirements
- Operating system
- Power supply
- Storage

Установка програмного забезпечення

- Driver
- Software

Polski

Zawartość opakowania

- Graphics card
- User Manual or Quick Guide (depends on the product)

Wymagania systemowe

- Minimum system requirements
- Operating system
- Power supply
- Storage

Wymagania systemowe

- Minimum system requirements
- Operating system
- Power supply
- Storage

Instalacja oprogramowania

- Driver
- Software

Português

Conteúdo da embalagem

- Graphics card
- User Manual or Quick Guide (depends on the product)

Requisitos do sistema

- Minimum system requirements
- Operating system
- Power supply
- Storage

Requisitos do sistema

- Minimum system requirements
- Operating system
- Power supply
- Storage

Instalação de software

- Driver
- Software

Español

Contenido del paquete

- Graphics card
- User Manual or Quick Guide (depends on the product)

Requisitos del sistema

- Minimum system requirements
- Operating system
- Power supply
- Storage

Requisitos del sistema

- Minimum system requirements
- Operating system
- Power supply
- Storage

Instalación de software

- Driver
- Software

Türkçe

PaKET İÇERİĞİ

- Graphics card
- User Manual or Quick Guide (depends on the product)

Sistem gereksinimleri

- Minimum system requirements
- Operating system
- Power supply
- Storage

Sistem gereksinimleri

- Minimum system requirements
- Operating system
- Power supply
- Storage

Yazılım kurulumu

- Driver
- Software

Latviski

Pašūdu krājums

- Graphics card
- User Manual or Quick Guide (depends on the product)

Sistēmas prasības

- Minimum system requirements
- Operating system
- Power supply
- Storage

Sistēmas prasības

- Minimum system requirements
- Operating system
- Power supply
- Storage

Programmatūras uzstādīšana

- Driver
- Software

Lietuviški

Įpakavimas

- Graphics card
- User Manual or Quick Guide (depends on the product)

Reikiamosios reiškiniai

- Minimum system requirements
- Operating system
- Power supply
- Storage

Reikiamosios reiškiniai

- Minimum system requirements
- Operating system
- Power supply
- Storage

Programos įdiegimas

- Driver
- Software

Nederlands

Verpakingsinhoud

- Graphics card
- User Manual or Quick Guide (depends on the product)

Voorvereisten voor gebruik

- Minimum system requirements
- Operating system
- Power supply
- Storage

Voorvereisten voor gebruik

- Minimum system requirements
- Operating system
- Power supply
- Storage

Software installatie

- Driver
- Software

Čeština

Obsah balení

- Graphics card
- User Manual or Quick Guide (depends on the product)

Upravičné požiadavky

- Minimum system requirements
- Operating system
- Power supply
- Storage

Upravičné požiadavky

- Minimum system requirements
- Operating system
- Power supply
- Storage

Upravičné požiadavky

- Minimum system requirements
- Operating system
- Power supply
- Storage

Srpski

Sadržaj pakovanja

- Graphics card
- User Manual or Quick Guide (depends on the product)

Preporučeni zahtevi

- Minimum system requirements
- Operating system
- Power supply
- Storage

Preporučeni zahtevi

- Minimum system requirements
- Operating system
- Power supply
- Storage

Upravljački softver

- Driver
- Software

Magyar

A csomag tartalma

- Graphics card
- User Manual or Quick Guide (depends on the product)

Szükséges követelmények

- Minimum system requirements
- Operating system
- Power supply
- Storage

Szükséges követelmények

- Minimum system requirements
- Operating system
- Power supply
- Storage

Szoftvertelepítés

- Driver
- Software

Latvian

Pašūdu krājums

- Graphics card
- User Manual or Quick Guide (depends on the product)

Reikiamosios reiškiniai

- Minimum system requirements
- Operating system
- Power supply
- Storage

Reikiamosios reiškiniai

- Minimum system requirements
- Operating system
- Power supply
- Storage

Programas uzstādīšana

- Driver
- Software

Lietuviški

Įpakavimas

- Graphics card
- User Manual or Quick Guide (depends on the product)

Reikiamosios reiškiniai

- Minimum system requirements
- Operating system
- Power supply
- Storage

Reikiamosios reiškiniai

- Minimum system requirements
- Operating system
- Power supply
- Storage

Programos įdiegimas

- Driver
- Software

Italiano

Contenuto della confezione

- Graphics card
- User Manual or Quick Guide (depends on the product)

Requisiti di sistema

- Minimum system requirements
- Operating system
- Power supply
- Storage

Requisiti di sistema

- Minimum system requirements
- Operating system
- Power supply
- Storage

Instalazione hardware

- Driver
- Software

Română

Conținutul pachetului

- Graphics card
- User Manual or Quick Guide (depends on the product)

Precondiții necesare

- Minimum system requirements
- Operating system
- Power supply
- Storage

Precondiții necesare

- Minimum system requirements
- Operating system
- Power supply
- Storage

Instalarea software

- Driver
- Software

Slovenščina

Obsah balenia

- Graphics card
- User Manual or Quick Guide (depends on the product)

Preporučeni zahtevi

- Minimum system requirements
- Operating system
- Power supply
- Storage

Preporučeni zahtevi

- Minimum system requirements
- Operating system
- Power supply
- Storage

Upravljalni programi

- Driver
- Software

Ελληνικά

Περιεχόμενα συσκευασίας

- Graphics card
- User Manual or Quick Guide (depends on the product)

Προϋποθέσεις χρήσης

- Minimum system requirements
- Operating system
- Power supply
- Storage

Προϋποθέσεις χρήσης

- Minimum system requirements
- Operating system
- Power supply
- Storage

Εγκατάσταση λογισμικού

- Driver
- Software

Eesti

Pakendi sisu

- Graphics card
- User Manual or Quick Guide (depends on the product)

Ettevaatusabinid

- Minimum system requirements
- Operating system
- Power supply
- Storage

Ettevaatusabinid

- Minimum system requirements
- Operating system
- Power supply
- Storage

Programmatüri paigaldamine

- Driver
- Software

MSI Afterburner is the world's most recognized and widely used graphics card control utility. For more information please visit: <http://www.msi.com/page/afterburner>

MSI Afterburner is the world's most recognized and widely used graphics card control utility. For more information please visit: <http://www.msi.com/page/afterburner>

MSI Afterburner is the world's most recognized and widely used graphics card control utility. For more information please visit: <http://www.msi.com/page/afterburner>

Package Contents

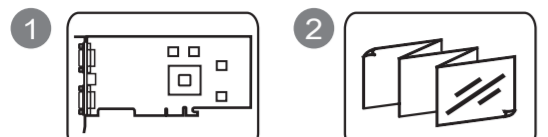

System Requirements



Auxiliary Tools



Hardware Installation

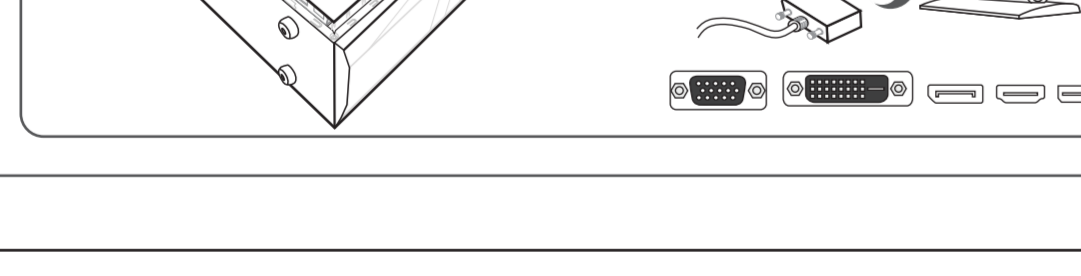
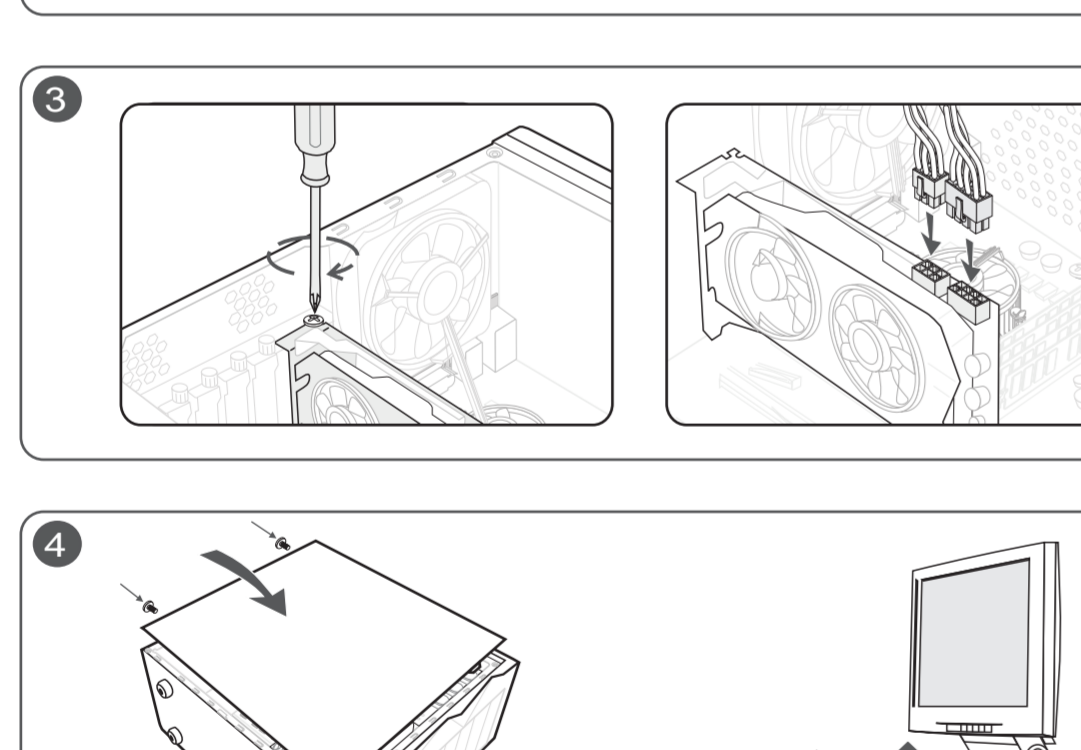
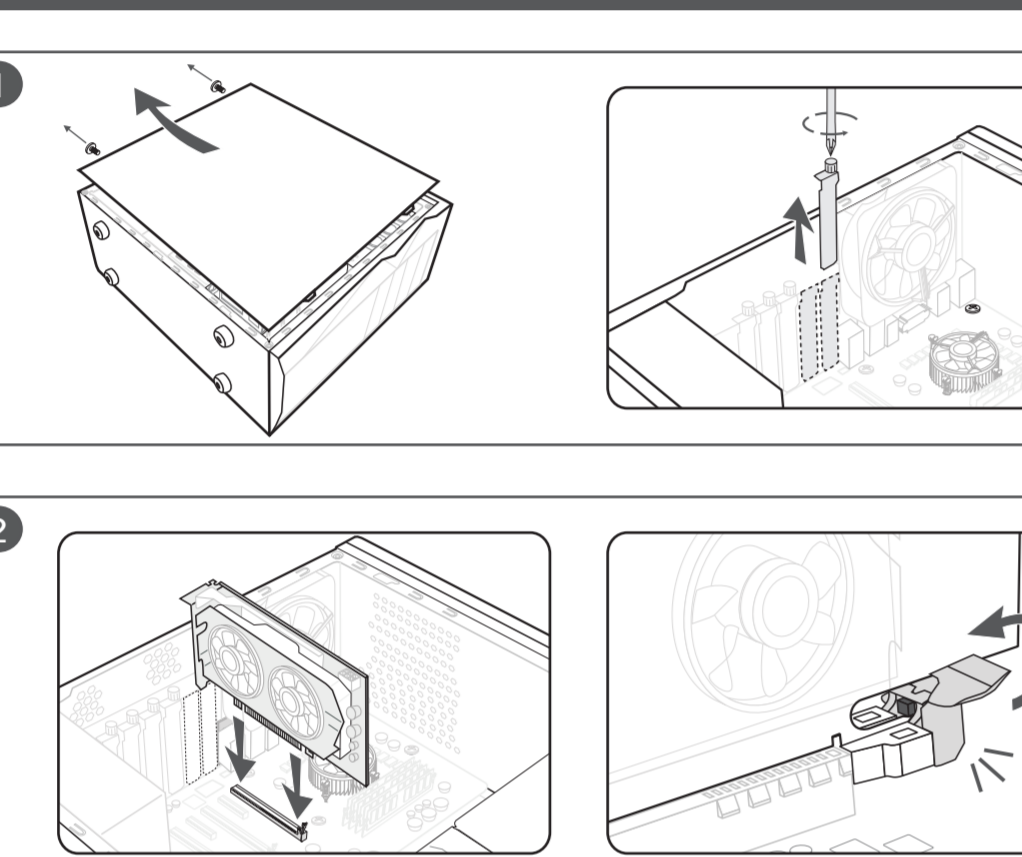

MSI Warranty Procedures and Conditions

This is only valid for Australia.

The terms and conditions of MSI's warranty described herein adhere to the guidelines set forth by the Australian Competition & Consumer Commission ("ACCC"), in addition to the specific provisions under the Australian Consumer Law ("ACL"). Our goods come with guarantees that cannot be excluded under the Australian Consumer Law. You are entitled to a replacement or refund for a major failure and for compensation for any other reasonably foreseeable loss or damage. You are also entitled to have the goods repaired or replaced if the goods fail to be of acceptable quality for a major failure.

(1) Determination of the warranty period: The warranty period starts from the date you purchase the product with valid invoice. If the date of the warranty period is a holiday or the day of purchase is the day of the warranty period.

(2) Customer-Initiated Defect (CID): If the problem or symptom is not diagnosed with improper usage defined as Customer-Initiated Defect (CID), shall not be accounted in warranty claim of the product. MSI reserves the right to determine whether the products are operated within the scope of proper usage.

(3) Limited Warranty: The software not provided is not covered under the Product's warranty. MSI assumes no responsibility for the software not provided by the customer used and any possible consequential damage or damage.

(4) Screen the problems by self-checking: Please first review the User's Manual and contents of the Software CD included with the Product. The User's Manual and Software CD provided by MSI contain a lot of information about product use. The manual will compose from user's perspective can answer many of your questions. If you still have any problem, you may contact the manual you need from the MSI website. MSI website for Australia: www.msi.com.au

(5) Seek support from the original source of purchase: If you cannot seek any solution for the problem at the above methods, you may seek support from the original source of purchase, because the original date of purchase should not less than your system configuration and specifications, and can provide you with any necessary resource and advice.

(6) Bring the Product to the original source of purchase: If your product has been determined by the MSI engineer or store as problematic or defective in hardware, and have your need for repair, you may bring your product to request for repair/replacement to the original date of purchase to send the product or replacement to your request or support from the original source of purchase.

(7) Warranty receipt: The valid receipt of your purchase should be provided for the warranty service.

(8) Contact: Please first review the User's Manual and contents of the Software CD included with the Product. The User's Manual and Software CD provided by MSI contain a lot of information about product use. The manual will compose from user's perspective can answer many of your questions. If you still have any problem, you may contact the manual you need from the MSI website. MSI website for Australia: www.msi.com.au

Қазақ

Қазақ тіліндегі пайдаланушының құрамы

1. Қазақ тіліндегі пайдаланушының құрамы. 2. Қазақ тіліндегі пайдаланушының құрамы. 3. Қазақ тіліндегі пайдаланушының құрамы.

Қазақ тіліндегі пайдаланушының құрамы

1. Қазақ тіліндегі пайдаланушының құрамы. 2. Қазақ тіліндегі пайдаланушының құрамы. 3. Қазақ тіліндегі пайдаланушының құрамы.

Norsk

Pakkeinnhold

1. Pakkeinnhold. 2. Pakkeinnhold. 3. Pakkeinnhold.

Forhåndsregler for bruk

1. Forhåndsregler for bruk. 2. Forhåndsregler for bruk. 3. Forhåndsregler for bruk.

Systemkrav

1. Systemkrav. 2. Systemkrav. 3. Systemkrav.

简体中文

包内内容

1. 包内内容. 2. 包内内容. 3. 包内内容.

使用注意事项

1. 使用注意事项. 2. 使用注意事项. 3. 使用注意事项.

ภาษาไทย

รายการประกอบชุด

1. รายการประกอบชุด. 2. รายการประกอบชุด. 3. รายการประกอบชุด.

ข้อกำหนดการใช้งาน

1. ข้อกำหนดการใช้งาน. 2. ข้อกำหนดการใช้งาน. 3. ข้อกำหนดการใช้งาน.

Svenska

Förpackningens innehåll

1. Förpackningens innehåll. 2. Förpackningens innehåll. 3. Förpackningens innehåll.

Förhållningsregler för användning

1. Förhållningsregler för användning. 2. Förhållningsregler för användning. 3. Förhållningsregler för användning.

Systemkrav

1. Systemkrav. 2. Systemkrav. 3. Systemkrav.

Slovensčina

Vsebina paketa

1. Vsebina paketa. 2. Vsebina paketa. 3. Vsebina paketa.

Previdilne ukrepe za uporabo

1. Previdilne ukrepe za uporabo. 2. Previdilne ukrepe za uporabo. 3. Previdilne ukrepe za uporabo.

Systemne zahteve

1. Systemne zahteve. 2. Systemne zahteve. 3. Systemne zahteve.

한국어

패키지 내용

1. 패키지 내용. 2. 패키지 내용. 3. 패키지 내용.

사용 주의 사항

1. 사용 주의 사항. 2. 사용 주의 사항. 3. 사용 주의 사항.

Tiếng Việt

Bàn trong sản phẩm

1. Bàn trong sản phẩm. 2. Bàn trong sản phẩm. 3. Bàn trong sản phẩm.

Thận trọng khi sử dụng

1. Thận trọng khi sử dụng. 2. Thận trọng khi sử dụng. 3. Thận trọng khi sử dụng.

Suomi

Pakkaus sisältö

1. Pakkaus sisältö. 2. Pakkaus sisältö. 3. Pakkaus sisältö.

Ohjeet käytön aloittamiseen

1. Ohjeet käytön aloittamiseen. 2. Ohjeet käytön aloittamiseen. 3. Ohjeet käytön aloittamiseen.

Systemvaatimukset

1. Systemvaatimukset. 2. Systemvaatimukset. 3. Systemvaatimukset.

Hrvatski

Sadržaj pakiranja

1. Sadržaj pakiranja. 2. Sadržaj pakiranja. 3. Sadržaj pakiranja.

Preporučeni postupci pri korištenju

1. Preporučeni postupci pri korištenju. 2. Preporučeni postupci pri korištenju. 3. Preporučeni postupci pri korištenju.

Sustavne zahtjeve

1. Sustavne zahtjeve. 2. Sustavne zahtjeve. 3. Sustavne zahtjeve.

日本語

パッケージ内容

1. パッケージ内容. 2. パッケージ内容. 3. パッケージ内容.

使用上の注意

1. 使用上の注意. 2. 使用上の注意. 3. 使用上の注意.

हिन्दी

पैकेज सामग्री

1. पैकेज सामग्री. 2. पैकेज सामग्री. 3. पैकेज सामग्री.

उपयोग के लिए सावधानी

1. उपयोग के लिए सावधानी. 2. उपयोग के लिए सावधानी. 3. उपयोग के लिए सावधानी.

Dansk

Pakkeens indhold

1. Pakkeens indhold. 2. Pakkeens indhold. 3. Pakkeens indhold.

Forhåndsregler for brug

1. Forhåndsregler for brug. 2. Forhåndsregler for brug. 3. Forhåndsregler for brug.

Systemkrav

1. Systemkrav. 2. Systemkrav. 3. Systemkrav.

繁體中文包裝內容 1. 包裝內容. 2. 包裝內容. 3. 包裝內容. 使用注意事項 1. 使用注意事項. 2. 使用注意事項. 3. 使用注意事項.

Bahasa Indonesia

Isi Kemasan

1. Isi Kemasan. 2. Isi Kemasan. 3. Isi Kemasan.

Kelembutan dalam penggunaan

1. Kelembutan dalam penggunaan. 2. Kelembutan dalam penggunaan. 3. Kelembutan dalam penggunaan.

Peringatan Tambahan

1. Peringatan Tambahan. 2. Peringatan Tambahan. 3. Peringatan Tambahan.

العربية

محتويات العبوة

1. محتويات العبوة. 2. محتويات العبوة. 3. محتويات العبوة.

تعليمات الاستخدام

1. تعليمات الاستخدام. 2. تعليمات الاستخدام. 3. تعليمات الاستخدام.

Bosanski

Sadržaj pakovanja

1. Sadržaj pakovanja. 2. Sadržaj pakovanja. 3. Sadržaj pakovanja.

Preporučeni postupci pri korištenju

1. Preporučeni postupci pri korištenju. 2. Preporučeni postupci pri korištenju. 3. Preporučeni postupci pri korištenju.

Sustavne zahtjeve

1. Sustavne zahtjeve. 2. Sustavne zahtjeve. 3. Sustavne zahtjeve.

Български

Съдържание на опаковката

1. Съдържание на опаковката. 2. Съдържание на опаковката. 3. Съдържание на опаковката.

Препоръчителни действия при употреба

1. Препоръчителни действия при употреба. 2. Препоръчителни действия при употреба. 3. Препоръчителни действия при употреба.

Изисквания към системата

1. Изисквания към системата. 2. Изисквания към системата. 3. Изисквания към системата.

বাংলা

প্যাকেজের উপাদান

1. প্যাকেজের উপাদান. 2. প্যাকেজের উপাদান. 3. প্যাকেজের উপাদান.

ব্যবহারের নির্দেশাবলী

1. ব্যবহারের নির্দেশাবলী. 2. ব্যবহারের নির্দেশাবলী. 3. ব্যবহারের নির্দেশাবলী.

فارسی

محتویات بسته بندی

1. محتویات بسته بندی. 2. محتویات بسته بندی. 3. محتویات بسته بندی.

توجهات در استفاده

1. توجهات در استفاده. 2. توجهات در استفاده. 3. توجهات در استفاده.

 상호 : ㈜ 엠에스아이코리아
제품명 : 그래픽카드
모델명 : V388
제조년월 : 2020년
제조사 및 제조국가 : MSI / 중국
R-R-MSI-MS-V388

 상호 : ㈜ 엠에스아이코리아
제품명 : 그래픽카드
모델명 : RTX3090VT
제조년월 : 2020년
제조사 및 제조국가 : MSI / 중국
R-R-MSI-RTX3090VT

 상호 : ㈜ 엠에스아이코리아
제품명 : 그래픽카드
모델명 : V389
제조년월 : 2020년
제조사 및 제조국가 : MSI / 중국
R-R-MSI-MS-V389

 상호 : ㈜ 엠에스아이코리아
제품명 : 그래픽카드
모델명 : RTX3080VT
제조년월 : 2020년
제조사 및 제조국가 : MSI / 중국
R-R-MSI-RTX3080VT

 상호 : ㈜ 엠에스아이코리아
제품명 : 그래픽카드
모델명 : MS-V390
제조년월 : 2020년
제조사 및 제조국가 : MSI / 중국
R-R-MSI-MS-V390

 상호 : ㈜ 엠에스아이코리아
제품명 : 그래픽카드
모델명 : RTX3070VT3
제조년월 : 2020년
제조사 및 제조국가 : MSI / 중국
R-R-MSI-RTX3070VT3

 상호 : ㈜ 엠에스아이코리아
제품명 : 그래픽카드
모델명 : RTX3070VT
제조년월 : 2020년
제조사 및 제조국가 : MSI / 중국
R-R-MSI-RTX3070VT

 상호 : ㈜ 엠에스아이코리아
제품명 : 그래픽카드
모델명 : MS-V375
제조년월 : 2020년
제조사 및 제조국가 : MSI / 중국
R-R-MSI-MS-V375

 상호 : ㈜ 엠에스아이코리아
제품명 : 그래픽카드
모델명 : N1660SG
제조년월 : 2020년
제조사 및 제조국가 : MSI / 중국
R-R-MSI-N1660SG

 상호 : ㈜ 엠에스아이코리아
제품명 : 그래픽카드
모델명 : N1660SVX
제조년월 : 2020년
제조사 및 제조국가 : MSI / 중국
R-R-MSI-N1660SVX

 상호 : ㈜ 엠에스아이코리아
제품명 : 그래픽카드
모델명 : MS-V379
제조년월 : 2020년
제조사 및 제조국가 : MSI / 중국
R-R-MSI-MS-V379

 상호 : ㈜ 엠에스아이코리아
제품명 : 그래픽카드
모델명 : V385
제조년월 : 2020년
제조사 및 제조국가 : MSI / 중국
R-R-MSI-MS-V385

 상호 : ㈜ 엠에스아이코리아
제품명 : 그래픽카드
모델명 : N1650SV
제조년월 : 2020년
제조사 및 제조국가 : MSI / 중국
R-R-MSI-N1650SV

 상호 : ㈜ 엠에스아이코리아
제품명 : 그래픽카드
모델명 : N1650VTD62
제조년월 : 2020년
제조사 및 제조국가 : MSI / 중국
R-R-MSI-N1650VTD62

 상호 : ㈜ 엠에스아이코리아
제품명 : 그래픽카드
모델명 : N1650AEROD62
제조년월 : 2020년
제조사 및 제조국가 : MSI / 중국
R-R-MSI-N1650AEROD62

 상호 : ㈜ 엠에스아이코리아
제품명 : 그래픽카드
모델명 : N1650VTD6
제조년월 : 2020년
제조사 및 제조국가 : MSI / 중국
R-R-MSI-N1650VTD6

 상호 : ㈜ 엠에스아이코리아
제품명 : 그래픽카드
모델명 : N1650AEROD6
제조년월 : 2020년
제조사 및 제조국가 : MSI / 중국
R-R-MSI-N1650AEROD6

 상호 : ㈜ 엠에스아이코리아
제품명 : 그래픽카드
모델명 : N1650VT
제조년월 : 2020년
제조사 및 제조국가 : MSI / 중국
R-R-MSI-N1650VT

 상호 : ㈜ 엠에스아이코리아
제품명 : 그래픽카드
모델명 : N1650AERO
제조년월 : 2020년
제조사 및 제조국가 : MSI / 중국
R-R-MSI-N1650AERO

 상호 : ㈜ 엠에스아이코리아
제품명 : 그래픽카드
모델명 : N1050TIV1
제조년월 : 2020년
제조사 및 제조국가 : MSI / 중국
MSIP-REI-MSI-N1050TIV1

 상호 : ㈜ 엠에스아이코리아
제품명 : 그래픽카드
모델명 : N1050TIOV1
제조년월 : 2020년
제조사 및 제조국가 : MSI / 중국
MSIP-REI-MSI-N1050TIOV1

 상호 : ㈜ 엠에스아이코리아
제품명 : 그래픽카드
모델명 : N1030AERO
제조년월 : 2020년
제조사 및 제조국가 : MSI / 중국
MSIP-REI-MSI-N1030AERO

 상호 : ㈜ 엠에스아이코리아
제품명 : 그래픽카드
모델명 : N730KHL
제조년월 : 2020년
제조사 및 제조국가 : MSI / 중국
R-R-MSI-N730KHL

 상호 : ㈜ 엠에스아이코리아
제품명 : 그래픽카드
모델명 : N710
제조년월 : 2020년
제조사 및 제조국가 : MSI / 중국
MSIP-REI-MSI-N710

 상호 : ㈜ 엠에스아이코리아
제품명 : 그래픽카드
모델명 : RX5700XM
제조년월 : 2020년
제조사 및 제조국가 : MSI / 중국
R-R-MSI-RX5700XM

 상호 : ㈜ 엠에스아이코리아
제품명 : 그래픽카드
모델명 : RX5600XTM
제조년월 : 2020년
제조사 및 제조국가 : MSI / 중국
R-R-MSI-RX5600XTM