

**NEC**

Desktop Monitor

**MultiSync EA231WU**

**MultiSync EA241F**

User's Manual

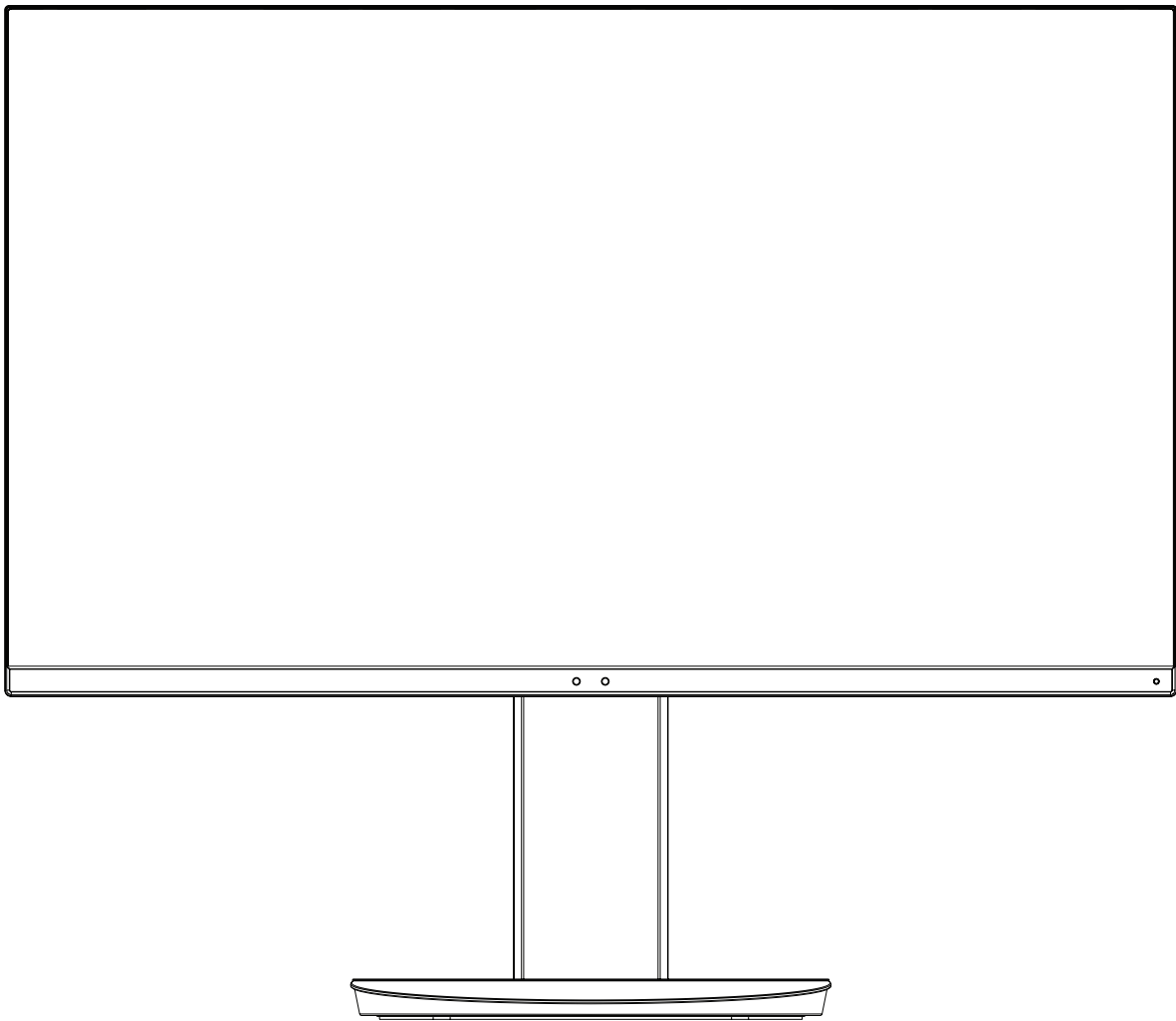

MODEL: EA231WU-BK, EA241F-BK

Please find your model name in the label on the rear side of the monitor.

# Index

---

WARNING .....	English-1
CAUTION .....	English-1
Registration Information .....	English-2
Recommended use .....	English-3
Safety Precautions and Maintenance .....	English-3
Ergonomics .....	English-4
Cleaning the LCD Panel.....	English-4
Cleaning the Cabinet.....	English-4
Parts Name and Functions .....	English-5
Quick Start.....	English-6
ControlSync.....	English-11
Controls .....	English-13
Specifications - EA231WU .....	English-21
Specifications - EA241F .....	English-22
Features .....	English-24
Troubleshooting.....	English-25
Human Sensing function .....	English-27
Using the Auto Brightness function .....	English-28
Manufacturer's Recycling and Energy Information.....	English-29

**WARNING**

⚡ TO PREVENT FIRE OR SHOCK HAZARDS, DO NOT EXPOSE THIS UNIT TO RAIN OR MOISTURE. ALSO, DO NOT USE THIS UNIT'S POLARIZED PLUG WITH AN EXTENSION CORD RECEPTACLE OR OTHER OUTLETS UNLESS THE PRONGS CAN BE FULLY INSERTED.

⚠ REFRAIN FROM OPENING THE CABINET AS THERE ARE HIGH VOLTAGE COMPONENTS INSIDE. REFER SERVICING TO QUALIFIED SERVICE PERSONNEL.

**CAUTION**

⚡ TO REDUCE THE RISK OF ELECTRIC SHOCK, MAKE SURE POWER CORD IS UNPLUGGED FROM WALL SOCKET. TO FULLY DISENGAGE THE POWER TO THE UNIT, PLEASE DISCONNECT THE POWER CORD FROM THE AC OUTLET. DO NOT REMOVE COVER (OR BACK). NO USER SERVICEABLE PARTS INSIDE. REFER SERVICING TO QUALIFIED SERVICE PERSONNEL.



This symbol warns user that uninsulated voltage within the unit may have sufficient magnitude to cause electric shock. Therefore, it is dangerous to make any kind of contact with any part inside this unit.



This symbol alerts the user that important literature concerning the operation and maintenance of this unit has been included. Therefore, it should be read carefully in order to avoid any problems.

**⚠ CAUTION:** Please use the power cord provided with this display in accordance with the table below. If a power cord is not supplied with this equipment, please contact NEC. For all other cases, please use the power cord with the plug style that matches the power socket where the monitor is located. The compatible power cord corresponds to the AC voltage of the power outlet and has been approved by, and complies with, the safety standards in the country of purchase.

This equipment is designed to be used in the condition of the power cord connected to earth. If the power cord is not connected to the earth, it may cause electric shock. Please make sure the power cord is earthed properly.

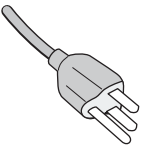
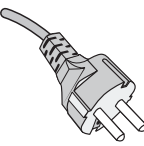
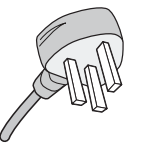
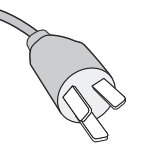
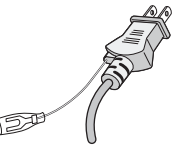
Plug Type	North America	European Continental	U.K.	Chinese	Japanese
Plug Shape					
Country	U.S.A./Canada	EU	U.K.	China	Japan
Voltage	120*	230	230	220	100

\*When operating the monitor with its AC 125-240V power supply, use a power supply cord that matches the power supply voltage of the AC power outlet being used.

**NOTE:** This product can only be serviced in the country where it was purchased.

Windows is a registered trademark of Microsoft Corporation. NEC is a registered trademark of NEC Corporation. ErgoDesign is a registered trademark of NEC Display Solutions, Ltd. in Austria, Benelux, Denmark, France, Germany, Italy, Norway, Spain, Sweden, U.K.

All other brands and product names are trademarks or registered trademarks of their respective owners.

ENERGY STAR is a U.S. registered trademark.

As an ENERGY STAR® Partner, NEC Display Solutions of America, Inc. has determined that this product meets the ENERGY STAR guidelines for energy efficiency. The ENERGY STAR emblem does not represent EPA endorsement of any product or service.

DisplayPort and DisplayPort Compliance Logo are trademarks owned by Video Electronics Standards Association in the United States and other countries.

MultiSync is a trademark or registered trademark of NEC Display Solutions, Ltd. in Japan and other countries.



HDCP (High-bandwidth Digital Content Protection): HDCP is a system for preventing illegal copying of video data sent over a digital signal. If you are unable to view material via the digital signal input, this does not necessarily mean the display is not functioning properly. With the implementation of HDCP, there may be cases in which certain content is protected with HDCP and might not be displayed due to the decision/intention of the HDCP community (Digital Content Protection, LLC).

The terms HDMI and HDMI High-Definition Multimedia Interface, and the HDMI Logo are trademarks or registered trademarks of HDMI Licensing Administrator, Inc. in the United States and other countries.



- The intended primary use of this product is as an Information Technical Equipment in an office or domestic environment.
- The product is intended to be connected to a computer and is not intended for the display of television broadcast signals.



# Registration Information

## Cable Information

**⚠ CAUTION:** Use the provided specified cables with this monitor so as not to interfere with radio and television reception. For DVI-D and mini D-Sub 15-pin, please use a shielded signal cable with ferrite core. For HDMI, DisplayPort, USB and AUDIO, please use a shielded signal cable. Use of other cables and adapters may cause interference with radio and television reception.

## FCC Information

**⚠ WARNING:** The Federal Communications Commission does not allow any modifications or changes to the unit EXCEPT those specified by NEC Display Solutions of America, Inc. in this manual. Failure to comply with this government regulation could void your right to operate this equipment.

1. The power supply cord you use must have been approved by and comply with the safety standards of U.S.A., and meet the following condition.

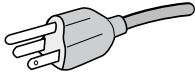
Power supply cord Plug shape	Non shield type, 3-conductor  U.S.A
---------------------------------	--

2. This equipment has been tested and found to comply with the limits for a Class B digital device, pursuant to part 15 of the FCC Rules. These limits are designed to provide reasonable protection against harmful interference in a residential installation. This equipment generates, uses and can radiate radio frequency energy, and, if not installed and used in accordance with the instructions, may cause harmful interference to radio communications. However, there is no guarantee that interference will not occur in a particular installation. If this equipment does cause harmful interference to radio or television reception, which can be determined by turning the equipment off and on, the user is encouraged to try to correct the interference by one or more of the following measures:
  - Reorient or relocate the receiving antenna.
  - Increase the separation between the equipment and receiver.
  - Connect the equipment into an outlet on a circuit different from that to which the receiver is connected.
  - Consult the dealer or an experienced radio/TV technician for help.

If necessary, the user should contact the dealer or an experienced radio/television technician for additional suggestions. The user may find the following booklet, prepared by the Federal Communications Commission, helpful: "How to Identify and Resolve Radio-TV Interference Problems." This booklet is available from the U.S. Government Printing Office, Washington, D.C., 20402, Stock No. 004-000-00345-4.

## SUPPLIER'S DECLARATION OF CONFORMITY

This device complies with Part 15 of FCC Rules. Operation is subject to the following two conditions. (1) This device may not cause harmful interference, and (2) this device must accept any interference received, including interference that may cause undesired operation.

**U.S. Responsible Party:** NEC Display Solutions of America, Inc.

**Address:** 3250 Lacey Rd, Ste 500  
Downers Grove, IL 60515  
**Tel. No.:** (630) 467-3000

Type of Product: Display Monitor

Equipment Classification: Class B Peripheral

Model: MultiSync EA231WU (EA231WU-BK)  
MultiSync EA241F (EA241F-BK)



To see a list of our TCO certified monitors and their TCO Certification (in English only), visit our website at

[https://www.nec-display.com/global/about/legal\\_regulation/TCO\\_mn/index.html](https://www.nec-display.com/global/about/legal_regulation/TCO_mn/index.html)

**⚠ CAUTION:** Please confirm the distribution system in building installation shall provide the circuit breaker rated 120/240V, 20A (maximum).

# Recommended use

## Safety Precautions and Maintenance



### WARNING

FOR OPTIMUM PERFORMANCE, PLEASE NOTE  
THE FOLLOWING WHEN SETTING UP AND  
USING THE LCD COLOR MONITOR:

- **DO NOT OPEN THE MONITOR.** There are no user serviceable parts inside and opening or removing covers may expose you to dangerous shock hazards or other risks. Refer all servicing to qualified service personnel.
- Do not spill any liquids into the cabinet or use your monitor near water.
- Do not insert objects of any kind into the cabinet slots as they may touch dangerous voltage points, which can be harmful or fatal, or may cause electric shock, fire or equipment failure.
- Do not place any heavy objects on the power cord. Damage to the cord may cause shock or fire.
- Do not place this product on a sloping or unstable cart, stand or table, as the monitor may fall, causing serious damage to the monitor.
- The power supply cord you use must have been approved by and comply with the safety standards of your country. (e.g. Type H05VV-F 3G 0.75 mm<sup>2</sup> should be used in Europe).
- In the UK use a BS-approved power cord with a molded plug having a black (5A) fuse installed for use with this monitor.
- Do not use the monitor outdoors.
- Do not bend, crimp or otherwise damage the power cord.
- Do not use the monitor in high temperature, humid, dusty, or oily areas.
- Do not cover the vent on the monitor.
- Vibration can damage the backlight. Do not install in areas where the monitor will be exposed to continual vibration.
- If monitor or glass is broken, do not come in contact with the liquid crystal and handle with care.
- To prevent damage to the LCD monitor caused by tipping over due to earthquakes or other shocks, make sure to install the monitor in a stable location and take measures to prevent falling.
- Immediately turn off the power, unplug your monitor from the wall outlet and move to a safe location, then refer servicing to qualified service personnel under the following conditions. If the monitor is used in this condition, the monitor may cause fall, fire and electric shock:
  - If the monitor stand has been cracked or peeled.
  - If you notice any structural damage such as cracks or unnatural wobbling.
  - If the monitor has an unusual odor.
  - If the power supply cord or plug is damaged.
  - If liquid has spilled or objects have fallen into the monitor.
  - If the monitor has been exposed to rain or water.
  - If the monitor has been dropped or the cabinet has been damaged.
  - If the monitor does not operate normally by following operating instructions.



### CAUTION

- Allow adequate ventilation around the monitor so that heat can properly dissipate. Do not block ventilated openings or place the monitor near a radiator or other heat sources.
- Do not put anything on top of the monitor.
- The power cable connector is the primary means of detaching the system from the power supply. The monitor should be installed close to a power outlet which is easily accessible.
- Handle with care when transporting. Save packaging for transporting.
- Handle with care during installation and adjustment to prevent personal injury and damage to the monitor.
- Do not connect headphones to the monitor while you are wearing them. Depending on the volume level, it may damage your ears and cause loss of hearing.
- Please tighten all screws. A loose screw may cause the monitor to fall off the arm or stand.
- Do not touch the LCD panel surface while transporting, mounting and setting. Applying pressure on the LCD panel can cause serious damage.

**Image Persistence:** Image persistence occurs when a residual or “ghost” image of a previous image remains visible on the screen. Unlike CRT monitors, LCD monitors’ image persistence is not permanent, but a still image being displayed for a long period of time should be avoided.

To alleviate image persistence, turn off the monitor for as long as the previous image was displayed. For example, if an image was on the monitor for one hour and a residual image remains, the monitor should be turned off for one hour to erase the image.

**NOTE:** As with all personal display devices, NEC DISPLAY SOLUTIONS recommends using a moving screen saver at regular intervals whenever the screen is idle, or turn off the monitor when not in use.

**CORRECT PLACEMENT AND ADJUSTMENT OF THE MONITOR CAN  
REDUCE EYE, SHOULDER, AND NECK FATIGUE. CHECK THE  
FOLLOWING WHEN YOU POSITION THE MONITOR:**

**Ergonomics**

To realize the maximum ergonomics benefits, we recommend the following:

- For optimum performance of the monitor, allow 20 minutes for warming up. Avoid reproduction of still patterns on the monitor for long periods of time to avoid image persistence (after image effects).
- Adjust the monitor height so that the top of the screen is at or slightly below eye level. Your eyes should look slightly downward when viewing the middle of the screen.
- Position your monitor no closer than 40 cm (15.75 inches) and no further away than 70 cm (27.56 inches) from your eyes. The optimal distance is 50 cm (19.69 inches).
- Rest your eyes periodically for 5 to 10 minutes for every 1 hour by focusing on an object at least 20 feet away.
- Position the monitor at a 90° angle to windows and other light sources to minimize glare and reflections. Adjust the monitor tilt so that ceiling lights do not reflect on your screen.
- If reflected light makes it hard for you to see your screen, use an anti-glare filter.
- Adjust the monitor's brightness and contrast controls to enhance readability.
- Use a document holder placed close to the screen.
- Position whatever you are looking at most of the time (the screen or reference material) directly in front of you to minimize turning your head while you are typing.
- Blink often. Eye exercise helps to reduce eye strain. Please contact your ophthalmologist. Get regular eye checkups.
- To avoid eye fatigue, adjust the brightness to a moderate setting. Place a sheet of white paper next to the LCD screen for luminance reference.
- Do not position the Contrast control to its maximum setting.
- Use the preset Size and Position controls with standard signals.
- Use the preset Color Setting.
- Use non-interlaced signals.
- Do not use primary color blue on a dark background, as it is difficult to see and may produce eye fatigue due to insufficient contrast.
- Suitable for entertainment purposes at controlled luminous environments, to avoid disturbing reflections from the screen.

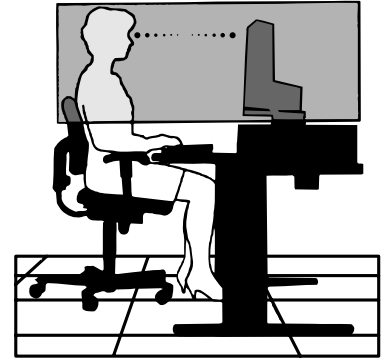

**Cleaning the LCD Panel**

- When the LCD is dusty, please gently wipe with a soft cloth.
- Clean the LCD monitor surface with a lint-free, non-abrasive cloth. Avoid using any cleaning solution or glass cleaner!
- Please do not rub the LCD panel with hard or coarse material.
- Please do not apply pressure to the LCD surface.
- Please do not use OA cleaner as it will cause deterioration or discoloration on the LCD panel surface.

**Cleaning the Cabinet**

- Unplug the power supply
- Gently wipe the cabinet with a soft cloth
- To clean the cabinet, dampen the cloth with a neutral detergent and water, wipe the cabinet and follow with a dry cloth.

**NOTE:** DO NOT clean with benzene thinner, alkaline detergent, alcoholic system detergent, glass cleaner, wax, polish cleaner, soap powder, or insecticide. Rubber or vinyl should not be in contact with the cabinet for an extended period of time. These types of fluids and materials can cause the paint to deteriorate, crack or peel.

For more detailed information on setting up a healthy work environment, write to the American National Standard for Human Factors Engineering of Computer Workstations - ANSI/HFES 100-2007 - The Human Factors Society, Inc. P.O. Box 1369, Santa Monica, California 90406.

# Parts Name and Functions

## Control Panel

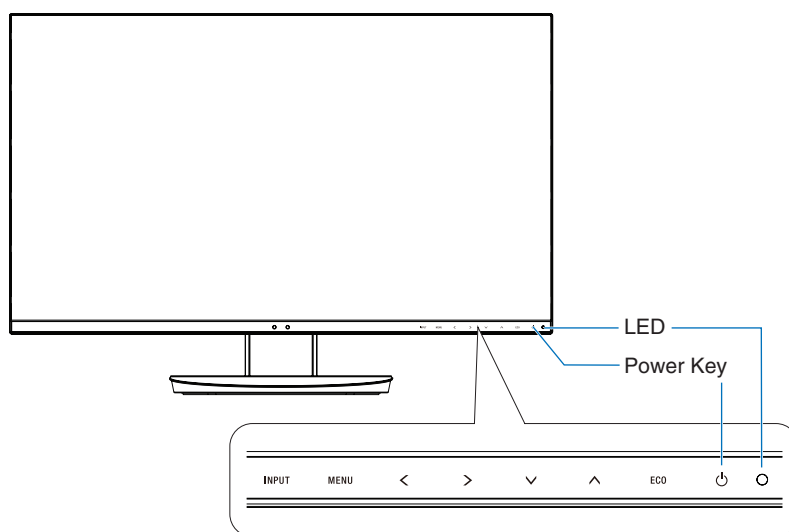

## Control Keys

Refer to the **Controls** section. See [page 13](#).

## Terminal Panel

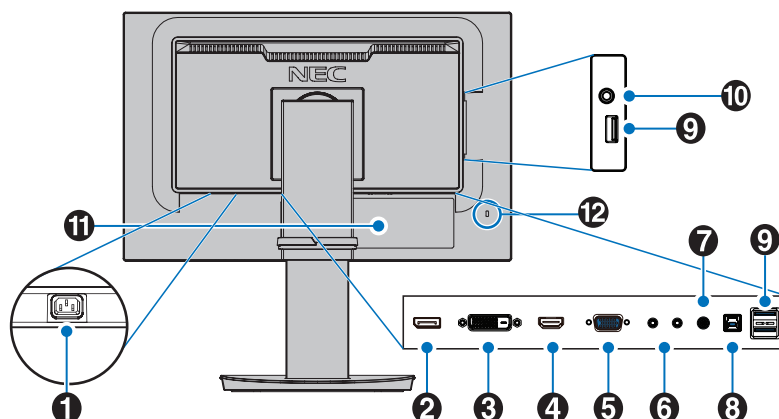

### ① AC IN Connector

Connects with the supplied power cord.

### ② DisplayPort IN

DisplayPort signals input.

### ③ DVI-D IN

DVI signals input.

### ④ HDMI IN

HDMI signals input.

### ⑤ VGA IN (mini D-Sub 15-pin)

Analog RGB signals input.

### ⑥ ControlSync IN/OUT

Connects with the supplied ControlSync cable. See [page 11](#).

### ⑦ Audio IN

Audio signal input from external equipment such as a computer or player.

### ⑧ USB Upstream Port (Type-B)

Connects with external equipment such as a computer. Please use this port to control the monitor from connected external equipment.

### ⑨ USB Downstream Port (Type-A)

Connects with USB devices. Connects with external equipment such as a computer compliant with USB.

### ⑩ Headphone Jack

Connects with headphones.

### ⑪ Rating Label

### ⑫ Security Slot

Security and theft protection lock slot compatible with Kensington cables/equipment. For products visit Kensington's website.

# Quick Start

For box contents, please refer the printed contents sheet provided in the box.

To attach the base to the LCD monitor stand:

1. Place the monitor face down on a non-abrasive surface (**Figure 1**)
2. Please rotate the stand 90 degrees as shown in **Figure 1**.

**CAUTION:** Handle with care when pulling the stand. It may pinch your fingers.

3. Attach the base to the stand, then tighten the screw at the base's bottom (**Figure 2**).

**NOTE:** Reverse this procedure if you need to re-pack the monitor.

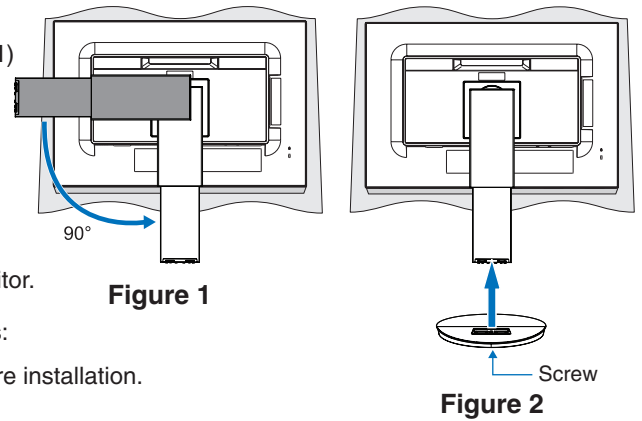

To connect the LCD monitor to your system, follow these instructions:

**NOTE:** Make sure to read "Recommended Use" ([page 3](#)) before installation.

**CAUTION:** Please tighten all screws.

**NOTE:** The accessories included will depend on the location where the LCD monitor was shipped.

1. Turn off the power for your computer.
2. **For a PC with DisplayPort output:** Connect the DisplayPort cable to the connector of the display card in your system (**Figure A.1**).

**For a PC with HDMI output:** Connect the HDMI cable to the connector of the display card in your system (**Figure A.2**).

**For a PC with Analog output:** Connect a mini D-Sub 15-pin signal cable to the connector of the display card in your system (**Figure A.3**). Tighten all screws.

**For a Mac or PC with Thunderbolt or Mini DisplayPort output:** Connect a Mini DisplayPort to DisplayPort cable to the video output connector on your system (**Figure A.4**).

**For a PC or MAC with DVI digital output:** Connect the DVI signal cable to the connector of the display card in your system (**Figure A.5**). Tighten all screws.

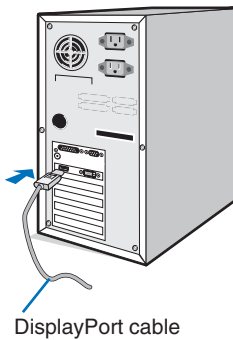

**Figure A.1**

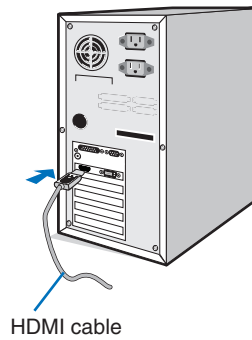

**Figure A.2**

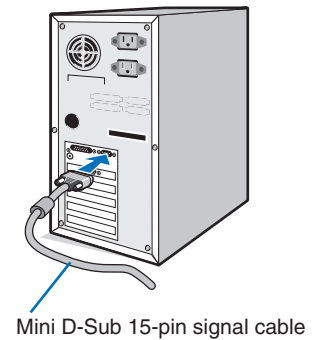

**Figure A.3**

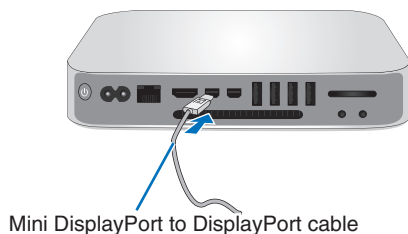

**Figure A.4**

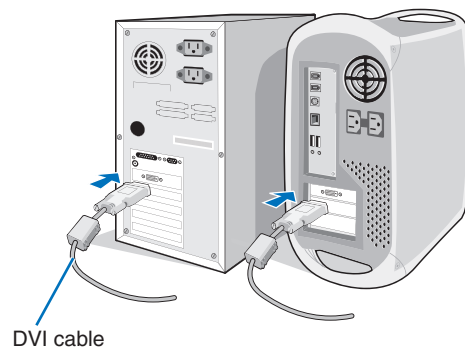

**Figure A.5**

**NOTE:**

- When removing the DisplayPort cable, hold down the top button to release the lock.
- Please use a High Speed HDMI cable with the HDMI logo.
- Please use a certified DisplayPort cable.

**CAUTION:** Use the provided specified cables with this monitor so as not to interfere with radio and television reception. For DVI-D and mini D-Sub 15-pin, please use a shielded signal cable with ferrite core. For HDMI, DisplayPort, USB and AUDIO, please use a shielded signal cable. Use of other cables and adapters may cause interference with radio and television reception.

- Place your hands on each side of the monitor screen, tilt the screen to the maximum tilt angle, then lift the screen to the highest position.
- Connect all cables to the appropriate connectors (**Figure C.1**). When using the USB cable, connect the B-type connector to the USB upstream port on the rear side of the monitor and the A-type connector to the downstream port on the computer (**Figure C.1a**). If using the cord from a USB device, plug it into the downstream port of the monitor.

**NOTE:** Incorrect cable connections may cause abnormal operation, damage display quality/components of the LCD panel and/or shorten the module's life.

**⚠ CAUTION:** Do not bind the USB cable. It may trap heat and start a fire.

**NOTE:** Do not use an attenuating (built-in resistor) audio cable. Using an audio cable with a built-in resistor will lower the sound level.

**NOTE:** Adjustment of the volume control as well as the equalizer to settings other than the center position may increase the ear-/headphones output voltage and therefore the sound pressure level.

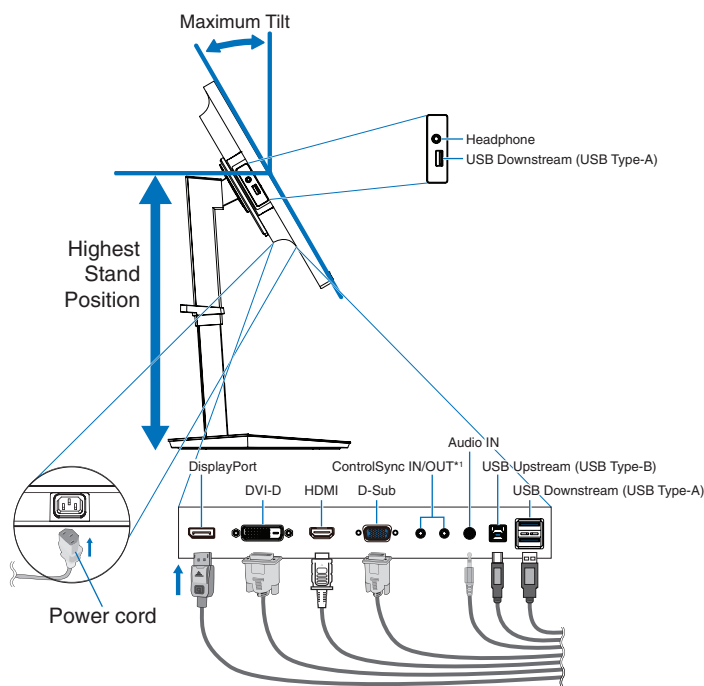

**Figure C.1**

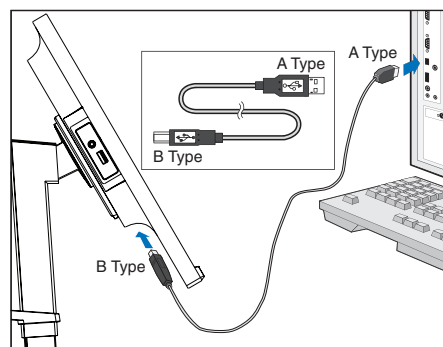

**Figure C.1a**

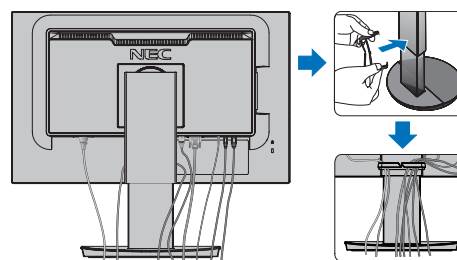
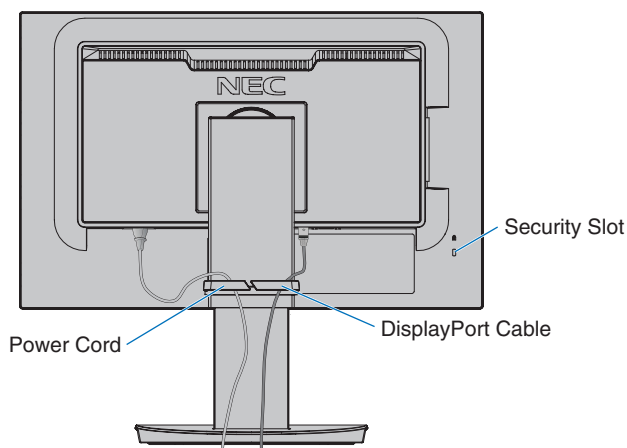

**Figure C.2**

\*1: See [page 11](#).

**⚠ CAUTION:** Do not connect headphones to the monitor while you are wearing them. Depending on the volume level, it may damage your ears and cause loss of hearing.

- Place the cable holder onto the stand (**Figure C.2**). Place the cables in the cable holder firmly and evenly (**Figure C.3** and **Figure C.4**).
- Please check that you can still raise and lower the monitor screen after you have installed the cables.



**Figure C.3**

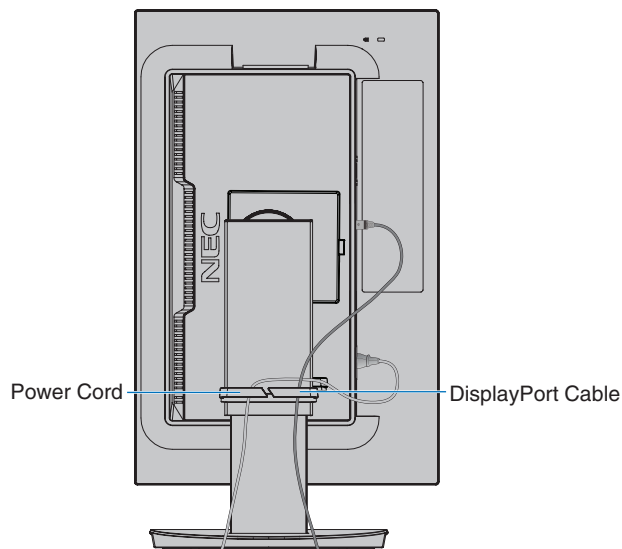

**Figure C.4**

7. Connect the power cord to the power outlet.

**NOTE:** Please refer to the **CAUTION** section of this manual for proper selection of the AC power cord.

8. Turn on the monitor by touching the [⏻] key and then turn on the computer (**Figure E.1**).

9. When using analog (VGA) input, No Touch Auto Adjust automatically adjusts the monitor to optimal settings upon initial setup. For further adjustments, use the following OSD controls:

- [AUTO CONTRAST]
- [AUTO ADJUST]

Refer to the **Controls** section of this User's Manual for a full description of these OSD controls.

**NOTE:** If you have any problems, please refer to the **Troubleshooting** section of this User's Manual.

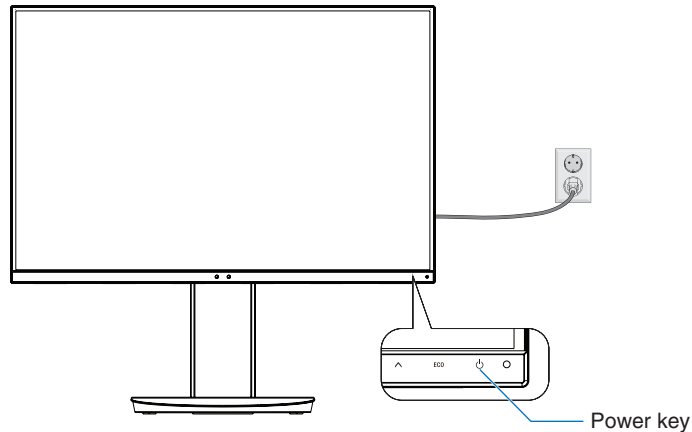

**Figure E.1**

## Adjustable stand with pivot capability

**Raise and Lower:** Hold the monitor screen on each side and lift or lower to the desired height.

**Tilt and Swivel:** Hold the top and bottom sides of the monitor screen with your hands and adjust the tilt and swivel as desired.

**Screen Rotation (Pivot):** Hold each side of the monitor screen, lift to its maximum height and tilt to its maximum tilt angle, then rotate the screen from landscape to portrait.

You can adjust the OSD (On-Screen Display) menu rotation to match the screen rotation. Refer to the [OSD ROTATION] instructions (see [page 18](#)).

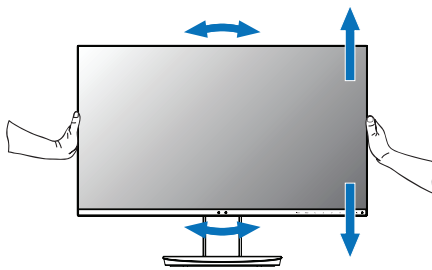

**Rotation, Raise and Lower**

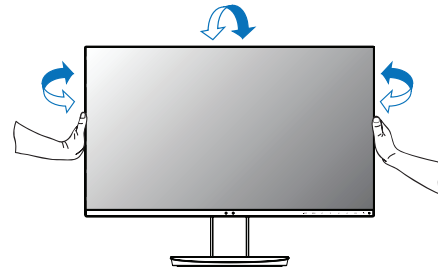

**Tilt and Swivel**

**⚠ CAUTION:** Handle with care when adjusting the monitor screen. Do not apply pressure to the LCD when adjusting the height and rotating the monitor screen. Before rotating, disconnect the power cord and all cables from the display. The screen must be raised to the highest level and adjusted to maximum tilt to avoid knocking the screen on the desk or pinching your fingers.

## Flexible Arm Installation

This LCD monitor is designed for use with a flexible arm. Contact NEC for more information.

To prepare the monitor for alternate mounting purposes:

- Follow the instructions provided by the manufacturer of the display mount.
  - ▲ **CAUTION:** To meet the safety requirements, the monitor must be mounted to an arm that supports the weight of the monitor. See the [Specifications - EA231WU](#) and [Specifications - EA241F](#) page for details. Remove the monitor stand before mounting.

### Remove the Monitor Stand for Mounting

To prepare the monitor for alternate mounting purposes:

1. Disconnect all cables.
2. Place your hands on each side of the monitor screen and lift up to the highest position.
3. Place the monitor face down on a non-abrasive surface (**Figure S.1**).
4. Place one hand around the base and one hand on the Quick Release Button. Push and hold the Quick Release Button in the direction indicated by the arrow (**Figure S.1**).
5. Lift up the stand to unhook it from the monitor (**Figure S.1**).  
The monitor can now be mounted using an alternate method.  
Reverse the process to reattach the stand.

**NOTE:** Handle with care when removing the monitor stand.

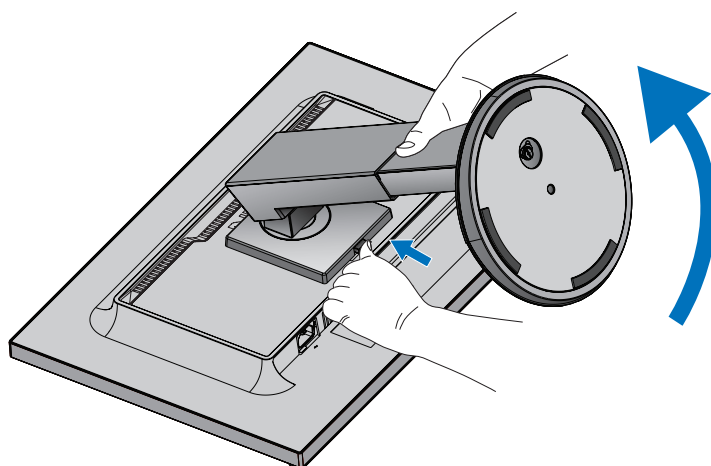
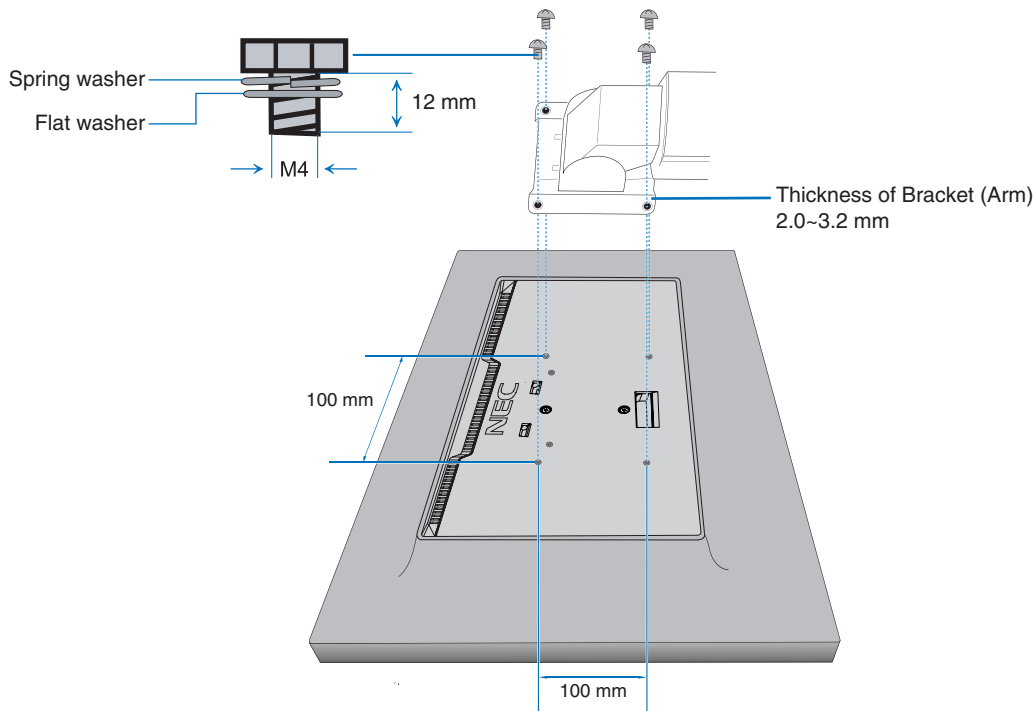

Figure S.1

## Mount Flexible Arm

This LCD monitor is designed for use with a flexible arm.

1. Follow the instructions in how to **Remove the Monitor Stand for Mounting**.
2. Using 4 screws that meet the specifications listed below, attach the arm to the monitor (**Figure F.1**).

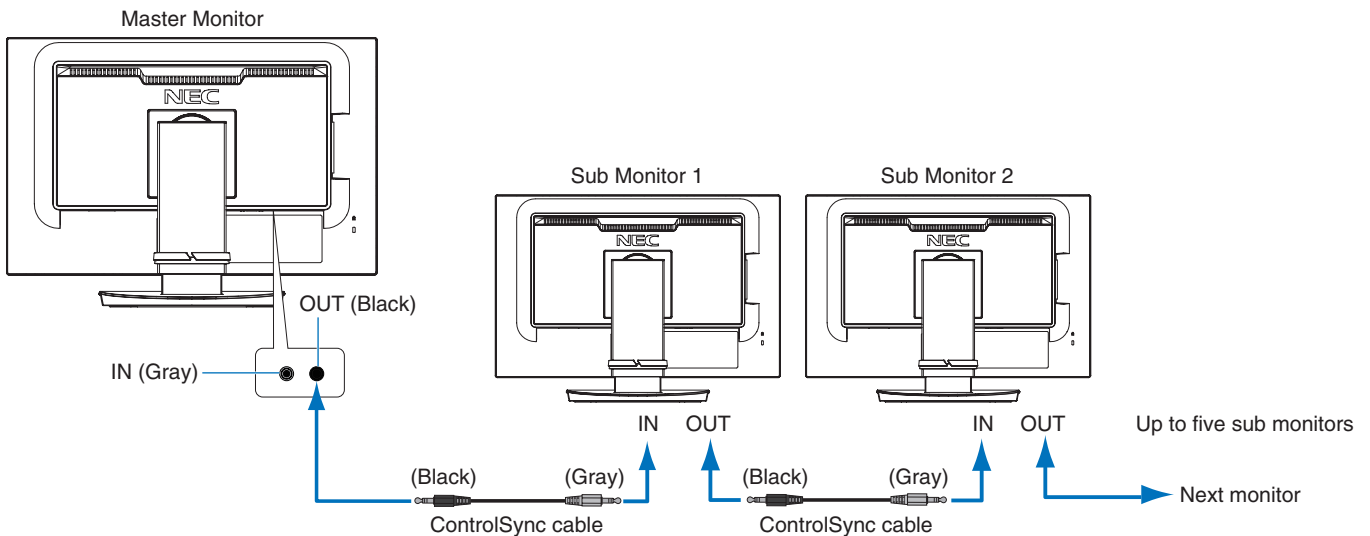

**Figure F.1**



- ⚠ CAUTION:**
- Only use 4 M4 sized screws when mounting to avoid damage to the monitor and stand.
  - To meet the safety requirements, the monitor must be mounted to an arm, which guarantees the necessary stability under consideration for the weight of the monitor. The LCD monitor should only be used with an approved arm (e.g. TUEV GS mark).
  - Tighten all screws (recommended Fasten Force: 98 - 137N•cm).  
A loose screw may cause the monitor to fall off the arm.
  - Attaching the flexible arm should be done by two or more people if the monitor cannot be placed face down on a flat surface for installation.

# ControlSync

ControlSync simultaneously controls all sub monitors connected to a master monitor. It can also individually control a single sub monitor using the [INDIVIDUAL ADJUST] function. Please refer to the figure below.



**NOTE:** The ControlSync icon will appear on the upper left of the OSD menu in the sub monitors. Do not connect the ControlSync ports IN-to-IN or OUT-to-OUT. The monitors' ControlSync ports must be connected OUT-to-IN. Do not make a "loop" connection by connecting the last monitor in the chain back to the master monitor. Turn off the power and disconnect the power cables for all monitors. Connect the ControlSync cables, then connect the power cables, and then turn on the power for each monitor.





## Controlling all connected sub monitors (Synchronized control):

1. Connect a ControlSync cable (ø 2.5) to the master monitor's ControlSync OUT port and into a sub monitor's ControlSync IN port. Up to five monitors can be daisy-chained together by connecting the monitors to each other via the ControlSync OUT to IN ports on the monitors.
2. Follow the steps for [DATA COPY] (see page 19). When a setting for the master monitor is adjusted, it will be copied and sent to the connected sub monitor(s) automatically.

## Controlling a target monitor (Individual Adjust):

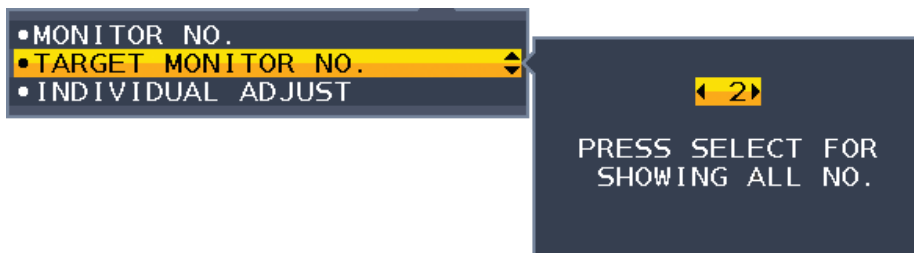
1. Touch the [MENU] key to show the OSD menu on the master monitor.
2. Touch the [>] key to enter the [MULTI DISPLAY] control. When the cursor is on [TARGET MONITOR NO.], a sub monitor number menu opens. Use the [<] or [>] key to select the sub monitor number. If you touch the [INPUT/SELECT] key, each sub monitor displays its monitor number.



3. Touch the [✓] or [^] key to select [INDIVIDUAL ADJUST] and then set it to [ON]. Control the sub monitor's OSD using the master monitor's control keys.

**NOTE:** To disable [INDIVIDUAL ADJUST], touch the [INPUT] and [MENU] keys simultaneously.

The following settings can be controlled by ControlSync:

		Synchronized control	Individual adjust
ECO TOOLS	BRIGHTNESS*	Yes	Yes
	CONTRAST	No	Yes
	ECO MODE	Yes	Yes
	AUTO BRIGHTNESS	Yes	Yes
	BLACK LEVEL	No	Yes
	OFF MODE SETTING	Yes	Yes
	OFF MODE SENSOR SETTING	Yes	Yes
	OFF MODE START TIME	Yes	Yes
	HUMAN SENSING	Yes	Yes
	HUMAN SENSOR SETTING	Yes	Yes
	HUMAN SENSOR START TIME	Yes	Yes
	DV MODE	Yes	Yes
SCREEN	AUTO ADJUST	No	Yes
	AUTO CONTRAST	No	Yes
	LEFT/RIGHT	No	Yes
	DOWN/UP	No	Yes
	H.SIZE	No	Yes
	FINE	No	Yes
	INPUT RESOLUTION	No	Yes
	VIDEO LEVEL	No	Yes
	OVER SCAN	No	Yes
EXPANSION	Yes	Yes	
COLOR	Color Control System	Yes	Yes
	R, G, B, color gain	No	Yes
TOOLS	VOLUME	Yes	Yes
	SOUND INPUT	No	Yes
	VIDEO DETECT	No	Yes
	RESPONSE IMPROVE	No	Yes
	OFF TIMER	Yes	Yes
	POWER SAVE TIMER	No	Yes
	LED BRIGHTNESS	Yes	Yes
	DDC/CI	Yes	Yes
	USB POWER	No	Yes
	FACTORY PRESET	No	Yes
MENU TOOLS	LANGUAGE	Yes	Yes
	OSD TURN OFF	Yes	Yes
	OSD LOCK OUT	Yes	Yes
	OSD ROTATION	No	Yes
	HOT KEY	Yes	Yes
	SIGNAL INFORMATION	Yes	Yes
	SENSOR INFORMATION	Yes	Yes
	KEY GUIDE	Yes	Yes
	DATA COPY	No	No
CUSTOMIZE SETTING	No	Yes	
MULTI DISPLAY	MONITOR NO.	No	No
	TARGET MONITOR NO.	No	No
	INDIVIDUAL ADJUST	No	No
ECO INFORMATION	CARBON SAVINGS	No	No
	CARBON USAGE	No	No
	COST SAVINGS	No	No
	CARBON CONVERT SETTING	Yes	Yes
	CURRENCY SETTING	Yes	Yes
	CURRENCY CONVERT SETTING	Yes	Yes

Other settings:

- Power Control (DC switch)
- Ambient Light Sensor
- Human Sensor Result
- Audio Mute

**NOTE:** Only the master monitor's human sensor and ambient light sensor are active. Please do not cover these sensors (See [page 13](#)).

After connecting all power cables and ControlSync cables, check that ControlSync operates correctly by turning the master monitor's power off then back on.

Do not use the ControlSync connectors for any purpose other than specified.

\* This value is not a directly adjusted output value. This is adjusted relatively.

# Controls

OSD (On-Screen Display) control keys on the front of the monitor function as follows:

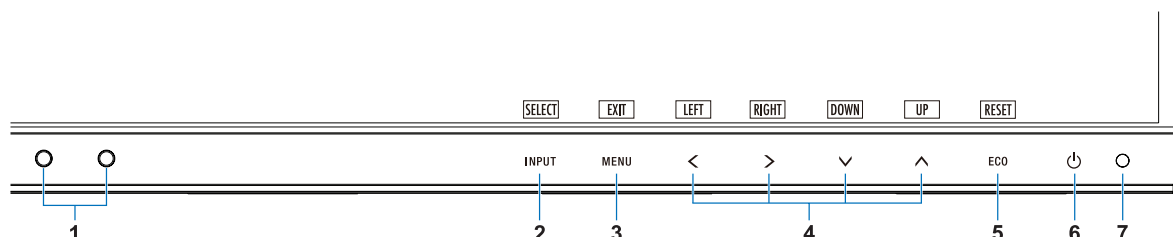

1 Ambient Light Sensor Human Sensor	Detects the level of ambient lighting and the presence of a user, allowing the monitor to make adjustments to various settings resulting in a more comfortable viewing experience. Do not cover this sensor.
2 INPUT/SELECT	Enters sub menus in the OSD menu when the OSD menu is displayed on the screen. Shows a switching menu for the input source when the OSD menu is not displayed on the screen. You can directly change to the [L/B] (LOW BLUE LIGHT) mode by touching this key for 3 seconds or more when the OSD menu is not open.*1
3 MENU/EXIT	Opens the OSD menu. Closes the OSD sub menus and main menu. You can restore the saved settings in the [CUSTOMIZE SETTING] by touching this key for 3 seconds or more when the OSD menu is not open.
4 LEFT/RIGHT/ UP/DOWN*2	When the OSD menu is displayed on the screen, navigates through the OSD menu. When the OSD menu is not displayed on the screen, touch one of the following keys to open the menu for the function indicated.*1 [^] key: [BRIGHTNESS] [v] key: [VOLUME]
5 ECO/RESET	When the OSD menu is displayed on the screen, this key sends a reset command for the OSD settings. When the OSD menu is not displayed on the screen, this key switches the [ECO MODE] status. You can set a mode from [OFF], [1] and [2].*1 Activates the [AUTO ADJUST] function by touching this key for 3 seconds or more when the OSD menu is not open (analog input only)*1.
6 Power	Turns the monitor on and off.
7 Power LED	Indicates that the power is on or off.

\*1 When the [HOT KEY] function is [OFF], this function is disabled.

\*2 Depending on the [OSD ROTATION] setting, [LEFT], [RIGHT], [UP] and [DOWN] key guides are displayed at the [<], [>], [v], [^] keys differently (See [page 18](#)).



## ECO TOOLS

### BRIGHTNESS

Adjusts the overall image and background screen brightness.

If [ECO MODE] is set to [1] or [2], a bar for [CARBON FOOTPRINT] will appear.

### CONTRAST

Adjusts the overall image and background screen brightness by input signal level.

**NOTE:** When [L/B] is selected in the [Color Control System], [CONTRAST] is disabled.

## ECO MODE

Decreases the amount of power consumption by reducing the brightness level.

**OFF:** Does not function.

**1:** Sets the brightness variable range from 0% to 70%.

This setting can adjust brightness to a range in which power is reduced by 15% compared to the maximum brightness setting.

**2:** Sets the brightness variable range from 0% to 30%.

This setting can adjust brightness to a range in which power is reduced by 35% (EA231WU)/40% (EA241F) compared to the maximum brightness setting.

When this function is set to [ON], a [CARBON FOOTPRINT] bar will appear alongside the [BRIGHTNESS] adjustment bar.

**NOTE:** This function is disabled when [DV MODE] (See [page 15](#)) is set to [DYNAMIC].

This function is disabled when [Color Control System] is set to [DICOM SIM.].

To enter the [ECO MODE], touch the [ECO] key.

When you touch the [ECO] key, the setting cycles through [1] → [2] → [OFF] → [1].

## AUTO BRIGHTNESS

**OFF:** Does not function.

**ON (AMBIENT LIGHT):** Automatically adjusts the brightness to the optimal setting by detecting the brightness level of the environment.\*1

\*1: Please refer to [page 28](#) for full "Auto Brightness" information.

**NOTE:** This function is disabled when [DV MODE] is set to [DYNAMIC].

This function is disabled when [Color Control System] is set to [DICOM SIM.].

## BLACK LEVEL

Adjusts the brightness level of black when displayed on screen.

## OFF MODE SETTING

The Intelligent Power Manager allows the monitor to enter into power saving mode after a period of inactivity.

**OFF:** The monitor enters into power saving mode automatically when the input signal is lost.

**ON:** The monitor enters into power saving mode automatically when the amount of surrounding light goes below the level determined by you. The level can be adjusted in the [OFF MODE SENSOR SETTING].

When in power saving mode, the LED on the front of the monitor becomes dark blue. When in power saving mode, touch any of the front keys, except for [⏻] and [INPUT] keys, to return to normal mode.

When the amount of surrounding light returns to normal levels, the monitor will automatically return to normal mode.

## SENSOR SETTING (OFF MODE SETTING)

Adjusts the threshold level for the ambient light sensor for detecting low light conditions and shows the current sensor measurement result.

## START TIME (OFF MODE SETTING)

Adjusts the wait time to enter into a lower power consumption level when the ambient light sensor detects low light conditions.

## HUMAN SENSING

The sensor detects the movement of a person by using the [HUMAN SENSING] function. The [HUMAN SENSING] function has three settings:

**OFF:** Does not function.

**1 (LIGHT):** After it detects that there is no person during a period of time, the monitor shifts to low brightness mode automatically to reduce the power consumption. When a person comes near the monitor again, the monitor will automatically return to normal mode. [START TIME] adjusts the period of time to wait before entering low brightness mode.

**2 (DEEP):** After it detects that there is no person, the monitor shifts to power saving mode automatically to reduce the power consumption. When a person comes near the monitor again, it resumes from the power saving mode.

**NOTE:** Detects a person within about 1.5 m from the monitor.

## SENSOR SETTING (HUMAN SENSING)

Adjusts the threshold level of [HUMAN SENSING].

When the human icon is located on the right side of the white color bar or vermilion color wave, a person is not detected.

**NOTE:** The [HUMAN SENSING] function starts after the OSD menu is closed.

## START TIME (HUMAN SENSING)

Adjusts the wait time before entering to low brightness mode or power saving mode when the Human Sensor detects no person.

## DV MODE

Dynamic Visual Mode allows you to select from the following settings:

**STANDARD:** Standard setting.

**TEXT:** Setting that makes letters and lines crisp; best suited for basic word processing and spreadsheets.

**MOVIE:** Setting that boosts dark tones; best suited for movies.

**GAMING:** Setting that boosts whole tones; best suited for games that use vivid, colorful images.

**PHOTO:** Setting that optimizes contrast; best suited for still images.

**DYNAMIC:** Setting that adjusts the brightness by detecting the screen's black areas and optimizes it.

**NOTE:** This function is disabled when [Color Control System] is set to [L/B], [PROGRAMMABLE] or [DICOM SIM.].  
[STANDARD] is used for TCO Certificate compliance.



## SCREEN

### AUTO ADJUST (Analog input only)

Automatically adjusts the image position, the [H.SIZE] and [FINE] settings.

### AUTO CONTRAST (Analog input only)

Adjusts the image displayed for non-standard video inputs.

### LEFT / RIGHT (Analog input only)

Controls horizontal image position within the display area of the LCD.

### DOWN / UP (Analog input only)

Controls vertical image position within the display area of the LCD.

### H.SIZE (Analog input only)

Adjusts the horizontal size by increasing or decreasing the setting.

If the [AUTO ADJUST] function does not give you a satisfactory picture setting, additional tuning can be performed by using the [H.SIZE] function (dot clock). A Moiré test pattern can be used for this. This function may alter the width of the picture. Use the [<] or [>] key to center the image on the screen. If the [H.SIZE] is incorrectly calibrated, the result would look like the left drawing. The image should be homogeneous.

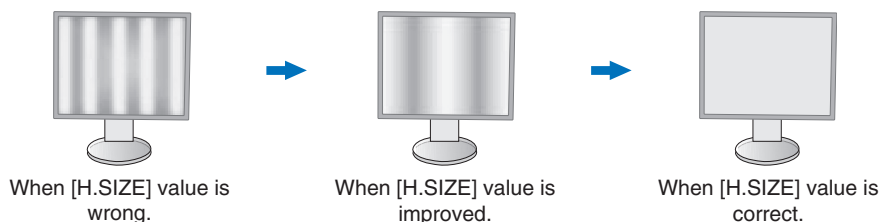

## FINE (Analog input only)

Improves focus, clarity and image stability by increasing or decreasing the setting.

If the [AUTO ADJUST] and [H.SIZE] functions do not give you a satisfactory picture setting, fine tuning can be performed by using the [FINE] function.

A Moiré test pattern can be used for this. If the [FINE] value is incorrectly calibrated, the result would look like the left drawing. The image should be homogeneous.

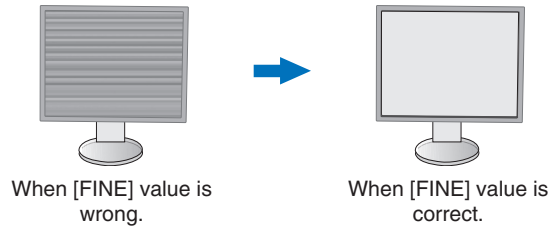

## INPUT RESOLUTION (Analog input only)

Selects one of the following pair of resolutions as the input signal priority:

1360 x 768 or 1280 x 768 (vertical resolution 768),  
1600 x 900 or 1280 x 960 (horizontal frequency 60kHz),  
1680 x 1050 or 1400 x 1050 (vertical resolution 1050).

## VIDEO LEVEL (HDMI input only)

**NORMAL:** Setting for use with a computer. Displays all input signals of 0-255 steps.

**EXPAND:** Setting for use with audio visual equipment. Expands input signals of 16-235 steps to 0-255 steps.

## OVER SCAN (HDMI input only)

Some video formats may require different scanning modes in order to best display the image.

**ON:** Image size is larger than what can be displayed. The image edge will appear cropped. Approximately 95% of the image will be shown on the screen.

**OFF:** Image size stays within the display area. The whole image is displayed on the screen.

## EXPANSION

Sets the zoom method.

**FULL:** The image is expanded to full screen regardless of the resolution.

**ASPECT:** The image is expanded without changing the aspect ratio.

**Note:** The resolution of 1280x768, 1360x768, 1280x720 and 1920x1080 are always [FULL] (EA231WU only).



## Color

**Color Control System:** Color presets are available for adjusting color settings.

**1, 2, 3, 4, 5:** Increases or decreases the [RED], [GREEN] or [BLUE] color depending upon which is selected.

The change in color will appear on screen and the direction (increase or decrease) will be shown by the bars.

sRGB (color preset mode [4]) dramatically improves the color fidelity in the desktop environment by a single standard RGB color space. With this color-supported environment, the operator could easily and confidently communicate color without further color management overhead in most common situations.

**NATIVE:** The LCD panel's original colors that cannot be adjusted.

**L/B (LOW BLUE LIGHT):** Reduces blue light emitted from monitor. This item cannot be adjusted.

**NOTE:** You can directly change to [L/B] (LOW BLUE LIGHT) mode by touching the [INPUT] key for 3 seconds or more. For changing to other settings from [L/B] mode, touch the [MENU] key to show OSD menu and enter [Color Control System].

When [L/B] is selected in [Color Control System], [CONTRAST] and [DV MODE] are disabled.

**DICOM SIM.:** The white point color temperature and the gamma curve are set to a DICOM simulation. This item cannot be adjusted.

**PROGRAMMABLE:** The gamma curve is adjustable through application software.

**NOTE:** When [MOVIE], [GAMING] or [PHOTO] is selected as the [DV MODE], [NATIVE] is selected automatically and cannot be changed.



## Tools

### VOLUME

Controls the volume of the speakers or headphones.  
To mute the speaker output touch the [ECO/RESET] key.

### SOUND INPUT (HDMI, DisplayPort inputs only)

Selects the sound input source.

### VIDEO DETECT

Selects the method of video detection when more than one video input is connected.

**FIRST:** When the current video input signal is not present, the monitor searches for a video signal from the other video input ports. If the video signal is present in another port, the monitor switches the video source input to the detected video source automatically. The monitor will not look for other video signals while the current video source is present.

**NONE:** Video input signal detection is not enabled.

### RESPONSE IMPROVE

Turns the [RESPONSE IMPROVE] function [ON] or [OFF]. This function may reduce blurring that occurs in some moving images.

### OFF TIMER

The monitor will automatically power off after a period of time has passed, which you can set. Before powering off, a message will appear on the screen asking if you want to delay the turn off time by 60 minutes. Touch any OSD key to delay the power-down time.

### POWER SAVE TIMER

[POWER SAVE TIMER] allows the monitor to turn off automatically after 2 consecutive hours in power save mode.

### LED BRIGHTNESS

Adjusts the Power LED brightness.

### DDC/CI

This function turns the [DDC/CI] function [ON] or [OFF].

### USB POWER

Selects how power through the USB port is enabled in relation to the monitor's power status.

**AUTO:** Power is supplied to the USB downstream port depending on the monitor's power condition.

**ON:** Power is always supplied to the USB downstream port even when the monitor is in power save mode or power OFF.

**NOTE:** Power consumption depends on the connected USB device even when a monitor's power is off.

### FACTORY PRESET

Selecting [FACTORY PRESET] allows you to reset all OSD control settings back to the factory settings except [LANGUAGE] and [OSD LOCK OUT]. Individual settings can be reset by touching the [ECO/RESET] key.



## MENU Tools

### LANGUAGE

Selects the language used by the OSD.

### OSD TURN OFF

The OSD menu will stay on as long as it is in use. You can select how long the monitor waits after the last key touch to turn off the OSD menu. The preset choices are 10-120 seconds by 5-second increments.

## OSD LOCK OUT

This control completely locks out access to all OSD control functions except for [BRIGHTNESS], [CONTRAST] and [VOLUME].

To activate the [OSD LOCK OUT] function, enter the OSD menu, select [OSD LOCK OUT], then touch [INPUT/SELECT] and [>] keys simultaneously. To deactivate, touch [INPUT/SELECT] and [<] keys simultaneously.

## OSD ROTATION

This controls the OSD menu rotation.

Depending on the image angle (monitor rotation), select a suitable [OSD ROTATION] setting.

**NOTE:** Please set the [KEY GUIDE] to [ON] to display the key guide.

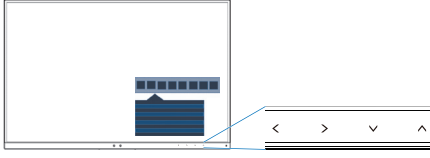
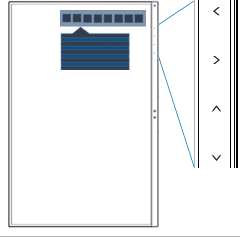
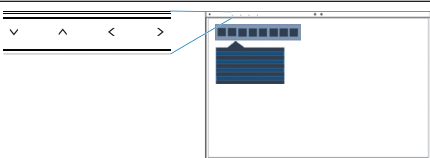
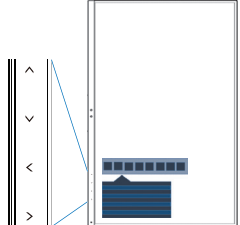
Setting (Angle)	Image	Key guide
0		<: LEFT >: RIGHT v: DOWN ^: UP
90		
180		
270		

## HOT KEY

When this function is [ON], [BRIGHTNESS], [VOLUME] and [ECO MODE] can be changed without entering the OSD menu.

### ON:

**BRIGHTNESS:** Touch the [^] key, then adjust the [BRIGHTNESS] level in the sub menu that opens.

**VOLUME:** Touch the [v] key, then adjust the [VOLUME] level in the sub menu that opens.

**ECO MODE:** Touch the [ECO] key, the [ECO MODE] sub menu opens. You can toggle among 3 selections: [OFF], [1] and [2].

**OFF:** The [HOT KEY] function for the [ECO] key, [^] key and [v] key are disabled.

## SIGNAL INFORMATION

If you select [ON], the monitor displays "VIDEO INPUT" message after changing the input.

If you select [OFF], the monitor doesn't display "VIDEO INPUT" message after changing the input.

## SENSOR INFORMATION

If you select [ON], the monitor displays a "HUMAN SENSOR ON" message. If you select [OFF], the monitor doesn't display the "HUMAN SENSOR ON" message.

## KEY GUIDE

If you select [ON], the Key Guide appears on screen when the OSD menu is accessed.

## DATA COPY

To initiate data copy from the master monitor to the sub monitor(s), select [DATA COPY] and touch the [INPUT/SELECT] key. A “PROCEEDING...” indicator will appear on the screen.

**NOTE:** This function is only intended for the master monitor in ControlSync.  
All of the settings specified in the ControlSync chart (see [page 12](#)) will be copied from the master monitor to the sub monitor(s).

## CUSTOMIZE SETTING

Store the current settings for easy recovery.

**To store current settings:** Touch the [INPUT/SELECT] key. After a warning message appears, touch the [ECO/RESET] key and the current settings are stored.

**To restore settings:** Touch the [MENU] key for 3 seconds or more while the OSD menu is not open.



## MULTI DISPLAY

### MONITOR NO.

This function is for [INDIVIDUAL ADJUST].

Sets the monitor number for each monitor.

Control a sub monitor from the master monitor by [INDIVIDUAL ADJUST]:

This function is for controlling a sub monitor from the master monitor. It is useful if the sub monitor is located at an unreachable spot.

Please set the monitor number for each monitor. If you set a unique number to each of the monitors, you can control a specific monitor. If you set duplicate numbers to some of the monitors, you can control the monitors that have the same number simultaneously.

**NOTE:** A master monitor should be connected only with ControlSync OUT. Do not connect a master monitor with ControlSync IN. See ControlSync for information about master and sub monitors ([page 11](#)).

### TARGET MONITOR NO.

Controls a sub monitor's OSD by using the master monitor's control keys.

Sets the sub monitor number that is set at [MONITOR NO.]. By touching the [INPUT/SELECT] key, each sub monitor displays its monitor number.

### INDIVIDUAL ADJUST

**ON:** Controls an individual sub monitor from the master monitor.

Once [ON] is set, operation at the master monitor reflects to the sub monitor OSD.

To disable [INDIVIDUAL ADJUST], please touch [INPUT] and [MENU] keys simultaneously.

**NOTE:** Please connect monitors with the ControlSync cables.



## ECO Information

**CARBON SAVINGS:** Displays the estimated carbon savings information in kg.

**CARBON USAGE:** Displays the estimated carbon usage information in kg. This is an arithmetic estimation, not actual measurement value.

**COST SAVINGS:** Displays the electricity cost savings in balance.

### CARBON CONVERT SETTING

Adjusts the carbon footprint factor in the carbon saving calculation. This initial setting is based on the OECD data (2008 Edition).

### CURRENCY SETTING

Displays electricity pricing in 6 currency units.

## CURRENCY CONVERT SETTING

Displays electricity savings in kW/hour (US Currency is default).

**NOTE:** This model's initial setting is US Dollar [\$] in [CURRENCY SETTING] and \$ [0.11] in [CURRENCY CONVERT SETTING].

This setting can be changed by using the [ECO INFORMATION] menu.

If you want to use the French setting, please refer to the steps below:

1. Touch the [MENU] key and select the [ECO INFORMATION] menu using the [◀] or [▶] key.
2. Select the [CURRENCY SETTING] item by touching the [▲] or [▼] key.
3. The French currency unit is Euro [€]. You can adjust currency setting to Euro icon [€] from US Dollar [\$] by touching the [◀] or [▶] key in [CURRENCY SETTING] item.
4. Select [CURRENCY CONVERT SETTING] by touching the [▲] or [▼] key\*.
5. Adjust [CURRENCY CONVERT SETTING] by touching the [◀] or [▶] key.

\* This initial Euro [€] setting is based on the OECD data for Germany (2007 Edition). Please check the receipt of electricity prices for France or OECD data for France. The French value according to the OECD data (2007 Edition) was €0.12.



## Information

Provides information about the current display resolution and technical data including the preset timing being used and the horizontal and vertical frequencies. Indicates the model and serial numbers of your monitor.

## OSD Warning

OSD warning messages close by touching the [MENU] key.

**NO SIGNAL:** This function gives a warning when there is no horizontal or vertical sync. After power is turned on or when there is a change of input signal, the “**NO SIGNAL**” window will appear.

**OUT OF RANGE:** This function gives a recommendation of the optimized resolution and refresh rate. After the power is turned on, or there is a change of input signal, or if the video signal doesn't have proper timing, the “**OUT OF RANGE**” message will appear.

# Specifications - EA231WU

Monitor Specifications		MultiSync EA231WU	Notes
LCD Module	Diagonal: Viewable Image Size: Native Resolution (Pixel Count):	57.15 cm/22.5 inches 57.15 cm/22.5 inches 1920 x 1200	Active matrix; thin film transistor (TFT) liquid crystal display (LCD); 0.254 mm (H) x 0.248 mm (V) dot pitch; 250 cd/m <sup>2</sup> white luminance; 1000:1 contrast ratio (typical), (5000:1 Contrast ratio, Dynamic).
Input Signal			
DisplayPort:	DisplayPort Connector:	Digital RGB	DisplayPort V1.1a (HDCP1.3)
DVI:	DVI-D 24pin:	Digital RGB	DVI (HDCP1.4)
VGA:	Mini D-Sub 15-pin:	Analog RGB Sync	0.7 Vp-p/75 ohm Separate sync.TTL level Positive/Negative Composite sync.TTL level Positive/Negative Sync on Green (Video 0.7 Vp-p and Sync Negative 0.3 Vp-p)
HDMI:	HDMI Connector:	Digital YUV Digital RGB	HDMI (HDCP1.4)
Display Colors		16,777,216	
Synchronization Range	Horizontal: Vertical:	31.5 kHz to 75.0 kHz 50 Hz to 60 Hz	Automatically Automatically
Viewing Angle	Left/Right: Up/Down:	±89° (CR > 10) ±89° (CR > 10)	
Response Time		5 ms (Gray to gray Typ.)	
Active Display Area	Landscape: Horiz.: Vert.: Portrait: Horiz.: Vert.:	488.2 mm/19.2 inches 297.2 mm/11.7 inches 297.2 mm/11.7 inches 488.2 mm/19.2 inches	
USB Hub	I/F: Port: Load Current:	USB Specification Revision USB 3.1 Gen 1 Upstream 1 Downstream 3 5 V/0.9 A (Max.)	Upstream port applicable to USB monitor control.
AUDIO			
Audio Input:	STEREO Mini Jack: DisplayPort Connector: HDMI Connector:	Analog Audio Digital Audio Digital Audio	Stereo L/R 500mV rms 20 Kohm PCM 2ch 32, 44.1, 48 kHz (16/20/24bit) PCM 2ch 32, 44.1, 48 kHz (16/20/24bit)
Headphone Output:	STEREO Mini Jack:		Headphone Impedance 32 Ohm
Speakers	Practical Audio Output:	1.0 W + 1.0 W	
ControlSync (available up to 5 sub monitors)	IN: OUT:	Stereo Micro jack 2.5 φ Stereo Micro jack 2.5 φ	
Power Supply		AC 100-240 V, 50/60 Hz	
Current Rating		0.90 - 0.50 A	
Dimensions	Landscape: Portrait:	498.9 mm (W) x 337.2 - 487.2 mm (H) x 250.0 mm (D) 19.6 inches (W) x 13.3 - 19.2 inches (H) x 9.8 inches (D) 319.7 mm (W) x 516.7 - 596.0 mm (H) x 250.0 mm (D) 12.6 inches (W) x 20.3 - 23.5 inches (H) x 9.8 inches (D)	
Stand adjustable range	Height Adjustment: Tilt / Pivot / Swivel:	150 mm/5.91 inches (Landscape orientation) 79.3 mm/3.12 inches (Portrait orientation) Up 35° Down 5° / ± 90° / 340°	
Weight		5.9 kg (13.0 lbs)/Without stand: 3.4 kg (7.5 lbs)	
Environmental Considerations			
	Operating Temperature: Humidity: Altitude:	5°C to 35°C/41°F to 95°F 20% to 80% 0 to 16,404 Feet/0 to 5,000 m	
	Storage Temperature: Humidity: Altitude:	-10°C to 60°C/14°F to 140°F 10% to 85% 0 to 40,000 Feet/0 to 12,192 m	

**NOTE:** Technical specifications are subject to change without notice.

# Specifications - EA241F

Monitor Specifications		MultiSync EA241F	Notes
LCD Module	Diagonal: Viewable Image Size: Native Resolution (Pixel Count):	60.47 cm/23.8 inches 60.47 cm/23.8 inches 1920 x 1080	Active matrix; thin film transistor (TFT) liquid crystal display (LCD); 0.275 mm (H) x 0.275 mm (V) dot pitch; 250 cd/m <sup>2</sup> white luminance; 1000:1 contrast ratio (typical), (5000:1 Contrast ratio, Dynamic).
Input Signal			
DisplayPort:	DisplayPort Connector:	Digital RGB	DisplayPort V1.1a (HDCP1.3)
DVI:	DVI-D 24pin:	Digital RGB	DVI (HDCP1.4)
VGA:	Mini D-Sub 15-pin:	Analog RGB Sync	0.7 Vp-p/75 ohm Separate sync.TTL level Positive/Negative Composite sync.TTL level Positive/Negative Sync on Green (Video 0.7 Vp-p and Sync Negative 0.3 Vp-p)
HDMI:	HDMI Connector:	Digital YUV Digital RGB	HDMI (HDCP1.4)
Display Colors		16,777,216	
Synchronization Range	Horizontal: Vertical:	31.5 kHz to 83.0 kHz 50 Hz to 75 Hz	Automatically Automatically
Viewing Angle	Left/Right: Up/Down:	±89° (CR > 10) ±89° (CR > 10)	
Response Time		5 ms (Gray to gray Typ.)	
Active Display Area	Landscape: Horiz.: Vert.: Portrait: Horiz.: Vert.:	527.0 mm/20.7 inches 296.5 mm/11.7 inches 296.5 mm/11.7 inches 527.0 mm/20.7 inches	
USB Hub	I/F: Port: Load Current:	USB Specification Revision USB 3.1 Gen 1 Upstream 1 Downstream 3 5 V/0.9 A (Max.)	Upstream port applicable to USB monitor control.
AUDIO			
Audio Input:	STEREO Mini Jack: DisplayPort Connector: HDMI Connector:	Analog Audio Digital Audio Digital Audio	Stereo L/R 500mV rms 20 Kohm PCM 2ch 32, 44.1, 48 kHz (16/20/24bit) PCM 2ch 32, 44.1, 48 kHz (16/20/24bit)
Headphone Output:	STEREO Mini Jack:		Headphone Impedance 32 Ohm
Speakers	Practical Audio Output:	1.0 W + 1.0 W	
ControlSync (available up to 5 sub monitors)	IN: OUT:	Stereo Micro jack 2.5 φ Stereo Micro jack 2.5 φ	
Power Supply		AC 100-240 V, 50/60 Hz	
Current Rating		0.90 - 0.50 A	
Dimensions	Landscape: Portrait:	537.7 mm (W) x 336.6 - 486.6 mm (H) x 250.0 mm (D) 21.2 inches (W) x 13.3 - 19.2 inches (H) x 9.8 inches (D) 319.1 mm (W) x 555.6 - 615.4 mm (H) x 250.0 mm (D) 12.6 inches (W) x 21.9 - 24.2 inches (H) x 9.8 inches (D)	
Stand adjustable range	Height Adjustment: Tilt / Pivot / Swivel:	150 mm/5.91 inches (Landscape orientation) 59.8 mm/2.35 inches (Portrait orientation) Up 35° Down 5° / ± 90° / 340°	
Weight		6.1 kg (13.4 lbs)/Without stand: 3.6 kg (7.9 lbs)	
Environmental Considerations			
Operating Temperature:		5°C to 35°C/41°F to 95°F	
Humidity:		20% to 80%	
Altitude:		0 to 16,404 Feet/0 to 5,000 m	
Storage Temperature:		-10°C to 60°C/14°F to 140°F	
Humidity:		10% to 85%	
Altitude:		0 to 40,000 Feet/0 to 12,192 m	

**NOTE:** Technical specifications are subject to change without notice.

## Major Supported Timings (EA231WU)

Resolution		Vertical Frequency	Notes
H	V		
640	x 480	60 Hz	
720	x 480	60 Hz	
720	x 576	50 Hz	
800	x 600	56/60 Hz	
1024	x 768	60 Hz	
1280	x 720	50/60 Hz	
1280	x 960	60 Hz	
1280	x 1024	60 Hz	
1440	x 900	60 Hz	
1600	x 1200	60 Hz	
1680	x 1050	60 Hz	
1920	x 1080	50/60 Hz	
1920	x 1200	60 Hz	Recommend

## Major Supported Timings (EA241F)

Resolution		Vertical Frequency	Notes
H	V		
640	x 480	60/72/75 Hz	
720	x 400	70 Hz	
720	x 480	60 Hz	
720	x 576	50 Hz	
800	x 600	50/60/72/75 Hz	
1024	x 768	60/70/75 Hz	
1280	x 720	50/60 Hz	
1280	x 960	60/75 Hz	
1280	x 1024	60/75 Hz	
1440	x 900	60 Hz	
1680	x 1050	60 Hz	
1920	x 1080	50/60 Hz	Recommend (60 Hz)

**NOTE:** When the selected monitor resolution is not a native panel resolution, the text contents appearance in the monitor screen is expanded in a horizontal or vertical direction to show the non-native resolution to full screen. This expansion is done by interpolated resolution technologies, which are normal and widely used in flat panel devices.

# Features

---

**3-side Narrow Bezel:** Stylish appearance and less distance between adjacent screens in a multi-monitor setup.

**Fully Ergonomic Stand:** Provides viewing flexibility with 150 mm height adjustment, -5 ~ 35-degree tilt, 340-degree swivel, with cable management and a small footprint. The ability to pivot to either side can minimize width between adjacent bezels in multi-monitor installations. The bottom of the monitor cabinet can touch the stand base for lower positioning requirements.

**ErgoDesign Features:** Enhance human ergonomics to improve the working environment, protect the health of the user and save money. The ergonomic features include a fully articulating stand, OSD controls that can rotate 90/180/270 degrees for quick and easy image adjustment, and lower emissions.

**VESA Standard Mounting Interface:** Connects the monitor to any VESA standard third party mounting arm or bracket.

**Various Signal Interfaces:** This model has various interfaces. For more detail, please see [page 7](#).

**Plug and Play:** The Microsoft® solution with the Windows® operating system facilitates setup and installation by allowing the monitor to send its capabilities (such as screen size and resolutions supported) directly to the computer, automatically optimizing display performance.

**USB Hub 3.1 Gen.1:** The USB hub adds flexibility to your computing by providing easy access to USB SuperSpeed data transfer and charging via USB. For more details, please see [page 7](#).

**Hardware Calibration:** Adjusts brightness, colors and gamma curve for your preference with software and color sensor.

**USB Monitor Control:** Allows you to adjust each item through application software by connecting a USB cable.

**Color Control Systems:** Adjusts the colors on the screen and allows customization of the color accuracy of the monitor to a variety of standards.

**Human/Ambient Sensors:** Controls screen brightness according to user presence and ambient light status for less power consumption.

**Response Improve (RESPONSE IMPROVE):** Improves gray to gray response.

**Intelligent Power Manager System:** Provides innovative power-saving methods that allow the monitor to shift to a lower-power mode when on but not in use, reducing emissions and lowering the cost of operating the monitor by reducing its power consumption.

**ControlSync:** Provides control and settings synchronization for up to five MultiSync EA series displays, as well as individual control of any single monitor in the ControlSync chain, from a single master monitor (see [page 11](#)).

**Individual Adjust (INDIVIDUAL ADJUST):** A designated main monitor can adjust an individual sub monitor(s) by the OSD. It is good for multi-setting monitors which are positioned far from the user.

**Customize Setting (CUSTOMIZE SETTING):** Allows to store the current settings and recover stored settings.

**Low Blue Light:** Low Blue Light function substantially reduces blue light and helps to alleviate eye-strain (see [page 16](#)).

**Flicker Free:** Special backlight system reduces flicker for less eyestrain.

**NaViSet Administrator 2 Software:** Offers an expanded and intuitive graphical interface, allowing adjustments of the OSD display settings from a network PC.

**Environmental Impact (EA231WU):** Annual typical maximum operating carbon footprint of this monitor (world-wide average) is approximately 41.8 kg (calculated by: rated wattage x 8 hours per day x 5 days a week x 45 weeks per year x Power-to-Carbon conversion factor - conversion factor is based on OECD publication of global CO2 emissions 2008 Edition). This monitor has a manufacturing carbon footprint of approximately 51.4 kg.

**Environmental Impact (EA241F):** Annual typical maximum operating carbon footprint of this monitor (world-wide average) is approximately 42.7 kg (calculated by: rated wattage x 8 hours per day x 5 days a week x 45 weeks per year x Power-to-Carbon conversion factor - conversion factor is based on OECD publication of global CO2 emissions 2008 Edition). This monitor has a manufacturing carbon footprint of approximately 52.6 kg.

**Note:** The manufacturing and operating carbon footprints are calculated by a unique algorithm developed exclusively by NEC for its monitors and are accurate at the time of printing. NEC reserves the right to publish updated carbon footprint values.

# Troubleshooting

## No picture

- Make sure the signal cable is fully connected to both the monitor and the computer.
- Make sure the computer's display card is fully seated in its slot.
- Do not use a DisplayPort converter adapter. This device is not supported.
- Make sure both the computer and monitor power switches are in the ON position.
- The monitor will automatically turn off by the [POWER SAVE TIMER] function when the [POWER SAVE TIMER] setting is [ON] and continues power save mode for 2 hours. Please touch the [⏻] key.
- Make sure that a Major Supported Timings has been selected for the display card in the system being used. (Please consult the manual for the system or display card for supported resolution and changing the settings.)
- Check the monitor and your display card with respect to compatibility and recommended settings.
- Check the signal cable connector for bent or pushed-in pins.
- Make sure the connected device outputs a signal to the monitor.
- If the front LED is dark blue, check the status of the [OFF MODE SETTING] mode (see [page 14](#)) or [HUMAN SENSING] (see [page 14](#)).

## Power Key does not respond

- Unplug the monitor's power cord from the AC outlet to reset the monitor.

## Image Persistence

- Image persistence is when a residual or "ghost" image of a previous image remains visible on the screen. Unlike CRT monitors, LCD monitors' image persistence is not permanent, but constant images being displayed for a long period of time should be avoided. To alleviate image persistence, turn off the monitor for as long as the previous image was displayed. For example, if an image was on the monitor for one hour and a residual image remains, the monitor should be turned off for one hour to erase the image.

**NOTE:** As with all personal display devices, NEC DISPLAY SOLUTIONS recommends using a moving screen saver at regular intervals whenever the screen is idle or turning off the monitor when not in use.

## Message "OUT OF RANGE" is displayed (screen is either blank or shows rough images only)

- OSD warning "OUT OF RANGE" is displayed on a rough image (pixels are missing): Either the signal clock or resolution is too high. Change the settings to a supported mode.
- OSD warning "OUT OF RANGE" is displayed on a blank screen: The signal frequency is out of range. Change the settings to a supported mode.

## Image is unstable, unfocused or swimming is apparent

- Signal cable should be completely attached to the computer.
- Disconnect the DisplayPort cable and touch the [MENU] key. Select [DP LONG CABLE] then adjust the OSD value using the [←] key or [→] key.
- Use the OSD Image Adjust controls to focus and adjust the display by increasing or decreasing the [FINE] adjustment. When the display mode is changed, the OSD Image Adjust settings may need to be readjusted.
- Check the monitor and your display card with respect to compatibility and recommended signal timings.
- If your text is garbled, change the video mode to non-interlace and use the 60Hz refresh rate.

## LED on monitor is not lit (*no blue or amber color can be seen*)

- Power Switch should be in the ON position and power cord should be connected.
- Increase the [LED BRIGHTNESS] adjustment.

## Picture is not bright

- If the brightness fluctuates, make sure [DV MODE] is set to [STANDARD].
- Make sure [ECO MODE] and [AUTO BRIGHTNESS] are turned off.
- If the brightness fluctuates, make sure [AUTO BRIGHTNESS] is turned off.
- Signal cable should be completely attached.
- LCD brightness degradation occurs due to long-term usage or extreme cold conditions.
- When using an HDMI input, please change [VIDEO LEVEL].

## Display image is not sized properly

- Use the OSD Image Adjust controls to increase or decrease the Coarse adjustment.
- Make sure that a Major Supported Timings has been selected for the display card in the system being used. (Please consult the manual for the system or display card for supported resolution and changing the settings.)
- When using an HDMI input, please change [OVER SCAN].

**No Video**

- If no video is present on the screen, turn the [⏻] key off and on again.
- Make sure the computer is not in a power-saving mode (touch the keyboard or mouse).
- When using DisplayPort, some display cards do not output video signal under low resolution modes when the monitor is turned OFF/ON or disconnected/connected from the AC power cord.
- When using an HDMI input, please change [OVER SCAN].
- Make sure [VIDEO DETECT] is set to [NONE].

**No Sound**

- Make sure the speaker cable is properly connected.
- Check to see if mute is activated.
- Check the volume level in the OSD menu.
- If the input signal is DisplayPort or HDMI, make sure the [SOUND INPUT] in the OSD menu is set to [DISPLAYPORT] or [HDMI].

**Brightness variations over time**

- Change [AUTO BRIGHTNESS] to [OFF] and then adjust the [BRIGHTNESS].
- Change [DV MODE] to [STANDARD] and then adjust the [BRIGHTNESS].

**NOTE:** When [AUTO BRIGHTNESS] is set to [ON], the monitor automatically adjusts brightness based on the environment. When the brightness of surrounding environment changes, the monitor will also change.  
When [DV MODE] is set to [DYNAMIC], the monitor automatically adjusts the [BRIGHTNESS].

**USB Hub does not operate**

- Make sure the USB cord is properly connected. Refer to your USB device User's Manual.
- Check that the USB upstream port on the monitor is connected to the USB downstream port on the computer. And make sure the computer is ON.

**Human sensor does not work**

- Make sure there is no object in front of the Human sensor.
- Make sure there is no equipment that radiates infrared rays in front of the monitor.

**ControlSync does not work**

- Make sure the ControlSync cable is connected correctly.
- Make sure the ControlSync cable is not in "loop" connection.
- Master monitor should be connected with ControlSync OUT connector only.
- Please use the provided ControlSync cables.
- You can use up to five sub monitors via ControlSync.

**Displayed OSD menu is rotated**

- Make sure of the [OSD ROTATION] setting.

# Human Sensing function

The Human Sensing function reduces power consumption by detecting the movement of a person.

The [HUMAN SENSING] has following two settings:

MODE	HUMAN SENSING SETTING	No person in front of the monitor
LIGHT	1	BRIGHTNESS 0%
DEEP	2	Power saving mode

## Image of human sensing operation

- When the sensor detects no person in front of the monitor, the monitor stays on for the period of time which is set at [HUMAN SENSING] > [START TIME] (see [page 15](#)).
- The monitor displays a notification on the screen after the period of time with no human detected has passed. You can set the notification screen at [SENSOR INFORMATION] (see [page 18](#)).

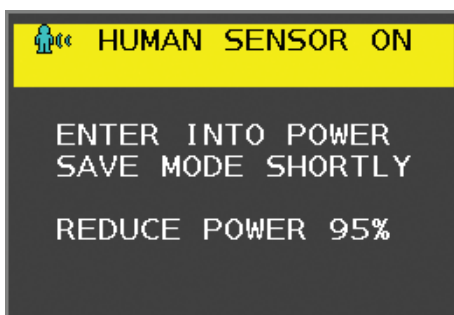

- After displaying the notification, if [LIGHT] is set at [HUMAN SENSING], the monitor screen gets gradually darker until it gets to 0% brightness. If [DEEP] is set at [HUMAN SENSING], the monitor enters into power saving mode.
- When the sensor detects a person coming back, the monitor is automatically returned from power saving mode to normal mode.

**NOTE:** When [LIGHT] is set at [HUMAN SENSING], the monitor screen gets gradually brighter as it returns to the original brightness.

- The monitor returns to normal mode.

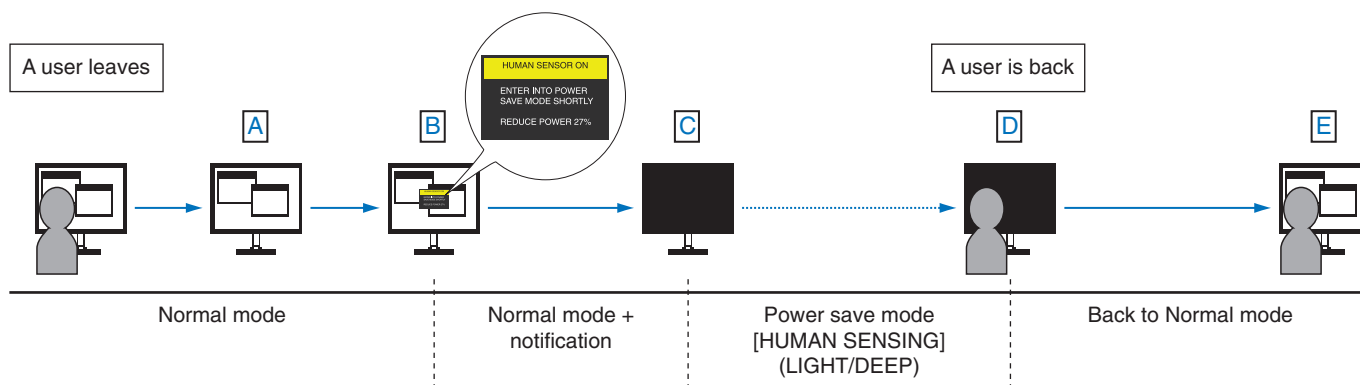

# Using the Auto Brightness function

The brightness of the LCD screen can be set to increase or decrease depending on the amount of ambient lighting within the room. If the room is bright, the monitor becomes correspondingly bright. If the room is dim, then the monitor will dim accordingly. The purpose of this function is to make the viewing experience more comfortable to the eye in a variety of lighting conditions.

## SETUP

Use the following procedures to select the brightness range the monitor will use when the [AUTO BRIGHTNESS] function is activated.

1. Set a level for the bright room condition. This is the maximum brightness level the monitor will rise to when the ambient lighting level is highest. Configure this setting when the room is at its brightest.

Select [ON] in the [AUTO BRIGHTNESS] menu (**Figure 1**). Then use the front Keys to move the cursor up to the [BRIGHTNESS] setting. Choose the desired brightness level (**Figure 2**).



Figure 1



Figure 2

2. Set a level for the dark room condition. This is the minimum brightness level the monitor will lower to when the ambient lighting level is low. Make sure the room is at its darkest when setting this level.

Then use the front Keys to move the cursor up to the [BRIGHTNESS] setting. Choose the desired brightness level (**Figure 3**).

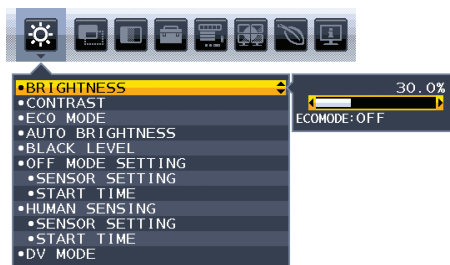

Figure 3

When the [AUTO BRIGHTNESS] function is enabled the Brightness level of the screen changes automatically according to the lighting conditions of the room (**Figure 4**).

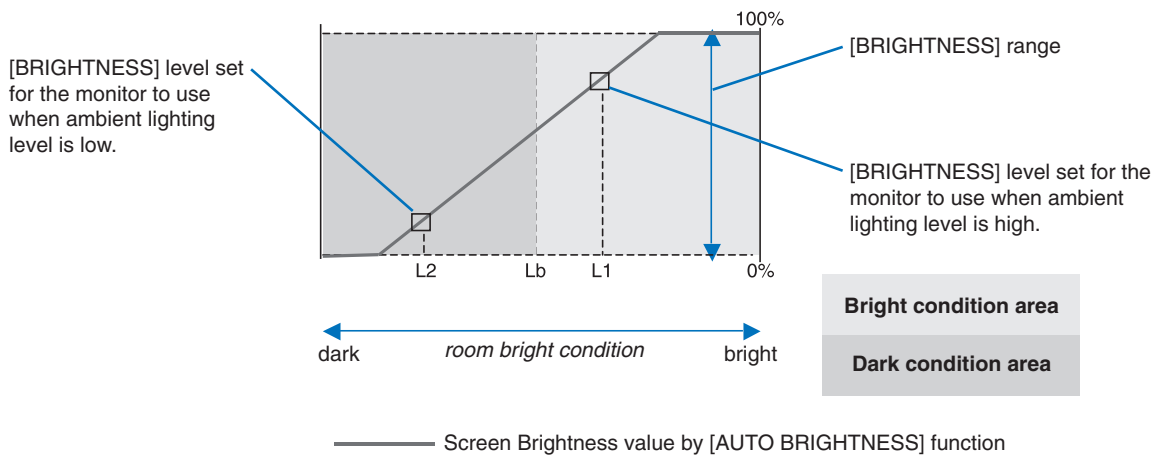

Figure 4

Lb: Border between bright and dim lighting conditions; set at the factory  
 L1: [BRIGHTNESS] level set for the monitor to use when ambient lighting level is high ( $L1 > Lb$ )  
 L2 : [BRIGHTNESS] level set for the monitor to use when ambient lighting level is low ( $L2 < Lb$ )

L1 and L2 are the brightness levels set by the user to compensate for changes in ambient lighting.

# Manufacturer's Recycling and Energy Information

NEC DISPLAY SOLUTIONS is strongly committed to environmental protection and sees recycling as one of the company's top priorities in trying to minimize the burden placed on the environment. We are engaged in developing environmentally-friendly products, and always strive to help define and comply with the latest independent standards from agencies such as ISO (International Organisation for Standardization) and TCO (Swedish Trades Union).

## Disposing of your old NEC product

The aim of recycling is to gain an environmental benefit by means of re-use, upgrading, reconditioning or reclamation of material. Dedicated recycling sites ensure that environmentally harmful components are properly handled and securely disposed. To ensure the best recycling of our products, **NEC DISPLAY SOLUTIONS offers a variety of recycling procedures** and gives advice on how to handle the product in an environmentally sensitive way, once it has reached the end of its life.

All required information concerning the disposal of the product and country-specific information on recycling facilities can be found on our following websites:

<https://www.nec-display-solutions.com/greencompany/> (in Europe),

<https://www.nec-display.com> (in Japan) or

<https://www.necdisplay.com> (in USA).

## Energy Saving

This monitor features an advanced energy saving capability. When a Display Power Management signal is sent to the monitor, the Energy Saving mode is activated. The monitor enters a single Energy Saving mode.

Mode	Power consumption	LED color
Maximum Operation	46 W (EA231WU) 47 W (EA241F)	Blue
Normal Operation	15 W Default setting	Blue
Energy Saving Mode	0.31 W*	Amber
Off Mode	0.29 W	Unlit

\*: Factory settings.

For additional information visit:

<https://www.necdisplay.com/> (in USA)

<https://www.nec-display-solutions.com/> (in Europe)

<https://www.nec-display.com/global/index.html> (Global)

For Energy Saving information:

For ErP requirement:

Setting: None.

Power consumption: 0.5 W or less.

Time for power management function: Approx. 1 min.

For ErP (Network standby) requirement:

Setting: None.

Power consumption: 0.5 W or less (with 1 port activating) / 3.0 W or less (with all ports activating).

Time for power management function: Approx. 1 min.

## WEEE Mark (European Directive 2012/19/EU and amendments)



### Disposing of your used product: In the European Union

EU-wide legislation as implemented in each Member State requires that used electrical and electronic products carrying the mark (left) must be disposed of separately from normal household waste. This includes monitors and electrical accessories, such as signal cables or power cords. When you dispose of such products, please follow the guidance of your local authority or ask the shop where you purchased the product, or if applicable, follow applicable legislation or agreement you may have. The mark on electrical and electronic products may only apply to the current European Union Member States.

### Outside the European Union

If you wish to dispose of used electrical and electronic products outside the European Union, please contact your local authority and ask for the correct method of disposal.