









Usage Information / Nutzungsinformationen / Gebruiksinformatie

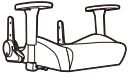

Nitro
S300 GAMING CHAIR

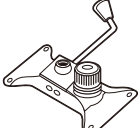
A	 x 5	F	
B		G	
C		H	 x 2
D		I	 x 2
E		J	Washer Spring Washer x 4
		K	

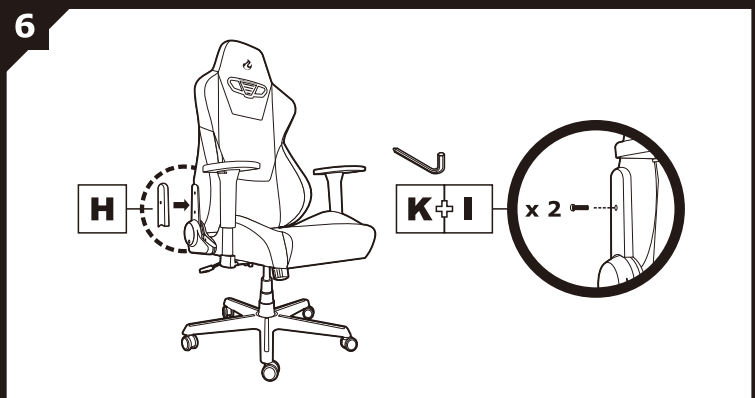
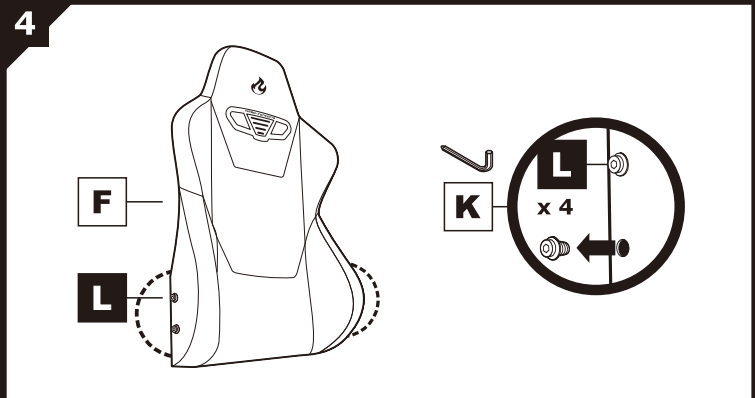
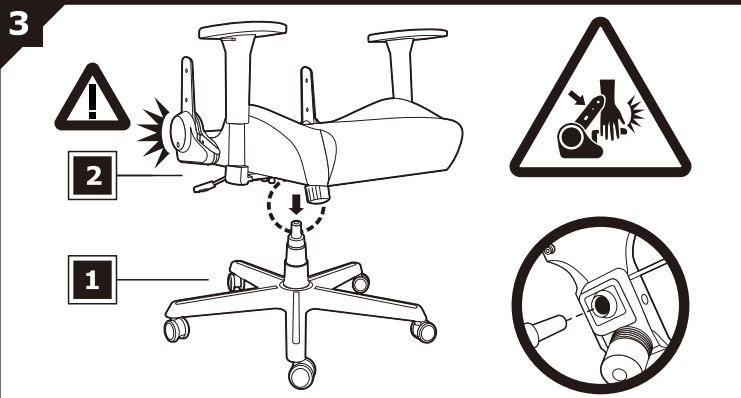
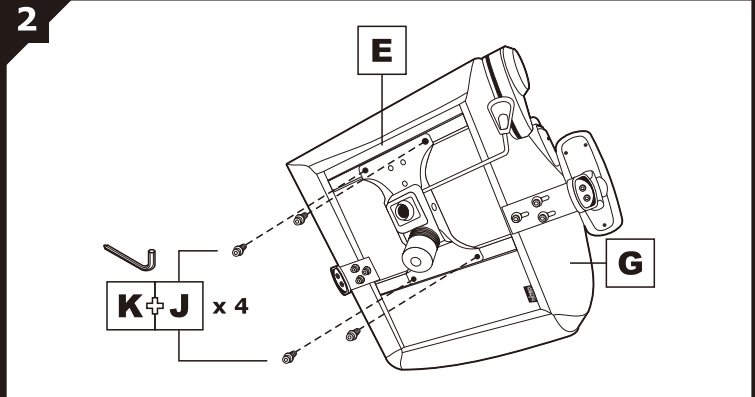
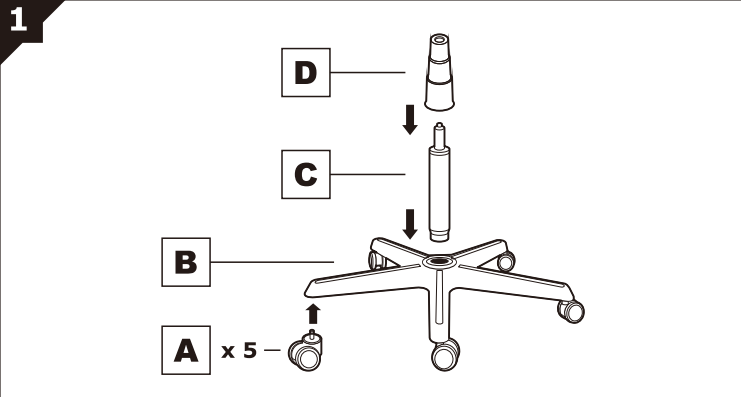

Usage Information / Nutzungsinformationen / Gebruiks informatie

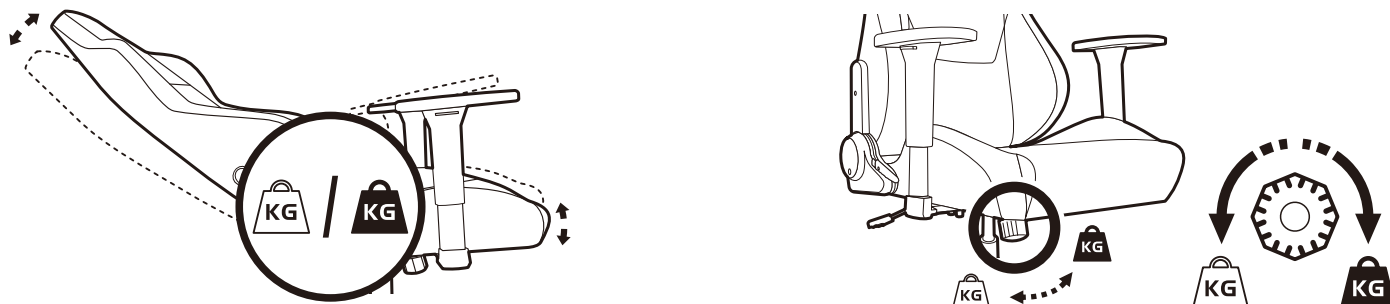
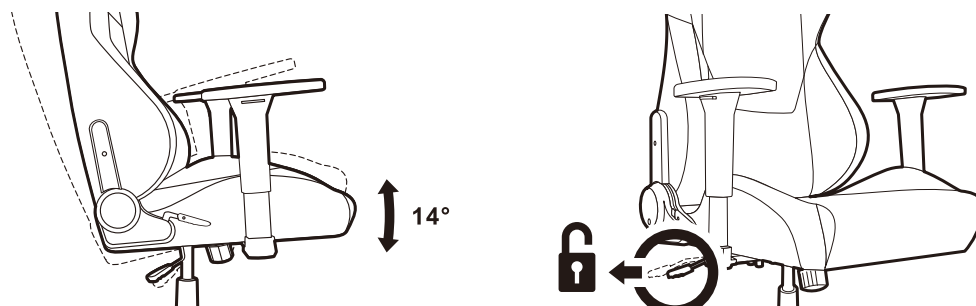
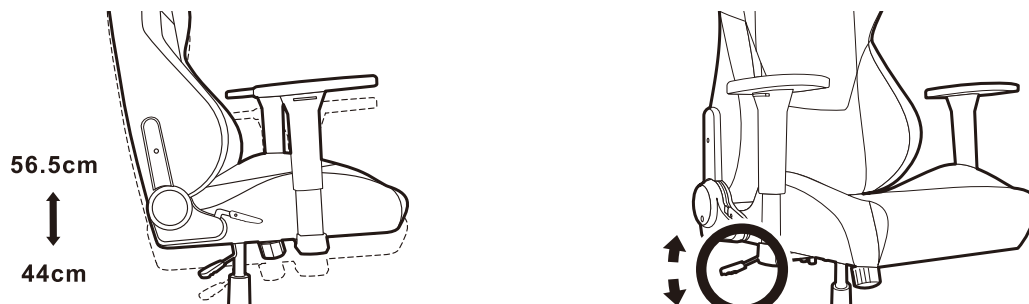
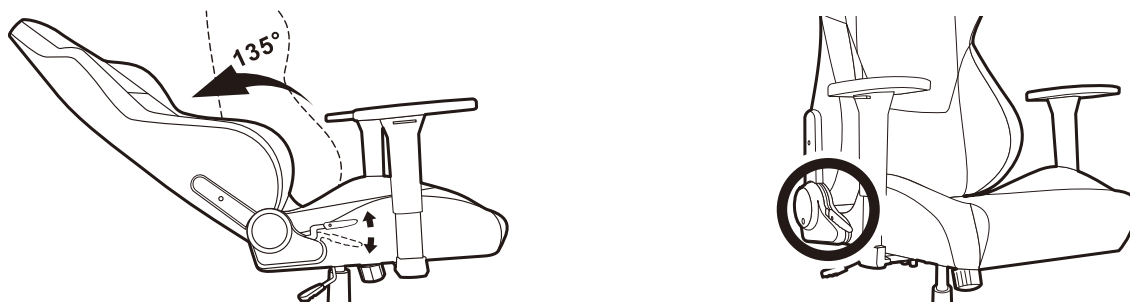
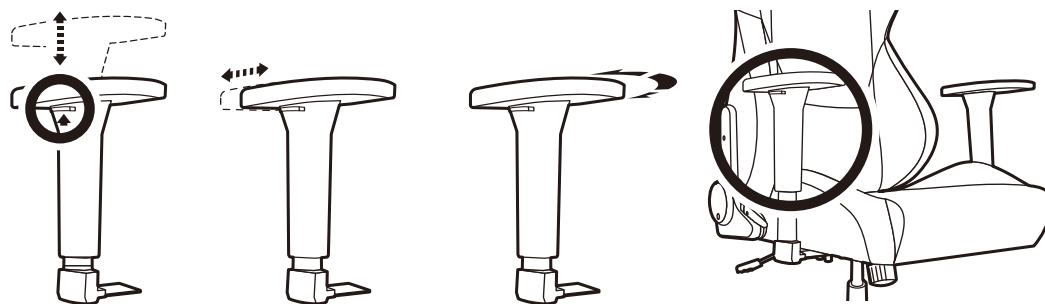

 info@nitro-concepts.com

 www.nitro-concepts.com