



Questo manuale d'istruzione è fornito da trovaprezzi.it. Scopri tutte le offerte per [Philips PUS7409](#) 50" (50PUS7409) o cerca il tuo prodotto tra le [migliori offerte di Televisori](#)

PHILIPS

Television

Quick Start Guide

7409 series

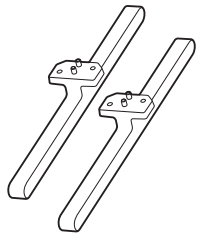
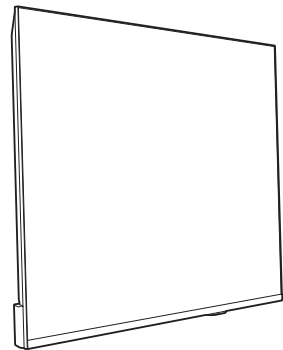

50"/55" (Q4xL18) : x4
65" (M4xL20) : x4

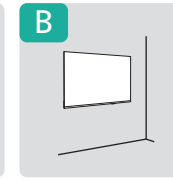
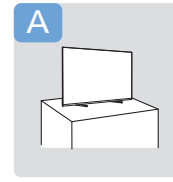

Register to find out more and get support
www.philips.com/TVsupport

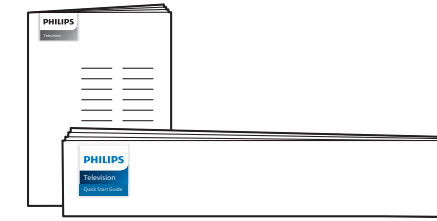
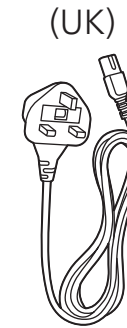
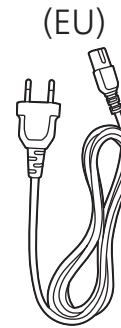
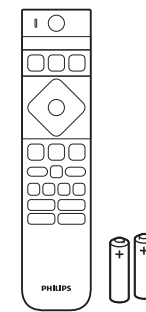
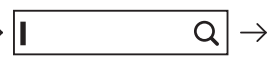

A 50"/55"

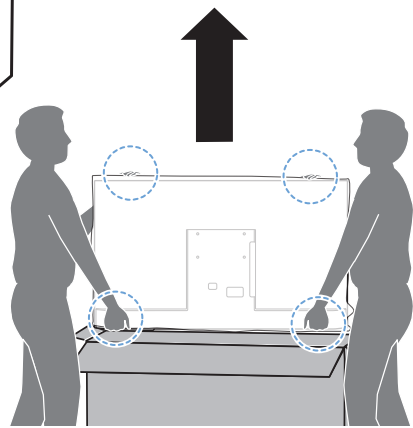
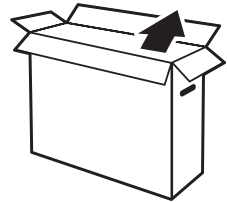

65"

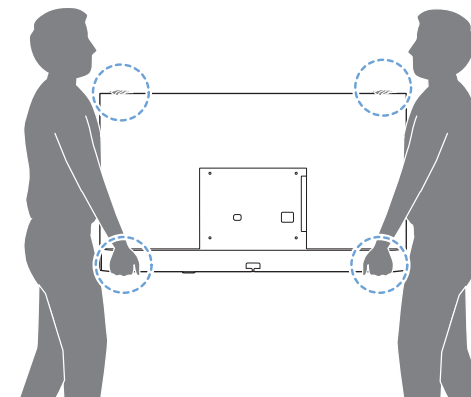
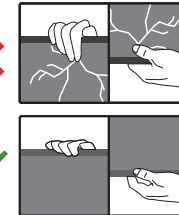
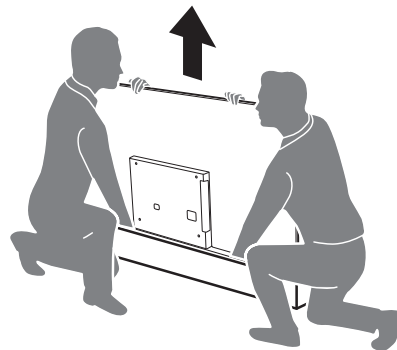
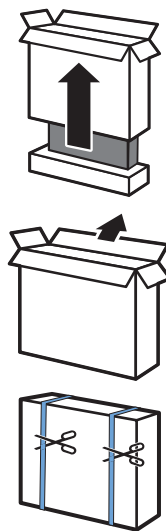

1

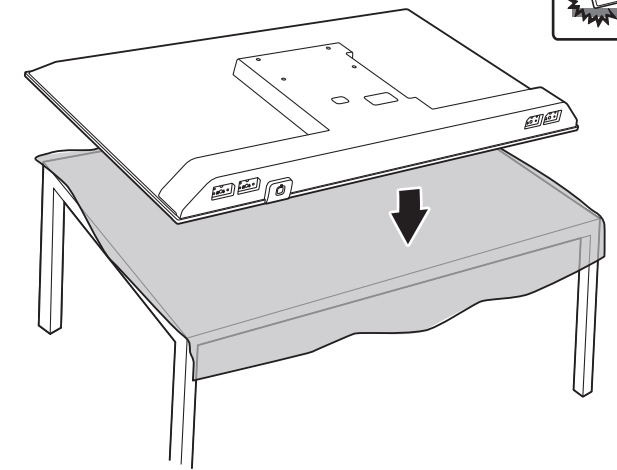

2

65"

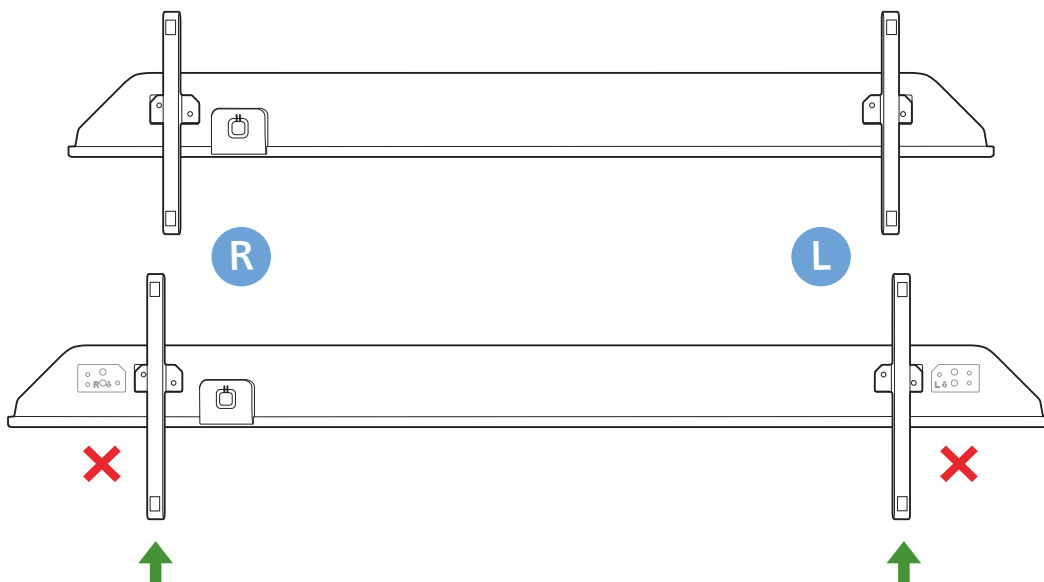

50"/55"

R + L

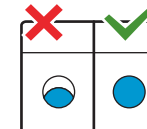

50"/55"
65"

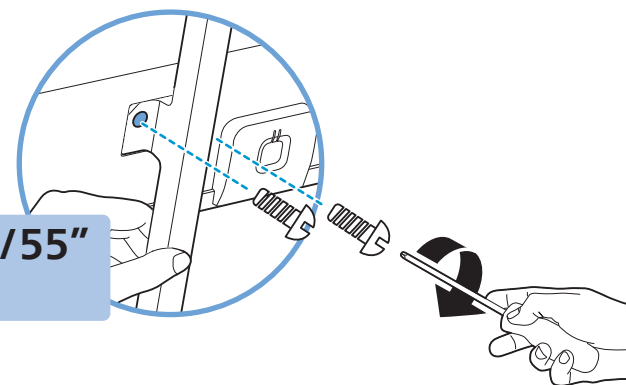

3

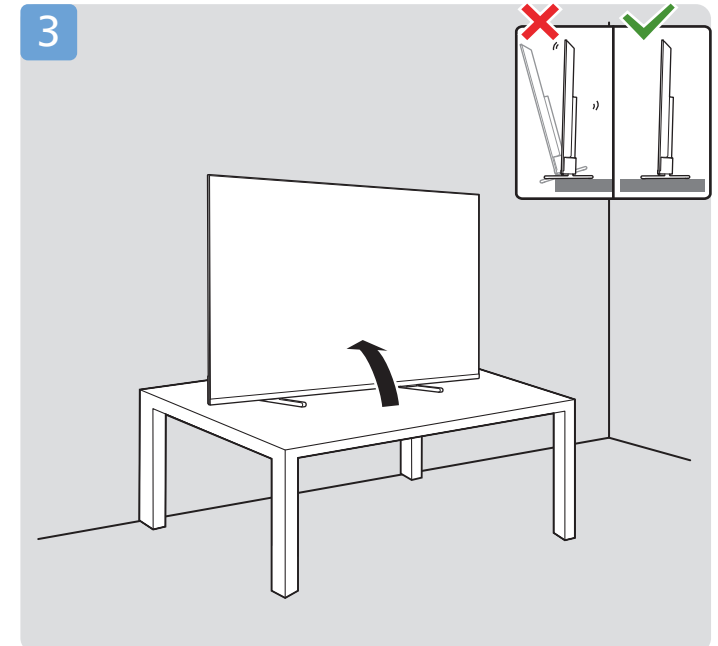

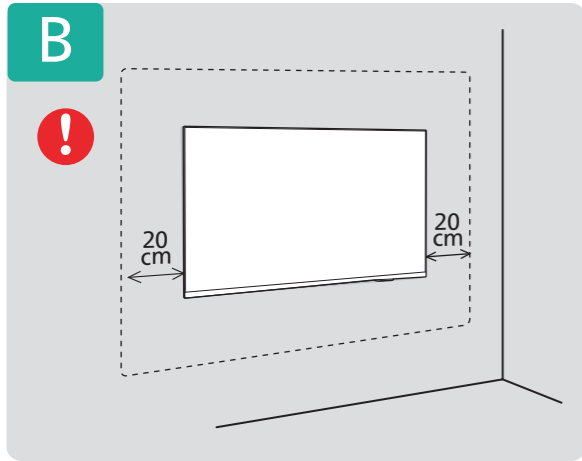

English Read the safety instructions.
Български Прочетете инструкциите за безопасност.
Čeština Přečtěte si bezpečnostní pokyny.
Hrvatski Pročitajte sigurnosne upute.
Dansk Læs sikkerhedsforskrifterne.
Deutsch Lesen Sie die Sicherheitshinweise.
Ελληνικά Διαβάστε τις οδηγίες ασφαλείας.
Eesti Lugege ohutusnõudeid.
Español Lea las instrucciones de seguridad.

Français Lisez les consignes de sécurité.
Italiano Leggere le istruzioni di sicurezza.
Қазақша Қорғаныстық нұсқаулар.
Latviešu Izlasiet drošības norādījumus.
Lietuvių Perskaitykite saugos instrukcijas.
Magyar Olvassa el a biztonsági utasításokat.
Nederlands Lees de veiligheidsvoorschriften.
Norsk Les sikkerhetsforskriftene.
Polski Zapoznaj się z instrukcjami bezpieczeństwa.

Português Leia as instruções de segurança.
Română Citiți instrucțiunile de siguranță.
Русский Читайте инструкции по технике безопасности.
Srpski Pročitajte bezbednosna uputstva.
Slovenščina Preberite varnostna navodila.
Slovenský Prečítajte si bezpečnostné pokyny.
Suomi Lue turvaohjeet.
Svenska Läs säkerhetsinstruktionerna.
ภาษาไทย โปรดอ่านคำแนะนำด้านความปลอดภัย

Türkçe Güvenlik talimatlarını okuyun.
Українська Читайте інструкції з техніки безпеки.
العربية قراءة تعليمات السلامة.
עברית קראו את הוראות הבטיחות



Wall Mount dimensions (x, y)
Dimensioni del montaggio a parete (x, y)

- 50" 200x100mm M6 (L: 8mm~10mm) 126 cm
- 55" 200x100mm M6 (L: 8mm~10mm) 139 cm
- 65" 400x300mm M8 (L: 12mm~22mm) 164 cm

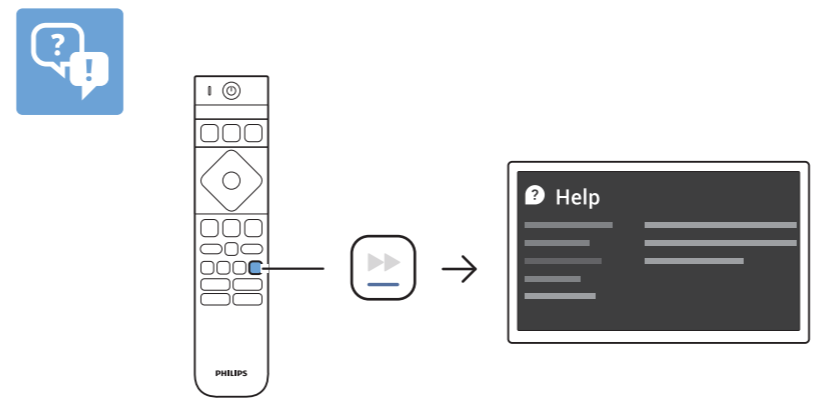
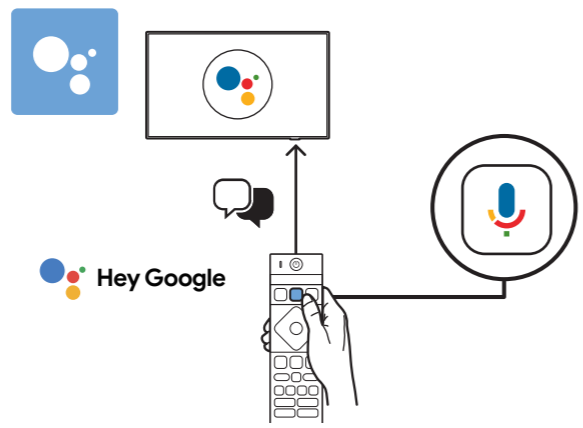
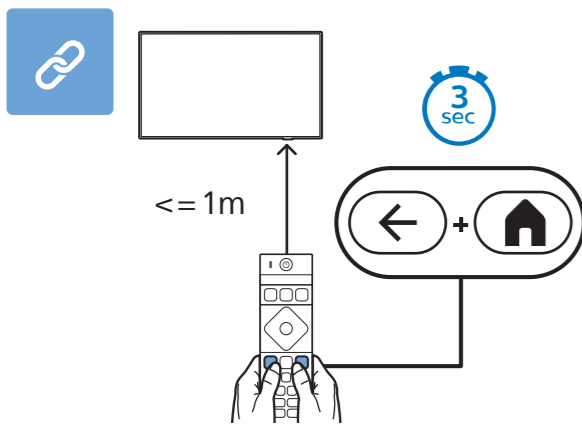
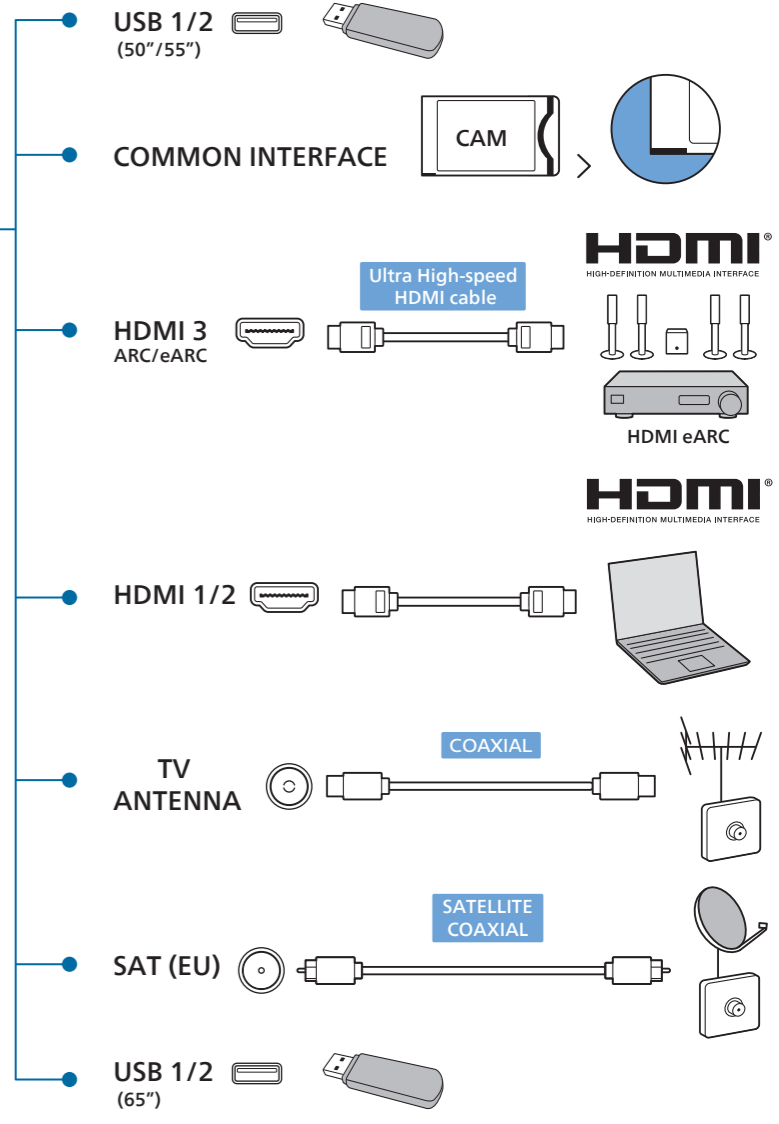
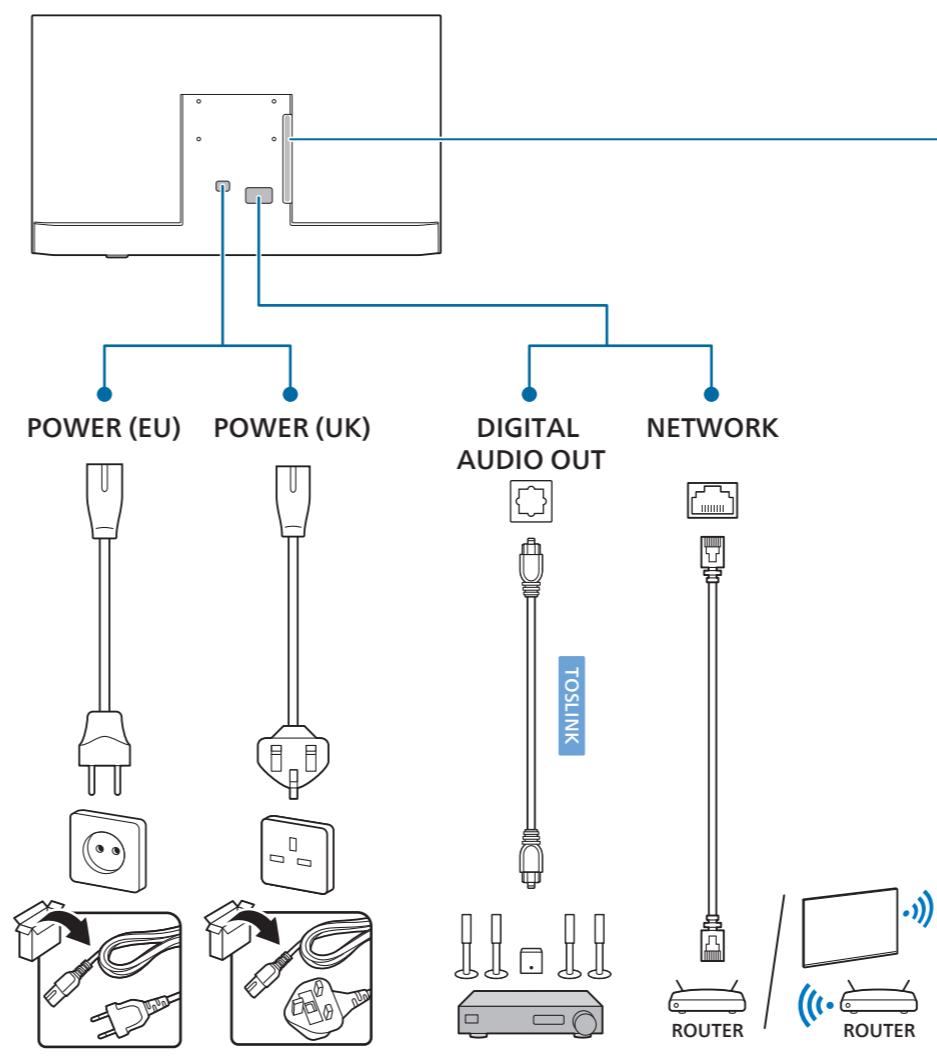
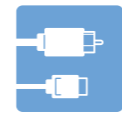
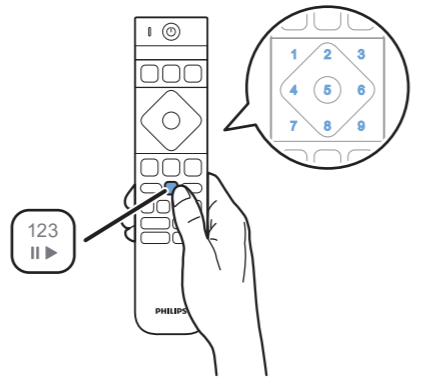
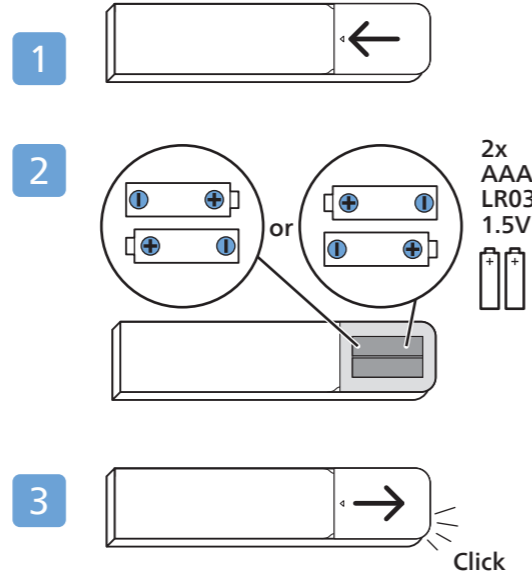
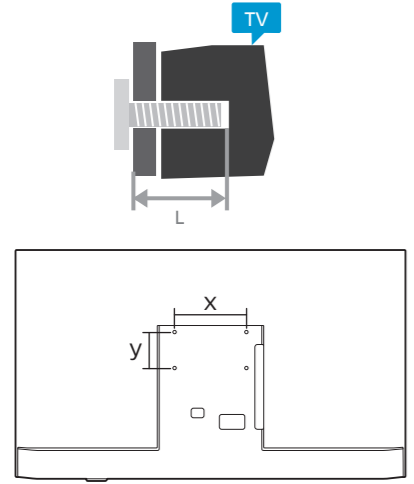

PHILIPS

All registered and unregistered trademarks are property of their respective owners. Specifications are subject to change without notice. Philips and the Philips Shield Emblem are registered trademarks of Koninklijke Philips N.V. and are used under license. This product has been manufactured by and is sold under the responsibility of TP Vision Europe B.V., and TP Vision Europe B.V. is the warrantor in relation to this product. 2024 © TP Vision Europe B.V. All rights reserved. www.philips.com/welcome