

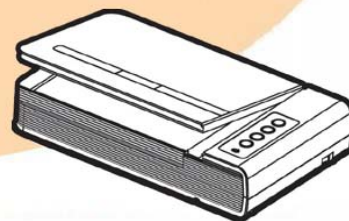

Questo manuale d'istruzione è fornito da trovaprezzi.it. Scopri tutte le offerte per [Plustek OpticBook 4800](#) o cerca il tuo prodotto tra le [migliori offerte di Stampanti](#)

Scanner User's Guide

plustek



OpticBook 4800

- ✓ **Installation**
- ✓ **Usage & Maintenance**

Trademarks

© 2011 Plustek Inc. All rights are reserved. No portion of this document may be reproduced without permission. All trademarks and brand names mentioned in this publication are property of their respective owners.

Liability

While all efforts have been made to ensure the accuracy of all contents in this manual, we assume no liability for errors or omissions or by statements of any kind in this manual, whether such errors are omissions or statements resulting from negligence, accidents, or any other cause. The contents of this manual are subject to change without notice. We will not shoulder any legal liability, if users failed to follow the operation instructions in this manual.

Copyright

The scanning of certain documents, for example checks, bank notes, I.D. cards, government bonds, or public documents, may be prohibited by law and/or subject to criminal prosecution. We recommend you to be responsible and respectful of the copyrights laws when you are scanning books, magazines, journals and other materials.

Environmental Information

Recycle or disposal at end-of-life information, please ask local distributors or suppliers for recycle and disposal information. The product is designed and produced to achieve sustainable environmental improvement. We strive to produce products in compliance with global environmental standards. Please consult your local authorities for proper disposal.

The product packaging is recyclable.

Attention for recycling (For EU country only)

Protect your environment! This product should not be thrown into the household waste container. Please give it to the free collecting center in your community.

Screen Examples in This Manual

The screen shots in this guide were made with Windows XP. If you are using Windows 2000/ Vista/ 7, your screen will look somewhat different but functions the same.

Table of Contents

INTRODUCTION	1
How to Use This Guide.....	1
Conventions of This Guide.....	2
<i>A Note about Icons</i>	2
Safety Precautions.....	2
Minimum System Requirements.....	3
Box Contents.....	4
The Scanner's Features.....	4
CHAPTER I. INSTALLING THE SCANNER	6
Software Installation Requirements.....	6
Hardware Requirements.....	6
Installing and Setting up the Scanner.....	7
<i>Step 1. Connecting the scanner to Your Computer</i>	7
<i>Step 2. Installing the software</i>	8
<i>Step 3. Testing the Scanner</i>	10
Software Setup Troubleshooting.....	11
Installing Additional Software.....	11
CHAPTER II. USAGE AND MAINTENANCE	12
Operating the Scanner.....	12
Preparation.....	12
Scan the Image(s).....	13
<i>Scanning via TWAIN Interface</i>	14
<i>Scanning from the Scanner's Panel or via Book Pavilion Interface</i>	15
<i>Scanning from Plustek DI Capture Program</i>	16
Scanner Connection.....	17
Aligning the Scanner.....	18
Standby Mode.....	18
Scanner Lock.....	19
Usage & Maintenance Tips.....	20
APPENDIX A: SPECIFICATIONS	21
APPENDIX B: CUSTOMER SERVICE AND WARRANTY	22
Service & Support Information (For EU country only).....	22
Statement of Limited Warranty.....	23
FCC Radio Frequency Statement.....	24
CONTACTING PLUSTEK	25

Introduction

Welcome to the world of Plustek scanners – the ultimate in computer imaging. Your new scanner will improve the professionalism of your day-to-day computing tasks by allowing you to input images and electronic text into your computer system.

Like all of our products, your new scanner is thoroughly tested and backed by our reputation for unsurpassed dependability and customer satisfaction.

Please remember to register your scanner by registering online via Plustek's website.

See the last page of this user's guide for a complete list of Plustek offices worldwide.

As a registered customer, you will receive customer support, new product information and software upgrades.

Thank you for choosing us as your scanner supplier. We hope you will continue to turn to us for additional quality products as your computing needs and interests grow.

How to Use This Guide

This User's Guide provides instructions and illustrations on how to install and operate your scanner. This guide assumes the user is familiar with Microsoft Windows System. If this is not the case, we suggest you learn more about Microsoft Windows by referring to your Microsoft Windows manual before using your scanner.

The Introduction section of this manual describes the box contents and minimum computer requirements to use this scanner. Before you start installing your scanner, check the box contents to make sure all parts are included. If any items are damaged or missing, please contact the vendor where you purchased your scanner or our customer service directly.

Chapter I describes how to install scanner's software and connect the scanner to your computer. Note: The scanner connects to your computer through the Universal Serial Bus (USB). If your computer does not support USB technology, you will need to purchase a USB interface card to add USB capabilities to your computer, or buy and install USB connectors if your motherboard has USB capabilities. This guide assumes that your computer is USB-ready and has a free USB port.

Chapter II describes how to use, maintain and clean your scanner.

Appendix A contains the Specifications of the scanner you purchased.

Appendix B contains our limited warranty agreement and FCC statement concerning the product.

Conventions of This Guide

[XXX] — Represents commands or contents on your computer screen.

Italic — First use of an important term in a chapter.

Bold — Represents buttons on your scanner OR important notes.

A Note about Icons

This guide uses the following icons to point out information that deserves special attention.



Warning

Warning: A procedure that must be followed carefully to prevent injury, or accidents.



Attention

Attention: Instructions that are important to remember and may prevent mistakes.



Information

Information: Optional tips for your reference.

Safety Precautions

Before using this device, please read the following important information to eliminate or reduce any possibility of causing damage and personal injury.

1. Usage, the product is for indoor use in dry locations. Moisture condensation may occur inside this device and cause malfunction at these conditions:
 - when this device is moved directly from a cold to a warm location;
 - after a cold room is heated;
 - when this device is placed in a damp room.

To avoid the moisture condensation, you are recommended to follow the procedure:

- i. Seal this device in a plastic bag for it to adapt to room conditions.
- ii. Wait for 1-2 hours before removing this device from the bag.
2. Do not use the power adapter and USB cable provided with the scanner. Use of other power adapter and cables may lead to malfunction.
3. Keep the space around the AC adapter clear in case you need to quickly unplug the AC adapter during emergencies.
4. Damaged wire could cause fire or electrical shock. Keep the power cord straight and without being twisted, bended, or scraped.

5. Unplug this device if you don't need to use for a certain period of time, such as, during night or long weekend, to avoid any risks of causing fire.
6. Do not attempt to disassemble the scanner. There is danger of an electrical shock and opening your scanner will void your warranty.
7. Be sure not to bump or knock the scanner glass as it is fragile and could break.

Minimum System Requirements¹

- PC with Intel Pentium® II 233 MHz processor or compatible
- 128MB RAM
- Available USB 2.0 port
- CD-ROM Drive or DVD-ROM Drive
- 800 MB Free Hard Disk Space
- Video card that supports 16-bit color or greater
- Operating System: Windows 2000/XP/Vista/7(compatible)



Information

Systems with Pentium III 500 MHz or higher processor (or its compatible), 256 MB RAM, available USB 2.0 port and 800MB free hard disk space are recommended for optimal performance.

¹ Higher requirements might be needed when scanning or editing a large quantity of image data. The system requirements here are only a guideline, as in general the better the computer (motherboard, processor, hard disk, RAM, video graphic card), the better the results.

Box Contents²

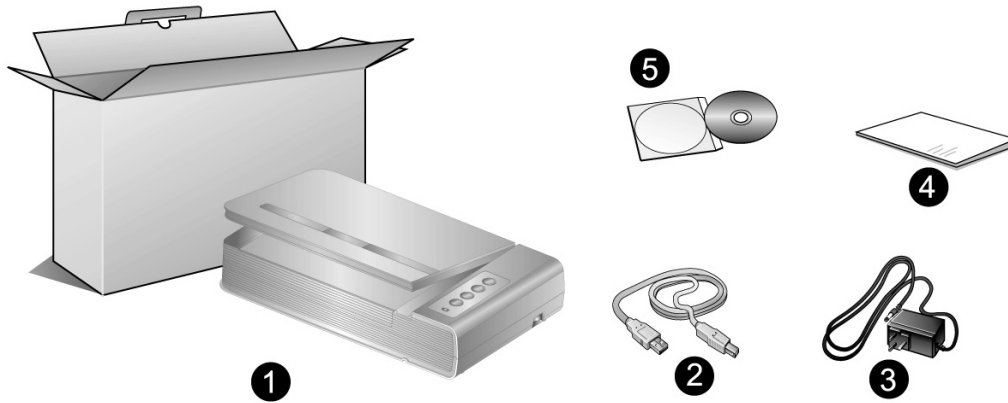

1. Scanner
2. USB Cable
3. Power Adapter
4. Quick Guide
5. Set up/Application CD-ROM

The Scanner's Features

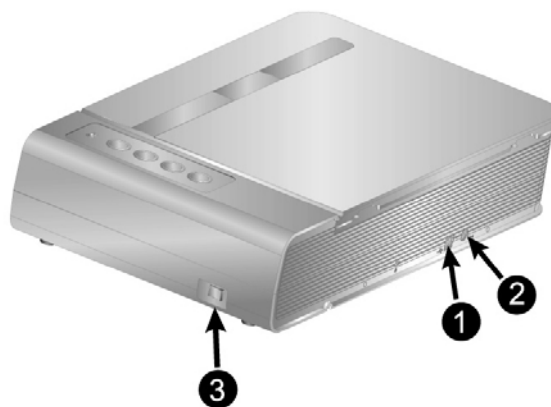

1. **USB Port:** It connects the scanner to a USB port on your computer by the included USB cable.
2. **Power Receptor:** It connects the scanner to a standard AC power outlet by the included power adapter.
3. **Power Switch:** Use this to turn the scanner ON or OFF.

² Save the box and packing materials in case you need to transport this scanner in the future. The product packaging can be recycled.

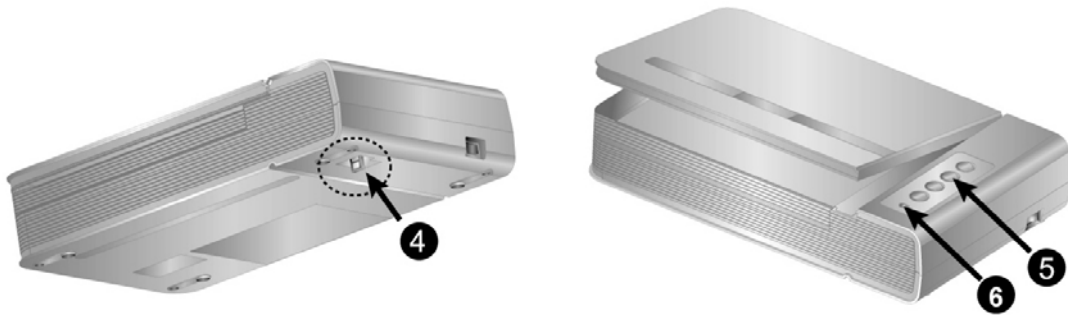

4. **Scanner Lock:** It holds your scanner head in place during transportation.
5. **Scanner Buttons:** You may press the button to perform a predefined scanning task.
6. **Power LED:** It indicates the scanner status.

Light	Status
On	The scanner is turned on, ready to scan images.
Off	The scanner is off, either because the power is not turned on, or because the power cord is not properly plugged into an AC power outlet.

Chapter I. Installing the Scanner

Before installing your scanner, please verify that you have all of the proper components. A list of the package contents is provided in the *Box Contents* section of this guide.

Software Installation Requirements

Your scanner comes with the image-editing software (NewSoft Presto! ImageFolio), OCR software (ABBYY FineReader Sprint), document management software (Presto! PageManager), the image capture software (Plustek DI Capture), the scanner's driver and the Book Pavilion software. All of these software applications use approximately 800 megabytes of hard disk space after they are installed into your computer. To ensure ample room for the installation, as well as for scanning and saving images, a minimum of 1 GB of hard disk space is recommended.

The USB scanner can only operate under the Microsoft Windows 2000, XP, Vista or 7 operating system.

Hardware Requirements

This scanner connects to your computer through the Universal Serial Bus (USB), which supports hot Plug and Play. To determine whether your computer is USB-capable, you must check the rear of your PC to locate a USB jack that looks the same as the one pictured below. Note that on some computers, the USB port at the rear of the computer may be occupied and additional ports may be found on the monitor or keyboard. If you are having trouble in locating the USB port on your computer, please refer to the hardware manual that came with your computer.

Upon examination, you should find one or two rectangular USB ports, which usually appear as shown below.

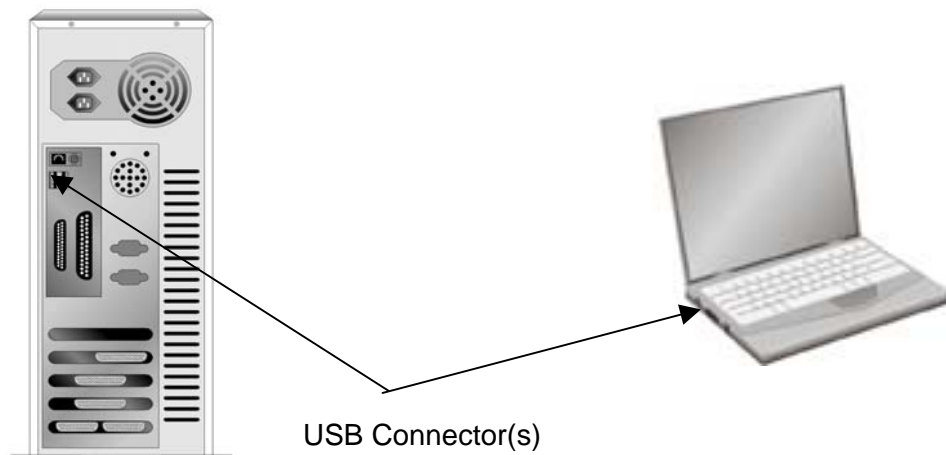

If you don't find such USB ports on your computer, then you need to purchase a certified USB interface card to add USB capabilities to your computer.

Installing and Setting up the Scanner

Please follow the step-by-step procedures described below to install the Plustek scanner.

Step 1. Connecting the scanner to Your Computer

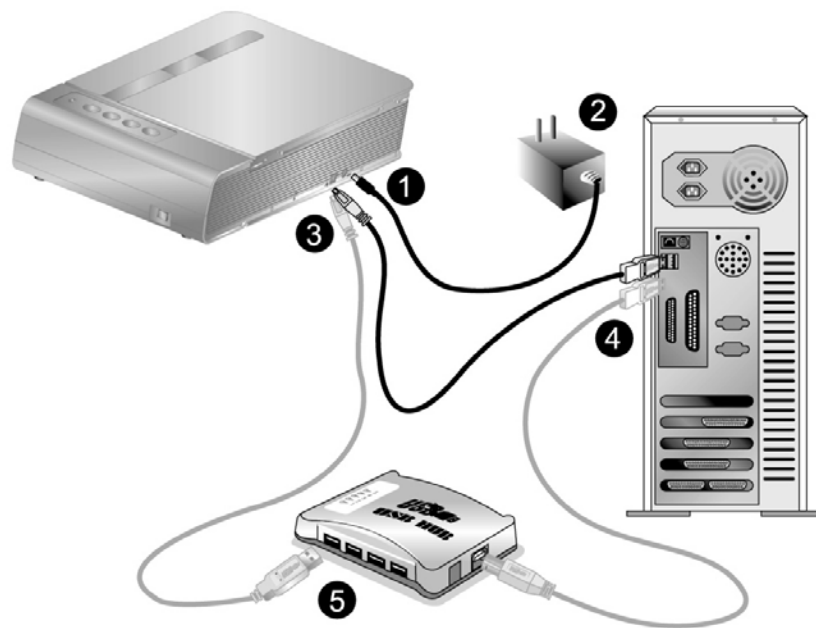

Please make sure the scanner is turned OFF before you plug or unplug the scanner power adapter.

Attention

1. Plug the power adapter into the scanner's power receptor.
2. Plug the other end of the power adapter into a standard AC power outlet.
3. Plug the square end of the included USB cable to the USB port at the rear of the scanner.
4. Plug the rectangular end of the USB cable to an available USB port on the back of your computer.
5. If you plan to connect your scanner to a USB hub³, make sure that the hub is connected to the USB port in your computer. Next, connect the scanner to the USB hub.

³ The USB hub is not included with the scanner.

Step 2. Installing the software

1. Switch the scanner power on.



2. If the USB components on your computer are functioning correctly, they will automatically detect the scanner causing the **Add New Hardware Wizard** or **Found New Hardware Wizard** to be launched.



Information

If your computer was off when you connected the scanner, the **Add New Hardware Wizard** message will be displayed when you turn the computer on and when Windows starts.

3. For Windows 2000:
 - a. Click the **Next** button when the “Add New Hardware Wizard” window is displayed.
 - b. Select **Search for the Best Driver for Your Device [Recommended]** and click the **Next** button.
 - c. The next window will ask you where to search to find the drive. Select **CD-ROM drive**, and deselect **Floppy disk drives** if it is checked.



- d. Insert the Setup/Application CD-ROM, included with your scanner, into your CD-ROM drive and then click the **Next** button.
 - e. Click the **Next** button in the window that appears.
 - f. During the process of the installation, a message “Digital Signature required” might be prompted. Please ignore it, and click the **Yes** button to continue the installation without any misgiving at your scanner functioning. Afterwards, please skip to procedure 8.
4. For Windows XP:
 - a. Insert the Setup/Application CD-ROM, included with your scanner, into your CD-ROM drive.

- b. Select **Install the software automatically recommended** and click the **Next** button.
 - c. Click the **Next** button in the window that appears. Afterwards, please skip to procedure 8.
5. For Windows Vista:
- a. Select “Locate and install driver software (recommended)” when the “Found New Hardware” window is displayed.
 - b. Click on the **Continue** button when the “User Account Control” dialog pops up.
 - c. Insert the Setup/Application CD-ROM, included with your scanner, into your CD-ROM drive when the system prompts you “Insert the disc that came with your USB Scanner“, and click on the **Next** button. Afterwards, please skip to procedure 8.

6. For Windows 7:

When the Setup/Application CD is for several scanner models

- a. Insert the Setup/Application CD-ROM, included with your scanner, into your CD-ROM drive. Click **Run install.exe** in the **AutoPlay** window.
- b. Click on the **Yes** button if the **User Account Control** dialog pops up. Follow the instructions in the pop-up installation message.
- c. In the **Device Manager** window, right-click on this scanner under **Other devices** and select **Update Driver Software** from the pop-up menu. Click **Browse my computer for driver software** in the window that appears, and click the **Browse** button.
- d. In the **Browse For Folder** window, select the folder or the CD-ROM drive that contains this scanner’s driver and click the **OK** button to return to the previous screen. Click the **Next** button and click **Install this driver software anyway** if the **Windows Security** window appears. Afterwards, please skip to procedure 9.

When the Setup/Application CD is for one scanner model

- a. Insert the Setup/Application CD-ROM, included with your scanner, into your CD-ROM drive. Click **Run install.exe** in the **AutoPlay** window.
 - b. Click on the **Yes** button if the **User Account Control** dialog pops up. If the pop-up wizard window appears click **Next**, and click **Install this driver software anyway** in the **Windows Security** window then click **Finish** in the wizard window. Afterwards, please skip to procedure 9.
7. During the process of the installation, a message “Windows can’t verify the publisher of this driver software” might be prompted. Please ignore it, and click on **Install this driver software anyway** to continue the installation without any misgiving at your scanner functioning.

- When the system completes the installation, click on the **Finish** button.
- Follow the on-screen instructions to install all software that your new USB scanner requires.
- After the software is installed, close all open applications and click on the **Finish** button to restart your computer.



Information

If the scanner installation is not started and displayed automatically on the screen, click **Start**, select **Run** and type in **D:\Install** (where D: is the drive letter assigned to the CD-ROM drive of your computer.)

Step 3. Testing the Scanner

The following describes how you can check if the scanner is properly functioning with your computer and the scanning software by performing your first scan with our bundled image-editing application NewSoft Presto! ImageFolio. Before testing your scanner, double check to make sure that all connections are securely fastened.

To properly test your scanner, please perform the following steps:

- Open the scanner's document cover and place a book, head toward the scanner button panel, on the scanner glass.



- Gently close the document cover.
- Click the Windows Start button to launch NewSoft Presto! ImageFolio.
- (If you have only one scanner connected with your computer, please skip to Step 5.)

If you have more than one scanner or other imaging device installed on your computer: Click **Select Source** from the **File** menu of Presto! ImageFolio and then choose this scanner as the default scanning source.

- Within Presto! ImageFolio, click **File > Acquire > Acquire**.
- In the TWAIN window that opens, select **Flatbed Reflective** as the Scan Type.

7. Click the **Scan** button.
8. If an image appears on your screen, your scanner is working properly.



Please refer to ImageFolio on-line help for further information about using ImageFolio.

Information

Software Setup Troubleshooting

Carefully review the steps outlined in this guide and the Quick Guide that accompanied your scanner.

If you are still having problems, please check that:

- You have 800MB of free space on your hard disk drive.
- The scanner is plugged in and has power.
- You are using the USB cable supplied with the scanner.
- The square end of the USB cable is plugged into the rear of the scanner.
- The rectangular end of the USB cable is plugged into the back of your computer.

If you deviated from the installation procedures defined in this manual, please unplug the USB cable from the scanner and reinstall the software from the CD-ROM. To reinstall your scanner's software, click **Start, Run**, then type **D:\Install** (where D represents the letter of your CD-ROM drive). Carefully follow all the installation instructions presented in the Setup Wizard. Reboot your computer when prompted, and plug the USB cable back into the scanner while your computer is still turned on.

Installing Additional Software

Your scanner is TWAIN compliant and functions with virtually all available TWAIN compatible software. If you purchase additional software to be used with your scanner, please make sure that it conforms to the TWAIN standard.

Chapter II. Usage and Maintenance

Operating the Scanner

Your scanner needs to be driven by some type of software program. Since all documents or images (whether text or pictures) that are acquired from the scanner are treated by your computer as images, most scanning will probably be done from an image-editing program where you can view, edit, save and output the scanned images. An image-editing program has been bundled with your scanner on the included Setup/Application CD-ROM. It will allow you to alter and correct any scanned images by using a variety of filters, tools and effects.

What about scanning text documents and editing them in a word processor? This is the role of Optical Character Recognition (OCR) software. OCR software converts the image files that are created from scanning text documents into text files that can be viewed, edited and saved by word processors. An OCR program has also been bundled on the included Setup/Application CD-ROM, and if you wish to use the scanner in this way you should install the OCR software that is included.

DI Capture, as its name suggests, is a specialized document image capture program that allows you to conveniently digitize your paper documents and automatically save their electronic files in the designated folder. If you are not familiar with scanning, no problem: the Scan Wizard will guide you through to complete each scanning task.

Book Pavilion, a carefully designed tool, helps you make the book scanning experience simple and efficient. With prior settings within the Book Pavilion turning books into electronic files is as easy as making copies on a copy machine. All you need to do is turn the book pages and then press one of the three scan buttons on the scanner panel. Furthermore, you can scan consecutive pages on a book without worrying about the page direction.... And you need to experience more!

Please refer to the online help of each program to guide you through any question you may have while scanning within that program.

Preparation

1. Open the document cover and place your book on the scanner glass. Align the book with the  mark on the scanner.
2. Gently close the document cover.



When you're scanning a thick book, please gently

Information press the book binding to guarantee the minimum space between the to-be-scanned page and the scanner glass.



Warning

When the document cover is not closed, please don't look directly at the scanner lamp during scanning.

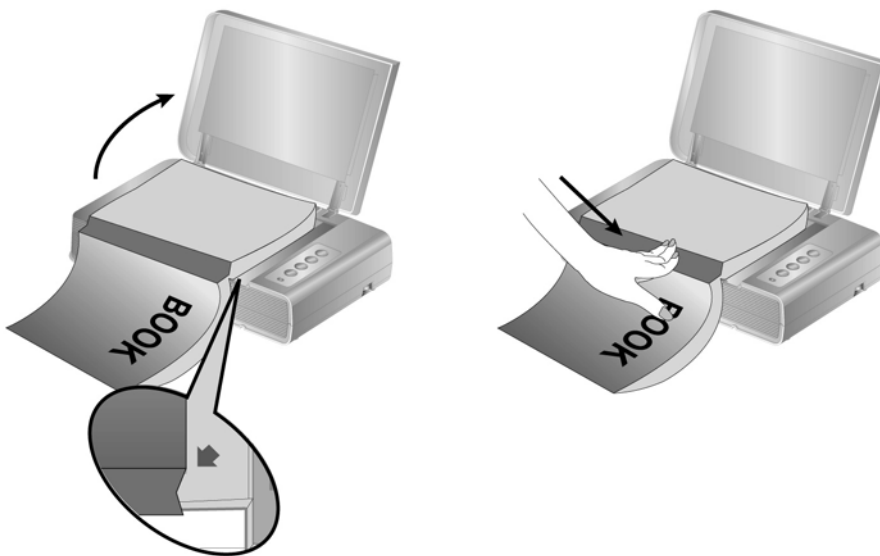

Scan the Image(s)

There are four different ways to operate the scanner:

1. By acquiring images from the scanner through our TWAIN interface within any TWAIN-compliant application programs.
2. By scanning from the scan button on the scanner.
3. By scanning images within Book Pavilion software.
4. By scanning images within our DI Capture software.

The TWAIN interface, DI Capture and Book Pavilion software are automatically installed to your system along with the scanner driver.



Attention

Before you start scanning, check the following:

- Your scanner has been unlocked and the power of both your computer and scanner is turned on.
-

-
- The icon  appears on the Windows system tray.
 - The book or paper is appropriately placed on the scanner flatbed glass.
-

Scanning via TWAIN Interface

The TWAIN program is a very important piece of software that comes with your scanner. This program acts as an interface between the scanner hardware and the image-editing software you are using to view and edit images. The TWAIN program allows you to adjust a number of settings to define the quality of the scanned image.

The following describes how you may use our bundled image-editing application (NewSoft Presto! ImageFolio) to scan via the TWAIN interface. When you get familiar with the scanning, you may alternatively use other TWAIN compatible scanning programs or image-editing applications to do your scanning projects.

Scan within NewSoft Presto! ImageFolio:

1. Click the Windows Start button to launch Presto! ImageFolio.



Attention

If you have more than one scanner or other imaging devices installed on your computer, you need to set this scanner as the default scanning source before you acquire the TWAIN program.

1. From the File menu of Presto! ImageFolio, click **Select Source**.
 2. In the window that opens, choose this scanner and then click the **OK** button to set this scanner as the default scanning source.
-
2. Within Presto! ImageFolio, click **File > Acquire > Acquire**.
 3. In the TWAIN window that opens, select **Flatbed Reflective** as the Scan Type.

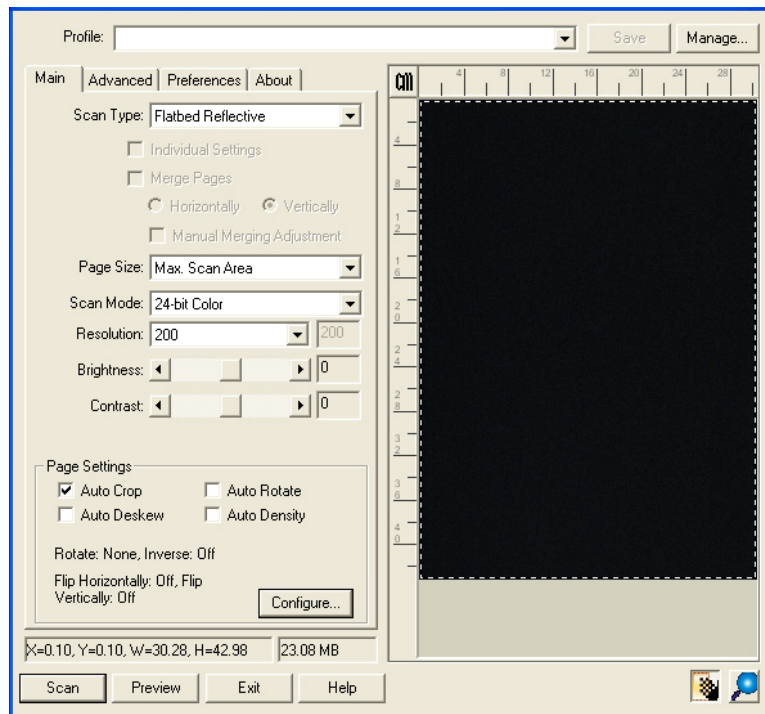

4. Adjust the scanning settings.
5. Click the **Preview** button. The scanned image should appear in the Preview Window. To define the margins and crop out sections of the image you don't want scanned, use the mouse to click and drag the corners or sides of the scan area borders. Adjust the scan settings again if the preview image doesn't satisfy your needs.
6. Click the **Scan** button.
7. When the scan finishes, click the **Exit** button to close the TWAIN window. The scanned images are displayed in Presto! ImageFolio, and you may perform the image editing tasks.



Click the **Help** button within the TWAIN window for more information about the settings.

Scanning from the Scanner's Panel or via Book Pavilion Interface

Your scanner is equipped with function buttons designed to make your scanning experience more convenient and efficient. The buttons on scanner's panel perform **Color**, **Gray** and **B/W** scanning functions. The settings for each button on the scanner's panel are configured through Book Pavilion. Book Pavilion offers you quick access to the most frequently-used scanning functions. They are especially useful when you need to repeatedly scan with the same settings and send images to the same destination.

Configure Button Settings

Before performing your first scan via scanner buttons, you are recommended to configure the button settings to your needs and preferences first. There are three ways to configure or view the button settings of Book Pavilion:

- Press the **Color**, **Gray** or **B/W** button on the scanner panel.
- Double-click the icon  in the Windows system tray.
- Right-click the icon  in the Windows system tray, and then choose **Setting...** in the pop-up menu that opens.

Within the “Book Pavilion” window, you may adjust the scan settings by clicking **Mode Setting**. Also, you can configure the save settings of the scanned images.

Click the **Help** button within the Book Pavilion window for more information about the settings.

Scan from the Buttons

Scanning books or images from this scanner is very easy. Follow the two steps described below:

1. Place the book or document onto the scanner.
2. Press the **Color**, **Gray** or **B/W** button on the scanner panel.

The scanner starts to scan immediately and carry out the corresponding action according to the settings you have set up in the Book Pavilion window.

Scanning from Plustek DI Capture Program

1. Click the Windows Start button to launch DI Capture.

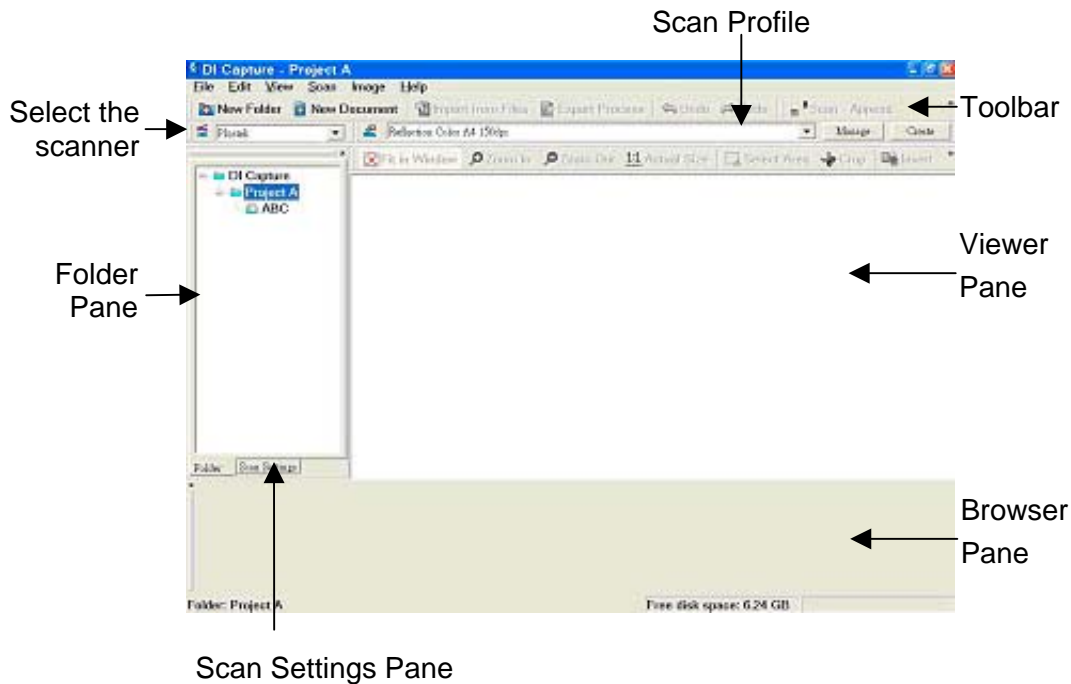

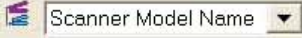
2. Within DI Capture, select this scanner from the drop-down list of .
3. Select a document from the **Folder Pane** to store the scanned images. (To create a new folder and/or a new document, click the **New Folder** and/or **New Document** button from the toolbar.)
4. Select an appropriate scan profile. (You may click the tab of **Scan Settings Pane** to check if the current settings of the selected scan profile meet your needs. If not, you may click the **Create** or **Manage** button beside the Scan Profile to create a new profile or modify an existing profile.)
5. Click the **Scan – Append** button from the toolbar.
6. When the scan finishes, all scanned images are displayed on the **Browser Pane**. The last scanned image appears on the **Viewer Pane**.



Alternatively you may click the **Scan Wizard** button from the toolbar to let the Scan Wizard guide you through the entire scan process.

You may also tailor your own user interface of DI Capture such as the toolbar buttons, Viewer Pane, Browser Pane, etc.

Refer to the online help of DI Capture to explore more about DI Capture!

Scanner Connection

The first step to take when troubleshooting connection problems with your scanner is to check all physical connections. The icon  , located on the Windows system tray, indicates if the scanner software is properly launched and the scanner and computer are communicating with each other.

Appearance	Status
	The program has been successfully launched and the scanner is connected with the computer, ready to scan images.
	The scanner is not connected with the computer. Or, the scanner power is not switched on.
No Display	You have chosen to terminate the program, no matter the scanner is connected or disconnected with the computer.

Aligning the Scanner

In most cases, the scanner doesn't need to be aligned but there are instances when the alignment might be required. You need to align the scanner only if parts of the scanned document are missing from any of its edges. For example, the heading of a document might be missing from the top edge after the document has been scanned.

1. Place the document onto the scanner glass headfirst and face-down. Align the top left corner of the document with the arrow on the reference mark.
2. From the Windows **START** menu, point to **All Programs > Your Scanner Model Name**, and then click **Scanner Utility**.
3. The Scanner Utility window opens. Find the **Initial Scanning Position Alignment** section and select **Flatbed Reflective** as the source.

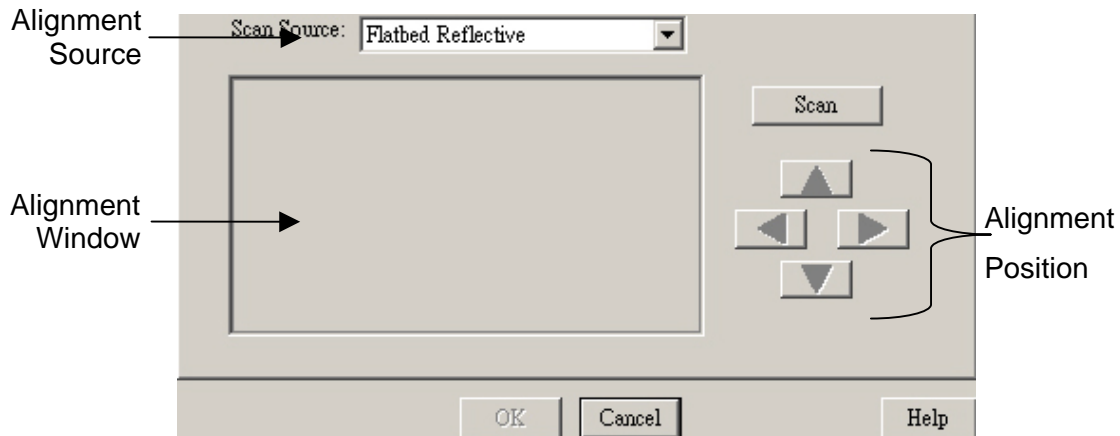

4. Click the **Scan** button. Part of the document image will be displayed in the Alignment Window.
5. Click the **Alignment Position** buttons (Up, Down, Left, Right) until the top left corner of the scanned document aligns with the top left corner of the Alignment Window.
6. When the alignment completes, click on **OK** button to save settings and exit.

Standby Mode

To save power consumption, the scanner will enter the standby mode after it is idle for a while. You may disable the standby mode or define an idle time for the scanner to automatically enter the standby mode.

1. From the Windows **START** menu, point to **All Programs > Your Scanner Model Name**, and then click **Scanner Utility**.
2. In the **Standby Mode** section of the Scanner Utility window that opens, click the button of your option:

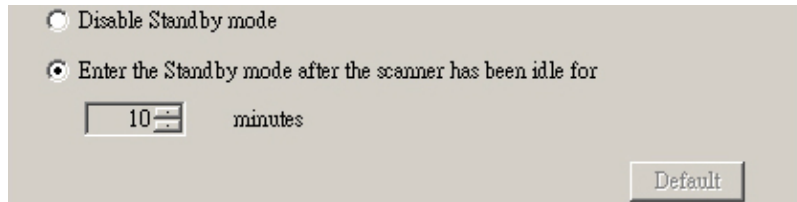

- a. To disable the Standby Mode: Click the button before **Disable Standby Mode**.
- b. To automatically enter the Standby Mode: Click the button before **Enter the Standby mode after the scanner has been idle for ... minutes** and then click the up or down arrows to set a default time for the scanner to automatically enter the Standby Mode.



Information

The scanner will enter the standby mode (sleep mode) after it is idle for 10 minutes. Simply press any scanner button on the scanner panel and the scanner will return back to the normal status.

3. Click on **OK** button to save settings and exit.
-



Warning

- To completely shut down the scanner, press the power switch on the side of the scanner.
 - If the scanner will not be used for a long period of time, shut down the scanner and then disconnect the power cable from the power outlet.
-

Alternatively you may click **Default** to restore the default settings. You may press any scanner button to wake up the scanner from power saving.

Scanner Lock

Your scanner is designed with two different lock statuses to protect the optical parts. To ensure the scanner working properly, you have to choose an appropriate lock status according to the situation.

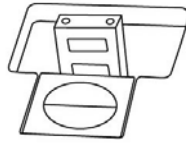

Auto Lock is for scanning on a smooth surface. The scanner will be locked automatically when the lock head is not pushed in. This lock status is recommended for general use.

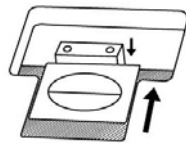

Always Unlock is for scanning on a surface that is not firm, unstable or too soft. Furthermore, if you place your scanner on a long-term position, you can also keep your scanner lock in this status.



Warning

If you use this lock status, ensure to relock the scanner before any movement to prevent damage of your scanner.

Usage & Maintenance Tips



Attention

To keep your scanner working smoothly, take a moment to review the following usage & maintenance tips.

- Avoid using the scanner in a dusty environment. Dust particles and other foreign objects may damage the unit.
- Do not subject the scanner to excessive vibration. It may damage the internal components.
- Clean the scanner glass by lightly spraying a non-abrasive glass cleaner onto a soft lint-free cloth. Then, wipe the glass thoroughly with the cloth. **DO NOT SPRAY CLEANER DIRECTLY ONTO THE SCANNER GLASS.** Excess liquid residue may fog or damage the scanner.
- Your scanner operates best in temperatures between 10° C and 40° C (50° F to 104° F).

Appendix A: Specifications⁴

Plustek OpticBook 4800	
Physical Dimensions	491 x 291 x 102 mm (19.3" x 11.4" x 4")
Weight	3.45 Kg (7.6 Lbs)
Operating Temperature	10° C to 40° C (50° F to 104° F)
Scanning Speed (300 dpi, A4 Size)	Color Mode: 3.6 sec. Grayscale Mode: 3.6 sec. Black & White Mode: 3.6 sec. Note : Results may vary depending upon your scanning application, computer processor and system memory.
Scan Area	Maximum 216 mm x 297 mm (8.5" x 11.69") Minimum 12.7 x 12.7 mm (0.5" x 0.5")
Scan Modes	Color: Input 48-bit; Output 24-bit Grayscale: Input 16-bit; Output 8-bit Black & White: 1-bit
Resolution	Optical Resolution: 1200 dpi Max. Hardware Resolution: 1200 dpi x 2400 dpi
Scanning Materials	Reflective color or black-and-white originals
Protocols	TWAIN Compliant
Interface	USB 2.0 High Speed and Full-Speed Mode
Light Source	LED
Power Adapter	Power Output DC 24V, 0.75A
Power Consumption	Operation: 18 watts maximum Idle: 5 watts
EMI	FCC Class B, CE
Environment Requirement	RoHS/WEEE

⁴ Hardware specifications may change at any time without prior notice.

Appendix B: Customer Service and Warranty

If you encounter problems with your scanner, please review the installation instructions and troubleshooting suggestions contained in this guide.

For further assistance call our customer support phone number listed on the last page of this guide. One of our representatives will be happy to assist you from Monday through Friday in office working hours as shown below:

Europe	9:00 a.m. – 5:30 p.m. (CET)
Other Countries or Areas	9:00 a.m. – 6:00 p.m. Taiwan Time

To avoid delays, please have the following information available before calling:

- Scanner name and model number
- Scanner serial number (Located at the bottom of the scanner)
- A detailed description of the problem
- Your computer manufacturer and its model number
- The speed of your CPU (Pentium 233, etc.)
- Your current operating system and BIOS (optional)
- Name of software package(s), version or release number and manufacturer of the software
- Other USB devices installed

Service & Support Information (For EU country only)

Where appropriate, the period of availability of spare parts and the possibilities of upgrading products information. Please ask local distributors and suppliers for spare parts information and product upgrade information.

Information requested by relevant Implementing Measure. Please ask local distributors and suppliers for the related information of Implementing Measure test report.

Do not dispose anything of products before you ask local distributors and suppliers to get correct information for decreases of environmental impact with right methods and procedures.

If you want to disposals the product and/or an accessory, please ask local distributors and suppliers to get the contact information of nearest disposal manufactures.

If you have any maintenance inquiry, please ask local distributors and suppliers to get the contact information of nearest maintenance center in order to extend the product usage life time.

If you want to maintain and clear the product, please ask local distributors and suppliers to get the right information of nearest stores.

Statement of Limited Warranty

This Statement of Limited Warranty applies only to the options you originally purchase for your use, and not for resale, from an authorized reseller.

The manufacturer warranty includes all parts and labor, and is not valid without the receipt of original purchase. To obtain warranty service, you may contact the authorized dealer or distributor, or visit our website to check out the available service information, or send a request via E-mail for further help.

If you transfer this product to another user, warranty service is available to that user for the remainder of the warranty period. You should give your proof of purchase and this statement to that user.

We warrant that this machine will be in good working order and will conform to its functional descriptions in the documentation provided. Upon provision of proof of purchase, replacement parts assume the remaining warranty of the parts they replace.

Before presenting this product for warranty service, you must remove all programs, data and removable storage media. Products returned without guides and software will be replaced without guides and software.

This Limited Warranty service does not provide for carry-in exchange when the problem results from accident, disaster, vandalism, misuse, abuse, unsuitable environment, program modification, another machine or non-vendor modification for this product.

If this product is an optional feature, this Limited Warranty applies only when the feature is used in a machine for which it was designed.

If you have any questions about your Limited Warranty, contact the approved retailer from whom you bought the product or the manufacturer.

THIS LIMITED WARRANTY REPLACES ALL OTHER WARRANTIES, EXPRESS OR IMPLIED, INCLUDING, BUT NOT LIMITED TO, THE IMPLIED WARRANTIES OF MERCHANTABILITY AND FITNESS FOR A PARTICULAR PURPOSE. HOWEVER, SOME LAWS DO NOT ALLOW THE EXCLUSION OF IMPLIED WARRANTIES. IF THESE LAWS APPLY, THEN ALL EXPRESS AND IMPLIED WARRANTIES ARE LIMITED IN DURATION TO THE WARRANTY PERIOD. NO OTHER WARRANTIES APPLY AFTER THAT PERIOD.

Some jurisdictions do not allow limitations on how long an implied warranty lasts, so the above limitation may not apply.

Under no circumstances are we liable for any of the following:

1. Third party claims against you for losses or damages.

2. Loss of, or damage to, your records or data; or
3. Economic consequential damages (including lost profits or savings) or incidental damages, even if we are informed of their possibility.

Some jurisdictions do not allow the exclusion or limitations of incidental or consequential damages, so the above limitation or exclusion may not apply to you.

This Limited Warranty gives you specific legal rights, and you may also have other rights that vary from jurisdiction to jurisdiction.

FCC Radio Frequency Statement

This equipment has been tested and found to comply with the limits for a Class B digital device, pursuant to part 15 of the FCC rules. These limits are designed to provide reasonable protection against harmful interference in a residential installation.

This equipment generates, uses and can radiate radio frequency energy and, if not installed and used in accordance with the instructions, may cause harmful interference to radio communications. However, there is no guarantee that interference will not occur in a particular television reception (which can be determined by turning the equipment off and on), the user is encouraged to try to correct the interference by one or more of the following measures:

- Reorient or relocate the receiving antenna.
- Increase the separation between the equipment and receiver.
- Connect the equipment to an outlet on a circuit different from that which the receiver is connected.
- Shielded interconnect cables and shielded power cord which are supplied with this equipment must be employed with this equipment to ensure compliance with the pertinent RF emission limits governing this device.
- Consult the dealer or an experienced radio/TV technician for help if the conditions persist.
- Changes or modifications not expressly approved by the manufacturer or authorized service center could void the user's authority to operate this equipment.

This device complies with Part 15 of the FCC Rules. Operation is subject to the following two conditions: (1) this device may not cause harmful interference, and (2) this device must accept any interference received, including interference that may cause undesired operation.

Contacting Plustek

Europe: Plustek Technology GmbH
An der Strusbek 60-62
22926 Ahrensburg
Germany

Tel.: +49 (0) 4102-8913-0
Fax: +49 (0) 4102-8913-500/508
E-mail: support@plustek.de
Website: www.plustek.de

North America: Plustek Technology Inc.
17517 Fabrica Way, Suite B
Cerritos, CA 90703
U.S.A.

Tel: +1 -714-670-7713
Fax: +1 -714-670-7756
E-mail: supportusa@plustek.com

**Worldwide except
Europe & North America:** Plustek Inc.
13F-1, No.3 (Building F), Yuan Qu Street
115 Nankang, Taipei
Taiwan

Tel: +886-2-2655 7866
Fax: +886-2-2655 7833
Website: www.plustek.com

Visit our website
www.plustek.com
for more customer service information.