



Questo manuale d'istruzione è fornito da [trovaprezzi.it](https://trovaprezzi.it). Scopri tutte le offerte per [Razer Barracuda X Rosa](#) o cerca il tuo prodotto tra le [migliori offerte di Cuffie e Microfoni](#)



RAZER BARRACUDA X (2022)

MASTER GUIDE

Immersive home gaming, seamless on-the-go audio—the **Razer Barracuda X** is built for both. Upgraded with Razer SmartSwitch Dual Wireless for seamless toggling between high-speed 2.4GHz and Bluetooth, enjoy true versatility backed by long-lasting comfort, powerful drivers, and a crystal-clear mic.

# CONTENTS

1. WHAT'S INSIDE .....	3
2. WHAT'S NEEDED .....	4
3. TECHNICAL SPECIFICATIONS.....	5
4. LET'S GET YOU COVERED .....	6
5. GETTING STARTED .....	7
6. USING YOUR HEADSET .....	11
7. SAFETY AND MAINTENANCE .....	18
8. LEGALESE.....	19

---

## 1. WHAT'S INSIDE

- Razer Barracuda X

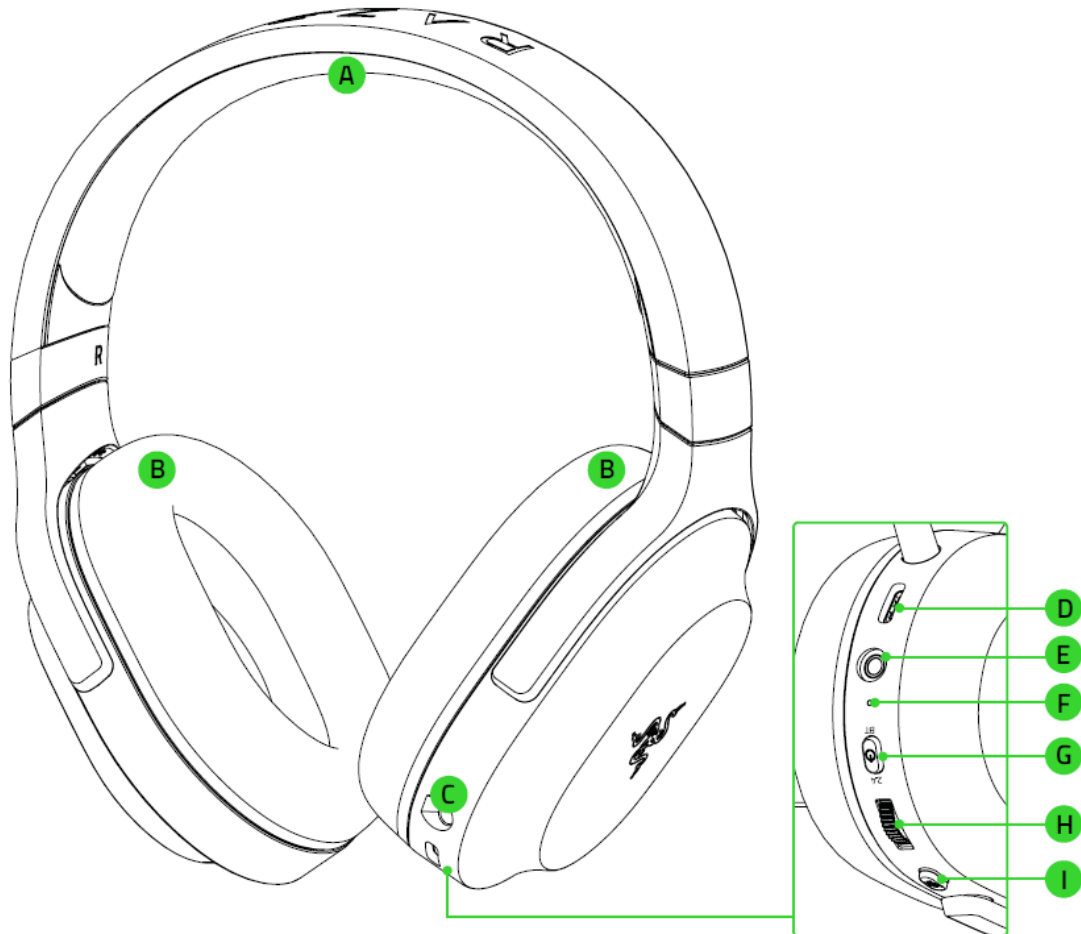

- A.** Adjustable padded headband
- B.** Ultra-soft leatherette memory foam ear cushions
- C.** Microphone jack
- D.** Type-C charging port
- E.** 3.5 mm audio + mic jack
- F.** Status indicator
- G.** Razer SmartSwitch / Power button
- H.** Volume control wheel
- I.** Mic mute button

- Type-C wireless dongle

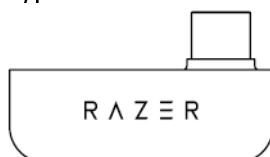

- Removable Razer™ HyperClear Cardioid Mic

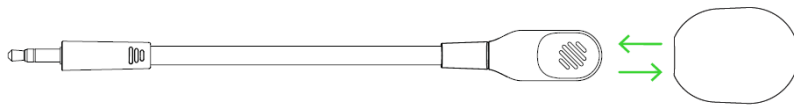

- Type-C charging cable

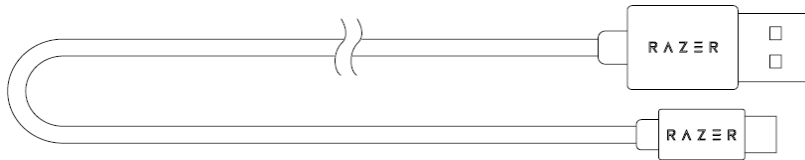

- Type-A to Type-C adapter cable

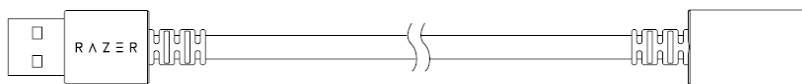

- 3.5 mm combo cable

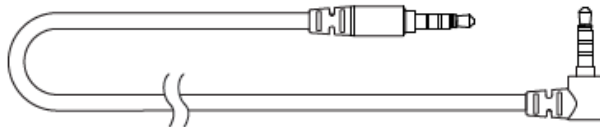

- Important Product Information Guide

---

## 2. WHAT'S NEEDED

### PRODUCT REQUIREMENTS

- [Wireless] Devices with Bluetooth audio capability / USB Type-C or Type-A port
- [Wired] 3.5 mm audio + mic combined jack

### RAZER AUDIO APP REQUIREMENTS

- iOS 12 / Android 8.1 Oreo (or higher) device with Bluetooth connectivity
- Internet connection for app installation

---

## 3. TECHNICAL SPECIFICATIONS

### HEADPHONES

- Frequency response: 20 Hz – 20 kHz
- Impedance: 32  $\Omega$  @ 1 kHz
- Sensitivity : 96dB SPL/mW@1KHz by HATS
- Drivers: Customized Dynamic 40 mm Driver
- Inner ear cup diameter: 60 mm x 40 mm
- Connection type: Bluetooth, USB Type C Dongle
- Cable length: 1.5 m / 4.92 ft
- Approx. weight: 250 g / 0.55 lbs
- Oval ear cushions: Full-ear coverage with fabric and plush leatherette, for sound isolation and comfort

### MICROPHONE

- Frequency response: 100 Hz – 10 kHz
- Signal-to-noise ratio:  $\geq$  60 dB
- Sensitivity (@1 kHz):  $-42 \pm 3$  dB
- Pick-up pattern: Unidirectional
- On-earcup controls
- Volume up and down
- Mic mute on/off toggle

### AUDIO USAGE

- Wireless: Via Type-C dongle or Bluetooth 5.2
- Wired: 3.5 mm analog
- Bluetooth Codec: SBC
- Surround sound: Only available on Windows 10 64-bit (or higher)

---

## 4. LET'S GET YOU COVERED

You've got a great device in your hands, complete with a 2-year limited warranty coverage. Now maximize its potential and score exclusive Razer benefits by registering at [razerid.razer.com](https://razerid.razer.com)

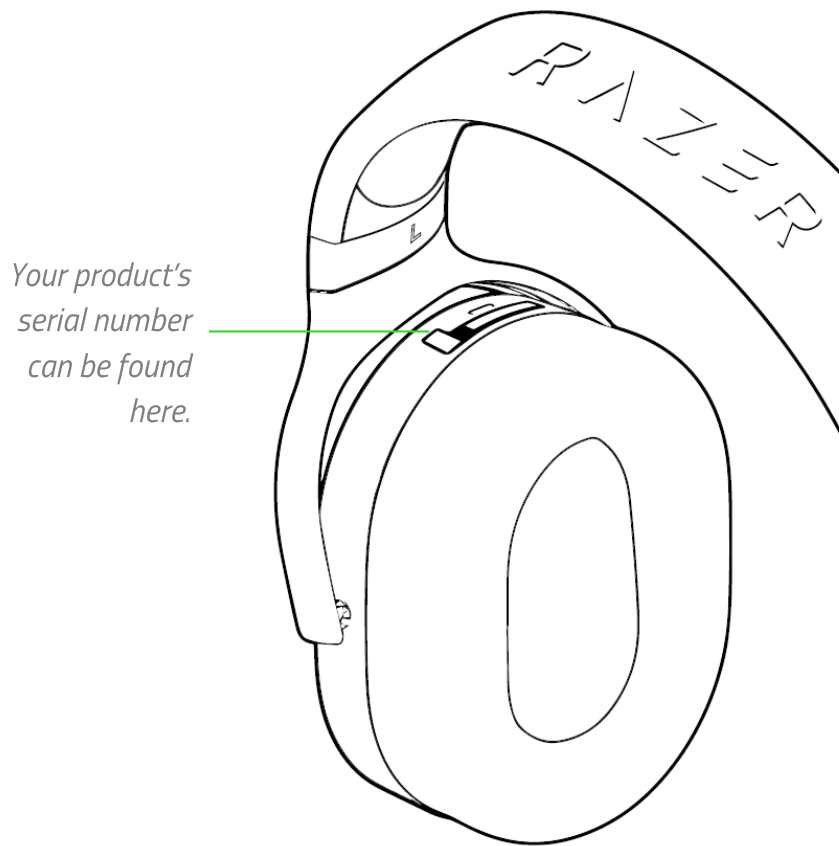

Got a question? Ask the Razer Support Team at [support.razer.com](https://support.razer.com)



---

## 5. GETTING STARTED

### CHARGING YOUR HEADSET

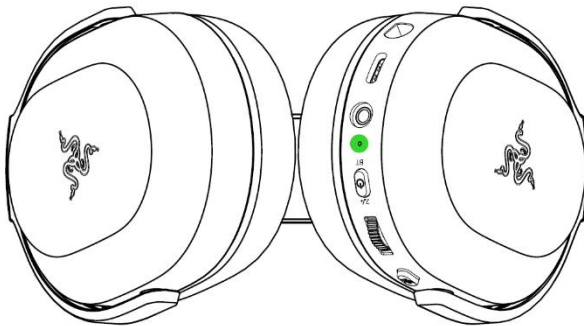
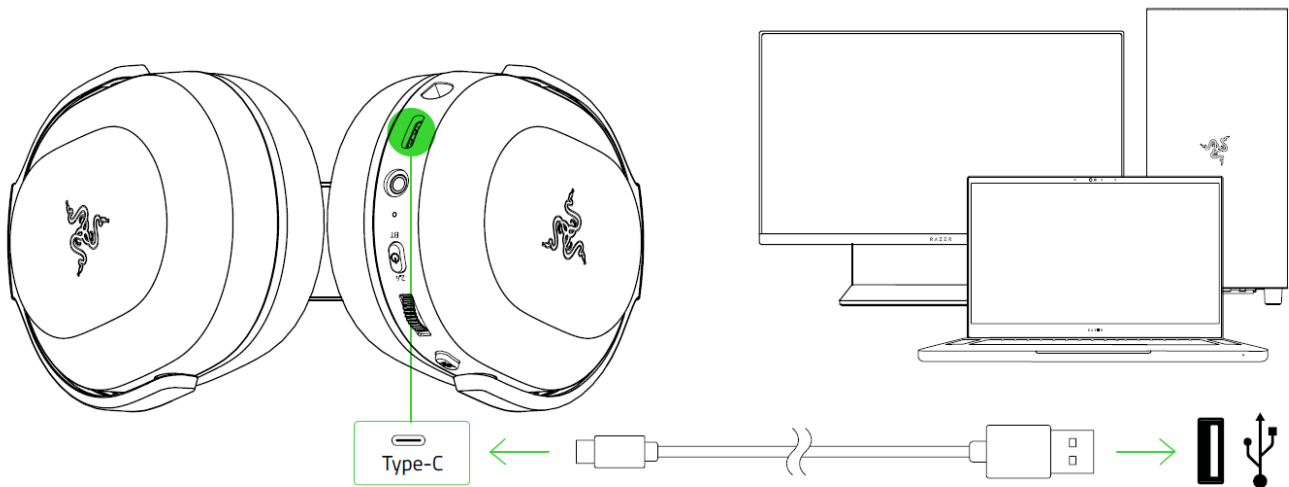
Connect your Razer Barracuda X to a powered USB Type-A port using the charging cable. For best results, please fully charge your headset before using it for the first time. A depleted unit will fully charge in about 4 hours.



Indicator	Battery level
	Fully charged
	Charging

## CONNECTING TO YOUR DEVICES

### A. Via Type-C wireless dongle (2.4GHz)

1. Plug the Type-C wireless dongle into your device.

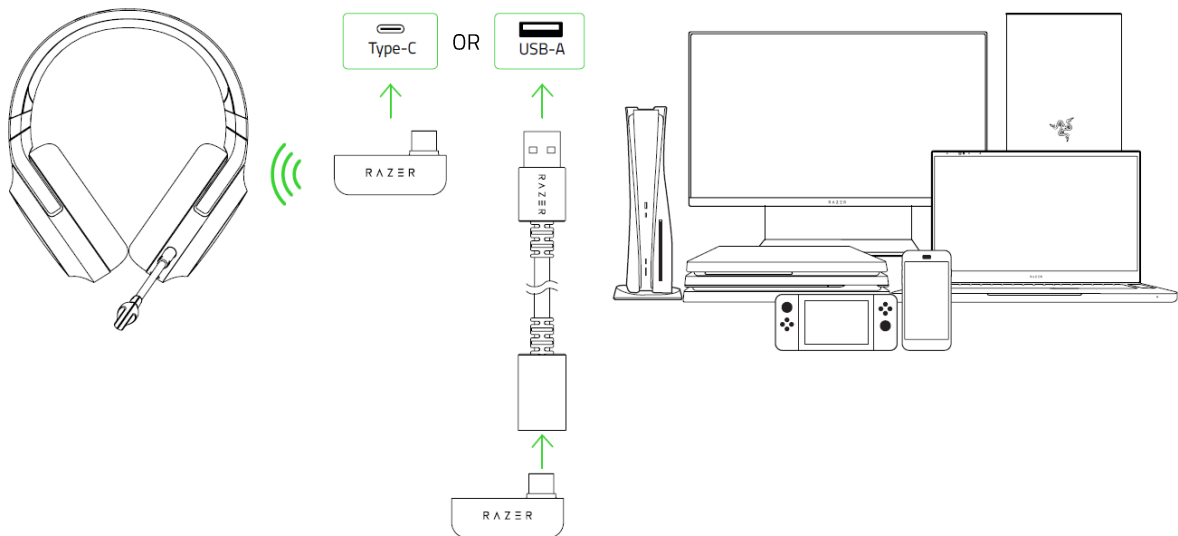

2. Press and hold the Razer SmartSwitch / Power button until the status indicator briefly lights up.

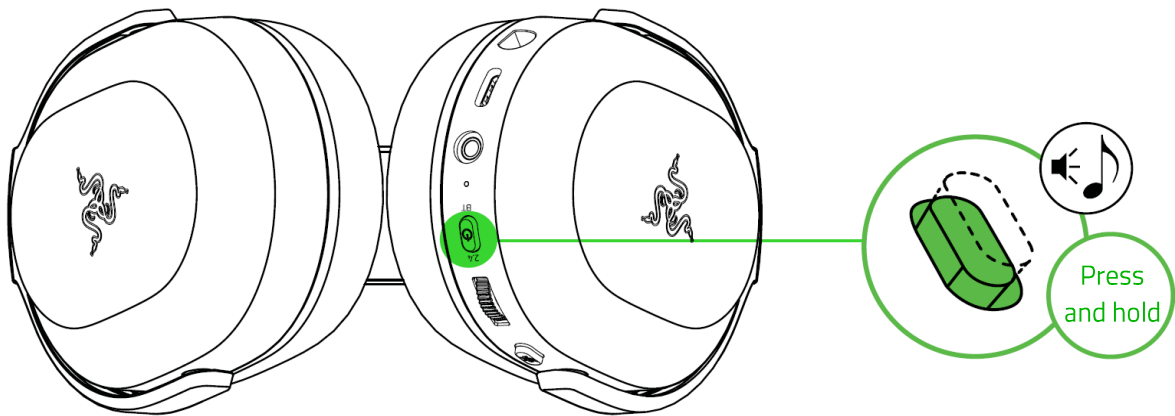

3. Wait until the status indicator briefly becomes static green indicating that the headset is connected to the Type-C wireless dongle.

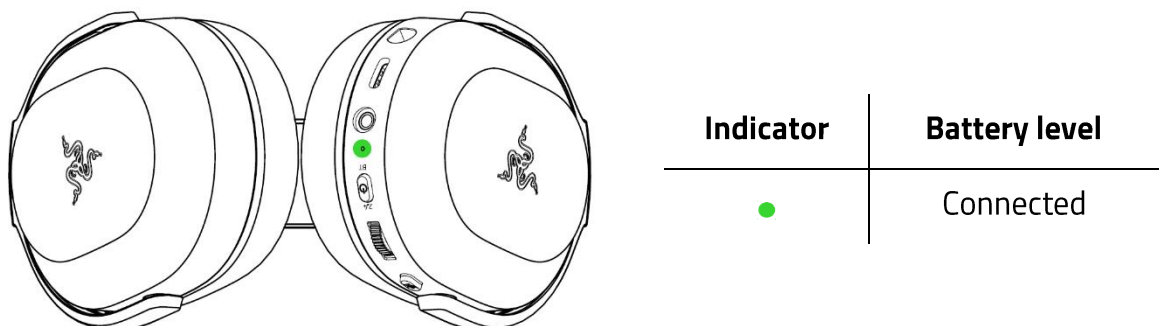

4. On your device (if applicable), set the Razer Barracuda X as the default **Input** and **Output Device**.

#### On **PC / Laptop**

- a. Right-click on the sound icon on the system tray and select **Open Sound settings**.
- b. On the Sound window, set **Razer Barracuda X 2.4** as the default **Output** and **Input** device.

#### On **PlayStation 5**, go to **Settings > Sound**

- On **Microphone**, set the **Input Device** to **Razer Barracuda X 2.4**.
- On **Audio Output**, set the **Output Device** to **Razer Barracuda X 2.4**.



#### On **PlayStation 4**, go to **Settings > Devices > Audio Devices**

- Set the **Input Device** and **Output Device** to **Razer Barracuda X 2.4**.

### B. Via Bluetooth

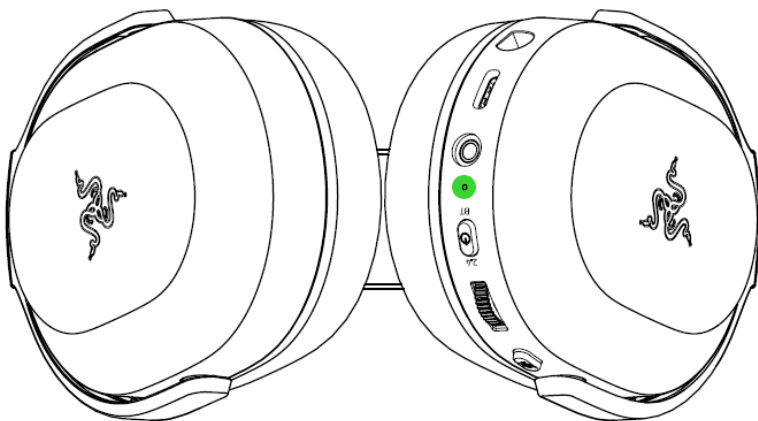
While powered off, press the Razer SmartSwitch / Power button for 5 seconds to activate Bluetooth pairing mode. Follow your device's instructions and select "**Razer Barracuda X (BT)**" from the list of found devices. The status indicator will briefly change to static blue to indicate that the headset is now paired with your device.



Indicator	Status
	Pairing
	Paired

### C. Via 3.5 mm audio + mic jack

If your device has a 3.5mm audio + mic combined jack, plug the 3.5mm combo cable from your headset into your device's audio jack.

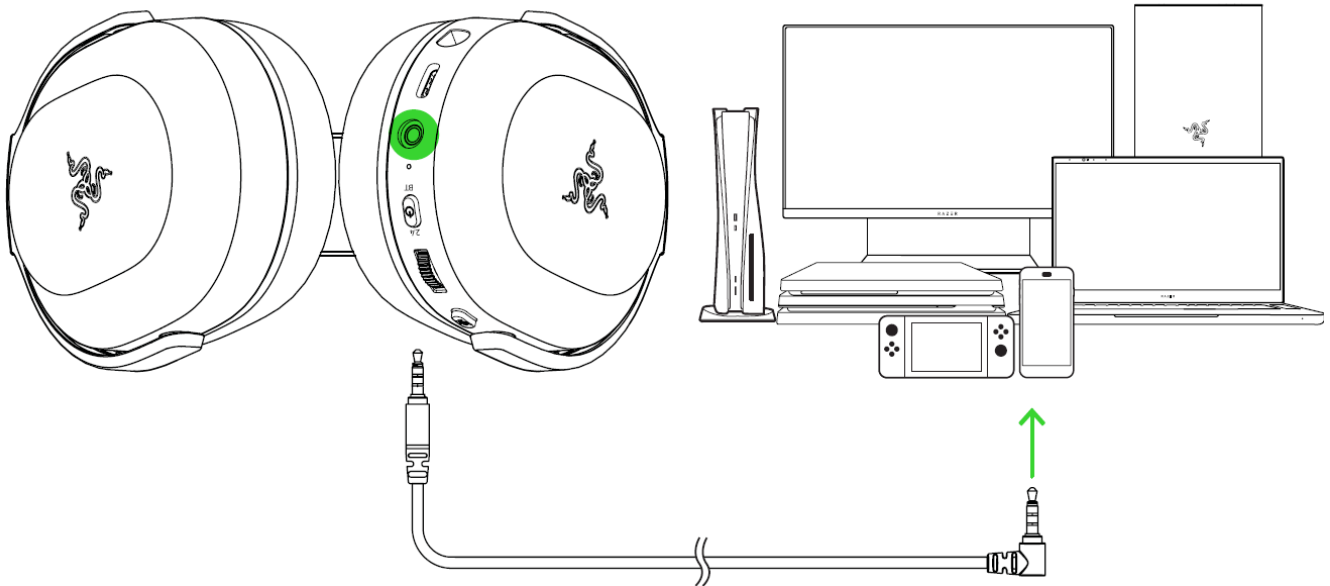

### RAZER AUDIO APP (MOBILE)

Making advanced customization just got a whole lot easier for the Razer Barracuda X. With the Razer Audio App, you'll be able to customize its EQ settings and auto shutoff feature, enable or disable gaming mode, and much more — anytime, anywhere.

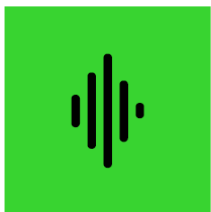

Razer Audio



OR



RZR.TO/AUDAPP  
(For China only)



*When using the app, make sure that the headset is only connected to your mobile device via Bluetooth. A solid blue status indicator indicates this connection.*

---

## 6. USING YOUR HEADSET

### BATTERY LEVEL

When unplugged and powered on, the status indicator will show the connection and battery status. While in use, you'll hear a voice prompt when the headset needs to be recharged; during such time, the indicator will continue showing the battery level until you charge the headset.

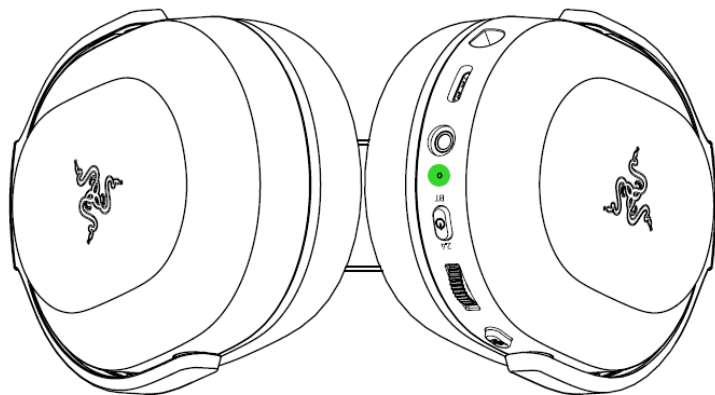

Indicator	Prompt	Battery level
	Voice	Low

### RAZER SMARTSWITCH / POWER BUTTON

#### Power ON / OFF

Power on the headset by holding the Razer SmartSwitch / Power button until the status indicator is on and holding the Power button again to turn off. An audio prompt will help notify you when the headset is powered on or off.

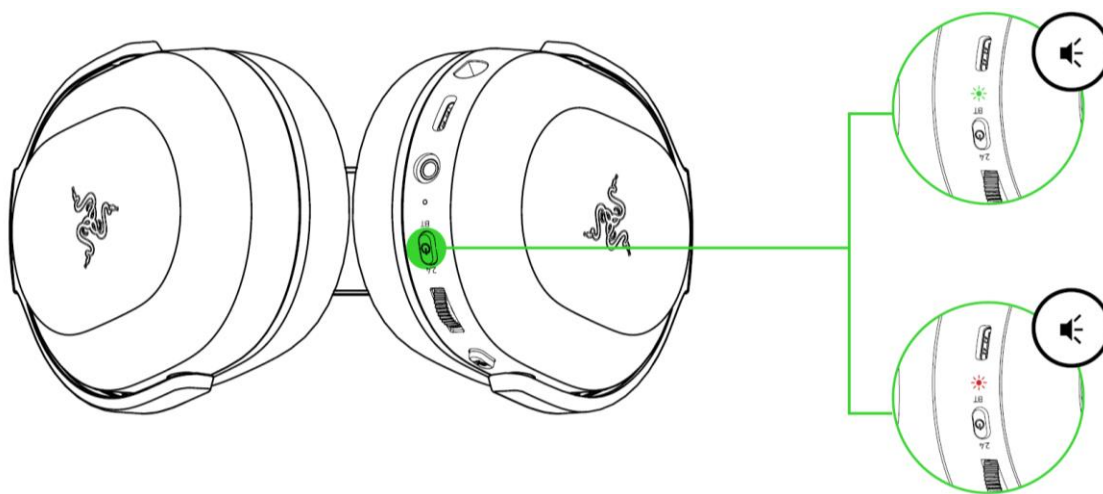

**i** The headset will power on using the last audio source before powering it off.

## Switching audio source

When powered on and connected to any audio source, triple press the Razer SmartSwitch / Power button to switch between the Type-C wireless dongle and Bluetooth audio source or vice versa.

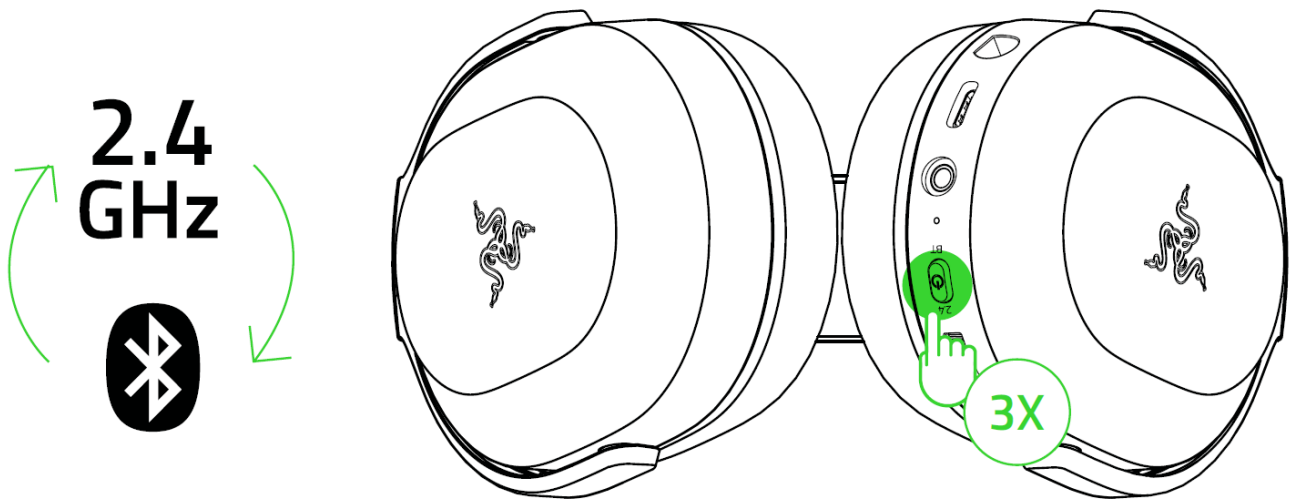

- i** Using Bluetooth as the audio source will reconnect the headset to the last known device. Pairing mode will be activated if no device is found.

## Other functions

Other Razer SmartSwitch / Power button functions are available when the headset is powered on with Bluetooth as the audio source. These functions operate based on your device's current activity and may not apply to certain devices.

Single press	Play/pause*
	Accept incoming call or end current call
	Put call on hold and accept incoming call
	End call and swap to on-hold call
Double press	Skip track
	Reject incoming call
	Swap call
Triple press	Switch audio source
While powered off, press and hold for 5 seconds	Activate Bluetooth pairing mode

*\*You can also use this function when using the Type-C wireless dongle as an audio source.*

## UNDERSTANDING RAZER SMARTSWITCH

With the Razer Barracuda X simultaneously connected to a PC or gaming console (via Type-C wireless dongle) and a mobile device (via Bluetooth), you'll be able to conveniently take calls from a connected Bluetooth device and switch back to the game audio without removing the headset. The status indicator will briefly show static white to indicate that the headset is connected to both audio sources.

The following behaviors below will help you understand how your headset responds to audio source switching and incoming calls when your headset is connected to a Bluetooth device and Type-C wireless dongle:

Headset audio	Razer SmartSwitch behavior
Streaming via Type-C wireless dongle	<ul style="list-style-type: none"> <li>▪ The headset will automatically switch to Bluetooth audio source for incoming calls from your mobile device and resume using the Type-C wireless dongle after each call.</li> <li>▪ When the same app rings on your PC and mobile device (e.g., Teams, Messenger), using the Razer SmartSwitch button to answer the incoming call will automatically switch the headset to Bluetooth audio source. The headset will resume using the Type-C wireless dongle after each call.               <ul style="list-style-type: none"> <li> <i>You can deactivate automatic source switching for incoming calls by enabling your headset's Do Not Disturb feature on the Razer Audio app.</i></li> </ul> </li> <li>▪ Audio from the connected mobile device will ONLY automatically stream on the headset if no audio is present or streaming on the Type-C wireless dongle.</li> <li>▪ Auto-pause on streamed audio when switching audio sources depends on the app you're using (e.g., Spotify, Apple Music).</li> </ul>
Streaming via Bluetooth	<ul style="list-style-type: none"> <li>▪ When you switch to the Type-C wireless dongle audio source, your headset will remain connected to your mobile device via Bluetooth. However, the Razer Audio app will disconnect from your mobile device.</li> <li>▪ Auto-pause on streamed audio when switching audio sources depends on the app you're using (e.g., Spotify, Apple Music).</li> </ul>
Not streaming on any audio source	Audio will play on the first audio source that streams audio.

## VOLUME WHEEL

Rotate the Volume wheel to increase or decrease the volume.

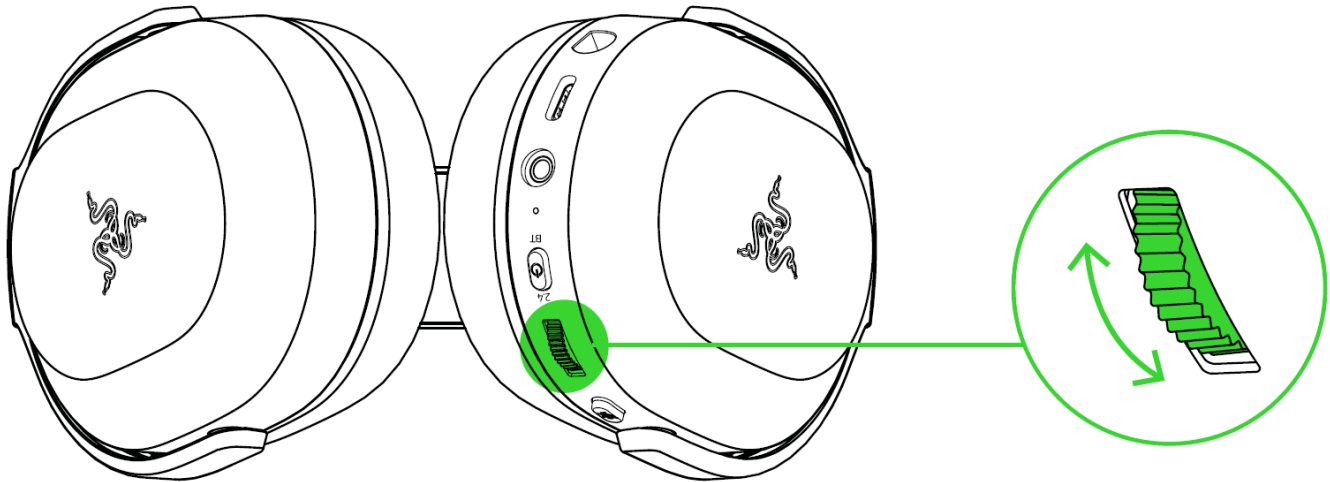

## USING THE RAZER™ HYPERCLEAR CARDIOID MIC

Plug the Razer™ HyperClear Cardioid Mic into the microphone jack and bend until it is parallel to your mouth. Ensure the mic diaphragm is in front and the air vent faces away from your mouth.

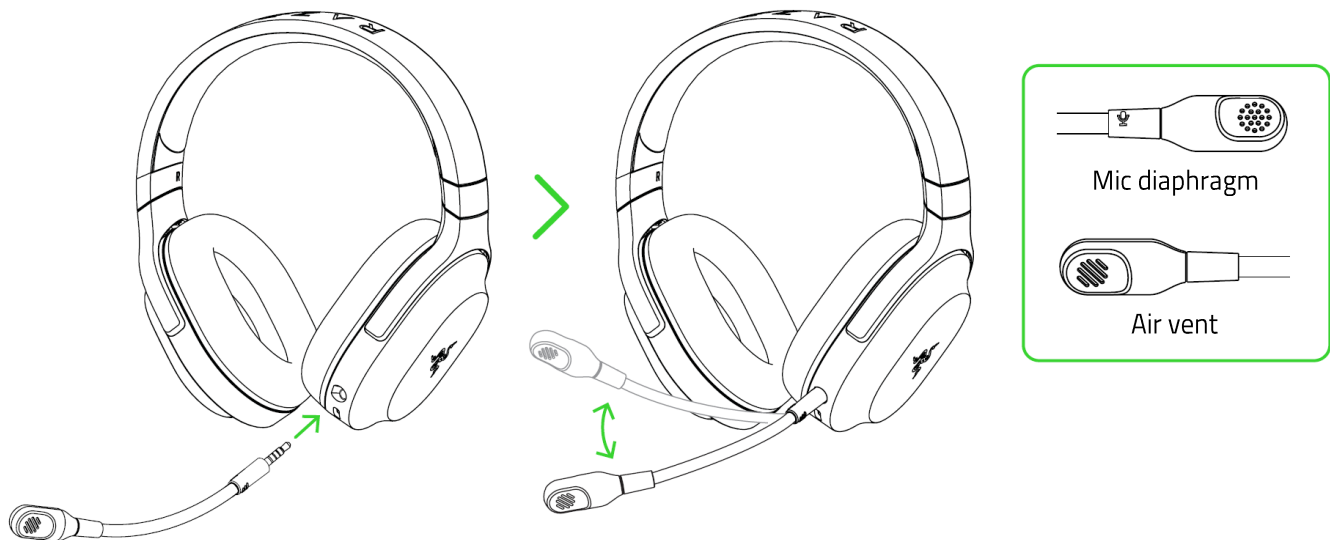

## MUTING / UNMUTING THE MICROPHONE

Press the mic mute button to mute or unmute the microphone.

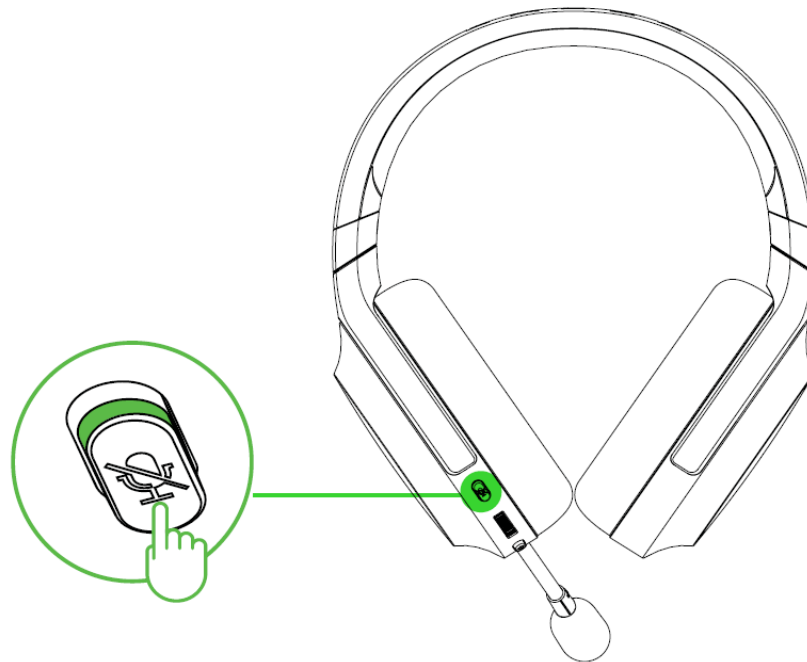

## EXTENDING YOUR HEADSET'S LIFESPAN

We recommend stretching the headset gently apart before placing them over your head to minimize headband stress. However, please avoid overstretching the headset beyond its technical limits.



## **ACTIVATE THE 7.1 SURROUND SOUND\***

Experience accurate positional sound specifically designed for games, movies, and music.

1. Download the 7.1 Surround Sound software from [razer.com/7.1-surround-sound](https://razer.com/7.1-surround-sound).
2. Register your product at [razerid.razer.com/products](https://razerid.razer.com/products) to get your activation code sent to your email.

*\*Only available on Windows 10 64-bit and above.*

---

## 7. SAFETY AND MAINTENANCE

### SAFETY GUIDELINES

To achieve maximum safety while using your Razer Barracuda X, we suggest that you adopt the following guidelines:

Should you have trouble operating the device properly and troubleshooting does not work, unplug the device and contact the Razer hotline or go to [support.razer.com](https://support.razer.com) for assistance.

Do not take apart the device and do not attempt to operate it under abnormal current loads. Doing so will void your warranty.

Keep the device away from liquid, humidity, or moisture. Operate the device only within the specific temperature range of 0°C (32°F) to 40°C (104°F). Should the temperature exceed this range, unplug and/or switch off the device in order to let the temperature stabilize to an optimal level.

The device isolates external ambient sounds even at low volumes, resulting in lowered awareness of your external surroundings. Please remove the device when engaging in activities that require active awareness of your surroundings.

Listening to excessively loud volumes over extended periods can damage your hearing. Furthermore, legislation of certain countries permits a maximum sound level of 86db to affect your hearing for 8 hours a day. We, therefore, recommend that you reduce the volume to a comfortable level when listening for prolonged periods. Please, take good care of your hearing.

### MAINTENANCE AND USE

The Razer Barracuda X requires minimum maintenance to keep it in optimum condition. Once a month, we recommend you clean it using a soft cloth or cotton swab to prevent dirt buildup. Do not use soap or harsh cleaning agents.

### BATTERY WARNING

The Razer Barracuda X contains a Li-ion rechargeable battery. In general, the life expectancy of such batteries is dependent upon usage. If you suspect that the Li-ion rechargeable battery inside the Razer Barracuda X may be drained (has a low charge), try charging it.

**Caution:** Do not open, mutilate, or expose to conducting materials (metal), moisture, liquid, fire, or heat. Doing so may cause batteries to leak or explode, resulting in personal injury. Battery life varies with usage.

---

## 8. LEGALESE

### **COPYRIGHT AND INTELLECTUAL PROPERTY INFORMATION**

©2022 Razer Inc. All rights reserved. Razer, the triple-headed snake logo, Razer logo, and “For Gamers. By Gamers.” are trademarks or registered trademarks of Razer Inc. and/or affiliated companies in the United States or other countries. All other trademarks are the property of their respective owners.

Android, Google, Google Logo, Google Play, and the Google Play logo are registered trademarks of Google LLC.

Apple, the Apple logo, and iPhone are trademarks of Apple Inc., registered in the U.S. and other countries. App Store is a service mark of Apple Inc. iOS is a trademark or registered trademark of Cisco in the U.S. and other countries and is used under license.

The Bluetooth® word mark and logos are registered trademarks owned by Bluetooth SIG, Inc., and any use of such marks by Razer is under license.

Windows and the Windows logo are trademarks or registered trademarks of the Microsoft group of companies.

Razer Inc. (“Razer”) may have copyright, trademarks, trade secrets, patents, patent applications, or other intellectual property rights (whether registered or unregistered) concerning the product in this guide. Furnishing of this guide does not give you a license to any such copyright, trademark, patent or other intellectual property right. The Razer Barracuda X (the “Product”) may differ from pictures, whether on packaging or otherwise. Razer assumes no responsibility for such differences or for any errors that may appear. Information contained herein is subject to change without notice.

### **LIMITED PRODUCT WARRANTY**

For the latest and current terms of the Limited Product Warranty, please visit [razer.com/warranty](https://www.razer.com/warranty).

### **LIMITATION OF LIABILITY**

Razer shall in no event be liable for any lost profits, loss of information or data, special, incidental, indirect, punitive or consequential or incidental damages, arising in any way out of distribution of, sale of, resale of, use of, or inability to use the Product. In no event shall Razer’s liability exceed the retail purchase price of the Product.

## **GENERAL**

These terms shall be governed by and construed under the laws of the jurisdiction in which the Product was purchased. If any term herein is held to be invalid or unenforceable, then such term (in so far as it is invalid or unenforceable) shall be given no effect and deemed to be excluded without invalidating any of the remaining terms. Razer reserves the right to amend any term at any time without notice.