



Questo manuale d'istruzione è fornito da [trovaprezzi.it](https://trovaprezzi.it). Scopri tutte le offerte per [Razer BlackShark V2 HyperSpeed Nero](#) o cerca il tuo prodotto tra le [migliori offerte di Cuffie e Microfoni](#)



# RAZER BLACKSHARK V2 HYPERSPEED

MASTER GUIDE

Get the non-stop comfort you need for all-day competitive play with the **Razer BlackShark V2 HyperSpeed**—a wireless ultra-lightweight esports headset. Designed for maximum performance and minimal weight, experience a level of clarity and power that never gets in the way of your game.

# CONTENTS

1. WHAT'S INSIDE .....	3
2. WHAT'S NEEDED .....	4
3. LET'S GET YOU COVERED.....	5
4. TECHNICAL SPECIFICATIONS .....	6
5. SETTING UP YOUR RAZER BLACKSHARK V2 HYPERSPEED.....	7
6. USING YOUR HEADSET .....	13
7. CONFIGURING YOUR RAZER BLACKSHARK V2 HYPERSPEED VIA RAZER SYNAPSE .....	21
8. SAFETY AND MAINTENANCE .....	34
9. LEGALESE.....	35

---

## 1. WHAT'S INSIDE

- Razer BlackShark V2 HyperSpeed

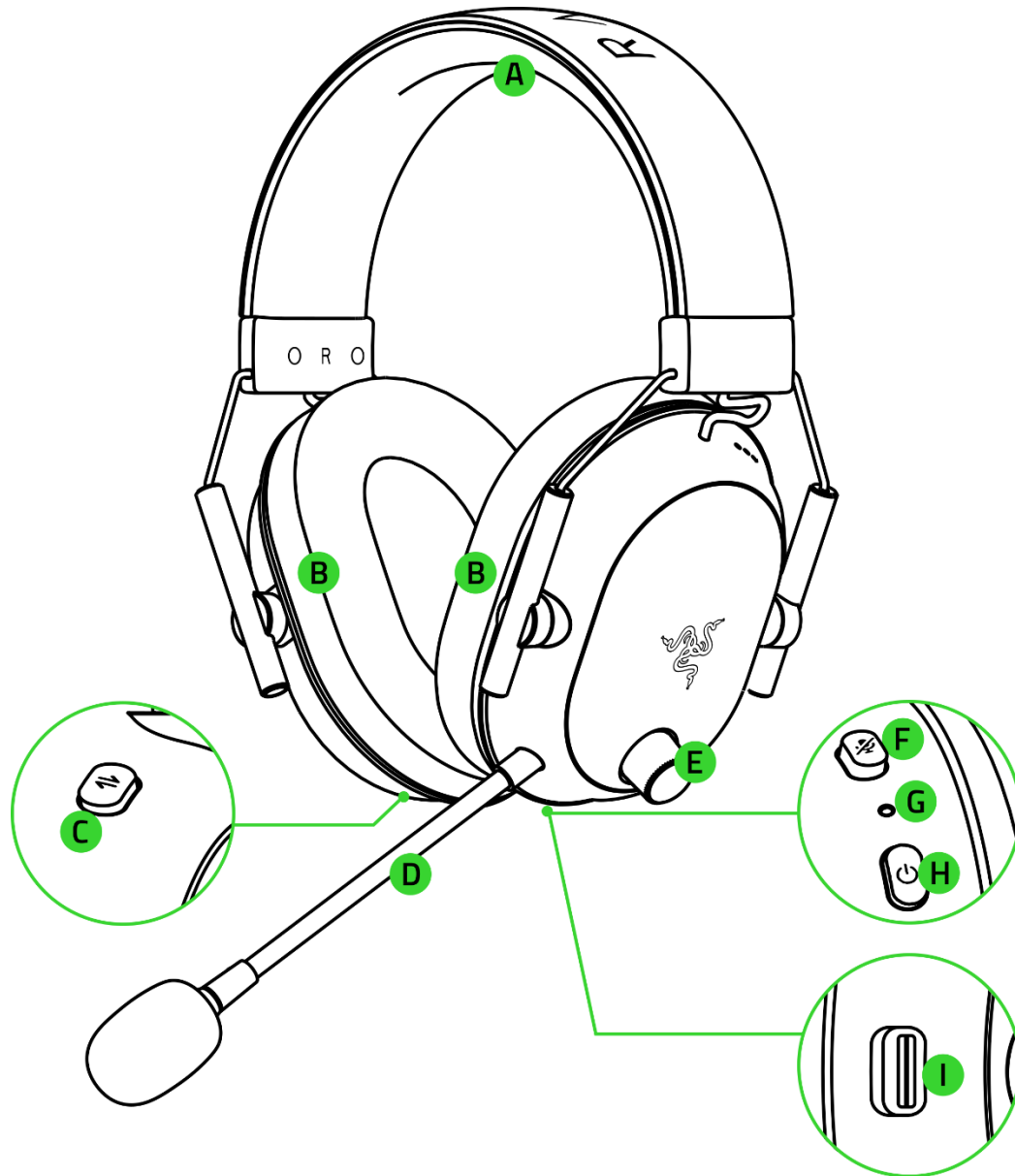

- A. Adjustable padded headband
- B. Ultra-soft breathable memory foam ear cushions
- C. Razer SmartSwitch / EQ button
- D. Razer HyperClear Super Wideband Mic

- E. Volume knob
- F. Mic mute button
- G. Headset indicator LED
- H. Power button
- I. USB Type C port

- Razer HyperSpeed Wireless dongle

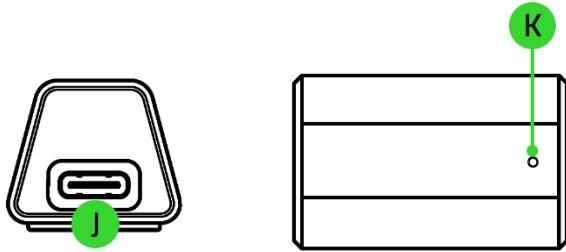

- J. USB Type C port
- K. Dongle indicator LED

- USB Type A to USB Type C charging cable

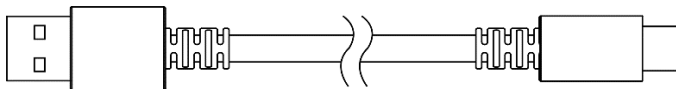

- Important Product Information Guide

---

## 2. WHAT'S NEEDED

### PRODUCT REQUIREMENTS

- USB Type A port or devices with Bluetooth connectivity

### RAZER SYNAPSE REQUIREMENTS

- Windows® 10 64-bit (or higher)
- Internet connection for software installation

---

### 3. LET'S GET YOU COVERED



Register your product and score exclusive benefits  
[razerid.razer.com/warranty](https://www.razerid.razer.com/warranty)



---

## 4. TECHNICAL SPECIFICATIONS

### HEADPHONES

- Frequency response: 12 Hz – 28 kHz
- Impedance: 32  $\Omega$
- Sensitivity (@1 kHz): 100 dB SPL / mW at 1 kHz by HATS
- Drivers: Customized Dynamic 50 mm Driver
- Inner ear cup diameter: 62 x 42 mm / 2.44 x 1.65 in
- Connection type: 2.4 GHz wireless or Bluetooth or USB
- Oval ear cushions: Breathable memory foam cushions

### MICROPHONE

- Frequency response: 100 Hz – 10 kHz
- Signal-to-noise ratio:  $\geq 60$  dB
- Sensitivity (@1 kHz):  $-42 \pm 3$  dBV / Pa, 1 kHz
- Pick-up pattern: Unidirectional

### ON-EARCUP CONTROLS

- Volume up and down
- Mic mute on/off toggle
- SmartSwitch button

### AUDIO USAGE

- Wireless: Via USB Type C dongle or Bluetooth 5.2
- Wired: USB Type A
- Bluetooth Codec: SBC
- THX Spatial Audio: Only available on Windows 10<sup>®</sup> 64-bit (or higher)

### BATTERY LIFE

- Up to 70 hours

---

## 5. SETTING UP YOUR RAZER BLACKSHARK V2 HYPERSPEED

### CHARGING YOUR HEADSET

Connect your Razer BlackShark V2 HyperSpeed to a powered USB Type A port using the charging cable. For best results, please fully charge your headset before using it for the first time. A depleted unit will fully charge in about 4 hours.

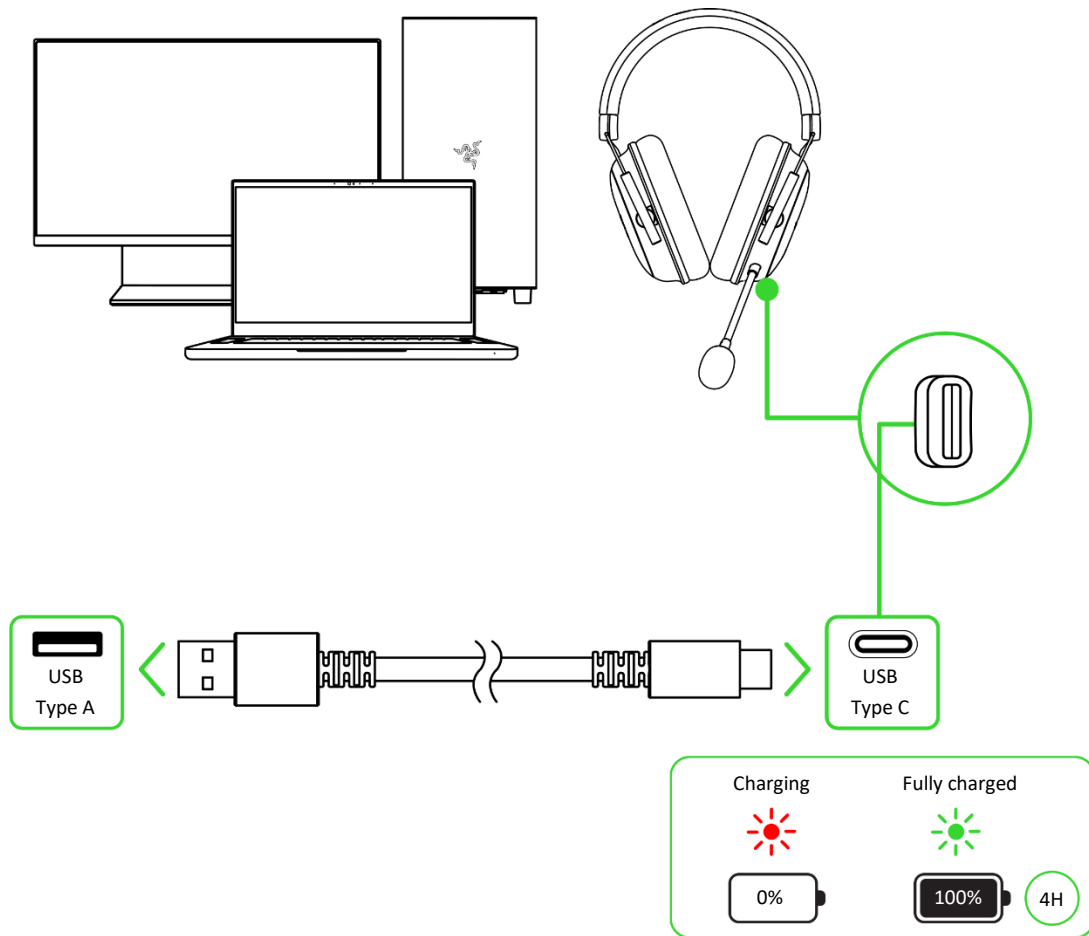

**i** This connection also acts as the wired mode for your Razer device.

## CONNECTING YOUR HEADSET

### A. Via wired mode

1. Connect the headset to any of the USB ports on your PC.

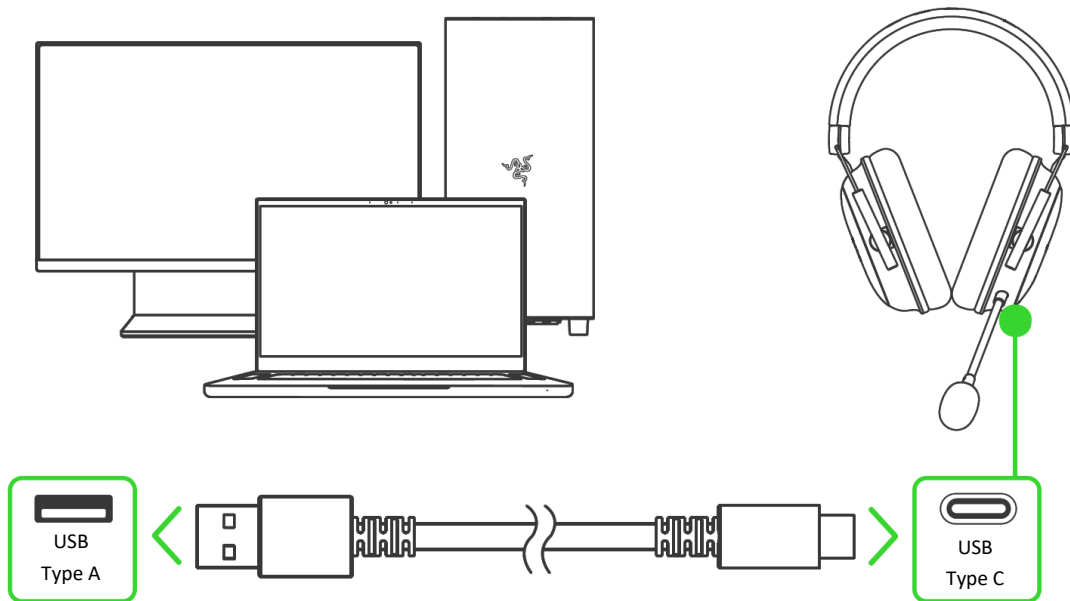

2. On your PC (if applicable), set the **Razer BlackShark V2 HS USB** as the default **Output** and **Input** device.

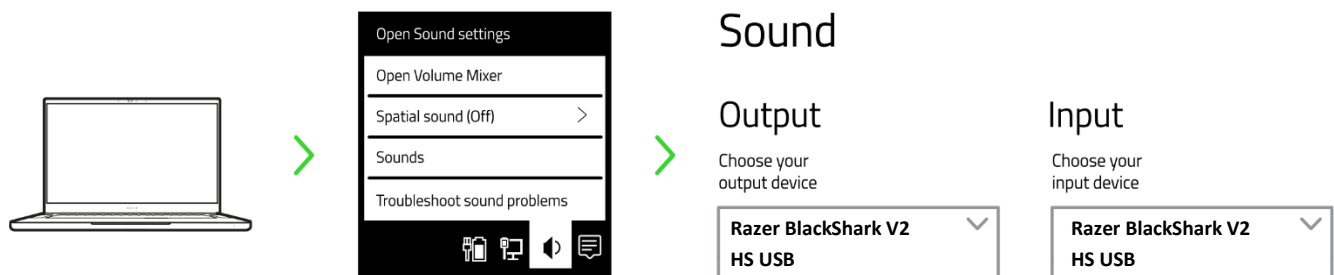

**i** When using the headset with other compatible devices, set **Razer BlackShark V2 HS USB** as its default input and output device.

Your headset is now ready to use in Wired mode.

## B. Via Razer™ HyperSpeed Wireless (2.4 GHz) mode

1. Connect the wireless dongle to any of the USB ports on your PC using the USB Type A to USB Type C cable.

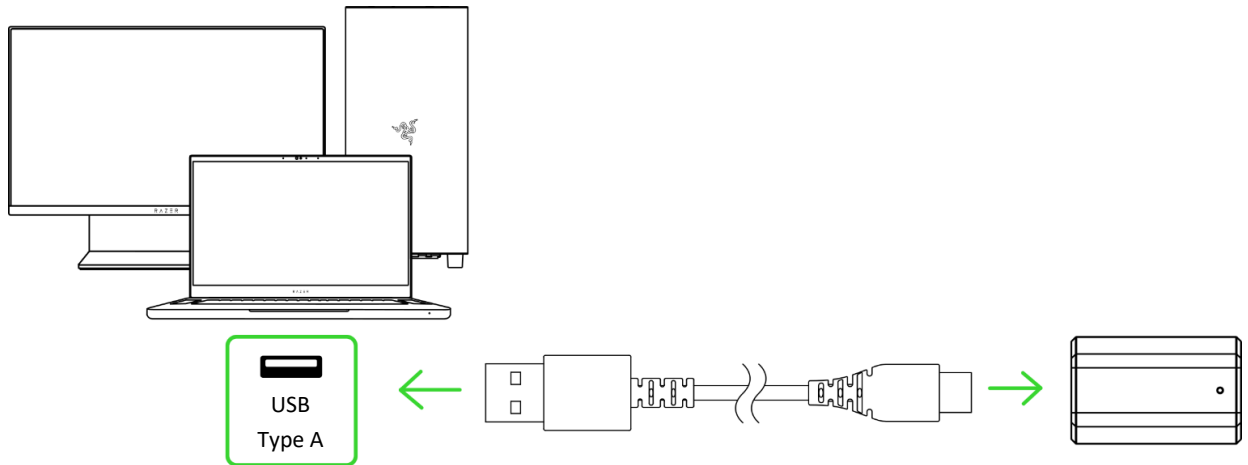

2. Press and hold the Power button until the headset indicator LED briefly lights up.

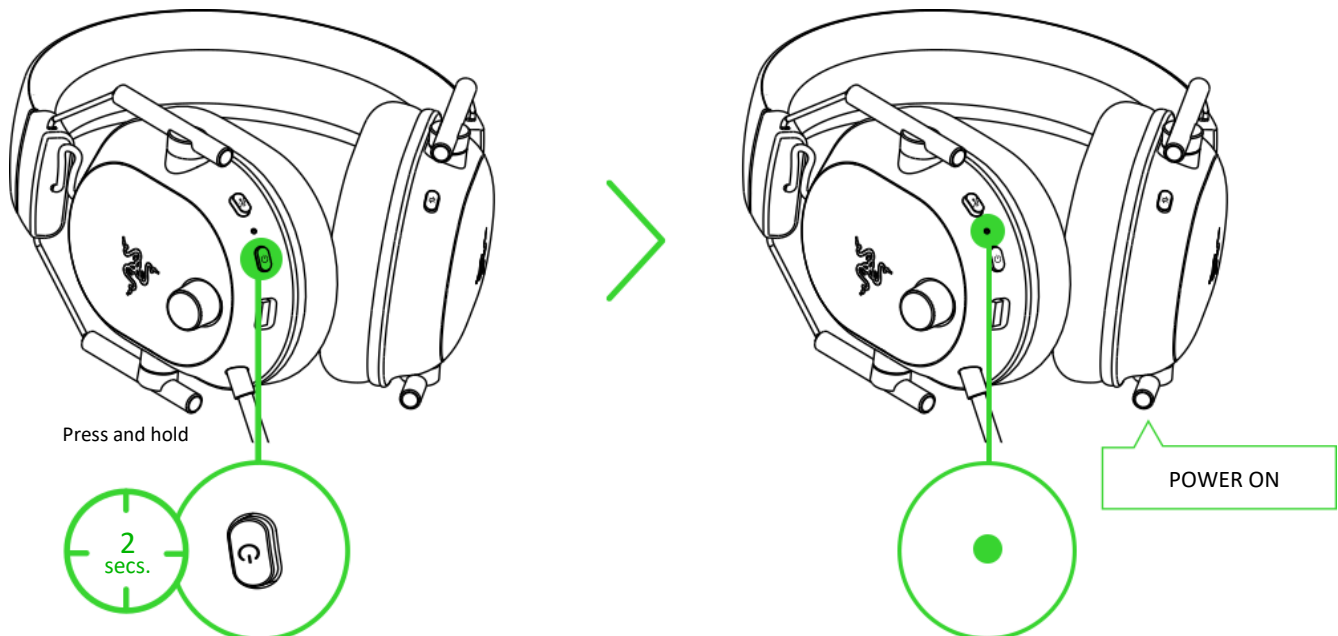

- Wait for the headset indicator LED to turn solid green, indicating that the headset is now connected to the wireless dongle.

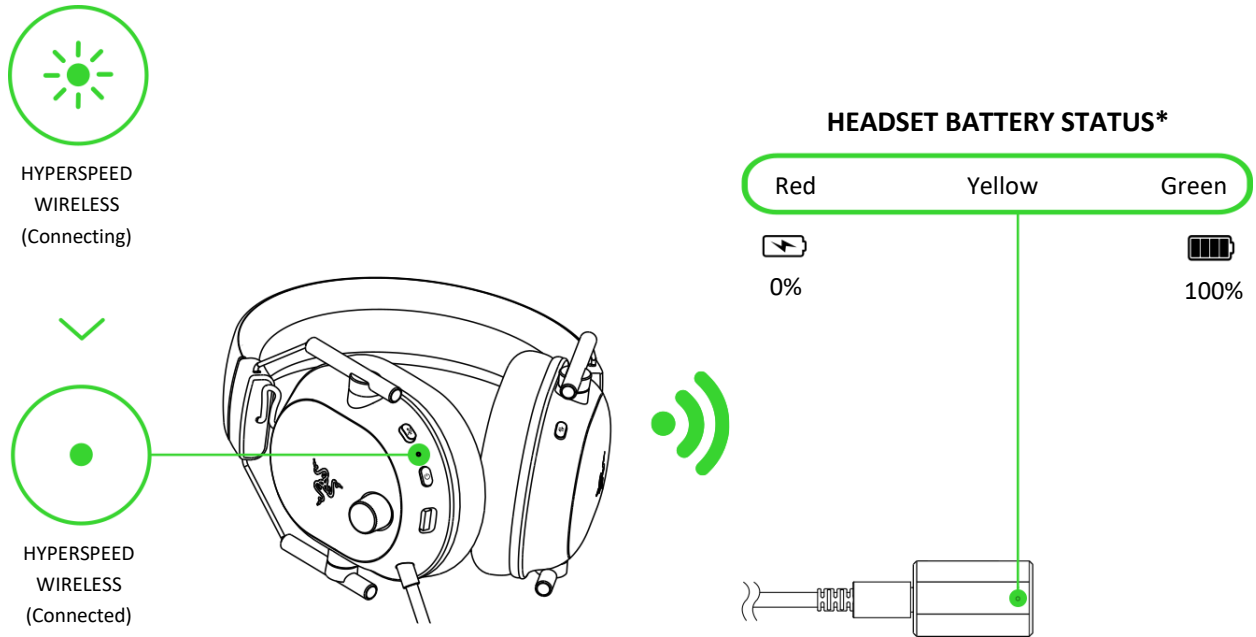

*\*By default, the dongle indicator LED will display the headset's battery status when connected via Razer HyperSpeed Wireless (2.4 GHz) mode. You can customize the indicator LED to show the headset's connection status, battery status (default) or low battery warning only from the Razer Synapse app. [Learn how to customize the dongle indicator LED](#)*

- On your PC (if applicable), set the **Razer BlackShark V2 HS 2.4** as the default **Output** and **Input** device.

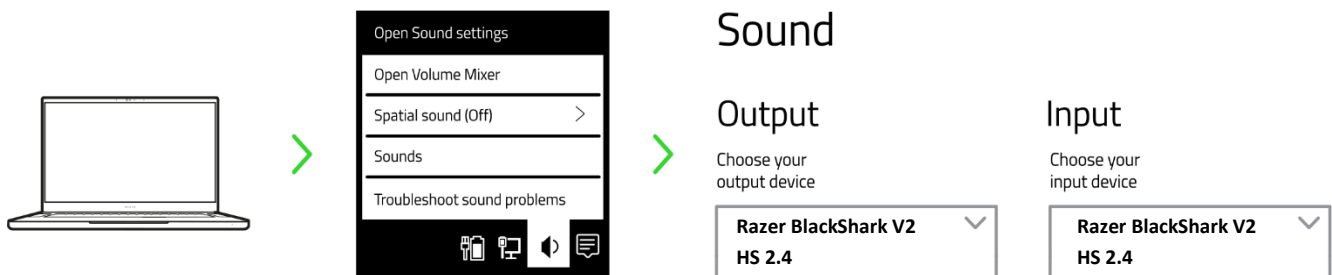

**i** *When using the headset with other compatible devices, set **Razer BlackShark V2 HS 2.4** as its default input and output device.*

Your headset is now ready to use in HyperSpeed Wireless mode.

### C. Via Bluetooth mode

1. While powered on, press and hold the Razer SmartSwitch / EQ button for 7 seconds to activate pairing mode.

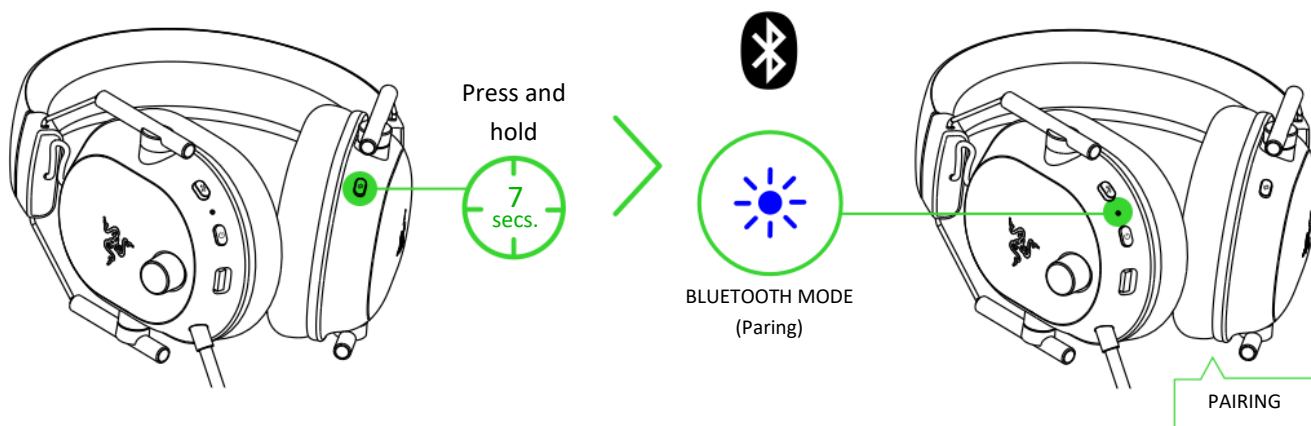

**i** Alternatively, you can reactivate Bluetooth pairing mode by pressing and holding the power button while the headset is powered off.

2. Activate Bluetooth on your device and select **Razer BlackShark V2 HS BT** from the list of devices found.

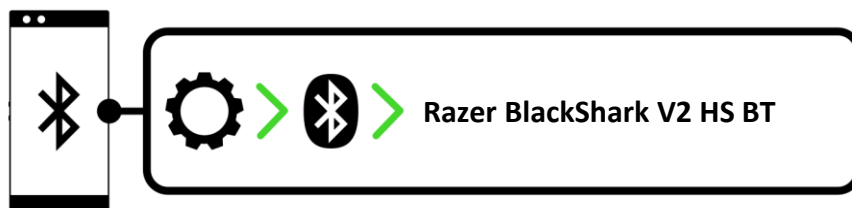

3. Wait until both devices are connected. The headset indicator LED will briefly show solid blue to indicate that the headset is now connected to your device.

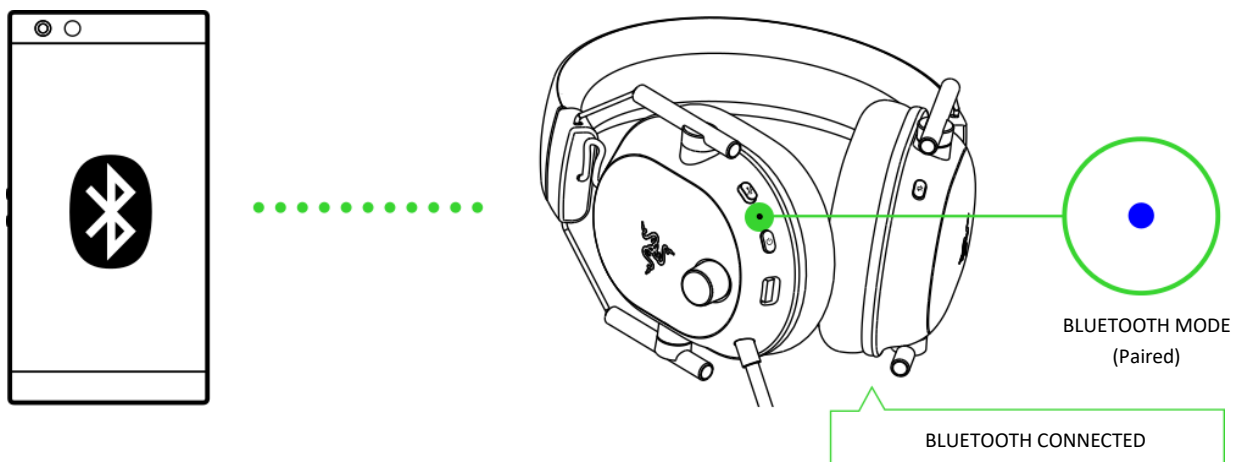

Your headset is now ready to use in Bluetooth mode.

## PERSONALIZE YOUR EXPERIENCE

### Razer Synapse (PC)\*

Use the Razer Synapse app to customize your headset's EQ, toggle Do Not Disturb to block incoming calls while gaming, enable mic noise cancellation, and fine-tune other advanced features.

 *Install Razer Synapse when prompted, or download the installer from [razer.com/synapse](https://www.razer.com/synapse)*

### Activate THX® Spatial Audio\*

Unleash the full potential of your Razer BlackShark V2 HyperSpeed by enabling 360° positional audio for a natural and lifelike experience through Razer Synapse.



*\*Only available on Windows 10 64-bit and above.*

---

## 6. USING YOUR HEADSET

### LOW BATTERY WARNING

The headset indicator LED will blink red twice in repeated intervals to indicate that its battery power is less than 8%. While in use, you'll hear a voice prompt when the headset needs to be recharged; during such time, the indicator will continue showing the battery level until you charge the headset.

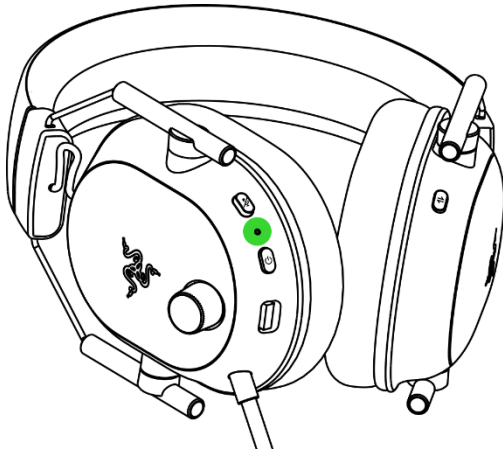

Indicator	Prompt	Battery level
	Voice	Low

### POWER BUTTON

Power on/off

Power on the headset by holding the Power button until the headset indicator LED is on and holding the Power button again to power it off. An audio prompt will notify you when the headset is powered on or off.

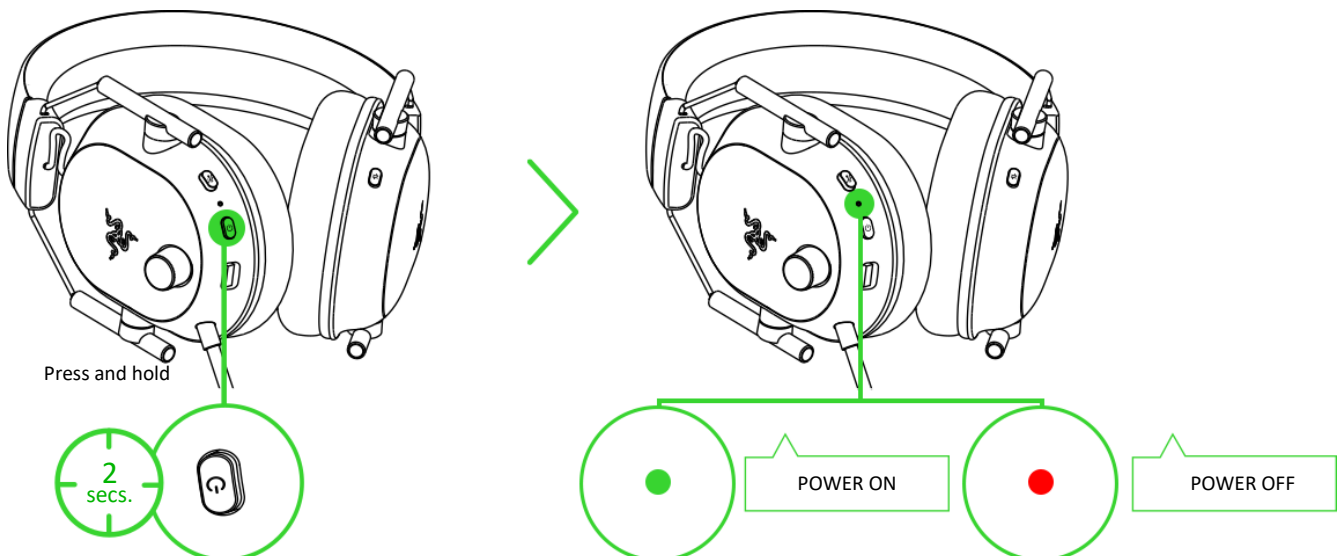

## Other functions

Other Power button functions are available and operate based on your device's current activity and may not apply to certain devices.

Single press	Play/pause
	Accept an incoming call or end the current call*
	Put a call on hold and accept an incoming call*
	End call and swap to on-hold call*
Double press	Reject incoming call*
	Swap calls*
	Skip track
Triple press	Previous track
While powered off, press and hold for 5 seconds	Activate Bluetooth pairing mode

*\*Only available in Bluetooth mode.*

## RAZER SMARTSWITCH / EQ BUTTON

### Switching between EQ Presets

Press the Razer SmartSwitch button to cycle through the Game, Movie, Music, and Custom EQ presets.

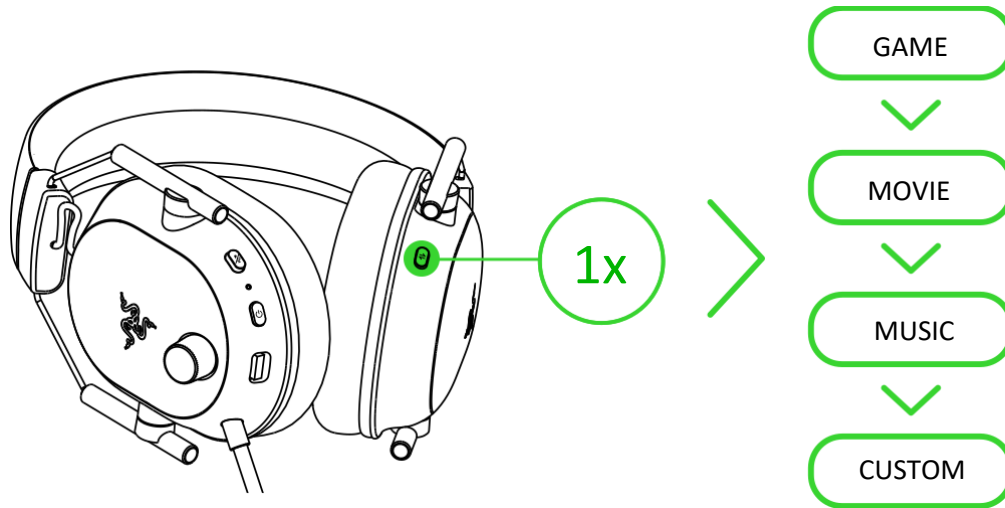

**i** By default, the headset is set to Music. A voice prompt will be heard as you switch between EQ presets. You can also change the active EQ preset and personalize the Custom EQ preset using the Razer Synapse app (PC). [Learn more about the Audio Equalizer](#)

### Reactivating Bluetooth pairing mode

You can also use the Razer SmartSwitch / EQ button to reactivate Bluetooth pairing mode. While connected via Bluetooth, press and hold the Razer Smart Switch button for 7 seconds to reactivate Bluetooth pairing mode and connect your device to **Razer BlackShark V2 HS BT** as needed.

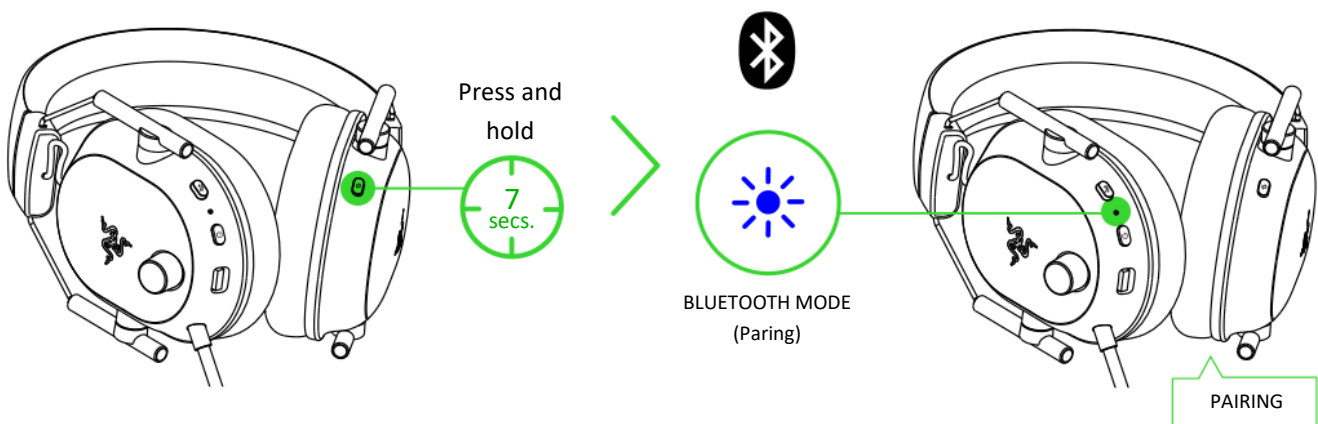

### Switching between audio sources

When powered on and connected to any audio source, double press the Razer SmartSwitch / EQ button to switch between the wireless dongle and Bluetooth audio source or vice versa.

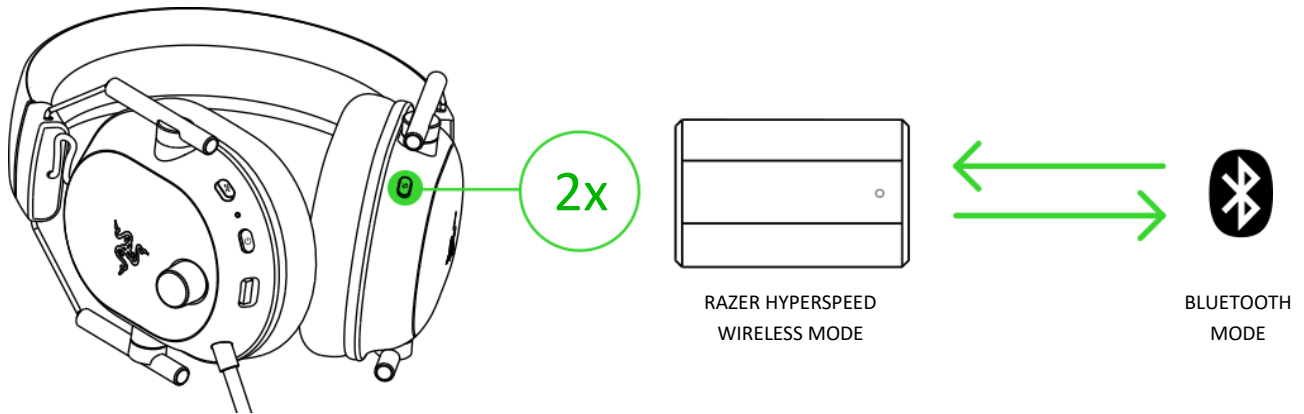

**i** Using Bluetooth as the audio source will reconnect the headset to the last known device. Pairing mode will be activated if no device is found.

### Enabling / Disabling Gaming Mode

While connected via Bluetooth, triple press the Razer SmartSwitch / EQ button, then hold the last press for 2 seconds to activate Gaming Mode. Once enabled, the headset will function at a lower latency, giving you real-time audio feedback while gaming. Repeat to disable gaming mode.

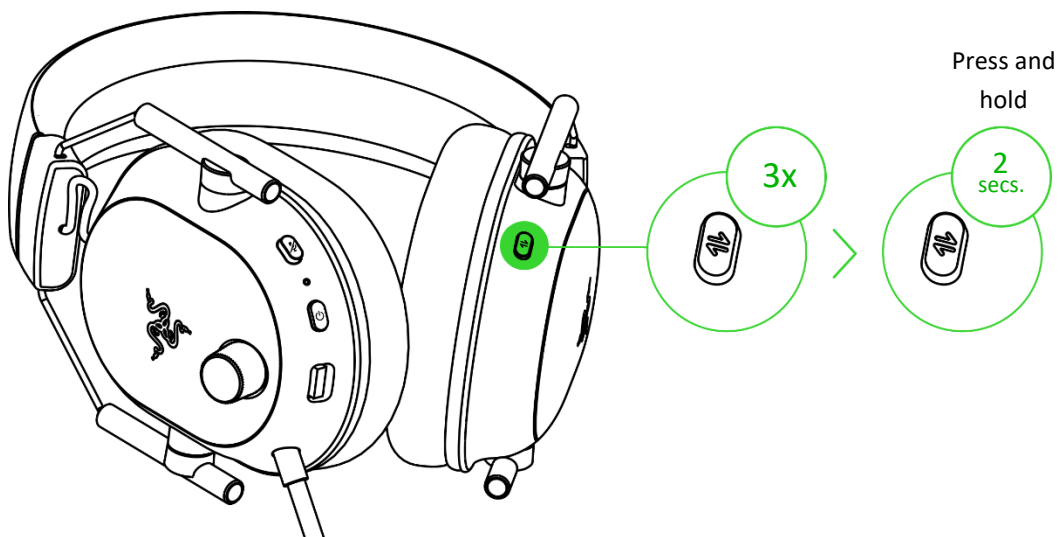

**i** This feature is only available on Bluetooth connection. Keeping the headset within a very close distance of the audio source is recommended for the best performance.

## Understanding Razer Smartswitch

With the Razer BlackShark V2 HyperSpeed simultaneously connected to a PC or gaming console (via wireless dongle) and a mobile device (via Bluetooth), you'll be able to use the headset for incoming/outgoing/conference calls from a connected Bluetooth device and switch back to the game audio without removing the headset. The headset indicator LED will briefly show static white to indicate that the headset is connected to both audio sources.

The following behaviors below will help you understand how your headset responds to audio source switching and incoming/outgoing/conference calls when your headset is connected to a Bluetooth device and the wireless dongle:

Headset audio	Razer SmartSwitch behavior
Streaming via the wireless dongle	<ul style="list-style-type: none"><li data-bbox="440 800 1438 919">▪ The headset will automatically switch to Bluetooth audio source for incoming/outgoing/conference calls from your mobile device and resume using the wireless dongle after each call.</li><li data-bbox="483 947 1446 1066"> <i>You can deactivate automatic source switching for incoming calls by enabling your headset's Do Not Disturb feature on the Razer Synapse app.</i></li><li data-bbox="440 1094 1463 1161">▪ Audio from the connected mobile device will ONLY automatically stream on the headset if no audio is present or streaming on the wireless dongle.</li><li data-bbox="440 1188 1438 1262">▪ Auto-pause on streamed audio when switching audio sources depends on the app you're using (e.g., Spotify, Apple Music).</li></ul>
Streaming via Bluetooth	<ul style="list-style-type: none"><li data-bbox="440 1310 1409 1377">▪ When you switch to the wireless dongle audio source, your headset will remain connected to your mobile device via Bluetooth.</li><li data-bbox="440 1409 1438 1482">▪ Auto-pause on streamed audio when switching audio sources depends on the app you're using (e.g., Spotify, Apple Music).</li></ul>
Not streaming on any audio source	Audio will play on the first audio source that streams audio.

## QUICK FUNCTIONS REFERENCE

### Power button

Single press	Play/pause
	Accept an incoming call or end the current call*
	Put a call on hold and accept an incoming call*
	End call and swap to on-hold call*
Double press	Skip track
	Swap calls*
	Reject incoming call*
Triple press	Previous track
Press and hold for 2 seconds	Power on / off headset
While powered off, press and hold for 5 seconds	Activate Bluetooth pairing mode

*\*Only available in Bluetooth mode.*

### Razer SmartSwitch / EQ button

Single press	Cycle through EQ presets
Double press	Switch between audio sources
Double press, then hold the last press for 2 seconds	Enable/disable Gaming Mode
While powered on and in Bluetooth mode, press and hold for 7 seconds	Activate Bluetooth pairing mode

## VOLUME CONTROL KNOB

Rotate the volume control knob to increase or decrease the volume.

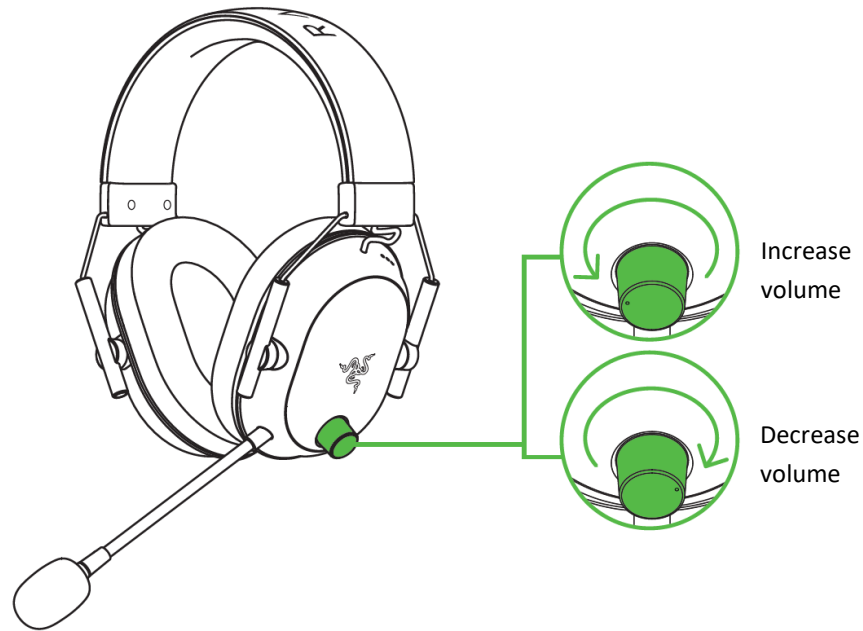

## RAZER HYPERCLEAR SUPER WIDEBAND MIC

Bend the Razer™ HyperClear Super Wideband Mic until it is parallel to your mouth. Make sure the mic diaphragm is in front, and the air vent is facing away from your mouth.

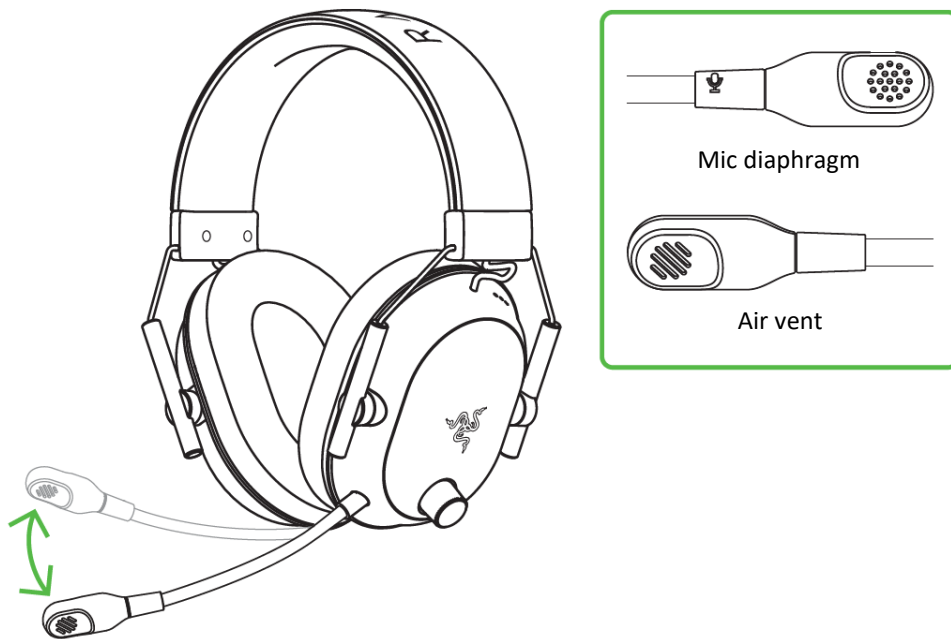

**i** The recommended mic-to-mouth distance for optimal sound capture is 1.5 cm to 3 cm (0.59 in to 1.18 in).

## MUTING / UNMUTING THE MICROPHONE

Press the mic mute button to mute or unmute the microphone.



---

## 7. CONFIGURING YOUR RAZER BLACKSHARK V2 HYPERSPEED VIA RAZER SYNAPSE

**i** *Internet connection is required for installation, updates, and cloud-based features. Registering for a Razer ID account is recommended but optional. All listed features are subject to change based on the current software version, the connected device(s), and supported apps and software.*

### SYNAPSE TAB

The Synapse tab is your default tab when you first launch Razer Synapse. This tab allows you to navigate the Dashboard subtab.

#### Dashboard

The Dashboard subtab is an overview of your Razer Synapse, where you can access all your Razer devices, modules, and online services.

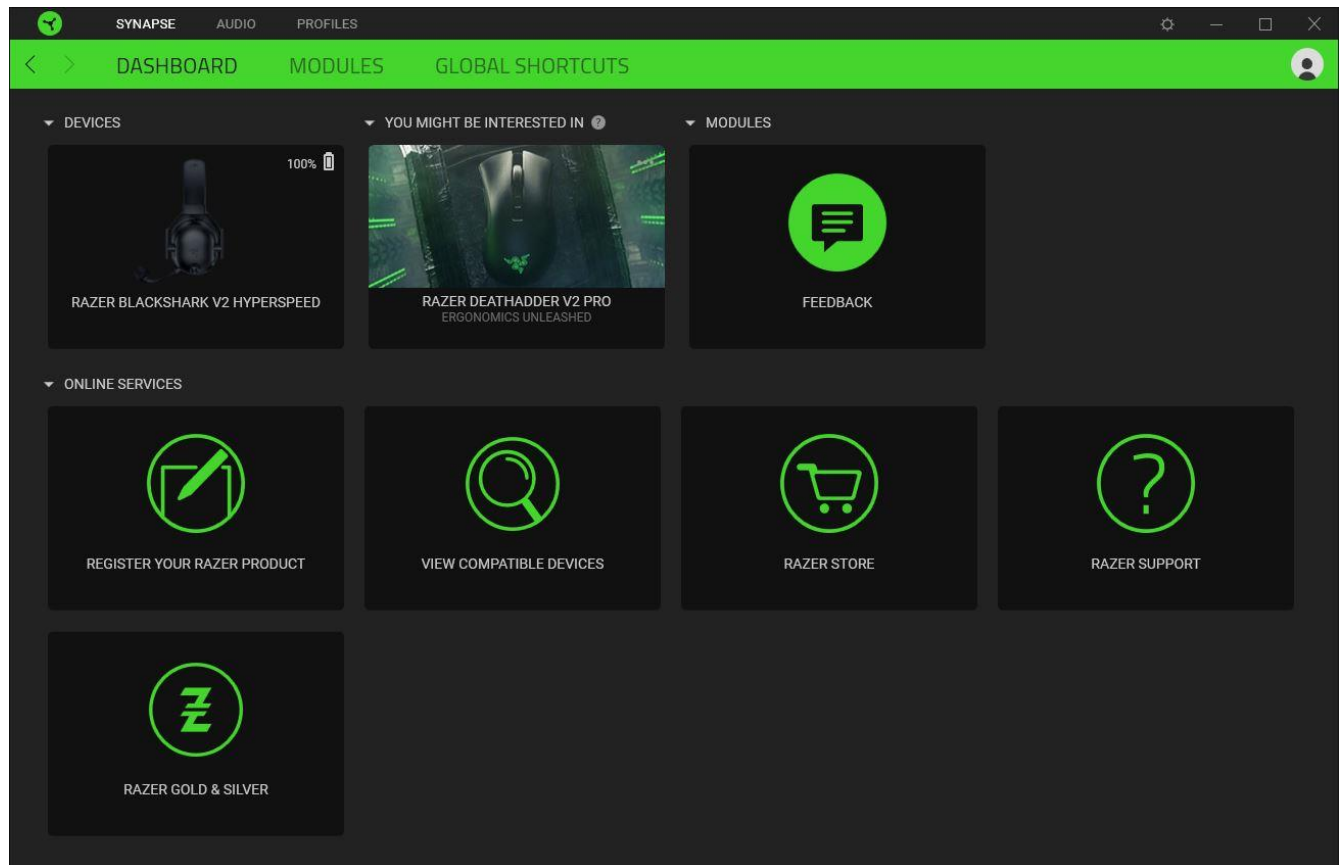

## Modules

The Modules subtab displays all installed and available modules for installation.

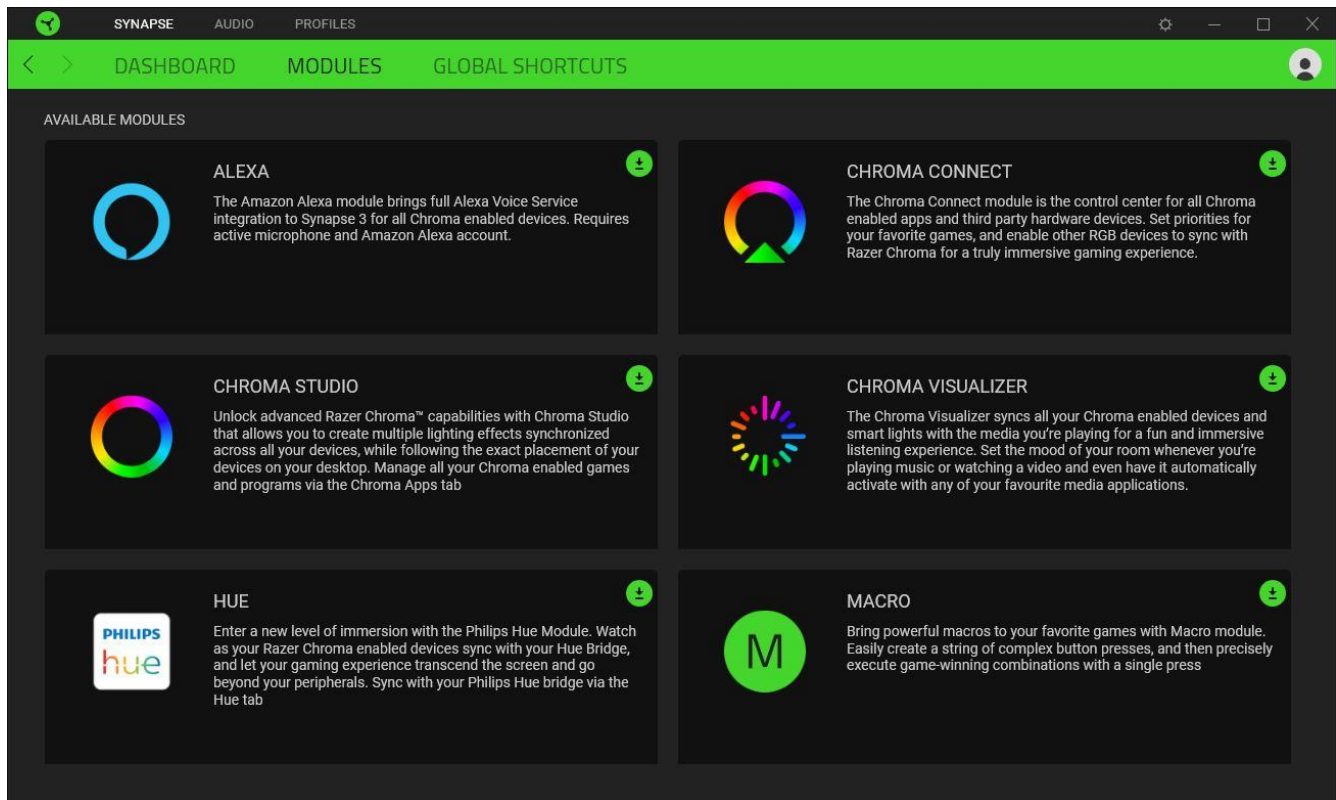

## Global Shortcuts

Bind operations or Razer Synapse functions to custom key combinations from any Razer Synapse-enabled device inputs, which apply across all device profiles. [Learn more about Profiles](#)

 *Only Razer Synapse-enabled device inputs will be recognized.*

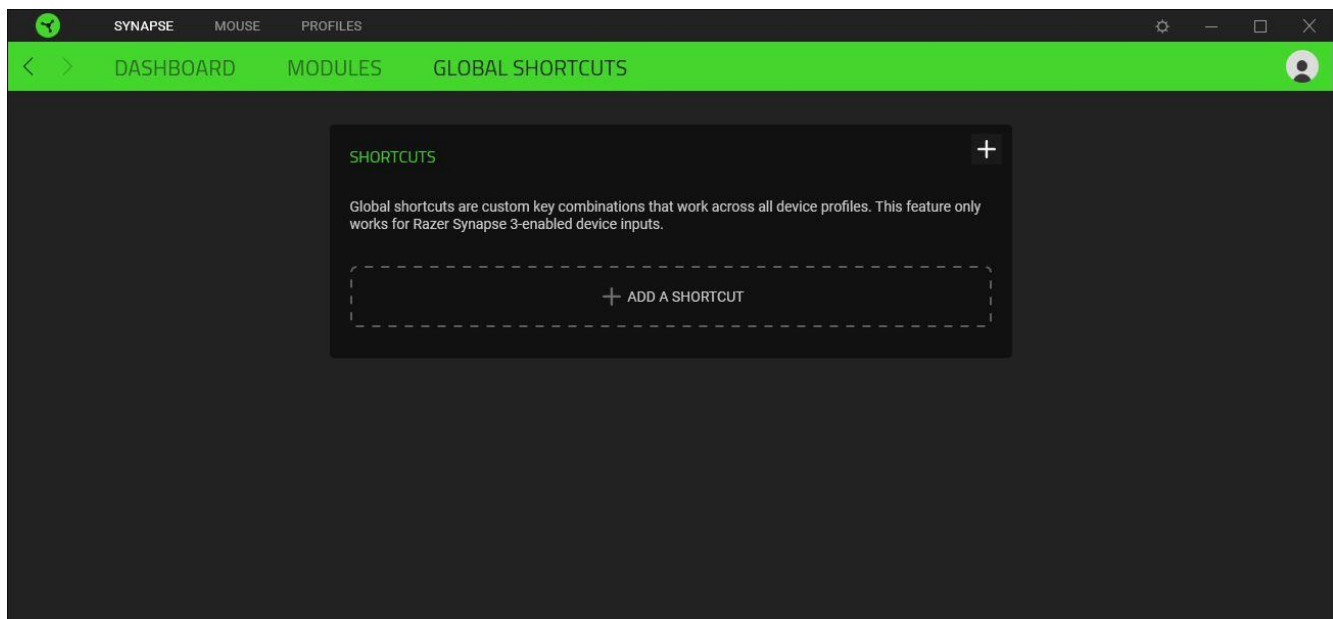

## AUDIO TAB

The Audio tab is the main tab for your Razer BlackShark V2 HyperSpeed. From here, you can customize your device's settings to unleash its full potential. Changes under this tab are automatically saved to your system and cloud storage.

### Sound

The Sound subtab is for switching between Stereo audio and THX Spatial Audio, setting and customizing EQ profiles, adjusting the overall system volume or individual volume of all active applications, and accessing Windows Sound properties.

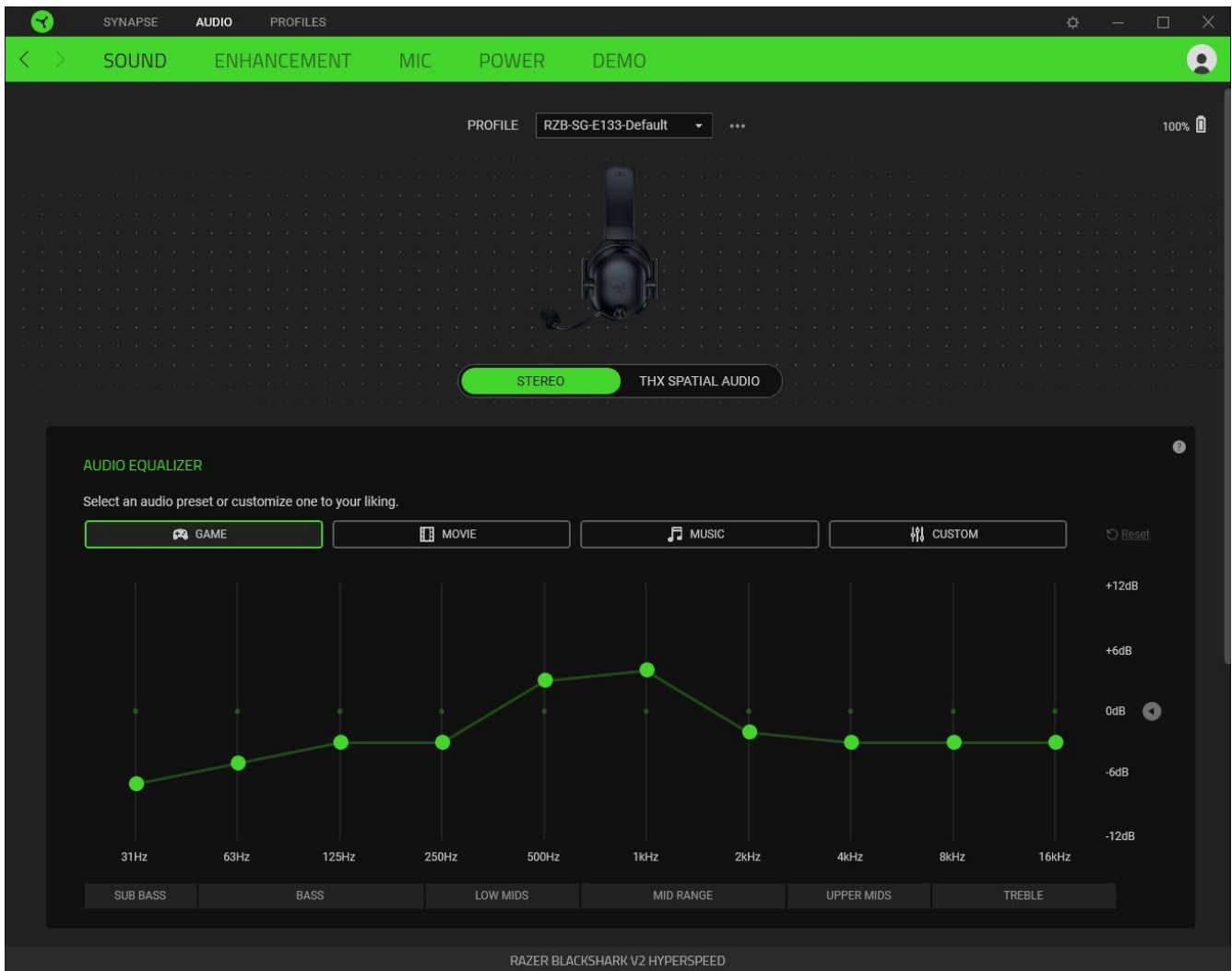

### Profile

A Profile is a data storage for keeping all your Razer peripherals' settings. By default, the profile name is based on your system's name. To add, import, rename, duplicate, export, reset or delete a profile, press the Miscellaneous button ( ●●● ).

### Stereo / THX Spatial Audio

Toggle between Stereo audio and THX Spatial Audio.

### Audio equalizer

Select any available equalizer preset created for the best audio experience designed for gaming immersion, movie viewing, or enjoying your favorite music. Manually adjusting any equalizer preset will automatically set it to Custom.

## Game Profiles

Set a THX Spatial Audio or EQ preset to load automatically when a game is in the foreground. Click on **Add Games & Programs** to manually add apps and set your preferred audio output for each.

## Understanding THX Game Profiles

THX Game Profiles are custom-tuned profiles that enhance the existing sound design in your favorite games. For THX Game Profile-supported games, the following modes are available in its corresponding Audio Output dropdown options:

- **THX Competitive Mode.** Boosts enemy audio while reducing low-frequency sounds such as explosions so you can hear their footsteps, reloads and other sound effects with greater clarity.
- **THX Environmental Mode.** For truly realistic acoustics that reflect your surroundings and localized enemy audio for better directional hearing.



For an updated list of THX Game Profile-supported games, visit [razer.com/thx-spatial-audio/game-list](https://www.razer.com/thx-spatial-audio/game-list)

## Volume

Adjust the audio volume of the device. You may also access the Windows volume mixer of the current playback device, where you can proportionally adjust the system's overall volume or individually adjust the volume of each active application.

## Sound Properties

Launches the Windows Sound Properties window where you can manage your system's sound settings, such as modifying the playback and recording device settings, sound scheme, and default communications activity.

## Enhancement

The Enhancement subtab is for customizing your audio system's incoming audio settings and frequency response.

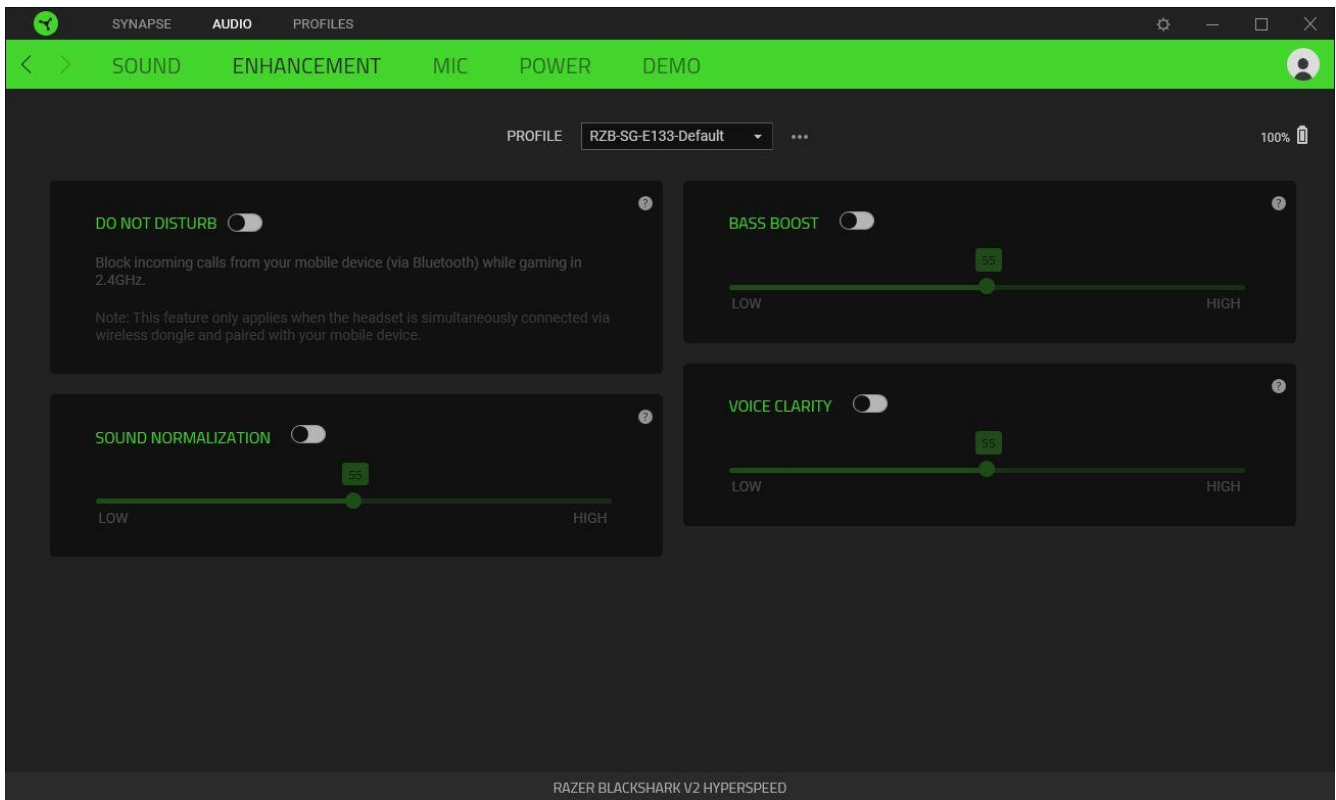

### *Do Not Disturb*

Block calls from your mobile device (via Bluetooth) while connected to the wireless dongle.

 *This feature only works when the headset is connected to the wireless dongle and a mobile device simultaneously.*

### *Bass Boost*

Enhance the low-frequency response to improve the bass output of your headset. When enabled, you can adjust the bass output of the headset by adjusting the bass boost slider.

### *Sound Normalization*

Enable Sound Normalization to adjust how much incoming audio will be reduced to avoid sudden and unpleasant increases in volume from effects such as shouting or explosions.

### *Voice Clarity*

Enhance the quality of incoming voice conversations by filtering the sound to improve clarity and volume.

### Mic

The Mic subtab enables you to change all outgoing mic audio settings.

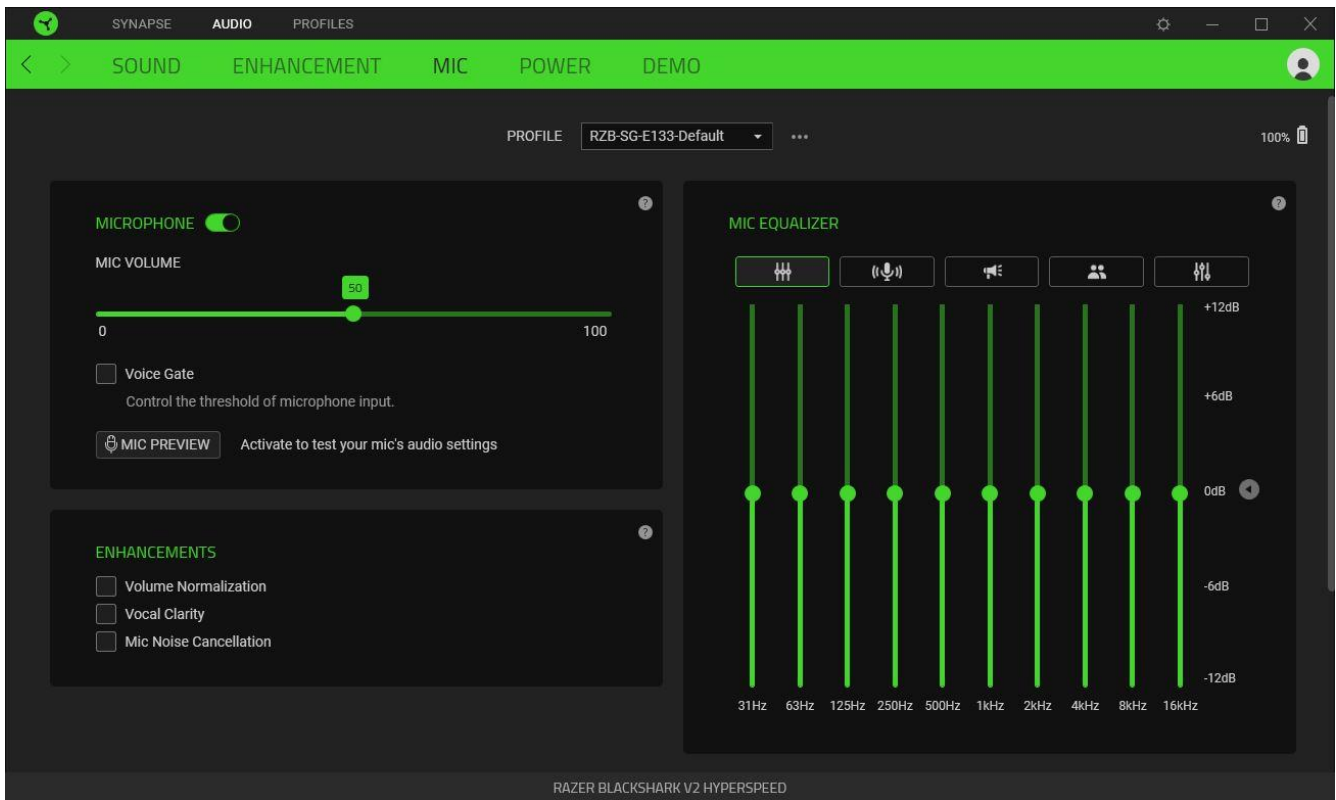

### Microphone

Control the mic volume and input for clearer mic audio or disable it entirely by toggling the Microphone option.

### Mic Volume

Adjust the microphone input or mute the mic.

### Enhancements

Improve the quality of the mic input further by enabling any of the listed features below and adjusting its intensity using its corresponding slider.

- Volume Normalization. Reduces the variation of loudness.
- Vocal Clarity. Emphasizes the voice frequency.
- Mic Noise Cancellation. Suppresses environmental noise.

### Mic Equalizer

Select any available mic equalizer preset that best fits your mic needs. Manually adjusting any equalizer preset will automatically set it as a Custom preset.

### *Mic Monitoring (Sidetone)*

Enable this setting to monitor the microphone's raw audio input through the headset with an additional option to increase or decrease the audio monitoring volume.

## Power

The Power subtab allows you to customize what the indicator LED on the wireless dongle displays or set your device to enter sleep mode when idle for a certain amount of time.

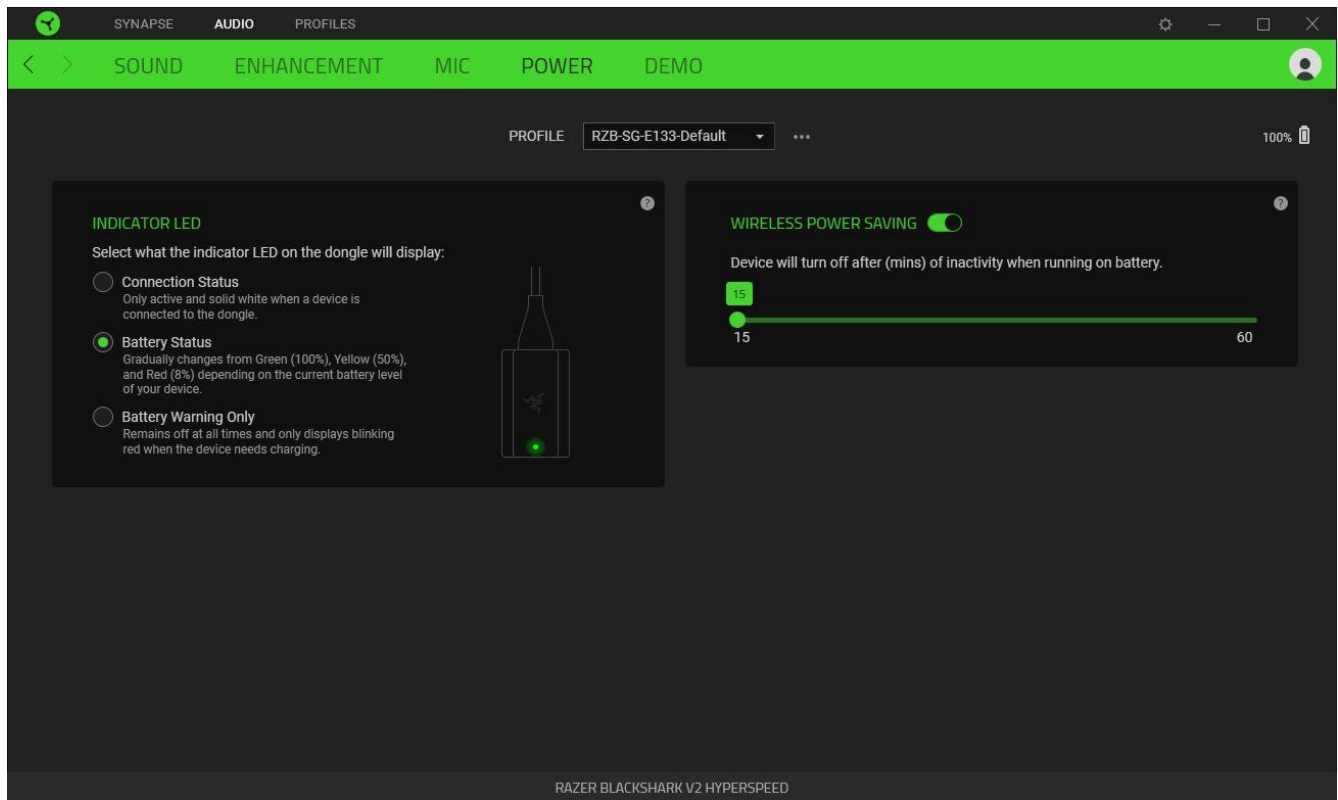

**!** *By default, the indicator LED on the wireless dongle displays the headset's battery status.*



## PROFILES TAB

The Profiles tab is a convenient way to manage all your profiles and link them to your games and applications.

### Devices

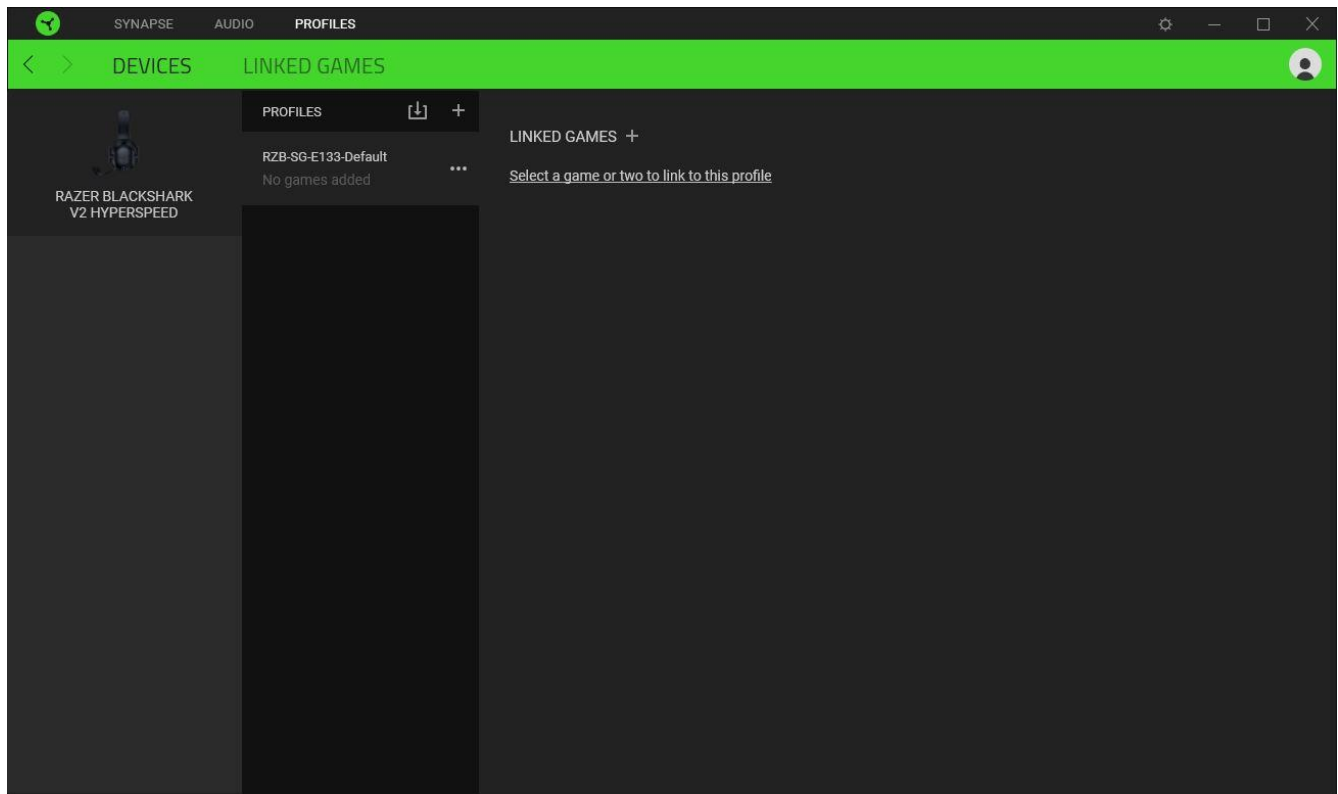
View which games are linked to each device's profiles or which Chroma Effect is linked to specific games using the Devices subtab.



You can import Profiles from your computer or the cloud through the import button (  ) or create new profiles within the selected device using the add button (  ). To rename, duplicate, export, or delete a profile, simply press the Miscellaneous button (  ). Each profile can be set to activate when you run an application using the Linked Games option.

## Linked Games

The Linked Games subtab allows you to add games, view devices linked to games, or search for added games. You can also sort games based on alphabetical order, last played, or most played. Added games will still be listed here, even if not linked to a Razer device.

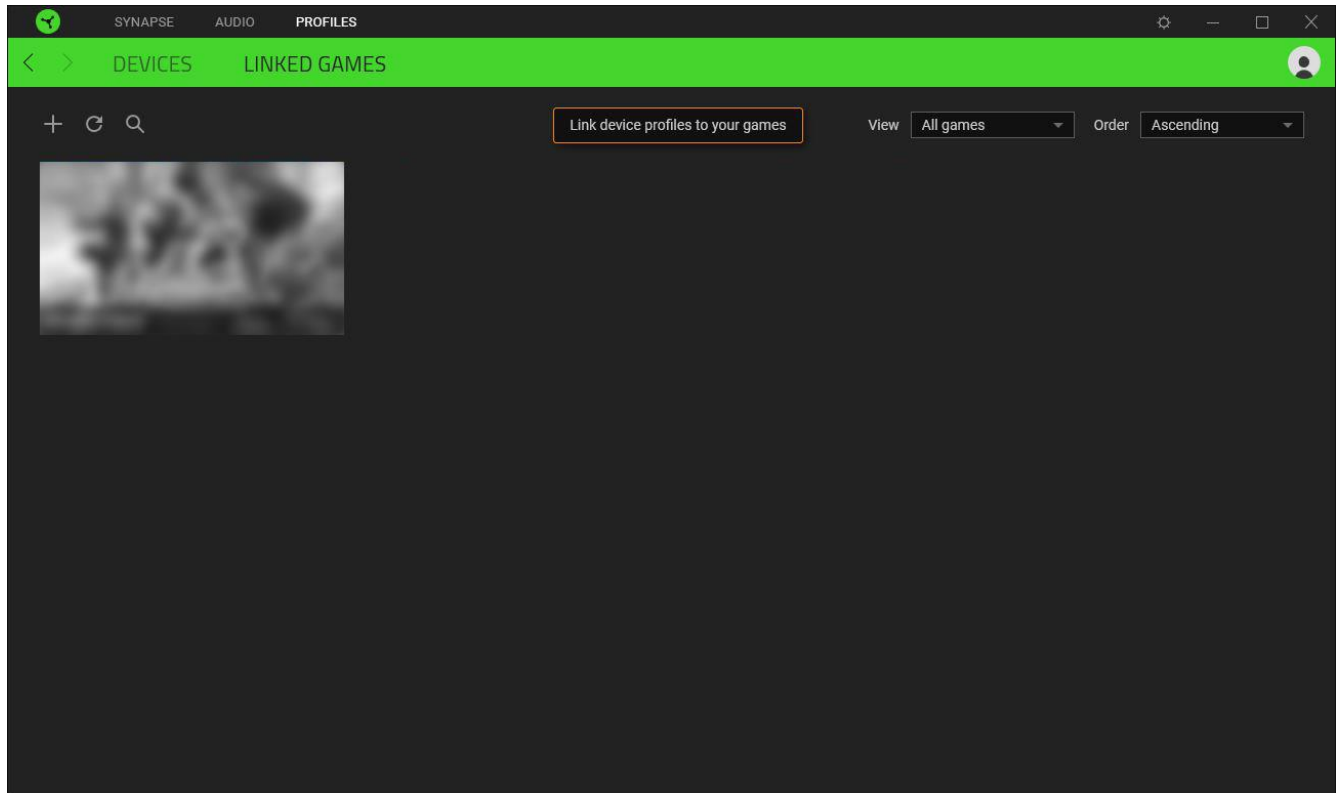

To link games to connected Razer devices or Chroma Effects, click on any game from the list, and then click **Select a device and its profile to launch automatically during gameplay** to select the Razer device or Chroma Effect it will link with. Once connected, you may click the Miscellaneous button ( ●●● ) of the corresponding Chroma Effect or device to select a specific Chroma Effect or profile.

## SETTINGS WINDOW

The Settings window, accessible by clicking the ( ⚙ ) button on Razer Synapse, enables you to configure the startup behavior and display language of Razer Synapse, control the recommendations you see on the Dashboard, check the firmware version and master guide of each Razer device, or perform a factory reset on any connected Razer device.

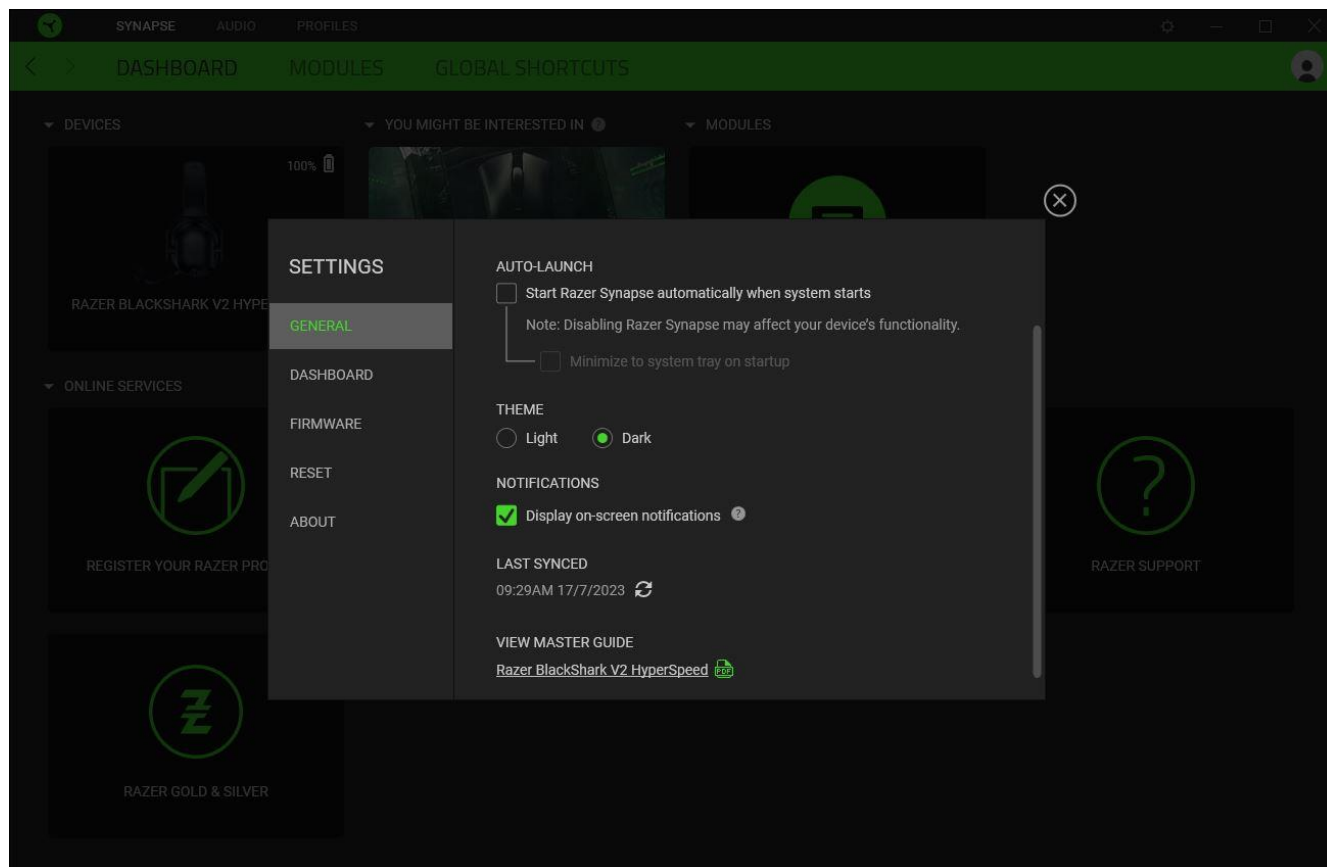

### General tab

The General tab lets you change the software's display language, startup behavior, theme, and on-screen notifications. You may also manually sync your profiles to the cloud ( ↻ ) or view the master guide of all connected Razer devices and installed modules.

### Dashboard tab

Use the Dashboard tab to customize which Razer device recommendations based on your setup, and the games you play will appear on the Dashboard.

### Firmware tab

Access the Firmware tab to view the current firmware version of your Razer device(s), and/or visit the Software and Firmware Update page to see whether a firmware update is available for your device(s).

## Reset tab

The Reset tab allows you to perform a factory reset on all connected Razer devices with on-board memory and/or reset Razer Synapse tutorials to acquaint yourself again with Razer Synapse's new features on its next launch.



*All profiles stored on the selected device's on-board memory will be erased when you reset a Razer device.*

## About tab

The About tab displays brief software information and copyright statement, and provides relevant links for its terms of use. You may also use this tab to check for software updates, or as quick access to Razer's social communities.

---

## 8. SAFETY AND MAINTENANCE

### SAFETY GUIDELINES

To achieve maximum safety while using your Razer BlackShark V2 HyperSpeed, we suggest that you adopt the following guidelines:

Should you have trouble operating the device properly and troubleshooting does not work, unplug the device and contact the Razer hotline or go to [support.razer.com](https://support.razer.com) for assistance.

Don't take apart the device, and don't attempt to operate it under abnormal current loads. Doing so will void your warranty.

Keep the device away from liquid, humidity, or moisture. Operate the device only within the specific temperature range of 0°C (32°F) to 40°C (104°F). Should the temperature exceed this range, unplug and/or switch off the device to stabilize the temperature to an optimal level.

When not in use, keep away the headset's mic foam from sunlight.

We recommend stretching the headset gently apart before placing them over your head to minimize headband stress. However, please avoid overstretching the headset beyond its technical limits.

The device isolates external ambient sounds even at low volumes, resulting in lowered awareness of your external surroundings. Please remove the device when engaging in activities requiring active awareness of your surroundings.

Listening to excessively loud volumes over extended periods can damage your hearing. Furthermore, legislation of certain countries permits a maximum sound level of 86db to affect your hearing for 8 hours a day. We, therefore, recommend that you reduce the volume to a comfortable level when listening for prolonged periods. Please, take good care of your hearing.

### MAINTENANCE AND USE

The Razer BlackShark V2 HyperSpeed requires minimum maintenance to keep it in optimum condition. Once a month, we recommend you clean the device using a soft cloth or cotton swab to prevent dirt buildup. Don't use soap or harsh cleaning agents.

### BATTERY WARNING

The Razer BlackShark V2 HyperSpeed contains a Li-ion rechargeable battery. In general, the life expectancy of such batteries is dependent upon usage. If you suspect that the Li-ion rechargeable battery inside the Razer BlackShark V2 HyperSpeed may be drained (has a low charge), try charging it.

**Caution:** Don't open, mutilate, or expose to conducting materials (metal), moisture, liquid, fire, or heat. Doing so may cause batteries to leak or explode, resulting in personal injury. Battery life varies with usage.

---

## 9. LEGALESE

### COPYRIGHT AND INTELLECTUAL PROPERTY INFORMATION

©2023 Razer Inc. All rights reserved. Razer, the triple-headed snake logo, Razer logo, and "For Gamers. By Gamers." are trademarks or registered trademarks of Razer Inc. and/or affiliated

companies in the United States or other countries. All other trademarks are the property of their respective owners.

The Bluetooth® word mark and logos are registered trademarks owned by Bluetooth SIG, Inc., and any use of such marks by Razer is under license.

THX and the THX logo are trademarks of THX Ltd., registered in the U.S. and other countries.

Windows and the Windows logo are trademarks or registered trademarks of the Microsoft group of companies.

Razer Inc. ("Razer") may have copyright, trademarks, trade secrets, patents, patent applications, or other intellectual property rights (whether registered or unregistered) concerning the product in this guide. Furnishing of this guide does not give you a license to any such copyright, trademark, patent or other intellectual property right. The Razer BlackShark V2 HyperSpeed (the "Product") may differ from pictures whether on packaging or otherwise. Razer assumes no responsibility for such differences or for any errors that may appear. Information contained herein is subject to change without notice.

## LIMITED PRODUCT WARRANTY

For the latest and current terms of the Limited Product Warranty, please visit [razer.com/warranty](https://www.razer.com/warranty).

## LIMITATION OF LIABILITY

Razer shall in no event be liable for any lost profits, loss of information or data, special, incidental, indirect, punitive or consequential or incidental damages, arising in any way out of distribution of, sale of, resale of, use of, or inability to use the Product. In no event shall Razer's liability exceed the retail purchase price of the Product.

## GENERAL

These terms shall be governed by and construed under the laws of the jurisdiction in which the Product was purchased. If any term herein is held to be invalid or unenforceable, then such term (in so far as it is invalid or unenforceable) shall be given no effect and deemed to be excluded without invalidating any of the remaining terms. Razer reserves the right to amend any term at any time without notice.