



Questo manuale d'istruzione è fornito da trovaprezzi.it. Scopri tutte le offerte per [Razer Seiren V3 Mini Nero](#) o cerca il tuo prodotto tra le [migliori offerte di Cuffie e Microfoni](#)



RAZER SEIREN V3 MINI

MASTER GUIDE

Meet the **Razer Seiren V3 Mini**—an ultra-compact USB microphone that now packs even more. Featuring a new tap-to-mute function and advanced audio customization, enjoy studio-quality voice capture with the perfect pint-sized companion for gaming, streaming, and chatting.

CONTENTS

1. WHAT'S INSIDE.....	3
2. WHAT'S NEEDED.....	4
3. LET'S GET YOU COVERED.....	4
4. TECHNICAL SPECIFICATIONS.....	5
5. SETTING UP YOUR MICROPHONE	6
6. CONFIGURING YOUR RAZER SEIREN V3 MINI.....	8
7. SAFETY AND MAINTENANCE.....	16
8. LEGALESE.....	17

1. WHAT'S INSIDE

- Razer Seiren V3 Mini

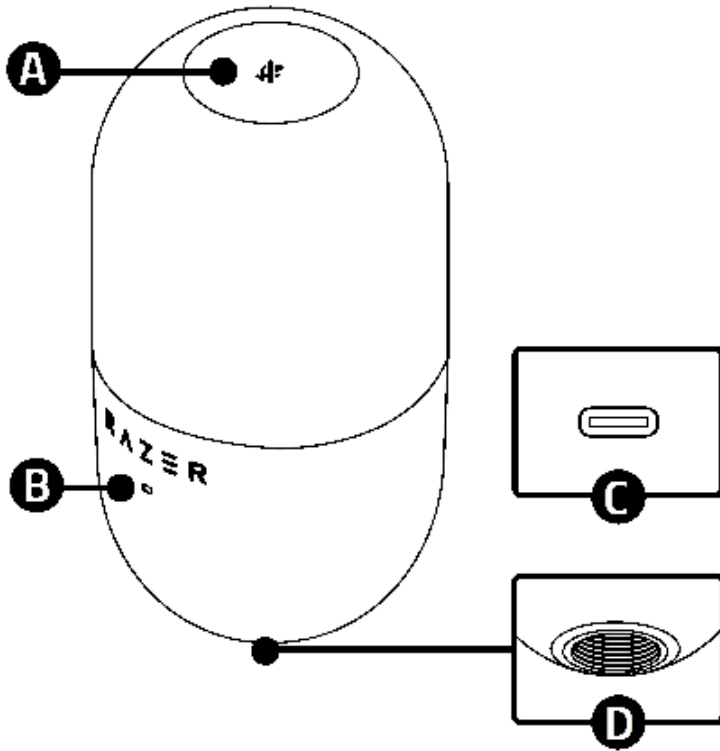

- A. Mute touch button
- B. Status indicator
- C. USB Type C port
- D. Thread mount

- Support rod

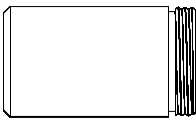

- USB Type A to Type C cable

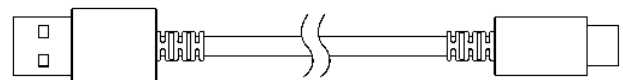

- Desk stand base

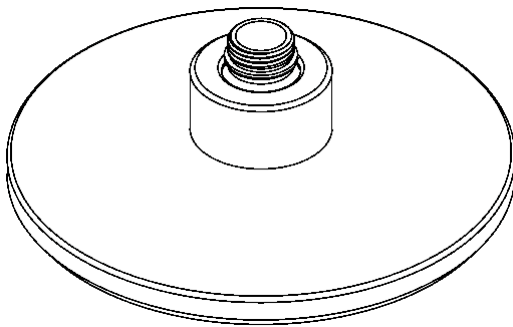

- Important Product Information Guide

2. WHAT'S NEEDED

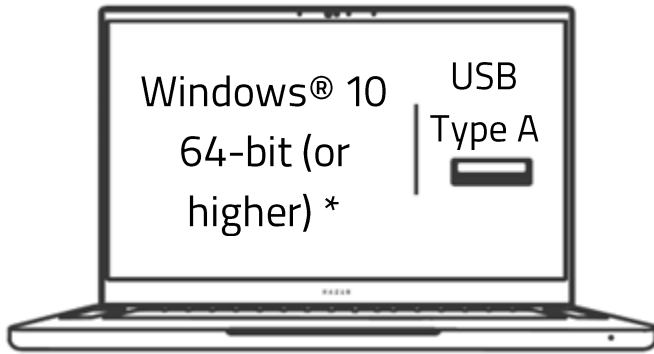

**Other compatible software include Audacity, OBS, Streamlabs OBS, and XSplit (software license fee may apply).*

3. LET'S GET YOU COVERED

Your product's serial number can be found here.

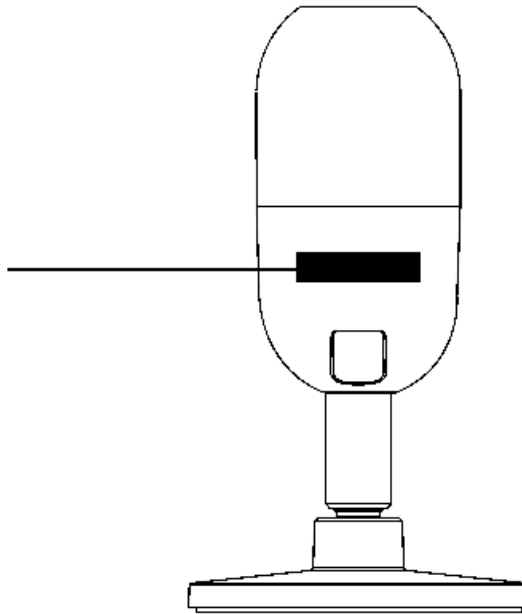

Register your product and score exclusive benefits.
razerid.razer.com/warranty

4. TECHNICAL SPECIFICATIONS

MICROPHONE SPECIFICATIONS

- Power Required / Consumption: 5V/350mA
- Sample rate: 96KHz
- Bit rate: 24
- Capsules: 14mm Condenser capsule
- Polar pattern: Supercardioid
- Frequency response: 20Hz ~ 20KHz
- Sensitivity: -36dB (1 V /Pa at 1kHz)
- Max SPL: 110dB
- Signal to Noise: None

5. SETTING UP YOUR MICROPHONE

1.

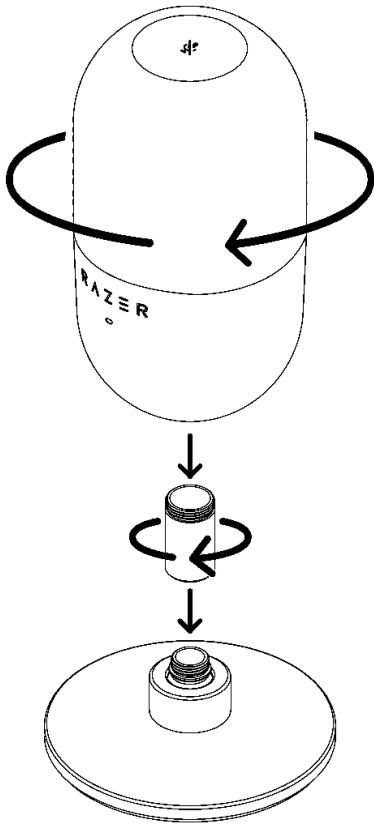

2.

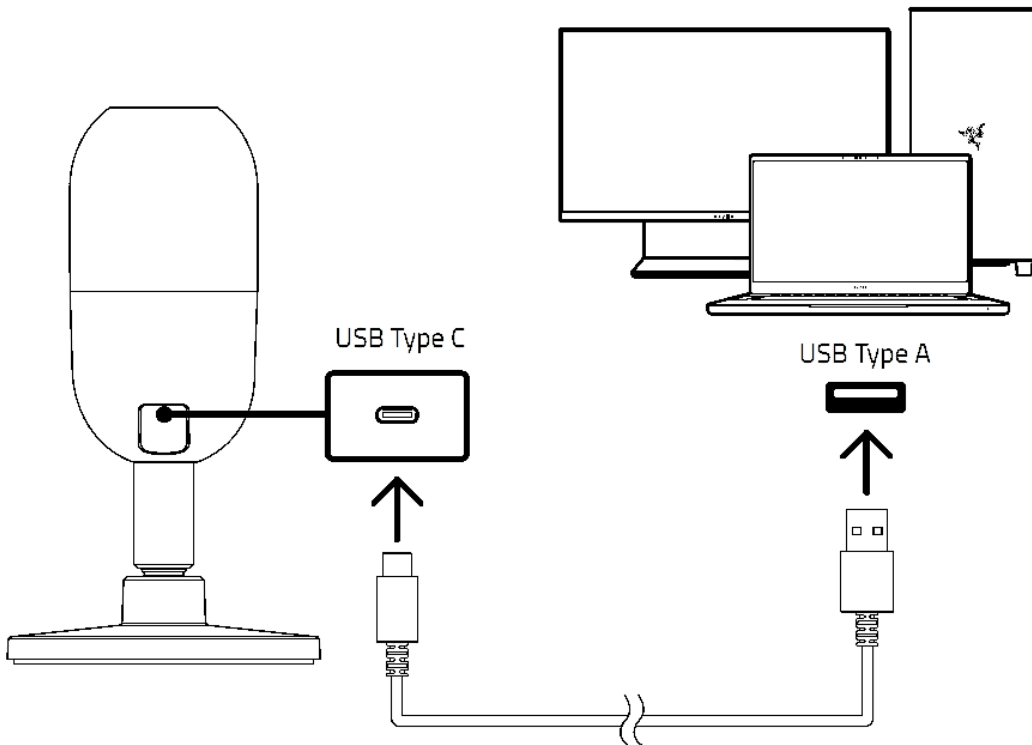

3.

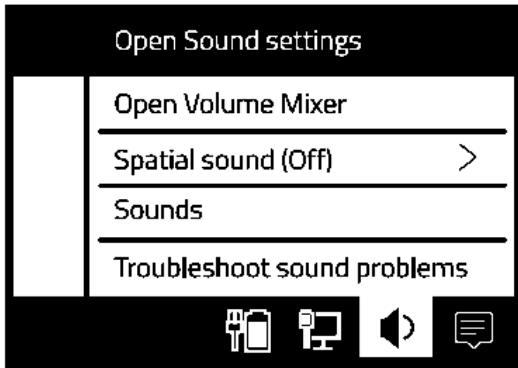

Input

Choose your input device

Razer Seiren V3 Mini



i Install Razer Synapse when prompted or download the installer from razer.com/synapse.

4.



6. CONFIGURING YOUR RAZER SEIREN V3 MINI

i Internet connection is required for installation, updates and cloud-based features. Registering for a Razer ID account is recommended, but optional. All listed features are subject to change based on the current software version, connected device(s), and supported apps and software.

SYNAPSE TAB

The Synapse tab is your default tab when you first launch Razer Synapse. This tab allows you to navigate the Dashboard subtab.

Dashboard

The Dashboard subtab is an overview of your Razer Synapse where you can access all your Razer devices, modules, and online services.

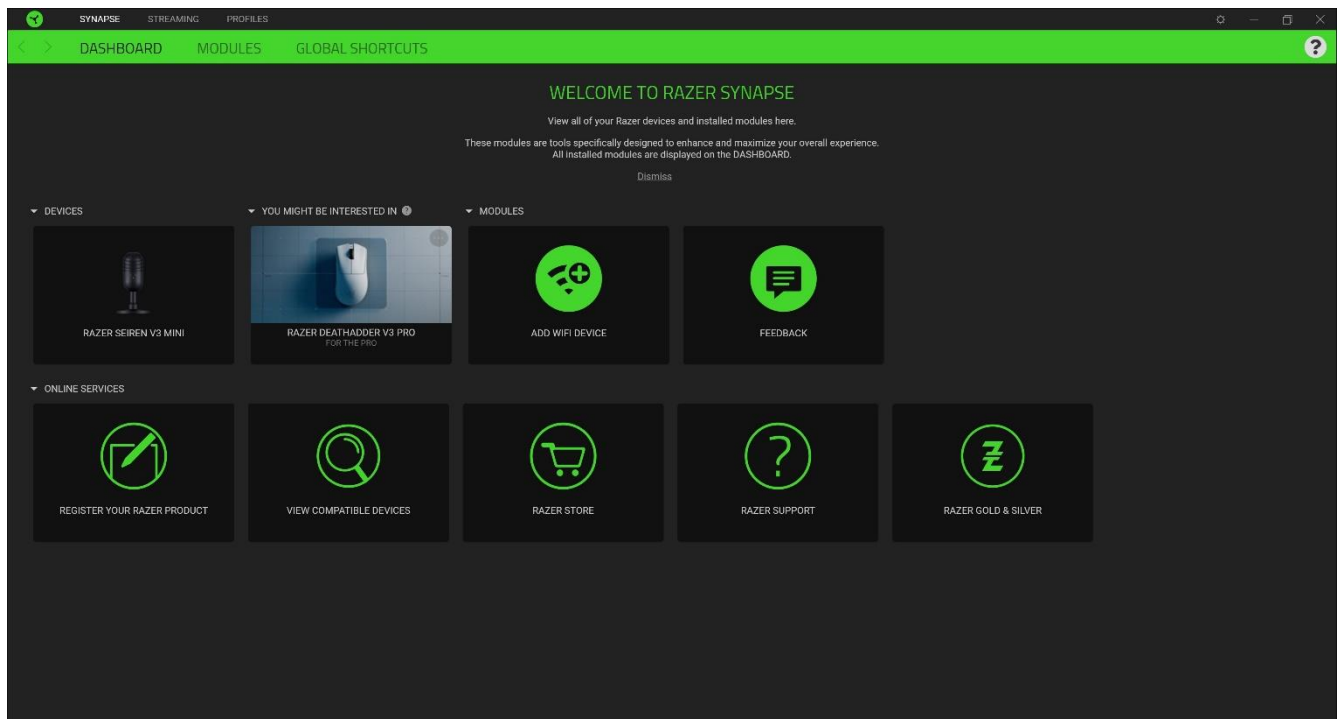

Modules

The Modules subtab displays all installed and available modules for installation.

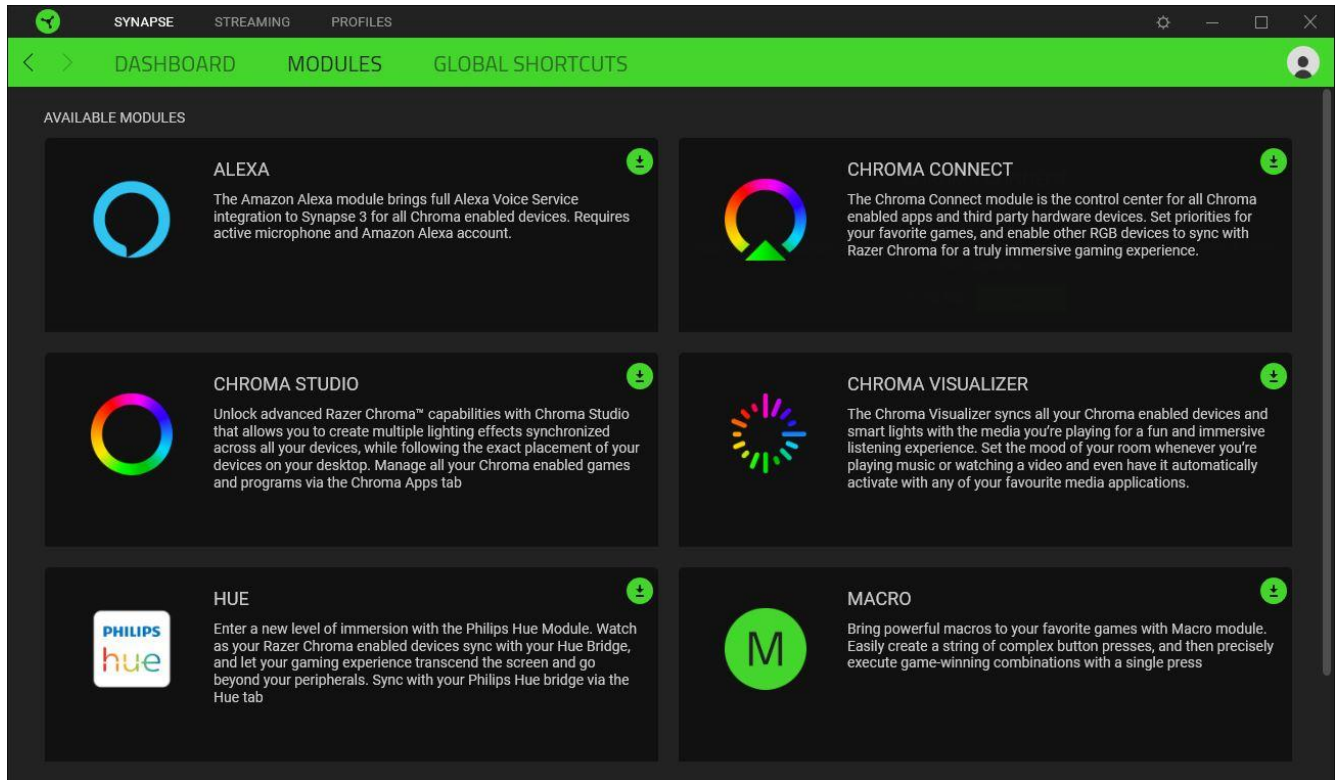

Global Shortcuts

Bind operations or Razer Synapse functions to custom key-combinations from any Razer Synapse-enabled device inputs which apply across all device profiles. [Learn more about Profiles](#)

! *Only Razer Synapse-enabled device inputs will be recognized.*

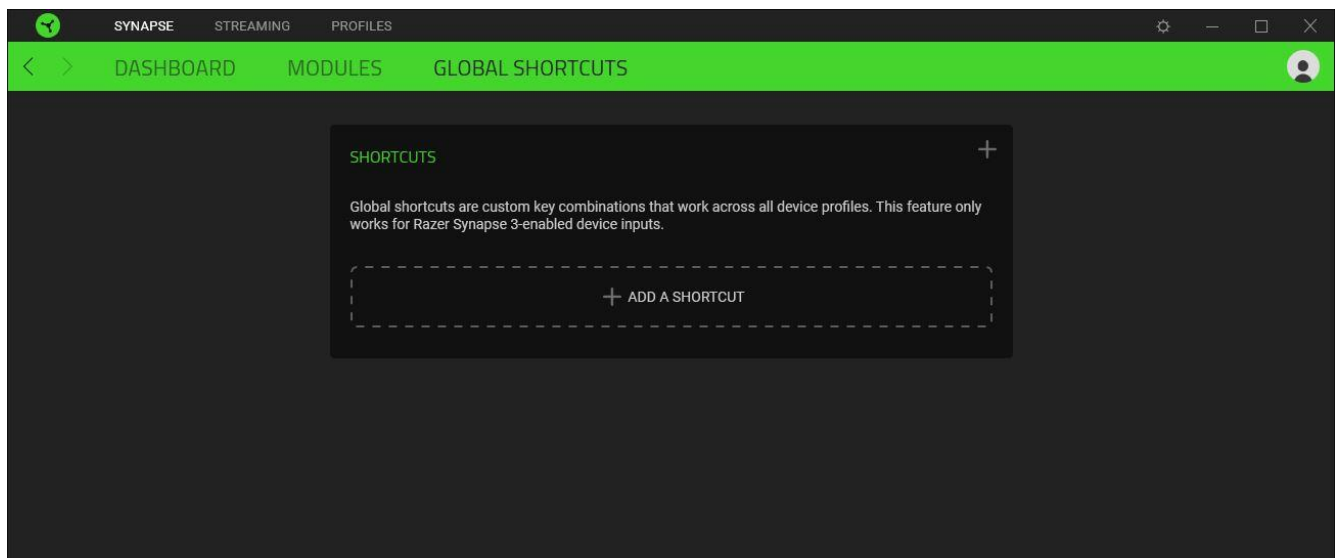

STREAMING TAB

The Streaming tab is the main tab for your Razer Seiren V3 Mini. From here, you'll be able to adjust the microphone gain and headphone volume, enable features such as high pass filter and analog gain limiter and even route specific applications to input channels which you can mix to a single audio channel.

Mic

The Mic subtab is for customizing the mute button, monitoring the input volume, adjusting the microphone sensitivity, and changing the sampling rate.

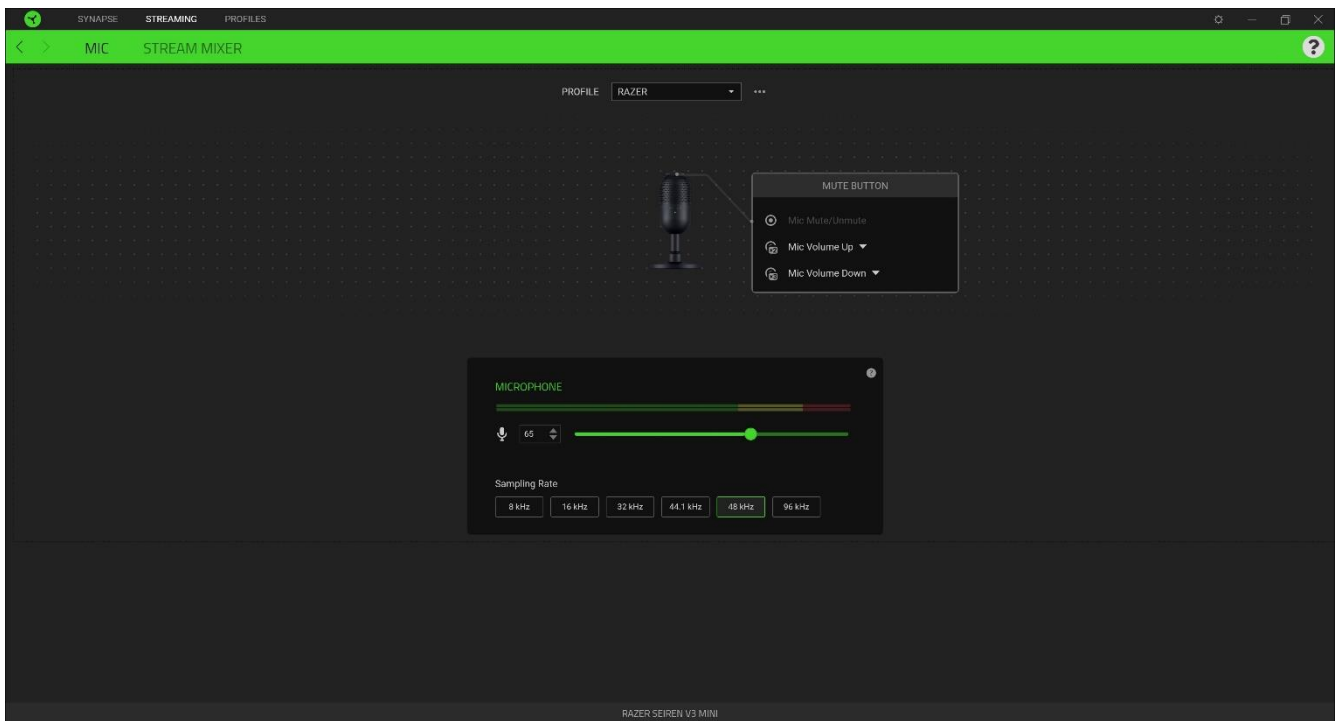

Profile

A Profile is a data storage for keeping all your Razer devices' settings. By default, the profile name is based on your system's name. To add, import, rename, duplicate, export, or delete a profile, press the profile's corresponding Miscellaneous button (●●●).

Mute button assignment

This feature displays the volume level of the captured audio.

Microphone input bar

This feature displays the volume level of the captured audio.

Microphone gain

Mute the microphone by clicking on the microphone gain icon (🎤) or use the slider to increase or decrease its sensitivity.

Sampling rate

Determines the resolution of your recordings. The higher the sampling rate, the more often the computer receives information about the captured audio, providing a more accurate capture and representation of audio.

Stream Mixer

The Stream Mixer subtab enables you to monitor, individually adjust, and mix all available virtual input channels on a single virtual output channel. Changes made under this tab are automatically saved to your system and cloud storage.

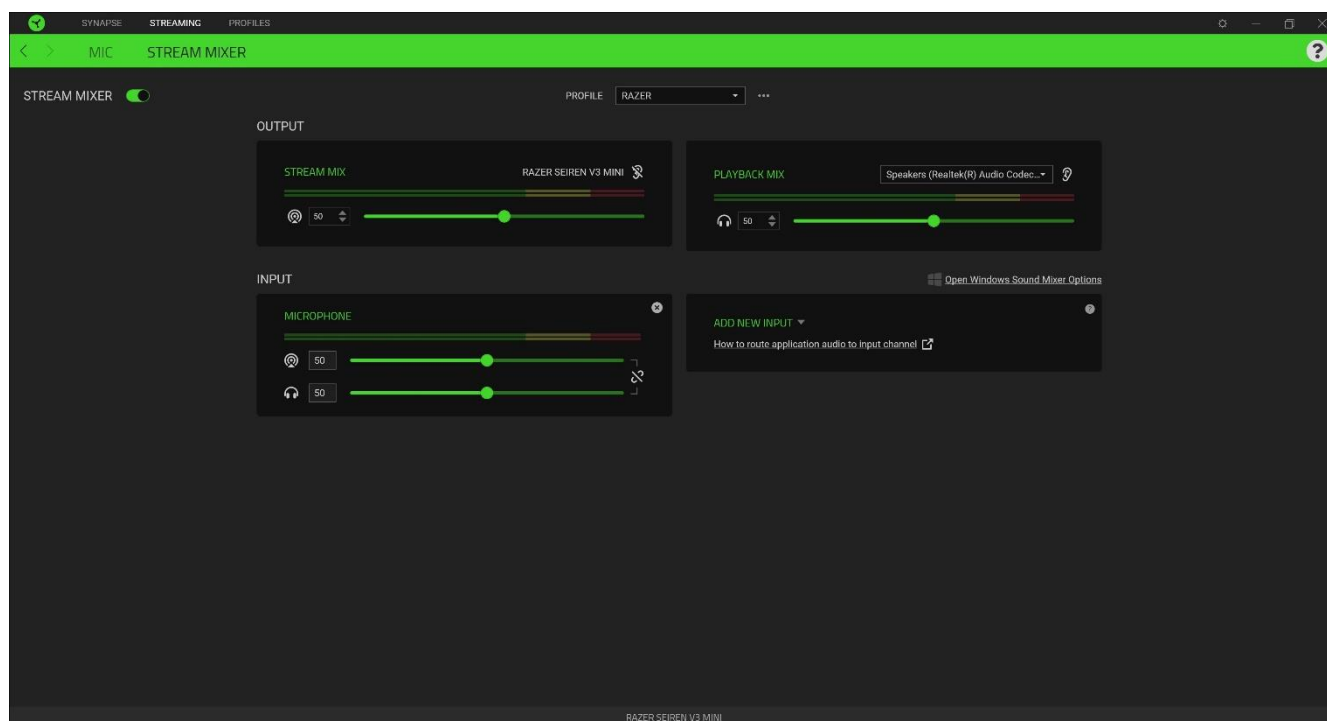

Output

Output channels are virtual channels recognized by the Windows operating system as Input devices. Upon installing Razer Synapse, the following output channels become available:



- **Stream Mix.** Combines all input channels in a single stream. Set this channel as the microphone or input device of your streaming software (e.g. OBS, Twitch, Streamlabs etc.) to individually control the volume of each channel using Razer Synapse.

! *Adjusting the slider of the Stream Mix will increase or decrease the volume of what you hear in your recording / streams. Instructions in setting the Stream Mix as the input device for your streaming software may vary.*

- **Playback Mix.** Allows you to listen to all channels using the selected playback device. The 3.5 mm headphone port of the microphone is set as the Playback device by default.

 *Adjusting the slider of the Playback Mix only increases or decreases the volume of the selected playback device.*

The following controls are available for both output channels:

- **Mute Stream Mix** (). Click to mute the Stream Mix channel.
- **Mute Playback Mix** (). Click to mute the Playback Mix channel.
- **Enable/Disable monitoring** (). Listen to either the Stream Mix or the Playback Mix.

Open Windows Sound Mixer Options





Opens the **App volume and device preferences** on Windows where you can route specific applications to various virtual input channels.

Input

Input channels are virtual channels recognized by the Windows operating system as Output devices. You can assign applications to Browser, Headphones, Game, Sound effects, System, Music input channels, with other input devices assignable to Aux (1 / 2 / 3) channels.

By assigning specific applications and/or devices to input channels, you can use a single channel on your streaming software while controlling each channel volume individually on Razer Synapse.

The following controls are available for all input channels:

- **Slider**. Adjust how loud the corresponding channel is on Stream Mix and/or Playback Mix.
- **Link** (). Link both Stream Mix and Playback Mix sliders to proportionally adjust the volume of each setting.
- **Mute Stream Mix** (). Click to mute the corresponding channel from the Stream Mix.
- **Mute Playback Mix** (). Click to mute the corresponding channel from the Playback Mix.
- **Remove channel** (). Removes the corresponding input channel from the Stream Mix.

Add New Input

For an input channel to work, an application or a device must be assigned to it first. To add an input channel on Razer Synapse with the desired application/device:

1. Make sure the application that you want to assign is running.
2. On Windows, go to **Windows Sound Mixer Options**.
3. On the **App volume and device preferences** window, go to the desired app, and set its **Output** to the preferred virtual input channel (e.g. Spotify to Music, Google Chrome to Browser, Microphone to Aux 1 etc.).

4. On Razer Synapse, click on **Add New Input** and select the newly configured virtual channel from the dropdown list to include it on the Stream Mix.

PROFILES TAB

The Profiles tab is a convenient way of managing all your profiles and linking them to your games and applications.

Devices

View which games are linked to each device's profiles or which Chroma Effect is linked to specific games using the Devices subtab.

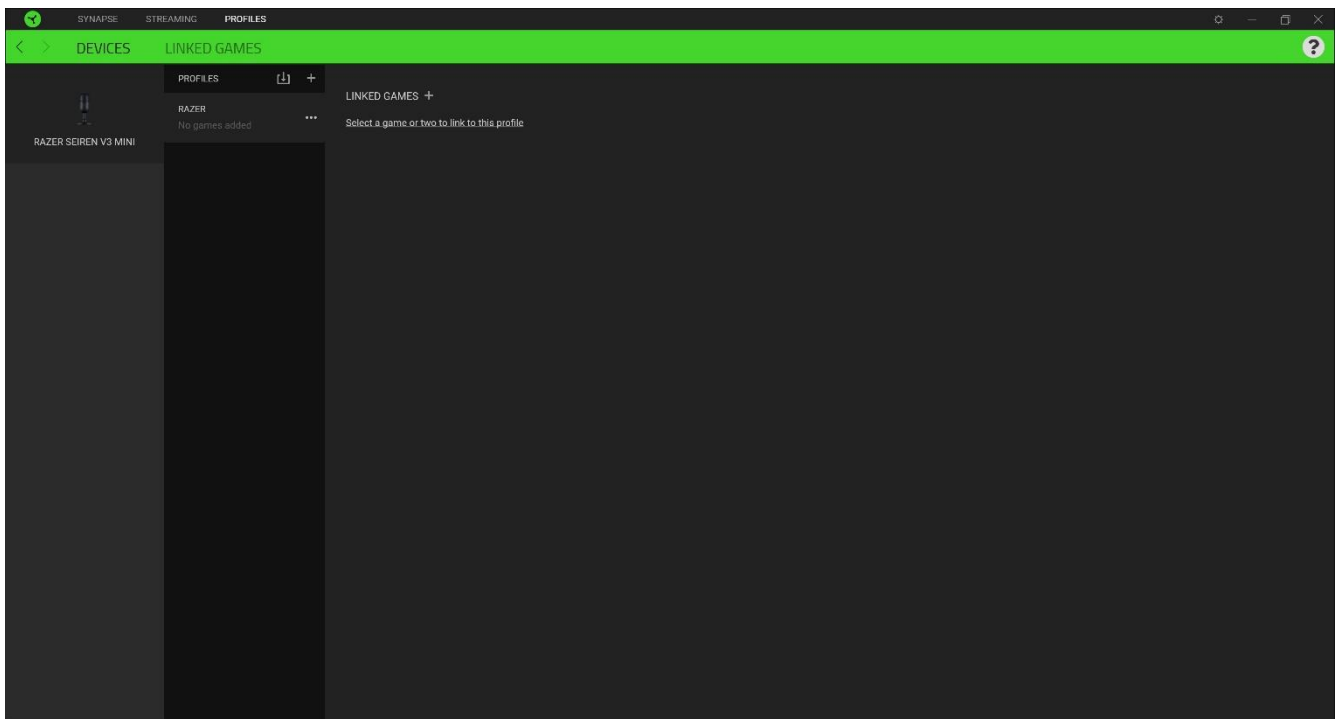

You can import Profiles from your computer or from the cloud through the import button (⌄) or create new profiles within the selected device using the add button (+). To rename, duplicate, export, or delete a profile, simply press the Miscellaneous button (•••). Each profile can be set to automatically activate when you run an application using the Linked Games option.

Linked Games

The Linked Games subtab gives you the flexibility to add games, view devices that are linked to games, or search for added games. You can also sort games based on alphabetical order, last played, or most played. Added games will still be listed here even if it is not linked to a Razer device.

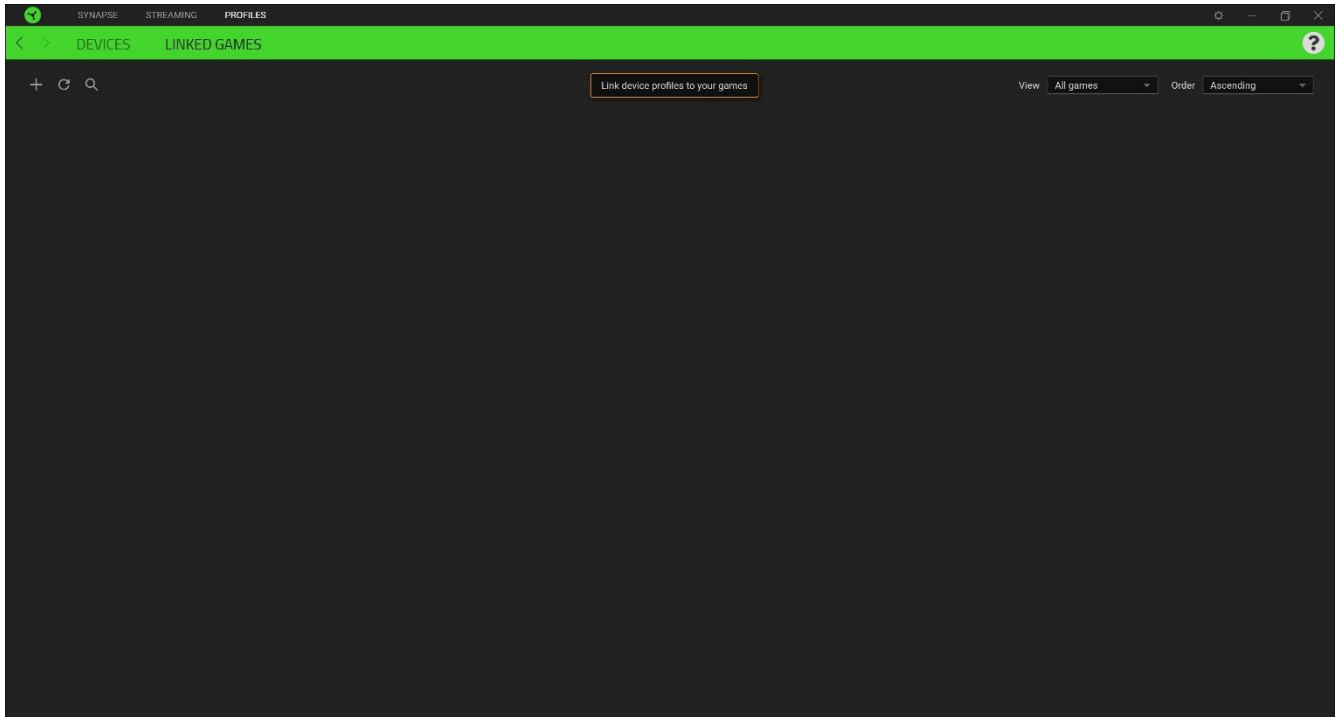

To link games to connected Razer devices or Chroma Effects, simply click on any game from the list, and then click **Select a device and its profile to launch automatically during gameplay** to select the Razer device or Chroma Effect it will link with. Once linked, you may click on the Miscellaneous button (●●●) of the corresponding Chroma Effect or device to select a specific Chroma Effect or profile.

SETTINGS WINDOW

The Settings window, accessible by clicking the (⚙) button on Razer Synapse, enables you to configure the startup behavior and display language of Razer Synapse, view the master guides of each connected Razer device, or perform factory reset on any connected Razer device.

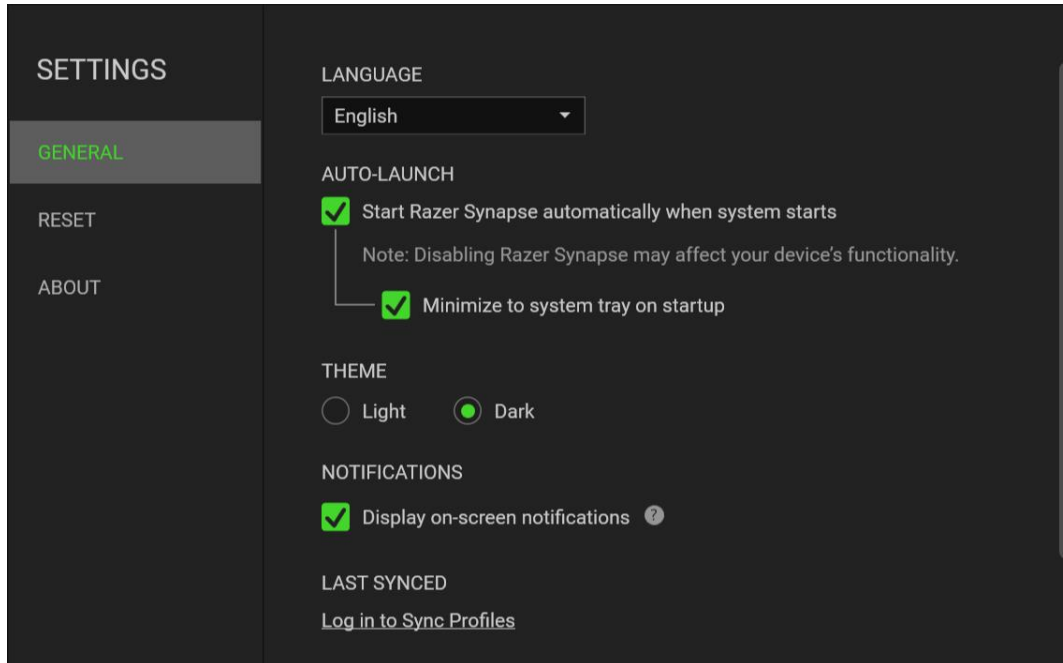

General tab

The default tab of the Settings window. The General tab enables you to change the software's display language, start-up behavior, display theme, and on-screen notifications display. You may also manually sync your profiles to the cloud (↻) or view the master guide of all connected Razer devices and installed modules.

Reset tab

The Reset tab allows you to perform a factory reset on all connected Razer devices with on-board memory and/or reset Razer Synapse tutorials to acquaint yourself again with Razer Synapse's new features on its next launch.

 *By resetting a Razer device, all profiles stored on the selected device's on-board memory will be erased.*

About tab

The About tab displays brief software information, copyright statement and provides relevant links for its terms of use. You may also use this tab to check for software updates, or as a quick access to Razer's social communities.

7. SAFETY AND MAINTENANCE

SAFETY GUIDELINES

In order to achieve maximum safety while using the Razer Seiren V3 Mini, we suggest that you adopt the following guidelines:

Should you have trouble operating the device properly and troubleshooting does not work, unplug the device and contact the Razer hotline or go to support.razer.com for assistance. Do not attempt to service or fix the device yourself at any time.

Do not take apart the device, and do not attempt to operate it under abnormal current loads. Doing so will void your warranty.

Do not puncture nor insert foreign objects into any of the device's openings.

Keep the device and its components away from liquid, humidity or moisture. Operate the device and its components only within the specific temperature range of 0°C (32°F) to 40°C (104°F). Should the temperature exceed this range, unplug and switch off the device in order to let the temperature stabilize to an optimal level.

MAINTENANCE AND USE

The Razer Seiren V3 Mini requires minimum maintenance to keep it in optimum condition. Once a month we recommend you unplug the device from the computer and clean it using a soft cloth or cotton to prevent dirt buildup. Do not use soap or harsh cleaning agents.

8. LEGALESE

COPYRIGHT AND INTELLECTUAL PROPERTY INFORMATION

©2024 Razer Inc. All rights reserved. Razer, the triple-headed snake logo, Razer logo, and “For Gamers. By Gamers.” are trademarks or registered trademarks of Razer Inc. and/or affiliated companies in the United States or other countries. All other trademarks are the property of their respective owners.

Windows and the Windows logo are trademarks or registered trademarks of the Microsoft group of companies.

XSplit and XSplit Broadcaster are registered trademarks of SplitmediaLabs Limited.

Razer Inc. (“Razer”) may have copyright, trademarks, trade secrets, patents, patent applications, or other intellectual property rights (whether registered or unregistered) concerning the product in this guide. Furnishing of this guide does not give you a license to any such copyright, trademark, patent or other intellectual property right. The Razer Seiren V3 Mini (the “Product”) may differ from pictures whether on packaging or otherwise. Razer assumes no responsibility for such differences or for any errors that may appear. Information contained herein is subject to change without notice.

LIMITED PRODUCT WARRANTY

For the latest and current terms of the Limited Product Warranty, please visit razer.com/warranty.

LIMITATION OF LIABILITY

Razer shall in no event be liable for any lost profits, loss of information or data, special, incidental, indirect, punitive or consequential or incidental damages, arising in any way out of distribution of, sale of, resale of, use of, or inability to use the Product. In no event shall Razer’s liability exceed the retail purchase price of the Product.

GENERAL

These terms shall be governed by and construed under the laws of the jurisdiction in which the Product was purchased. If any term herein is held to be invalid or unenforceable, then such term (in so far as it is invalid or unenforceable) shall be given no effect and deemed to be excluded without invalidating any of the remaining terms. Razer reserves the right to amend any term at any time without notice.