



RICOH

GR

RICOH GR IV
Operating Manual

The serial number is located on the bottom of the camera.

Chapter 1: Introduction

Read this chapter before use.

This chapter gives you an overview of the RICOH GR IV.

Chapter 2: Getting Started

Read this chapter before using the RICOH GR IV for the first time.

This chapter explains about basic operations such as turning the camera on, performing shooting, and playing back images.

Chapter 3 and later

Read these chapters when you want to learn more about the different camera functions.

These chapters explain about shooting and playback functions, as well as how to customize the camera settings and use it with a computer.

Model: R09010

Regarding User Registration

Thank you for purchasing a RICOH IMAGING product.

In order to provide you with the best customer support and service experience for the product you have purchased, we ask you to complete the user registration.

Visit the following website to complete the user registration.

<https://www.ricoh-imaging.com/registration/>

Registered users will be notified by e-mail about important customer support information, such as firmware version updates, etc.

Introduction

This Operating Manual provides information on how to use the shooting and playback functions of this camera and related precautions.

Thoroughly read this Operating Manual to make the best use of the functions available with this camera. Be sure to keep this Operating Manual for future reference.

It is recommended to update the camera firmware to the latest version before using the camera.

For details on the latest firmware version, refer to the following firmware download site.

<https://www.ricoh-imaging.co.jp/english/>

RICOH IMAGING COMPANY, LTD.

Safety precautions	Read all safety precautions thoroughly to ensure safe use.
Test shots	Take test shots to ensure that the camera is working properly before taking pictures on important occasions.
Copyright	Reproduction or alteration of copyrighted documents, magazines, and other materials, other than for personal, home, or other similarly limited purposes, without the consent of the copyright holder, is prohibited.
Exemption from liability	RICOH IMAGING COMPANY assumes no liability for failure to record or display images as a result of product malfunction.
Radio interference	<p>Operating this camera in the vicinity of other electronic equipment may adversely affect both the camera and the other device. Interference is particularly likely if the camera is used in close proximity to a radio/TV receiver. In such case, take the following measures.</p> <ul style="list-style-type: none"> • Keep the camera as far away as possible from the radio/TV receiver. • Reorient the antenna of the radio/TV receiver. • Use a different wall outlet.

This publication may not be reproduced in whole or in part without RICOH IMAGING COMPANY's express written permission.

© RICOH IMAGING COMPANY, LTD. 2025

RICOH IMAGING COMPANY reserves the right to change the contents of this manual at any time without prior notice.

Every effort has been made to ensure the accuracy of the information in this manual. Should you nevertheless notice any errors or omissions, we would be grateful if you would notify us at the address listed on the back cover of this manual.

About the Wireless LAN and Bluetooth® Functions

- Do not use the camera in a place where electrical products, AV/OA devices, and so on generate magnetic fields and electromagnetic waves.
- If the camera is affected by magnetic fields and electromagnetic waves, it may not be able to communicate.
- If the camera is used near a TV or radio, poor reception or TV screen glitch may occur.
- If there are multiple wireless LAN access points or Bluetooth® devices near the camera and the same channel is used, search operation may not be executed correctly.
- The security of your data stored, sent, or received is your own responsibility.

In the frequency band used by the camera, along with industrial, scientific, and medical devices such as microwave ovens, premises radio stations (wireless stations requiring license) and specified low power radio stations (wireless stations not requiring license) for mobile object identification used in factory production lines, etc., and amateur radio stations (wireless stations requiring license) are operated.

1. Before using the camera, confirm that premises radio stations and specified low power radio stations for mobile object identification and amateur radio stations are not operated in the vicinity.
2. In the event that the camera causes harmful radio wave interference to premises radio stations for mobile object identification, immediately change the frequency being used to avoid interference.
3. If you have other troubles such that the camera causes harmful radio wave interference to specified low power radio stations for mobile object identification or to amateur radio stations, contact your nearest service center.

The certification marks can be displayed electronically on the monitor.



Displaying the Certification Marks

- 1 Press **MENU** to display the menu screen.
- 2 Use **▲▼◀▶** to display the **↻ 8** menu (About This Device).
- 3 Use **▲▼◀▶** to select [Certification Marks], and press **OK**.

Les marques de certification peuvent être affichées électroniquement sur l'écran.



Affichage des marques de certification

- 1 Appuyez sur **MENU** pour afficher l'écran de menu.
- 2 Utilisez **▲▼◀▶** pour afficher le menu **↻ 8** (À propos de l'appareil).
- 3 Utilisez **▲▼◀▶** pour sélectionner [Marques de certification], et appuyez sur **OK**.

Trademarks

- Microsoft and Windows are registered trademarks of Microsoft Corporation in the United States of America and other countries.
 - Mac, macOS, and App Store are trademarks of Apple Inc.
 - IOS is a trademark or registered trademark of Cisco Systems, Inc. in the U.S. and other countries and is used under license.
 - Adobe and the Adobe logo are registered trademarks or trademarks of Adobe Systems Incorporated in the United States and/or other countries.
 - This product includes DNG technology under license by Adobe Systems Incorporated.
 - The DNG logo is either a registered trademark or trademark of Adobe Systems Incorporated in the United States and/or other countries.
 - The microSDXC logo is a trademark of SD-3C, LLC.
 - Google, Google Play, and Android are trademarks or registered trademarks of Google LLC.
 - Bluetooth is a registered trademark or trademark of Bluetooth SIG, Inc. in the U.S. and other countries.
 - USB Type-C and USB-C are trademarks of USB Implementers Forum.
 - DisplayPort™ is a trademark owned by the Video Electronics Standards Association (VESA®) in the United States and other countries.
 - HDMI, the HDMI logo, and High-Definition Multimedia Interface are trademarks or registered trademarks of HDMI Licensing Administrator, Inc. in the United States and/or other countries.
- Other company names, product names, and logos are trade names, trademarks, or registered trademarks of their respective companies.
- This product uses the RICOH RT font designed by RICOH COMPANY, LTD.

AVC Patent Portfolio License

This product is licensed under the AVC Patent Portfolio License for the personal use of a consumer or other uses in which it does not receive remuneration to (i) encode video in compliance with the AVC standard ("AVC video") and/or (ii) decode AVC video that was encoded by a consumer engaged in a personal activity and/or was obtained from a video provider licensed to provide AVC video. No license is granted or shall be implied for any other use. Additional information may be obtained from Via Licensing Alliance. See <https://www.via-la.com/>.



Announcement about the Open Source Software

This camera includes the open source software (OSS) licensed under the GNU General Public License (GPL), GNU Lesser General Public License (LGPL), and/or other licenses. The information about licenses of each OSS used in the camera is saved in the camera internal memory as a text file. Connect the camera to a computer, access the "oss_license" folder under "Software License", and open each text file to read the license terms. The source codes of OSS used in the camera are disclosed under the license terms of GPL, LGPL, etc. If you need the source codes, access the following URL.
<https://www.ricoh-imaging.co.jp/english/products/oss/>

Safety Precautions

Warning Symbols

Various symbols are used throughout this Operating Manual and on the product to prevent physical harm to you or other people and damage to property. The symbols and their meanings are explained below.

 Danger	This symbol indicates matters that may lead to imminent risk of death or serious injury if ignored or incorrectly handled.
 Warning	This symbol indicates matters that may lead to death or serious injury if ignored or incorrectly handled.
 Caution	This symbol indicates matters that may lead to injury or physical damage if ignored or incorrectly handled.

Meaning of Symbols



The  symbol alerts you to actions that must be performed.



The  symbol alerts you to prohibited actions.

The  symbol may be combined with other symbols to indicate that a specific action is prohibited.

Example:

: Do not touch : Do not disassemble

Observe the following precautions to ensure safe use of this camera.

Danger



- Do not attempt to disassemble, repair, or alter the camera yourself. The high-voltage circuitry in the camera poses significant electrical hazard.
- Do not attempt to disassemble, alter, or directly solder the battery.



- Do not put the battery in a fire, attempt to heat it, use it in a high temperature environment such as next to a fire or inside a car, or abandon it. Do not put it into water or the sea or allow it to get wet.
- Do not attempt to pierce, hit, compress, drop, or subject the battery to any other severe impact or force.
- Do not use a battery that is significantly damaged or deformed.
- Do not connect the positive (+) and negative (-) poles of the battery with a wire or other metallic item. Also, do not carry or store together with metal objects such as ballpoint pens and necklaces.
- Stop using the camera immediately in the event of abnormalities such as smoke, unusual odors, or excessive heat being emitted. Contact your nearest service center or dealer for repair.



- Use the camera or optional Battery Charger BJ-12 to charge the battery. Do not use the battery with any camera except the cameras compatible with the DB-120.
- If the battery fluid leaks and gets into your eyes, immediately wash your eyes thoroughly with tap water or other clean water without rubbing, and seek medical attention immediately.

Warning



- Turn off the power immediately in the event of abnormalities such as smoke or unusual odors being emitted. Remove the battery as soon as possible, being careful to avoid electric shocks or burns. If you are drawing power from a household electrical outlet, be sure to unplug the power plug from the outlet. Failure to observe this precaution could result in fire or electric shocks. Contact your nearest service center or dealer. Stop using the camera immediately if it is malfunctioning.
- Turn off the power immediately if any metallic object, water, liquid, or other foreign object gets into the camera. Remove the battery and memory card as soon as possible, being careful to avoid electric shocks or burns. If you are drawing power from a household electrical outlet, be sure to unplug the power plug from the outlet. Failure to observe this precaution could result in fire or electric shocks. Contact your nearest service center or dealer. Stop using the camera immediately if it is malfunctioning.
- If the monitor is damaged, avoid any contact with the liquid crystal inside it. Follow the appropriate emergency measures below.
- SKIN: If any of the liquid crystal gets on your skin, wipe it off and rinse the affected area thoroughly with water, then wash well with soap.
- EYES: If it gets in your eyes, wash your eyes with clean water for at least 15 minutes and seek medical advice immediately.
- INGESTION: If any of the liquid crystal is ingested, rinse the mouth out thoroughly with water. Have the person drink a large amount of water and induce vomiting. Seek medical assistance immediately.
- Keep the battery and memory card used in the camera out of the reach of children to prevent accidental swallowing. The battery and memory card are harmful if swallowed. Seek medical assistance immediately.



- Follow these precautions to prevent the battery from leaking, overheating, igniting, or exploding.
- Do not use a battery other than those specifically recommended for the camera.
- Do not carry or store the battery together with metal objects such as ballpoint pens, necklaces, coins, and hairpins.
- Do not put the battery into a microwave or high pressure container.
- If leakage of battery fluid, a strange odor, color change, etc. is noticed during use or during charging, remove the battery from the camera or battery charger immediately and keep it away from fire.
- Observe the following in order to prevent fire, electrical shock, or exploding of the battery while charging.
- Use only the indicated power supply voltage. Also avoid the use of multi-socket adapters and extension cords.
- Keep the battery out of the reach of children.
- If the battery does not finish charging after the prescribed charging time, discontinue charging.
- If the battery leaks or emits an unusual odor, immediately move it away from any sources of fire.
- Keep the camera out of the reach of children. For children, accidents may occur because they cannot understand the contents of "Safety Precautions" and "Precautions for Use".
- Do not use the camera near flammable gases, gasoline, benzene, thinner, or similar substances. Failure to observe this precaution could result in an explosion, fire, or burns.
- Do not use the camera in a location where usage is restricted or prohibited, such as on airplanes. Failure to observe this precaution could result in an accident.
- Do not use the battery charger or AC adapter with commercially available electronic transformers when traveling abroad. Failure to observe this precaution could result in fire, electric shocks, or product malfunction.
- Use only the indicated power supply voltage. Failure to observe this precaution could result in fire or electric shocks.



- Do not touch the internal components of the camera if they become exposed as a result of being dropped or damaged. The high-voltage circuitry in the camera could lead to electric shocks. Remove the battery as soon as possible, being careful to avoid electric shocks or burns. Contact your nearest service center or dealer if it is damaged.
- If you see a lightning flash or hear thunder during use of the battery charger or AC adapter, do not touch the power plug. Failure to observe this precaution could result in electric shocks.



- If any metallic object, water, liquid, or other foreign object gets into the camera, immediately remove the power plug from the outlet and contact your nearest service center or dealer for repair. Failure to observe this precaution could result in fire or electric shocks.
- If an abnormality such as an unusual sound or smoke is emitted from the camera, immediately remove the power plug from the outlet and contact your nearest service center or dealer for repair. Stop using the camera immediately if it is malfunctioning.



- Do not attempt to disassemble the camera yourself. The high-voltage circuitry in the camera could lead to electric shocks.



- Do not use the camera in wet areas such as a kitchen. Failure to observe this precaution could result in fire or electric shocks.
- Do not use the camera in a bathroom. Failure to observe this precaution could result in fire or electric shocks.



Caution



- Contact with fluid leaking from a battery can lead to burns. If part of your body comes in contact with a damaged battery, rinse the area with water immediately. (Do not use soap.)
If a battery starts to leak, remove it immediately from the camera and wipe the battery chamber thoroughly before replacing it with a new battery.



- Do not allow the camera to get wet. In addition, do not operate it with wet hands. Failure to observe this precaution could result in electric shocks.
- Do not fire the flash at drivers of vehicles, as this may cause the driver to lose control and result in a traffic accident.
- Do not cover the camera while using it. Failure to observe this precaution could result in fire.
- Do not short-circuit the terminal metal contacts. Failure to observe this precaution could result in fire.
- Do not use the camera in wet areas or areas subject to oil smoke such as a kitchen. Failure to observe this precaution could result in fire or electric shocks.



- Remove the power plug from the outlets before cleaning the camera.
- Remove the power plug from the outlets when the camera is not used.

Safety Precautions for Accessories

When using optional products, carefully read the user's manuals provided with the product before using that product.



Memo

- The bags used for camera packaging are made of environmentally friendly bamboo material. If any powder from the packaging bag adheres to the camera, remove it with a commercially available blower or cleaning paper before using the camera.

Contents

Regarding User Registration.....	1
Introduction	1
Safety Precautions.....	5
1 Introduction	13
Checking the Contents of the Package	13
Names and Functions of the Working Parts.....	14
Operating Controls	16
Indicators on the Monitor.....	18
Shooting Screen.....	18
Playback Screen	19
Changing the Screen Display	20
Using the Touch Screen	21
How to Change Function Settings	22
Using the Buttons and Dial	22
Using the Menus.....	25
Menu List	28
📷 Still Image Setting Menu.....	28
🎬 Movie Settings Menu.....	31
▶ Playback Settings Menu.....	32
⚙️ Customize Settings Menu.....	34
🔧 Setup Menu.....	37
2 Getting Started	40
Setting the Battery and a Memory Card	40
Inserting the Battery and a Memory Card	40
Charging the Battery.....	42
Initial Settings.....	44
Turning the Camera On	44
Setting the Language, Smartphone Linkage, and Date/Time.....	45
Formatting a Memory Card.....	46
Basic Shooting Operation.....	48
Shooting in the Program Mode.....	48
Viewing the Taken Images.....	50
3 Taking Images	52
Taking Still Pictures	52
Setting the Exposure Mode	52

Recording Movies.....	57
Playing Back Movies	59
Setting the Focus.....	60
Setting the Focus Mode	60
Shooting Close-ups (Macro)	65
Shooting with a Single Press of the Shutter Release Button (Full Press Snap)	66
Setting the Exposure	67
Selecting the Metering Method	67
Setting the ISO Sensitivity	69
Using the Flash	70
Reducing Noise	73
Setting the White Balance	75
Setting the White Balance Manually.....	78
Setting the Color Temperature	79
Setting the Drive Mode	80
Shooting Continuously (Continuous Shooting)	81
Shooting with Varied Exposure Values (Bracketing)	82
Shooting While Merging Images Together (Multi-exposure)	83
Shooting Automatically at Set Intervals (Interval Shooting)	85
Recording Star Trails (Interval Composite)	87
Using the Self-timer	89
Configuring the Image Save Settings	90
Setting the Save Destination.....	90
Still Image Save Settings.....	91
Movie Save Settings.....	92
Setting the Image Finishing Tone and Correction	93
Using the ND Filter	93
Reducing Moiré (AA Filter Simulator).....	93
Setting the Image Atmosphere (Image Control).....	94
Correcting the Peripheral Illumination.....	96
Correcting a Range of Tones (D-Range Correction)	97
Reducing Blurring of Images.....	98
Correcting the Skew of Images.....	98

4 Playback Functions **99**

Using the Playback Functions	99
Changing the Playback Method.....	100
Displaying Multiple Images	100
Displaying Rotated Images	101
Connecting the Camera to an AV Device.....	102

Organizing Files.....	103
Deleting Files.....	103
Protecting Images from Deletion	105
Copying Images	107
Setting the Transfer Reservation for Images.....	109
Editing and Processing Images	111
Developing RAW Images	111
Changing the Image Size.....	114
Correcting Highlight/Shadow Areas (Levels Adjustment).....	116
Correcting the White Balance	118
Correcting Color Moiré.....	119
Adjusting the Image Quality	120
Editing Movies	121
5 Sharing Images	123
Using the Camera with a Computer	123
Using the Camera with a Communication Device.....	124
Connecting the Camera to a Communication Device	125
Setting Functions Linked with the Communication Device	128
6 Changing the Settings	129
Saving Frequently Used Settings.....	129
Saving the Current Settings.....	129
Using the Setting Boxes	131
Using the User Mode.....	133
Customizing the Button Functions	134
Changing the Dial Operation for the Exposure Mode.....	134
Registering Functions to the ADJ. Mode.....	134
Changing the Functions of the Fn Button	136
Setting the Operation of the Shutter Release Button	139
Selecting the Settings to Save in the Camera	140
Display and Sound Settings.....	141
Setting the Information Displayed During Shooting/Playback	141
Setting the Instant Review Display	142
Setting the Live View Display	143
Setting the Brightness and Tone of the Monitor.....	143
Setting the Lamp	144
Setting the Sound Effects	145
Power Saving Settings	146
Automatically Turning the Power Off.....	146
Dimming the Display.....	147

File Management Settings	148
Specifying the Folder/File Settings	148
Setting the Copyright Information.....	153

7 Appendix 155

Attaching Optional Accessories	155
Conversion Lens/Lens Adapter.....	155
Troubleshooting	156
Power Supply	156
Shooting	157
Playback/Deletion	160
Others	162
Error Messages.....	163
Main Specifications.....	166
Camera	166
Rechargeable Battery DB-120.....	173
Image Storage Capacity	173
Operating Environment	175
Using the Camera Abroad	176
Precautions for Use	177
Camera Care and Storage.....	179
Warranty Policy.....	180
Regulatory Compliance Statements.....	183
Index.....	196

Checking the Contents of the Package

Before using your digital camera, confirm that the package contains the items listed below.



RICOH GR IV



Hot shoe cover
(Installed on the camera)

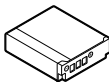

**Rechargeable battery
(DB-120)**

- USB cable (I-USB198)
- Hand strap
- Start Guide

Names and Functions of the Working Parts

1

Introduction

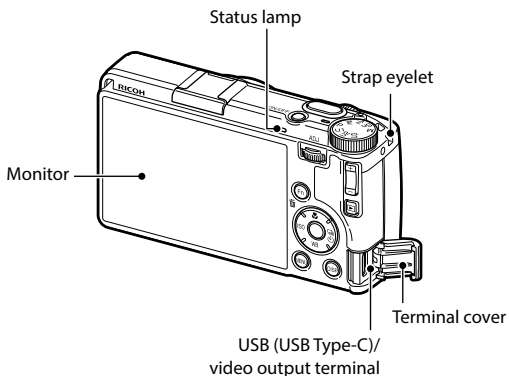
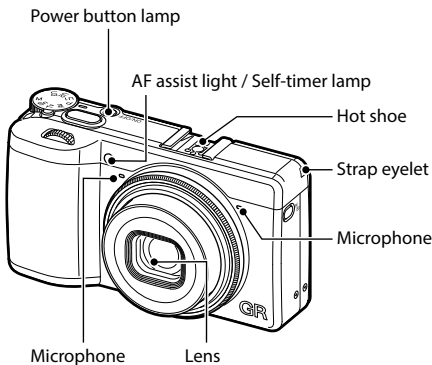

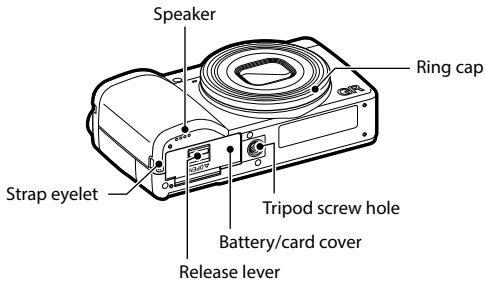

Operating Controls

This section explains about operating controls.
The icons in parentheses are used in the descriptions of this manual.

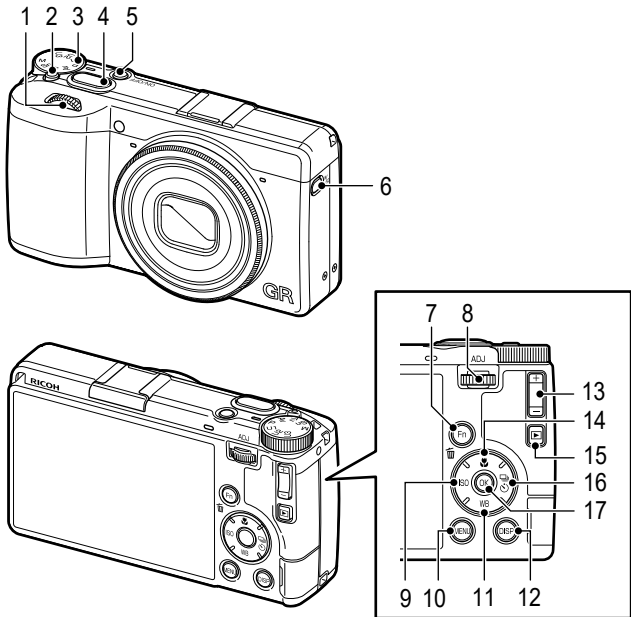

- 1 Front e-dial (☺)**
Changes the values for camera settings such as exposure. (p.52)
Magnifies images in the playback mode. (p.50)
Moves the cursor up and down on the menu screen or image selection screen.
- 2 Lock button**
Allows the mode dial to be turned when pressed.
- 3 Mode dial**
Changes the exposure mode. (p.52)

- 4 Shutter release button (SHUTTER)**
Shoots images.
Activates autofocus when pressed halfway. (p.48)
- 5 Power button**
Turns the power on or off. (p.44)
- 6 Movie/Save destination memory switching button (M/SD)**
Switches between the still picture mode and the movie mode. (p.57)
Switches the save destination memory when pressed and held. (p.41)
- 7 Fn/Delete button (Fn/🗑️)**
Calls the assigned function. (p.23)
Deletes images in the playback mode. (p.50)
- 8 ADJ./Rear e-dial (ADJ/🌀)**
Changes the values for camera settings such as exposure. (p.52)
Switches to the ADJ. mode when pushed in during the shooting mode. (p.24)
Moves the cursor right and left and confirms the selected items when pushed in on the menu screen or image selection screen.
- 9 ISO/Left button (ISO/◀)**
Changes the ISO sensitivity. (p.69)
Moves the cursor to the left when an item is selected.
- 10 MENU button (MENU)**
Displays the menu screen.
Returns to the previous screen when pressed while the menu is displayed. (p.25)
- 11 White balance/Down button (WB/▼)**
Displays the white balance setting screen. (p.76)
Moves the cursor down when an item is selected.
- 12 DISP button (DISP)**
Switches the information displayed on the shooting screen and playback screen. (p.20)
Magnifies the Live View image when pressed and held in the shooting mode. (p.49)
- 13 EV Compensation button (EV)**
Performs exposure compensation. (p.52)
Switches the display in the playback mode. (p.100)
Moves the cursor up and down or increase/decreases the setting value on the menu screen.
- 14 Macro/Up button (M/▲)**
Switches to the macro mode. (p.65)
Moves the cursor up when an item is selected.
- 15 Playback button (▶)**
Switches between the shooting mode and the playback mode. (p.50)
- 16 Drive/Right button (D/▶)**
Displays the drive mode setting screen. (p.80)
Moves the cursor to the right when an item is selected.
- 17 OK button (OK)**
Confirms the selected items on the menu screen, etc.

Indicators on the Monitor

Shooting Screen

1

Introduction

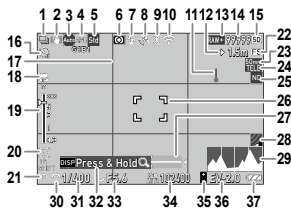

Still image



Movie

- | | | | |
|----|--|----|---|
| 1 | Drive (p.80) | 20 | AF Point Change Priority / Direct Key Priority (p.63) |
| 2 | Shake Reduction / Movie SR (p.98) / Auto Horizon Correction (p.98) | 21 | Exposure mode (p.52) |
| 3 | Focus mode (p.60) | 22 | Full Press Snap (p.66) |
| 4 | White Balance (p.75) | 23 | Crop (p.92) |
| 5 | Image Control (p.94) | 24 | Conversion lens (p.155) |
| 6 | AE Metering (p.67) | 25 | ND Filter (p.93) |
| 7 | Flash Mode (p.71) | 26 | Focus frame (p.49) |
| 8 | GPS positioning status (p.128)* | 27 | Electronic Level (p.141) |
| 9 | Bluetooth® communication (p.125) | 28 | AA Filter Simulator (p.93) |
| 10 | Wireless LAN communication (p.125) / Airplane Mode (p.127) | 29 | Histogram (p.141) |
| 11 | Temperature warning | 30 | Front e-dial |
| 12 | Snap Focus Distance (p.60) | 31 | Shutter speed (p.52) |
| 13 | File Format / JPEG Recorded Pixels (p.91) | 32 | Operation guide |
| 14 | Number of storable images | 33 | Aperture value (p.52) |
| 15 | Save destination (p.41) | 34 | ISO sensitivity (p.69) |
| 16 | Self-timer (p.89) | 35 | EV Compensation button |
| 17 | Grid Guide (p.141) | 36 | Exposure indicator / Exposure compensation (p.52) |
| 18 | Macro Mode (p.65) | 37 | Battery level (p.20) |
| 19 | Focus bar / Depth of field (p.64) | 38 | Recording indicator |
| | | 39 | Recording time / Remaining recording time |

Playback Screen

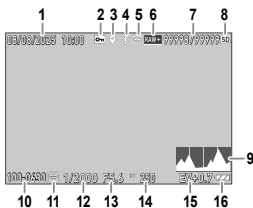

Still image

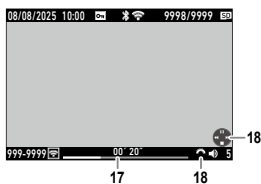

Movie

- | | | | |
|---|---|----|---|
| 1 | Shooting date and time | 10 | Folder number / File number (p.148) |
| 2 | Protect (p.105) | 11 | Image transfer status (p.109) |
| 3 | GPS information (p.128) | 12 | Shutter speed |
| 4 | Bluetooth® communication (p.125) | 13 | Aperture value |
| 5 | Wireless LAN communication (p.125) | 14 | ISO sensitivity |
| 6 | File Format / JPEG Recorded Pixels (p.91) | 15 | Exposure compensation |
| 7 | Current file / Total files | 16 | Battery level (p.20) |
| 8 | Playback source memory (p.51) | 17 | Length of time of the recorded movie / Elapsed time |
| 9 | Histogram (p.141) | 18 | Operation guide |







Memo

- “GPS positioning status” (No. 8 on the shooting screen) is displayed when [Store Location Info.] of [Smartphone Link] is set to [On] in the 6 menu and the camera is linked with a communication device. (p.128)

Battery Level

The icon display changes depending on the battery level.

	The battery level is sufficient.
	The battery level started to drop.
	The battery level is low. Charge the battery.
	The camera will turn off soon.
	There is a problem with the battery.

Changing the Screen Display

Press **DISP** to switch the information displayed on the screen.

Shooting Mode

The information displayed on the shooting screen can be switched.

Standard Info. Display	Displays all the information.
Simplified Info. Display	Displays only the information regarding the exposure, AE lock, autofocus frame, and MF operation guide.
No Information Display	Displays the information only when camera settings are changed. Autofocus frame is displayed during range-finding.
Display Off	Does not display the autofocus frame and Live View but the information when the camera settings are changed.



Memo

- You can specify the displayed information in [Shooting Info. Display] in the **C** 3 menu. (p.141)

Playback Mode

You can switch the displayed information between [Standard Info. Display], [Detailed Info. Display], and [No Information Display] in single image display. Use ▲▼ or flick up and down to switch the page in [Detailed Info. Display].

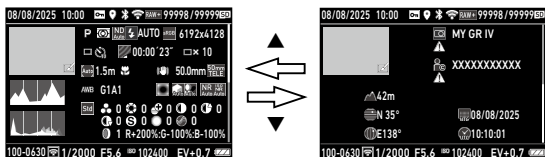

Memo

- You can specify the displayed information in [Playback Info. Display] in the **C** 3 menu. (p.141)
- For movies, [Histogram], [Grid Guide], and [Highlight Alert] are not displayed.

Using the Touch Screen

You can use the touch screen to select functions, set the AF point for shooting, and perform other operations.

When not using the touch screen function, set [LCD Touch Operation] to [Off] in the **C** 2 menu.

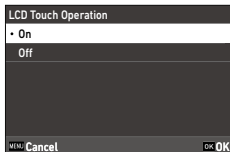

How to Change Function Settings

Using the Buttons and Dial

1

Introduction

Using the Direct Keys

You can perform the following functions quickly by pressing ▲▼◀▶ in the shooting mode.

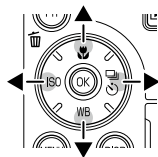

▲ (📷)	Macro Mode (p.65)
▼ (WB)	White Balance (p.75)
◀ (ISO)	ISO Setting (p.69)
▶ (📷)	Drive Mode (p.80)



Memo

- The functions mentioned above can also be set from the 📷 menu by pressing MENU.
- The function of ▼, ◀, and ▶ can be changed in [Fn Button Setting] in the C 2 menu. (p.136)

Using the Fn Button

You can activate the assigned function by pressing **Fn** in the shooting mode. By default, [AF+AE Lock] is assigned.

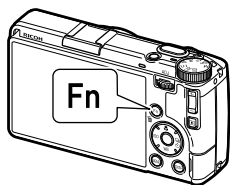

Memo

- The function of **Fn** can be changed in [Fn Button Setting] in the **C2** menu. (p.136)
- When the power is turned on or the mode dial is turned, the current function of the button is displayed for three seconds. If [Guide Display] is set to [Off] in the **2** menu, the function is not displayed.

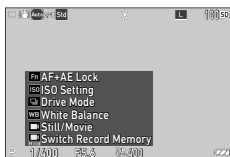

Using the ADJ. Mode

You can easily recall the assigned functions by pressing **ADJ** (☺) in the shooting mode.

1 Press **ADJ** in the shooting mode.

The camera enters the ADJ. mode and the symbol for the assigned function appears.

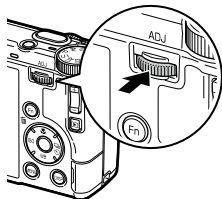

2 Use **◀▶** to select a function.

By default, the following functions can be selected.

- Image Control (p.94)
- Focus (p.60)
- AE Metering (p.67)
- File Format (p.91) ("Framerate" for the **■(mode)**)
- Aspect Ratio (p.91) ("Outdoor View Setting" for the **■(mode)**)



3 Use **▲▼** to select a setting.

To make detailed settings, press **Fn**.

4 Press **OK**.

The selected function is set and the camera is ready to perform shooting.



Memo -----

- The functions for ADJ. mode can be changed in [ADJ Mode Setting] in the **C 2** menu. (p.134)
- When [Shutter Btn. Confirmation] is set to [On] in the **C 2** menu, pressing **SHUTTER** half way completes the setting of ADJ. mode. (p.139)

Using the Menus

You can set most functions from the menus.

1 Turn the camera on.

Refer to “Turning the Camera On” (p.44) for how to turn the camera on.

2 Press **MENU**.

The 1 menu appears.

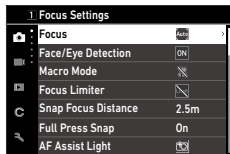

3 When changing the menu type, press **◀** twice, and then use **▲▼** to select a type.

You can use instead of **▲▼**, and instead of **◀▶** to move the cursor.

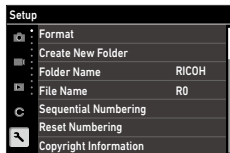

	Still Image Settings menus (p.28)
	Movie Settings menus (p.31)
	Playback Settings menus (p.32)
	Customize Settings menus (p.34)
	Setup menus (p.37)

4 Press **▶** twice.

5 Use **▲▼** to select a function.

Each menu type has a maximum of 11 categories.

Press to switch pages.

Press **◀** then **▲▼** to switch categories.

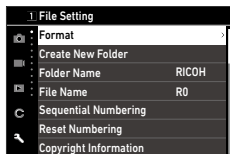

6 Find a function to set and press ►.

The settings for the selected function are displayed.

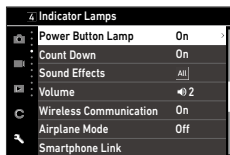

7 Use ▲▼ to select a setting, and then press **OK** or **ADJ.**

The screen in Step 5 reappears.

Press **MENU** to return to the previous screen.

When you have finished setting, press **MENU** several times to return to previous screens.

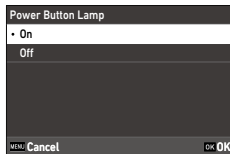

Memo

- When **MENU** is pressed, the last used menu screen appears first. To display the most appropriate menus for the camera settings at that time, set [Store Cursor Position] to [Off] in the  2 menu.

Resetting the Settings

The settings are saved even after the power is turned off. To reset the settings, perform the following operations.

1 Select [Reset] in the 11 menu, and then press ►.

2 Select [Reset Settings] or [Reset to Factory Default], and then press ►.

When [Reset Settings] is selected, proceed to the next Step.

When [Reset to Factory Default] is selected and executed, all the functions are reset to the factory settings and all images saved in the internal memory are deleted. When this is selected, proceed to Step 7.

3 Press **▶**.

The [Reset Item] screen appears.

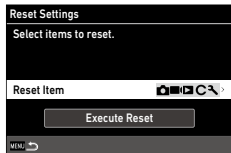
**4** Use **ADJ** to turn each menu type on or off.

The menu types turned off are not reset.

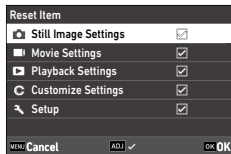
**5** Press **OK**.

The screen in Step 3 reappears.

6 Select [Execute Reset], and then press **OK**.**7** Select [Execute], and then press **OK**.

The selected menu types are reset.

**Memo** -----

- For each function, you can select whether to save the settings or reset them when the camera is turned off. Make settings in [Memory] in the **C** 2 menu. (p.140)

Menu List

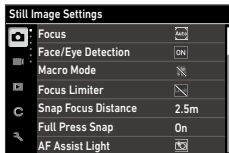

The following menus are available. (The underlined settings and the square-bracketed settings are the default settings.)

Still Image Setting Menus



1 Focus Settings

Focus	<u>Auto-area AF</u> , Zone Select AF, Select AF, Pinpoint AF, Tracking AF, Continuous AF, MF, Snap, ∞	p.60
Face/Eye Detection	<u>On</u> , Use only in Auto-area AF, Off	p.62
Macro Mode	On, <u>Off</u>	p.65
Focus Limiter	Near Side, Far Side, <u>Off</u>	p.62
Snap Focus Distance	0.3m, 1m, 1.5m, 2m, <u>2.5m</u> , 3.5m, 5m, ∞	p.60
Full Press Snap	<u>On</u> , Off	p.66
AF Assist Light	<u>On</u> , Off	p.61
Focus Peaking	On, <u>Off</u>	p.61
A.F.C Setting	<u>Focus-priority</u> , FPS-priority	p.60
MF Auto Magnification	On, <u>Off</u>	p.64

 2 Exposure Setting		
Exposure Mode	Program AE, Aperture Priority AE, Shutter Priority AE, Snap Distance Priority AE, Manual Exposure	p.133
AE Metering	Multi-segment, Center-weighted, Spot, Highlight-weighted	p.67
ISO Setting	ISO Setting: <u>AUTO</u> , 100 to 204800 ISO Auto Upper Limit: From one setting higher than the lowest ISO sensitivity to the highest ISO sensitivity [12800] ISO Auto Lower Limit: From the lowest ISO sensitivity to one setting lower than the highest ISO sensitivity [100] Minimum Shutter Speed: 1 to 1/1000 sec. [1/30]	p.69
Flash Mode	Flash Mode: <u>Flash On</u> , Flash On+Red-eye, Slow-speed Sync, Slow Sync+Red-eye Flash Output: <u>AUTO</u> , 1/1, 1/4	p.71
Program Line	<u>Normal</u> , DOF Priority (Shallow), DOF Priority (Deep)	p.55
ND Filter	<u>Auto</u> , On, Off	p.93
Auto EV Compensation	On, <u>Off</u>	p.54
Link AE and AF Point	On, <u>Off</u>	p.68
 3 Shooting Settings		
Still/Movie	<u>Still Image</u> , Movie	p.57
Drive Mode	Drive: Single Frame Shooting, Continuous Shooting, Bracketing, Multi-exposure, Interval Shooting, Interval Composite Self-timer: 10sec., 2sec., <u>Off</u>	p.80
AA Filter Simulator	High, Low, <u>Off</u>	p.93

📷 4 Image Capture Settings		
Shooting Memory Setting	Internal Memory Priority, <u>Memory Card Priority</u>	p.90
File Format	<u>JPEG</u> , RAW, RAW+JPEG	p.91
Aspect Ratio	<u>3:2</u> , 4:3, 1:1, 16:9	
Crop	<u>Off</u> , 35mm, 50mm	
JPEG Recorded Pixels	<u>L</u> , M, S, XS	
Color Space	<u>sRGB</u> , AdobeRGB	
📷 5 Image Process Settings		
White Balance	<u>Auto White Balance</u> , Auto WB (Warmth Pri.), Auto WB (White Pri.), Daylight, Shade, Cloudy, Fl. - Daylight Color, Fl. - Daylight White, Fl. - Cool White, Fl. - Warm White, Tungsten, CTE, Manual White Balance, Color Temperature, Custom 1 to 3	p.75
Image Control	<u>Standard</u> , Vivid, Monotone, Soft Monotone, Hard Monotone, Hi-Contrast B&W, Negative Film, Positive Film, Cinema (Yellow), Cinema (Green), Cross Processing, Bleach Bypass, Retro, HDR Tone, Custom 1 to 3	p.94
Peripheral Illumin. Corr.	<u>On</u> , Off	p.96
D-Range Correction	Highlight Correction: <u>Auto</u> , On, Off Shadow Correction: <u>Auto</u> , Low, Medium, High, Off	p.97
Noise Reduction	Slow Shutter Speed NR: <u>Auto</u> , On, Off High-ISO Noise Reduction: <u>Auto</u> , Low, Medium, High, Custom, Off	p.73
📷 6 Shooting Assist		
Shake Reduction	<u>On</u> , Off	p.98
Auto SR Off	<u>Enable Auto SR Off</u> , Disable Auto SR Off	p.98
Horizon Correction	On, <u>Off</u>	p.98

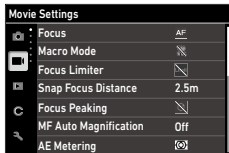

■(1 Focus Settings		
Focus	AE, MF, Snap, ∞	p.60
Macro Mode	On, <u>Off</u>	p.65
Focus Limiter	Near Side, Far Side, <u>Off</u>	p.62
Snap Focus Distance	0.3m, 1m, 1.5m, 2m, <u>2.5m</u> , 3.5m, 5m, ∞	p.60
Focus Peaking	On, <u>Off</u>	p.61
MF Auto Magnification	On, <u>Off</u>	p.64
■(2 Exposure Setting		
AE Metering	<u>Multi-segment</u> , Center-weighted, Spot, Highlight-weighted	p.67
ND Filter	On, <u>Off</u>	p.93
■(3 Shooting Settings		
Still/Movie	<u>Still Image</u> , Movie	p.57
■(4 Movie Capture Settings		
Shooting Memory Setting	Internal Memory Priority, <u>Memory Card Priority</u>	p.90
Framerate	<u>60p</u> , 30p, 24p	p.92
Sound Recording	<u>On</u> , Off	

15 Image Process Settings

White Balance	<u>Auto White Balance</u> , Auto WB (Warmth Pri.), Auto WB (White Pri.), Daylight, Shade, Cloudy, Fl. - Daylight Color, Fl. - Daylight White, Fl. - Cool White, Fl. - Warm White, Tungsten, CTE, Manual White Balance, Color Temperature, Custom 1 to 3	p.75
Image Control	<u>Standard</u> , Vivid, Monotone, Hard Monotone, Hi-Contrast B&W, Negative Film, Positive Film, Cinema (Yellow), Cinema (Green), Cross Processing, Bleach Bypass, Retro, Custom 1 to 3	p.94
Peripheral Illumin. Corr.	<u>On</u> , Off	p.96
D-Range Correction	Highlight Correction: <u>Auto</u> , Off Shadow Correction: <u>Auto</u> , Low, Medium, High, Off	p.97

16 Shooting Assist

Movie SR	<u>On</u> , Off	p.98
----------	-----------------	------

▶ Playback Settings Menus

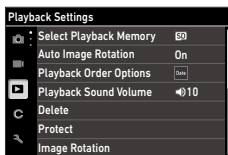

▶ 1 Playback Settings

Select Playback Memory	Internal Memory, <u>Memory Card</u>	p.51
Auto Image Rotation	<u>On</u> , Off	p.101
Playback Order Options	File No., <u>Shooting Date/Time</u>	p.101
Playback Sound Volume	0 to 20 [10]	p.59

▶ 2 File Management		
Delete	Delete 1 Image, Delete All Images	p.103
Protect	Protect 1 Image, Protect All Images	p.105
Image Rotation	90° to left, 180°, 90° to right	p.101
Image Copy	Copy 1 Image, Copy All Images	p.107
File Transfer	Transfer 1 Image	p.109
▶ 3 Image Edit		
RAW Development	JPEG Recorded Pixels, Aspect Ratio, Color Space, White Balance, Image Control, Peripheral Illumin. Corr., Sensitivity, High-ISO Noise Reduction, Shadow Correction	p.111
Resize	—	p.114
Cropping	—	p.115
Levels Adjustment	—	p.116
WB Adjustment	—	p.118
Color Moiré Correction	Low, Medium, High	p.119
Base Parameter Adj	Brightness, Saturation, Filter Effect, Hue, Toning, Contrast, Sharpness	p.120
Movie Edit	Cut, Divide	p.121

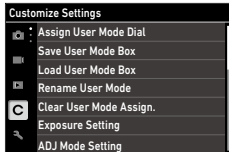

C 1 User Mode		
Assign User Mode Dial	—	p.129
Save User Mode Box	—	p.131
Load User Mode Box	—	p.132
Rename User Mode	—	p.130
Clear User Mode Assign.	—	p.130
C 2 Customize Controls		
Exposure Setting	P, Av, Tv, Sn, M	p.134
ADJ Mode Setting	Off, <u>F</u> ocus [Setting2], Focus Limiter, Snap Focus Distance, <u>F</u> ile <u>F</u> ormat [Setting4], <u>A</u> spect <u>R</u> atio [Setting5], Crop, JPEG Recorded Pixels, <u>A</u> E <u>M</u> etering [Setting3], ISO Setting, Flash Mode, Flash Output, Drive, Self-timer, White Balance, <u>I</u> mage <u>C</u> ontrol [Setting1], One Push AE in M Mode, Touch AF, Outdoor View Setting, Framerate	p.134



Fn Button Setting	Off, Focus, Set MF, Set Snap, Set Tracking AF, Enable AF, <u>AF+AE Lock</u> [Fn Button], AE Lock, Face/Eye Detection, Focus Limiter, Snap Focus Distance, <u>Switch Record Memory</u> [Hold Movie Button], File Format, JPEG → RAW, JPEG → RAW+, Aspect Ratio, Crop, JPEG Recorded Pixels, Framerate, <u>Still/Movie</u> [Movie Button], AE Metering, <u>ISO Setting</u> [ISO Button], Flash Mode, Flash Output, ND Filter, <u>Drive Mode</u> [Drive Button], Drive, Continuous Shooting, Self-timer, <u>White Balance</u> [White Balance Button], Image Control, Shake Reduction, One Push AE in M Mode, 4-way Controller Action, Touch AF, Outdoor View Setting, Enable Sleep Mode, Airplane Mode, Preview Focus Settings: <u>Same as Shutter Button</u> , Auto-area AF, Zone Select AF, Select AF, Pinpoint AF, Tracking AF, Continuous AF Keep AE Lock: On, <u>Off</u> One Push AE in M Mode: Program AE, <u>Aperture Priority AE</u> , Shutter Priority AE	p.136
Shutter Button Setting	<u>AF+AE Lock</u> , AE Lock, Enable AF	p.139
4-way Controller	<u>Direct Key Priority</u> , AF point change Priority	p.63
Shutter Btn. Confirmation	On, <u>Off</u>	p.139
LCD Touch Operation	<u>On</u> , Off	p.21
Touch AF	<u>AF Point</u> , AF Point+Focus, AF Point+Focus+Shoot, Full Press Snap, Off	p.55
Memory	ISO Setting, EV Compensation, Program Auto Ex, Focus, Macro Mode, Focus Limiter, Focus Peaking, AE Metering, Flash Mode, Flash Output, Still/Movie, Drive, Self-timer, AA Filter Simulator, Aspect Ratio, Crop, White Balance, Image Control, ADJ Mode Setting, Shooting Info. Display, Playback Info. Display, Image for Playback, Outdoor View Setting	p.140

C 3 Display Customization		
Shooting Info. Display	Standard Info. Display, Simplified Info. Display, No Information Display, Display Off	p.141
Playback Info. Display	Standard Info. Display, No Information Display	
Instant Review	Display Time: <u>0.5sec.</u> , 1sec., 2sec., 3sec., Hold, Off Zoom Review: On, <u>Off</u> Delete: On, <u>Off</u>	p.142
Quick Zoom	x4, x8, x16, <u>100%</u>	
Focus Magnification	<u>On</u> , Off	p.51
Grid Style	<u>3x3 Grid</u> , 4x4 Grid	p.143
Electronic Level Type	<u>Level+Tilt</u> , Level	
Electronic Level Design	<u>Type1</u> , Type2, Type3	
Flicker Reduction	<u>50Hz</u> , 60Hz	



1 File Setting		
Format	Memory Card, Internal Memory	p.46
Create New Folder	—	p.148
Folder Name	Folder Name: <u>Date</u> , <u>Optional</u> A freely defined string of characters [RICOH]	p.149
File Name	Still Image: A freely defined string of two characters [R0] Movie: A freely defined string of two characters [R0]	p.151
Sequential Numbering	<u>Folder & File</u> , File, Off	p.152
Reset Numbering	—	p.152
Copyright Information	Embed Copyright Data: <u>On</u> , <u>Off</u> Copyright Holder: A freely defined string of 32 characters	p.153
2 Display Settings		
Store Cursor Position	<u>On</u> , Off	p.26
Guide Display	<u>On</u> , Off	p.23
Animation Setting	<u>On</u> , Off	p.51
End Screen	Type1, <u>Type2</u>	p.44
3 LCD Setting		
LCD Setting	Brightness: -7 to +7 Saturation: -7 to +7 Adjust: Blue-Amber: -7 to +7 Adjust: Green-Magenta: -7 to +7	p.143
Outdoor View Setting	<u>Auto</u> , +2, +1, OFF, -1, -2	p.144

4 Indicator Lamps		
Power Button Lamp	<u>On</u> , Off	p.144
Count Down	<u>On</u> , Off	
5 Sound Effects Setting		
Sound Effects	<u>All</u> , Shutter Sound Only	p.145
Volume	0 to 3 [2]	
6 Wireless Connection		
Wireless Communication	Action Mode: <u>On</u> , <u>Off</u> Pairing: Execute Pairing, Paired Devices Communication Info.	p.125
Airplane Mode	<u>On</u> , <u>Off</u>	p.127
Smartphone Link	Store Location Info.: <u>On</u> , <u>Off</u> Auto Image Transfer: Auto Image Transfer, Transfer File Format Auto Resize: <u>On</u> , <u>Off</u> Image Transfer while Off: <u>On</u> , <u>Off</u>	p.128
USB Setting	<u>Image Display</u> , License Display	p.124
7 Power Supply Settings		
Auto Power Off	<u>1min.</u> , 3min., 5min., 10min., 30min., Off	p.146
Sleep Mode	3sec., 10sec., <u>30sec.</u> , 1min., 3min., 5min., 10min., 30min., Off	p.147
LCD Auto Dim	<u>On</u> , Off	
8 About This Device		
Camera Information	—	—
Certification Marks	—	p.3
9 Sensor Maintenance		
Pixel Mapping	—	p.160
Dust Removal	Execute Dust Removal Startup Action: <u>On</u> , Off Shutdown Action: <u>On</u> , Off	p.160

 10 Language/Date Setting		
Language/言語	English, French, German, Spanish, Portuguese, Italian, Dutch, Danish, Swedish, Finnish, Polish, Czech, Hungarian, Turkish, Greek, Russian, Thai, Korean, Traditional Chinese, Simplified Chinese, Japanese	p.45
Date Adjustment	Date Format: Y/M/D, D/M/Y, <u>M/D/Y</u> Date: <u>January 1, 2025</u> to December 31, 2074 Time: <u>00:00</u> to 23:59	p.46
 11 Reset		
Reset	Reset Settings: Reset Item, Execute Reset Reset to Factory Default	p.26

Setting the Battery and a Memory Card

Inserting the Battery and a Memory Card

2
Getting Started

The camera can save images to its internal memory. When using a memory card, commercially available microSD memory cards, microSDHC memory cards, and microSDXC memory cards can be used. "Memory card" refers to these memory cards in this manual.

1 Make sure that the camera power is off.

2 Slide the release lever on the bottom of the camera toward OPEN to open the battery/card cover.

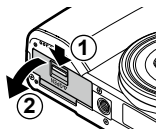

3 When using a memory card, make sure that the memory card is facing the right way and then push it all the way in until it clicks.

To remove the memory card, push it in and then release your hand.

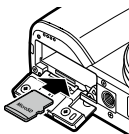

4 Insert the battery.

Use the battery to press the latch and insert the battery all the way into the battery compartment.

To remove the battery, slide the latch.

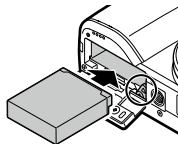

- 5** Close the battery/card cover and slide the release lever in the opposite direction of OPEN to lock it in place.

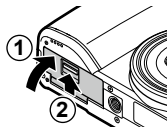

Data Save Location

Data is saved according to the setting of [Shooting Memory Setting] in the 4/ 14 menu.

Press and hold ($\frac{M}{SD}$) before shooting to switch the save destination.

The save destination can be checked in the upper right corner of the monitor.



Caution -----

- Avoid touching the microSD card terminal directly with your hands or fingers.

Memo -----

- When a memory card is inserted, the data save method can be set. (p.90)
- Saved images can be copied between the internal memory and the memory card. (p.107)
- The storage capacity varies depending on the memory card. (p.173)

Charging the Battery

Charge the provided rechargeable battery (DB-120) before using the camera.

Charge the battery using one of the following methods.

Using the Battery Charger

You can charge the battery using the optional battery charger (BJ-12). For how to charge the battery, refer to the user's manual of the battery charger.

Using an AC Adapter

You can charge the battery using a commercially available AC adapter compatible with USB Power Delivery in combination with the provided USB cable (I-USB198) or the optional AC adapter (K-AC166).



Memo

- When a commercially available AC adapter compatible with USB Power Delivery or the optional AC adapter (K-AC166) is connected and the camera is turned on, you can perform shooting and play back images using power supplied via the AC adapter.
- The camera is compatible with USB Power Delivery, but is not certified with the USB Implementers Forum logo.

Using a Computer

You can charge the battery using the provided USB cable (I-USB198) and a computer with a USB Type-C port.

- 1 Turn the camera off.
- 2 Open the terminal cover, and then connect the USB cable to the USB terminal.
- 3 Connect the USB cable to the USB Type-C port of the computer.
The camera turns on and enters the playback mode.

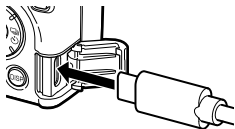

4 Press the power button to turn the camera off.

The status lamp of the camera turns on and charging starts. When charging is complete, the status lamp turns off.

5 Remove the USB cable from the USB terminal, and close the terminal cover.



Caution

- Use only genuine rechargeable battery (DB-120).
- If the battery starts to run down more quickly even after being charged, the battery has reached the end of its service life. In this case, replace the battery with a new one.
- The battery may become very hot immediately after operation. Turn the camera off and leave it to cool down sufficiently before removing the battery.
- If the camera is turned on while charging, the charging stops.
- When a computer that does not support USB Power Delivery is used, charging may take a long time.



Storage Capacity

- Approx. 250 images can be taken when the battery is fully charged.
- This is based on tests conducted according to CIPA standards under the following conditions: At 23°C (73°F) temperature; the monitor is on; an image is taken every 30 seconds; the camera is turned off and back on after 10 images are taken.
- The storage capacity is for reference. For long periods of use, it is recommended that you carry spare batteries.

Initial Settings

Turn the camera on and make the initial settings.

Turning the Camera On

2

Getting Started

1 Press the power button.

The power button lamp turns on, and then the status lamp blinks for several seconds.

The first time the camera is turned on after purchase, the [Language/言語] screen appears.

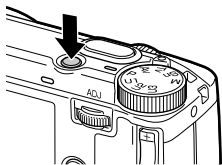

When the power button is pressed again, the power turns off.



Turning the Camera On in the Playback Mode-----



- When  is pressed and held with the camera turned off, the camera turns on in the playback mode.

The following operations are available.

	Turns the camera off
 (halfway)	Switches the camera to the shooting mode.



Memo-----

- The power button lamp can be set to [Off] in [Power Button Lamp] in the  4 menu. (p.144)
- If no operations are made for about one minute (default setting), the camera turns off automatically to suppress battery drain. The power saving function can be set in the  7 menu. (p.146)
- The number of images taken on the day (except the deleted images), the total number of images taken since you started using the camera, and the firmware version of the camera are displayed when the power is turned off. To display only the number of images taken on the day, set [End Screen] to [Type1] in the  2 menu.

Setting the Language, Smartphone Linkage, and Date/Time

You can set the display language for menus and the date and time, and pair the camera with a communication device via Bluetooth®.

1 Use ▲▼ to select a language, and then press **OK**.

The selected language is set and the [Smartphone Linkage] screen appears.

If you do not want to link the camera with a communication device or want to link it later, press **MENU** to proceed to Step 7.

2 Press **OK**.

[Wireless Communication] turns [On] in the  6 menu and the app installation guide screen appears.



3 Read the displayed two-dimensional code with a communication device such as a smartphone and install the RICOH GR series dedicated app "GR WORLD" to the communication device.

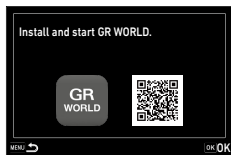

4 Press **OK** of the camera.

5 Use the app to register the camera.

The camera and the communication device are paired.

6 Press **OK** of the camera.

The [Date Adjustment] screen appears.

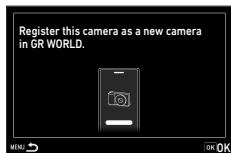

7 Set the display format and the date and time.

Use ◀▶ to select an item and ▲▼ to change the value.

Press **MENU** to cancel the setting.

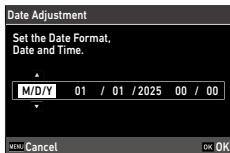

8 Press **OK**.

The date and time are set and the camera is ready to perform shooting.



Memo -----

- If the battery is removed for about five days, the date and time settings will be lost. To retain the date and time settings, insert a battery with sufficient power for at least two hours, and then remove the battery.
- You can change the language and the date and time settings in the **⌘** 10 menu.
- For how to link the camera with a communication device later or for details on the app functions, refer to “Using the Camera with a Communication Device” (p.124).

Formatting a Memory Card

When using a new memory card or a memory card used with another device, format the memory card with this camera. The internal memory can also be formatted.

1 Press **MENU**.

The menu appears.

2 Press ◀ twice, and then use ▲▼ to select **⌘**.



- 3** Press **▶** twice, select [Format], and then press **▶**.

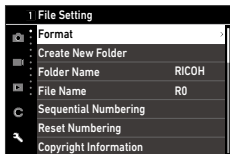

- 4** Use **▲▼** to select [Memory Card] or [Internal Memory], and then press **▶**. The confirmation screen appears.

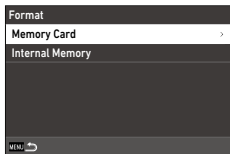

- 5** Use **▲** to select [Execute], and then press **OK**. The memory is formatted and the screen in Step 4 reappears.

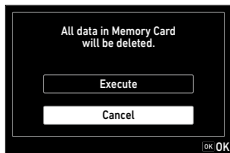

- 6** Press **MENU** twice. The shooting screen reappears.



Caution -----

- Do not remove the memory card while formatting, or the card may be damaged.
- Formatting deletes all data, both protected and unprotected.



Memo -----

- When a memory card is formatted, the volume label "RICOH GR" is assigned to the card.

Basic Shooting Operation

Shooting in the Program Mode

You can perform shooting in the Program AE mode that automatically sets an aperture value and shutter speed.

2 Getting Started

- 1** Set the mode dial to **P** while pressing the lock button.

The exposure mode is set to [Program AE] and the Live View is displayed.

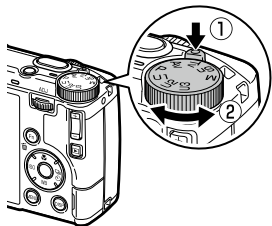

- 2** Press **SHUTTER** halfway.

Focus is adjusted, and exposure is set.

The distance is measured from up to 25 points and the green focus frame appears for the area in focus.

- 3** Press **SHUTTER** fully.

The image you have just captured is displayed on the monitor (Instant Review) and saved.



**Focus**

- The status lamp and the color of the center frame on the monitor show whether the subject is in focus.

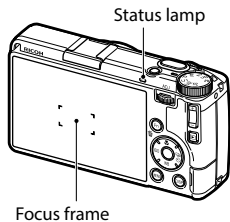

Focus Status	Frame Color	Status Lamp
Before focusing	White	Off
Subject in focus	Green	Green (on)
Unable to focus	Red	Green (blinks)

**Live View Magnification**

- The Live View image can be magnified. The following operations are available.

DISP (pressed and held)	Magnifies the Live View image.
	Switches the magnification between [x4] and [x16].
/ Slide	Moves the magnified area.
OK	Resets to the entire image display.

- The image cannot be magnified during recording in the mode.

**Memo**

- You can set the display and operation of [Instant Review] that displays the taken image immediately after shooting in the **C** 3 menu. (p.142)

Viewing the Taken Images

You can view taken images on the monitor one by one.

1 Press .



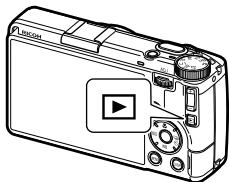







The camera switches to the playback mode and the last image you took is displayed.
(Single image display)





2 View an image.



The following operations are available.

 /  / Flick	Displays the previous or next image.
	Deletes the image. (p.103)
 (to the right) /  (+) / Pinch out	Magnifies the image.
 (-) / Pinch in	Displays the multi-image display screen. (p.100) In magnified view: Reduces the image.
	In magnified view: Changes the display magnification.
 / Slide	In magnified view: Moves the magnified area.
 (+) / ADJ / Double-tap	Magnifies the image with the magnification ([x4], [x8], [x16], [100%]) set in [Quick Zoom] in the C 3 menu. (p.142) In magnified view: Returns to the single image display.
	In magnified view: Displays the previous or next image without changing the magnification.
OK	In magnified view: Returns to the single image display.
DISP	Switches between [Standard Info. Display], [Detailed Info. Display], and [No Information Display]. In magnified view: Switches between [Standard Info. Display] and [No Information Display].

 / Tap and hold	Displays the playback function selection screen (p.99).
 ($\frac{IN}{SD}$) (pressed and held)	Switches the memory to play back images.
	Switches the camera to the shooting mode.



Memo -----

- If [Focus Magnification] is set to [On] (default setting) in the **C** 3 menu, the image is magnified centering on the AF point set in shooting.
- Movies cannot be magnified.
- If the image is switched to the previous or next image by flicking the touch screen, animation is displayed. The animation can be set to [Off] in [Animation Setting] in the **2** menu.

Taking Still Pictures



Setting the Exposure Mode

You can set an aperture value or shutter speed for shooting.

- 3 **1** Set the mode dial to **P**, **Av**, **Tv**, **Sn**, or **M**.



The exposure mode and set values are displayed on the shooting screen.

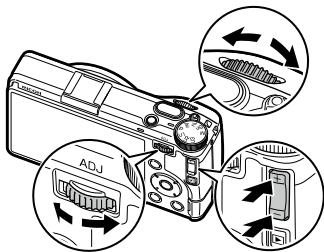

- 2** Use , , or  to change values.



The following values can be changed.

Exposure Mode			
P Program AE	Aperture value	Shutter speed	Exposure compensation
Av Aperture Priority AE	Aperture value	—	Exposure compensation
Tv Shutter Priority AE	—	Shutter speed	Exposure compensation
Sn Snap Distance Priority AE	Snap focus distance	Depth of field	Exposure compensation
M Manual Exposure	Aperture value	Shutter speed	When ISO AUTO is set for the ISO sensitivity: Exposure compensation When the ISO sensitivity value is fixed: ISO sensitivity

The exposure compensation can be set in the range of ± 5.0 EV (± 2.0 EV in the  mode) in increments of 1/3 EV steps.

In the **Sn** mode, the snap focus distance and depth of field can be adjusted. The focus mode is fixed to [Snap] (p.60) and the depth of field can be selected from three levels.

In the **M** mode, the exposure indicator is displayed. The exposure is correct when the pointer of the exposure indicator is in the center. When the exposure value is in the range of ± 2 EV, the indicator changes according to the exposure value. The indicator color turns yellow when the exposure value is outside this range.



3 Shoot.

**Memo** -----

- When you change the aperture value or shutter speed in the **P** mode, the exposure mode temporarily switches to the **Av/Tv** mode (Program Auto Ex). To return each value to its standard setting, press the lock button. When switching the exposure modes or switching to the **M** mode, each value also returns to its standard setting.
- If [Auto EV Compensation] is set to [On] in the 2 menu, the exposure is automatically compensated when the correct exposure cannot be achieved in the **Av** or **Tv** mode.
- Pressing halfway activates the autofocus and locks the exposure value. To only lock the exposure value, set [Shutter Button Setting] to [AE Lock] in the 2 menu. (p.139)
- The functions of , , and when these are operated in each exposure mode can be changed. (p.134)

**Caution** -----

- The image is not displayed on the monitor during shooting.
- The exposure compensation is not available when the ISO sensitivity is set to a fixed value in the **M** mode.

**AE Lock** -----

- The exposure value is locked while is pressed halfway, and the lock is canceled when the button is released.
- The exposure value can also be locked with by setting [Fn Button Setting] to [AF+AE Lock] or [AE Lock] in the 2 menu. By default, [AF+AE Lock] is assigned to . (p.136)

AF+AE Lock	Locks the focus and exposure value simultaneously. The lock of the exposure value is canceled when the button is released.
AE Lock	Locks the exposure value only. When [Keep AE Lock] is set to [On] in [Fn Button Setting] in the 2 menu, the lock of the exposure value is kept even if the button is released.

- The lock of the exposure value is not available if the ISO sensitivity is set to a fixed value in the **M** mode, or if the shutter speed is set to B, T, or BT.



AF Using the Touch Screen

- By default, only the AF point can be changed using the touch screen. To perform autofocus and shooting using the touch screen, set [Touch AF] in the **C2** menu.

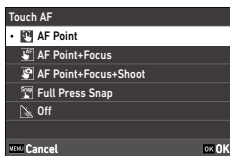

AF Point	Sets the AF point to the touched point.
AF Point+Focus	Sets the AF point to the touched point and performs autofocus.
AF Point+Focus+Shoot	Sets the AF point to the touched point, and performs autofocus and shooting.
Full Press Snap	Performs "Full Press Snap" shooting.
Off	Does not perform autofocus using the touch screen.

When autofocus using the touch screen is enabled in the **■** mode, [AF Point+Focus] is applied.



Program Line

- You can set the program line for the **P** mode to [DOF Priority (Shallow)] or [DOF Priority (Deep)] in [Program Line] in the **2** menu.



Checking the Depth of Field

- When [Hold Movie Button] of [Fn Button Setting] is set to [Preview] in the **C2** menu, the preview function is available. (p.136) When you press and hold **□**, the aperture is adjusted to the set aperture value, and you can check the depth of field. It is canceled when **□** is released.
- During the preview, shooting cannot be performed and the aperture value cannot be changed.
- When using the flash, the actual aperture value may differ from the preview.
- The preview function is for checking the depth of field, so the exposure may not be appropriate.
- The preview function is not available in the **■** mode.

**Long Exposure**-----

- When the ISO sensitivity is set to a fixed value in the **M** mode, the shutter speed can be set to B, T, or BT.



Shutter Speed	Operation
B Bulb	The exposure continues while SHUTTER is pressed, and is canceled when the button is released.
T Time	The exposure starts when SHUTTER is pressed, and ends when the button is pressed again.
BT Bulb timer	The exposure start when SHUTTER is pressed, and ends after the set time has elapsed. Use 4 to set the exposure time.

- B and T are available when [Drive Mode] is set to [Single Frame Shooting] or [Multi-exposure], and BT is available when [Drive Mode] is set to [Single Frame Shooting], [Multi-exposure], [Interval Shooting], or [Interval Composite].

**Compensation to Correct Exposure in the M mode**-----

- When [One Push AE in M Mode] is registered in [Fn Button Setting] in the **C** 2 menu (p.136), pressing the button compensates the exposure to the correct exposure. You can select the value to be prioritized for this compensation.



Program AE	Adjusts both the aperture value and shutter speed.
Aperture Priority AE	Sets the aperture value to a fixed value and adjusts the shutter speed.
Shutter Priority AE	Sets the shutter speed to a fixed value and adjusts the aperture value.

When the ISO sensitivity is set to ISO AUTO or the shutter speed is set to B, T, or BT, [M Mode Instant Push AE] does not operate.

Recording Movies

1 Press .

The camera enters the  mode.

You can also switch the modes from [Still/Movie] in the 3/3 menu.



2 Focus on the subject.

When [Focus] is set to [AF] in the 1 menu, press **SHUTTER** halfway.

3 Press **SHUTTER** fully.

Recording starts.

The recording time is displayed while recording.





4 Press **SHUTTER** again.

Recording stops.



Caution

- When [Sound Recording] is set to [On] (default setting) in the 4 menu, camera operation sounds are also recorded.
- If the internal temperature of the camera becomes high during recording, recording may be terminated.
- The following functions are not available in the  mode.
 - Flash
 - Wireless LAN



Memo

- Movies are recorded in the **P** mode regardless of the mode dial setting. The exposure compensation is possible.
- When [Touch AF] is enabled in the **C 2** menu, autofocus can be performed with the touch screen even during recording. (p.55)
- In the **1/** mode, pressing **SHUTTER** halfway does not lock the exposure value. The exposure value is locked while **Fn** is pressed (default setting).
- You can record a movie continuously up to 4 GB or 25 minutes. Recording stops when the memory card or internal memory becomes full. The maximum recording time per shooting depends on the capacity of the memory card. (p.175) Shooting may stop even before the maximum recording time is reached.
- The remaining recording time is calculated based on the remaining memory capacity, so the change in time may not be constant.
- Use a memory card of Speed Class 6 or higher for recording movies.
- Use a fully charged battery, commercially available AC adapter compatible with USB Power Delivery, or optional AC adapter (K-AC166).
- When the setting of [Movie Button] has been changed in [Fn Button Setting] (p.136) in the **C 2** menu, switch the camera to the **1/** mode from the **3/** menu.

Playing Back Movies

1 Press .

The image is displayed in the single image display in the playback mode.







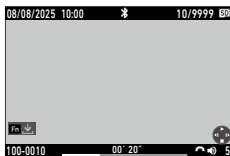

2 Use to select a movie to play back.

The first frame of the movie is displayed as a still image.

3 Play back the movie.





The following operations are available.

 / Tap	Plays back/Pauses the movie.
 / Double-tap	Stops playback.
 / 	Adjusts the sound volume (0 to 20).
 / 	During playback: Fast-reverses/Fast-forwards playback. While playback is paused: Reverses/Forwards a frame.
	While playback is paused: Saves the displayed frame as a still image (JPEG file).
	Switches between [Standard Info. Display] and [No Information Display].

















Memo

- The sound volume at the start of movie playback can be set in [Playback Sound Volume] in the  1 menu.
- With [Movie Edit] in the  3 menu, a movie file can be divided or cut out. (p.121)

Setting the Focus

Setting the Focus Mode

 Auto-area AF	Measures the distances from the 5 × 5 AF areas and focuses to the appropriate AF area. (Default setting)
 Zone Select AF	Focuses to the appropriate AF area in the 3 × 3 AF areas moved as desired. (p.63)
 Select AF	Focuses to the selected AF area. (p.63)
 Pinpoint AF	Focuses to the selected AF area that is smaller than [Select AF]. (p.63)
 Tracking AF	Tracks the subject and continually focuses. (p.63) When SHUTTER is pressed halfway, the subject inside the frame in the center of the monitor is set as the tracking target, and a green target symbol appears. When a tracking target cannot be found, the frame color turns red.
 Continuous AF	Keeps focusing while SHUTTER is pressed halfway. (p.63) [Focus-priority] or [FPS-priority] can be set in [AFC Setting] in the  1 menu.
 MF	Focuses manually. (p.64)
 Snap	Fixes the focus to the set distance. Set a distance in [Snap Focus Distance] in the  1 menu. Turn  while pressing  to change the distance.
 	Fixes the focus distance at infinity. This is useful for shooting distant scenes.

1 Select [Focus] in the 1/1 menu, and then press .

2 Use to select a setting.

In the mode, select a setting from [AF], [MF], [Snap], and [].

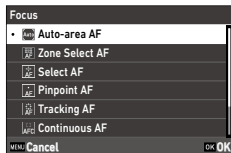

3 Press .

4 Press .

The focus mode icon appears on the shooting screen.



Memo

- This function can be registered to [ADJ Mode Setting] and [Fn Button Setting] in the 2 menu. (p.134, p.136)
When [Set MF], [Set Snap], or [Set Tracking AF] is set to [Fn Button Setting], the focus modes can be switched with button operation only.
- When [Auto-area AF], [Zone Select AF], [Select AF], or [Pinpoint AF] is set, the AF assist light on the front of the camera lights as necessary. The AF assist light can be set to [Off] in [AF Assist Light] in the 1 menu.
- When [Focus Peaking] is set to [On] in the 1/1 menu, the outline of the subject in focus is emphasized, and this makes it easier to check the focus.
- By default, the autofocus also works with . The focus operation of can be set in [Focus Settings] of [Fn Button Setting] in the 2 menu. (p.136)

**Caution**-----

- When [Shutter Button Setting] is set to [AE Lock] in the **C** 2 menu, the autofocus does not work even when **SHUTTER** is pressed halfway. (p.139)

**Detection of People**-----

- When [Auto-area AF], [Zone Select AF], [Select AF], or [Pinpoint AF] is set, faces and eyes of people are automatically detected for autofocus. The setting can be changed to [Use only in Auto-area AF] or [Off] in [Face/Eye Detection] in the **1** menu.
- If there are multiple people in the subject, tap the face of the person you want to focus on to move the AF point (when [Touch AF] is enabled in the **C** 2 menu).
- When [Auto-area AF] is set, press **OK** during autofocusing to enter the face selection mode, and then **▲▼◀▶** to select the face of the person to be focused on.

**Limiting the Focus Distance**-----

- Limiting the focus distance in [Focus Limiter] in the **1** menu allows for smooth focusing. [Near Side] or [Far Side] can be set.
- [Focus Limiter] is disabled in the following case.
 - In the **Sn** mode
 - In the macro mode
 - When [Focus] is set to [MF], [Snap], or [∞]
 - During “Full Press Snap” shooting

Selecting the Desired AF Point

1 Set [Zone Select AF], [Select AF], [Pinpoint AF], [Tracking AF], or [Continuous AF] in [Focus] in the 1 menu.

2 Press **OK** on the shooting screen.

The AF point can be changed.

3 Use **▲▼◀▶** to set an AF point.

Press and hold **OK** to reset the AF point to the center.

You can also tap on the monitor to move the AF point.

When multiple faces are detected by [Face/Eye Detection], the face from which to measure the distance can be selected.



4 Press **OK**.

The AF point is set.



Memo

- When [4-way Controller] is set to [AF point change Priority] in the **C** 2 menu, the AF point can be moved using **▲▼◀▶** without pressing **OK** in Step 2. In this case, the button functions are as follows.

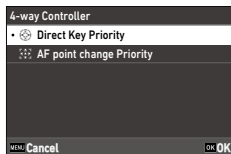

OK	Resets the AF point to the center.
OK (pressed and held)	Switches between the AF point setting by ▲▼◀▶ and the direct key functions ().

Focusing Manually (Manual Focus)

If the camera fails to focus automatically, you can focus manually. The manual focus enables shooting at a fixed distance.

1 Set [MF] in [Focus] in the 1/ 1 menu.

The focus bar appears on the shooting screen.

2 Press .

appears on the focus bar.



3 Adjust the focus distance.

The following operations are available.

	Adjusts the focus distance.
(pressed and held)	Magnifies the Live View image. (p.49)



Memo

- When [MF Auto Magnification] is set to [On] in the 1/ 1 menu, the image on the shooting screen is automatically magnified to make it easier to focus.

Shooting Close-ups (Macro)

The camera focuses to the range of 6 to 15 cm from the front edge of the lens.

1 Press ▲ (📷) in the shooting mode.

The camera enters the macro mode and the macro symbol appears on the shooting screen.



2 Shoot.

To cancel the macro mode, press ▲ again.



Memo -----

- The macro mode can be set to [On] or [Off] in [Macro Mode] in the 📷/📷1 menu.
- When [Focus] is set to [Snap] or [∞], [Select AF] is applied.



Caution -----

- When [Focus] is set to [MF], ▲ is used for focus distance adjustment. (p.64) To enter the macro mode, set [Macro Mode] in the 📷1/📷1 menu.

Shooting with a Single Press of the Shutter Release Button (Full Press Snap)

While pressing **SHUTTER** halfway operates autofocus, pressing **SHUTTER** fully quickly performs shooting at the set focal distance. This function is called “Full Press Snap”. The camera focuses at the distance set in [Snap Focus Distance] in the 1/ 1 menu.

Set the “Full Press Snap” in [Full Press Snap] in the 1 menu.

When [Full Press Snap] is set to [On], the symbol and shooting distance are displayed on the shooting screen.



On	Performs shooting by focusing at the distance set in [Snap Focus Distance] when the shutter release button is fully pressed.
Off	Performs autofocus and then shooting.



Caution

- “Full Press Snap” is not available in the following cases.
 - In the **Sn** mode
 - In the mode
 - In the macro mode
 - When [Focus] is set to [MF], [Snap], or [∞]
 - When [Drive Mode] is set to [Self-timer]



Memo

- Even when [Full Press Snap] is set to [On], the camera focuses at the setting in [Focus] when **SHUTTER** is pressed halfway.

Setting the Exposure

Selecting the Metering Method

Set the metering method in [AE Metering] in the 2/2 menu.



Multi-segment	Divides the shooting range and meters exposure based on comprehensive judgment. When a face or eyes are detected with [Face/Eye Detection], the exposure is adjusted to match the face.
Center-weighted	Meters exposure with emphasis on the center.
Spot	Meters exposure within a narrow range. Use this option when metering exposure in a part of an image or when the metering target subject is small.
Highlight-weighted	Divides the shooting range and meters exposure with emphasis on the bright areas.



Memo

- This function can be registered to [ADJ Mode Setting] in the **C** 2 menu. (p.134)
- When [Link AE and AF Point] is set to [On] in the **C** 2 menu, the metering point and the AF point are linked in the following combinations of the [AE Metering] and [Focus] settings.

AE Metering	Focus
Multi-segment	[Select AF], [Pinpoint AF], [Tracking AF], or [Continuous AF]
Spot	[Select AF], [Pinpoint AF], or [Continuous AF] When a face or eyes are detected with [Face/Eye Detection], the exposure is adjusted to match the face.

Setting the ISO Sensitivity

1 Press **◀** (**ISO**).

2 Use **↻**/**+** to change the value.

Values from ISO 100 to ISO 204800 can be set.

Press **Fn** to reset the ISO sensitivity setting to ISO AUTO. Press **Fn** again to restore the fixed value set last.



Memo

- This function can be registered to [ADJ Mode Setting] in the **C** 2 menu. (p.134)
- Images taken with a higher ISO sensitivity may appear grainy.
- Depending on the ISO sensitivity setting, the setting of [D-Range Correction] in the **5** menu is disabled. (p.97)
- ISO sensitivity can also be set in [ISO Setting] in the **2** menu. In this case, the detailed settings of ISO AUTO can be made.

ISO Setting	
ISO Setting	AUTO
ISO Auto Upper Limit	12800 >
ISO Auto Lower Limit	100
Minimum Shutter Speed	1/30

ISO Auto Upper Limit	Sets the highest ISO sensitivity for ISO AUTO.
ISO Auto Lower Limit	Sets the lowest ISO sensitivity for ISO AUTO.
Minimum Shutter Speed	Sets the shutter speed to increase the sensitivity for ISO AUTO.

- When the setting of [ISO Button] has been changed in [Fn Button Setting] in the **C** 2 menu (p.136), set the ISO sensitivity from the **2** menu.

Using the Flash

When the optional flash is connected to the camera, you can discharge a flash for shooting.

The following flash can be used.

- GF-2

Connecting the Flash

3

Taking Images

- 1 Remove the hot shoe cover from the camera.

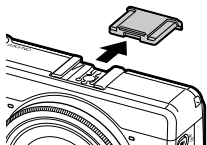

- 2 Turn off the camera and the external flash, and then attach the flash to the camera hot shoe.

- 3 Turn on the camera, and then turn on the external flash.



Caution -----

- Turn the external flash off before removing it from the camera.
- When the camera does not recognize the external flash, turn off the camera and external flash, and then remove and reattach the flash.







Using Other External Flashes -----

- Use only flashes with one signal terminal, which must be an X-contact with a positive voltage of no more than 20 V.
- [Flash Mode] cannot be set. The flash always operates with [Flash On].
- A flash signal is output to the X-contact of the hot shoe regardless of the flash setting.
- Use an external flash with a lighting angle that covers the angle of view of the shooting lens.

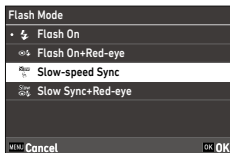
Setting the Flash Mode

- 1 Select [Flash Mode] in the 2 menu, and then press **▶**.
- 2 Select [Flash Mode], and then press **▶**.
- 3 Use **▲▼** to select a flash mode.



 Flash On	Always fires the flash. (Default setting)
 Flash On+ Red-eye	Forces the flash to fire while reducing the red-eye phenomenon.
 Slow-speed Sync	Fires the flash with the shutter speed slowed. This is suitable for taking nightscape images that include people. Use of a tripod is recommended to prevent blur.
 Slow Sync+ Red-eye	Fires the flash with the shutter speed slowed while reducing the red-eye phenomenon.

- 4 Press **OK**.
- 5 To compensate the flash output, select [Flash Output], and then press **▶**.

6 Select the flash output, and then press **OK**.

Select [1/1] for full output, and [1/4] for 1/4 of the full output.

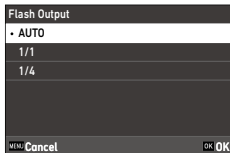

7 Press **MENU** twice.



Caution

- In the **Tv** and **M** modes, [Slow-speed Sync] and [Slow Sync+Red-eye] cannot be selected.

Reducing Noise

Slow Shutter Speed Noise Reduction

Using a long shutter speed results in a noisy image. When [Slow Shutter Speed NR] is set in [Noise Reduction] in the 5 menu, noise reduction processing is carried out.

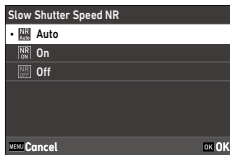

Auto	Applies the noise reduction according to the shutter speed, ISO sensitivity, and internal temperature of the camera.
On	Applies the noise reduction when the shutter speed is slower than 1 second.
Off	Does not apply the noise reduction.

The status lamp blinks during the [Slow Shutter Speed NR] processing.

High-ISO Noise Reduction

You can reduce the amount of noise when images are taken with a higher ISO sensitivity.

- 1 Select [High-ISO Noise Reduction] in [Noise Reduction] in the 5 menu, and then press **▶**.

The [High-ISO Noise Reduction] screen appears.

- 2 Use **▲▼** to select a setting, and then press **OK**.

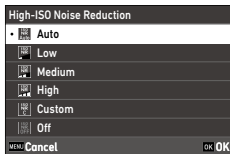

Auto	Automatically reduces noises according to the ISO sensitivity.
Low, Medium, High	Applies the noise reduction at a low, medium, or high level.
Custom	Sets the noise reduction level for each ISO sensitivity.
Off	Does not apply the noise reduction.

The [Noise Reduction] screen reappears.

When [Custom] is selected, proceed to the next step.

When other settings are selected, proceed to Step 6.

3 Select [Custom Options], and then press ►.

The ISO sensitivity setting screen appears.

4 Use ▲▼ to select an ISO sensitivity and ◀▶ to select a level.

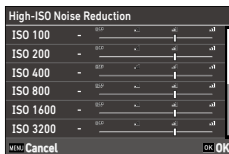

5 Press **OK**.

6 Press **MENU** twice.









⚠ **Caution** -----







- When the noise reduction is set, it may take longer than normal to save images.

Setting the White Balance

You can make adjustments to the white balance so that white subjects will appear white under any kind of light.

If you cannot get the white balance you want when shooting an object of a single color or when shooting under multiple light sources, change the setting.

 Auto White Balance	Adjusts the white balance automatically.
 Auto WB (Warmth Pri.)	Produces a warm finish that retains the color of incandescent lighting.
 Auto WB (White Pri.)	Produces a finish close to the original color even under incandescent lighting.
 Daylight	Used when shooting in daylight under clear skies.
 Shade	Used when shooting in shade.
 Cloudy	Used when shooting in daylight under cloudy skies.
 Fl. - Daylight Color	Used with daylight fluorescent lighting.
 Fl. - Daylight White	Used with neutral white fluorescent lighting.
 Fl. - Cool White	Used with cool white fluorescent lighting.

 Fl. - Warm White	Used with warm white fluorescent lighting.
 Tungsten	Used with incandescent lighting.
 CTE	Exaggerates the color of the light source to leave the color of the subject. Use this setting when you want to emphasize the color used for most part of the image.
 Manual White Balance	Sets the white balance manually. (p.78)
 Color Temperature	Sets the color temperature between 2500 to 10000 K. (p.79)
 Custom 1 to 3	Uses the registered fine-tuned white balance (three types of white balance can be registered).

1 Press **WB** (▼) in the shooting mode.

The [White Balance] screen appears.

2 Use ▲▼ to select a setting.

If no fine tuning is required, proceed to Step 6.

Refer to p.78 for details on [Manual White Balance] and p.79 for [Color Temperature].

3 Press **Fn**.

4 Use ▲▼◀▶ to fine-tune the color.

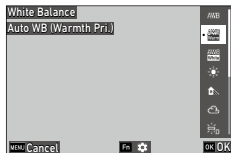

5 Press **OK**.

The screen in Step 2 reappears.

6 Press **OK**.

The white balance icon appears on the shooting screen.

**Memo** -----

- The white balance can also be set in [White Balance] in the **5/5** menu. When the setting of [White Balance Button] has been changed in [Fn Button Setting] in the **C2** menu (p.136), set the white balance from the **5/5** menu.
- When the white balance is turned on in [Memory] in the **C2** menu (p.140), the fine-tuned value is saved even when the camera is turned off.

**Caution** -----

- The white balance may not be adjusted correctly for a subject that is mostly dark.
- When using the flash, set the white balance to [Auto White Balance], [Auto WB (Warmth Pri.)], [Auto WB (White Pri.)], or [Manual White Balance]. The white balance may not be adjusted correctly for other settings.

Setting the White Balance Manually

- 1** Select [Manual White Balance] in Step 2 on p.76.
- 2** Aim the camera at a white subject, such as a sheet of paper, under the light for shooting.
- 3** Press **DISP**.
An image to be used for white balance adjustment is taken.
- 4** Use **▲▼◀▶** to adjust the point.

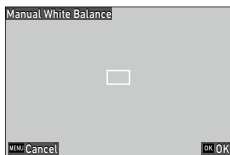

- 5** Press **OK**.
The [White Balance] screen reappears.
- 6** Press **OK**.
The shooting screen reappears.

Setting the Color Temperature

- 1** Select [Color Temperature] in Step 2 on p.76, and then press **▶**.

The [Color Temperature] screen appears.

- 2** Use **▲▼** to set a value.

The color temperature can be set between 2500 to 10000 K in increments of 10 K.

Press **DISP** to fine-tune the color.

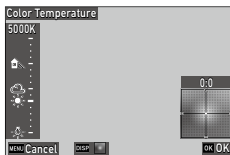

- 3** Press **OK**.

The [White Balance] screen reappears.

- 4** Press **OK**.

The shooting screen reappears.

Setting the Drive Mode

- 1** Press  (▶) in the shooting mode.

The [Drive Mode] screen appears.

- 2** Press ▶.



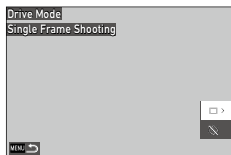

The [Drive] screen appears.

For [Self-timer], refer to p.89.

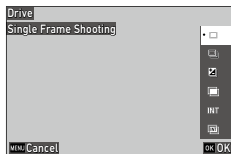

- 3** Use ▲▼ to select a drive mode.



 Single Frame Shooting	Takes a single image per shooting.	—
 Continuous Shooting	Performs continuous shooting while SHUTTER is pressed.	p.81
 Bracketing	Takes three images with different exposure settings.	p.82
 Multi-exposure	Takes images while merging them together.	p.83
 Interval Shooting	Takes images automatically at a fixed interval.	p.85



 Interval Composite	Merges a series of images taken continuously in such a way that the bright areas remain. Use this function when you want to record the trails of light formed by stars or the moon during nightscape shooting at a fixed position.	p.87
---	--	------

4 Press **OK**.

The drive mode icon appears on the shooting screen.



Memo -----

- The drive mode can also be set in [Drive Mode] in the 3 menu. When the setting of [Drive Button] has been changed in [Fn Button Setting] in the 2 menu (p.136), set the drive mode from the 3 menu.

Shooting Continuously (Continuous Shooting)

1 Select [Continuous Shooting] in Step 3 on p.80.

2 Press and hold **SHUTTER** on the shooting screen.
Images continue to be taken while **SHUTTER** is pressed.

Shooting with Varied Exposure Values (Bracketing)

- 1** Select [Bracketing] in Step 3 on p.80, and then press **Fn**.

The detailed settings screen appears.



- 2** Use **▲▼◀▶** to change the setting.

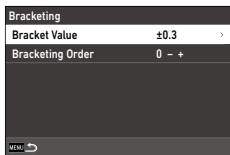

Bracket Value	Sets the range for changing the exposure from ± 0.3 to ± 5.0 .
Bracketing Order	Sets the order of 3 images to be taken from [0 - +], [- 0 +], [+ 0 -], or [0 + -].

- 3** Press **MENU**.
- The [Drive] screen reappears.

- 4** Press **OK**.
- The shooting screen reappears.

- 5** Press **SHUTTER**.
- Three images are saved in the set order with one release of the shutter.

- Memo** -----
- When using the flash, images are taken while automatically changing the flash output.

Shooting While Merging Images Together (Multi-exposure)

- 1 Select [Multi-exposure] in Step 3 on p.80, and then press **Fn**.

The detailed settings screen appears.



- 2 Use **▲▼◀▶** to change the setting.

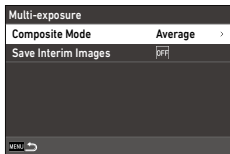

Composite Mode	[Average]: Creates a composite image with the average exposure. [Additive]: Creates a composite image with the cumulatively added exposure. [Bright]: Creates a composite image replacing only the portions that are brighter compared with the first image.
Save Interim Images	Sets whether to save unprocessed images and images in the middle of processing. The images in the middle of processing are saved in the JPEG format.

- 3 Press **MENU**.
The [Drive] screen reappears.
- 4 Press **OK**.
The shooting screen reappears.
- 5 Take the first image.

6 To take the next image, select [Next shot], and then press **OK**.

To retake the image, select [Retake shot].

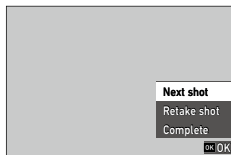

7 Take the next image.

Repeat Steps 6 to 7.

To return to the previous merged image, select [Retake shot].

8 Select [Complete] to end shooting.

The merged image is saved.



Caution

- The settings for the following functions cannot be changed during the multi-exposure shooting.
 - [Drive Mode] in the 3 menu
 - [Shooting Memory Setting], [File Format], [Aspect Ratio], [Crop], and [JPEG Recorded Pixels] in the 4 menu
 - [White Balance] and [Image Control] in the 5 menu

Shooting Automatically at Set Intervals (Interval Shooting)

- 1** Select [Interval Shooting] in Step 3 on p.80, and then press **Fn**.

The detailed settings screen appears.

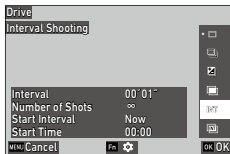

- 2** Use **▲▼◀▶** to change the setting.

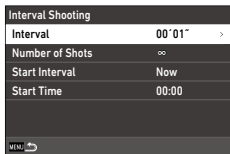

Interval	Sets the shooting interval from [Minimum] to 60 min.
Number of Shots	Sets the number of shots to [∞] or from [2] to [99].
Start Interval	Sets whether to take the first image immediately or at the set time.
Start Time	Sets the time when [Start Interval] is set to [Set Time].

- 3** Press **MENU**.

The [Drive] screen reappears.

- 4** Press **OK**.

The shooting screen reappears.

- 5** Press **SHUTTER**.

When [Start Interval] is set to [Now], the first image is taken. When [Start Interval] is set to [Set Time], shooting starts at the set time.

To cancel shooting, press **OK**.

**Caution**-----

- Depending on the shooting settings, the time until the next image is taken may be longer than the time set for the interval shooting.
- When the shooting interval is short, the exposure for the first image may be used for the second and later images.
- The interval shooting is canceled if the exposure mode is changed or the camera is turned off.

**Memo**-----

- For each interval shooting, a new folder is created and the images are saved there.
- If “Full Press Snap” shooting is performed when [Focus] is set to [MF], [Snap], or [∞] in the  1 menu (p.60), the focus position is fixed at the position for the first image.
- Use a fully charged battery, commercially available AC adapter compatible with USB Power Delivery, or optional AC adapter (K-AC166).

Recording Star Trails (Interval Composite)

1 Mount the camera on a tripod, and then take a test shot.
Set the exposure, focus mode, and white balance, and then check the composition. Images are merged with this exposure setting.

2 Select [Interval Composite] in Step 3 on p.80, and then press **Fn**.

The detailed settings screen appears.

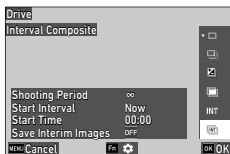

3 Use **▲▼◀▶** to change the setting.

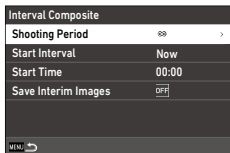

Shooting Period	Sets the shooting period to [∞] or from 10 min. to 24 hr.
Start Interval	Sets whether to take the first image immediately or at the set time.
Start Time	Sets the time when [Start Interval] is set to [Set Time].
Save Interim Images	Sets whether to save unprocessed images and images in the middle of processing. The images in the middle of processing are saved in the JPEG format.

4 Press **MENU**.
The [Drive] screen reappears.

5 Press **OK**.
The shooting screen reappears.

6 Take the first image.

Images are taken continuously at the shortest interval.

To check the images being merged, press **SHUTTER** halfway.

If **SHUTTER** is pressed fully, the images merged up to that point are saved as they are, and the interval composite shooting starts with a new image.

To cancel shooting, press **OK**.



Caution -----

- During exposure, the image at the time **OK** is pressed or **SHUTTER** is fully pressed is not merged.
- The interval composite shooting is canceled if the exposure mode is changed or the camera is turned off.
- Autofocus is not performed for the second and subsequent images.
- The following functions are fixed to [Off].
 - [Slow Shutter Speed NR] in [Noise Reduction] in the **5** menu
 - [Shake Reduction] in the **6** menu



Memo -----

- When [Save Interim Images] is set so that images in the middle of processing are saved, for each interval composite, a new folder is created and the images are saved there.
- The values of the following settings are fixed when the first image is taken.
 - Focus position of autofocus
 - ISO sensitivity, shutter speed, and aperture value when the ISO sensitivity is set to ISO AUTO
 - White balance values
- During shooting in a dark location, using the optional external viewfinder (GV-1 or GV-2) is convenient.

Using the Self-timer

In the drive modes other than [Continuous Shooting], you can use [Self-timer] together. [10sec.] or [2sec.] can be selected. The self-timer lamp blinks and a beep sounds during the self-timer countdown.

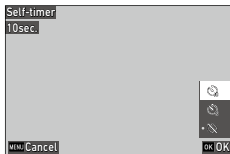

Memo -----

- The self-timer can only be used for the first image in [Interval Shooting] and [Interval Composite]. When [Start Interval] is set to [Set Time], the self-timer is disabled.
- The self-timer lamp and beep sound during the self-timer countdown can be turned off. (p.144, p.145)

Configuring the Image Save Settings

Setting the Save Destination

You can set the save destination for still images and movies in [Shooting Memory Setting] in the 4/ 4 menu.

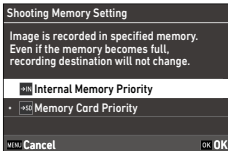

Internal Memory Priority	Saves still images and movies in the internal memory.
Memory Card Priority	When a memory card is inserted, saves still images and movies in the memory card, and when a memory card is not inserted, saves them in the internal memory.



Caution

- Even if the save destination memory becomes unable to save still images and movies (due to no free space available, folder creation not possible, memory failure, or other conditions that prevent recording), the save destination does not switch to the other destination.

Still Image Save Settings

You can set the file format for still pictures in [Image Capture Settings] in the  4 menu.

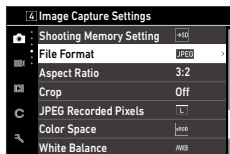

File Format	[JPEG] [RAW]: Saves a RAW image (DNG format). [RAW+JPEG]: Saves a RAW image simultaneously with a JPEG image.
Aspect Ratio	[3:2], [4:3], [1:1], [16:9]
Crop	[Off], [35mm], [50mm]
JPEG Recorded Pixels	[L], [M], [S], [XS]
Color Space	[sRGB], [AdobeRGB]

3

Taking Images





Memo

- When [Aspect Ratio] is set to [4:3] or [1:1], black bands appear at the right and left sides of the monitor, and when [Aspect Ratio] is set to [16:9], black bands appear at the top and bottom of the monitor.
- This function can be registered to [ADJ Mode Setting] and [Fn Button Setting] in the  2 menu. (p.134, p.136)
If [JPEG → RAW] or [JPEG → RAW+] is set to [Fn Button Setting], the image format can be easily switched.



Shooting RAW Images

- A RAW image can be converted to JPEG format in [RAW Development] in the  3 menu. (p.111)
- RAW images are saved with the recorded pixels of 26M (6192 × 4128) regardless of the [Aspect Ratio] and [Crop] settings.
- The following functions are not reflected in RAW images. These functions can be reflected when a RAW image is converted to JPEG format in [RAW Development] in the  3 menu.
 - Image Control
 - Shadow Correction

When the file format is set to [RAW+JPEG], the functions listed above are reflected in JPEG images only.



Changing the Angle of View

- When [Crop] is set to [35mm] or [50mm], the 35 mm equivalent angle of view is changed from default 28 mm to 35 mm or 50 mm, and the image display is also changed.
- When [Crop] is set, available [JPEG Recorded Pixels] settings are limited.

Crop	JPEG Recorded Pixels
35mm	When [L] is set: Changes the recorded pixels to [M].
50mm	When [L] or [M] is set: Changes the recorded pixels to [S].

Movie Save Settings

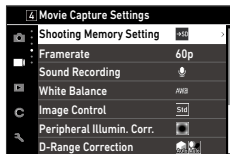

You can set the file format for movies in [Movie Capture Settings] in the **4** menu.





Framerate	[60p], [30p], [24p]
Sound Recording	[On], [Off]

Setting the Image Finishing Tone and Correction

Using the ND Filter

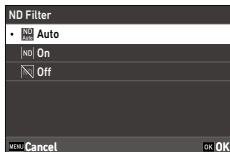
You can set whether to always use the internal ND filter of the camera in [ND Filter] in the  2/  2 menu.



Auto	Automatically determines whether to turn this function on or off according to conditions. The ND filter is used when the icon is displayed on the shooting screen when SHUTTER is pressed halfway. This function is disabled when the ISO sensitivity is set to a fixed value in the M mode. [Auto] cannot be selected in the  mode.
On	Always uses the ND filter. The icon is displayed on the shooting screen.
Off	Not uses the ND filter.



Memo

- This function can be registered to [Fn Button Setting] in the  2 menu. (p.136)

Reducing Moiré (AA Filter Simulator)

A moiré reduction effect simulating that of a low-pass filter can be achieved with [AA Filter Simulator] in the  3 menu. [High], [Low], or [Off] can be selected.

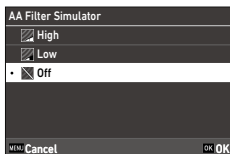











Caution







- When shooting with a fast shutter speed or with the flash, the full effect of this function may not be achieved.

Setting the Image Atmosphere (Image Control)



You can take images with varied saturation and contrast.

The settings such as the color tone can be changed to take distinctive images.

 Standard	Takes an image with normal image quality.
 Vivid	Takes an image with vivid and sharp colors.
 Monotone	Takes a black and white image.
 Soft Monotone	Takes a black and white image that gives soft impression. This cannot be selected in the  mode.
 Hard Monotone	Takes a black and white image that gives hard impression.
 Hi-Contrast B&W	Takes a black and white image with stronger contrast. This makes it possible to take images with a grainy feel, such as that created by using ultra-high-sensitivity film in a film camera or by push processing film at the development stage.
 Negative Film	Takes an image like one taken with positive film.
 Positive Film	Takes a highly saturated image like one taken with positive film.
 Cinema (Yellow)	Takes a cinematic image with a yellowish tint.
 Cinema (Green)	Takes a cinematic image with a greenish tint in the shadow areas.



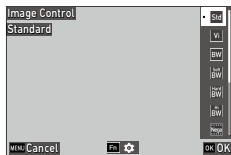

 Cross Processing	Takes an image that looks as if it has been cross-processed by changing the color tone and contrast.
 Bleach Bypass	Takes an image with low saturation and high contrast.
 Retro	Takes an image that looks like an old photo.
 HDR Tone	Takes an image finished like a painting with enhanced fine contrast. This cannot be selected in the  mode.
 Custom 1 to 3	Takes an image with parameters changed (three types of image control can be registered).

1 Select [Image Control] in the 5/5 menu, and then press . The [Image Control] screen appears.

2 Use   to select an image.
 If you do not want to change the parameters, proceed to Step 6.



3 Press .
 The detailed settings screen appears.

4 Use     to change the setting.
 Available parameters vary depending on the selected image.

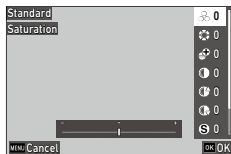

5 Press .
 The screen in Step 2 reappears.

6 Press **OK**.

7 Press **MENU**.

The icon appears on the shooting screen.

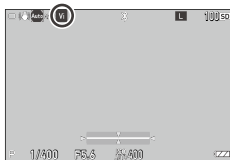

Caution -----

- The [Image Control] setting is not applied to RAW images. It can be set when [RAW Development] in the **3** menu is performed. (p.111)

Memo -----



- This function can be registered to [ADJ Mode Setting] and [Fn Button Setting] in the **2** menu. (p.134, p.136)
- The names of [Custom 1] to [Custom 3] can be changed using the RICOH GR series dedicated app "GR WORLD". (p.124)

Correcting the Peripheral Illumination

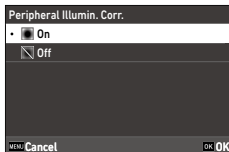

You can reduce peripheral light fall-off occurring due to lens properties with [Peripheral Illumin. Corr.] in the **5/5** menu.

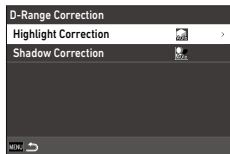

Correcting a Range of Tones (D-Range Correction)

You can expand an image gradation to make the bright and dark portions of an image clearly visible with [D-Range Correction] in the  5/  5 menu.



 Highlight Correction	[Auto], [On], or [Off] can be selected. [On] cannot be selected in the  mode.
 Shadow Correction	[Auto], [Low], [Medium], [High], or [Off] can be selected.





Caution

- When [Shadow Correction] is set to [High], noise in images may be noticeable.
- When the ISO sensitivity is set to less than ISO 200, [Highlight Correction] does not operate.



Reducing Blurring of Images

To automatically reduce blurring of images, set the following functions. By default, both settings are set to [On].

Still Image Mode	[Shake Reduction] in the  6 menu
Movie Mode	[Movie SR] in the  6 menu



Memo



- If [Shake Reduction] is set to [Fn Button Setting] in the 2 menu, the Shake Reduction function can be turned on and off with button operation only. (p.136)
- When [Self-timer] is set in [Drive Mode], [Shake Reduction] is automatically set to [Off]. To keep the Shake Reduction function set to [On], set [Auto SR Off] to [Disable Auto SR Off] in the 6 menu.

Correcting the Skew of Images

You can correct the horizontal camera angle detected by the electronic level. Make settings in [Horizon Correction] in the 6 menu.

Using the Playback Functions

You can set the playback functions in the  menu or on the playback function selection screen.

Press  or tap and hold on the monitor in the playback mode to display the playback function selection screen. The  2/ 3 menu settings can be made on the playback function selection screen.



Caution

- The playback functions that are not supported by the displayed image cannot be used.

Changing the Playback Method

Displaying Multiple Images

You can display multiple images in the thumbnail view.

- 1 Press the **-** side of **DISP** in the single image display in the playback mode.

Multiple images are displayed.

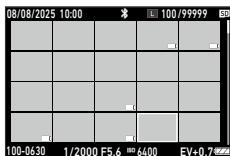

The following operations are available.

	Moves the selection frame.
Flick up or down	Switches pages.
DISP	Switches between 20-image view and 48-image view.
+ (-) / Pinch in	Switches to the shooting date display (folder display).
OK	In the shooting date display: Displays multiple images of the selected shooting date. In the folder display: Displays multiple images in the selected folder.
	Deletes the selected images. (p.104)
/ Tap and hold	Displays the playback function selection screen.
(MV / SD) (pressed and held)	Switches the memory to play back images.

- 2 Press **OK** or **ADJ.**

You can also tap the image to select it.

The selected image is displayed in the single image display.

**Memo**

- The images are displayed in order of the shooting date and time. The display order can be changed to [File No.] in [Playback Order Options] in the **▶ 1** menu. In this case, if the – side of **▶** is pressed after Step 1, images are displayed in the folder display.
- When multiple images are displayed, switching to the **▶ 2** menu or playback function selection screen allows you to apply the selected function to multiple images at once. When a function is selected in the shooting date display or folder display, the function can be applied by shooting date or by folder. If a function that cannot be applied by shooting date or by folder is selected, an error message is displayed.

Displaying Rotated Images

You can change image rotation information in 90° increments.

- 1** Display the image to rotate in the single image display in the playback mode.

When multiple images are displayed, the selected images are processed.

- 2** Select [Image Rotation] in the **▶ 2** menu or on the playback function selection screen, and then press **▶**.

- 3** Select the rotation direction, and then press **OK**.

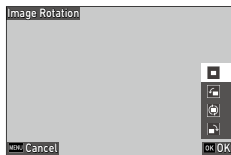
**Memo**

- In the playback mode, the displayed image is rotated according to the camera's orientation. When [Auto Image Rotation] is set to [Off] in the **▶ 1** menu, the image display orientation is fixed regardless of the [Image Rotation] setting.

**Caution**-----

- Rotation direction cannot be changed when the write-protect switch on the memory card is locked or for the following images.
 - Movies
 - Protected images

Connecting the Camera to an AV Device

You can connect the camera to an AV device such as a TV to display Live View images while shooting or to play back images.

Use the provided USB cable (I-USB198) to connect the camera to an AV device.

1 Turn the AV device and camera off.

2 Open the terminal cover of the camera, and then connect the USB cable to the USB terminal.

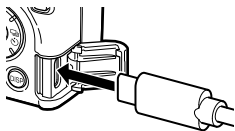

3 Connect the USB cable to the video input terminal on the AV device.

For details, refer to the manual for the AV device.

4 Turn the camera on.

5 Turn the AV device on.

**Caution**-----

- While the camera is connected to an AV device, nothing is displayed on the camera monitor.
- The audio of movies is output from the AV device. Adjust the volume on the AV device.
- The camera cannot supply power to the AV device. Supply power on the AV device side.

**Memo**-----

- The USB terminal (USB Type-C) on the camera supports DisplayPort™.

Organizing Files

Deleting Files

1 Select [Delete] in the **▶ 2** menu or on the playback function selection screen, and then press **▶**.

2 Select [Delete 1 Image] or [Delete All Images].

When [Delete 1 image] is selected, use **◀▶** to select an image.

For images taken with [File Format] set to [RAW+JPEG], you can select the file format to delete.

When [Delete All Images] is selected, you cannot select the file format to delete.

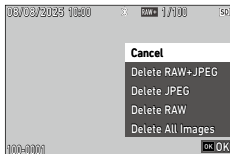

3 Press **OK**.

The image is deleted.

Repeat Steps 2 and 3 to delete another image.

To end the process, select [Cancel].

When [Delete All Images] is selected, proceed to the next step.

4 Select [Execute], and then press **OK**.

All images are deleted.

Deleting Multiple Images

1 Press the – side of  in the single image display in the playback mode.



Multiple images are displayed.

2 Press .

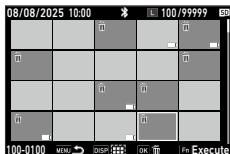
3 Select the images to delete.



The following operations are available.

	Moves the selection frame.
	Selects/Deselects an image.
	Selects the starting or ending point for image selection range.

4 Press .

The confirmation screen appears.

5 Select [Execute], and then press .

The selected images are deleted.



Memo -----

- Protected images cannot be selected.

Protecting Images from Deletion

You can protect images to prevent them from being deleted accidentally.

1 Select [Protect] in the **2** menu or on the playback function selection screen, and then press **▶**.

2 Select [Protect 1 Image] or [Protect All Images].

When [Protect 1 Image] is selected, use **◀▶** to select an image.

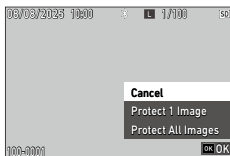

3 Press **OK**.

When [Protect 1 Image] is selected, the selected image is protected.

Repeat Steps 2 and 3 to protect another image.

To end the process, select [Cancel].

When [Protect All Images] is selected, proceed to the next step.



4 Select [Protect] or [Unprotect], and then press **OK**.

All images are protected or unprotected.



Memo -----

- To cancel the protection, set [Protect] for the image again.



Caution -----

- If [Format] is performed in the **1** menu, protected images are also deleted.

Protecting Multiple Images from Deletion

- 1** Press the – side of **[F]** in the single image display in the playback mode.
Multiple images are displayed.
- 2** Select [Protect] in the **[▶ 2]** menu or on the playback function selection screen, and then press **[▶]**.
- 3** Select the images to protect.

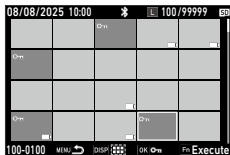

The following operations are available.

▲▼◀▶ / ↶ / ↷	Moves the selection frame.
OK	Selects/Deselects an image.
DISP	Selects the starting or ending point for image selection range.

- 4** Press **[Fn]**.
The confirmation screen appears.
- 5** Select [Execute], and then press **OK**.
The selected images are protected.

Copying Images

You can copy images between the internal memory and the memory card.

- 1 Insert a memory card.
- 2 Press and hold **□** ($\frac{M}{SD}$) to select the memory from which the image is copied.

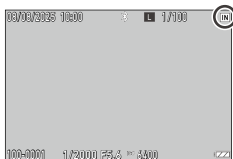

- 3 Select [Image Copy] in the **▶ 2** menu or on the playback function selection screen, and then press **▶**.

- 4 Select [Copy 1 Image] or [Copy All Images].

When [Copy 1 Image] is selected, use **◀▶** to select an image.

For images taken with [File Format] set to [RAW+JPEG], you can select the file format to copy.

When [Copy All Images] is selected, you cannot select the file format to copy.

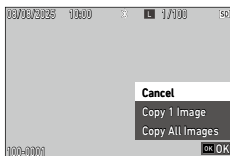

- 5 Press **OK**.

When [Copy 1 Image] is selected, the image is saved to the copy destination.

Repeat Steps 4 and 5 to copy another image.

To end the process, select [Cancel].

When [Copy All Images] is selected, proceed to the next step.

- 6 Select [Execute], and then press **OK**.

A new folder is created at the copy destination and the images are saved there.

**Caution**

- If there is insufficient capacity at the copy destination, a message indicating insufficient capacity is displayed.

Copying Multiple Images

- 1 Press and hold ($\frac{IN}{SD}$) to select the memory from which the images are copied.
- 2 Press the – side of in the single image display in the playback mode.
Multiple images are displayed.
- 3 Select [Image Copy] in the 2 menu or on the playback function selection screen, and then press .
- 4 Select the images to copy.

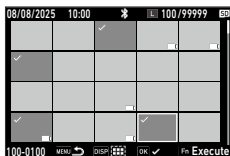

The following operations are available.

	Moves the selection frame.
	Selects/Deselects an image.
	Selects the starting or ending point for image selection range.

- 5 Press .
- The confirmation screen appears.
- 6 Select [Execute], and then press .
- The selected images are copied.

Setting the Transfer Reservation for Images

You can select images to transfer to a communication device and make a transfer reservation.

When you operate the RICOH GR series dedicated app with a communication device that has registered the camera, the file transfer automatically starts.

1 Select [File Transfer] in the **▶ 2** menu or on the playback function selection screen, and then press **▶**.

2 Select [Transfer 1 Image].

Use **◀▶** to select an image.

For images taken with [File Format] set to [RAW+JPEG], you can select the file format to transfer.

3 Press **OK**.

The transfer reservation is set for the image.

Repeat Steps 2 and 3 to transfer another image.

To end the process, select [Cancel].

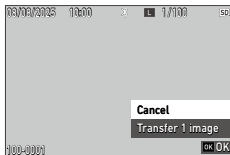

Memo

- To cancel the transfer reservation, set [File Transfer] for the image again.
- Refer to “Using the Camera with a Communication Device” (p.124) for how to connect the camera to a communication device.

Setting the Transfer Reservation for Multiple Images

1 Press the **-** side of **■** in the single image display in the playback mode.

Multiple images are displayed.

2 Select [File Transfer] in the **▶ 2** menu or on the playback function selection screen, and then press **▶**.

3 Select [Transfer Reservation] or [Cancel Reservation], and then press **OK**.

When [Transfer Reservation] is selected, proceed to the next step.

When [Cancel Reservation] is selected, the transfer is canceled and the screen returns to the multi-image display.

4 Select the images to transfer.

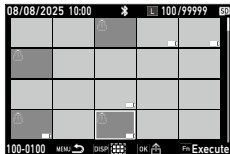

The following operations are available.

	Moves the selection frame.
	Selects/Deselects an image.
	Selects the starting or ending point for image selection range.

5 Press **Fn**.

The screen to select the file format for transferred images appears.

6 Use **ADJ** to turn each file format on or off.



7 Press **OK**.

The transfer reservation is set for the selected images.

Editing and Processing Images

You can edit and process taken images and then save them as new images.







Caution

- Only JPEG images taken with the camera can be edited and processed (only RAW images for [RAW Development]). Still images saved from movies cannot be edited and processed. Note that if you edit and process images repeatedly, image quality will deteriorate.

Developing RAW Images

You can convert RAW images (file extension: DNG) into JPEG format (file extension: JPG) and then save them as new images. Various settings such as [White Balance] and [Image Control] can be configured for saved images.

- 1 Display the RAW image to develop in the playback mode.
- 2 Select [RAW Development] in the  3 menu or on the playback function selection screen, and then press .
The [RAW Development] screen appears.
- 3 Use   to select a parameter.

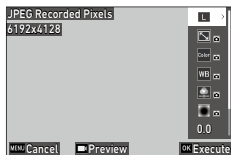



The following settings are available.

- JPEG Recorded Pixels
- Aspect Ratio
- Color Space
- White Balance
- Image Control
- Peripheral Illumin. Corr.
- Sensitivity
- High-ISO Noise Reduction
- Shadow Correction

The settings that were set at the time of shooting are initially selected. You can only select settings that can be changed.

The following operations are available.

	Displays the preview.
	During the preview: Magnifies the image.

4 Press **▶**.

The setting selection screen appears.

5 Use **▲▼** to select a setting.

For [White Balance] and [Image Control], pressing **Fn** displays the detailed settings screen.

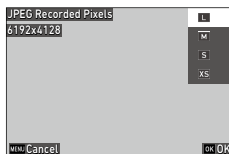

6 Press **OK**.

The screen in Step 3 reappears.

7 When you have finished configuring all of the settings, press **OK**.

8 Select the save destination memory, and then press **OK**.

The image is saved as a new image.

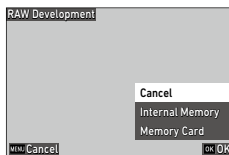

9 Select [Continue] or [Finish], and then press **OK**.



When [Continue] is selected, the screen in Step 3 reappears.

Developing Multiple RAW Images

You can develop multiple images with the same settings.

- 1** Press the – side of  in the single image display in the playback mode.

Multiple images are displayed.



- 2** Select [RAW Development] in the  3 menu or on the playback function selection screen, and then press .

RAW images are searched.

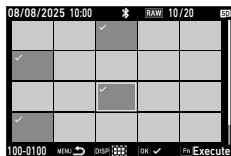
- 3** Select the images to develop.



The following operations are available.

	Moves the selection frame.
	Selects/Deselects an image.
	Selects the starting or ending point for image selection range.

- 4** Press .

The parameter selection screen appears.

- 5** Select a parameter and setting.

- 6** When you have finished configuring all of the settings, press .

- 7** Select the save destination memory, and then press .

The images are saved as new images.

Changing the Image Size

Reducing the Image Size (Resize)

You can reduce the size of JPEG images and save them.

- 1** Display the image to process in the single image display in the playback mode.

When multiple images are displayed, the selected images are processed.

- 2** Select [Resize] in the **▶ 3** menu or on the playback function selection screen, and then press **▶**.

The [Resize] screen appears.

- 3** Select the image size.

The smaller size than the [JPEG Recorded Pixels] setting for shooting can be selected.

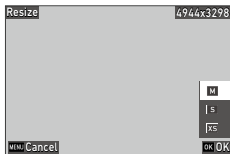

- 4** Press **OK**.

- 5** Select the save destination memory, and then press **OK**.

The image is saved as a new image.

Cropping Images

You can crop a part of JPEG images and then save them.

- 1** Display the image to process in the single image display in the playback mode.

When multiple images are displayed, the selected images are processed.

- 2** Select [Cropping] in the **▶3** menu or on the playback function selection screen, and then press **▶**.

The [Cropping] screen appears.

- 3** Specify the range to crop.



The following operations are available.

▲▼◀▶ / ↶ / ↷	Moves the cropping frame.
ADJ	Changes the aspect ratio of the cropping frame (3:2, 4:3, 1:1, or 16:9).
DISP	Switches the ↶ operation between changing the cropping size and rotating the image.
+	Changes the cropping size or rotates the cropping frame by 0.1°.
Fn	Rotates the cropping frame by 90°.
Preview	Displays the preview.
↶ / +	During the preview: Magnifies the image.

- 4** Press **OK**.

- 5** Select the save destination memory, and then press **OK**.

The image is saved as a new image.

Correcting Highlight/Shadow Areas (Levels Adjustment)

You can correct the brightness and contrast of the highlight, mid-tone, and shadow areas in JPEG images.

- 1** Display the image to process in the single image display in the playback mode.
When multiple images are displayed, the selected images are processed.
- 2** Select [Levels Adjustment] in the **▶ 3** menu or on the playback function selection screen, and then press **▶**.
The [Levels Adjustment] screen appears.
- 3** Adjust the value.

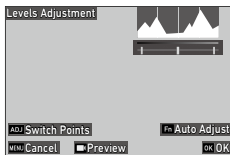

The following operations are available.

ADJ	Switches the adjustment points.
◀▶ / ☺	Adjusts the value.
Fn	Performs the auto correction.
◻	Displays the preview.
☺ / +	During the preview: Magnifies the image.

- 4** Press **OK**.
- 5** Select the save destination memory, and then press **OK**.
The image is saved as a new image.



How to Make Adjustments

- Moving the center point left or right adjusts the overall brightness. Move it to the left to make the image brighter, or move it to the right to make the image darker.

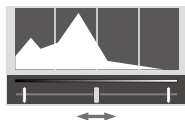

- If the image is overexposed, move the left point to the right so that it aligns with the edge of the histogram peak. If the image is underexposed, move the right point to the left.

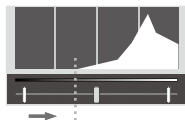

- When the histogram peak is in the center and the contrast is low, align the left and right points with the edges of the histogram peak.

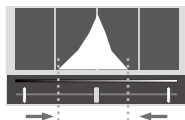

Correcting the White Balance

You can correct the white balance of JPEG images.

- 1** Display the image to process in the single image display in the playback mode.

When multiple images are displayed, the selected images are processed.

- 2** Select [WB Adjustment] in the **▶ 3** menu or on the playback function selection screen, and then press **▶**.

The [WB Adjustment] screen appears.

- 3** Adjust the value.

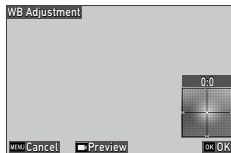

The following operations are available.

	Moves the adjustment points.
	Displays the preview.
	During the preview: Magnifies the image.

- 4** Press **OK**.

- 5** Select the save destination memory, and then press **OK**.

The image is saved as a new image.

Correcting Color Moiré

You can reduce color moiré in images.

- 1** Display the image to process in the single image display in the playback mode.

When multiple images are displayed, the selected images are processed.

- 2** Select [Color Moiré Correction] in the **▶ 3** menu or on the playback function selection screen, and then press **▶**.

The [Color Moiré Correction] screen appears.

- 3** Adjust the value.

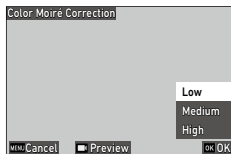

The following operations are available.

	Selects the correction level.
	Displays the preview.
	During the preview: Magnifies the image.

- 4** Press **OK**.

- 5** Select the save destination memory, and then press **OK**.

The image is saved as a new image.

- ⚠ Caution** -----
- Some images may not be corrected properly.
 - If [Color Moiré Correction] is applied, color loss or color bleeding may occur in images.

Adjusting the Image Quality

You can adjust the quality level of JPEG images.

- 1** Display the image to process in the single image display in the playback mode.
When multiple images are displayed, the selected images are processed.
- 2** Select [Base Parameter Adj] in the **▶ 3** menu or on the playback function selection screen, and then press **▶**.
The [Base Parameter Adj] screen appears.
- 3** Use **F_n** to switch between the normal editing and the monotone editing.
- 4** Adjust the value.

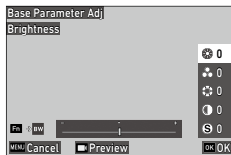

The following operations are available.

▲ ▼	Normal editing: Sets [Brightness], [Saturation], [Hue], [Contrast], or [Sharpness]. Monotone editing: Sets [Brightness], [Filter Effect], [Toning], [Contrast], or [Sharpness].
◀ ▶	Sets a value (± 4).
□	Displays the preview.
🔍 / 📏	During the preview: Magnifies the image.

- 5** Press **OK**.
- 6** Select the save destination memory, and then press **OK**.
The image is saved as a new image.

Editing Movies

You can cut out or divide a movie file and save as a new file(s).

- 1** Display the movie to process in the single image display in the playback mode.
When multiple movies are displayed, the selected movies are processed.
- 2** Select [Movie Edit] in the **▶ 3** menu or on the playback function selection screen, and then press **▶**.
The [Movie Edit] screen appears.
- 3** Select [Cut] or [Divide], and then press **OK**.





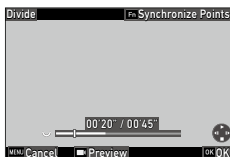
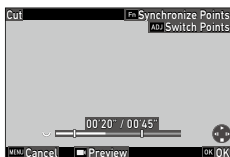

Cut	Saves the range specified with the start and end points as a new file.
Divide	Divides a movie into two files at the specified division point and saves as new files.

- 4** Specify the starting and ending points or division point.
You can play or pause the movie in the same manner as when viewing a movie in the playback mode. (p.59)



The following operations are also available.

	[Cut]: Switches between the starting and ending points.
	[Cut]: Moves the starting or ending point. [Divide]: Moves the division point.
	[Cut]: Moves the starting or ending point to the playback point. [Divide]: Moves the division point to the playback point.
	While the movie is paused: Displays the preview.

5 Press .

4 **6** Select the save destination memory, and then press .

The movie file(s) is saved as a new movie(s).

Using the Camera with a Computer

You can connect the camera to a computer using the provided USB cable (I-USB198) to copy the images from the camera to the computer.

- 1** Turn the camera off.
- 2** Open the terminal cover of the camera, and then connect the USB cable to the USB terminal.

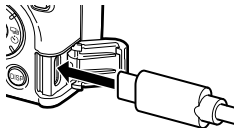

- 3** Connect the USB cable to the USB Type-C port of the computer.

The camera turns on and enters the playback mode.

The camera is recognized as a device by the computer.

When a memory card is inserted, the files on the memory card are displayed. When a memory card is not inserted, the files in the internal memory are displayed. Pressing and holding  (Fn) switches the memory to play back images.

- 4** Copy the images to the computer.

The status lamp blinks while images are being transferred.

- 5** Disconnect the camera from the computer when the copy is complete.

- 6** Remove the USB cable from the camera.

Caution -----

- Do not remove the USB cable while images are being transferred.
- If the battery level is low, it may take some time until the camera is recognized by the computer.
- The wireless communication function is not available while the camera is connected to a computer with a USB cable.



Memo

- When the camera is connected to a computer, it is recognized as a device with the name "RICOH GR IV".
- Refer to "Operating Environment" (p.175) for system requirements to connect the camera to a computer.
- When [USB Setting] is set to [License Display] in the  6 menu, you can check the software license information.

Using the Camera with a Communication Device

The following functions can be used by connecting the camera to a communication device via Bluetooth® and using the RICOH GR series dedicated app "GR WORLD".

Remote Shooting	Performs shooting remotely by operating a communication device.
Image View	Displays the images saved in the camera on the communication device and imports them to the communication device.
Time Synchronization	Synchronizes the date and time displayed on the camera with the date and time settings of the communication device.
Power Supply Control	Turns the camera on and off from by operating the communication device.
Firmware Update	Downloads the camera firmware and updates the camera.
Camera Name Change	Changes the camera name (default setting: MY GR IV).

"GR WORLD" supports iOS and Android™, and can be downloaded from the App Store or Google Play™. For the supported operating system and other details, refer to the download site.



Memo

- To download GR WORLD and for more information, refer to the following website.
<https://www.ricoh-imaging.com/gr-world/download/>
- When the camera is connected to the communication device via Bluetooth®, the wireless LAN function is turned on or off according to requests from the app.
- For details on using the camera with the communication device, refer to the manual of the device used and the “GR WORLD” website.
- The app screen varies depending on the camera model, communication device operating system, and app version. Note that the specifications of the app may be changed without notice in order to improve functionality.



Caution

- The wireless LAN function does not turn on in the following case.
 - In the mode
 - While the camera is connected to a device with the USB cable
 - When [Wireless Communication] is set to [Off] in the 6 menu
 - When [Airplane Mode] is set to [On] in the 6 menu

Connecting the Camera to a Communication Device

You can connect the camera to a communication device wirelessly via Bluetooth®. Install the RICOH GR series dedicated app “GR WORLD” on the communication device in advance.

- 1** Turn on the Bluetooth® function of the communication device.
- 2** Start the GR WORLD on the communication device.
- 3** Tap [Register new camera] on the home screen of the app.
- 4** Select [GR IV], and then tap [This is the first time].

- 5** Select [Wireless Communication] in the  6 menu, and then press .

The [Wireless Communication] screen appears.

- 6** Select [Action Mode], and then press .

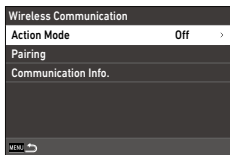

- 7** Select [On], and then press .

- 8** Select [Pairing], and then press .

- 9** Select [Execute Pairing], and then press .

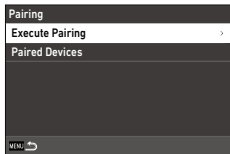

- 10** Tap [Search for cameras] on the app.
[Device Name] of the camera is displayed.

- 11** Tap [Device Name] of the camera.

[Authentication Code] is displayed on the camera and app.

- 12** Check that the displayed authentication codes match, and then tap [Pairing] or [OK] on the app.

- 13** Press  of the camera.

The camera and the communication device are paired, and the pairing completion screen appears.

The connection status icon appears when the camera is connected to the communication device via Bluetooth®.



**Caution**-----

- Pairing is not possible in the following cases.
 - While the camera is connected to a device with the USB cable
 - When [Wireless Communication] is set to [Off] in the 6 menu
 - When [Airplane Mode] is set to [On] in the 6 menu
- When using a wireless connection, observe local laws and regulations governing radio communication.
- In locations where wireless communication functions cannot be used, such as on an airplanes, set [Airplane Mode] to [On] in the 6 menu.

**Memo**-----

- The taken images can be transferred to the communication device by setting a transfer reservation in [File Transfer] in the 2 menu. (p.109) You can also set transfer reservations automatically for taken images. (p.128) When [Import images] is tapped on the app, transfer starts after the connection via wireless LAN is established.
- Selecting [Paired Devices] on the screen in Step 6 displays the list of paired communication devices. You can cancel pairing with each device by pressing on this screen. The pairing can be established with up to six communication devices.
- Selecting [Communication Info.] on the screen in Step 3 displays the camera's [Device Name].
- The frequency band can be changed using the RICOH GR series dedicated app.

About the Wireless LAN

- Available frequency bands vary depending on the country.
- The 5 GHz band is restricted for outdoor use in some countries.

Setting Functions Linked with the Communication Device

You can select the functions to be linked to the communication device.

- 1** Select [Smartphone Link] in the **6** menu, and then press **▶**.
The [Smartphone Link] screen appears.
- 2** Select the function to link, and then press **▶**.

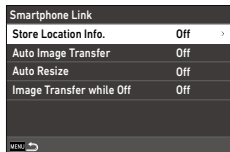

The following functions can be selected.

Store Location Info.	Records the location information of the communication device in taken images.
Auto Image Transfer	Automatically sets the transfer reservation for taken images after shooting. Select the format of transferred files.
Auto Resize	Resizes [JPEG Recorded Pixels] of transferred images to [XS] when set to [On].
Image Transfer while Off	Sets whether to continue image transfer even when the camera is turned off during transfer.



- 3** Select [On], and then press **OK**.
Repeat Steps 2 to 3.
- 4** Press **MENU** twice.

Saving Frequently Used Settings

You can use the shooting settings saved in **U1**, **U2**, and **U3** of the mode dial.

There are two ways to save the shooting settings: Register the current settings or recall the settings saved in the setting boxes.

The following settings can be saved.

- Exposure mode
- Exposure compensation
-  menu and  menu settings (with exceptions)

Saving the Current Settings

You can save the current settings to the mode dial.

1 Set the exposure mode and all the necessary settings to save.

2 Select [Assign User Mode Dial] in the  menu, and then press .
The [Assign User Mode Dial] screen appears.

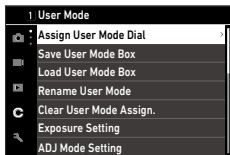

3 Select from [USER1] to [USER3], and then press .

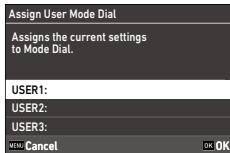

4 Select whether to enter a user mode name, and then press **OK**.

When [Enter Name] is selected, the text entry screen appears.

When [Cancel] is selected, proceed to Step 7.

5 Enter a user mode name.

Up to 32 single-byte alphanumeric characters and symbols can be entered.

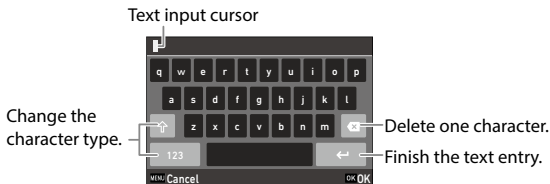

The following operations are available.

▲▼◀▶	Moves the text selection cursor.
↶ / ↷	Moves the text selection cursor up and down.
↶	Moves the text selection cursor right and left.
OK / ADJ	Enters a character selected with the text selection cursor.

You can also use the touch screen for the operations.

6 After entering the text, move the text selection cursor to **←**, and then press **OK**.

The confirmation screen appears.

7 After checking the setting, press **OK**.

The **C 1** menu reappears.



Memo

- If a name is not entered, the registration date and time are used as the user mode name.
- To change the user mode name, select [Rename User Mode] in the **C 1** menu.
- To delete the user mode settings, select [Clear User Mode Assign.] in the **C 1** menu.

Using the Setting Boxes

Saving the Settings in a Setting Box

You can save six different settings in the setting boxes.

- 1 Set the exposure mode and all the necessary settings to save.
- 2 Select [Save User Mode Box] in the **C 1** menu, and then press **▶**.
The [Save User Mode Box] screen appears.
- 3 Select from [BOX1] to [BOX6], and then press **OK**.

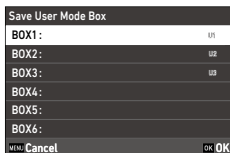

- 4 Select whether to enter a box name, and then press **OK**.
When [Enter Name] is selected, enter the name according to Steps 5 and 6 of "Saving the Current Settings" (p.129).
When [Cancel] is selected, proceed to the next Step.
- 5 Press **OK**.
The **C 1** menu reappears.

Assigning the Settings to the Mode Dial

You can assign the settings saved in a setting box to the mode dial.

- 1** Select [Load User Mode Box] in the **C 1** menu, and then press **▶**.

The [Load User Mode Box] screen appears.

- 2** Select from [BOX1] to [BOX6], and then press **OK**.

- 3** Select the mode dial to assign the settings to from **USER1 (U1)**, **USER2 (U2)**, and **USER3 (U3)**, and then press **▶**.

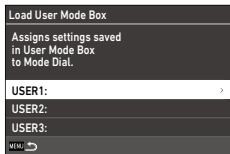

- 4** Select whether to enter a user mode name.

When [Enter Name] is selected, enter the name according to Steps 5 and 6 of "Saving the Current Settings" (p.129).

When [Cancel] is selected, proceed to the next Step.

- 5** Press **OK**.

The settings saved in the setting box are assigned to the mode dial.

Using the User Mode

1 Set the mode dial to **U1**, **U2**, or **U3** in the shooting mode.

The user mode guide appears on the shooting screen.

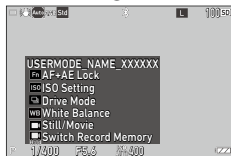

2 Change the settings as necessary.

To change the exposure mode, set [Exposure Mode] in the 2 menu.

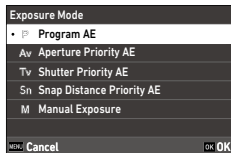



Memo



- The settings changed in Step 2 are not saved in the camera. If the mode dial is turned, the settings are reset to the saved settings. To change the settings, save the settings in [Save User Mode Box] again.
- If the settings saved in the setting box assigned to the mode dial are changed, the settings applied to the mode dial are also changed.

Customizing the Button Functions

Changing the Dial Operation for the Exposure Mode

You can save the exposure settings to be changed when , , and  are operated in each exposure mode.

1 Select [Exposure Setting] in the **C 2** menu, and then press .

The current settings assigned to , , and  are displayed on the [Exposure Setting] screen.

2 Select the exposure mode with the settings to change, and then press .

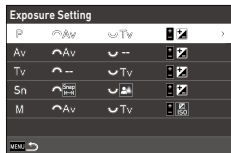

3 Select the settings to be changed when , , and are operated.

4 Press **OK**.

The setting changes are applied, and the screen in Step 2 reappears.

Registering Functions to the ADJ. Mode

You can change the settings for “ADJ. mode” of which functions can be easily used by pressing **ADJ** (.

Five functions in the following shooting functions can be registered. (The functions indicated with a square-bracketed item are the default settings for the item.)

- Off
- Focus [Setting2]
- Focus Limiter
- Snap Focus Distance
- File Format [Setting4]
- Aspect Ratio [Setting5]
- Crop
- JPEG Recorded Pixels
- AE Metering [Setting3]
- ISO Setting
- Flash Mode
- Flash Output
- Drive
- Self-timer
- White Balance
- Image Control [Setting1]
- One Push AE in M Mode
- Touch AF
- Outdoor View Setting
- Framerate

- 1** Select [ADJ Mode Setting] in the **C 2** menu, and then press **▶**.
The [ADJ Mode Setting] screen appears.

- 2** Select from [Setting1] to [Setting5], and then press **▶**.

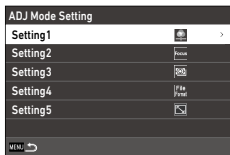

- 3** Select the function to register, and then press **OK**.

The setting changes are applied, and the screen in Step 2 reappears.

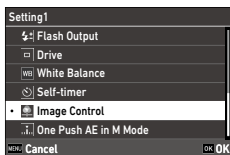

Caution -----

- The settings changed in [ADJ Mode Setting] are enabled in the **📷** mode only. For the **📷** mode, [Image Control], [Focus], [AE Metering], [Framerate], and [Outdoor View Setting] are registered and cannot be changed.

Memo -----

- Refer to "Using the ADJ. Mode" (p.24) for how to use the ADJ. mode.

Changing the Functions of the Fn Button

You can change the functions for when **Fn**, **▼**, **◀**, **▶**, or **□** is pressed. The following functions can be registered to each button. (The functions indicated with a square-bracketed item are the default settings for the item.)

- Off
- Focus
- Set MF
- Set Snap
- Set Tracking AF
- Enable AF*1 *2
- AF+AE Lock*1 *2 [Fn Button]
- AE Lock*1 *2
- Face/Eye Detection
- Focus Limiter
- Snap Focus Distance
- Switch Record Memory [Hold Movie Button]
- File Format
- JPEG → RAW
- JPEG → RAW+
- Aspect Ratio
- Crop
- JPEG Recorded Pixels
- Framerate
- Still/Movie [Movie Button]
- AE Metering
- ISO Setting [ISO Button]
- Flash Mode
- Flash Output
- ND Filter
- Drive Mode [Drive Button]
- Drive
- Continuous Shooting
- Self-timer
- White Balance [White Balance Button]
- Image Control
- Shake Reduction
- One Push AE in M Mode*1 *2
- 4-way Controller Action
- Touch AF
- Outdoor View Setting
- Enable Sleep Mode
- Airplane Mode*3
- Preview*3

*1 The operation to be performed when the button is pressed can be set.

*2 The function cannot be registered to [Movie Button] and [Hold Movie Button].

*3 The function can only be registered to [Hold Movie Button].

- 1** Select [Fn Button Setting] in the **C 2** menu, and then press **▶**.
The [Fn Button Setting] screen appears.

- 2** Select the button to change the setting of, and then press **▶**.

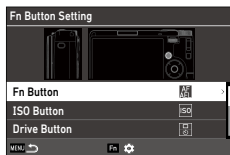

- 3** Select the function to register, and then press **OK**.

The setting changes are applied, and the screen in Step 2 reappears.

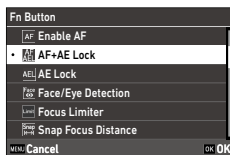

- 4** When a function requiring detailed settings is assigned, press **Fn**.

- 5** Set the operation to be performed when the button is pressed.

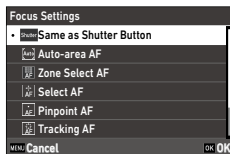

You can set the operation when one of the following functions is assigned to the button.

Enable AF AF+AE Lock	Select the button operation from [Same as Shutter Button], [Auto-area AF], [Zone Select AF], [Select AF], [Pinpoint AF], [Tracking AF], and [Continuous AF] in [Focus Settings].
AE Lock	Set the button operation for [Keep AE Lock]. When set to [On], AE lock is turned on and off each time the button is pressed. When set to [Off], AE lock is only enabled while the button is pressed. (p.54)
One Push AE in M Mode	Select the mode to adjust to correct exposure when the button is pressed in the M mode from [Program AE], [Aperture Priority AE], and [Shutter Priority AE]. (p.56)

6

Press **OK**.

The screen in Step 2 reappears.

6



Caution

- [Enable AF], [AF+AE Lock], [AE Lock], or [One Push AE in M Mode] cannot be assigned to .



Memo

- When the camera is turned on or the mode dial is turned, the current function of the button is displayed. If [Guide Display] is set to [Off] in the  2 menu, the function is not displayed.

Setting the Operation of the Shutter Release Button

You can set the operation when **SHUTTER** is pressed in the **C 2** menu.

Shutter Button Setting	Select the button operation when SHUTTER is pressed halfway from [AF+AE Lock], [AE Lock], and [Enable AF].
Shutter Btn. Confirmation	Set whether to complete the setting by pressing SHUTTER halfway when a function is set on the shooting screen such as in the ADJ. mode. This setting is also applied to when autofocus is activated using Fn . [On]: Completes the setting by pressing SHUTTER halfway. [Off]: Returns to the setting screen after SHUTTER is pressed halfway and then released.

Selecting the Settings to Save in the Camera

The functions and values set with this camera are saved even if the camera is turned off. For the following functions, you can select whether to save the settings (On) or to reset the settings to their default values (Off) when the camera is turned off.

- ISO Setting
- EV Compensation
- Program Auto Ex
- Focus
- Macro Mode
- Focus Limiter
- Focus Peaking
- AE Metering
- Flash Mode
- Flash Output
- Still/Movie
- Drive
- Self-timer
- AA Filter Simulator
- Aspect Ratio
- Crop
- White Balance
- Image Control
- ADJ Mode Setting
- Shooting Info. Display
- Playback Info. Display
- Image for Playback
- Outdoor View Setting

6

Changing the Settings

Make settings in [Memory] in the **C 2** menu.
Press **ADJ** to turn saving on or off.

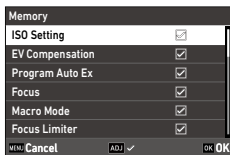

Memo

- When [Reset] is performed in the **11** menu, all [Memory] settings are reset to the default values.

Display and Sound Settings

Setting the Information Displayed During Shooting/Playback

You can set the information displayed when the display is switched using **DISP** in the shooting or playback mode.

- 1** Select **[Shooting Info. Display]** or **[Playback Info. Display]** in the **C 3** menu, and then press **▶**.

The **[Shooting Info. Display]** or **[Playback Info. Display]** screen appears.

For **[Playback Info. Display]**, proceed to Step 3.

- 2** For **[LCD Display]**, use **◀▶** to select a display mode, and then press **ADJ** to turn the display on or off.

The display can be set for the display modes **[Standard Info. Display]**, **[Simplified Info. Display]**, **[No Information Display]**, and **[Display Off]**.

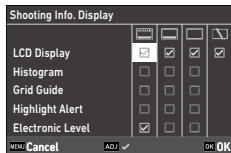

The display modes without a check mark are not displayed when **DISP** is pressed in the shooting mode. Turn on at least one display mode.

- 3** Use **▲▼◀▶** to select a display item, and then press **ADJ** to turn it on or off.

[Shooting Info. Display]

Histogram	Displays the histogram.
Grid Guide	Displays the grid guide.
Highlight Alert	Blinks areas expected to be overexposed in red during shooting.
Electronic Level	Displays the indicator for checking camera tilt.

[Playback Info. Display]

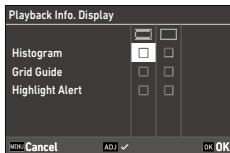

Histogram	Displays the histogram for the image.
Grid Guide	Displays the grid guide.
Highlight Alert	Blinks overexposed areas in red.

4 Press **OK**.

Setting the Instant Review Display

6

Changing the Settings

You can set the information displayed in “Instant Review” that displays the taken image immediately after shooting in [Instant Review] in the **C3** menu.

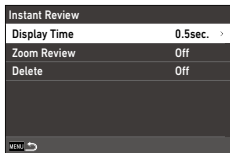

Display Time	Sets the display time of Instant Review. When set to [Hold], the image is displayed until SHUTTER is pressed halfway or another operation is performed.
Zoom Review	Allows images to be magnified by turning ⤵ to the right or pressing ADJ or the + side of ⏏ during Instant Review.
Delete	Allows images to be deleted by pressing 🗑 during Instant Review.

The initial magnification when magnifying images in Instant Review or single image display in the playback mode can be set in [Quick Zoom] in the **C3** menu. Select the magnification from [x4], [x8], [x16], and [100%].

Setting the Live View Display

You can set the following items for the Live View display in the **C** 3 menu.

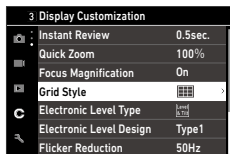

Grid Style	Sets the line type when displaying the grid guide. Select the type from [3x3 Grid] and [4x4 Grid].
Electronic Level Type	Sets whether to display the horizontal level only, or the horizontal level and tilt (vertical direction).
Electronic Level Design	[Type1]: Displays the bar at the bottom of the screen. [Type2]: Displays the scale at the bottom of the screen. [Type3]: Displays the bar in the center of the screen.
Flicker Reduction	Cuts down on the Live View screen flicker by setting the power frequency.

Setting the Brightness and Tone of the Monitor

LCD Setting

You can set [Brightness], [Saturation], [Adjust: Blue-Amber], and [Adjust: Green-Magenta] in [LCD Setting] in the **3** menu.



Outdoor View Setting

If the monitor display is difficult to see when you take images outdoors or in other situations, you can adjust the brightness of the monitor in [Outdoor View Setting] in the  3 menu.

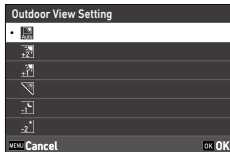

Memo

- This function can be registered to [ADJ Mode Setting] in the  2 menu. (p.134)

Setting the Lamp

You can set the lamp illumination in the  4 menu.

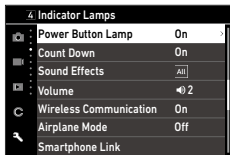

Power Button Lamp	Sets whether to turn the power button lamp on while the power of the camera is on.
Count Down	Sets whether to blink the self-timer lamp when shooting using [Self-timer] of [Drive Mode].

Setting the Sound Effects

You can set the sound effects in the  5 menu.

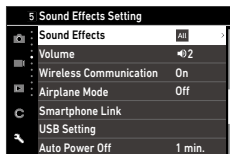

Sound Effects	[All]: Outputs the shutter sound, in-focus sound, timer countdown sound, and switching sound of turning the wireless LAN on and off. [Shutter Sound Only]: Outputs the shutter sound only.
Volume	Sets the sound volume. When set to [0], all sound effects are turned off.

Power Saving Settings

Automatically Turning the Power Off

The camera turns off automatically if no operations are performed for the set time. You can set the time until the camera turns off to [1min.], [3min.], [5min.], [10min.], [30min.], or [Off] in [Auto Power Off] in the  7 menu.

To resume operation, press the power button or .

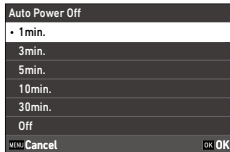

Memo

- [Auto Power Off] is not available in the following cases.
 - During movie recording or playback
 - During shooting with [Interval Shooting] or [Interval Composite] of [Drive Mode]
 - During data processing
 - During image transfer
 - While the camera is connected to a computer
 - While the camera is connected to GR WORLD

Dimming the Display

The camera dims the display automatically if no operations are performed. The following items can be set in the  7 menu.

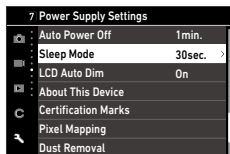

Sleep Mode	Turns the monitor off automatically if no operations are performed for the set time. The status lamp lights in the sleep mode. You can set the time until the monitor turns off to [3sec.], [10sec.], [30sec.], [1min.], [3min.], [5min.], [10min.], [30min.], or [Off].
LCD Auto Dim	Dims the display automatically if the camera is not operated for five seconds. You can set this function to [On] or [Off].

When the camera is operated, the original brightness is restored.



Memo

- When [Enable Sleep Mode] is registered to a button in [Fn Button Setting] in the **C** 2 menu (p.136), the camera enters the sleep mode immediately when the button is pressed.
- [Sleep Mode] is not available in the following cases.
 - During shooting with [Interval Shooting] or [Interval Composite] of [Drive Mode]
 - During movie recording or playback
 - While an AV device is connected to the camera
 - While the camera is connected to GR WORLD
- [LCD Auto Dim] is not available in the following cases.
 - During shooting with [Interval Shooting] or [Interval Composite] of [Drive Mode]
 - During Instant Review
 - In the playback mode
 - While an AV device is connected to the camera

File Management Settings

Specifying the Folder/File Settings

By default, files and folders are automatically named as follows.

File Name	R0000001.JPG to R0999999.JPG
Folder Name	100 to 999

When the file number exceeds R0* *9999, the next folder is created and the file number becomes R0* *0001. If the file number exceeds R0* *9999 when the folder number is 999, no more files can be stored on the memory card currently inserted.

You can change the file and folder names.

Create New Folder

When [Create New Folder] is selected in the  1 menu, a folder is created with a new number when the next image is saved.



Caution

- You cannot successively create multiple folders.





Memo

- A new folder is automatically created during shooting with [Interval Shooting] or [Interval Composite] of [Drive Mode].

Folder Name

When images are taken with the camera, a folder is automatically created and the taken images are stored in it. Each folder name consists of a sequential number from 100 to 999 and a string of five characters.

You can change the character string in the folder name.



- 1** Select [Folder Name] in the  1 menu, and then press .
The [Folder Name] screen appears.

- 2** Select [Date] or [Optional] for [Folder Name].



Date	Assigns four digits of the month and day of the shooting date after the folder number. The assigned month and day are according to the date format set in [Date Adjustment] in the  10 menu. Example) 101_0125: Images taken on January 25th
Optional	Assigns a freely defined string of five characters after the folder number. (Default: RICOH) Example) 101RICOH

When you select [Date] or do not need to change the character string, proceed to Step 6.

- 3** Press  to select [Enter Text], and then press .
The text-entry screen appears.

4 Enter a folder name.

Up to five single-byte alphanumeric characters can be entered.



The following operations are available.

▲▼◀▶	Moves the text selection cursor.
↶ / +	Moves the text selection cursor up and down.
↷	Moves the text selection cursor right and left.
OK / ADJ	Enters a character selected with the text selection cursor.

You can also use the touch screen for the operations.

5 After entering the text, move the text selection cursor to ←, and then press **OK**.

The confirmation screen appears.

6 After checking the entered name, press **OK**.

The screen in Step 2 reappears.



Memo -----

- A folder with a new number is created when the next shooting is performed after the folder name is changed.



Caution -----



- The maximum folder number is 999. If the folder name is changed or a new folder is created after the folder number reaches 999, you cannot take new images. Also, you cannot take new images when the file number reaches 9999.

File Name

One of the following character strings is used as the file name prefix for still images depending on the [Color Space] (p.91) setting in the  4 menu.

Color Space	File Name
sRGB	R0*****.JPG
AdobeRGB	_R*****.JPG

You can change the first two characters of file names from "R0".

1 Select [File Name] in the  1 menu, and then press .

The [File Name] screen appears.

2 Use   to select  or , and then use   to specify a character string.

Uppercase alphanumeric characters and "_ " can be specified.

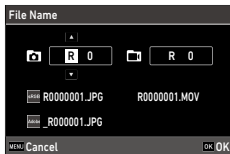

3 Press .



Memo -----

- When [Color Space] is set to [AdobeRGB], the file name prefix is "__" and the first character of the specified character string is used for the file name.

Sequential Numbering

In [Sequential Numbering] in the  1 menu, you can set whether to continue the sequential numbering for folder and file names even when a new folder is created or when the memory card is changed.

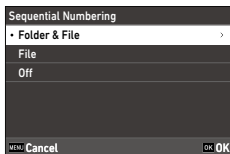

Sequential Numbering	When a new folder is created	When the memory card is changed	
	File No.	Folder Name	File No.
Folder & File	Continue	Continue	Continue
File	Continue	Reset	Continue
Off	Reset	Reset	Reset

6

Reset Numbering

When a new image is taken after [Reset Numbering] is performed in the  1 menu, a folder with a new folder number is created and the file number starts from 0001.



Memo

- When the file number reaches 9999, a new folder is created and the file number is reset.
- When a memory card is not inserted, the file number for images in the internal memory is reset.

Setting the Copyright Information

You can set the copyright information embedded in the Exif data.

- 1 Select [Copyright Information] in the 1 menu, and then press .

The [Copyright Information] screen appears.

- 2 Select [On] or [Off] in [Embed Copyright Data], and then press **OK**.

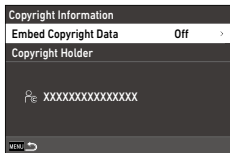

- 3 Press in [Copyright Holder].

The text-entry screen appears.

- 4 Enter the copyright holder name.

Up to 32 single-byte alphanumeric characters and symbols can be entered.

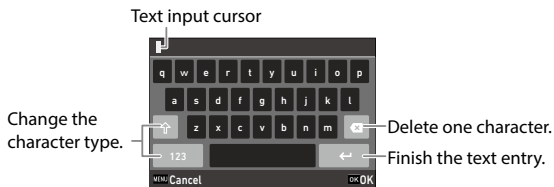

The following operations are available.

	Moves the text selection cursor.
	Moves the text selection cursor up and down.
	Moves the text selection cursor right and left.
OK / ADJ	Enters a character selected with the text selection cursor.

You can also use the touch screen for the operations.

5 After entering the text, move the text selection cursor to ←, and then press **OK**.

The confirmation screen appears.

6 After checking the entered name, press **OK**.

The screen in Step 2 reappears.



Memo -----

- You can check the Exif information in [Detailed Info. Display] (p.21) in the playback mode.

Attaching Optional Accessories

Conversion Lens/Lens Adapter

Remove the ring cap before using the wide conversion lens (GW-4) and lens adapter (GA-3).

For details on handling optional accessories, refer to the user's manual provided with each product.

Removing the Ring Cap

Turn the camera off and rotate the cap counterclockwise until it can be removed. Do not touch the converter pins (1).

For removing the lens adapter, turn it counterclockwise in the same manner.

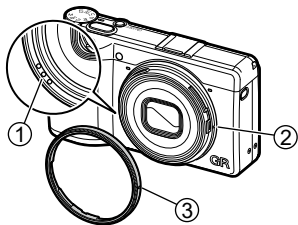

Attaching the Ring Cap

With the camera turned off, align the marking on the ring cap (3) with the marking on the camera body (2), and turn the ring cap clockwise until it clicks.



Caution

- When using a lens adapter, always use the Lens Adapter GA-3. If other adapters are used, the original optical performance of the camera is not obtained.

Troubleshooting

Power Supply



Problem	Cause	Solution	Page
The camera does not turn on.	The battery is not inserted.	Charge the battery and correctly insert it into the camera .	p.42
	The battery is exhausted.		
	The battery is not inserted in the correct orientation.		
	The battery is incompatible.	Use the dedicated rechargeable battery (DB-120).	—
	The AC adapter is not correctly connected.	Connect the AC adapter correctly.	—
The camera turns off during use.	The [Auto Power Off] function has been activated because the camera was not operated for a certain period of time.	Turn the camera back on.	p.44
	The battery is exhausted.	Charge the battery.	p.42
The camera does not turn off.	The camera is malfunctioning.	Take the battery out and insert it again.	p.40
The low battery indicator is displayed or the camera turns off even when a fully charged battery is installed.	The battery is incompatible.	Use the dedicated rechargeable battery (DB-120).	—
The battery cannot be charged.	The battery has failed.	Replace the battery with a new one.	—
	The battery is hot.	Let the battery cool down to ambient temperature.	—

Problem	Cause	Solution	Page
The battery is quickly exhausted.	Ambient temperature is very high or very low.	—	—



Shooting

Problem	Cause	Solution	Page
Shooting cannot be performed by pressing SHUTTER .	The battery is exhausted.	Charge the battery.	p.42
	The camera is turned off or not in the shooting mode.	Turn the camera on or press SHUTTER to switch the camera to the shooting mode.	p.44
	The memory card is not formatted.	Perform [Format] in the  1 menu.	p.46
	The memory card is full.	Insert a new card, or delete unwanted files.	p.103
	The memory card has reached end of its working life.	Insert a new memory card.	—
	The memory card contacts are dirty.	Clean with soft, dry cloth.	—
Images cannot be checked after shooting.	Confirmation time is too short.	Change the [Display Time] setting of [Instant Review] in the C 3 menu.	p.142

Problem	Cause	Solution	Page
The monitor is blank.	The monitor brightness is dark.	Adjust the brightness of the monitor in the  3 menu.	p.143
	The monitor is off.	Press DISP to turn the monitor on.	p.20
	An AV device is connected to the camera.	Remove the cable from the camera.	p.102
The camera is unable to focus in autofocus mode.	The lens is dirty.	Clean with soft, dry cloth.	—
	The subject is not at center of frame.	Lock the focus for shooting.	—
	The subject is not suitable for autofocus.	Lock the focus or set the focus mode to [MF] for shooting.	p.64
	The subject is too close.	Use the macro mode or move away from the subject.	p.65
Images are blurred.	The camera was moved when SHUTTER is pressed.	Hold the camera with your elbows pressed against your body, or use a tripod.	—
	When shooting in a dark place, the shutter speed slows down and images taken become easily blurred.	Use a flash, or set [ISO Setting] to a high ISO sensitivity.	p.70 p.69
The flash does not discharge.	A function preventing flash operation is selected.	Check the settings and mode.	—
The flash does not illuminate the subject.	The subject is dark.	Adjust the flash exposure.	p.71
	Flash output is not appropriate.		



Problem	Cause	Solution	Page
Images are too bright.	Flash output is not appropriate.	Adjust the flash exposure, move away from the subject, or use a different light source.	p.71
	The monitor brightness is not appropriate.	Adjust the brightness of the monitor in the  3 menu.	p.143
Images are too dark.	The monitor brightness is not appropriate.	Adjust the brightness of the monitor in the  3 menu.	p.143
	The exposure compensation is set to a negative value.	Change the exposure compensation value.	p.53
The colors of images are unnatural.	The camera is unable to adjust white balance for shooting conditions using auto white balance.	Include a white object with the subject or select the settings other than [Auto White Balance] for [White Balance].	p.75
The monitor brightness changes during autofocus.	Ambient lighting is poor or differs from that used for autofocus.	This is normal and does not indicate a malfunction.	—
Electronic level indicators are not displayed.	Electronic level indicators are hidden.	Check the [Shooting Info. Display] setting in the  3 menu.	p.141
The image is not level although level indicator showed that the camera was level.	The camera was moving during shooting because you were on a moving object or due to other causes.	Do not move the camera during shooting.	—
	The subject is not level.	Check the subject.	—

Playback/Deletion

Problem	Cause	Solution	Page
Shooting information is not displayed.	Information display is set to [No Information Display].	Press DISP to switch the information displayed on the screen.	p.20
Dust or dirt particles appear in images.	The sensor is dirty or dusty.	Perform [Dust Removal] in the  9 menu. The Dust Removal function can be set to be performed every time the camera is turned on and off.	—
Pixel defects such as bright spots and dark spots appear in the image.	There are defective pixels in the sensor.	Perform [Pixel Mapping] in the  9 menu. It takes about 30 seconds to correct the defective pixels, so be sure to install a fully charged battery.	—
Images are not displayed on an AV device.	The cable is not correctly connected.	Follow the correct procedure to connect the cable.	p.102
	The input setting of the AV device is incorrect.	Check the AV device settings.	—
The images on the memory card cannot be played back.	The inserted memory card is not formatted with this camera.	Insert a memory card formatted using [Format] in the  1 menu of this camera.	p.46
Images are not displayed on the monitor.	The memory card contacts are dirty.	Clean with soft, dry cloth.	—
	The card is malfunctioning.	There is not problem with the camera if images in another memory card can be played back with this camera. Do not use a memory card that has a problem.	—



Problem	Cause	Solution	Page
The monitor turned off.	The battery is exhausted.	Charge the battery.	p.42
	The [Auto Power Off] function has been activated because the camera was not operated for a certain period of time.	Turn the camera back on.	p.44
File(s) cannot be deleted.	[Protect] is set for the image(s).	Cancel the protection with [Protect] in the  2 menu.	p.105

Others

Problem	Cause	Solution	Page
The memory card cannot be inserted.	The card is not in the correct orientation.	Insert the memory card in the correct orientation.	p.40
Camera controls have no effect.	The battery is exhausted.	Charge the battery.	p.42
	The camera is malfunctioning.	Turn the camera off and back on.	p.44
		Take the battery out and insert it again. When the AC adapter is used, reconnect it.	p.40
Date is not set correctly.	Date and time are not set correctly.	Set date and time correctly in the  10 menu.	p.45
The date setting has been reset.	The battery was removed.	If the battery is removed for more than about five days, the date setting will be lost. Set date and time correctly in the  10 menu.	p.45

Error Messages

Error Message	Description
Memory card full.	The memory card is full and no more images can be saved. Insert a new memory card or delete unwanted files. (p.103)
Internal memory full.	The internal memory is full and no more images can be saved. Insert a memory card or delete unwanted files. (p.103)
No image.	There are no images that can be played back in the memory card and internal memory.
No card in the camera.	There is no memory card inserted in the camera.
Memory card error.	The memory card has a problem, and shooting and playback are impossible. You may be able to play back the images with a computer.
Internal memory error.	The internal memory has a problem. Format the internal memory. (p.46)
Card is not formatted.	The memory card you have inserted is unformatted or has been previously used on another device and is not compatible with this camera. Use the card after formatting it with this camera. (p.46)
Cannot use this card.	A memory card not compatible with this camera is inserted.
Unable to store image.	The memory card or internal memory has a problem, and the image cannot be saved.
Image folder cannot be created.	The maximum folder number (999) is being used, and no more images can be saved. Insert a new memory card or format the memory card or internal memory. (p.46)
This image cannot be displayed.	You are trying to play back an image in a format not supported by this camera. You may be able to play back the images with a computer.

Error Message	Description
This image cannot be magnified.	You are trying to magnify an image that cannot be magnified.
This image cannot be processed.	This message appears when you try to perform a function in the  3 menu for the images shot using other cameras, or [Resize] or [Cropping] for the minimum file-size images.
This function cannot process multiple images as a batch.	Process each image one by one.
This function is not available in the current mode.	Set the function after switching to the  mode. Alternatively, set [Airplane Mode] to [Off] in the  6 menu.
This function is not available except in User Mode.	Set the function after setting the mode dial to U1 , U2 , or U3 .
The camera will turn off to prevent damage from overheating.	The camera will turn off because its internal temperature is too high. Leave the camera turned off until it cools down before turning on the camera again.
Update failed.	The update could not be performed correctly. Turn the camera off and back on, and then perform the update again.
Unable to update firmware. There is a problem with the firmware update file.	There is a problem with the firmware update file. Download the update file again, and then perform the update.
Insufficient battery power remaining to activate Pixel Mapping.	These messages appear if you try to perform each function when the battery level is insufficient. Install a fully charged battery.
Insufficient battery power remaining to update the firmware.	
Insufficient battery power remaining to reset to factory defaults.	

Error Message	Description
Pairing failed. Check Action Mode.	Bluetooth® pairing failed. Check the settings. (p.125)
Pairing failed. Check Airplane Mode.	
Pairing failed because the camera is currently connected via USB.	

Main Specifications

Camera

Lens	Lens Construction	7 elements in 5 groups (3 aspherical lens elements)
	Focal Length and Aperture	18.3 mm (approx. 28 mm in 35 mm equivalent focal length); F2.8 to F16
Image Capture Unit	Image Sensor	Type: Primary color filter, CMOS Size: 23.3 mm × 15.5 mm
	Effective Pixels	Approx. 25.74 megapixels
	Sensitivity (Standard Output)	ISO 100 to ISO 204800: Auto (ISO Auto Lower/Upper Limit and Minimum Shutter Speed can be set), Manual
	Image Stabilization	Sensor-shift shake reduction "SR" (5-axis)
	AA Filter Simulator	Moiré reduction using the SR unit (Off, Low, High)
	Dust Removal	Image sensor cleaning using ultrasonic vibrations "DR II"

File Formats	Still Image	<p>File Format: RAW (DNG) 14bit, JPEG (Exif 2.3 compliant), DCF 2.0 compliant Color Space: sRGB, AdobeRGB Recorded Pixels:</p> <p>[3:2] L (26M: 6192 × 4128) M (16M: 4944 × 3296) S (8.2M: 3504 × 2336) XS (2.5M: 1920 × 1280)</p> <p>[4:3] L (23M: 5504 × 4128) M (15M: 4400 × 3296) S (7.3M: 3120 × 2336) XS (2.8M: 1920 × 1440)</p> <p>[1:1] L (17M: 4128 × 4128) M (11M: 3296 × 3296) S (5.5M: 2336 × 2336) XS (1.6M: 1280 × 1280)</p> <p>[16:9] L (22M: 6192 × 3480) M (14M: 4944 × 2784) S (6.9M: 3504 × 1968) XS (2.1M: 1920 × 1080)</p>
	Movie	<p>File Format: MPEG4 AVC/H.264 (MOV) Recorded Pixels: Full HD (1920 × 1080, 60p/30p/24p) Sound Recording: Built-in stereo microphone Recording Time: Up to 4 GB or 25 minutes; automatically stops recording if the internal temperature of the camera becomes high</p>
	Storage Medium	<p>Internal memory (approx. 53 GB), microSD/microSDHC/microSDXC memory card (microSDHC memory card and microSDXC memory card conform to UHS-I standards)</p>

Focus	Type	Hybrid AF (image plane phase-matching detection and contrast detection)
	Focus Mode	Auto-area AF, Zone Select AF, Select AF, Pinpoint AF, Tracking AF, Continuous AF, MF, Snap (0.3 m, 1 m, 1.5 m, 2 m, 2.5 m, 3.5 m, 5 m, ∞), ∞
	Focus Limiter	Near Side, Far Side, Off
	Full Press Snap	Shooting by focusing at the Snap distance with a single press of the shutter release button or a touch on the monitor
	Face/Eye Detection	On, Use only in Auto-area AF, Off
	Focus Range (from lens face)	Normal mode: Approx. 0.1 m to ∞ Macro mode: Approx. 0.06 to 0.15 m
Exposure Control	Exposure Mode	Program AE, Aperture Priority AE, Shutter Priority AE, Snap Distance Priority AE, Manual Exposure
	Metering Mode	Multi-segment metering, Center-weighted metering, Spot metering, Highlight-weighted metering
	Shutter Speed	1/4000 to 30 sec. (limit by aperture — F2.8: up to 1/2500 sec., F5.6 or higher: up to 1/4000 sec.), Timed exposure (10 sec. to 20 min.), Bulb, Time
	Exposure Compensation	Still image: ± 5 EV, 1/3 EV steps Movie: ± 2 EV, 1/3 EV steps
	ND Filter (2 EV)	Auto, On, Off
White Balance		Auto White Balance, Auto WB (Warmth Pri.), Auto WB (White Pri.), Daylight, Shade, Cloudy, Fl. - Daylight Color, Fl. - Daylight White, Fl. - Cool White, Fl. - Warm White, Tungsten, CTE, Manual White Balance, Color Temperature, Custom 1, Custom 2, Custom 3
	Fine Adjustment	Adjustable ± 14 steps on A-B axis or G-M axis

Drive Mode	Drive	Single Frame Shooting, Continuous Shooting, Bracketing, Multi-exposure, Interval Shooting, Interval Composite
	Self-timer	10 sec., 2 sec., Off
Shooting Functions	Crop	Off, 35mm, 50mm
	Image Control	Standard, Vivid, Monotone, Soft Monotone, Hard Monotone, Hi-Contrast B&W, Negative Film, Positive Film, Cinema (Yellow), Cinema (Green), Cross Processing, Bleach Bypass, Retro, HDR Tone, Custom 1, Custom 2, Custom 3 Adjustment parameters: Saturation, Hue, High/Low Key Adjustment, Contrast, Contrast (Highlight), Contrast (Shadow), Sharpness, Shading, Clarity, Toning, Filter Effect, Grain Effect, HDR Tone Level, Color Tone * Adjustable parameters vary depending on the selected image setting.
	Dynamic Range Correction	Highlight Correction, Shadow Correction
	Noise Reduction	Slow Shutter Speed Noise Reduction, High-ISO Noise Reduction
	Horizon Correction	SR On: Correction up to 1 degree SR Off: Correction up to 1.5 degrees
	Display	Display magnification (4x, 16x), Grid Guide (3x3 Grid, 4x4 Grid), Histogram, Highlight Alert, Electronic Level

Playback Functions	Playback View	Single image display, Multi-image display (20 images, 48 images), Display magnification (up to 16x; 100% view and Quick Zoom view available), Histogram (Y histogram, RGB histogram), Grid Guide (3x3 Grid, 4x4 Grid), Highlight Alert, Auto Image Rotation, Folder display, Calendar filmstrip display
	Base Parameter Adjustment	Normal editing, Monotone editing Adjustment parameters: Brightness, Saturation, Filter Effect, Hue, Toning, Contrast, Sharpness * Adjustable parameters vary depending on the selected edit setting.
	RAW Development	RAW image selection options: Single image, Multiple images, Images in the selected folder, Images on the selected shooting date RAW development parameters: JPEG Recorded Pixels, Aspect Ratio, Color Space, White Balance, Image Control, Peripheral Illumination Correction, Sensitivity, High-ISO Noise Reduction, Shadow Correction
	Edit	Delete, Protect, Image Rotation, Image Copy, File Transfer, Resize, Cropping (aspect ratio and slant adjustments available), Levels Adjustment, White Balance Adjustment, Color Moiré Correction, Movie Edit (Cut, Divide), Save movie frame as JPEG image
LCD Monitor	Type	3.0-inch wide viewing angle TFT color LCD (aspect ratio: 3:2) with air-gapless tempered glass, Approx. 1037K dots
	Touch Screen	Capacitive sensing type
	Adjustments	Brightness, Saturation, Blue/Amber, Green/Magenta, Outdoor View Setting (Auto, Manual (± 2 steps))

Wireless LAN Communication	Standards	2.4 GHz: IEEE802.11 b/g/n/ax 5.2 GHz: IEEE802.11 a/n/ac/ax (not available in some regions) 5.8 GHz: IEEE802.11 a/n/ac/ax (not available in some regions)
	Operating Frequency Band Range	2.4 GHz: 2400 to 2483.5 MHz 5.2 GHz: 5150 to 5250 MHz (not available in some regions) 5.8 GHz: 5725 to 5850 MHz (not available in some regions)
	Bandwidth	2.4 GHz: 20 MHz 5.2 GHz: 20/40/80 MHz 5.8 GHz: 20/40/80 MHz
	Security	Authentication: WPA2™, WPA3™ Encryption: AES
Bluetooth® Communication	Standards	Bluetooth® v5.3 (Bluetooth Low Energy)
	Operating Frequency Band Range	2400 to 2483.5 MHz
Interfaces	USB Type-C	Battery recharge/Power supply (when using an optional AC adapter), Data transfer (MTP), Video output (DisplayPort™ over USB-C (DisplayPort Alternative Mode))
	Hot Shoe	Compatible with dedicated flashes Flash Mode: Flash On, Flash On+Red-eye, Slow-speed Sync, Slow Sync+Red-eye Flash Output: Auto, 1/1, 1/4
	Lens Adapter Pin	Available

Power Supply	Battery Type	Rechargeable Battery DB-120
	AC Adapter	AC adapter compatible with USB Power Delivery, AC adapter (K-AC166; optional) <ul style="list-style-type: none">• The camera is compatible with USB Power Delivery, but is not certified with the USB Implementers Forum logo.
	Battery Life	Number of recordable images: Approx. 250 images <ul style="list-style-type: none">• This is according to the result of testing in compliance with CIPA standard using a fully charged rechargeable battery at a temperature of 23°C (73°F). Actual results may vary depending on the shooting conditions/circumstances. Playback time: Approx. 240 min. <ul style="list-style-type: none">• This is according to the result of RICOH in-house testing. Actual results may vary depending on the shooting conditions/circumstances.
Dimensions and Weight	Dimensions	Approx. 109.4 mm (W) × 61.1 mm (H) × 32.7 mm (D) (4.3 in. (W) × 2.4 in. (H) × 1.3 in. (D)) (excluding operating controls and protrusions)
	Weight	Approx. 262 g (9.2 oz) (including the dedicated battery and microSD memory card) Approx. 228 g (8 oz) (body only)
Included Accessories	Rechargeable Battery DB-120, USB Cable I-USB198, Hand strap O-ST198	
Language	English, French, German, Spanish, Portuguese, Italian, Dutch, Danish, Swedish, Finnish, Polish, Czech, Hungarian, Turkish, Greek, Russian, Thai, Korean, Traditional Chinese, Simplified Chinese, Japanese	

Rechargeable Battery DB-120

Nominal Voltage	3.85 V
Rated Capacity	1800 mAh, 6.93 Wh
Operating Temperature	0 to 40°C (32 to 104°F)
Storage Temperature	-20 to 45°C (-4 to 113°F)
Dimensions	40.9 mm (W) × 35.4 mm (H) × 10.75 mm (D) (1.6 in. (W) × 1.4 in. (H) × 0.4 in. (D))
Weight	Approx. 33 g (1.2 oz)

Image Storage Capacity

The following table shows the approximate number of images and recording time (in seconds) of movies that can be saved in the internal memory and a memory card in various formats.

Still Image

File Format/ JPEG Record- ed Pixels	Aspect Ratio	Focal Length ¹	Number of Recorded Pixels	Internal Memory 53 GB	Memory Card 64 GB
L	3:2	—	26M: 6192 × 4128	3,498	3,929
	4:3	—	23M: 5504 × 4128	3,943	4,429
	1:1	—	17M: 4128 × 4128	5,226	5,870
	16:9	—	22M: 6192 × 3480	4,131	4,640
M	3:2	—	16M: 4944 × 3296	5,422	6,090
	4:3	—	15M: 4400 × 3296	6,110	6,862
	1:1	—	11M: 3296 × 3296	8,033	9,022
	16:9	—	14M: 4944 × 2784	6,475	7,272
S	3:2	—	8.2M: 3504 × 2336	10,581	11,883
	4:3	—	7.3M: 3120 × 2336	12,050	13,534
	1:1	—	5.5M: 2336 × 2336	15,494	17,401
	16:9	—	6.9M: 3504 × 1968	12,395	13,921
XS	3:2	—	2.5M: 1920 × 1280	33,371	37,479
	4:3	—	2.8M: 1920 × 1440	28,922	32,482
	1:1	—	1.6M: 1280 × 1280	48,203	54,137
	16:9	—	2.1M: 1920 × 1080	39,439	44,294

File Format/ JPEG Record- ed Pixels	Aspect Ratio	Focal Length ^{*1}	Number of Recorded Pixels	Internal Memory 53 GB	Memory Card 64 GB	
RAW	3:2	28 mm	26M: 6192 × 4128	995	1,117	
		35 mm	16M: 4944 × 3296	1,018	1,143	
		50 mm	8.2M: 3504 × 2336	1,037	1,165	
	4:3	28 mm	23M: 5504 × 4128	1,001	1,125	
		35 mm	15M: 4400 × 3296	1,023	1,149	
		50 mm	7.3M: 3120 × 2336	1,040	1,168	
	1:1	28 mm	17M: 4128 × 4128	1,016	1,141	
		35 mm	11M: 3296 × 3296	1,030	1,157	
		50 mm	5.5M: 2336 × 2336	1,045	1,174	
	16:9	28 mm	22M: 6192 × 3480	1,004	1,127	
		35 mm	14M: 4944 × 2784	1,023	1,149	
		50 mm	6.9M: 3504 × 1968	1,042	1,171	
	RAW+	3:2	28 mm	26M: 6192 × 4128	774	870
			35 mm	16M: 4944 × 3296	859	964
			50 mm	8.2M: 3504 × 2336	947	1,063
4:3		28 mm	23M: 5504 × 4128	798	897	
		35 mm	15M: 4400 × 3296	876	984	
		50 mm	7.3M: 3120 × 2336	957	1,075	
1:1		28 mm	17M: 4128 × 4128	850	955	
		35 mm	11M: 3296 × 3296	915	1,027	
		50 mm	5.5M: 2336 × 2336	981	1,102	
16:9		28 mm	22M: 6192 × 3480	809	909	
		35 mm	14M: 4944 × 2784	883	992	
		50 mm	6.9M: 3504 × 1968	961	1,080	

*1 35 mm equivalent focal length

Movie

Recorded Pixels	Aspect Ratio	Framerate	Number of Recorded Pixels	Internal Memory 53 GB	Memory Card 64 GB
Full HD	16:9	60p	1920 × 1080	1:26'56"	1:37'38"
		30p		2:50'51"	3:11'53"
		24p		3:31'44"	3:57'48"



Memo

- The figures for movies are the total length that can be recorded. The maximum recording time per shooting is 25 minutes or the equivalent of 4 GB.
- The number of images that can be shot may differ from the number of storable images displayed on the monitor.
- The storage capacity varies depending on the shooting conditions and the capacity of the memory.

Operating Environment

The USB connection between the camera and a computer has been confirmed to work with the following OSs.

Windows®	Windows® 11, Windows® 10
Mac	macOS 14 Sonoma, macOS 13 Ventura, macOS 12 Monterey, macOS 11 Big Sur

Using the Camera Abroad

For conditions of use and important points to note when using the camera overseas, check the product page and FAQ on the RICOH IMAGING website.

Precautions for Use

Camera

- Do not drop the camera or subject it to physical shocks.
- When carrying the camera, be careful that it does not strike other objects. Particular care is required to protect the lens and monitor.
- Battery may become hot with extended use. Wait for the battery to cool before removing it from the camera.
- The monitor may be difficult to read in direct sunlight.
- You may notice that monitor varies in brightness or contains pixels that do not light or that are always lit. This is common to all LCD monitors and does not indicate a malfunction.
- Do not apply force to the monitor.
- Abrupt changes in temperature may cause condensation, resulting in visible condensation inside the lens or camera malfunction. This can be avoided by placing the camera in a plastic bag to slow the temperature change, and removing it only after the air in the bag has reached the same temperature of its surroundings.
- To prevent damage to the camera, do not insert objects into the holes in the microphone and speaker coverings.
- Do not allow the camera to get wet. In addition, do not operate it with wet hands. Failure to observe this precaution could result in camera malfunction or electric shock.
- Take a test shot to ensure that the camera is functioning properly before using it on important occasions such as travel or weddings. We recommend that you keep this manual and spare batteries at hand.



Conditions that May Cause Condensation-----

- If you move to an area with a sharply different temperature
- If humidity is high
- In a cold room after the heater has come on, or where the camera is exposed to cold air from an air conditioner or other device

Rechargeable Battery DB-120

- This is a lithium-ion battery.
- The battery is not fully charged at the time of purchase, so be sure to charge the battery before use.
- Do not open or damage the battery as this can result in fire or injury. In addition, do not heat the battery above 60°C (140°F) or expose the battery to fire.
- Due to the battery characteristics, the battery usage time may be shortened when used in a cold environment, even if the battery is fully charged. Keep the battery warm by placing it in a pocket or have a backup battery ready.
- When not in use, be sure to remove the battery from the camera or battery charger. A small amount of current can leak from the battery even when the power is off, creating excessive discharge and making the battery unusable. If the battery is removed for more than five days, the date and time settings will be lost. In this case, reset the date and time.
- If the battery is not used for a long time, charge the battery for 15 minutes once a year before storing.
- Store the battery in a dry, cool place with an ambient temperature between 15°C and 25°C (59°F and 77°F). Avoid storing in extreme high or low temperatures.
- After charging the battery, do not immediately charge it again.
- Charge the battery at an ambient temperature between 10°C and 40°C (50°F and 104°F). Charging the battery at a high temperature can deteriorate the battery. Charging at a low temperature may prevent full charging.
- If the battery usage time becomes very short even when fully charged, the battery has reached the end of its service life. Replace it with a new battery. Be sure to use a replacement battery recommended by RICOH IMAGING.
- The recharge time with the provided USB cable (I-USB198) is approx. 2 hours (at 25°C (77°F)).



Caution

- Use of other batteries can cause explosion.
- Recycle used batteries in a recycle box at your local electronics store or supermarket.

Camera Care and Storage

Caring for the Camera

- Image quality can be affected by fingerprints and other foreign matter on the lens. Avoid touching the lens with your fingers.
- Remove dust or lint on the lens with a commercially available blower, or gently clean the lens with a soft, dry cloth.
- Clean the camera thoroughly after using it at the beach or handling chemicals.
- In the unlikely event of malfunction, consult your nearest service center or dealer.
- The camera contains high-voltage circuits. Do not disassemble it.
- Do not expose the camera to volatile substances such as thinner, benzene, or pesticides. Failure to observe this precaution could result in damage to the camera or its coatings.
- The monitor is easily scratched, avoid touching it with hard objects.
- Clean the monitor by wiping it with a soft cloth dampened with a small amount of any monitor cleaner that does not contain organic solvents.

Storage

- Do not store the camera where it will be exposed to:
 - Extreme heat or humidity, large changes in temperature or humidity
 - Dust, dirt, sand
 - Severe vibration
 - Prolonged contact with chemicals including pesticides, or with vinyl or rubber products
 - Strong magnetic fields (for example, in the vicinity of a monitor, transformer, or magnet)
- Remove the battery if the camera is left unused for a long period of time.

Before Cleaning

- Be sure to turn the camera off.
- Remove the battery and AC adapter from the camera.

Warranty Policy

All our cameras purchased through authorized bona fide photographic distribution channels are guaranteed against defects of material or workmanship for a period of twelve months from the date of your purchase. Service will be rendered, and defective parts will be replaced without cost to you within that period, provided the camera does not show evidence of impact, sand or liquid damage, mishandling, tampering, battery or chemical corrosion, operation contrary to operating instructions, or modification by an unauthorized repair shop. The manufacturer or its authorized representatives shall not be liable for any repair or alterations except those made with its written consent and shall not be liable for damages from delay or loss of use or from other indirect or consequential damages of any kind, whether caused by defective material or workmanship or otherwise; and it is expressly agreed that the liability of the manufacturer or its representatives under all guarantees or warranties, whether expressed or implied, is strictly limited to the replacement of parts as hereinbefore provided. No refunds will be made on repairs by non-authorized service facilities.

Procedure During 12-month Warranty Period

Any camera which proves defective during the 12-month warranty period should be returned to the dealer from whom you purchased the camera or to the manufacturer. If there are no representatives of the manufacturer in your country, send the camera to the manufacturer, with postage prepaid. In this case, it will take a considerable length of time before the camera can be returned to you owing to the complicated customs procedures required. If the camera is covered by warranty, repairs will be made and parts replaced free of charge, and the camera will be returned to you upon completion of servicing. If the camera is not covered by warranty, regular charges of the manufacturer or of its representatives will apply. Shipping charges are to be borne by the owner. If your camera was purchased outside of the country where you wish to have it serviced during the warranty period, regular handling and servicing fees may be charged by the manufacturer's representatives in that country. Notwithstanding this, your camera returned to the manufacturer will be serviced free of charge according to this procedure and warranty policy. In any case, however, shipping charges and customs clearance fees to be borne by the sender. To prove the date of your purchase when required, please keep the receipt or bills covering the purchase of your camera for at least a year. Before sending your camera for servicing, please make sure that you are sending it to the manufacturer's authorized representatives or their approved repair shops, unless you are sending it directly to the manufacturer. Always obtain a quotation for the service charge, and only after you accept the quoted service charge, instruct the service station to proceed with the servicing.

- **This warranty policy does not affect the customer's statutory rights.**
- **The local warranty policies available from our distributors in some countries can supersede this warranty policy. Therefore, we recommend that you review the warranty card supplied with your product at the time of purchase, or contact our distributor in your country for more information and to receive a copy of the warranty policy.**

Conditions of RICOH IMAGING North America Warranty

1. RICOH IMAGING products originally distributed by RICOH IMAGING AMERICAS CORPORATION and RICOH IMAGING CANADA and purchased through our authorized distribution channels, are warranted by RICOH IMAGING AMERICAS CORPORATION and RICOH IMAGING CANADA to the original retail purchaser for a period of one year from date of purchase against defects in material and/or workmanship.
2. This warranty is limited to repair of defects in material and/or workmanship. These repairs will be made at no charge to the customer. However, all charges related to shipping the product to the service center are the responsibility of the owner. (Note: RICOH IMAGING AMERICAS CORPORATION and RICOH IMAGING CANADA will not assume the responsibility for damages or loss encountered in transit to the service center but will assist in processing any claims whenever possible.)
3. This warranty does not cover finishes or batteries, nor does it cover damages resulting from accident, misuse, abuse, dirt, water, sand, battery leakage, tampering, servicing performed or attempted by unauthorized service agencies. This warranty is valid only in the country where this product is purchased. Routine cleaning and normal cosmetic and mechanical wear are not covered under the terms of this warranty. RICOH IMAGING AMERICAS CORPORATION and RICOH IMAGING CANADA shall not be liable for any consequential or incidental damages resulting from any breach of warranty, express or implied, applicable to this product.
4. Please be sure to keep your original or a copy of your proof of purchase receipt (bill of sale), to obtain warranty service during the warranty period. The dated proof of purchase receipt (bill of sale) must be provided to ensure warranty status. If the dated proof of purchase receipt (bill of sale) is not received with the product, a repair estimate will be issued.

Some states do not allow limitations on how long an implied warranty lasts, so the above limitations may not apply to you. Some states do not allow the exclusion or limitation of incidental or consequential damages, so the above limitations may not apply to you. This warranty gives you specific rights and you may have other legal rights which vary from state to state. This warranty policy does not affect the consumer's statutory rights.

Register your product:

USA: <https://us.ricoh-imaging.com/register-product/>

CAN: <https://www.ricoh-imaging.ca/register-your-ricoh-imaging-product/>

For service-related inquiries:

USA: <https://us.ricoh-imaging.com/repairs/>

CAN: <https://www.ricoh-imaging.ca/support/repairs/>

For technical support:

USA: <https://us.ricoh-imaging.com/online-support/>

Tel: 1-800-234-0276

CAN: <https://www.ricoh-imaging.ca/support/digital-support/>

Tel: 1-800-224-6767

Conditions de garantie RICOH IMAGING en Amérique du Nord

1. Les produits RICOH IMAGING distribués à l'origine par RICOH IMAGING AMERICAS CORPORATION et RICOH IMAGING CANADA et achetés par l'entremise de nos réseaux de distribution dûment agréés sont garantis par RICOH IMAGING AMERICAS CORPORATION et RICOH IMAGING CANADA contre tout défaut de fabrication et de main-d'œuvre pendant un an à partir de la date d'achat initiale pour l'acheteur original.
2. Cette garantie se limite aux réparations des défauts de fabrication et de main-d'œuvre. Ces réparations seront effectuées sans frais pour le client. Cependant, tous les frais reliés à l'envoi du produit dans un Centre de service seront à la charge de l'utilisateur. (Nota : RICOH IMAGING AMERICAS CORPORATION et RICOH IMAGING CANADA n'assumeront aucune responsabilité pour les dommages ou perte pouvant survenir lors du transport, mais assistera dans le traitement de toute réclamation dans la mesure du possible.)
3. Cette garantie ne couvre pas le fini ni les piles, et ne couvre pas non plus les dommages résultant d'un accident, d'une utilisation inappropriée ou abusive ainsi que de la poussière, eau, écoulement des piles, modifications ou réparations réalisées ou tentées par une agence de réparation non agréée. Cette garantie n'est valable que dans le pays où le produit a été acheté. Le nettoyage de routine et l'usure mécanique et esthétique ne sont pas couverts par cette garantie. RICOH IMAGING AMERICAS CORPORATION et RICOH IMAGING CANADA ne peuvent être tenues responsables des dommages accidentels, indirects et consécutifs résultant d'un manquement à une condition de la garantie, expresse ou implicite, applicable à ce produit.
4. Conservez votre bon d'achat original (facture de vente datée) ou une , copie afin de fournir lors d'une demande de réparation pendant la période de garantie. Votre bon d'achat doit être fournie pour assurer l'état de la garantie. Si votre bon d'achat n'est pas reçue avec le produit, un devis de réparation sera émis.

Certains pays, états ne permettent pas de limiter la durée d'une garantie implicite, donc les limitations citées ci-dessus peuvent ne pas s'appliquer à vous. De même, certains pays, états permettent pas l'exclusion ou la limitation des dommages accidentels ou consécutifs, en conséquence, les limitations peuvent ne pas s'appliquer à vous. Cette garantie vous donne des droits spécifiques et vous pouvez avoir d'autres droits selon la juridiction en vigueur dans votre région. Cette garantie ne peut diminuer les droits juridiques du consommateur.

Renseignement relatif au service :

<https://www.ricoh-imaging.ca/fr/service-et-solution/repairs/>

Soutien technique :

<https://www.ricoh-imaging.ca/fr/service-et-solution/soutien-technique/>

Regulatory Compliance Statements

For Customers in USA

STATEMENT OF FCC COMPLIANCE

Supplier's Declaration of Conformity 47 CFR § 2.1077 Compliance Information

Product Name: RICOH GR IV

Model: R09010

This device complies with Part 15 of the FCC Rules. Operation is subject to the following two conditions: (1) This device may not cause harmful interference, and (2) this device must accept any interference received, including interference that may cause undesired operation.

Responsible party: RICOH IMAGING AMERICAS CORPORATION

Address: 2 Gatehall Drive Suite 204, Parsippany, New Jersey 07054, U.S.A.

Phone: 800-877-0155

CAUTION:

Any changes or modifications not expressly approved by the party responsible for compliance could void the user's authority to operate the equipment.

FCC Part 15 Subpart B Class B

This equipment has been tested and found to comply with the limits for a Class B digital device, pursuant to part 15 of the FCC Rules. These limits are designed to provide reasonable protection against harmful interference in a residential installation. This equipment generates, uses and can radiate radio frequency energy and, if not installed and used in accordance with the instructions, may cause harmful interference to radio communications. However, there is no guarantee that interference will not occur in a particular installation. If this equipment does cause harmful interference to radio or television reception, which can be determined by turning the equipment off and on, the user is encouraged to try to correct the interference by one or more of the following measures:

- Reorient or relocate the receiving antenna.
- Increase the separation between the equipment and receiver.
- Connect the equipment into an outlet on a circuit different from that to which the receiver is connected.
- Consult the dealer or an experienced radio/TV technician for help.

FCC Part 15 Subpart E

Compliance with FCC requirement 15.407(c)

Data transmission is always initiated by software, which is passed down through the MAC, through the digital and analog baseband, and finally to the RF chip. Several special packets are initiated by the MAC. These are the only ways the digital baseband portion will turn on the RF transmitter, which it then turns off at the end of the packet. Therefore, the transmitter will be on only while one of the aforementioned packets is being transmitted. In other words, this device automatically discontinues transmission in case of either absence of information to transmit or operational failure.

Frequency tolerance (2.4 GHz band): 25 ppm

Frequency tolerance (5 GHz band): 20 ppm

RF Exposure Warning

This device meets the government's requirements for exposure to radio waves. This device is designed and manufactured not to exceed the emission limits for exposure to radio frequency (RF) energy set by the Federal Communications Commission of the U.S. Government.

The exposure standard employs a unit of measurement known as the Specific Absorption Rate, or SAR. The SAR limit set by the FCC is 1.6 W/kg. Tests for SAR are conducted using standard operating positions accepted by the FCC with the EUT transmitting at the specified power level in different channels.

The FCC has granted an Equipment Authorization for this device with all reported SAR levels evaluated as in compliance with the FCC RF exposure guidelines. SAR information on this device is on file with the FCC and can be found under the Display Grant section of <https://apps.fcc.gov/oetcf/eas/reports/GenericSearch.cfm> after searching on FCC ID: 2ACZ5-R09010.

Safety Standard for Button Cell or Coin Batteries and Consumer Products Containing Such Batteries

This product contains a non-replaceable button cell or coin battery.

Do not replace the button cell or coin battery. This can cause a fire or electric shock.

WARNING

- **INGESTION HAZARD:** This product contains a button cell or coin battery.
- **DEATH** or serious injury can occur if ingested.
- A swallowed button cell or coin battery can cause **Internal Chemical Burns** in as little as **2 hours**.
- **KEEP** new and used batteries **OUT OF REACH of CHILDREN**.
- **Seek immediate medical attention** if a battery is suspected to be swallowed or inserted inside any part of the body.



- a) Immediately dispose of used battery according to local regulations and keep it away from children. Do NOT dispose of the battery in household trash or incinerate.
- b) Even a used battery may cause severe injury or death.
- c) Call a local poison control center for treatment information.
- d) Battery type: ML414H IV01E
- e) Nominal battery voltage: 3 V
- f) A non-rechargeable battery is not to be recharged.
- g) Do not force discharge, recharge, disassemble, heat above manufacturer's specified temperature rating, or incinerate the battery. Doing so may result in injury due to venting, leakage, or explosion, resulting in chemical burns.

General Certificate of Conformity

PRODUCT MODEL	MODEL: R09010 TYPE: DIGITAL CAMERA
CITATION TO EACH CPSC PRODUCT SAFETY RULE TO WHICH THIS PRODUCT IS BEING CERTIFIED	16 CFR Part 1263 — Safety Standard for Button Cell or Coin Batteries and Consumer Products Containing Such Batteries
THE IMPORTER ISSUING THE CERTIFICATE	RICOH IMAGING AMERICAS CORPORATION 2 Gatehall Drive Suite 204, Parsippany, New Jersey 07054, U.S.A. (800) 234-0276
CONTACT INFORMATION FOR THE INDIVIDUAL MAINTAINING RECORDS OF TEST RESULTS	RICOH IMAGING AMERICAS CORPORATION Yuliana Kwok orders@ricoh-usa.com 2 Gatehall Drive Suite 204, Parsippany, New Jersey 07054, U.S.A. (905) 795-5729
THE DATE AND PLACE OF MANUFACTURE	March, 2025 Guangdong Sheng, China
THE DATE AND PLACE WHERE THE PRODUCT WAS TESTED	1/4/2025 to 20/6/2025 Kanagawa, Japan
LABORATORY CONDUCTING TESTING ON WHICH THE CERTIFICATE DEPENDS	RICOH IMAGING COMPANY, LTD. 16-1 Shinei-cho, Tsuzuki-ku, Yokohama, Kanagawa 224-0035 Japan

For Customers in USA and Canada

Lithium-ion batteries are recyclable.

You can help preserve our environment by returning your used rechargeable batteries to the collection and recycling location nearest you.

For more information regarding recycling of rechargeable batteries, call toll free 1-877-723-1297, or visit <https://www.call2recycle.org/>.

For Customers in Canada

Innovation, Science and Economic Development Canada (ISED) Regulatory Compliance Notice

This Class B digital apparatus complies with Canadian ICES-003 (B).

This device contains licence-exempt transmitter(s)/receiver(s) that comply with Innovation, Science and Economic Development Canada's licence-exempt RSS(s). Operation is subject to the following two conditions:

1. This device may not cause interference.
2. This device must accept any interference, including interference that may cause undesired operation of the device.

Warning:

- (i) The device for operation in the band 5150–5250 MHz is only for indoor use to reduce the potential for harmful interference to co-channel mobile satellite systems.
- (ii) For devices with detachable antenna(s), the maximum antenna gain permitted for devices in the band 5725–5850 MHz shall be such that the equipment still complies with the e.i.r.p. limits as appropriate.

Radio Frequency (RF) Exposure Information

The radiated output power of the Wireless Device is below the Innovation, Science and Economic Development Canada (ISED) radio frequency exposure limits. The Wireless Device should be used in such a manner such that the potential for human contact during normal operation is minimized.

This device has been evaluated for and shown compliant with the ISED Specific Absorption Rate ("SAR") limits when operated in portable exposure conditions. (Antennas are greater than 0 mm from a person's body.)

Avis de conformité à la réglementation d'Innovation, Sciences et Développement économique Canada (ISDE)

Cet appareil numérique de la classe B est conforme à la norme NMB-003 (B) du Canada.

L'émetteur/récepteur exempt de licence contenu dans le présent appareil est conforme aux CNR d'Innovation, Sciences et Développement économique Canada applicables aux appareils radio exempts de licence. L'exploitation est autorisée aux deux conditions suivantes :

1. L'appareil ne doit pas produire de brouillage ;
2. L'appareil doit accepter tout brouillage radioélectrique subi, même si le brouillage est susceptible d'en compromettre le fonctionnement.

Mise en garde :

- (i) Les dispositifs fonctionnant dans la bande de 5150 à 5250 MHz sont réservés uniquement pour une utilisation à l'intérieur afin de réduire les risques de brouillage préjudiciable aux systèmes de satellites mobiles utilisant les mêmes canaux.
- (ii) Pour les dispositifs munis d'antennes amovibles, le gain maximal d'antenne permis (pour les dispositifs utilisant la bande de 5725 à 5850 MHz) doit être conforme à la limite de la p.i.r.e. spécifiée, selon le cas.

Informations concernant l'exposition aux fréquences radio (RF)

La puissance de sortie rayonnée de l'appareil sans fil est inférieure aux limites d'exposition aux radiofréquences d'Innovation, Sciences et Développement économique Canada (ISDE). L'Appareil sans fil doit être utilisé de telle manière que le potentiel de contact humain pendant le fonctionnement normal soit minimisé.

Cet appareil a été évalué et démontré conforme aux limites de débit d'absorption spécifique (« SAR ») ISDE lorsqu'il est utilisé dans des conditions d'exposition portables. (Les antennes sont à plus de 0 mm du corps d'une personne.)

For Customers in Countries that Require the CE Marking

This product complies with the essential requirements and provisions.

RE Directive 2014/53/EU

The EU Declaration of Conformity is available by accessing the URL:
https://www.ricoh-imaging.co.jp/english/support/declaration_of_conformity.html
and selecting the product applicable.



Operating frequency band: 2400 to 2483.5 MHz
5150 to 5250 MHz
5725 to 5850 MHz

Maximum radio-frequency power: 2400 to 2483.5 MHz: 12.80 dBm EIRP
5150 to 5250 MHz: 11.20 dBm EIRP
5725 to 5850 MHz: 12.73 dBm EIRP

The minimum power required by the radio equipment to charge: 2.5 W
The maximum power required by the radio equipment to achieve maximum charging speed: 10 W



Importer (CE marking): RICOH IMAGING EUROPE S.A.S.
7-9, avenue Robert Schuman, 94150 Rungis, France

Manufacturer: RICOH IMAGING COMPANY, LTD.
1-3-6, Nakamagome, Ohta-ku, Tokyo 143-8555 Japan

Battery Regulation (EU) 2023/1542

This product complies with the essential requirements and provisions.

Li-ion rechargeable battery

DB-120

Importer (CE marking): RICOH IMAGING EUROPE S.A.S.
7-9, avenue Robert Schuman, 94150 Rungis, France
<https://ricoh-imaging.eu/>

Manufacturer: RICOH IMAGING COMPANY, LTD.
1-3-6, Nakamagome, Ohta-ku, Tokyo 143-8555 Japan
<https://www.ricoh-imaging.co.jp/english/>

Lithium secondary battery

ML414H IV01E

Importer (CE marking): RICOH IMAGING EUROPE S.A.S.
7-9, avenue Robert Schuman, 94150 Rungis, France
<https://ricoh-imaging.eu/>

Manufacturer: Seiko Instruments Inc.
8, Nakase 1-chome, Mihama-ku, Chiba-shi, Chiba 261-8507 Japan
https://krs.bz/sii/m/battery_inq_en

Regarding Wireless LAN

	AT	EE	IE	NL	ES	CH
	BE	FI	IT	PL	SE	HR
	BG	FR	LV	PT	UK(NI)	MK
	CY	DE	LT	RO	IS	TR
	CZ	EL	LU	SK	LI	ME
	DK	HU	MT	SI	NO	RS

- Do not use the 5 GHz band (W52) of wireless LAN outdoors in the countries listed above. The outdoor use of the W52 is prohibited by law in these countries. Use the 2.4 GHz or 5.8 GHz band for outdoors.
- The frequency range used by this product is limited to 5150 to 5250 MHz (W52) or 5725 to 5850 MHz (W58) in the 5 GHz band.

Regarding Batteries

- Replacement of a battery with an incorrect type can defeat a safeguard (for example, in the case of some lithium battery types).
- Disposal of a battery into fire or a hot oven, or mechanically crushing or cutting of a battery can result in an explosion.
- Leaving a battery in an extremely high temperature surrounding environment can result in an explosion or the leakage of flammable liquid or gas.
- A battery subjected to extremely low air pressure may result in an explosion or the leakage of flammable liquid or gas.

For Customers in Countries that Require the UKCA Marking

This product complies with the essential requirements and provisions.

Radio Equipment Regulations 2017

The UK Declaration of Conformity is available by accessing the URL:
https://www.ricoh-imaging.co.jp/english/support/declaration_of_conformity.html
and selecting the product applicable.



Operating frequency band: 2400 to 2483.5 MHz
5150 to 5250 MHz
5725 to 5850 MHz

Maximum radio-frequency power: 2400 to 2483.5 MHz: 12.80 dBm EIRP
5150 to 5250 MHz: 11.20 dBm EIRP
5725 to 5850 MHz: 12.73 dBm EIRP

Manufacturer: RICOH IMAGING COMPANY, LTD.
1-3-6, Nakamagome, Ohta-ku, Tokyo 143-8555 Japan

PSTI Statement of Compliance

This statement of compliance has been prepared by RICOH IMAGING COMPANY, LTD., 1-3-6, Nakamagome, Ohta-ku, Tokyo 143-8555 Japan (the 'Manufacturer') pursuant to Section 9 (2) of the Product Security and Telecommunications Infrastructure Act 2022 in respect of the following product:

Product Type: DIGITAL CAMERA

Product Model: R09010

End of Security Support Date: 30/11/2026

For details, refer to the webpages shown below.

<https://www.ricoh-imaging.co.jp/english/about/security/products/support/>



In the Manufacturer's opinion, the Manufacturer has complied with the following applicable security requirements:

Security requirements for manufacturers set out in SCHEDULE 2 of the Product Security and Telecommunications Infrastructure (Security Requirements for Relevant Connectable Products) Regulations 2023.

Applicable Standards: ETSI EN 303 645 V.2.1.1 (2020-06)

ISO/IEC 29147:2018 (2018-10)

Authorized by:



Kazunobu Saiki

Title of Authority: General Manager, Camera Business Division
RICOH IMAGING COMPANY, LTD.

Place and Date of Issue: Tokyo, Japan

30/6/2025 (dd/mm/yyyy)

Information for Users on Collection and Disposal of Old Equipment and Used Batteries



1. In the European Union

These symbols on the products, packaging and/or accompanying documents mean that used electrical and electronic equipment and batteries should not be mixed with general household waste.



Used electrical/electronic equipment and batteries must be treated separately and in accordance with legislation that requires proper treatment, recovery and recycling of these products.



By disposing of these products correctly you will help ensure that the waste undergoes the necessary treatment, recovery and recycling and thus prevent potential negative effects on the environment and human health which could otherwise arise due to inappropriate waste handling.

If a chemical symbol is added beneath the symbol shown above, in accordance with the Battery Directive, this indicates that a heavy metal (Hg = Mercury, Cd = Cadmium, Pb = Lead) is present in the battery at a concentration above an applicable threshold specified in the Battery Directive.

For more information about collection and recycling of used products, please contact your local authorities, your waste disposal service or the point of sale where you purchased the products.

2. In other countries outside the EU

These symbols are only valid in the European Union. If you wish to discard used products, please contact your local authorities or dealer and ask for the correct method of disposal.

For Switzerland: Used electrical/electronic equipment can be returned free of charge to the dealer, even when you don't purchase a new product. Further collection facilities are listed on the home page of www.swico.ch or www.sens.ch.

For Customers in Thai

เครื่องโทรคมนาคมและอุปกรณ์นี้ มีความสอดคล้องตามมาตรฐานหรือข้อกำหนดทางเทคนิคของ กสทช



กสทช.

เครื่องวิทยุคมนาคมนี้ ได้รับยกเว้น ไม่ต้องได้รับใบอนุญาตให้มี ใช้ซึ่งเครื่องวิทยุคมนาคมหรือตั้งสถานีวิทยุคมนาคมตามประกาศ กสทช. เรื่อง เครื่องวิทยุคมนาคม และสถานีวิทยุคมนาคมที่ได้รับยกเว้นไม่ต้องได้รับใบอนุญาตวิทยุคมนาคม ตามพระราชบัญญัติวิทยุคมนาคม พ.ศ. 2498



nab. โทรคมนาคม

กำกับดูแลเพื่อประชาชน

Call Center 1200 (Inswi)

For Customers in India

Battery Waste Management Rules

EPR No.: 7252955672223764882

Index

Numerics

4-way Controller 63

A

AA Filter Simulator 93
AC adapter 42
ADJ. mode 24
ADJ Mode Setting 134
AdobeRGB 91
AE Lock 54
AE Metering 67
AF Assist Light 61
AF point 63
Animation Setting 51
Aperture Priority AE 53
Aperture value 52
Aspect Ratio 91
Auto-area AF (Focus) 60
Auto bracketing 82
Auto EV Compensation 54
Auto Image Rotation 101
Auto Image Transfer 128
Auto Power Off 146
Auto Resize 128
Auto SR Off 98
Auto White Balance (White Balance).... 75
AV device 102
Av mode 53

B

Base Parameter Adj 120
Battery 40, 42
Battery level 20
Bleach Bypass (Image Control) 95
Bluetooth® 45, 125
Box 131
Bracketing 82
Bulb 56
Bulb timer 56
Button 16

C

Camera name change 124
Card 40

Care 179
Center-weighted (AE Metering) 67
Certification Marks 3
Changing display 20
Charging the battery 42
Cinema (Image Control) 94
Cloudy (White Balance) 75
Color Moiré Correction 119
Color Space 91
Color Temperature (White Balance)..... 79
Communication device 45, 124
Connection to a computer 123
Continuous AF (Focus) 60
Continuous Shooting 81
Conversion lens 155
Copyright Information 153
Correcting a range of tones 97
Count Down 144
Create New Folder 148
Crop 91, 92
Cropping 115
Cross Processing (Image Control) 95
CTE (White Balance) 76
Customization 134
Customize Settings menus 34
Cut (Movie) 121

D

Date Adjustment 45
Daylight (White Balance) 75
Delete 103
Depth of field 55
Dial 16
Direct keys 22
DisplayPort™ 102
Divide (Movie) 121
DNG 91
D-Range Correction 97
Drive Mode 80
Dust Removal 160

E

Editing images 111
Electronic Level 141
Electronic Level Design 143
Electronic Level Type 143
End Screen 44

Exif	153	Highlight-weighted (AE Metering).....	67
Exposure compensation	53	Histogram.....	141
Exposure Mode	52, 133	Horizon Correction	98
Exposure Setting	134		
F		I	
Face/Eye Detection	62	Image Capture Settings	91
File Format	91	Image Control.....	94
File Name.....	151	Image Copy	107
File Transfer.....	109	Image Rotation.....	101
Firmware update	124	Image Transfer while Off.....	128
Flash	70	Infinity (Focus)	60
Flash Mode.....	71	Initial settings	44
Flash On+Red-eye (Flash).....	71	Instant Review	48, 142
Flash On (Flash).....	71	Internal Memory	41
Flash Output.....	71	Interval Composite	87
Flicker Reduction.....	143	Interval Shooting.....	85
Fluorescent (White Balance).....	75	ISO sensitivity.....	69
Fn button.....	23	ISO Setting	69
Fn Button Setting	136		
Focus	49, 60	J	
Focus bar	64	JPEG Recorded Pixels	91
Focus frame	49		
Focus Limiter.....	62	K	
Focus Magnification	51	Keep AE Lock.....	138
Focus Peaking.....	61		
Focus Settings.....	138	L	
Folder display.....	100	Language setting	45
Folder Name	149	LCD Auto Dim	147
Format	46	LCD Setting	143
Formatting the memory	46	Lens adapter.....	155
Framerate.....	92	Levels Adjustment	116
Full Press Snap	66	Link AE and AF Point	68
		Long exposure.....	56
G			
Grid Guide	141	M	
Grid Style	143	Macro	65
GR WORLD	45, 124	Magnifying images	50
Guide Display.....	23, 138	Magnifying Live View images	49
		Manual Exposure	53
H		Manual focus.....	64
Hard Monotone (Image Control)	94	Manual White Balance	
HDR Tone (Image Control).....	95	(White Balance).....	78
Hi-Contrast B&W (Image Control).....	94	Memory.....	140
High-ISO Noise Reduction	73	Memory card.....	40
Highlight Alert.....	141	Menu.....	25
Highlight Correction	97	MF	64
		MF Auto Magnification.....	64

microSD memory card.....	40
M mode.....	53
Moiré reduction	93
Monitor	18
Monotone (Image Control).....	94
Movie	57
Movie Capture Settings.....	92
Movie Edit	121
Movie Settings menus.....	31
Movie SR	98
Multi-exposure.....	83
Multi-image display.....	100
Multi-segment (AE Metering)	67

N

ND Filter	93
Negative Film (Image Control).....	94
Noise Reduction.....	73

O

One Push AE in M Mode.....	56, 138
Operating environment.....	175
Outdoor View Setting	144

P

Package contents	13
Pairing.....	45, 126
Peripheral Illumin. Corr.....	96
Pinpoint AF (Focus).....	60
Pixel Mapping.....	160
Playback.....	50, 99
Playback function selection screen	99
Playback Info. Display	141
Playback Order Options	101
Playback Settings menus.....	32
P mode	48, 53
Positive Film (Image Control)	94
Power	44
Power Button Lamp.....	144
Preview.....	55
Processing images	111
Program AE.....	48, 53
Program Auto Ex.....	54
Program Line.....	55
Protect.....	105

Q

Quick Zoom	142
------------------	-----

R

RAW	91
RAW Development.....	111
Reducing blurring of images.....	98
Remote shooting.....	124
Reset.....	26
Reset Numbering	152
Reset Settings.....	26
Reset to Factory Default.....	26
Resize	114
Retro (Image Control)	95
Ring cap	155

S

Saving power	146
Select AF (Focus).....	60
Self-timer	89
Sensitivity.....	69
Sequential Numbering.....	152
Setting box	131
Setup menus	37
Shade (White Balance)	75
Shadow Correction	97
Shake Reduction.....	98
Sharing.....	123
Shooting close-ups.....	65
Shooting date display.....	100
Shooting Info. Display.....	141
Shooting Memory Setting.....	90
Shutter Btn. Confirmation	139
Shutter Button Setting	139
Shutter Priority AE.....	53
Shutter speed	52
Single image display	50
Sleep Mode.....	147
Slow Shutter Speed NR	73
Slow-speed Sync (Flash).....	71
Slow Sync+Red-eye (Flash)	71
Smartphone Link.....	128
Smartphone Linkage	45
Snap Distance Priority AE.....	53
Snap (Focus).....	60
Snap Focus Distance	60
Sn mode.....	53

Soft Monotone (Image Control).....	94
Sound Effects	145
Sound Recording.....	92
Specifications.....	166
Spot (AE Metering).....	67
sRGB	91
Status lamp.....	49
Still Image Settings menus	28
Storage	179
Storage capacity	43, 173
Store Cursor Position.....	26
Store Location Info.....	128

T

Time.....	56
Time synchronization	124
Touch AF	55
Touch screen	21
Tracking AF (Focus).....	60
Tungsten (White Balance)	76
TV	102
Tv mode	53

U

USB cable.....	42, 123
User Mode.....	129

V

Vivid (Image Control)	94
Volume	145
Volume label	47

W

Warranty policy	180
WB Adjustment	118
White Balance	75
Wireless Communication.....	126

Z

Zone Select AF (Focus)	60
------------------------------	----

RICOH IMAGING COMPANY, LTD.

16-1, Shinei-cho, Tsuzuki-ku, Yokohama, Kanagawa
224-0035 Japan
(<https://www.ricoh-imaging.co.jp>)

**RICOH IMAGING EUROPE
S.A.S.**

7-9, avenue Robert Schuman, 94150 Rungis, France
(<https://www.ricoh-imaging.eu>)

**RICOH IMAGING
AMERICAS CORPORATION**

2 Gatehall Drive Suite 204, Parsippany, New Jersey
07054, U.S.A.
(<https://www.us.ricoh-imaging.com>)

**RICOH IMAGING CANADA
INC.**

5560 Explorer Drive Suite 400, Mississauga, Ontario,
L4W 5M3, Canada
(<https://www.ricoh-imaging.ca>)

**RICOH IMAGING CHINA
CO., LTD.**

Room A 23F Lansheng Building, 2-8 Huaihaizhong
Road, Huangpu District, Shanghai, 200021, China
(<https://www.ricoh-imaging.com.cn/china/>)

<https://www.ricoh-imaging.co.jp/english/>

This contact information may change without
notice. Please check the latest information on our
websites.

RICOH IMAGING COMPANY, LTD.
June, 2025



Printed in China
78560 Z040



* 4 Q D A Z 0 4 0 *