



the Dual Boiler™

BES920



EN QUICK GUIDE

Sage®



- 2 Sage® Recommends Safety First
- 5 Know Your New Appliance
- 7 Operating Your New Appliance
- 17 Care & Cleaning
- 20 Troubleshooting
- 23 Guarantee

SAGE® RECOMMENDS SAFETY FIRST

At Sage® we are very safety conscious. We design and manufacture appliances with your safety foremost in mind. We also ask that you exercise a degree of care when using any electrical appliance and adhere to the following precautions.

READ ALL INSTRUCTIONS BEFORE USE AND SAVE FOR FUTURE REFERENCE

- A downloadable version of this document is also available at sageappliances.com
- Before using for the first time, please ensure that your electricity supply is the same as shown on the rating label on the underside of the appliance. If you have any concerns please contact your local electricity company.
- The installation of a residual current safety switch is recommended to provide

additional safety when using all electrical appliances. Safety switches with a rated operating current not more than 30mA are recommended. Consult an electrician for professional advice.

- Remove and discard any packaging materials safely, before first use.
- To eliminate a choking hazard for young children, discard the protective cover fitted to the power plug safely.
- Ensure the product is properly assembled before first use.
- This appliance is for household use only. Do not use the appliance for anything other than its intended purpose. Do not use in moving vehicles or boats. Do not use outdoors. Misuse may cause injury.
- Position the appliance on a stable, heat resistant, level, dry surface away from the counter edge, and do not operate on or near a heat source such as a hot plate, oven or gas hob.
- Fully unwind the power cord before operating.
- Do not let the power cord hang over the edge of a counter or table. Do not let the power cord touch hot surfaces or become knotted.
- Do not leave the appliance unattended when in use.

WE RECOMMEND SAFETY FIRST

- If the appliance is to be:

- left unattended
- cleaned
- moved
- assembled; or
- stored

Always switch off the espresso machine by pressing the POWER button to OFF.

Switch off and unplug from the power outlet.

- Regularly inspect the power cord, plug and actual appliance for any damage. If found to be damaged in any way, immediately cease use of the appliance and return the entire appliance to the nearest authorised Sage Service Centre for examination, replacement or repair.
- Keep the appliance and accessories clean. Follow the cleaning instructions provided in this book. Any procedure not listed in this instruction booklet should be performed at an authorised Sage Service Centre.
- The appliance can be used by children aged 8 or older and persons with reduced physical, sensory or mental capabilities or a lack of experience and knowledge, only if they have been given supervision or instruction concerning use of the appliance in a safe way and understand the hazards involved.
- Children should not play with the appliance.
- Cleaning of the appliance should not be carried out by children unless they are 8 years or older and under adult supervision.
- The appliance and its cord should be kept out of reach of children aged 8 years and younger.
- Do not use attachments other than those provided with the appliances.
- Do not attempt to operate the appliance by any method other than those described in this booklet.
- Do not move the appliance whilst in operation.
- Do not use any other liquid apart from cold mains/town water. We do not recommend the use of highly filtered, de-mineralised or distilled water as this may affect the taste of the coffee and how the espresso machine is designed to function.
- Never use the appliance without water in the water tank.
- Ensure the portafilter is firmly inserted and secured into the brewing head before using the machine.
- Never remove the portafilter during the brewing operation as the machine is under pressure.

WE RECOMMEND SAFETY FIRST

- Do not place anything, other than cups for warming, on top of the appliance.
- Use caution when operating machine as metal surfaces are liable to get hot during use.
- Do not touch hot surfaces. Allow the product to cool down before moving or cleaning any parts.
- Heating element surface is subject to residual heat after use.
- Always ensure the appliance is turned OFF, unplugged at the power outlet and has been allowed to cool before cleaning, attempting to move or storing.
- The appliance is not intended to be operated by means of an external timer or separate remote-control system.
- The use of attachments not sold or recommended by Sage may cause fire, electric shock or injury.
- Always turn the appliance to the off position, switch off at the power outlet and unplug at the power outlet when the appliance is not in use.
- Any maintenance other than cleaning should be performed by an authorised Sage® service centre.
- Do not use the appliance on a sink drain board.
- Do not operate the appliance if it is in an enclosed space, or within a cupboard.
- Use caution when descaling as hot steam may be released. Before descaling, ensure drip tray is empty and inserted. Refer to 'Care & Cleaning' for further instructions.

SPECIFIC INSTRUCTIONS FOR WATER FILTER

- Filter cartridge should be kept out of reach of children.
- Store filter cartridges in a dry place in the original packaging.
- Protect cartridges from heat and direct sunlight.
- Do not use damaged filter cartridges.
- Do not open filter cartridges.
- If you are absent for a prolonged period of time, empty the water tank and replace the cartridge.



The symbol shown indicates that this appliance should not be disposed of in normal household waste. It should be taken to a local authority waste collection centre designated for this purpose or to a dealer providing this service. For more information, please contact your local council office.



To protect against electric shock, do not immerse the power cord, power plug or appliance in water or any other liquid.

**FOR HOUSEHOLD USE ONLY
SAVE THESE INSTRUCTIONS**

KNOW YOUR NEW APPLIANCE

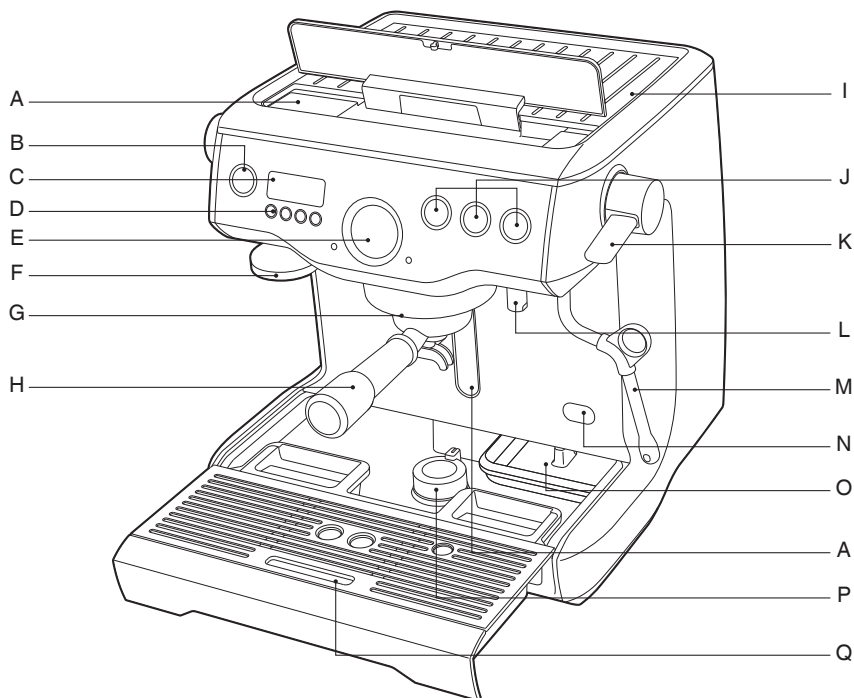

- A. Top fill 2.5 litre removable water tank
- B. POWER button
- C. Backlit LCD interface
- D. MENU access and DISPLAY mode buttons
- E. Espresso pressure gauge
- F. Integrated & removable 58mm tamper
- G. Actively heated 58mm group head with embedded element
- H. 58mm full stainless steel portafilter
- I. Convection heated 6 cup warming tray
- J. Manual and programmable 1 & 2 cup volume controls
- K. Easy to operate steam lever
- L. Dedicated hot water outlet

- M. 360° swivel action steam wand with 3 hole tip
- N. De-scale access point
- O. Integrated tool storage tray
- P. Drop down swivel foot
- Q. Removable drip tray

NOT SHOWN

- 15 bar Italian pump
- Dual stainless steel boilers
- Electronic PID temperature control
- Over pressure valve
- Low pressure pre-infusion
- Power save mode
- Safety thermal cut-out protection

KNOW YOUR NEW APPLIANCE

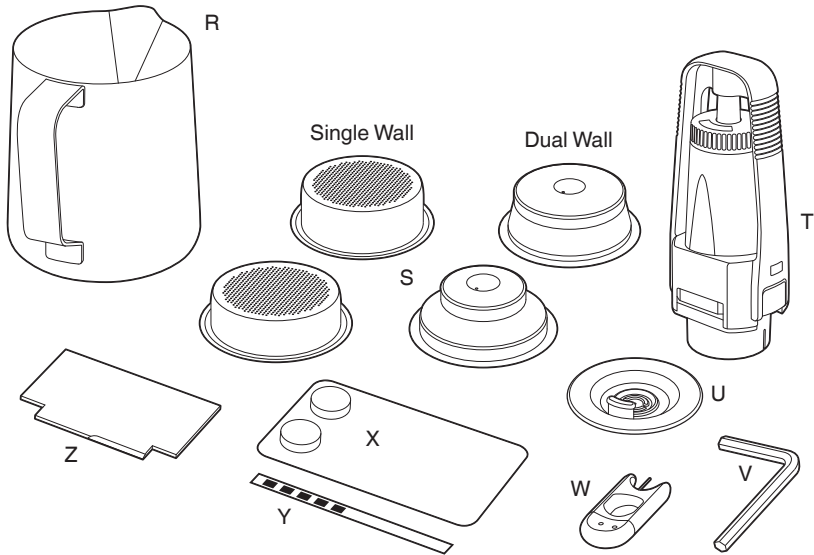

ACCESSORIES

- R. Stainless steel frothing jug
- S. Single & dual wall filter baskets (1 & 2 cup)
- T. Water filter holder with filter
- U. Cleaning disc
- V. Allen key
- W. Cleaning tool
- X. Espresso cleaning tablets
- Y. Water hardness test strip
- Z. Razor™ precision dosing tool

LCD INTERFACE

- Display Modes
- Shot Temp
- Shot Clock Timer
- Clock

Programmable Functions

- Shot Temp
- Shot Volume - 1 & 2 cup
- Pre-Infusion
- Auto Start



Rating Information

220-240V ~50-60Hz 1800-2200W

OPERATING YOUR NEW APPLIANCE



WARNING

Both the STEAM LEVER and HOT WATER dial must be in the CLOSED position for the machine to enter START UP mode.

BEFORE FIRST USE

Machine Preparation

Remove and discard all labelling and packaging materials attached to your espresso machine. Ensure you have removed all parts and accessories before discarding the packaging.

Clean parts and accessories (water tank, portafilter, filter baskets, jug) using warm water and a gentle dish washing liquid and rinse well.

Conditioning the Water Filter

- Remove filter from the plastic bag and soak in a cup of water for 5 minutes.
- Rinse filter under cold running water.
- Wash the stainless steel mesh in the plastic filter compartment with cold water.
- Insert the filter into the filter holder.
- Set Date Dial 2 months ahead.
- To install filter, push down to lock into place.
- Slide the water tank into position and lock into place.

FIRST USE

Initial Start Up

- Fill tank with cold tap water.
- Dip Water Hardness Test Strip into water tank for 1 second & set aside.
- Check Steam Lever and Hot Water dial are in the CLOSED position.
- Press POWER On.
- Machine will prompt you to set water hardness. Refer for test strip for your water hardness. Use the Arrow UP or Arrow DOWN keys to select water hardness 1–5. Press Menu to set. Machine will beep to confirm selection.
- Machine will reach operating temperature and go into STANDBY mode.

Flushing The Machine

When the machine has reached STANDBY mode, run the following 3 steps:

1. Press 2 Cup button to run water through group head.
2. Run Hot Water for 30 seconds.
3. Activate Steam for 10 seconds.

START UP

Press the POWER button to switch the machine ON. The POWER button will flash and the LCD screen will display the current espresso boiler temperature.

When the machine has reached operating temperature, the POWER button light will stop flashing and the MANUAL, 1 CUP and 2 CUP buttons will illuminate.

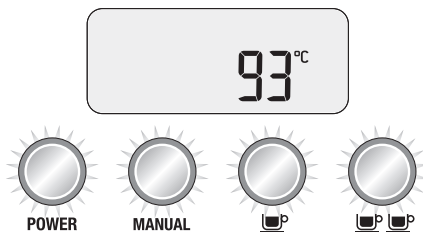

The machine is now in STANDBY mode ready for use.

NOTE

You will not be able to select 1 CUP, 2 CUP or CLEANING CYCLE during START UP.

AUTO OFF MODE

The machine automatically switches to AUTO OFF mode after 20 minutes.

OPERATING YOUR NEW APPLIANCE

LCD INTERFACE

Display modes

3 modes can be displayed on the LCD screen: *Shot Temp*, *Shot Clock* or *Clock*.

Press UP or DOWN arrow to change the display mode between shot clock & clock. Shot temp will be displayed during an extraction.

1. Shot Temp

Displays selected extraction temperature (default set at 93°C), but can be changed from 86°C – 96°C. See 'Extraction Temperature', page 12.

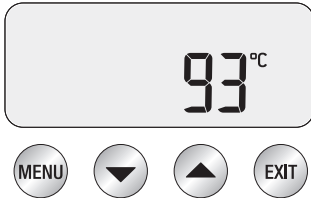

2. Shot Clock

Temporarily displays duration of last espresso extraction in seconds.



3. Clock

Temporarily displays current time (default set at 12.00am if time has not been set).



SELECTING FILTER BASKET

SINGLE WALL Filter Baskets

Use Single Wall filter baskets when grinding fresh whole coffee beans.

Single Wall filter baskets allow you to experiment with grind, dose and tamp to create a more balanced espresso.

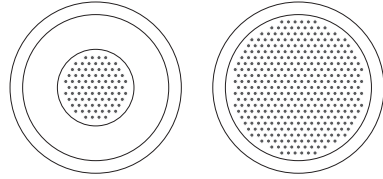

- Use the 1 cup filter basket when brewing single cups and the 2 cup filter basket when brewing two cups, stronger single cups or mugs.

DUAL WALL Filter Baskets

Use Dual Wall filter baskets if using pre-ground coffee.

Dual Wall filter baskets regulate the pressure and help to optimise the extraction regardless of the grind, dose, tamp pressure or freshness.

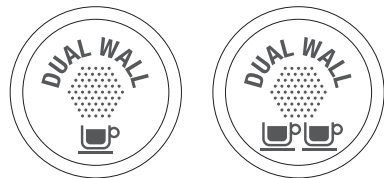

- Use the 1 cup filter basket when brewing single cups and the 2 cup filter basket when brewing two cups, stronger single cups or mugs.

COFFEE DOSE AND TAMPING

- Using Single Wall filter baskets, grind enough coffee to fill the coffee basket.
- Tap the portafilter several times to collapse and distribute the coffee evenly in the filter basket.
- Tamp down firmly (using approx. 15 – 20kgs of pressure). The amount of pressure is not as important as consistent pressure every time.

OPERATING YOUR NEW APPLIANCE

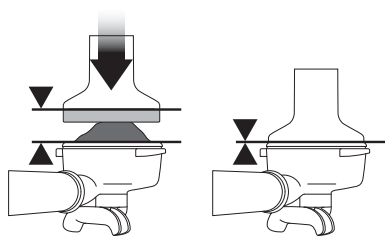

- As a guide to dose, the top edge of the metal cap on the tamper should be level with the top of the filter basket AFTER the coffee has been tamped.

TRIMMING THE DOSE

- Insert the Razor™ dosing tool into the coffee basket until the shoulders of the tool rest on the rim of the basket. The blade of the dosing tool should penetrate the surface of the tamped coffee.
- Rotate the Razor™ dosing tool back and forth while holding the portafilter on an angle over the knock box to trim off excess coffee grinds. Your coffee filter basket is now dosed with the correct amount of coffee.

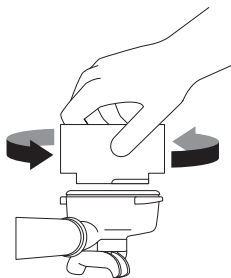

- Wipe excess coffee from the rim of the filter basket to ensure a proper seal is achieved in the group head.

GENERAL OPERATION

1 CUP

Press 1 CUP once to extract a single shot of espresso at the pre-programmed duration (30secs). The extraction will start using the low pressure pre-infusion.



2 CUP

Press 2 CUP button once to extract a double shot of espresso at the pre-programmed duration (30secs).

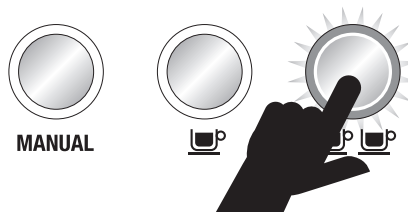

MANUAL

The MANUAL button allows you to control the espresso pour volume to suit your preference.

Press MANUAL button once to start the espresso extraction. The extraction will start using the low pressure pre-infusion.

Press MANUAL button again to stop extraction.

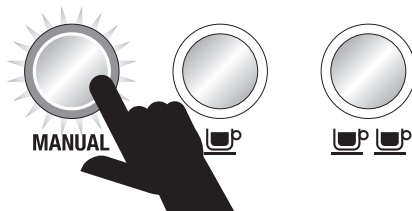

OPERATING YOUR NEW APPLIANCE

EXTRACTION GUIDE

	GRIND	SHOT TIME
OVER EXTRACTED BITTER • ASTRINGENT	TOO FINE	OVER 40 SEC
BALANCED	OPTIMUM	25-35 SEC
UNDER EXTRACTED UNDERDEVELOPED • SOUR	TOO COARSE	UNDER 20 SEC

STEAM

For instant steam, move STEAM LEVER to OPEN position. The Steam LED will be On.

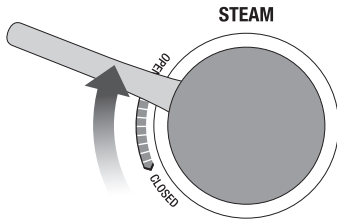

To turn STEAM off, move STEAM LEVER to CLOSED position. The machine will return to STANDBY mode.

CAUTION: BURN HAZARD

Pressurised steam can still be released, even after machine has been switched off.

Children must always be supervised.

HOT WATER

For instant hot water, rotate the HOT WATER dial to OPEN position. The Hot Water LED will be On.

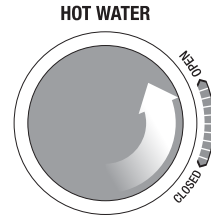

To turn HOT WATER off, rotate the HOT WATER dial to CLOSED position. The machine will return to STANDBY mode.

LCD PROGRAMMING FUNCTIONS

To program the machine, press MENU button once. The LCD will display all programming functions. Continue to press MENU button to select your desired function.

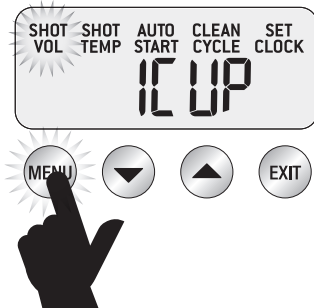

At any stage during programming, press EXIT to return to STANDBY mode.

NOTE

The MENU button is disabled when the machine is extracting espresso or delivering hot water.

OPERATING YOUR NEW APPLIANCE

SHOT DURATION

1 CUP Duration Programming

Press MENU button until SHOT VOL icon flashes and 1 CUP is displayed on the LCD screen.

Press 1 CUP button to start water flow from the group head.

Press 1 CUP again once required extraction duration has been reached.

The machine will beep twice to indicate the new 1 CUP duration has been set.

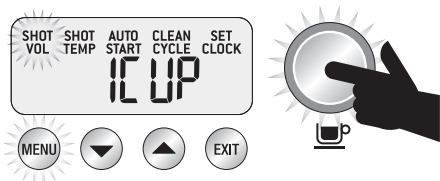

2 CUP Duration Programming

Press MENU button until SHOT VOL icon flashes and 2 CUP is displayed on the LCD screen.

Press 2 CUP button to start water flow from the group head.

Press 2 CUP again once required extraction duration has been reached.

The machine will beep twice to indicate the new 2 CUP duration has been set.

SHOT VOLUME

1 CUP Volume Programming

Press MENU button until SHOT VOL icon flashes and 1 CUP is displayed on the LCD screen.

Dose & tamp the portafilter with ground coffee. Press 1 CUP button to start espresso extraction. Press 1 CUP again once desired volume of espresso has been extracted.

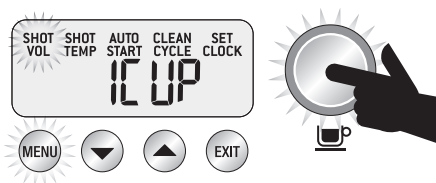

2 CUP Volume Programming

Press MENU button until SHOT VOL icon flashes and 2 CUP is displayed on the LCD screen.

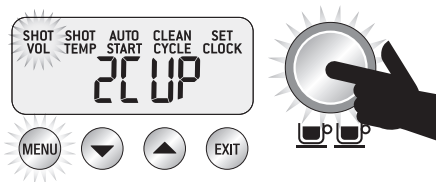

Dose & tamp the portafilter with ground coffee. Press 2 CUP button to start espresso extraction. Press 2 CUP again once desired volume of espresso has been extracted.

OPERATING YOUR NEW APPLIANCE

EXTRACTION TEMPERATURE

Press MENU button until SHOT TEMP icon flashes. The LCD will display the current shot temperature setting.

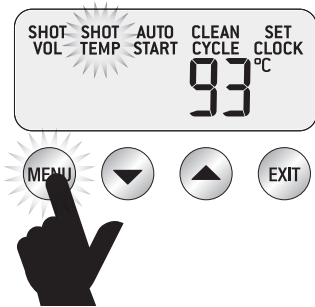

Press UP or DOWN arrow to adjust SHOT TEMP to the desired setting (range 86°C – 96°C).

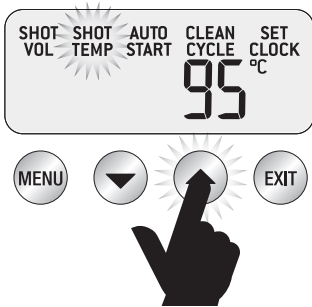

The new SHOT TEMP setting will be displayed on the LCD screen.

AUTO START

To use AUTO START, first ensure clock has been set.

Auto Start ON/OFF

Press MENU button until AUTO START icon flashes and the current Auto Start setting (ON or OFF) is displayed on the LCD screen.

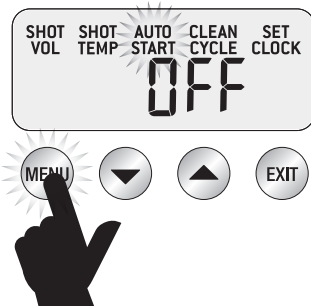

Press UP or DOWN arrow to set the AUTO START to ON or OFF.



If AUTO START is ON, the LCD will display a Clock icon.

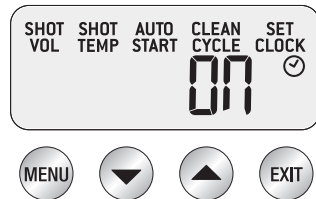

OPERATING YOUR NEW APPLIANCE

Press MENU button and the current Auto Start time will be displayed on the LCD screen.



Press UP or DOWN arrow to adjust AUTO START to the desired time (default AUTO START time set at 7:00am).

Press EXIT button.

SET CLOCK

Press MENU button until SET CLOCK icon flashes. The current Clock Time will be displayed on the LCD screen.



Press UP or DOWN arrow to adjust the time.



Press EXIT button.

CLEAN CYCLE

Press MENU button until CLEAN CYCLE icon flashes and PUSH is displayed on the LCD screen.

To start the CLEAN CYCLE press the illuminated MANUAL button.

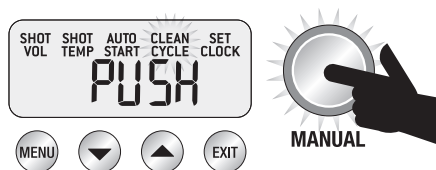

The CLEAN CYCLE icon will flash and the machine will start to countdown from 370 seconds.

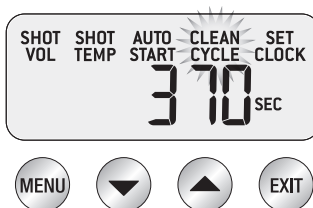

The machine will return to STANDBY when the cleaning cycle has ended.

OPERATING YOUR NEW APPLIANCE

ADVANCED ESPRESSO FUNCTIONS

Press & Hold - 1 CUP

Press & hold 1 CUP to bypass the pre-infusion phase and deliver water to the group head at the full 9 bar pressure. Release button to stop extraction. This function can be used when purging the group head.

Press & Hold - 2 CUP

Press & hold 2 CUP to bypass the pre-infusion phase and deliver water to the group head at the full 9 bar pressure. Release button to stop extraction. This function can be used when purging the group head.

Press & Hold - MANUAL

Press & hold the MANUAL button to deliver water to the group head at low pre-infusion pressure. When MANUAL button is released, water will continue at the full 9 bars of pressure. Press MANUAL button again to stop extraction.

This function can be used to manually control the pre-infusion duration.

ACCESS ADVANCED MENU

To access the Advanced Menu:

With machine OFF, press and hold the 1 CUP button, then press the POWER button.

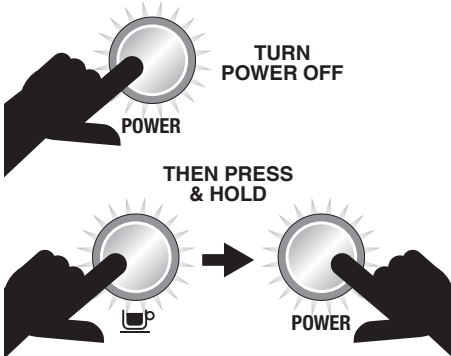

Resetting default settings

The machine has the following default settings:

1. Temperature – 93°C
2. Pre-Infusion – Duration Pr07
3. Pre-Infusion – Power PP60
4. Steam temperature – 135°C
5. Auto Start – OFF
6. Audio – LO
7. Water Hardness – 3
8. Espresso Volume durations – 30/30 secs
- 9.

To reset machine to original default settings, first enter Advanced Menu. rSEt will be displayed on the LCD. Press the MENU button to reset the machine to the default settings.



The machine will then prompt you to set the water hardness. Select your water hardness using the UP & DOWN arrows & press MENU to confirm or press EXIT to return to STANDBY mode.



OPERATING YOUR NEW APPLIANCE

Temperature Unit - °C/°F (SEt)

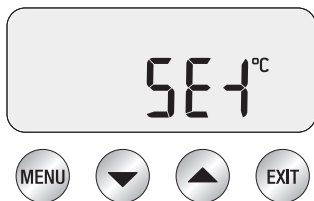

Temperature Unit will be displayed on the LCD screen as SEt. Press MENU to Select.

Use UP and DOWN arrows to select desired temperature unit. Press MENU to set.

Machine will beep once to confirm selection. Press EXIT to return to STANDBY mode.

Steam Temperature (StEA)

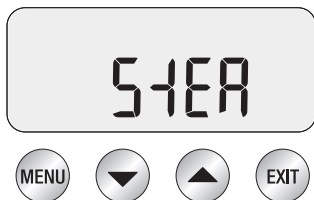

Adjust Steam Temperature to control the pressure of the steam being delivered. Lower steam temperature to texture smaller volumes of milk or have more control. Raise steam temperature to texture larger volumes of milk.

Press MENU to Select STEAM.

Use UP and DOWN arrows to select required steam temperature.

Press MENU to set.

Machine will beep once to confirm selection.

Machine Audio (Snd)

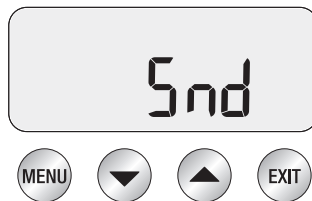

Machine Audio refers to the volume level of the 'beeps' heard.

- HI - high volume
- LO - low volume
- OFF - volume off

Press the MENU button to select Audio.

Press UP or DOWN arrows to select desired volume. Press MENU to set. Machine will beep once to confirm selection.

Volumetric Control (vOL)



Use this function to set Duration or Volume to control the espresso output.

Press the MENU button to select. Use the UP or DOWN arrows to select FL0 or SEc. Press MENU to set. Machine will beep once to confirm selection.

OPERATING YOUR NEW APPLIANCE

ADVANCED FEATURES

Pre-Infusion Programming

With machine in STANDBY mode, press UP and DOWN arrows together to enter Pre-Infusion programming mode.

Press MENU button to move between Pre-infusion Duration and Power.

Pre-Infusion Duration

The LCD will display the current Pre-Infusion Duration.

Press UP or DOWN arrow to vary time.

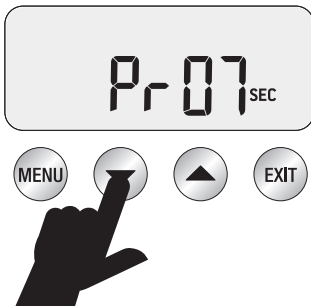

We recommend a range of between 5 - 15secs as being optimum.

Pre-Infusion Power

The LCD will display current Pre-Infusion Power.

Press UP or DOWN arrows to vary power.

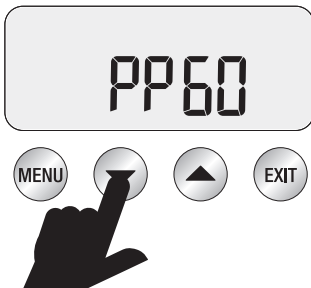

We recommend a range of between 55–65 as being optimum. Press EXIT to confirm setting and return to STANDBY mode.

ALERTS

STEAM LED Flashing At START UP

The machine will not enter START UP mode when the STEAM LEVER is in the OPEN position and the STEAM LED is flashing.

Move the STEAM LEVER to the CLOSED position for the machine to enter START UP mode.

HOT WATER LED Flashing At START UP

The machine will not enter START UP mode when the HOT WATER dial is in the OPEN position and the HOT WATER LED is flashing.

Move the HOT WATER dial to the CLOSED position for the machine to enter START UP mode.

HOT WATER LED Flashing

The HOT WATER LED will flash when the HOT WATER function has been operating for longer than 1 minute.

Move the HOT WATER dial to CLOSED position for machine to enter STANDBY mode.

Fill Tank

The machine will detect a low water level. The FILL TANK icon will be displayed on the LCD screen.

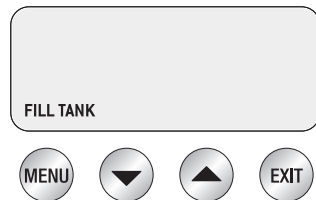

If FILL TANK icon is displayed, add water to tank until machine returns to STANDBY mode.

CARE & CLEANING

CLEAN ME!

The machine will detect when 200 extractions have been carried out since the last clean cycle.

The CLEAN ME! icon will be displayed on the LCD screen the next time the machine enters START UP mode.



CLEANING CYCLE

- CLEAN ME! will be displayed on LCD to indicate when a cleaning cycle is required (approx. 200 shots).
- Insert the supplied cleaning disc, followed by 1 cleaning tablet into the 1 CUP filter basket.
- Insert the portafilter and lock into group head.
- Ensure the water tank is filled with cold tap water.
- Ensure the drip tray is empty & inserted.
- Press MENU button until CLEAN CYCLE icon flashes and PUSH is displayed on the LCD screen.

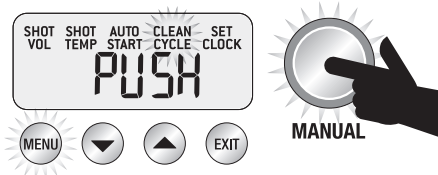

- To start the Clean Cycle press the illuminated MANUAL button.
- The CLEAN CYCLE icon will flash and the machine will start to countdown from 370 seconds.
- When the cleaning cycle has finished, remove the portafilter and ensure the tablet has completely dissolved. If the tablet has

not dissolved, repeat the steps above, without inserting a new tablet.

- Rinse the filter basket and portafilter thoroughly before use.

INSTALLING WATER FILTERS

- Soak filter in a glass of water for 5 minutes.
- Rinse the filter and mesh under running water.
- Assemble filter into filter holder.
- Set replacement date forward 2 months.
- Install filter holder into water tank.
- Insert water tank into the machine. Ensure the latch is locked into position.
- Replacing the water filter after three months or 40L will reduce the need to descale the machine. The limitation of 40L is based on water hardness level 4. If you are in level 2 area, you can increase this to 60L.

NOTE

To purchase water filters visit Sage® webpage.

CLEANING THE STEAM WAND

- Wipe the steam wand with a damp cloth & purge directly after texturing the milk.
- If the any of the holes in the tip of the steam wand become blocked, ensure the STEAM LEVER is in the CLOSED position and clean using the pin on the end of the cleaning tool.
- If steam wand remains blocked, remove the tip using the integrated spanner in the cleaning tool and soak in hot water. Screw tip back onto the steam wand using the integrated spanner in the cleaning tool.

CLEANING THE FILTER BASKETS AND PORTAFILTER

- The filter baskets and portafilter should be rinsed under hot water directly after use to remove all residual coffee oils.

If the holes in the filter baskets become blocked, dissolve a cleaning tablet in hot water and soak filter basket and portafilter in solution for approx. 20 minutes. Rinse thoroughly.

CARE & CLEANING

CLEANING THE SHOWER SCREEN

- The group head interior and shower screen should be wiped with a damp cloth to remove any ground coffee particles.
- Periodically run hot water through the machine with the filter basket and portafilter in place, without ground coffee, to rinse out any residual coffee.

CLEAR WATER BACK-FLUSH

- Insert the cleaning disc into the 1 cup filter basket.
- Insert portafilter into the group head.
- Press the 1 CUP button to build pressure in the basket.
- Repeat several times to remove residual coffee oils in the espresso water paths.

CLEANING THE DRIP & STORAGE TRAY

- The drip tray should be removed, emptied and cleaned after each use or when the drip tray indicator is showing Empty Me!
- Remove grill from the drip tray. Wash the drip tray in warm soapy water. The Empty Me! indicator can also be removed from the drip tray.
- The storage tray can be removed and cleaned with a soft, damp cloth (do not use abrasive cleansers, pads or cloths which can scratch the surface).

CLEANING THE OUTER HOUSING & CUP WARMING TRAY

- The outer housing and cup warming tray can be cleaned with a soft, damp cloth. Polish with a soft, dry cloth. Do not use abrasive cleansers, pads or cloths which can scratch the surface.

NOTE

Do not clean any of the parts or accessories in the dishwasher.

DESCALE (dESC)

NOTE

Even if you used the provided water filter, we recommend you to descale if there is scale build-up in the water tank.

Only descale via the descale menu.

1 – Prepare for Descale

- a) Empty the drip tray and insert into position.
- b) Turn the machine off and allow to cool for at least 4 hours. With the machine off, press and hold the 1 CUP button, then press and hold the POWER button together for 3 seconds. rSET will appear on the LCD.

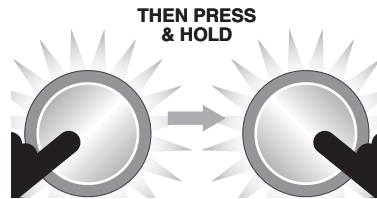

- c) Press UP or DOWN arrow to the 'dESC' then press MENU to confirm.

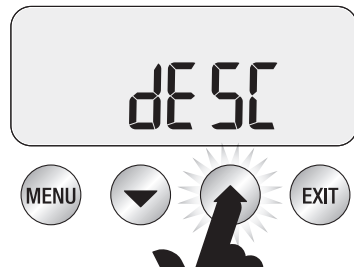

2 – Empty Boilers

- a) Remove the grey silicone cover on the lower front panel marked DESCALING ACCESS.

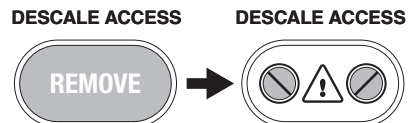

CARE & CLEANING

- b) Place a cloth over the drip tray to prevent steam escaping.

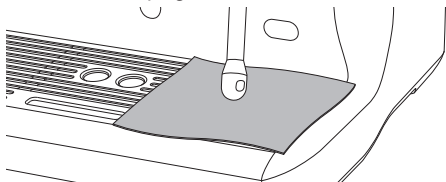

- c) Use a flat head screw driver to rotate the right valve counter-clockwise SLOWLY until fully open. As the valve opens, steam may be released.

NOTE

If there's no water released into the drip tray, press and hold the 1 CUP button for 3 seconds. This will release water from the boiler.

When the water is completely empty, close the valve by rotating screws clock-wise until seated. Do not overtighten screws to avoid damage to the valves.

DESCALE ACCESS



- d) Repeat the above process on the left valve.
 e) Empty the drip tray, use caution as the drip tray may be hot.
 f) Empty water tank, remove water filter.
 g) Dissolve 1 sachet of Sage® Descaler™ into 1 litre of warm water. Pour solution into the water tank.

NOTE

If water tank has not been removed, replaced or is empty, "FILL TANK" will appear on the LCD.

3 – Begin Descale

- a) Press 1 Cup button and the LCD screen will show countdown time (20 minutes).

20

During this time, the machine will fill boilers with descale solution and heat to temperature. There may be some water flow through the group head during this time.

Allow the countdown timer to reach 0 as this allows solution sufficient time to dissolve scale build up. However you can proceed to the next step at any time by pressing the 1 Cup button.

- b) Place a cloth over the drip tray to stop steam escaping.
 c) Empty boilers by repeating steps 2c and 2d.
 d) Empty drip tray and insert back to place.
 e) Empty water tank then rinse and fill with clean water to the MAX line. Lock water tank back into position.

4 – Flush Boilers

- a) Press 1 Cup button and the LCD screen will show countdown time (20 minutes).

20

During this time, the machine will fill boilers with fresh clean water and heat to temperature. You can proceed to the next step at any time by pressing the 1 Cup button.

- b) Place a cloth over the drip tray to stop steam escaping.
 c) Empty boilers by repeating steps 2c and 2d.
 d) Empty drip tray and insert back to place.
 e) Empty water tank then rinse and fill with clean water to the MAX line. Lock water tank back into position.

5 – Repeat Step 4 Flush Boilers

We recommend flushing boilers again to ensure any residual descale solution is released from the boilers. Press POWER button to escape the Descale mode. The descale process is now complete and ready to use.

TROUBLESHOOTING

PROBLEM	POSSIBLE CAUSES	WHAT TO DO
The Hot Water LED flashes when the machine is turned On.	<ul style="list-style-type: none"> Hot Water dial is open. 	Turn the Hot Water dial to the CLOSED position.
The Steam LED flashes when the machine is turned On.	<ul style="list-style-type: none"> Steam Lever is open. 	Move the Steam Lever to the CLOSED position.
Water does not flow from the group head.	<ul style="list-style-type: none"> Machine has not reached operating temperature. 	Allow time for the machine to reach operating temperature. The POWER light will stop flashing when machine is ready.
	<ul style="list-style-type: none"> Water tank is empty. 	Fill Tank.
	<ul style="list-style-type: none"> Water tank not fully inserted & locked. 	Push water tank in fully and close the latch.
FILL TANK displayed on LCD, but water tank is full.	<ul style="list-style-type: none"> Water tank is not fully inserted and locked into position. 	Push water tank in fully and close the latch.
No Steam or Hot Water.	<ul style="list-style-type: none"> Machine is not turned on. 	Ensure the machine is plugged in, switched On at the power outlet and the POWER button is On.
No Hot Water.	<ul style="list-style-type: none"> Water tank is empty. 	Fill water tank.
No Steam.	<ul style="list-style-type: none"> Steam Wand is blocked. 	Use the pin on the cleaning tool to clear the holes. If the steam wand continues to be blocked remove the tip of the steam wand using the spanner in the cleaning tool and soak in hot water.
The machine is 'On' but ceases to operate.		Turn machine Off. Wait for 60 minutes and turn machine back On. If problem persists, call Sage® Customer Service UK.
Steam pouring out of group head.		Turn machine Off. Wait for 60 minutes and turn machine back On. If problem persists, call Sage® Customer Service UK.

TROUBLESHOOTING

PROBLEM	POSSIBLE CAUSES	WHAT TO DO
Espresso just drips from the portafilter spouts.	• Coffee is ground too finely.	Use slightly coarser grind.
	• Too much coffee in the filter basket.	Lower dose of coffee using the RAZOR™ dosing tool.
	• The filter basket may be blocked.	Use the fine pin on the provided cleaning tool to clear the outlet hole(s) on the underside of the filter basket. If it continues to be blocked, dissolve a cleaning tablet in hot water and soak filter basket and portafilter in the solution for approx. 20 minutes. Rinse thoroughly.
Espresso runs out too quickly. and/or Pressure gauge not reaching 9 bar.	• The coffee is ground too coarse.	Use slightly finer grind.
	• Not enough coffee in the filter basket.	Increase dose of coffee and use the RAZOR™ dosing tool to trim off excess coffee after tamping.
	• Coffee not tamped firmly enough.	Tamp between 15-20kgs of pressure.
		If the above suggestions do not help, check the machine. Place an EMPTY Dual Wall filter basket into the portafilter (either 1 CUP or 2 CUP). Press the MANUAL button. If the pressure gauge reads over 5 bar the machine is OK. Ensure correct dose by using the RAZOR™ dosing tool. If the dose is correct, make the grind finer. If the pressure gauge reads below 5 bar, contact Sage® Customer Service Centre.
Coffee not hot enough.	• Cups not preheated.	Rinse cups under hot water outlet and place on cup warming tray.
	• Milk not hot enough (if making a cappuccino or latte etc).	Heat milk until side of the jug becomes hot to touch.
No crema.	• Coffee beans are stale.	Buy freshly roasted coffee with a roasted-on date.
	• Using Single Wall Filter Baskets with pre-ground coffee.	Ensure you use Dual Wall Filter Baskets with pre-ground coffee.

TROUBLESHOOTING

PROBLEM	POSSIBLE CAUSES	WHAT TO DO
<p>Espresso runs out around the edge of the portafilter.</p> <p>and/or</p> <p>Portafilter comes out of the group head during an extraction.</p>	<ul style="list-style-type: none"> Portafilter not inserted in the group head correctly. 	<p>Ensure portafilter is rotated to the right until the handle is past the centre and is securely locked in place. Rotating past the centre will not damage the silicone seal.</p>
	<ul style="list-style-type: none"> There are coffee grounds around the filter basket rim. 	<p>Clean excess coffee from the rim of the filter basket to ensure a proper seal in group head.</p>
	<ul style="list-style-type: none"> Filter basket rim is wet or underside of portafilter lugs are wet. Wet surfaces reduce the friction required to hold the portafilter in place whilst under pressure during an extraction. 	<p>Always ensure filter basket and portafilter are dried thoroughly before filling with coffee, tamping and inserting into the group head.</p>
	<ul style="list-style-type: none"> Too much coffee in the filter basket. 	<p>Trim coffee dose using the RAZOR™ dosing tool after tamping.</p>
<p>Unable to set auto start time.</p>	<ul style="list-style-type: none"> Clock not set. 	<p>Set clock.</p>
<p>E1, E2 or E3 error message on LCD screen.</p>	<ul style="list-style-type: none"> An error that cannot be reset by the user has occurred. 	<p>Contact Sage® Customer Service Centre UK.</p>
<p>Coffee puck is sticking to the shower screen.</p>	<ul style="list-style-type: none"> This is normal and happens occasionally. The dry puck feature creates a slight vacuum on top of the coffee puck which will occasionally hold the puck against the shower screen instead of leaving it in the filter basket. 	
<p>Pumps continue to operate / Steam is very wet / Hot water outlet leaks.</p>	<ul style="list-style-type: none"> Using de-mineralised or distilled water which is affecting how the machine is designed to function. 	<p>We recommend using cold, filtered water. We do not recommend using water with no/low mineral content such as de-mineralised or distilled water. If the problem persists, contact Sage® Customer Service Centre.</p>

GUARANTEE

2 YEAR LIMITED GUARANTEE

Sage Appliances guarantees this product for domestic use in specified territories for 2 years from the date of purchase against defects caused by faulty workmanship and materials. During this guarantee period Sage Appliances will repair, replace, or refund any defective product (at the sole discretion of Sage Appliances).

All legal warranty rights under applicable national legislation will be respected and will not be impaired by our guarantee. For full terms and conditions on the guarantee, as well as instructions on how to make a claim, please visit www.sageappliances.com.

GBR

IRE

BRG Appliances Limited
Unit 3.2, Power Road Studios, 114 Power Road, London, W4 5PY
Freephone (UK Landline): +44 (0)808 178 1650
Mobile Calls (National Rate): 0333 0142 970

Sage[®]

www.sageappliances.com

Registered in England & Wales No. 8223512.

• Due to continued product improvement, the products illustrated or photographed in this document may vary slightly from the actual product.
Copyright BRG Appliances 2019.

BES920 UG1 E19