

SAMSUNG

USER MANUAL

SM-T500
SM-T505

Table of Contents

Basics

- 4 Read me first
- 6 Device overheating situations and solutions
- 9 Device layout and functions
- 13 Battery
- 15 SIM or USIM card (nano-SIM card) (SM-T505)
- 17 Memory card (microSD card)
- 20 Turning the device on and off
- 21 Initial setup
- 21 Samsung account
- 23 Transferring data from your previous device (Smart Switch)
- 25 Understanding the screen
- 36 Notification panel
- 38 Entering text

Apps and features

- 41 Installing or uninstalling apps
- 43 Phone
- 47 Contacts
- 51 Messages
- 54 Internet
- 56 Camera
- 68 Gallery
- 73 Multi window
- 75 Samsung Members
- 76 Samsung Notes
- 77 Calendar
- 78 Reminder
- 80 Samsung Flow
- 82 Voice Recorder
- 83 My Files
- 83 Clock
- 85 Calculator
- 85 Game Launcher
- 86 Samsung Kids
- 88 Sharing content
- 90 Google apps

Settings

- 92 Introduction
- 92 Connections
 - 93 Wi-Fi
 - 95 Bluetooth
 - 96 Data saver (SM-T505)
 - 97 Mobile data only apps (SM-T505)
 - 97 Mobile Hotspot and Tethering (SM-T505)
 - 99 More connection settings
- 100 Sound
 - 101 Dolby Atmos (surround sound)
 - 101 Separate app sound
- 101 Notifications
 - 102 App icon badges
- 102 Display
 - 103 Dark mode settings
 - 104 Font size and style
 - 104 Screen saver
- 105 Wallpaper
- 105 Lock screen
 - 106 Smart Lock
- 106 Biometrics and security
 - 107 Face recognition
- 109 Privacy
- 110 Location
- 110 Accounts and backup
 - 111 Users
 - 113 Samsung Cloud

- 114 Google
- 115 Advanced features
 - 116 Motions and gestures
- 116 Digital Wellbeing and parental controls
 - 116 Digital Wellbeing
- 118 Device care
 - 118 Optimising your device
 - 118 Battery
 - 120 Storage
 - 120 Memory
 - 120 Security
- 120 Apps
 - 121 General management
 - 122 Accessibility
 - 122 Software update
 - 123 User manual
 - 123 About tablet

Appendix

- 124 Troubleshooting
- 130 About Hearing Aid Compatibility (HAC)

Basics

Read me first

Please read this manual before using the device to ensure safe and proper use.

- Descriptions are based on the device's default settings.
- Some content may differ from your device depending on the region, service provider, model specifications, or device's software.
- Content (high quality content) that requires high CPU and RAM usage will affect the overall performance of the device. Apps related to the content may not work properly depending on the device's specifications and the environment that it is used in.
- Samsung is not liable for performance issues caused by apps supplied by providers other than Samsung.
- Samsung is not liable for performance issues or incompatibilities caused by edited registry settings or modified operating system software. Attempting to customize the operating system may cause the device or apps to work improperly.
- Software, sound sources, wallpapers, images, and other media provided with this device are licensed for limited use. Extracting and using these materials for commercial or other purposes is an infringement of copyright laws. Users are entirely responsible for illegal use of media.
- You may incur additional charges for data services, such as messaging, uploading and downloading, auto-syncing, or using location services depending on your data plan. For large data transfers, it is recommended to use the Wi-Fi feature. (SM-T505)
- Default apps that come with the device are subject to updates and may no longer be supported without prior notice. If you have questions about an app provided with the device, contact a Samsung Service Center. For user-installed apps, contact service providers.
- Modifying the device's operating system or installing softwares from unofficial sources may result in device malfunctions and data corruption or loss. These actions are violations of your Samsung license agreement and will void your warranty.

- Depending on the region or service provider, a screen protector is attached for protection during production and distribution. Damage to the attached screen protector is not covered by the warranty.
- You can see the touchscreen clearly even in strong outdoor sunlight by automatically adjusting the contrast range based on the surrounding environment. Due to the nature of the product, displaying fixed graphics for extended periods may result in afterimages (screen burn-in) or ghosting.
 - It is recommended not to use fixed graphics on part or all of the touchscreen for extended periods and turn off the touchscreen when not using the device.
 - You can set the touchscreen to turn off automatically when you are not using it. Launch the **Settings** app, tap **Display** → **Screen timeout**, and then select the length of time you want the device to wait before turning off the touchscreen.
 - To set the touchscreen to automatically adjust its brightness based on the surrounding environment, launch the **Settings** app, tap **Display**, and then tap the **Adaptive brightness** switch to activate it.
- Depending on the region or model, some devices are required to receive approval from the Federal Communications Commission (FCC).

If your device is approved by the FCC, you can view the FCC ID of the device. To view the FCC ID, launch the **Settings** app and tap **About tablet** → **Status**. If your device does not have an FCC ID, it means that the device has not been authorized for sale in the U.S. or its territories and may only be brought to the U.S. for the owner's personal use.

Instructional icons



Warning: situations that could cause injury to yourself or others



Caution: situations that could cause damage to your device or other equipment



Notice: notes, usage tips, or additional information

Device overheating situations and solutions

When the device heats up while charging the battery

While charging, the device and the charger may become hot. During wireless charging or fast charging, the device may feel hotter to the touch. This does not affect the device's lifespan or performance and is in the device's normal range of operation. If the battery becomes too hot, the charging speed may decrease or the charger may stop charging.

Do the following when the device heats up:

- Disconnect the charger from the device and close any running apps. Wait for the device to cool down and then begin charging the device again.
- If the lower part of the device overheats, it could be because the connected USB cable is damaged. Replace the damaged USB cable with a new Samsung-approved one.
- When using a wireless charger, do not place foreign materials, such as metal objects, magnets, and magnetic stripe cards, between the device and the wireless charger.



The wireless charging or fast charging feature is only available on supported models.

When the device heats up during use

When you use features or apps that require more power or use them for extended periods, your device may temporarily heat up due to increased battery consumption. Close any running apps and do not use the device for a while.

The following are examples of situations in which the device may overheat. Depending on the functions and apps you use, these examples may not apply to your model.

- During the initial setup after purchase or when restoring data
- When downloading large files

- When using apps that require more power or using apps for extended periods
 - When playing high-quality games for extended periods
 - When recording videos for extended periods
 - When streaming videos while using the maximum brightness setting
 - When connecting to a TV
- While multitasking (or, when running many apps in the background)
 - When using Multi window
 - When updating or installing apps while recording videos
 - When downloading large files during a video call
 - When recording videos while using a navigation app
- When using large amount of data for syncing with the cloud, email, or other accounts
- When using a navigation app in a car while the device is placed in direct sunlight
- When using the mobile hotspot and tethering feature
- When using the device in areas with weak signals or no reception
- When charging the battery with a damaged USB cable
- When the device's multipurpose jack is damaged or exposed to foreign materials, such as liquid, dust, metal powder, and pencil lead
- When you are roaming

Do the following when the device heats up:

- Keep the device updated with the latest software.
- Conflicts between running apps may cause the device to heat up. Restart the device.
- Deactivate the Wi-Fi, GPS, and Bluetooth features when not using them.
- Close apps that increase battery consumption or that run in the background when not in use.
- Delete unnecessary files or unused apps.
- Decrease the screen brightness.
- If the device overheats or feels hot for a prolonged period, do not use it for a while. If the device continues to overheat, contact a Samsung Service Center.

Precautions for device overheating

If you begin to feel uncomfortable due to the device overheating, stop using the device.

When the device heats up, the features and performance may be limited or the device may turn off to cool down. The feature is only available on supported models.

- If the device overheats and reaches a certain temperature, a warning message will appear to prevent device failure, skin irritations and damages, and battery leakage. To lower the device's temperature, the screen brightness and the performance speed will be limited and battery charging will stop. Running apps will be closed and all calling and other features will be limited, except for emergency calls, until the device cools down.
- If the second message appears due to a further increase of the device's temperature, the device will turn off. Do not use the device until the device's temperature drops below the specified level. If the second warning message appears during an emergency call, the call will not be disconnected by a forced shut down.

Precautions for operating environment

Your device may heat up due to the environment in the following conditions. Use caution to avoid shortening the battery's lifespan, damaging the device, or causing a fire.

- Do not store your device in very cold or very hot temperatures.
- Do not expose your device to direct sunlight for extended periods.
- Do not use or store your device for extended periods in very hot areas, such as inside a car in the summertime.
- Do not place the device in any areas that may overheat, such as on an electric heating mat.
- Do not store your device near or in heaters, microwaves, hot cooking equipment, or high pressure containers.
- Do not use a cable whose covering is peeled off or damaged, and do not use any charger or battery that is damaged or malfunctioning.

Device layout and functions

Package contents

Refer to the quick start guide for package contents.



- The items supplied with the device and any available accessories may vary depending on the region or service provider.
- The supplied items are designed only for this device and may not be compatible with other devices.
- Appearances and specifications are subject to change without prior notice.
- You can purchase additional accessories from your local Samsung retailer. Make sure they are compatible with the device before purchase.
- Use only Samsung-approved accessories. Using unapproved accessories may cause the performance problems and malfunctions that are not covered by the warranty.
- Availability of all accessories is subject to change depending entirely on manufacturing companies. For more information about available accessories, refer to the Samsung website.

Device layout

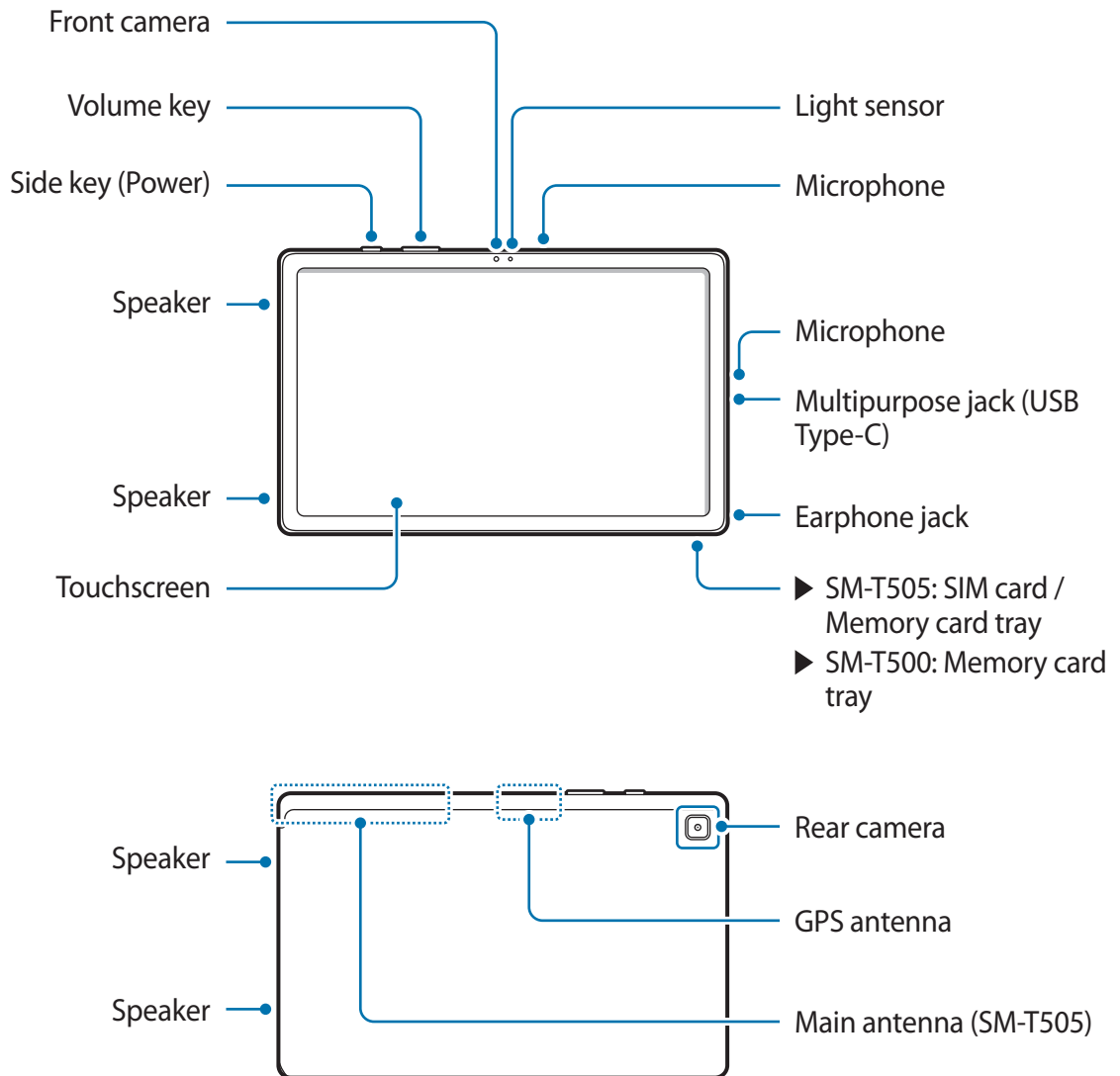



- When using the speakers, such as when playing media files or using speakerphone, do not place the device close to your ears.
- Be careful not to expose the camera lens to a strong light source, such as direct sunlight. If the camera lens is exposed to a strong light source, such as direct sunlight, the camera image sensor may be damaged. A damaged image sensor is irreparable and will cause dots or spots in pictures.
- If you use the device with its glass or acrylic body broken, there may be a risk of injury. Use the device only after it has been repaired at a Samsung Service Center.
- If dust or foreign materials enter the microphone, speaker, or receiver, the device's sound may become quiet or certain features may not work. If you attempt to remove the dust or foreign materials with a sharp object, the device may be damaged and its appearance may be affected.



- Connectivity problems and battery drain may occur in the following situations:
 - If you attach metallic stickers on the antenna area of the device
 - If you attach a device cover made with metallic material to the device
 - If you cover the device's antenna area with your hands or other objects while using certain features, such as calls or the mobile data connection (SM-T505)
- Using a Samsung-approved screen protector is recommended. Unapproved screen protectors may cause the sensors to malfunction.
- Do not cover the light sensor area with screen accessories, such as a screen protector, stickers, or a cover. Doing so may cause the sensor to malfunction.
- Do not allow water to contact the touchscreen. The touchscreen may malfunction in humid conditions or when exposed to water.

Hard keys

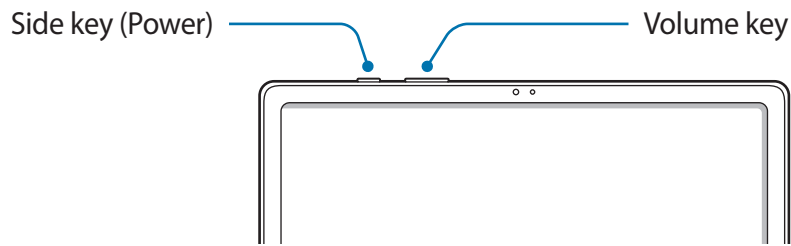

Key	Function
Side key	<ul style="list-style-type: none"> • Press and hold to turn the device on or off. • Press to turn on or lock the screen. • Press twice to launch the app or feature you set.
Volume key	<ul style="list-style-type: none"> • Press to adjust the device volume.

Soft buttons

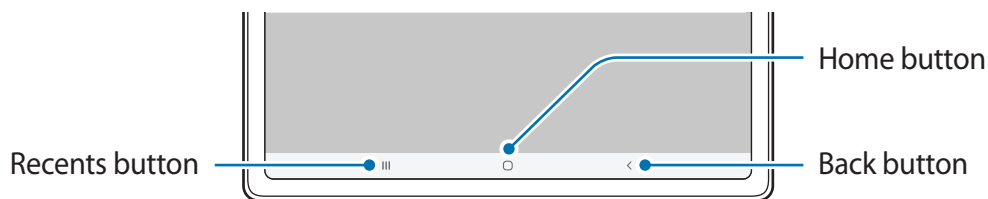

When you turn on the screen, the soft buttons will appear at the bottom of the screen. The soft buttons are set to the Recents button, Home button, and Back button by default. Refer to [Navigation bar \(soft buttons\)](#) for more information.

Battery

Charging the battery

Charge the battery before using it for the first time or when it has been unused for extended periods.



Use only Samsung-approved battery, charger, and cable specifically designed for your device. Incompatible battery, charger, and cable can cause serious injuries or damage to your device.



- Connecting the charger improperly may cause serious damage to the device. Any damage caused by misuse is not covered by the warranty.
- Use only USB Type-C cable supplied with the device. The device may be damaged if you use Micro USB cable.



To save energy, unplug the charger when not in use. The charger does not have a power switch, so you must unplug the charger from the electric socket when not in use to avoid wasting power. The charger should remain close to the electric socket and easily accessible while charging.

- 1 Connect the USB cable to the USB power adaptor.
- 2 Plug the USB cable into the device's multipurpose jack.

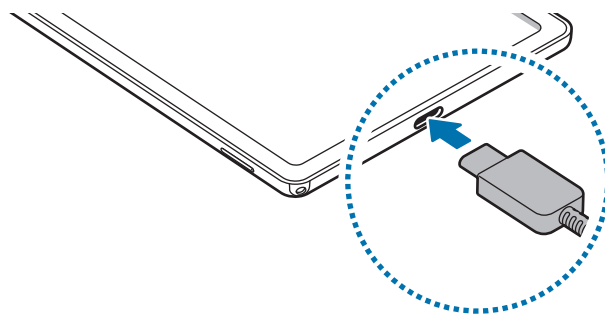

- 3 Plug the USB power adaptor into an electric socket.
- 4 After fully charging, disconnect the charger from the device. Then, unplug the charger from the electric socket.

Reducing the battery consumption

Your device provides various options that help you conserve battery power.

- Optimize the device using the device care feature.
- When you are not using the device, turn off the screen by pressing the Side key.
- Activate power saving mode.
- Close unnecessary apps.
- Deactivate the Bluetooth feature when not in use.
- Deactivate auto-syncing of apps that need to be synced.
- Decrease the backlight time.
- Decrease the screen brightness.

Battery charging tips and precautions

- When the battery power is low, the battery icon appears empty.
- If the battery is completely discharged, the device cannot be turned on immediately when the charger is connected. Allow a depleted battery to charge for a few minutes before turning on the device.
- If you use multiple apps at once, network apps, or apps that need a connection to another device, the battery will drain quickly. To avoid losing power during a data transfer, always use these apps after fully charging the battery.
- Using a power source other than the charger, such as a computer, may result in a slower charging speed due to a lower electric current.
- The device can be used while it is charging, but it may take longer to fully charge the battery.
- If the device receives an unstable power supply while charging, the touchscreen may not function. If this happens, unplug the charger from the device.
- While charging, the device and the charger may heat up. This is normal and should not affect the device's lifespan or performance. If the battery gets hotter than usual, the charger may stop charging. If this occurs during wireless charging, disconnect the device from the charger to let it cool down, then charge the device again later.
- If you charge the device while the multipurpose jack is wet, the device may be damaged. Thoroughly dry the multipurpose jack before charging the device.
- If the device is not charging properly, take the device and the charger to a Samsung Service Center.

Fast charging

The device has a built-in fast charging feature. You can charge the battery more quickly while the device or its screen is turned off.

Increasing the charging speed

To increase the charging speed, turn the device or its screen off when you charge the battery. If the fast charging feature is not activated, launch the **Settings** app, tap **Device care** → **Battery** → **Charging**, and then tap the **Fast charging** switch to activate it.



- While charging, you cannot activate or deactivate this feature.
- You cannot use the built-in fast charging feature when you charge the battery using a standard battery charger.
- If the device heats up or the ambient air temperature rises, the charging speed may decrease automatically. This is a normal operating condition to prevent damage to the device.

SIM or USIM card (nano-SIM card) (SM-T505)

Installing the SIM or USIM card

Insert the SIM or USIM card provided by the mobile telephone service provider.



- Use only a nano-SIM card.
- Use caution not to lose or let others use the SIM or USIM card. Samsung is not responsible for any damages or inconveniences caused by lost or stolen cards.



Some services that require a network connection may not be available depending on the service provider.

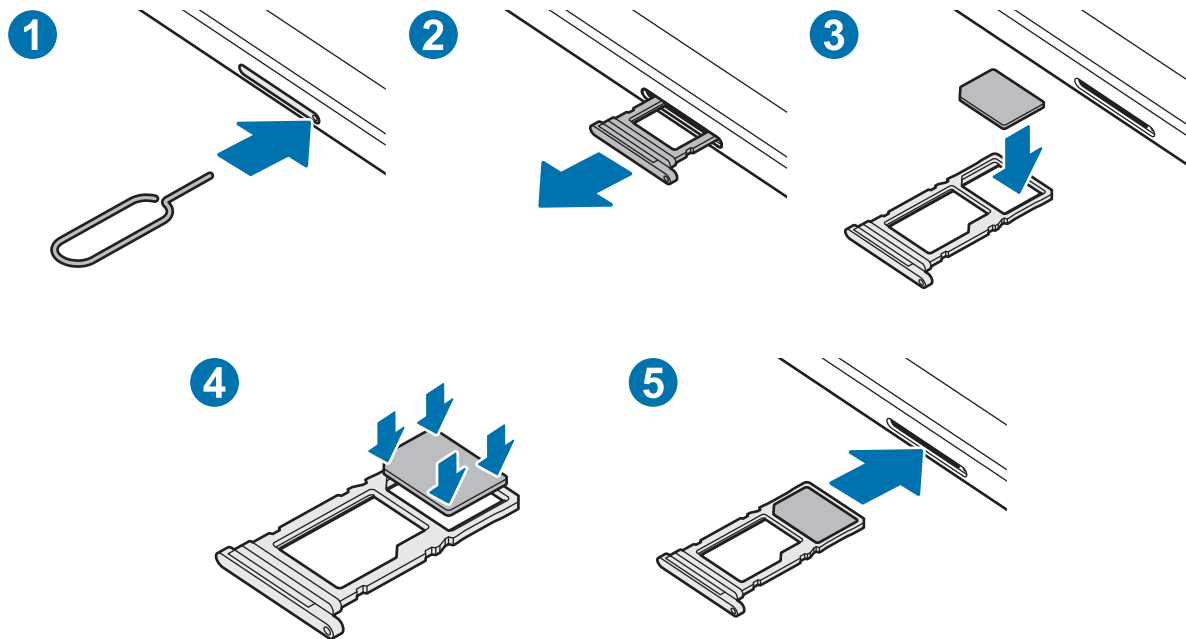

1 Insert the ejection pin into the hole on the tray to loosen the tray.

⚠ Ensure that the ejection pin is perpendicular to the hole. Otherwise, the device may be damaged.

2 Pull out the tray gently from the tray slot.

3 Place the SIM or USIM card on the tray with the gold-colored contacts facing downwards.

4 Gently press the SIM or USIM card into the tray to secure it.

⚠ If the card is not fixed firmly into the tray, the SIM card may leave or fall out of the tray.

5 Insert the tray back into the tray slot.



⚠

- If you insert the tray into your device while the tray is wet, your device may be damaged. Always make sure the tray is dry.
- Fully insert the tray into the tray slot to prevent liquid from entering your device.

Memory card (microSD card)

Installing a memory card

Your device's memory card capacity may vary from other models and some memory cards may not be compatible with your device depending on the memory card manufacturer and type. To view your device's maximum memory card capacity, refer to the Samsung website.

- 
 - Some memory cards may not be fully compatible with the device. Using an incompatible card may damage the device or the memory card, or corrupt the data stored in it.
 - Use caution to insert the memory card right-side up.
- 
 - The device supports the FAT and the exFAT file systems for memory cards. When inserting a card formatted in a different file system, the device will ask to reformat the card or will not recognize the card. To use the memory card, you must format it. If your device cannot format or recognize the memory card, contact the memory card manufacturer or a Samsung Service Center.
 - Frequent writing and erasing of data shortens the lifespan of memory cards.
 - When inserting a memory card into the device, the memory card's file directory appears in the **My Files** → **SD card** folder.

► SM-T505:

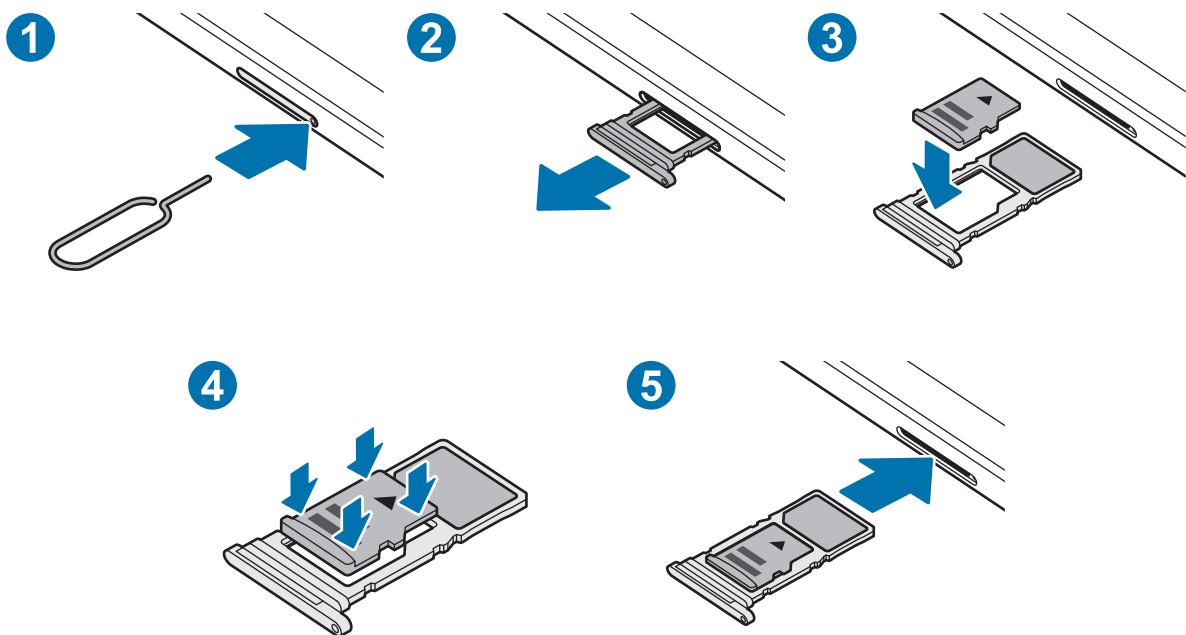

► SM-T500:

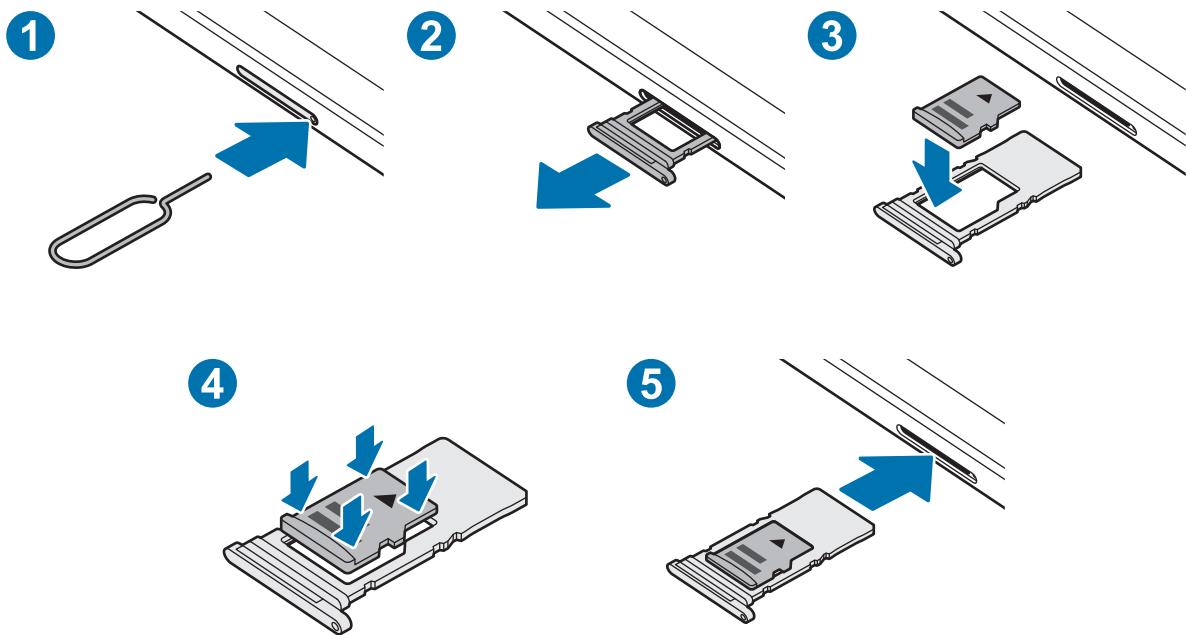

1 Insert the ejection pin into the hole on the tray to loosen the tray.

⚠ Ensure that the ejection pin is perpendicular to the hole. Otherwise, the device may be damaged.

2 Pull out the tray gently from the tray slot.

⚠ When you remove the tray from the device, the mobile data connection will be disabled. (SM-T505)

3 Place a memory card on the tray with the gold-colored contacts facing downwards.

4 Gently press the memory card into the tray to secure it.

⚠ If the card is not fixed firmly into the tray, the memory card may leave or fall out of the tray.

5 Insert the tray back into the tray slot.

⚠

- If you insert the tray into your device while the tray is wet, your device may be damaged. Always make sure the tray is dry.
- Fully insert the tray into the tray slot to prevent liquid from entering your device.

Removing the memory card

Before removing the memory card, first unmount it for safe removal.

Launch the **Settings** app and tap **Device care** → **Storage** → **Advanced** → **SD card** → **Unmount**.



Do not remove external storage, such as a memory card or USB storage, while the device is transferring or accessing information, or right after transferring data. Doing so can cause data to be corrupted or lost or cause damage to the external storage or device. Samsung is not responsible for losses, including loss of data, resulting from the misuse of external storage devices.

Formatting the memory card

A memory card formatted on a computer may not be compatible with the device. Format the memory card on the device.

Launch the **Settings** app and tap **Device care** → **Storage** → **Advanced** → **SD card** → **Format**.



Before formatting the memory card, remember to make backup copies of all important data stored in the memory card. The manufacturer's warranty does not cover loss of data resulting from user actions.

Turning the device on and off



Follow all posted warnings and directions from authorized personnel in areas where the use of wireless devices is restricted, such as airplanes and hospitals.

Turning the device on

Press and hold the Side key for a few seconds to turn on the device.

When you turn on your device for the first time or after performing a data reset, follow the on-screen instructions to set up your device.

Turning the device off

- 1 To turn off the device, press and hold the Side key. Alternatively, open the notification panel and tap .

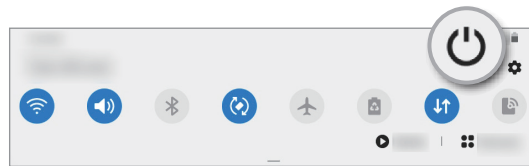

- 2 Tap **Power off**.

To restart the device, tap **Restart**.

Forcing restart

If your device is frozen and unresponsive, press and hold the Side key and the Volume Down key simultaneously for more than 7 seconds to restart it.

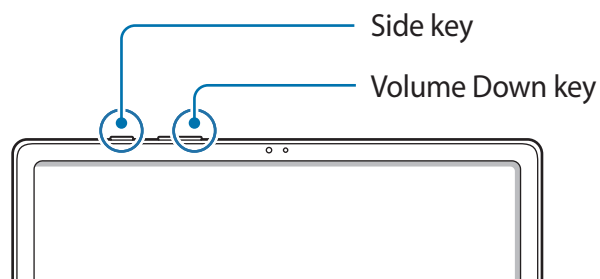

Initial setup

When you turn on your device for the first time or after performing a data reset, follow the on-screen instructions to set up your device.



If you do not connect to a Wi-Fi network, you may not be able to set up some device features during the initial setup.

Samsung account

Your Samsung account is an integrated account service that allows you to use a variety of Samsung services provided by mobile devices, TVs, and the Samsung website.

To check the list of services that can be used with your Samsung account, launch the **Settings** app and tap **Accounts and backup** → **Accounts** → **Samsung account** → **Apps and services**. Alternatively, visit account.samsung.com.

Creating a Samsung account

If you do not have a Samsung account, you should create one.

1 Launch the **Settings** app and tap **Accounts and backup** → **Accounts** → **Add account** → **Samsung account**.

Alternatively, launch the **Settings** app and tap .

2 Tap **Create account**.

3 Follow the on-screen instructions to complete creating your account.

Signing in to your Samsung account

If you already have a Samsung account, sign in to your Samsung account. You can also sign in using your Google account.

1 Launch the **Settings** app and tap **Accounts and backup** → **Accounts** → **Add account** → **Samsung account**.

Alternatively, launch the **Settings** app and tap .

2 Enter your Samsung account ID and password and tap **Sign in**.

If you want to sign in using your Google account, tap **Continue with Google**.

3 Follow the on-screen instructions to complete signing in to your Samsung account.

Finding your ID and resetting your password

If you forget your Samsung account ID or password, tap **Find ID** or **Reset password** on the Samsung account sign-in screen. You can find your ID or reset your password after you enter the required information.

Removing your Samsung account

When you remove your Samsung account from the device, your data, such as contacts or events, will also be removed.

1 Launch the **Settings** app and tap **Accounts and backup** → **Accounts**.

2 Tap **Samsung account** → **Personal info** →  → **Sign out**.

3 Tap **Sign out**, enter your Samsung account password, and then tap **OK**.

Transferring data from your previous device (Smart Switch)

You can use Smart Switch to transfer data from your previous device to your new device.

Launch the **Settings** app and tap **Accounts and backup** → **Smart Switch**.



- This feature may not be supported on some devices or computers.
- Limitations apply. Visit www.samsung.com/smartswitch for details. Samsung takes copyright seriously. Only transfer content that you own or have the right to transfer.

Transferring data wirelessly

Transfer data from your previous device to your device wirelessly via Wi-Fi Direct.

- 1 On the previous device, launch **Smart Switch**.
If you do not have the app, download it from **Galaxy Store** or **Play Store**.
- 2 On your device, launch the **Settings** app and tap **Accounts and backup** → **Smart Switch**.
- 3 Place the devices near each other.
- 4 On the previous device, tap **Send data** → **Wireless**.
- 5 On the previous device, tap **Allow**.
- 6 On your device, select an item to bring and tap **Transfer**.
- 7 Follow the on-screen instructions to transfer data from your previous device.
After the data is done transferring, you can view a list of the transferred data on your device.

Backing up and restoring data using external storage

Transfer data using external storage, such as a microSD card.

- 1 Back up data from your previous device to external storage.
- 2 Insert or connect the external storage device to your device.
- 3 On your device, launch the **Settings** app and tap **Accounts and backup** → **Smart Switch** →  → **Restore**.
- 4 Follow the on-screen instructions to transfer data from external storage.

Transferring backup data from a computer

Transfer data between your device and a computer. You must download the Smart Switch computer version app from www.samsung.com/smartswitch. Back up data from your previous device to a computer and import the data to your device.

- 1 On the computer, visit www.samsung.com/smartswitch to download Smart Switch.
- 2 On the computer, launch Smart Switch.
 If your previous device is not a Samsung device, back up data to a computer using a program provided by the device's manufacturer. Then, skip to the fifth step.
- 3 Connect your previous device to the computer using the device's USB cable.
- 4 On the computer, follow the on-screen instructions to back up data from the device. Then, disconnect your previous device from the computer.
- 5 Connect your device to the computer using the USB cable.
- 6 On the computer, follow the on-screen instructions to transfer data to your device.

Understanding the screen

Controlling the touchscreen



- Do not allow the touchscreen to come into contact with other electrical devices. Electrostatic discharges can cause the touchscreen to malfunction.
- To avoid damaging the touchscreen, do not tap it with anything sharp or apply excessive pressure to it with your fingertips.
- It is recommended not to use fixed graphics on part or all of the touchscreen for extended periods. Doing so may result in afterimages (screen burn-in) or ghosting.



- The device may not recognize touch inputs close to the edges of the screen, which are outside of the touch input area.
- It is recommended to use fingers when you use the touchscreen.

Tapping

Tap the screen.

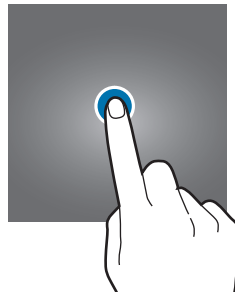

Tapping and holding

Tap and hold the screen for approximately 2 seconds.

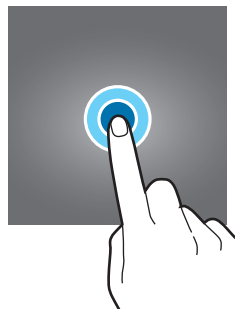

Dragging

Tap and hold an item and drag it to the target position.

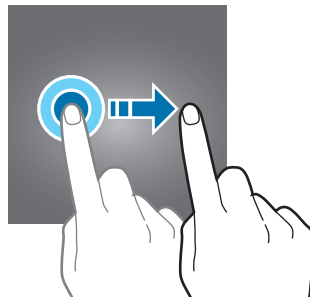

Double-tapping

Double-tap the screen.

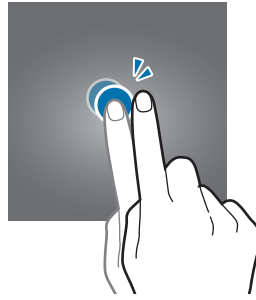

Swiping

Swipe upwards, downwards, to the left, or to the right.

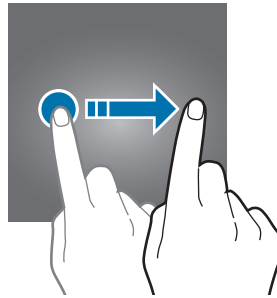

Spreading and pinching

Spread two fingers apart or pinch on the screen.

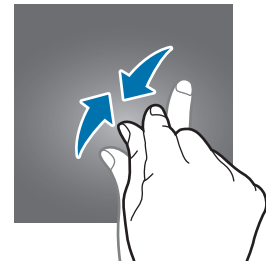

Navigation bar (soft buttons)

When you turn on the screen, the soft buttons will appear on the navigation bar at the bottom of the screen. The soft buttons are set to the Recents button, Home button, and Back button by default. The functions of the buttons can change according to the app currently being used or usage environment.

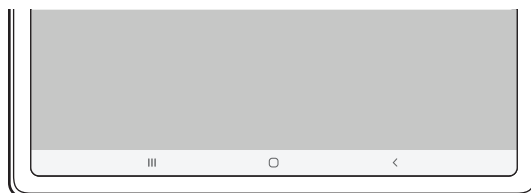

Button	Function
Recents	<ul style="list-style-type: none"> • Tap to open the list of recent apps.
○ Home	<ul style="list-style-type: none"> • Tap to return to the Home screen. • Tap and hold to launch the Google Assistant app.
< Back	<ul style="list-style-type: none"> • Tap to return to the previous screen.

Hiding the navigation bar

View files or use apps on a wider screen by hiding the navigation bar.

Launch the **Settings** app, tap **Display** → **Navigation bar**, and then tap **Swipe gestures** under **Navigation type**. The navigation bar will be hidden and the gesture hints will appear. Tap **More options** and select an option you want.

- **Swipe from bottom:** The gesture hints will appear where the soft buttons are located. To use the soft buttons, drag the gesture hint of the desired button upwards.
- **Swipe from sides and bottom:**
 - Swipe up from the bottom of the screen to move to the Home screen.
 - Swipe up and hold to view the list of recent apps.
 - Swipe inward from either side of the screen to return to the previous screen.
 - Swipe inward from one of the bottom corners to launch the **Google Assistant** app.

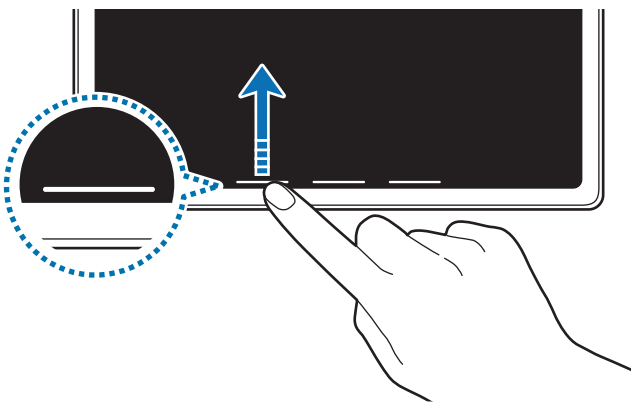

Swipe from bottom

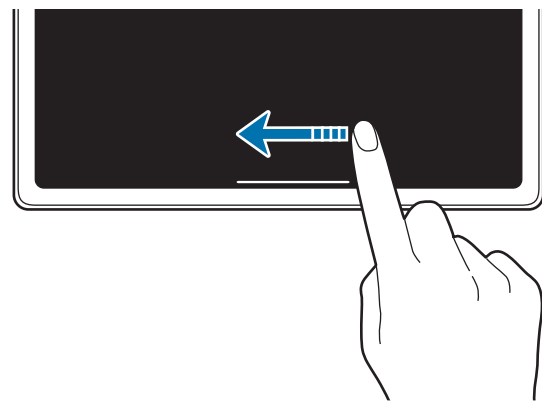

Swipe from sides and bottom

If you want to hide the gesture hints at the bottom of the screen, tap the **Gesture hints** switch to deactivate it.

Home screen and Apps screen

The Home screen is the starting point for accessing all of the device's features. It displays widgets, shortcuts to apps, and more.

The Apps screen displays icons for all apps, including newly installed apps.



The screen may appear differently depending on the region or service provider.

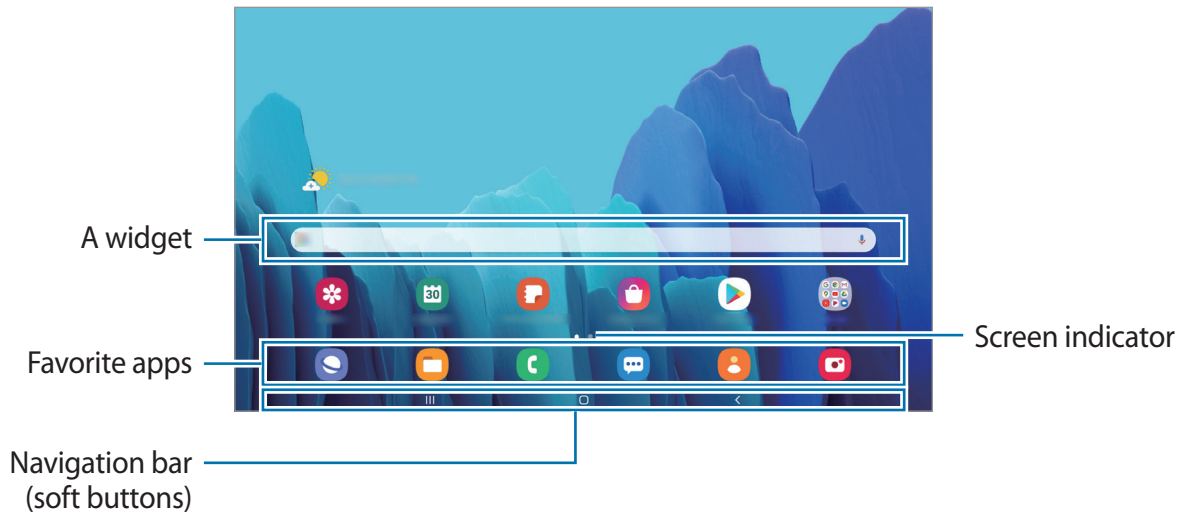

Switching between Home and Apps screens

On the Home screen, swipe upwards or downwards to open the Apps screen.

To return to the Home screen, swipe upwards or downwards on the Apps screen.

Alternatively, tap the Home button or the Back button.





If you add the Apps button on the Home screen, you can open the Apps screen by tapping the button. On the Home screen, tap and hold an empty area, tap **Home screen settings**, and then tap the **Apps button** switch to activate it. The Apps button will be added at the bottom of the Home screen.



Launching Finder

Search for content on the device quickly.

- 1 On the Apps screen, tap . Alternatively, open the notification panel, swipe downwards, and then tap .



- 2 Enter a keyword.

Apps and content on your device will be searched.

If you tap  on the keyboard, you can search for more content.

Moving items

Tap and hold an item, and then drag it to a new location. To move the item to another panel, drag it to the side of the screen.

To add a shortcut to an app on the Home screen, tap and hold an item on the Apps screen, and then tap **Add to Home**. A shortcut to the app will be added on the Home screen.

You can also move frequently used apps to the shortcuts area at the bottom of the Home screen.

Creating folders

Create folders and gather similar apps to quickly access and launch apps.

On the Home screen or the Apps screen, tap and hold an app, and then drag it over another app.

A new folder containing the selected apps will be created. Tap **Folder name** and enter a folder name.

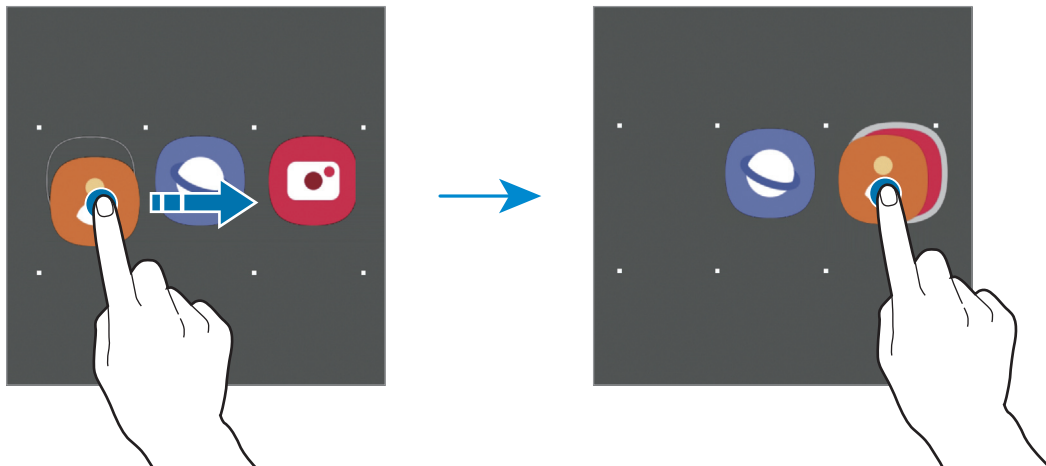

- **Adding more apps**

Tap **+** on the folder. Tick the apps to add and tap **Done**. You can also add an app by dragging it to the folder.

- **Moving apps from a folder**

Tap and hold an app to drag it to a new location.

- **Deleting a folder**

Tap and hold a folder, and then tap **Delete folder**. Only the folder will be deleted. The folder's apps will be relocated to the Apps screen.

Editing the Home screen

On the Home screen, tap and hold an empty area, or pinch your fingers together to access the editing options. You can set the wallpaper, add widgets, and more. You can also add, delete, or rearrange Home screen panels.

- Adding panels: Swipe to the left, and then tap \oplus .
- Moving panels: Tap and hold a panel preview, and then drag it to a new location.
- Deleting panels: Tap 🗑 on the panel.

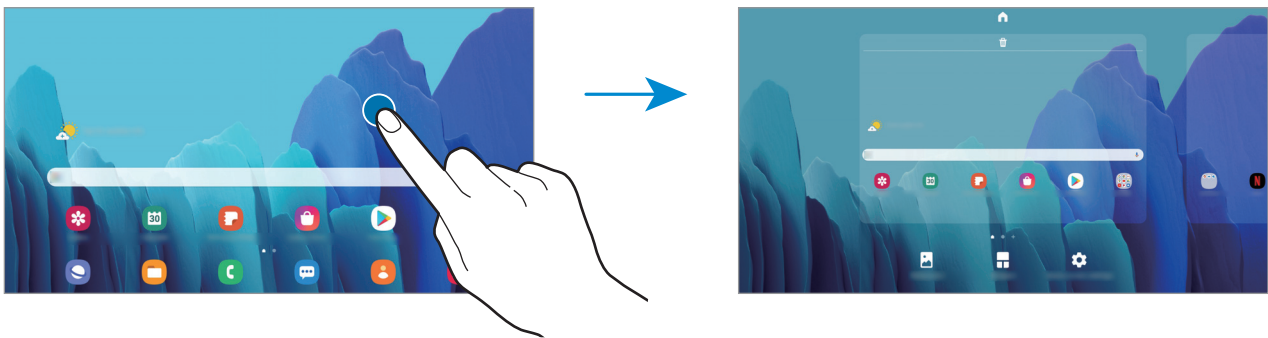

- **Wallpaper:** Change the wallpaper settings for the Home screen and the locked screen.
- **Widgets:** Widgets are small apps that launch specific app functions to provide information and convenient access on your Home screen. Tap and hold a widget, and then drag it to the Home screen. The widget will be added on the Home screen.
- **Home screen settings:** Configure settings for the Home screen, such as the screen grid or layout.

Displaying all apps on the Home screen

Without using a separate Apps screen, you can set the device to display all apps on the Home screen. On the Home screen, tap and hold an empty area, and then tap **Home screen settings** → **Home screen layout** → **Home screen only** → **Apply**.

You can now access all your apps by swiping to the left on the Home screen.

Indicator icons

Indicator icons appear on the status bar at the top of the screen. The icons listed in the table below are most common.



- The status bar may not appear at the top of the screen in some apps. To display the status bar, drag down from the top of the screen.
- Some indicator icons appear only when you open the notification panel.
- The indicator icons may appear differently depending on the service provider or model.

Icon	Meaning
	No signal
	Signal strength
	Roaming (outside of normal service area)
	GPRS network connected
	EDGE network connected
	UMTS network connected
	HSDPA network connected
	HSPA+ network connected
	LTE network connected
	Wi-Fi connected
	Bluetooth feature activated
	Location services being used
	Call in progress
	Missed call
	New text or multimedia message
	Alarm activated
	Mute mode activated
	Airplane mode activated
	Error occurred or caution required
	Battery charging
	Battery power level

Lock screen

Pressing the Side key turns off the screen and locks it. Also, the screen turns off and automatically locks if the device is not used for a specified period.

To unlock the screen, swipe in any direction when the screen turns on.

If the screen is off, press the Side key to turn on the screen. Alternatively, double-tap the screen.

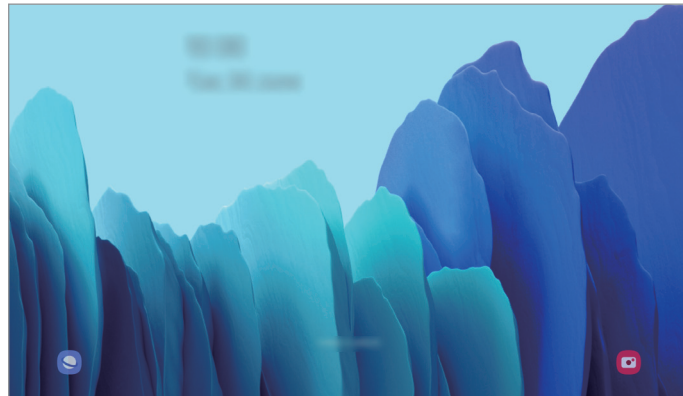

Locked screen

Changing the screen lock method

To change the screen lock method, launch the **Settings** app, tap **Lock screen** → **Screen lock type**, and then select a method.

When you set a pattern, PIN, password, or your biometric data for the screen lock method, you can protect your personal information by preventing others from accessing your device. After setting the screen lock method, the device will require an unlock code whenever unlocking it.

- **Swipe:** Swipe in any direction on the screen to unlock it.
- **Pattern:** Draw a pattern with four or more dots to unlock the screen.
- **PIN:** Enter a PIN with at least four numbers to unlock the screen.
- **Password:** Enter a password with at least four characters, numbers, or symbols to unlock the screen.
- **None:** Do not set a screen lock method.
- **Face:** Register your face to unlock the screen. Refer to [Face recognition](#) for more information.



You can set your device to perform a factory data reset if you enter the unlock code incorrectly several times in a row and reach the attempt limit. Launch the **Settings** app, tap **Lock screen** → **Secure lock settings**, unlock the screen using the preset screen lock method, and then tap the **Auto factory reset** switch to activate it.

Screen capture

Capture a screenshot while using the device and write on, draw on, crop, or share the captured screen. You can capture the current screen and scrollable area.





Press and hold the Volume Down key and the Side key simultaneously. You can view the captured screenshots in **Gallery**.



It is not possible to capture a screenshot while using some apps and features.

After capturing a screenshot, use the following options on the toolbar at the bottom of the screen:



- : Capture the current content and the hidden content on an elongated page, such as a webpage. When you tap , the screen will automatically scroll down and more content will be captured.
- : Write or draw on the screenshot or crop a portion from the screenshot. You can view the cropped area in **Gallery**.
- : Share the screenshot with others.



If the options are not visible on the captured screen, launch the **Settings** app, tap **Advanced features** → **Screenshots**, and then tap the **Screenshot toolbar** switch to activate it.

Notification panel

When you receive new notifications, indicator icons appear on the status bar. To see more information about the icons, open the notification panel and view the details.

To open the notification panel, drag the status bar downwards. To close the notification panel, swipe upwards on the screen.

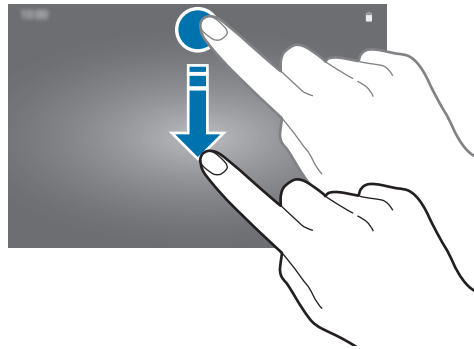

You can use the following functions on the notification panel.

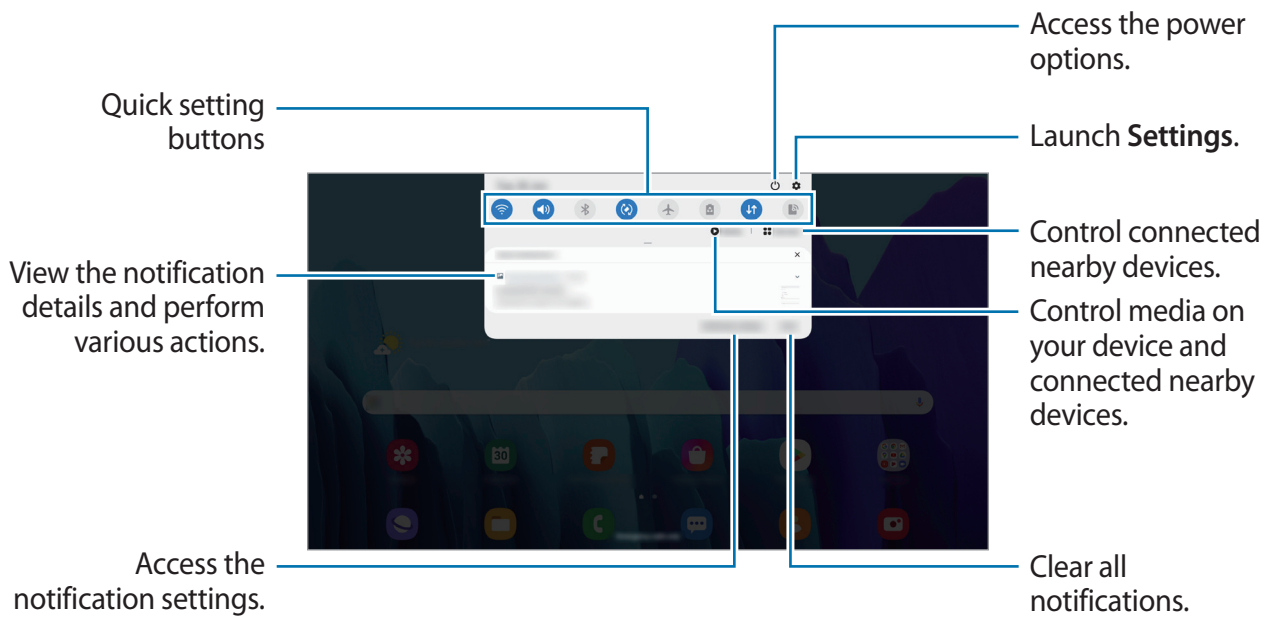

Using quick setting buttons

Tap quick setting buttons to activate certain features. Swipe downwards on the notification panel to view more buttons.

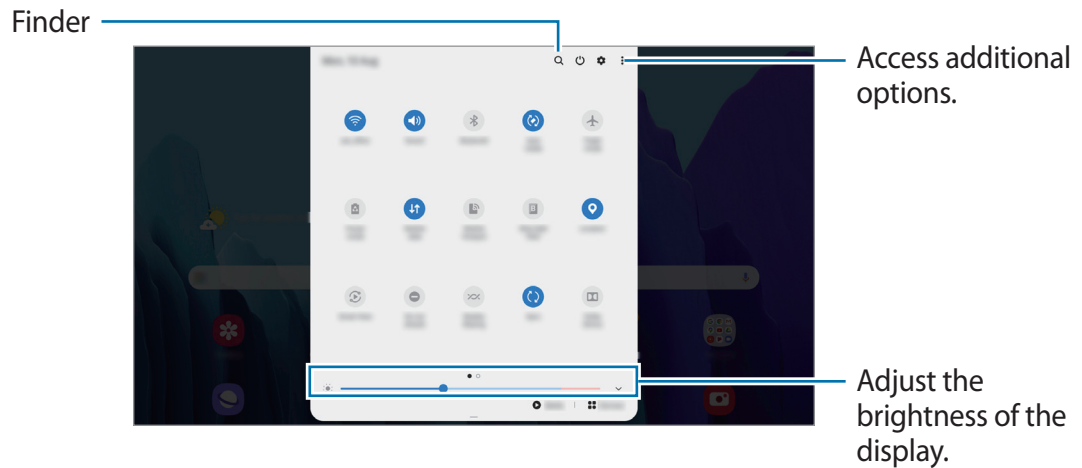

To change feature settings, tap the text under each button. To view more detailed settings, tap and hold a button.

To rearrange buttons, tap  → **Button order**, tap and hold a button, and then drag it to another location.

Controlling media playback

Take control of music or video playback easily using the Media feature. You can also continue playback on another device.

- 1 Open the notification panel and tap **Media**.
- 2 Tap the icons on the controller to control the playback.
To continue the playback on another device, tap  and select a device you want.

Controlling nearby devices

Launch quickly and take control of nearby connected devices on the notification panel.

- 1 Open the notification panel and tap **Devices**.
Nearby connected devices will appear.
- 2 Select a nearby device to control it.

Entering text

Keyboard layout

A keyboard appears automatically when you enter text to send emails, create notes, and more.



Text entry is not supported in some languages. To enter text, you must change the input language to one of the supported languages.

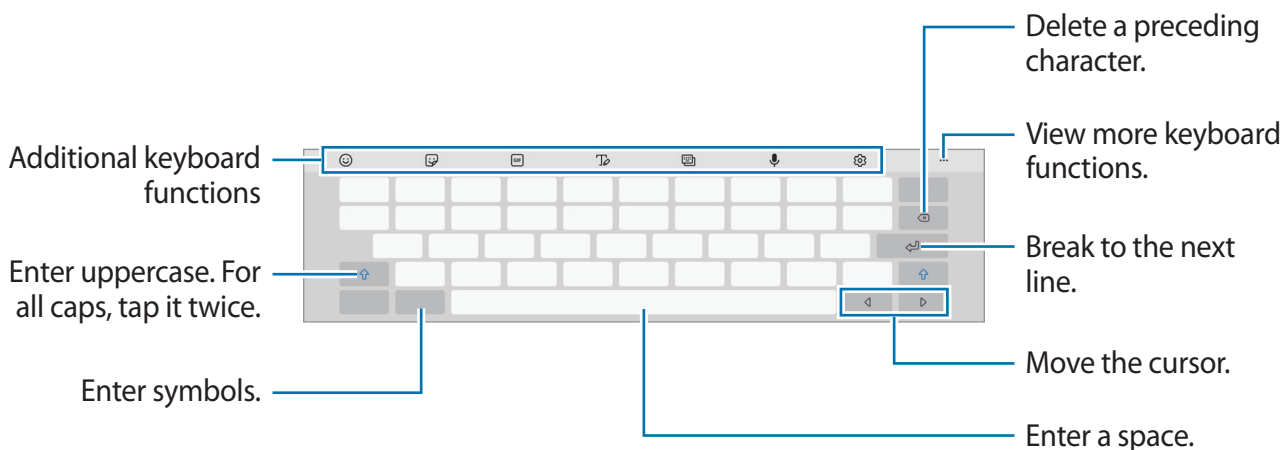



Changing the input language

Tap  → **Languages and types** → **Manage input languages** and select the languages to use. When you select two or more languages, you can switch between the input languages by swiping to the left or right on the space key.

Changing the keyboard

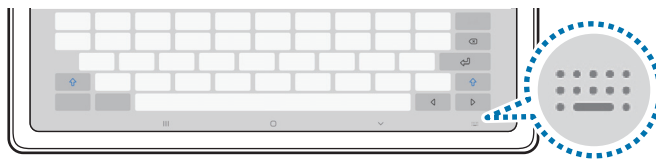
On the navigation bar, tap  to change the keyboard.



To change the keyboard type, tap  → **Languages and types**, select a language, and then select the keyboard type you want.







If the keyboard button () does not appear on the navigation bar, launch the **Settings** app, tap **General management** → **Language and input** → **On-screen keyboard**, and then tap the **Show Keyboard button** switch to activate it.

Additional keyboard functions









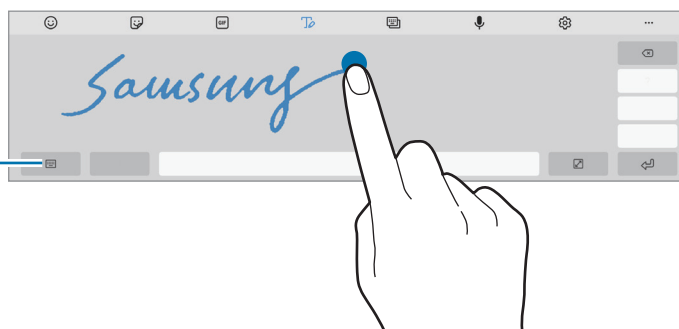



Some features may not be available depending on the region or service provider.



-  : Enter emoticons.
-  : Enter stickers.
-  : Attach animated GIFs.
-  : Switch to handwriting mode.

Switch to the standard keyboard.



- : Change the keyboard mode.
- : Enter text by voice.
- : Change the keyboard settings.
-  → : Search for content and enter it.
-  → : Translate text and enter it.
-  → : Open the text editing panel.
-  → : Change the keyboard size.

Copying and pasting

- 1 Tap and hold over text.
- 2 Drag  or  to select the desired text, or tap **Select all** to select all text.
- 3 Tap **Copy** or **Cut**.
The selected text is copied to the clipboard.
- 4 Tap and hold where the text is to be inserted and tap **Paste**.

Apps and features

Installing or uninstalling apps

Galaxy Store

Purchase and download apps. You can download apps that are specialized for Samsung Galaxy devices.

Launch the **Galaxy Store** app.



This app may not be available depending on the region or service provider.

Installing apps

Browse apps by category or tap **Q** to search for a keyword.

Select an app to view information about it. To download free apps, tap **Install**. To purchase and download apps where charges apply, tap the price and follow the on-screen instructions.



To change the auto update settings, tap **≡** → **⚙** → **Auto update apps**, and then select an option.

Play Store

Purchase and download apps.

Launch the **Play Store** app.

Installing apps

Browse apps by category or search for apps by keyword.

Select an app to view information about it. To download free apps, tap **Install**. To purchase and download apps where charges apply, tap the price and follow the on-screen instructions.



To change the auto update settings, tap **≡** → **Settings** → **Auto-update apps**, and then select an option.

Managing apps

Uninstalling or disabling apps

Tap and hold an app and select an option.

- **Uninstall:** Uninstall downloaded apps.
- **Disable:** Disable selected default apps that cannot be uninstalled from the device.



Some apps may not support this feature.

Enabling apps

Launch the **Settings** app, tap **Apps** → ▼ → **Disabled**, select an app, and then tap **Enable**.

Setting app permissions

For some apps to operate properly, they may need permission to access or use information on your device.

To view your app permission settings, launch the **Settings** app and tap **Apps**. Select an app and tap **Permissions**. You can view the app's permissions list and change its permissions.

To view or change app permission settings by permission category, launch the **Settings** app and tap **Apps** → ⋮ → **Permission manager**. Select an item and select an app.



If you do not grant permissions to apps, the basic features of the apps may not function properly.

Phone



Introduction

Make or answer voice and video calls.



To make a call and send a text message, launch the **Settings** app, tap **Advanced features**, and then tap the **Call & text on other devices** switch to activate it. You must register and sign in to the same Samsung account on your device and the other device. Some calling and messaging features may not be available.

Making calls

- 1 Launch the **Phone** app and tap **Keypad**.
- 2 Enter a phone number.
- 3 Tap  to make a voice call, or tap  to make a video call.

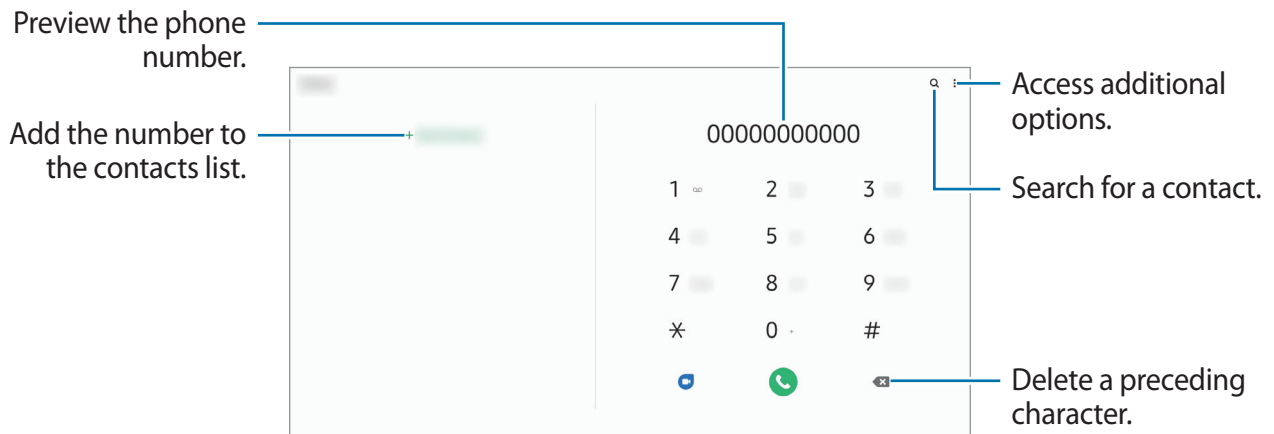

Making calls from call logs or contacts list

Launch the **Phone** app, tap **Recents** or **Contacts**, and then swipe to the right on a contact or a phone number to make a call.

If this feature is deactivated, launch the **Settings** app, tap **Advanced features** → **Motions and gestures**, and then tap the **Swipe to call or send messages** switch to activate it.

Using speed dial

Set speed dial numbers to quickly make calls.

To set a number to speed dial, launch the **Phone** app, tap **Keypad** or **Contacts** →  → **Speed dial numbers**, select a speed dial number, and then add a phone number.

To make a call, tap and hold a speed dial number on the keypad. For speed dial numbers 10 and up, tap the first digit(s) of the number, and then tap and hold the last digit.

For example, if you set the number **123** as a speed dial number, tap **1**, tap **2**, and then tap and hold **3**.

Making an international call

- 1 Launch the **Phone** app and tap **Keypad**.
- 2 Tap and hold **0** until the + sign appears.
- 3 Enter the country code, area code, and phone number, and then tap .

Receiving calls



Answering a call

When a call comes in, drag  outside the large circle.

Rejecting a call

When a call comes in, drag  outside the large circle.

To send a message when rejecting an incoming call, drag the **Send message** bar upwards and select a message to send. If the **Add reminder** switch is activated, a reminder will be saved to alert you of the rejected call one hour later.



To create various rejection messages, launch the **Phone** app, tap  → **Settings** → **Quick decline messages**, enter a message, and then tap .

Missed calls

If a call is missed, the  icon appears on the status bar. Open the notification panel to view the list of missed calls. Alternatively, launch the **Phone** app and tap **Recents** to view missed calls.

Blocking phone numbers

Block calls from specific numbers added to your block list.



- 1 Launch the **Phone** app and tap  → **Settings** → **Block numbers**.
- 2 Tap **Recents** or **Contacts**, select contacts or phone numbers, and then tap **Done**.
To manually enter a number, tap **Add phone number**, enter a phone number, and then tap .

When blocked numbers try to contact you, you will not receive notifications. The calls will be logged in the call log.



You can also block incoming calls from people that do not show their caller ID. Tap the **Block unknown/hidden numbers** switch to activate the feature.

Options during calls

- : Access additional options.
- **Add call**: Dial a second call. The first call will be put on hold. When you end the second call, the first call will be resumed.
- **Message**: Send a message to the caller.
- **Bluetooth**: Switch to a Bluetooth headset if it is connected to the device.
- **Hold call**: Hold a call. Tap **Resume call** to retrieve the held call.
- **Mute**: Turn off the microphone so that the other party cannot hear you.
- **Keypad / Hide**: Open or close the keypad.
- : End the current call.



The available options may vary depending on the region or service provider.

Adding a phone number to Contacts

Adding a phone number to Contacts from the keypad

- 1 Launch the **Phone** app and tap **Keypad**.
- 2 Enter the number.
- 3 Tap **Add to Contacts**.
- 4 Tap **Create new contact** to create a new contact, or tap **Update existing contact** to add the number to an existing contact.

Adding a phone number to Contacts from the calls list

- 1 Launch the **Phone** app and tap **Recents**.
- 2 Tap a phone number and tap **Add**.
- 3 Tap **Create new contact** to create a new contact, or tap **Update existing contact** to add the number to an existing contact.

Adding a tag to a phone number

You can add tags to numbers without saving them to Contacts. This allows you to view the caller's information when they call without having them listed in Contacts.

- 1 Launch the **Phone** app and tap **Recents**.
- 2 Tap a phone number.
- 3 Tap **Add note**, enter a tag, and then tap **Add**.

When a call comes from that number, the tag will show under the number.

Contacts

Introduction

Create new contacts or manage contacts on the device.

Adding contacts

Creating a new contact

- 1 Launch the **Contacts** app and tap .
- 2 Select a storage location.

3 Enter contact information.

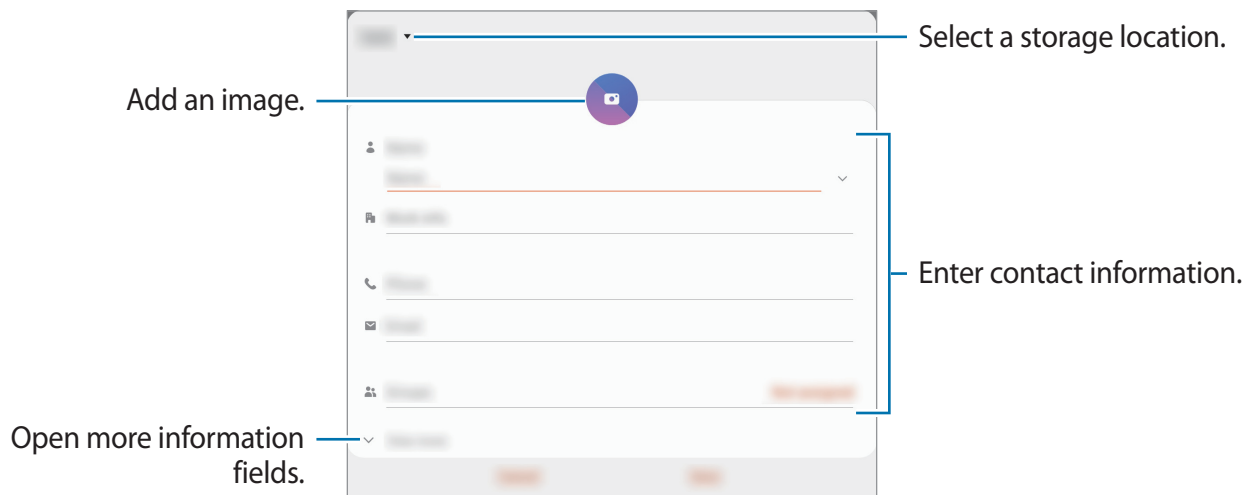

Depending on the selected storage location, the types of information you can save may vary.

4 Tap **Save**.

Importing contacts

Add contacts by importing them from other storages to your device.

- 1 Launch the **Contacts** app and tap  → **Manage contacts** → **Import or export contacts** → **Import**.
- 2 Select a storage location to import contacts from.
- 3 Tick VCF files or contacts to import and tap **Done**.
- 4 Select a storage location to save contacts to and tap **Import**.

Syncing contacts with your web accounts

Sync your device contacts with online contacts saved in your web accounts, such as your Samsung account.

- 1 Launch the **Settings** app, tap **Accounts and backup** → **Accounts**, and then select the account to sync with.
- 2 Tap **Sync account** and tap the **Contacts** switch to activate it.
For the Samsung account, tap  → **Sync settings** and tap the **Contacts** switch to activate it.





Searching for contacts

Launch the **Contacts** app.

Use one of the following search methods:

- Scroll up or down the contacts list.
- Drag a finger along the index at the right side of the contacts list to scroll through it quickly.
- Tap **Q** at the top of the contacts list and enter search criteria.

Tap the contact. Then take one of the following actions:

-  : Add to favorite contacts.
-  /  : Make a voice or video call.
-  : Compose a message.
-  : Compose an email.

Sharing contacts

You can share contacts with others by using various sharing options.

- 1 Launch the **Contacts** app, tap  at the top of the contacts list, and then tap **Share**.
- 2 Select contacts and tap **Share**.
- 3 Select a sharing method.

Saving and sharing profile (SM-T505)

Save and share your profile information, such as your photo and status message, with others using the profile sharing feature.



- To use this feature, you must sign in to your Samsung account.
- The profile sharing feature may not be available depending on the region or service provider.
- The profile sharing feature is only available for contacts who have activated the profile sharing feature on their device.

1 Launch the **Contacts** app and select your profile.

2 Tap **Tap here to share your profile** and tap the switch to activate it.

- To use the profile sharing feature, your phone number must be verified. You can view your contacts' updated profile information in **Contacts**.
- To change the scope of contacts to share your profile with, tap **Select what's shared**, select an item to share, and then select an option.

Creating groups

You can add groups, such as family or friends, and manage contacts by group.

1 Launch the **Contacts** app and tap  → **Groups** → **Create group**.

2 Enter a group name.

To set a group ringtone, tap **Group ringtone** and select a ringtone.

3 Tap **Add member**, select contacts to add to the group, and then tap **Done**.

4 Tap **Save**.

Sending a group message

You can send a group message to a group's members at the same time.

Launch the **Contacts** app, tap  → **Groups**, select a group, and then tap  → **Send message**.

Merging duplicate contacts

When you import contacts from other storages, or sync contacts with other accounts, your contacts list may include duplicate contacts. Merge duplicate contacts into one to streamline your contacts list.

- 1 Launch the **Contacts** app and tap  → **Manage contacts** → **Merge contacts**.
- 2 Tick contacts and tap **Merge**.

Deleting contacts

- 1 Launch the **Contacts** app, tap  at the top of the contacts list, and then tap **Delete**.
- 2 Select contacts and tap **Delete**.

To delete contacts one by one, tap a contact. Then tap  → **Delete**.

Messages

Introduction

Send and view messages by conversation.



To make a call and send a text message, launch the **Settings** app, tap **Advanced features**, and then tap the **Call & text on other devices** switch to activate it. You must register and sign in to the same Samsung account on your device and the other device. Some calling and messaging features may not be available.

Sending messages



You may incur additional charges for sending messages when you are roaming.

1 Launch the **Messages** app and tap **+**.

2 Add recipients and enter a message.

To record and send a voice message, tap and hold , say your message, and then release your finger. The recording icon appears only while the message input field is empty.

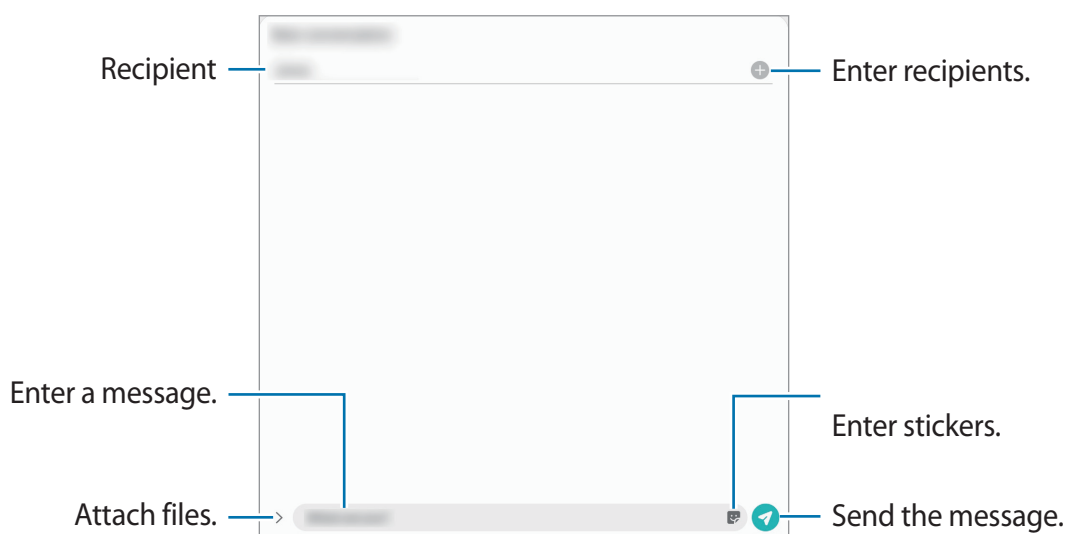

3 Tap  to send the message.

Viewing messages

Messages are grouped into message threads by contact.



You may incur additional charges for receiving messages when you are roaming.

1 Launch the **Messages** app.

2 On the messages list, select a contact or a phone number.

- To reply to the message, tap input field, enter a message, and then tap .
- To adjust the font size, spread two fingers apart or pinch on the screen.



Sorting messages

You can sort messages by category and manage them easily.

- 1 Launch the **Messages** app and tap **Conversations**.
- 2 Tap **New category** → **Add category**.
If the category option does not appear, tap  → **Settings** and tap the **Conversations categories** switch to activate it.
- 3 Enter a category name and tap **Done**.
- 4 Select conversations to add to the category and tap **Done**.

Blocking unwanted messages

Block messages from specific numbers added to your block list.

- 1 Launch the **Messages** app, tap  at the top of the messages list, and then tap **Settings** → **Block numbers and messages** → **Block numbers**.
- 2 Tap **Conversations** and select a contact or a phone number. Or, tap **Contacts**, select contacts, and then tap **Done**.
To manually enter a number, enter a phone number under **Enter phone number** and tap .

Setting the message notification

You can change notification sound, display options, and more.

- 1 Launch the **Messages** app, tap  at the top of the messages list, tap **Settings** → **Notifications**, and then tap the switch to activate it.
- 2 Change the notification settings.

Setting a message reminder

You can set an alert at an interval to let you know that you have unchecked notifications. If this feature is not activated, launch the **Settings** app, tap **Accessibility** → **Advanced settings** → **Notification reminders**, and then tap the switch to activate it.

Deleting messages

- 1 Launch the **Messages** app.
- 2 On the messages list, select a contact or a phone number.
- 3 Tap and hold a message, then tap **Delete**.
To delete multiple messages, tick messages you want to delete.
- 4 Tap **Delete**.

Internet

Introduction

Browse the Internet to search for information and bookmark your favorite webpages to access them conveniently.

Browsing webpages

- 1 Launch the **Internet** app.
- 2 Tap the address field.
- 3 Enter the web address or a keyword, and then tap **Go**.

To view the toolbars, drag your finger downwards slightly on the screen.

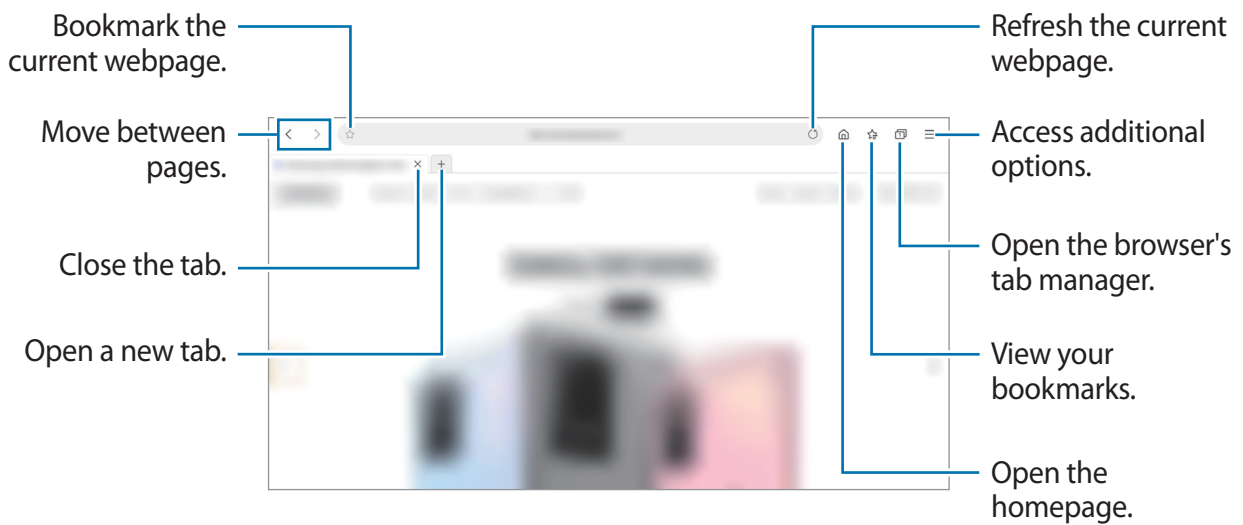

Using secret mode

In secret mode, you can separately manage open tabs, bookmarks, and saved pages. You can lock secret mode using a password and your biometric data.

Activating secret mode

Tap  → **Turn on Secret mode**. If you are using this feature for the first time, set whether to use a password for secret mode.

In secret mode, the device will change the color of the toolbars.



In secret mode, you cannot use some features, such as screen capture.

Changing security settings

You can change your password or the lock method.

Tap  → **Settings** → **Privacy and security** → **Secret mode settings** → **Change password**.

To use your registered biometric data as a lock method along with the password, tap an option switch under **Biometrics** to activate it.

Deactivating secret mode

Tap  → Turn off Secret mode.

Camera

Introduction

Take photos and record videos using various modes and settings.

Camera etiquette

- Do not take photos or record videos of other people without their permission.
- Do not take photos or record videos where legally prohibited.
- Do not take photos or record videos in places where you may violate other people's privacy.

Launching Camera

Use the following methods to launch **Camera**:

- Launch the **Camera** app.
- Press the Side key twice quickly.
- On the locked screen, drag  outside the circle.



- Some methods may not be available depending on the region or service provider.
- Some camera features are not available when you launch the **Camera** app from the locked screen or when the screen is turned off while the screen lock method is set.
- If photos you take appear blurry, clean the camera lens and try again.

Taking photos

1 Tap the image on the preview screen where the camera should focus.

- Spread two fingers apart on the screen to zoom in, and pinch to zoom out. Alternatively, drag the lens selection icon. Zooming features are available only when using the rear camera.
- To adjust the brightness of photos, tap the screen. When the adjustment bar appears, drag the adjustment bar towards **+** or **-**.

2 Tap  to take a photo.



- The preview screen may vary depending on the shooting mode and which camera is being used.
- The camera automatically shuts off when unused.
- Make sure that the lens is not damaged or contaminated. Otherwise, the device may not work properly in some modes that require high resolutions.
- Your device's camera features a wide-angle lens. Minor distortion may occur in wide-angle photos or videos and does not indicate device performance problems.

Options for current shooting mode













On the preview screen, use the following options.



Options for current shooting mode



The available options may vary depending on the shooting mode.

-  : Activate or deactivate the flash.
-  : Select the length of the delay before the camera automatically takes a photo.
-  : Select an aspect ratio for photos.
-  : Select a frame rate.
-  : Select an aspect ratio for videos.
-  : Apply a filter effect or beauty effects.
-  : Select a metering method. This determines how light values are calculated.  **Center-weighted** uses the light in the center portion of the shot to calculate the exposure of the shot.  **Spot** uses the light in a concentrated center area of the shot to calculate the exposure of the shot.  **Matrix** averages the entire scene.
-  : In **FOOD** mode, focus on a subject inside the circular frame and blur the image outside the frame.
-  : In **FOOD** mode, adjust the color tone.

Changing shooting modes

To change the shooting mode, drag the shooting modes list to the left or right, or swipe to the left or right on the preview screen.

Select a shooting mode you want.





Selecting a camera for shooting

On the preview screen, select the camera you want and take a photo or record a video.



This feature is only available in some shooting modes.

-  (Wide-angle): The wide-angle camera lets you take basic photos or record normal videos.
-  (Telephoto): The telephoto camera (optical zoom) lets you take photos or record videos by enlarging the subject.



 Wide-angle



 Telephoto

Photo mode (Intelligent camera)

The camera adjusts the shooting options automatically depending on the surroundings to capture photos easily. The intelligent camera feature automatically recognizes the subject and optimizes the color and any effects.

On the shooting modes list, tap **PHOTO** and tap  to take a photo.

Scene optimiser

The camera adjusts the color settings and applies the optimized effect automatically by recognizing the subject.

On the shooting modes list, tap **PHOTO**. When the camera recognizes the subject, the scene optimiser button will change and the optimized color and effect will be applied.





- If this feature is not activated, tap  on the preview screen and tap the **Scene optimiser** switch to activate it.
- If you do not want to use this feature, tap the scene optimiser button on the preview screen.



Taking selfies

You can take self-portraits with the front camera.

- 1 On the shooting modes list, tap **PHOTO**.
- 2 On the preview screen, swipe upwards or downwards, or tap  to switch to the front camera for self-portraits.
- 3 Face the front camera lens.
To take self-portraits with a wide-angle shot of the landscape or people, tap .
- 4 Tap  to take a photo.

Applying filter and beauty effects

You can select a filter effect and modify facial features, such as your skin tone or face shape, before taking a photo.

- 1 On the preview screen, tap .
- 2 Select a filter effect or beauty effects and take a photo.





Locking the focus (AF) and exposure (AE)

You can lock the focus or exposure on a selected area to prevent the camera from automatically adjusting based on changes to the subjects or light sources.

Tap and hold the area to focus, the AF/AE frame will appear on the area and the focus and exposure setting will be locked. The setting remains locked even after you take a photo.

Video mode

The camera adjusts the shooting options automatically depending on the surroundings to record videos easily.

- 1 On the shooting modes list, tap **VIDEO**.
- 2 Tap  to record a video.
 - To switch between the front and rear cameras while recording, tap .
 - To capture an image from the video while recording, tap .
 - To change the focus while recording a video, tap where you want to focus. To use auto focus mode, tap **AF** to cancel the manually set focus.
- 3 Tap  to stop recording the video.

Live focus mode

The camera allows you to take photos where the background is blurred and the subject stands out clearly.



- Use this feature in a place that has sufficient light.
- The background blur may not be applied properly in the following conditions:
 - The device or the subject is moving.
 - The subject has a similar color to the background.



Taking portraits that stand out using the Live focus feature

- 1 On the shooting modes list, tap **LIVE FOCUS**.
- 2 Drag the background blur adjustment bar to adjust the blur level.
- 3 When **Ready** appears on the preview screen, tap  to take a photo.



Food mode

Take photos of food with more vibrant colors.

- 1 On the shooting modes list, tap **MORE** → **FOOD**.
- 2 Tap the screen and drag the circular frame over the area to highlight.
The area outside the circular frame will be blurred.
To resize the circular frame, drag a corner of the frame.
- 3 Tap  and drag the adjustment bar to adjust the color tone.
- 4 Tap  to take a photo.

Panorama mode

Using panorama mode, take a series of photos and then stitch them together to create a wide scene.



To get the best shots using panorama mode, follow these tips:

- Move the camera slowly in one direction.
- Keep the image within the frame on the camera's viewfinder. If the preview image is out of the guide frame or you do not move the device, the device will automatically stop taking photos.
- Avoid taking photos of indistinct backgrounds, such as an empty sky or a plain wall.

1 On the shooting modes list, tap **MORE** → **PANORAMA**.

2 Tap  and move the device slowly in one direction.



3 Tap  to stop taking photos.

Pro mode

Capture photos while manually adjusting various shooting options, such as exposure value and ISO value.

On the shooting modes list, tap **MORE** → **PRO**. Select options and customize the settings, and then tap  to take a photo.

Available options

-  : Select an ISO value. This controls camera light sensitivity. Low values are for stationary or brightly lit objects. Higher values are for fast-moving or poorly lit objects. However, higher ISO settings can result in noise in photos.
-  : Select an appropriate white balance, so images have a true-to-life color range. You can set the color temperature.
-  : Change the exposure value. This determines how much light the camera's sensor receives. For low-light situations, use a higher exposure.

Separating the focus area and the exposure area



You can separate the focus area and the exposure area.

Tap and hold the preview screen. The AF/AE frame will appear on the screen. Drag the frame to the area where you want to separate the focus area and the exposure area.





Hyperlapse mode

Record scenes, such as passing people or cars, and view them as fast-motion videos.

- 1 On the shooting modes list, tap **MORE** → **HYPERLAPSE**.
- 2 Tap  and select a frame rate option.
- 3 Tap  to start recording.
- 4 Tap  to finish recording.
- 5 On the preview screen, tap the preview thumbnail and tap **Play hyperlapse** to view the video.

Deco Pic mode

Capture photos or videos with various stickers.

- 1 On the shooting modes list, tap **MORE** → **Deco Pic**.
- 2 Select a sticker you want to use.
- 3 Tap  to take a photo or tap and hold  to record a video.
You can view and share the photos and videos that you have captured in **Gallery**.

Customizing camera settings

On the preview screen, tap . Some options may not be available depending on the shooting mode.

Intelligent features

- **Scene optimiser:** Set the device to adjust the color settings automatically depending on the subject or scene.
- **Scan QR codes:** Enable or disable the QR code reader.

Pictures

- **Hold Shutter button to:** Select an action to perform when you tap and hold the camera button.

Videos

- **Rear video size:** Select a resolution for videos you want to take with the rear camera. Using a higher resolution will result in higher quality videos, but they will take up more memory.
- **Front video size:** Select a resolution for videos you want to take with the front camera. Using a higher resolution will result in higher quality videos, but they will take up more memory.
- **High efficiency video:** Record videos in the High Efficiency Video Codec (HEVC) format. Your HEVC videos will be saved as compressed files to conserve the device's memory.
- **Video stabilization:** Activate anti-shake to reduce or eliminate blurry image resulting from camera shake while recording a video.

Useful features

- **Auto HDR:** Take photos with rich colors and reproduce details even in bright and dark areas.
- **Pictures as previewed:** Set the device to save photos as they appear on the preview screen when taken with the front camera without flipping them.
- **Grid lines:** Display viewfinder guides to help composition when selecting subjects.
- **Location tags:** Attach a GPS location tag to the photo.
 -  GPS signal strength may decrease in locations where the signal is obstructed, such as between buildings or in low-lying areas, or in poor weather conditions.
 - Your location may appear on your photos when you upload them to the Internet. To avoid this, deactivate the location tag setting.
- **Shooting methods:** Select additional shooting methods for taking a photo or recording a video.
- **Storage location:** Select the memory location for storage. This feature will appear when you insert a memory card.
- **Watermark:** Add a watermark in the bottom left corner when taking pictures.
- **Reset settings:** Reset the camera settings.
- **Contact us:** Ask questions or view frequently asked questions.
- **About Camera:** View the Camera app version and legal information.

Gallery

Introduction

View images and videos stored in your device. You can also manage images and videos by album or create stories.

Using Gallery

Launch the **Gallery** app.

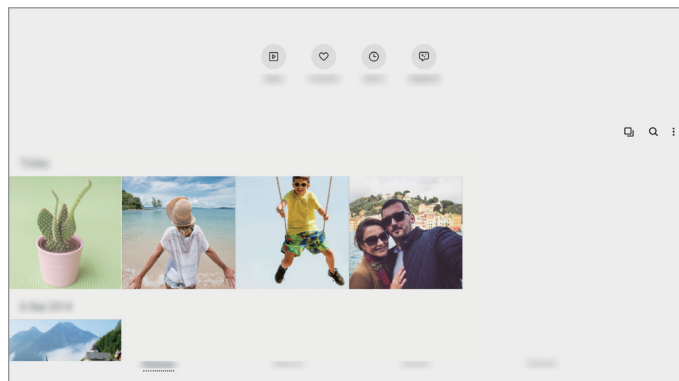

- **Videos:** View the videos saved in your device.
- **Favorites:** View your favorite photos and videos.
- **Recent:** View recent photos and videos.
- **Suggested:** View recommended content.

Grouping similar images

Launch the **Gallery** app and tap  to group similar images and display only the best shots as a preview of the images. When you tap the image preview, you can view all the images in the group.



The icon appears only when there are similar images.

Searching for images

Launch the **Gallery** app and tap **Q** to view images sorted by category, such as types or locations.

To search for images by entering keywords, tap the search field.

Viewing images

1 Launch the **Gallery** app and tap **Pictures**.

2 Select an image.

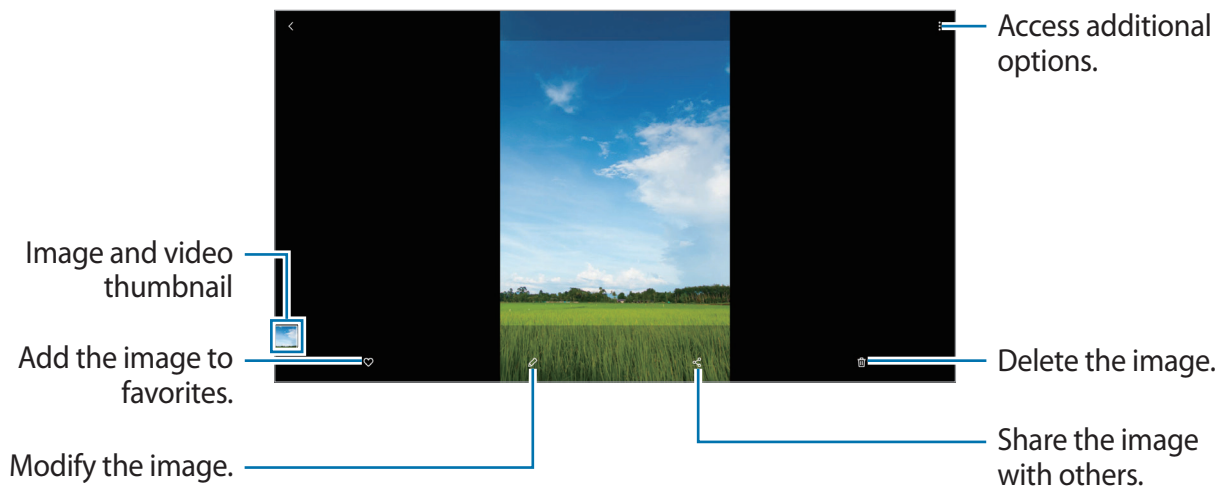

Cropping images by enlarging an area

1 Launch the **Gallery** app and tap **Pictures**.

2 Select an image.

3 Double-tap or spread two fingers apart on the area you want to save and tap .

The cropped area will be saved as a file.



Viewing videos

- 1 Launch the **Gallery** app and tap **Pictures**.
- 2 Select a video to play.
- 3 Tap **Play video** to play the video.

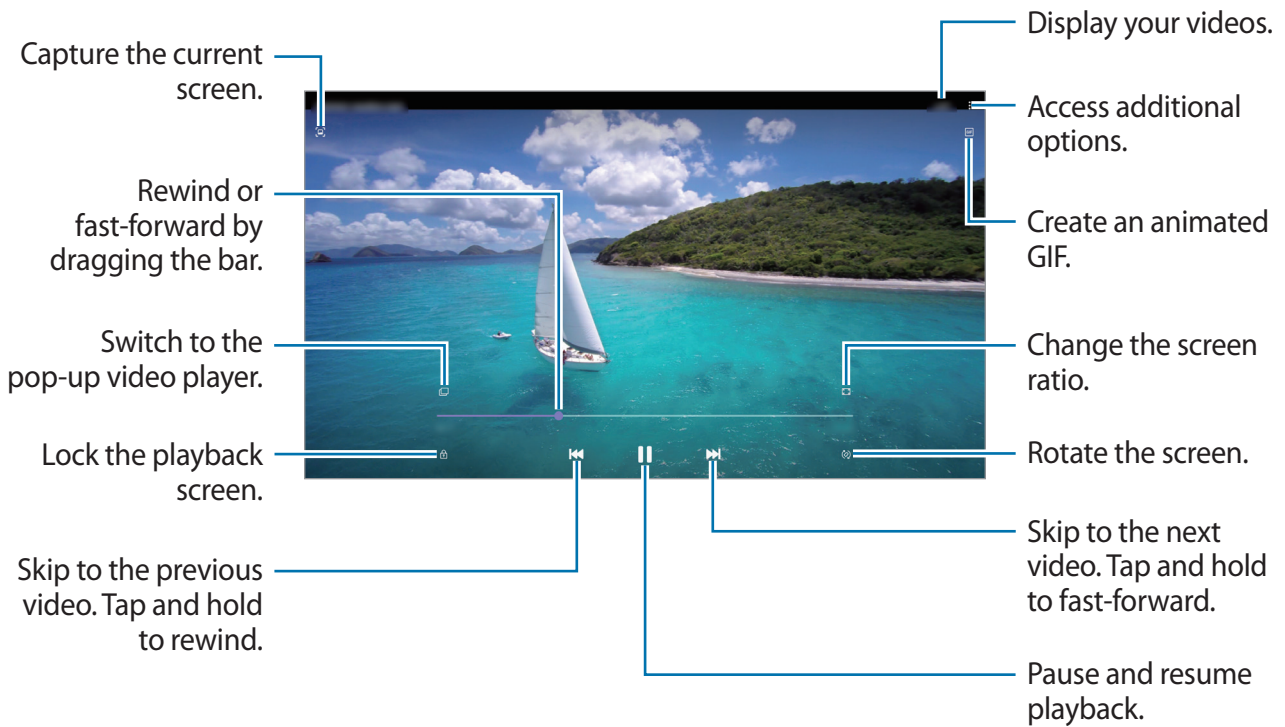

Drag your finger up or down on the left side of the playback screen to adjust the brightness, or drag your finger up or down on the right side of the playback screen to adjust the volume. To rewind or fast-forward, swipe to the left or right on the playback screen.

Viewing albums

You can view your images and videos sorted by folders or albums.

Launch the **Gallery** app, tap **Albums**, and then select an album.

Creating albums

You can add albums and sort files.

- 1 Launch the **Gallery** app and tap **Albums**.
- 2 Tap  → **Create album**.
- 3 Enter a title for the album and tap **Create**.

Moving photos and videos to albums

- 1 Launch the **Gallery** app and tap **Albums**.
- 2 Select an album and tap **Add items**.
- 3 Tap **Pictures**, or tap **Albums** and select an album with the images or videos you want.
- 4 Tick files and tap **Done**.
- 5 Tap **Move**.

The files will be deleted from the original folder and moved to the album. To copy the files, tap **Copy**.

Deleting albums

- 1 Launch the **Gallery** app and tap **Albums**.
- 2 Tap and hold an album to delete, and tap **Delete**.

Creating album groups

You can add groups and sort albums.



- 1 Launch the **Gallery** app and tap **Albums**.
- 2 Tap  → **Create group**.
- 3 Enter a title for the group and tap **Create**.
- 4 Select the group, tap **Add albums**, tick albums, and then tap **Add**.
The albums will be moved to the group.

Viewing stories

When you capture or save images and videos, the device will read their date and location tags, sort the images and videos, and then create stories. To create stories automatically, you must capture or save multiple images and videos.

Launch the **Gallery** app, tap **Stories**, and then select a story.

Editing stories

- To add images or videos to a story, select a story and tap **Story album** →  → **Add**.
- To remove images or videos from a story, select a story, tap **Story album** →  → **Edit**, tick images or videos to remove, and then tap **Remove from story**.

Deleting stories



- 1 Launch the **Gallery** app and tap **Stories**.
- 2 Tap and hold a story to delete, and tap **Delete**.

Deleting images or videos

- 1 Launch the **Gallery** app.
- 2 Select an image or a video to delete.
To delete multiple files, tap and hold a file to delete on the list and tick more files to delete.
- 3 Tap  or **Delete**.

Using the recycle bin feature

You can keep the deleted images and videos in the recycle bin. The files will be deleted after a certain period.

Launch the **Gallery** app, tap  → **Settings**, and then tap the **Recycle bin** switch to activate it. To view files in the recycle bin, launch the **Gallery** app and tap  → **Recycle bin**.

Multi window

Introduction

Multi window lets you run two apps at the same time in the split screen view. You can also run multiple apps at the same time in the pop-up view.



Some apps may not support this feature.

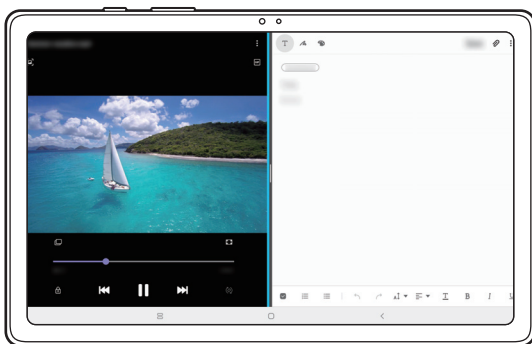

Split screen view



Pop-up view

Split screen view

- 1 Tap the Recents button to open the list of recently used apps.
- 2 Swipe to the left or right, tap an app's icon, and then tap **Open in split screen view**.
The selected app will launch in the split screen view.
- 3 On the other window, swipe left or right to select another app to launch.
To launch apps not on the list of recently used apps, tap the Home button or Back button and select an app.

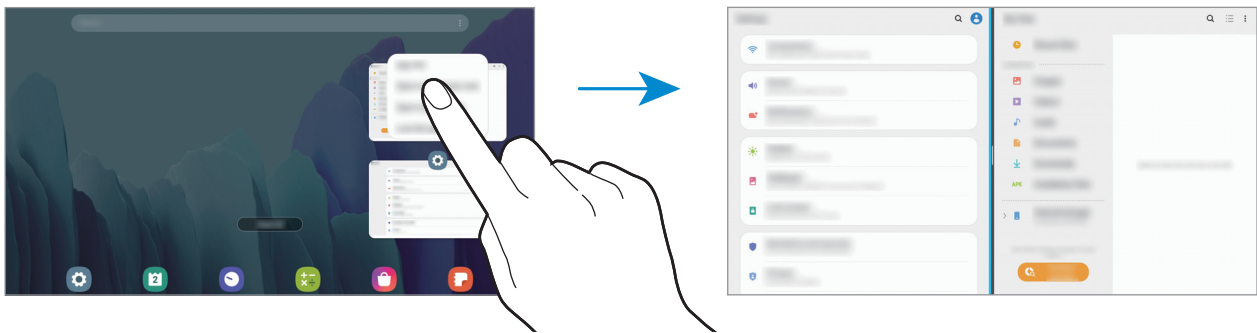

Adjusting the window size

Drag the bar between the app windows to the left or right to adjust the size of the windows. When you drag the bar between the app windows to the left or right edge of the screen, the window will be maximized.

Pop-up view

- 1 Tap the Recents button to open the list of recently used apps.
- 2 Swipe to the left or right, tap an app's icon, and then tap **Open in pop-up view**.
The app screen will appear in the pop-up view.

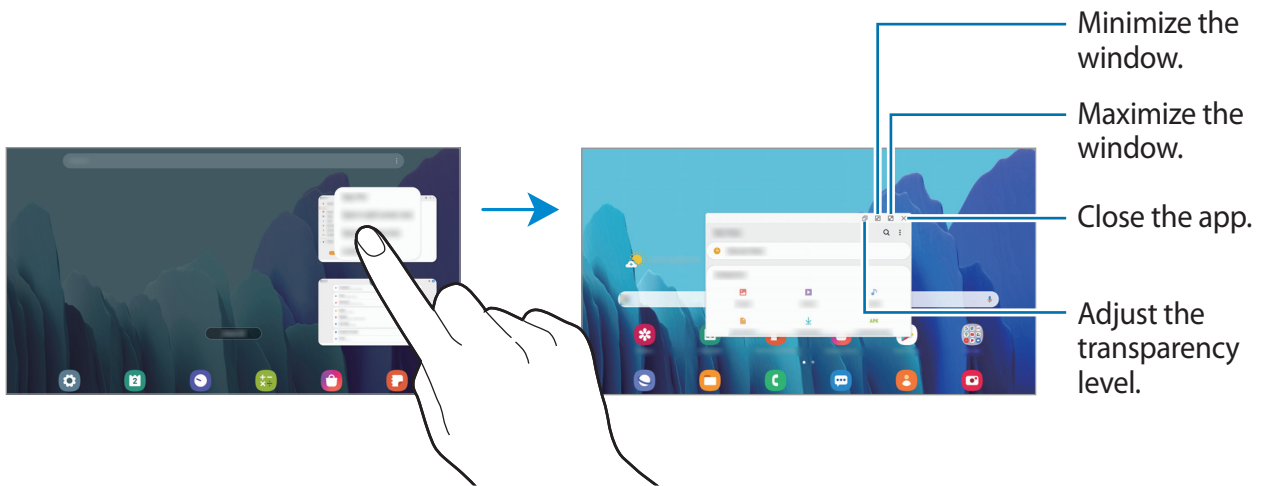

Moving pop-up windows

To move a pop-up window, tap the window's toolbar and drag it to a new location.

Samsung Members

Samsung Members offers support services to customers, such as device problem diagnosis, and lets users submit questions and error reports. You can also share information with others in the Galaxy users' community or view the latest news and tips. **Samsung Members** can help you solve any problems you might encounter while using your device.



To submit your feedback or post your comments, you must sign in to your Samsung account. Refer to [Samsung account](#) for more information.

Samsung Notes

Create notes by entering text from the keyboard or by handwriting or drawing on the screen. You can also insert images or voice recordings into your notes.

Creating notes

- 1 Launch the **Samsung Notes** app and tap .
- 2 Select an input method from the toolbar at the top of the screen and compose a note.

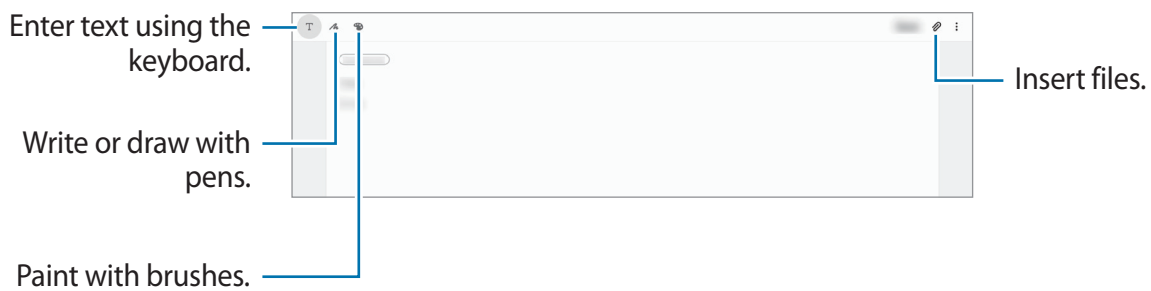

- 3 When you are finished composing the note, tap **Save**.

Deleting notes

- 1 Launch the **Samsung Notes** app.
- 2 Tap and hold a note to delete.
To delete multiple notes, tick more notes to delete.
- 3 Tap **Delete**.

Calendar

Manage your schedule by entering upcoming events or reminders in your planner.

Creating events

- 1 Launch the **Calendar** app and tap **+** or double-tap a date.
- 2 Enter event details.

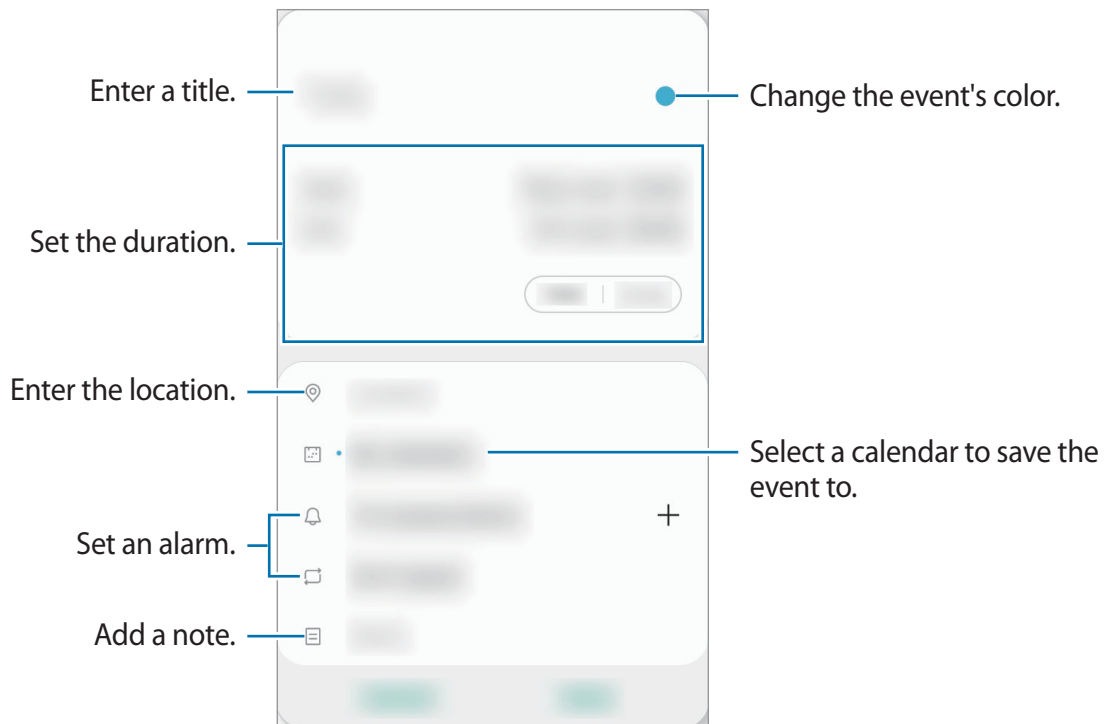



- 3 Tap **Save** to save the event.

Creating reminders

You can create tasks as reminders and receive notifications at the preset time or location for each reminder. Launch the **Calendar** app and tap **≡** → **Reminder**. Refer to [Reminder](#) for more information.

Syncing events with your accounts

- 1 Launch the **Settings** app, tap **Accounts and backup** → **Accounts**, and then select the account to sync with.
- 2 Tap **Sync account** and tap the **Calendar** switch to activate it.
For the Samsung account, tap  → **Sync settings** and tap the **Calendar** switch to activate it.

To add accounts to sync with, launch the **Calendar** app and tap  →  → **Add new account**. Then, select an account to sync with and sign in. When an account is added, a blue circle is displayed next to the account name.

Reminder

Create reminders to schedule to-do items or to view content later. You will receive notifications at the preset time or location for each reminder.



- To receive more accurate notifications, connect to a Wi-Fi or mobile network.
- To fully use this feature, you must sign in to your Samsung account.
- To use location reminders, the GPS feature must be activated. Location reminders may not be available depending on the model.

Starting Reminder

Launch the **Calendar** app and tap  → **Reminder**. The Reminder screen will appear and the Reminder app icon () will be added to the Apps screen.

Creating reminders

Create reminders with various methods. Reminder will alert you if you create a reminder with a specified time or location setting. You can also save various content, such as a single memo or webpage address, and view it later.

For example, create a reminder to alert you to 'Water the flowers when I get home.'

- 1 Launch the **Reminder** app.

2 Tap **Write a reminder** or **+** and enter 'Water the flowers'.

3 Tap **Place** → **Pick a place** and set the location to home.

4 Tap **When I arrive at** → **Done**.

5 Tap **Save** to save the reminder.

When you arrive at home, the 'Water the flowers' notification will appear.

Completing reminders

Mark reminders that you do not need to be reminded of as complete.

On the reminders list, select a reminder and tap **Complete**.

Restoring reminders

Restore reminders that have been completed.

1 On the reminders list, tap **⋮** → **Completed** → **Edit**.

2 Tick items to restore and tap **Restore**.

Reminders will be added to the reminders list and you will be reminded at the preset times.

Deleting reminders

To delete a reminder, select a reminder and tap **Delete**. To delete multiple reminders, tap and hold a reminder, tick reminders to delete, and then tap **Delete**.

Samsung Flow

Introduction

Samsung Flow allows you to easily connect your tablet to your smartphone and use them conveniently, such as checking notifications or sharing contents.

Samsung Flow must be installed on both devices that you want to connect. If Samsung Flow is not installed, download it from **Galaxy Store** or **Play Store**.



- This feature is only available on some Samsung Android devices.
- To use this feature, you must activate Bluetooth feature on your tablet and your smartphone.

Connecting your tablet and smartphone

1 On your smartphone, launch Samsung Flow.

2 On your tablet, launch the **Samsung Flow** app.



If you are using this feature for the first time, tap **Start**.

3 Select your smartphone from the detected devices list.

4 Accept the connection request on both devices.

5 Confirm the passkey on both devices.

The devices will be connected.



If your smartphone supports fingerprint recognition feature, set up Samsung Pass on your smartphone to connect the devices more easily and securely using your fingerprint.

Sharing mobile data connection

Share your smartphone's mobile data connection with your tablet using a mobile hotspot when the Internet connection is not available on your tablet.

1 On your tablet, launch the **Samsung Flow** app.

2 Tap .

You can access the Internet on your tablet using your smartphone's mobile data connection.



- Your smartphone must support the mobile hotspot feature.
- You may incur additional charges on your smartphone when using this feature.

Checking notifications on your tablet

When you receive new notifications on your smartphone, tap **NOTIFICATIONS** to check the notifications on your tablet.

Sharing contents



You can share your smartphone's contents with your tablet.

Voice Recorder

Introduction

Use this app to record or play voice memos.

Making voice recordings

- 1 Launch the **Voice Recorder** app.
- 2 Tap  to start recording. Speak into the microphone.
 - Tap  to pause recording.
 - While making a voice recording, tap **BOOKMARK** to insert a bookmark.

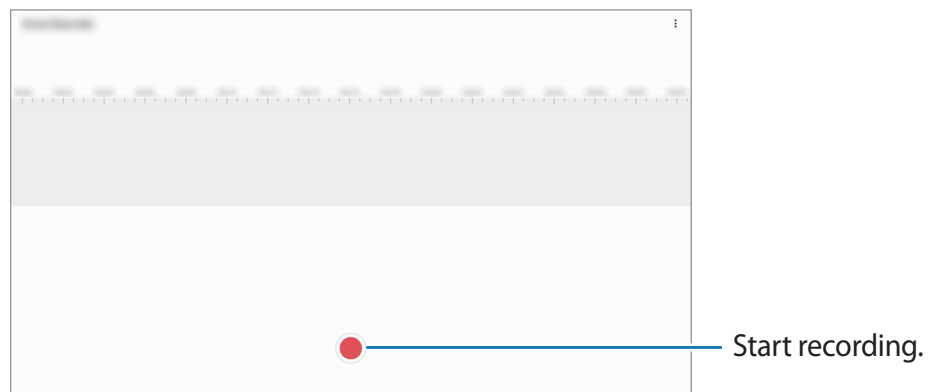

- 3 Tap  to finish recording.
- 4 Enter a file name and tap **Save**.

My Files

Access and manage various files stored in the device.

Launch the **My Files** app.

View files that are stored in each storage.

To check for unnecessary data and free up the device's storage, tap **Analyze storage**.

To search for files or folders, tap **Q**.

Clock

Introduction

Set alarms, check the current time in many cities around the world, time an event, or set a specific duration.

Alarm

Launch the **Clock** app and tap **Alarm**.

Setting alarms

Tap **+** in the alarms list, set an alarm time, select the days on which the alarm will repeat, set other various alarm options, and then tap **Save**.

To open the keypad to enter an alarm time, tap the time input field.

To activate or deactivate alarms, tap the switch next to the alarm in the alarms list.

Stopping alarms

Tap **Dismiss** to stop an alarm. If you have previously enabled the snooze option, tap **Snooze** to repeat the alarm after a specified length of time.

Deleting alarms

Tap and hold an alarm, tick alarms to delete, and then tap **Delete**.

World clock

Launch the **Clock** app and tap **World clock**.

Creating clocks

Tap **+**, enter a city name or select a city from the map, and then tap **Add**.

To use the time zone converter, tap **⋮** → **Time zone converter**.

Deleting clocks

Tap and hold a clock, tick clocks to delete, and then tap **Delete**.

Stopwatch

1 Launch the **Clock** app and tap **Stopwatch**.

2 Tap **Start** to time an event.

To record lap times while timing an event, tap **Lap**.

3 Tap **Stop** to stop timing.

- To restart the timing, tap **Resume**.
- To clear lap times, tap **Reset**.

Timer

1 Launch the **Clock** app and tap **Timer**.

To add a frequently used timer, tap **+**, set the duration and name, and then tap **Add**.

2 Set the duration and tap **Start**.

To open the keypad to enter the duration, tap the duration input field.

3 Tap **Dismiss** when the timer goes off.

Calculator

Perform simple or complex calculations.

Launch the **Calculator** app.

To clear the history, tap **Clear history**.

To use the unit conversion tool, tap . You can convert various values, such as area, length, or temperature, into other units.

Game Launcher

Introduction

Game Launcher gathers your games downloaded from **Play Store** and **Galaxy Store** into one place for easy access. You can set the device to game mode to play games more easily.

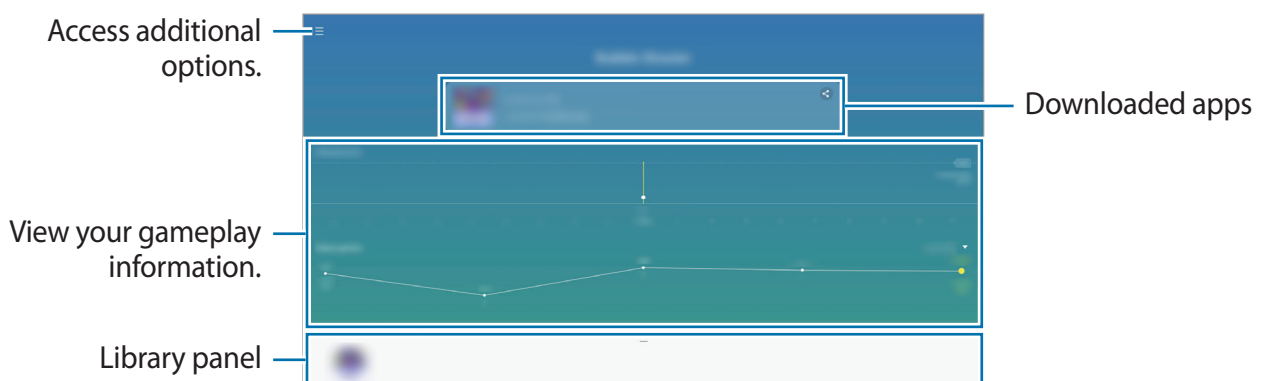

Using Game Launcher

- 1 Launch the **Game Launcher** app.
- 2 Drag the Library panel upwards and tap a game.



Games downloaded from **Play Store** and **Galaxy Store** will be automatically shown on the Game Launcher screen. If you cannot see your games, drag the Library panel upwards and tap  → **Add apps**.

Removing a game from Game Launcher

Drag the Library panel upwards, tap and hold a game, and then tap **Remove from Game Launcher**.

Samsung Kids

Introduction

You can restrict children's access to certain apps, set their usage times, and configure settings to provide a fun and safe environment for children when they use the device.

Using Samsung Kids

Open the notification panel, swipe downwards, and then tap  (**Samsung Kids**) to activate it. The Samsung Kids screen will appear. When starting Samsung Kids for the first time or after performing a data reset, follow the on-screen instructions to complete the setup.

On the Samsung Kids screen, select the app you want to use.



Your preset screen lock method or your created PIN will be used when activating the **Parental control** feature or closing Samsung Kids.

Using parental control features

You can configure the settings for Samsung Kids and view the usage history.

On the Samsung Kids screen, tap  → **Parental control** and enter your unlock code.

- **Kid's name:** Manage your child's profile.
- **Set daily playtime:** Restrict the usage time for Samsung Kids.
- **Daily usage:** View the daily usage time of Samsung Kids.
- **Activity:** View the activity history of Samsung Kids.
- **Frequently contacted:** View the frequently used contacts in Samsung Kids. (SM-T505)
- **My kid's creations:** View the works created from the apps in Samsung Kids.
- **Allowed content:** Check the apps or content supported by Samsung Kids and add them.
- **Show Content page:** Set the device to display the Samsung partner's content page on the Samsung Kids screen.

Closing Samsung Kids

To close Samsung Kids, tap the Back button or tap  → **Close Samsung Kids**, and then enter your unlock code.

Sharing content

Share content by using various sharing options. The following actions are an example of sharing images.



You may incur additional charges when sharing files via the mobile network. (SM-T505)

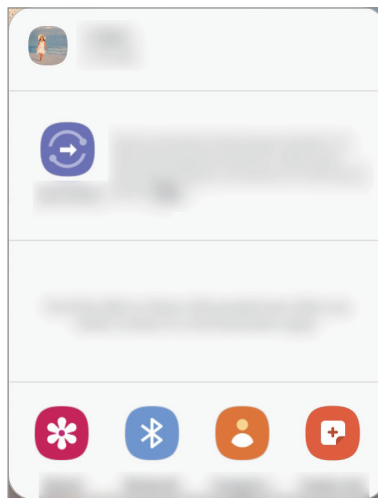

- 1 Launch the **Gallery** app and select an image.
- 2 Tap  and select a sharing method, such as email.



When you have a communication or sharing history, the people you contacted will appear on the sharing options panel. To directly share content with them via the corresponding app, select a person's icon. If the feature is not activated, launch the **Settings** app, tap **Advanced features**, and then tap the **Direct share** switch to activate it.



Quick Share

Share content with nearby devices via Wi-Fi Direct or Bluetooth.

- 1 Launch the **Gallery** app and select an image.
- 2 On the other device, open the notification panel, swipe downwards, and then tap  (**Quick Share**) to activate it.
- 3 Tap  → **Quick Share** and select a device to transfer the image to.
- 4 Accept the file transfer request on the other device.

Setting who can find your device

Set who is allowed to find and send content to your device.

- 1 Open the notification panel, swipe downwards, and then tap  (**Quick Share**) to activate it.
- 2 Tap and hold  (**Quick Share**).
The Quick Share settings screen will appear.
- 3 Select an option. (SM-T505)
 - **Contacts only:** Allow only your contacts to share with your device.
 - **Everyone:** Allow any nearby devices to share with your device.

Shared album

Create a shared album to share photos or videos with others, and download your files whenever you want.



- To use this feature, you must sign in to your Samsung account.
- When you play a high-resolution video from a shared album, the video connection may drop depending on the network speed.
- Content that is larger than 1 GB cannot be shared to a shared album.

1 Launch the **Gallery** app and select an image.

2 Tap  → **Shared album**.

3 Select an album to share.

If there is no album to share, tap **Create shared album** and follow the on-screen instructions to create an album.

Google apps

Google provides entertainment, social network, and business apps. You may require a Google account to access some apps.

To view more app information, access each app's help menu.



Some apps may not be available or may be labeled differently depending on the region or service provider.

Chrome

Search for information and browse webpages.

Gmail

Send or receive emails via the Google Mail service.

Maps

Find your location on the map, search the world map, and view location information for various places around you.

YT Music

Enjoy various music and videos provided by YouTube Music. You can also view the music collections stored on your device and play them.

Play Movies & TV

Purchase or rent videos, such as movies and TV programs, from **Play Store**.

Drive

Store your content on the cloud, access it from anywhere, and share it with others.

YouTube

Watch or create videos and share them with others.

Photos

Search for, manage, and edit all your photos and videos from various sources in one place.

Google

Search quickly for items on the Internet or your device.

Duo

Make a simple video call.

Settings

Introduction

Customize device settings. You can make your device more personalized by configuring various setting options.

Launch the **Settings** app.

To search for settings by entering keywords, tap **Q**.

Connections

Options

Change settings for various connections, such as the Wi-Fi feature and Bluetooth.

On the Settings screen, tap **Connections**.

- **Wi-Fi:** Activate the Wi-Fi feature to connect to a Wi-Fi network and access the Internet or other network devices. Refer to [Wi-Fi](#) for more information.
- **Bluetooth:** Use Bluetooth to exchange data or media files with other Bluetooth-enabled devices. Refer to [Bluetooth](#) for more information.
- **Airplane mode:** Set the device to disable all wireless functions on your device. You can use only non-network services.



Follow the regulations provided by the airline and the instructions of aircraft personnel. In cases where it is allowed to use the device, always use it in airplane mode.

- **Mobile networks:** Configure your mobile network settings. (SM-T505)

- **Data usage**

- ▶ **SM-T505:** Keep track of your data usage amount and customize the settings for the limitation. Set the device to automatically disable the mobile data connection when the amount of mobile data you have used reaches your specified limit.

You can activate the data saver feature to prevent some apps running in the background from sending or receiving data. Refer to [Data saver \(SM-T505\)](#) for more information.

You can also select apps to always use the mobile data even when your device is connected to a Wi-Fi network. Refer to [Mobile data only apps \(SM-T505\)](#) for more information.

- ▶ **SM-T500:** Keep track of your data usage amount.

- **Mobile Hotspot and Tethering:** Use the device as a mobile hotspot to share the device's mobile data connection with other devices when the network connection is not available. Connections can be made via Wi-Fi, USB, or Bluetooth. Refer to [Mobile Hotspot and Tethering \(SM-T505\)](#) for more information. (SM-T505)
- **More connection settings:** Customize settings to control other features. Refer to [More connection settings](#) for more information.

Wi-Fi

Activate the Wi-Fi feature to connect to a Wi-Fi network and access the Internet or other network devices.

Connecting to a Wi-Fi network

- 1 On the Settings screen, tap **Connections** → **Wi-Fi** and tap the switch to activate it.

- 2 Select a network from the Wi-Fi networks list.

Networks that require a password appear with a lock icon. Enter the password and tap **Connect**.



- Once the device connects to a Wi-Fi network, the device will reconnect to that network each time it is available without requiring a password. To prevent the device from connecting to the network automatically, tap  next to the network and tap the **Auto reconnect** switch to deactivate it.
- If you cannot connect to a Wi-Fi network properly, restart your device's Wi-Fi feature or the wireless router.

Wi-Fi Direct

Wi-Fi Direct connects devices directly via a Wi-Fi network without requiring an access point.

- 1 On the Settings screen, tap **Connections** → **Wi-Fi** and tap the switch to activate it.
- 2 Tap  → **Wi-Fi Direct**.
The detected devices are listed.
If the device you want to connect to is not in the list, request that the device turns on its Wi-Fi Direct feature.
- 3 Select a device to connect to.
The devices will be connected when the other device accepts the Wi-Fi Direct connection request.

Sending and receiving data

You can share data, such as contacts or media files, with other devices. The following actions are an example of sending an image to another device.

- 1 Launch the **Gallery** app and select an image.
- 2 Tap  → **Wi-Fi Direct** and select a device to transfer the image to.
- 3 Accept the Wi-Fi Direct connection request on the other device.
If the devices are already connected, the image will be sent to the other device without the connection request procedure.

Ending the device connection

- 1 On the Settings screen, tap **Connections** → **Wi-Fi**.
- 2 Tap  → **Wi-Fi Direct**.
The device displays the connected devices in the list.
- 3 Tap the device name to disconnect the devices.

Bluetooth

Use Bluetooth to exchange data or media files with other Bluetooth-enabled devices.



- Samsung is not responsible for the loss, interception, or misuse of data sent or received via Bluetooth.
- Always ensure that you share and receive data with devices that are trusted and properly secured. If there are obstacles between the devices, the operating distance may be reduced.
- Some devices, especially those that are not tested or approved by the Bluetooth SIG, may be incompatible with your device.
- Do not use the Bluetooth feature for illegal purposes (for example, pirating copies of files or illegally tapping communications for commercial purposes). Samsung is not responsible for the repercussion of illegal use of the Bluetooth feature.

Pairing with other Bluetooth devices

1 On the Settings screen, tap **Connections** → **Bluetooth** and tap the switch to activate it. The detected devices will be listed.

2 Select a device to pair with.

If the device you want to pair with is not on the list, set the device to enter Bluetooth pairing mode. Refer to the other device's user manuals.



Your device is visible to other devices while the Bluetooth settings screen is open.

3 Accept the Bluetooth connection request on your device to confirm.

The devices will be connected when the other device accepts the Bluetooth connection request.

Sending and receiving data

Many apps support data transfer via Bluetooth. You can share data, such as contacts or media files, with other Bluetooth devices. The following actions are an example of sending an image to another device.

- 1 Launch the **Gallery** app and select an image.
- 2 Tap  → **Bluetooth** and select a device to transfer the image to.
If the device you want to pair with is not in the list, request that the device turns on its visibility option.
- 3 Accept the Bluetooth connection request on the other device.

Unpairing Bluetooth devices

- 1 On the Settings screen, tap **Connections** → **Bluetooth**.
The device displays the paired devices in the list.
- 2 Tap  next to the device name to unpair.
- 3 Tap **Unpair**.

Data saver (SM-T505)

Reduce your data usage by preventing some apps running in the background from sending or receiving data.

On the Settings screen, tap **Connections** → **Data usage** → **Data saver** and tap the switch to activate it.

When the data saver feature is activated, the  icon will appear on the status bar.



-  To select apps to use data without restriction, tap **Allow app while Data saver on** and select apps.

Mobile data only apps (SM-T505)

Select apps to always use the mobile data even when your device is connected to a Wi-Fi network.

For example, you can set the device to use only mobile data for apps that you want to keep secure or streaming apps that can be disconnected. Even if you do not deactivate the Wi-Fi feature, the apps will launch using the mobile data.

On the Settings screen, tap **Connections** → **Data usage** → **Mobile data only apps**, tap the switch to activate it, and then tap the switches next to the apps you want.



You may incur additional charges when using this feature.

Mobile Hotspot and Tethering (SM-T505)

Use the device as a mobile hotspot to share the device's mobile data connection with other devices when the network connection is not available. Connections can be made via Wi-Fi, USB, or Bluetooth.

On the Settings screen, tap **Connections** → **Mobile Hotspot and Tethering**.



You may incur additional charges when using this feature.

- **Mobile Hotspot:** Use the mobile hotspot to share the device's mobile data connection with computers or other devices.
- **Bluetooth tethering:** Use Bluetooth tethering to share the device's mobile data connection with computers or other devices via Bluetooth.
- **USB tethering:** Use USB tethering to share the device's mobile data connection with a computer via USB. When connected to a computer, the device is used as a wireless modem for the computer.

Using the mobile hotspot

Use your device as a mobile hotspot to share your device's mobile data connection with other devices.

1 On the Settings screen, tap **Connections** → **Mobile Hotspot and Tethering** → **Mobile Hotspot**.

2 Tap the switch to activate it.

The  icon appears on the status bar. Other devices can find your device in the Wi-Fi networks list.

To set a password for the mobile hotspot, tap  → **Configure Mobile Hotspot** and select the level of security. Then, enter a password and tap **Save**.

3 On the other device's screen, search for and select your device from the Wi-Fi networks list.

To connect without entering the password, tap  and scan the QR code with the other device.



If the mobile hotspot is not found, on your device, tap  → **Configure Mobile Hotspot** and deselect **Hide my device**.

4 On the connected device, use the device's mobile data connection to access the Internet.

Auto Hotspot

You can share your device's mobile data connection with other devices signed in to your Samsung account without entering a password.

Tap the **Auto Hotspot** switch to activate it.

More connection settings

Customize settings to control other connection features.

On the Settings screen, tap **Connections** → **More connection settings**.

- **Nearby device scanning:** Set the device to scan for nearby devices to connect to.
- **Printing:** Configure settings for printer plug-ins installed on the device. You can search for available printers or add one manually to print files. Refer to [Printing](#) for more information.
- **VPN:** Set up virtual private networks (VPNs) on your device to connect to a school or company's private network.
- **Private DNS:** Set the device to use the security enhanced private DNS.
- **Ethernet:** When you connect an Ethernet adaptor, you can use a wired network and configure network settings.

Printing

Configure settings for printer plug-ins installed on the device. You can connect the device to a printer via Wi-Fi or Wi-Fi Direct, and print images or documents.



Some printers may not be compatible with the device.

Adding printer plug-ins

Add printer plug-ins for printers you want to connect the device to.

- 1 On the Settings screen, tap **Connections** → **More connection settings** → **Printing** → **Download plugin**.
- 2 Search for a printer plug-in in **Play Store**.
- 3 Select a printer plug-in and install it.
- 4 Select the installed printer plug-in.

The device will automatically search for printers that are connected to the same Wi-Fi network as your device.

5 Select a printer to add.



To add printers manually, tap  → **Add printer**.

Printing content

While viewing content, such as images or documents, access the options list, tap **Print** → ▼ → **All printers...**, and then select a printer.



Printing methods may vary depending on the content type.

Sound

Options

Change settings for various sounds on the device.

On the Settings screen, tap **Sound**.

- **Sound mode:** Set the device to use sound mode or silent mode.
- **Temporary mute:** Set the device to use silent mode for a certain period.
- **Ringtone:** Change the call ringtone.
- **Notification sound:** Change the notification sound.
- **Volume:** Adjust the device's volume level.
- **System sound:** Set the device to sound for actions, such as controlling the touchscreen.
- **Sound quality and effects:** Set the device's sound quality and effects. Refer to [Dolby Atmos \(surround sound\)](#) for more information.
- **Separate app sound:** Set the device to play media sound from a specific app separately on the other audio device. Refer to [Separate app sound](#) for more information.

Dolby Atmos (surround sound)

Select a surround sound mode optimized for various types of audio, such as movies, music, and voice. With Dolby Atmos, you can experience moving audio sounds that flow all around you.

On the Settings screen, tap **Sound** → **Sound quality and effects** → **Dolby Atmos**, tap the switch to activate it, and then select a mode.

Separate app sound

Set the device to play media sound from a specific app on the connected Bluetooth speaker or headset separate from the sound of other apps.

For example, you can listen to the Navigation app through your device's speaker while listening to playback from the Music app through the vehicle's Bluetooth speaker.

- 1 On the Settings screen, tap **Sound** → **Separate app sound** and tap the switch to activate it.
- 2 Select an app to play media sounds separately and tap the Back button.
- 3 Select a device for playing the selected app's media sound.

Notifications

Options

Change the notification settings.

On the Settings screen, tap **Notifications**.

- **Suggest actions and replies:** Set the device to suggest actions and replies for notifications.
- **Swipe left or right for snooze:** Set the device to show the notification snooze icon when you swipe a notification to the left or right on the notification panel.
- **App icon badges:** Change the settings for app icon badges. Refer to [App icon badges](#) for more information.

- **Status bar:** Set how to display notification icons and whether to show the remaining battery percentage on the status bar.
- **Do not disturb:** Set the device to mute all sounds except for allowed exceptions.
- **Recently sent:** View the apps that received recent notifications and change the notification settings. To customize notification settings for more apps, tap **See all** → ▼ → **All** and select an app from the apps list.

App icon badges

You can set the device to display a number or dot badge on apps that have notifications. You can also set it to display no badges.

- 1 On the Settings screen, tap **Notifications** → **App icon badges** and tap the switch to activate it.
- 2 Select an option under **Badge style**.

Display

Options

Change the display and the Home screen settings.

On the Settings screen, tap **Display**.

- **Light / Dark:** Activate or deactivate dark mode.
- **Dark mode settings:** Reduce eye strain by applying the dark theme when using the device at night or in a dark place. Refer to [Dark mode settings](#) for more information.
- **Brightness:** Adjust the brightness of the display.
- **Adaptive brightness:** Set the device to save power by adjusting the brightness of the display automatically.

- **Font size and style:** Change the font size and style. Refer to [Font size and style](#) for more information.
- **Screen zoom:** Change the screen zoom setting.
- **Screen timeout:** Set the length of time the device waits before turning off the display's backlight.
- **Home screen:** Configure settings for the Home screen, such as the screen grid or layout.
- **Navigation bar:** Change the navigation bar settings. Refer to [Navigation bar \(soft buttons\)](#) for more information.
- **Screen saver:** Set the device to launch a screen saver when the device is charging. Refer to [Screen saver](#) for more information.

Dark mode settings

Reduce eye strain by applying the dark theme when using the device at night or in a dark place.



- The dark theme may not be applied in some apps.
- You can quickly activate or deactivate dark mode on the notification panel. Open the notification panel, swipe downwards, and then tap  (**Dark mode**).

- 1 On the Settings screen, tap **Display** and tap **Dark** to activate it.
- 2 To set the schedule to apply dark mode to the screen, tap **Dark mode settings**, tap the **Turn on as scheduled** switch to activate it, and then select an option.
 - **Sunset to sunrise:** Set the device to turn on dark mode at night and turn it off in the morning based on your current location.
 - **Custom schedule:** Set a specific time to turn on and off dark mode.

Font size and style

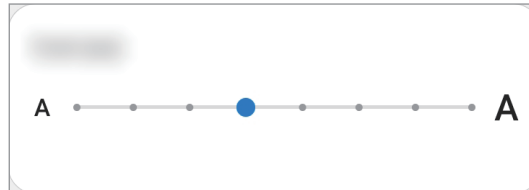

Change the font size and style.

- 1 On the Settings screen, tap **Display** → **Font size and style**.
- 2 Change the font style and boldness setting and drag the adjustment bar under **Font size** to change the size.



Screen saver

You can set to display images as a screen saver when the screen turns off automatically. The screen saver will be displayed when the device is charging.

- 1 On the Settings screen, tap **Display** → **Screen saver**.
 - 2 Select an option.
If you select **Photo Frame** or **Photos**, a slideshow with selected images will start. If you select **Photo Table**, selected images will appear as small cards and overlap.
 - 3 Tap  to select albums for displaying images.
 - 4 When you are finished, tap the Back button.
To preview the selected option, tap **Preview**.
-  When you tap the screen while your screen saver is displayed, the screen will turn on.

Wallpaper

Change the wallpaper settings for the Home screen and the locked screen.

On the Settings screen, tap **Wallpaper**.

Lock screen

Options

Change the settings for the locked screen.

On the Settings screen, tap **Lock screen**.



The available options may vary depending on the screen lock method selected.

- **Screen lock type:** Change the screen lock method.
- **Smart Lock:** Set the device to unlock itself when trusted locations or devices are detected. Refer to [Smart Lock](#) for more information.
- **Secure lock settings:** Change screen lock settings for the selected lock method.
- **Wallpaper services:** Set the device to use wallpaper services such as Dynamic Lock screen.
- **Clock style:** Change the type and color of the clock on the locked screen.
- **Roaming clock:** Change the clock to show both the local and home time zones on the locked screen when roaming. (SM-T505)
- **FaceWidgets:** Change the settings of the items displayed on the locked screen.
- **Contact information:** Set the device to show contact information, such as your email address, on the locked screen.
- **Notifications:** Set how to show notifications on the locked screen.
- **Shortcuts:** Select apps to display shortcuts to them on the locked screen.
- **About Lock screen:** View the Lock screen version and legal information.

Smart Lock

You can set the device to unlock itself and remain unlocked when trusted locations or devices are detected.

For example, if you have set your home as a trusted location, when you get home your device will detect the location and automatically unlock itself.



- This feature will be available to use after you set a screen lock method.
- If you do not use your device for four hours or when you turn on the device, you must unlock the screen using the pattern, PIN, or password you set.

- 1 On the Settings screen, tap **Lock screen** → **Smart Lock**.
- 2 Unlock the screen using the preset screen lock method.
- 3 Select an option and follow the on-screen instructions to complete the setup.

Biometrics and security

Options

Change the settings for securing the device.

On the Settings screen, tap **Biometrics and security**.

- **Face recognition:** Set the device to unlock the screen by recognizing your face. Refer to [Face recognition](#) for more information.
- **Biometrics preferences:** Change the settings for biometric data.
- **Google Play Protect:** Set the device to check for harmful apps and behavior and warn about potential harm and remove them.
- **Security update:** View the version of your device's software and check for updates.
- **Google Play system update:** View the Google Play system version and check for updates.
- **Find My Mobile:** Activate or deactivate the Find My Mobile feature. Access the Find My Mobile website (findmymobile.samsung.com) to track and control your lost or stolen device.

- **Install unknown apps:** Set the device to allow the installation of apps from unknown sources.
- **Encrypt or decrypt SD card:** Set the device to encrypt files on a memory card.
 -  If you reset your device to the factory defaults with this setting enabled, the device will not be able to read your encrypted files. Disable this setting before resetting the device.
- **Other security settings:** Configure additional security settings.

Face recognition

You can set the device to unlock the screen by recognizing your face.



- If you use your face as a screen lock method, your face cannot be used to unlock the screen for the first time after turning on the device. To use the device, you must unlock the screen using the pattern, PIN, or password you set when registering the face. Be careful not to forget your pattern, PIN, or password.
- If you change the screen lock method to **Swipe** or **None**, which are not secure, all of your biometric data will be deleted. If you want to use your biometric data in apps or features, you must register your biometric data again.



Precautions for using face recognition

Before using the face recognition to unlock your device, keep the following precautions in mind.

- Your device could be unlocked by someone or something that looks like your image.
- Face recognition is less secure than Pattern, PIN, or Password.

For better face recognition

Consider the following when using face recognition:

- Consider the conditions when registering, such as wearing glasses, hats, masks, beards, or heavy makeup
- Ensure that you are in a well-lit area and that the camera lens is clean when registering
- Ensure your image is not blurry for better match results

Registering your face

For better face registration, register your face indoors and out of direct sunlight.

- 1 On the Settings screen, tap **Biometrics and security** → **Face recognition**.
- 2 Read the on-screen instructions and tap **Continue**.
- 3 Set a screen lock method.
- 4 Hold the device with the screen facing towards you and look at the screen.
- 5 Position your face inside the frame on the screen.
The camera will scan your face.



If unlocking the screen with your face is not working properly, tap **Remove face data** to remove your registered face and register your face again.

Deleting the registered face data

You can delete face data that you have registered.

- 1 On the Settings screen, tap **Biometrics and security** → **Face recognition**.
- 2 Unlock the screen using the preset screen lock method.
- 3 Tap **Remove face data** → **Remove**.

Once the registered face is deleted, all the related features will also be deactivated.

Unlocking the screen with your face

You can unlock the screen with your face instead of using a pattern, PIN, or password.

1 On the Settings screen, tap **Biometrics and security** → **Face recognition**.

2 Unlock the screen using the preset screen lock method.

3 Tap the **Face unlock** switch to activate it.



- If you want to set the device to unlock the screen without swiping on the locked screen after recognizing your face, tap the **Stay on Lock screen** switch to deactivate it.
- If you want to increase the recognition rate in a dark place, tap the **Brighten screen** switch to activate it.

4 On the locked screen, look at the screen.

When your face is recognized, you can unlock the screen without using any additional screen lock method. If your face is not recognized, use the preset screen lock method.

Privacy

Change the settings for privacy.

On the Settings screen, tap **Privacy**.

- **Permission manager:** View the list of features and apps that have permission to use them. You can also edit the permission settings.
- **Send diagnostic data:** Set the device to automatically send the device's diagnostic and usage information to Samsung.
- **Receive marketing information:** Set whether to receive Samsung marketing information, such as special offers, membership benefits, and newsletters.
- **Samsung account privacy:** Manage personal data related to your Samsung account and change the settings for Customization Service.
- **Advanced:** Configure advanced settings for privacy.

Location

Change settings for location information permissions.

On the Settings screen, tap **Location**.

- **App permissions:** View the list of apps that have permission to access the device's location and edit the permission settings.
- **Improve accuracy:** Set the device to use the Wi-Fi or Bluetooth feature to increase the accuracy of your location information, even when the features are deactivated.
- **Recent location requests:** View which apps request your current location information.
- **Location services:** View the location services your device is using.

Accounts and backup

Options

Sync, back up, or restore your device's data using Samsung Cloud. You can also sign in to accounts, such as your Samsung account or Google account, or transfer data to or from other devices via Smart Switch.

On the Settings screen, tap **Accounts and backup**.

- **Accounts:** Add your Samsung and Google accounts, or other accounts, to sync with.
- **Users:** Set up additional user accounts for other users to use the device with personalized settings, such as email accounts, wallpaper preferences, and more. Refer to [Users](#) for more information.



This feature may not be available depending on the region or service provider.

- **Backup and restore:** Keep your personal information, app data, and settings safe on your device. You can back up your sensitive information and access it later. You must sign in to your Google or Samsung account to back up or restore data.
- **Samsung Cloud:** Manage the content that you want to store securely in Samsung Cloud. Sync and back up your data and settings, and restore the previous device's data and settings even when you do not have it. Refer to [Samsung Cloud](#) for more information.

- **Smart Switch:** Launch Smart Switch and transfer data from your previous device. Refer to [Transferring data from your previous device \(Smart Switch\)](#) for more information.



Regularly back up your data to a safe location, such as Samsung Cloud or a computer, so that you can restore it if the data is corrupted or lost due to an unintended factory data reset.

Users

Set up additional user accounts for other users to use the device with personalized settings, such as email accounts, wallpaper preferences, and more.



This feature may not be available depending on the region or service provider.

Following types of user accounts are available:

- **Administrator:** The administrator account is created only when setting up the device for the first time, and cannot be created more than one. This account has full control of the device including user account management. You can add or delete user accounts only when using this account.
- **Guest:** This account allows guests to access the device. Information and data used during a guest session is temporarily stored. Each time you use this account, you are asked whether to continue the previous guest session or reset it.
- **New user:** This account allows users to access their own apps and content, and customize the device settings that affect all accounts.
- **New restricted account:** A restricted account can only access the apps and content allowed by the administrator account, and cannot use the services that require logging in. (SM-T500)

Adding users

1 On the Settings screen, tap **Accounts and backup** → **Users**.

2 ▶ **SM-T505**: Tap **Add user** → **OK** → **Set up now**.

▶ **SM-T500**: Tap **Add user or profile** → **User** → **OK** → **Set up now**.

The device will switch to a new user account and the default locked screen will appear on the screen.

3 Unlock the device and follow the on-screen instructions to complete the account setup.

Adding restricted profiles (SM-T500)

1 On the Settings screen, tap **Accounts and backup** → **Users**.

2 Tap **Add user or profile** → **User (restricted profile)** → **Set up screen lock**.

If you are not using a secure screen lock method with the administrator account, follow the on-screen instructions to set one up.

3 Select the apps and content that restricted users are allowed to access.

Switching users

Tap the user account icon at the top of the locked screen and select an account to switch to.

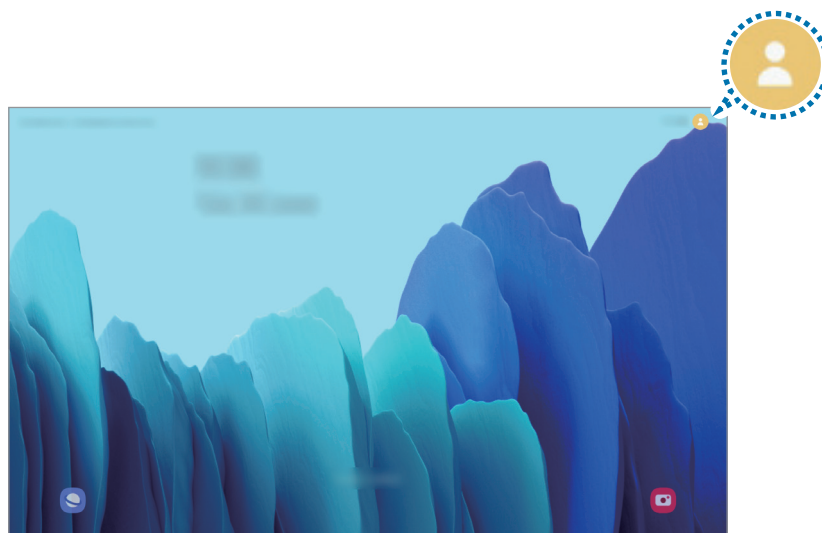

Locked screen

Managing users



When using the administrator account, you can delete accounts or change account settings.

On the Settings screen, tap **Accounts and backup** → **Users**.

▶ **SM-T505**: To delete a user account, tap  next to the account and then tap **Delete user**.

To change an account's settings, tap  next to an account.

▶ **SM-T500**: To delete a user account, tap  next to the account.

To change the settings for a restricted account, tap  next to an account. You can delete the account by tapping .

Samsung Cloud

Sync your device's data with Samsung Cloud and view the data you have synced in each app. You can also back up your device's data to Samsung Cloud and restore it later.



To use Samsung Cloud, you must sign in to your Samsung account.

Syncing data

You can sync data saved in your device with Samsung Cloud and access it from other devices.

1 On the Settings screen, tap **Accounts and backup** → **Samsung Cloud**.

2 Tap  → **Settings** → **Sync and auto backup settings** → **Sync**.

3 Tap the switches next to the items you want to sync with.



- You can check the saved data or change the settings by tapping **Other synced data** or **Samsung Cloud Drive**.
- When you connect your Samsung account and Microsoft account, you can sync images and videos with Microsoft OneDrive.

Backing up data

You can back up your device's data to Samsung Cloud.

- 1 On the Settings screen, tap **Accounts and backup** → **Samsung Cloud** → **Back up this tablet**.
- 2 Tick items you want to back up and tap **Back up**.
- 3 Tap **Done**.



- Some data will not be backed up. To check which data will be backed up, on the Settings screen, tap **Accounts and backup** → **Samsung Cloud** → **Back up this tablet**.
- To view the backup data for other devices in your Samsung Cloud, on the Settings screen, tap **Accounts and backup** → **Samsung Cloud** → **Restore data** → ▼, and then select a device you want.

Restoring data

You can restore your backup data from Samsung Cloud to your device.

- 1 On the Settings screen, tap **Accounts and backup** → **Samsung Cloud**.
- 2 Tap **Restore data** → ▼ and select a device you want.
- 3 Tick items you want to restore and tap **Restore**.

Google

Configure settings for some features provided by Google.

On the Settings screen, tap **Google**.

Advanced features

Options

Activate advanced features and change the settings that control them.

On the Settings screen, tap **Advanced features**.



Excessive shaking or an impact to the device may cause an unintended input for some features using sensors.

- **Side key:** Select an app or feature to launch using the Side key.
- **Accessories:** Change the accessory settings.
- **Call & text on other devices:** Use your device's calling and messaging features on other devices signed in to your Samsung account.



This feature may not be available depending on the region or service provider.

- **Smart pop-up view:** Select apps to view their notifications via pop-up windows. When using this feature, you can quickly view the contents via pop-up windows by tapping the icon on the screen.



This feature is only available in apps that support the Multi window feature.

- **Screenshots:** Change the settings for screenshots.
- **Direct share:** Set the device to display the people you contacted on the sharing options panel to allow you to share content directly.
- **Reduce animations:** Set the device to reduce the screen effects of certain actions, such as opening or closing apps.
- **Motions and gestures:** Activate the motion feature and configure settings. Refer to [Motions and gestures](#) for more information.

Motions and gestures

Activate the motion feature and configure settings.

On the Settings screen, tap **Advanced features** → **Motions and gestures**.

- **Double tap to wake:** Set the device to turn on the screen by double-tapping anywhere on the screen while the screen is turned off.
- **Swipe to call or send messages:** Set the device to make a call or send a message when you swipe to the right or left on a contact or a phone number in the **Phone** or **Contacts** app.

Digital Wellbeing and parental controls

Options

View the history of your device usage and use features to prevent your device from interfering with your life. You can also set up parental controls for your children and manage their digital use.

On the Settings screen, tap **Digital Wellbeing and parental controls**.

- **Digital Wellbeing:** View the daily usage history of your device. Refer to [Digital Wellbeing](#) for more information.
- **Parental controls:** Manage your children's digital use.

Digital Wellbeing

View the daily usage history of your device. You can also limit usage time or change the notification settings for each app.

On the Settings screen, tap **Digital Wellbeing and parental controls** → **Digital Wellbeing**.

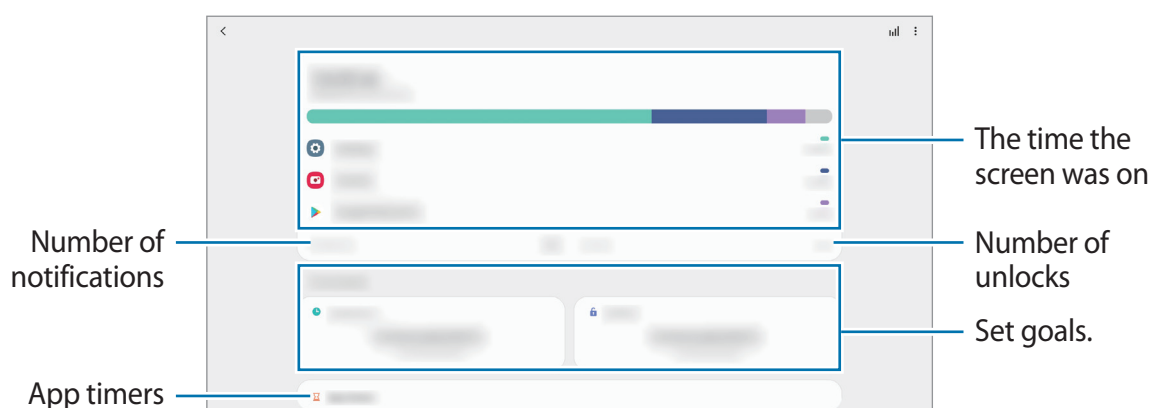

Setting your goals

You can set goals for how long to use your device and how many times to unlock it a day.

- 1 On the Settings screen, tap **Digital Wellbeing and parental controls**.
- 2 Tap **Screen time** or **Unlocks** under **Your goals**, set a goal, and then tap **Set**.

Setting timers for apps

You can limit the daily usage time for each app by setting a timer. When you reach the limit, the app will be deactivated and you cannot use it.

- 1 On the Settings screen, tap **Digital Wellbeing and parental controls** → **App timers**.
- 2 Tap **No timer** next to the app you want and set the time.

Using focus mode

You can activate focus mode to avoid distractions from your device and stay focused on what you want. While focus mode is on, you can only use default apps and the apps you allowed exceptions for.

On the Settings screen, tap **Digital Wellbeing and parental controls**. Then tap the mode you want to activate under **Focus mode** and tap **Start**.

Activating wind down mode

You can activate wind down mode to reduce eye strain before sleeping and prevent your sleep from being disturbed.

- 1 On the Settings screen, tap **Digital Wellbeing and parental controls** → **Wind Down**.
- 2 To set the schedule to activate wind down mode, tap **Turn on as scheduled**, tap the switch to activate it, and then set the days and time.

Device care

Introduction

The device care feature provides an overview of the status of your device's battery, storage, memory, and system security. You can also automatically optimize the device with a tap of your finger.

Optimising your device

On the Settings screen, tap **Device care** → **Optimize now**.

The quick optimization feature improves device performance through the following actions.

- Closing apps running in the background.
- Managing abnormal battery usage.
- Scanning for crashed apps and malware.

Using the auto optimization feature

You can set the device to perform auto optimization when your device is not in use. Tap  → **Advanced** → **Auto optimization** and tap the switch to activate it. If you want to set the time to perform auto optimization, tap **Time**.

Battery

Check the remaining battery power and time to use the device. For devices with low battery levels, conserve battery power by activating power saving features.

On the Settings screen, tap **Device care** → **Battery**.



- The usage time left shows the time remaining before the battery power runs out. Usage time left may vary depending on your device settings and operating conditions.
- You may not receive notifications from some apps that use power saving mode.

Power mode

Select a power mode that suits your device usage purposes.

Tap **Power mode** and select an option.

- **Optimized:** Optimized for a balance between the device's performance and battery usage.
- **Medium power saving:** Activate power saving mode to extend the battery's usage time.
- **Maximum power saving:** In maximum power saving mode, the device decreases battery consumption by activating dark mode and limiting the apps and features available. Network connections, except for the mobile network, will be deactivated.

You can set the device to charge the battery more quickly. Tap **Charging** and tap the **Fast charging** switch to activate it.

Adaptive power saving

You can set the device to activate power saving mode automatically based on your usage patterns and the remaining battery power.

Tap **Power mode** and tap the **Adaptive power saving** switch to activate it. Your device will activate power saving mode based on the situation to extend the battery's usage time.

Putting apps to sleep

You can save battery power by preventing apps that are running in the background from using battery power when they are not being used. Tap **Battery usage**, select apps from the apps list, and then tap the **Put app to sleep** switch to activate the feature.

Storage

Check the status of the used and available memory.

On the Settings screen, tap **Device care** → **Storage**.



- The actual available capacity of the internal memory is less than the specified capacity because the operating system and default apps occupy part of the memory. The available capacity may change when you update the device.
- You can view the available capacity of the internal memory in the Specification section for your device on the Samsung website.

Managing the memory

To delete files or uninstall apps that you do not use any more, select a category. Then, tick items to select and tap **Delete** or **Uninstall**.

Memory

On the Settings screen, tap **Device care** → **Memory**.

To speed up your device by stopping apps running in the background, tick apps from the apps list, and tap **Clean now**.

Security

Check the device's security status. This feature scans your device for malware.

On the Settings screen, tap **Device care** → **Security** → **Scan tablet**.

Apps

Manage the device's apps and change their settings. You can view the apps' usage information, change their notification or permission settings, or uninstall or disable unnecessary apps.

On the Settings screen, tap **Apps**.

General management

Customize your device's system settings or reset the device.

On the Settings screen, tap **General management**.

- **Language and input:** Select device languages and change settings, such as keyboards and voice input types. Some options may not be available depending on the selected language. Refer to [Adding device languages](#) for more information.
- **Date and time:** Access and alter the settings to control how the device displays the time and date.



If the battery remains fully discharged, the time and date is reset.

- **Contact us:** Ask questions or view frequently asked questions.
- **Reset:** Reset your device's settings or perform a factory data reset. You can reset all your settings, or only network settings, or accessibility settings. You can also set the device to restart at a preset time for device optimization.

Adding device languages

You can add languages to use on your device.

- 1 On the Settings screen, tap **General management** → **Language and input** → **Language** → **Add language**.

To view all the languages that can be added, tap  → **All languages**.

- 2 Select a language to add.

- 3 To set the selected language as the default language, tap **Set as default**. To keep the current language setting, tap **Keep current**.

The selected language will be added to your languages list. If you changed the default language, the selected language will be added to the top of the list.

To change the default language from your languages list, select the language you want and tap **Apply**. If an app does not support the default language, the next supported language in the list will be used.

Accessibility

Configure various settings to improve accessibility to the device.

On the Settings screen, tap **Accessibility**.

- **Screen reader:** Activate Voice Assistant, which provides voice feedback. To view help information to learn how to use this feature, tap **Tutorial**.
- **Visibility enhancements:** Customize the settings to improve accessibility for visually impaired users.
- **Hearing enhancements:** Customize the settings to improve accessibility for users with hearing impairment.
- **Interaction and dexterity:** Customize the settings to improve accessibility for users who have reduced dexterity.
- **Advanced settings:** Configure settings for Direct access and notification features.
- **Installed services:** View accessibility services installed on the device.
- **About Accessibility:** View the Accessibility information.
- **Contact us:** Ask questions or view frequently asked questions.

Software update

Update your device's software via the firmware over-the-air (FOTA) service. You can also schedule software updates.

On the Settings screen, tap **Software update**.



If emergency software updates are released for your device's security and to block new types of security threats, they will be installed automatically without your agreement.

- **Download and install:** Check for and install updates manually.
- **Auto download over Wi-Fi:** Set the device to download updates automatically when connected to a Wi-Fi network.
- **Last update:** View information about the last software update.

Security updates information

Security updates are provided to strengthen the security of your device and protect your personal information. For security updates for your model, visit security.samsungmobile.com.



The website supports only some languages.

User manual

View help information to learn how to use the device and apps or configure important settings.

On the Settings screen, tap **User manual**.

About tablet

Access your device's information.

On the Settings screen, tap **About tablet**.

To change your device's name, tap **Edit**.

- **Status:** View various device information, such as the SIM card status, IMEI information, Wi-Fi MAC address and serial number.
- **Legal information:** View legal information related to the device, such as safety information and the open source license.
- **Software information:** View the device's software information, such as its operating system version and firmware version.
- **Battery information:** View the device's battery status and information.

Checking your device's IMEI information (SM-T505)

The International Mobile Equipment Identity (IMEI) is a unique number assigned to your device. You can check whether your device was reported as stolen or lost prior to buying it using the IMEI number.

To view your device's IMEI number, enter `*#06#` on the dialing keypad or access your device's Settings app.



This feature may not be supported by some devices.

Appendix

Troubleshooting

Before contacting a Samsung Service Center, please attempt the following solutions. Some situations may not apply to your device.

When you turn on your device or while you are using the device, it prompts you to enter one of the following codes:

- **Password:** When the device lock feature is enabled, you must enter the password you set for the device.
- **PIN:** When using the device for the first time or when the PIN requirement is enabled, you must enter the PIN supplied with the SIM or USIM card. You can disable this feature by using the Lock SIM card menu.
- **PUK:** Your SIM or USIM card is blocked, usually as a result of entering your PIN incorrectly several times. You must enter the PUK supplied by your service provider.
- **PIN2:** When you access a menu requiring the PIN2, you must enter the PIN2 supplied with the SIM or USIM card. For more information, contact your service provider.

Your device displays network or service error messages

- When you are in areas with weak signals or poor reception, you may lose reception. Move to another area and try again. While moving, error messages may appear repeatedly.
- You cannot access some options without a subscription. For more information, contact your service provider.

Your device does not turn on

When the battery is completely discharged, your device will not turn on. Fully charge the battery before turning on the device.

The touchscreen responds slowly or improperly

- If you attach a screen protector or optional accessories to the touchscreen, the touchscreen may not function properly.
- If you are wearing gloves, if your hands are not clean while touching the touchscreen, or if you tap the screen with sharp objects or your fingertips, the touchscreen may malfunction.
- The touchscreen may malfunction in humid conditions or when exposed to water.
- Restart your device to clear any temporary software bugs.
- Ensure that your device software is updated to the latest version.
- If the touchscreen is scratched or damaged, visit a Samsung Service Center.

Your device freezes or encounters a fatal error

Try the following solutions. If the problem is still not resolved, contact a Samsung Service Center.

Restarting the device

If your device freezes or hangs, you may need to close apps or turn off the device and turn it on again.

Forcing restart

If your device is frozen and unresponsive, press and hold the Side key and the Volume Down key simultaneously for more than 7 seconds to restart it.

Resetting the device

If the methods above do not solve your problem, perform a factory data reset.

Launch the **Settings** app and tap **General management** → **Reset** → **Factory data reset** → **Reset** → **Delete all**. Before performing the factory data reset, remember to make backup copies of all important data stored in the device.

Calls are not connected

- Ensure that you have accessed the right cellular network.
- Ensure that you have not set call barring for the phone number you are dialing.
- Ensure that you have not set call barring for the incoming phone number.

Others cannot hear you speaking on a call

- Ensure that you are not covering the built-in microphone.
- Ensure that the microphone is close to your mouth.
- If using an earphone, ensure that it is properly connected.

Sound echoes during a call

Adjust the volume by pressing the Volume key or move to another area.

A cellular network or the Internet is often disconnected or audio quality is poor

- Ensure that you are not blocking the device's internal antenna.
- When you are in areas with weak signals or poor reception, you may lose reception. You may have connectivity problems due to issues with the service provider's base station. Move to another area and try again.
- When using the device while moving, wireless network services may be disabled due to issues with the service provider's network.

The battery does not charge properly (For Samsung-approved chargers)

- Ensure that the charger is connected properly.
- Visit a Samsung Service Center and have the battery replaced.

The battery depletes faster than when first purchased

- When you expose the device or the battery to very cold or very hot temperatures, the useful charge may be reduced.
- Battery consumption will increase when you use certain features or apps, such as GPS, games, or the Internet.
- The battery is consumable and the useful charge will get shorter over time.

Error messages appear when launching the camera

Your device must have sufficient available memory and battery power to operate the camera app. If you receive error messages when launching the camera, try the following:

- Charge the battery.
- Free some memory by transferring files to a computer or deleting files from your device.
- Restart the device. If you are still having trouble with the camera app after trying these tips, contact a Samsung Service Center.

Photo quality is poorer than the preview

- The quality of your photos may vary, depending on the surroundings and the photography techniques you use.
- If you take photos in dark areas, at night, or indoors, image noise may occur or images may be out of focus.

Error messages appear when opening multimedia files

If you receive error messages or multimedia files do not play when you open them on your device, try the following:

- Free some memory by transferring files to a computer or deleting files from your device.
- Ensure that the music file is not Digital Rights Management (DRM)-protected. If the file is DRM-protected, ensure that you have the appropriate license or key to play the file.
- Ensure that the file formats are supported by the device. If a file format is not supported, such as DivX or AC3, install an app that supports it. To confirm the file formats that your device supports, visit www.samsung.com.
- Your device supports photos and videos captured with the device. Photos and videos captured by other devices may not work properly.
- Your device supports multimedia files that are authorized by your network service provider or providers of additional services. Some content circulated on the Internet, such as ringtones, videos, or wallpapers, may not work properly.

Bluetooth is not working well

If another Bluetooth device is not located or there are connection problems or performance malfunctions, try the following:

- Ensure that the device you wish to connect with is ready to be scanned or connected to.
- Ensure that your device and the other Bluetooth device are within the maximum Bluetooth range (10 m).
- On your device, launch the **Settings** app, tap **Connections**, and then tap the **Bluetooth** switch to re-activate it.
- On your device, launch the **Settings** app, tap **General management** → **Reset** → **Reset network settings** → **Reset settings** → **Reset** to reset network settings. You may lose registered information when performing the reset.

If the tips above do not solve the problem, contact a Samsung Service Center.

A connection is not established when you connect the device to a computer

- Ensure that the USB cable you are using is compatible with your device.
- Ensure that you have the proper driver installed and updated on your computer.

Your device cannot find your current location

GPS signals may be obstructed in some locations, such as indoors. Set the device to use Wi-Fi or a mobile network to find your current location in these situations.

Data stored in the device has been lost

Always make backup copies of all important data stored in the device. Otherwise, you cannot restore data if it is corrupted or lost. Samsung is not responsible for the loss of data stored in the device.

A small gap appears around the outside of the device case

- This gap is a necessary manufacturing feature and some minor rocking or vibration of parts may occur.
- Over time, friction between parts may cause this gap to expand slightly.

There is not enough space in the device's storage

Delete unnecessary data, such as cache, using the device care feature or manually delete unused apps or files to free up storage space.

The Home button does not appear

The navigation bar containing the Home button may disappear while using certain apps or features. To view the navigation bar, drag upwards from the bottom of the screen.

The screen brightness adjustment bar does not appear on the notification panel

Open the notification panel by dragging the status bar downwards, and then drag the notification panel downwards. Tap  → **Quick panel layout**, and tap the **Show brightness on top** switch to activate it.

About Hearing Aid Compatibility (HAC)



The following explanation about HAC is only for the models that have been certified by the FCC in terms of HAC requirements.

HAC for Newer Technologies

This device has been tested and rated for use with hearing aids for some of the wireless technologies that it uses. However, there may be some newer wireless technologies used in this device that have not been tested yet for use with hearing aids. It is important to try the different features of this device thoroughly and in different locations, using your hearing aid or cochlear implant, to determine if you hear any interfering noise.

Consult your service provider or the manufacturer of this device for information on hearing aid compatibility. If you have questions about return or exchange policies, consult your service provider or device retailer.

FCC Hearing Aid Compatibility (HAC) regulations for wireless devices

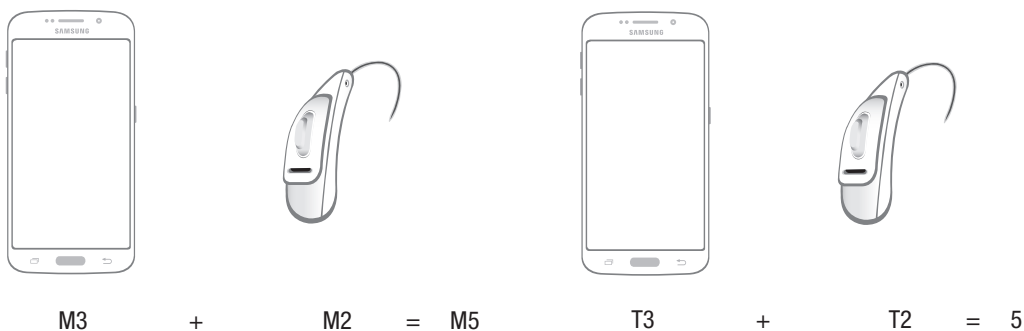

The FCC established requirements for devices to be compatible with hearing aids and other hearing devices. For more information, visit <https://www.fcc.gov/consumers/guides/hearing-aid-compatibility-wireline-and-wireless-telephones>

Copyright

Copyright © 2020 Samsung Electronics Co., Ltd.

This manual is protected under international copyright laws.

No part of this manual may be reproduced, distributed, translated, or transmitted in any form or by any means, electronic or mechanical, including photocopying, recording, or storing in any information storage and retrieval system.

Trademarks

- SAMSUNG and the SAMSUNG logo are registered trademarks of Samsung Electronics Co., Ltd.
- Bluetooth® is a registered trademark of Bluetooth SIG, Inc. worldwide.
- Wi-Fi®, Wi-Fi Direct™, Wi-Fi CERTIFIED™, and the Wi-Fi logo are registered trademarks of the Wi-Fi Alliance.
- Manufactured under license from Dolby Laboratories. Dolby, Dolby Atmos, and the double-D symbol are trademarks of Dolby Laboratories.
- All other trademarks and copyrights are the property of their respective owners.