

SAMSUNG

USER MANUAL

Table of Contents

Getting Started

5 About the Galaxy Watch Active

5 Read me first

11 Device layout

- 11 Package contents
- 12 Galaxy Watch Active
- 14 Wireless charger

15 Battery

- 15 Charging the battery
- 16 Battery charging tips and precautions
- 17 Wireless charging
- 19 Power saving mode

20 Wearing the Galaxy Watch Active

- 20 Putting on the Galaxy Watch Active
- 21 Band tips and precautions
- 21 Replacing the band

23 Turning the Galaxy Watch Active on and off

24 Connecting the Galaxy Watch Active to a mobile device

- 24 Installing the Galaxy Wearable app
- 24 Connecting the Galaxy Watch Active to a mobile device via Bluetooth
- 26 Remote connection

27 Using the Galaxy Watch Active without a mobile device

28 Controlling the screen

- 28 Touchscreen
- 31 Screen composition
- 32 Turning the screen on and off
- 33 Switching the screen
- 35 Lock screen

35 Watch

- 35 Watch screen
- 36 Changing the watch face
- 37 Activating the watch always on feature
- 37 Watch only mode

38 Notifications

- 38 Notification panel
- 39 Viewing incoming notifications
- 40 Selecting apps for receiving notifications

40 Quick panel

47 Entering text

- 47 Introduction
- 47 Using the voice input
- 48 Using emoticons
- 49 Using handwriting input mode or the keyboard

Apps and features

51 Messages

53 Phone

- 53 Introduction
- 53 Receiving calls
- 55 Making calls

55 Contacts

57 Samsung Pay

58 Samsung Health

- 58 Introduction
- 61 Daily activity
- 62 Steps
- 64 Floors
- 65 Calories
- 66 Exercise
- 73 Sleep
- 75 Heart rate
- 77 Stress
- 79 Food
- 81 Weight management
- 82 Water
- 83 Caffeine
- 84 Together
- 85 Settings
- 85 Additional information

86 GPS

87 Music

- 87 Introduction
- 87 Playing music
- 87 Importing music
- 88 Playing music with your Galaxy Watch Active
- 88 Playing music with your mobile device
- 89 Playing music without connecting to a mobile device

89 Reminder

90 Calendar

91 Bixby

- 91 Introduction
- 91 Launching Bixby
- 92 Using Bixby
- 93 Setting the language

93 Weather

94 Alarm

95 World clock

95 Gallery

- 95 Importing and exporting images
- 96 Viewing images
- 97 Deleting images

97 Find My Phone

98 Find My Watch

99 SOS messages

100 Email

100 Galaxy Store

101 Settings

- 101 Introduction
- 101 Watch faces
- 102 Vibration
- 102 Display
- 103 Advanced
- 104 Connections
- 108 Apps
- 109 Security
- 109 Account
- 110 Accessibility
- 110 General
- 112 Battery
- 112 About watch
- 113 Connect to new phone
- 113 Connect to phone

Galaxy Wearable app

114 Introduction

116 Home

- 116 About watch
- 116 Payment
- 116 Galaxy Store
- 116 Samsung Health
- 117 Samsung Pay
- 117 SmartThings
- 117 Notifications
- 118 Apps
- 119 Widgets
- 120 Vibration
- 120 Display
- 121 Advanced
- 122 Add content to your watch
- 123 Send SOS requests

- 123 Find My Watch
- 124 Account and backup
- 125 Sync phone settings
- 126 Accessibility
- 126 About watch
- 127 About Galaxy Wearable

128 Watch faces

128 Discover

Using the Galaxy Watch Active

129 Introduction

129 Using as a personal coach for your health

- 129 Achieving your daily activity target
- 130 Managing stress and sleep quality
- 130 Experiencing enhanced exercises

131 Using as an intelligent planner

- 131 Checking out today's information
- 132 Managing my daily life
- 134 Using dual clock when you are abroad
- 134 Using a convenient reminder

Appendix

135 Troubleshooting

139 Removing the battery

Getting Started

About the Galaxy Watch Active



The Galaxy Watch Active is a smartwatch that can analyse your exercise pattern, manage your health and allows you to use a variety of convenient apps for making phone calls and playing music. You can easily launch the various features with a simple tap and also change the watch face to match your taste.



Connect your Galaxy Watch Active to your mobile device to expand your mobile device experience, or use the Galaxy Watch Active by itself, without connecting to a mobile device.

Read me first

Please read this manual before using this device to ensure safe and proper use.

- Descriptions are based on the device's default settings.
- Some content may differ from your device depending on the region, model specifications, or device's software.
- Content (high quality content) that requires high CPU and RAM usage will affect the overall performance of the device. Apps related to the content may not work properly depending on the device's specifications and the environment that it is used in.
- Samsung is not liable for performance issues caused by apps supplied by providers other than Samsung.
- Samsung is not liable for performance issues or incompatibilities caused by edited registry settings or modified operating system software. Attempting to customise the operating system may cause the Galaxy Watch Active or apps to work improperly.

- Software, sound sources, wallpapers, images, and other media provided with this Galaxy Watch Active are licensed for limited use. Extracting and using these materials for commercial or other purposes is an infringement of copyright laws. Users are entirely responsible for illegal use of media.
- Default apps that come with the Galaxy Watch Active are subject to updates and may no longer be supported without prior notice. If you have questions about an app provided with the Galaxy Watch Active, contact a Samsung Service Centre. For user-installed apps, contact service providers.
- Modifying the Galaxy Watch Active's operating system or installing softwares from unofficial sources may result in Galaxy Watch Active malfunctions and data corruption or loss. These actions are violations of your Samsung licence agreement and will void your warranty.
- Some functions may not work as described in this manual depending on the maker and model of the mobile device you connect to the Galaxy Watch Active.
- You can see the touchscreen clearly even in strong outdoor sunlight by automatically adjusting the contrast range based on the surrounding environment. Due to the nature of the Galaxy Watch Active, displaying fixed graphics for extended periods may result in afterimages (screen burn-in) or ghosting.
 - It is recommended not to use fixed graphics on part or all of the touchscreen for extended periods and turn off the touchscreen when not using the Galaxy Watch Active.
 - You can set the touchscreen to turn off automatically when you are not using it. Tap  (**Settings**) on the Galaxy Watch Active's Apps screen, tap **Display** → **Screen timeout**, and then select the length of time you want the device to wait before turning off the touchscreen.
 - To set the touchscreen to automatically adjust its brightness based on the surrounding environment, tap  (**Settings**) on the Galaxy Watch Active's Apps screen, tap **Display** → **Auto low brightness**, and then tap the switch to activate it.

- Depending on the region or model, some devices are required to receive approval from the Federal Communications Commission (FCC). If your device is approved by the FCC, you can view the FCC ID of the Galaxy Watch Active. To view the FCC ID, tap  (**Settings**) on the Galaxy Watch Active's Apps screen, tap **About watch** → **Device**, and then check the FCC ID under **FCC certification**.
- Depending on the region, you can view the regulatory information on the Galaxy Watch Active. To view the information, tap  (**Settings**) on the Galaxy Watch Active's Apps screen and tap **About watch** → **Regulatory info**.

Maintaining water and dust resistance

Your device supports water- and dust-resistance. Follow these tips carefully to maintain the water- and dust-resistance of your device. Failure to do so may result in damage to your device.

- Do not expose the device to **water moving with force**.
- Do not use your device when you dive into the water, snorkel or try any water sports in fast-flowing water.
- If the device or your hands are wet, dry them thoroughly before handling the device.
- If the device is exposed to fresh water, dry it thoroughly with a clean, soft cloth. If the device is exposed to other liquids, such as salt water, swimming pool water, soapy water, oil, perfume, sunscreen, hand cleaner, or chemical products such as cosmetics, rinse it with fresh water and dry it thoroughly with a clean, soft cloth. If you do not follow these instructions, the device's performance and appearance may be affected.
- **If the device is dropped or receives an impact**, the water- and dust-resistant features of the device may be damaged.
- Do not disassemble your device. The water- and dust-resistant features of the device can be damaged.
- Do not expose your device to a dramatic change in air temperature or water temperature.
- Do not dry your device with a heating machine like a hair drier.
- The water-resistant feature of the device can be damaged in the sauna.

- Some features such as the touchscreen may not work properly **if the device is used in water.**
- **Your device has been tested in a controlled environment and certified to be water- and dust-resistant in specific situations and conditions. (Meets the requirements of the water-resistance in a 50 m deep water as described by the international standard ISO 22810:2010 and your device can be used in shallow water. Meets the requirements of the dust-resistance as described by classification IEC 60529 IP6X.)**

Precautions for overheating

If you feel discomfort due to overheating while using the device, stop using it immediately and remove it from your wrist.

To avoid problems, such as device malfunction, skin discomfort or damage, and battery draining, a warning will appear on the device if it reaches a specific temperature. When the initial warning appears, all device functions will be disabled until the device cools down to a specific temperature.

If the device temperature continues to increase, a second warning will appear. At this time, the device will shut down. Do not use the device until it cools down to a specific temperature.

Instructional icons



Warning: situations that could cause injury to yourself or others



Caution: situations that could cause damage to your device or other equipment



Notice: notes, usage tips, or additional information

Cleaning and managing the Galaxy Watch Active

Follow the points below to ensure your Galaxy Watch Active functions correctly and maintains its appearance. Failure to do so may damage the Galaxy Watch Active and cause the skin irritation.

- Prevent the device from being exposed to dust, sweat, ink, oil, and chemical products such as cosmetics, antibacterial spray, hand cleaner, detergent, and insecticides. The Galaxy Watch Active's exterior and interior parts may be damaged or it could result in poor performance. If your Galaxy Watch Active is exposed to any of the previously mentioned substances, use a lint-free, soft cloth to clean it.
- Do not use soap, cleaning agents, abrasive materials and compressed air when cleaning your Galaxy Watch Active and do not clean it with the ultrasonic waves or the external heat sources. Doing so may damage the Galaxy Watch Active. Skin irritation may be caused by soap, detergents hand sanitizers, or cleaning agents left on the Galaxy Watch Active.
- Clean your wrist and band after exercising or sweating. Clean the Galaxy Watch Active with freshwater, wipe it with a little rubbing alcohol and dry your Galaxy Watch Active thoroughly.
- When you remove sun block, lotion, or oil, use a soap-free detergent, then rinse and dry your Galaxy Watch Active thoroughly.
- If the Galaxy Watch Active's band gets stained or contains any materials, wipe it with a moistened soft bristle toothbrush.

Use caution if you are allergic to any materials on the Galaxy Watch Active

- Samsung has tested the noxious materials found on the Galaxy Watch Active through the internal and external certificate authorities, including the test for all materials which contact with skin, skin toxicity test, and the Galaxy Watch Active-wearing test.
- The Galaxy Watch Active includes nickel. Take the necessary precautions if your skin is hypersensitive or you have an allergy to any materials found on the Galaxy Watch Active.
 - **Nickel:** The Galaxy Watch Active contains a small amount of nickel, which is below its reference point limited by the Europe REACH regulation. You will not be exposed to the nickel inside the Galaxy Watch Active and the Galaxy Watch Active has passed the international certificated test. However, if you are sensitive to nickel, be careful to use the Galaxy Watch Active.
- Only the materials observed the standards of the U.S Consumer Product Safety Commission (CPSC), the regulations of the European countries, and other international standards are used to make a Galaxy Watch Active.
- For more information about how Samsung manages chemicals, refer to the Samsung website (<https://www.samsung.com/uk/aboutsamsung/sustainability/environment/>).

Device layout

Package contents

Refer to the quick start guide for package contents.



- The items supplied with the Galaxy Watch Active, their images, and any available accessories may vary depending on the region or service provider.
- The supplied items are designed only for this Galaxy Watch Active and may not be compatible with other devices.
- Appearances and specifications are subject to change without prior notice.
- You can purchase additional accessories from your local Samsung retailer. Make sure they are compatible with the Galaxy Watch Active before purchase.
- Except the Galaxy Watch Active and some accessories may not have the same water- and dust-resistance certification.
- Use only Samsung-approved accessories. Using unapproved accessories may cause the performance problems and malfunctions that are not covered by the warranty.
- Availability of all accessories is subject to change depending entirely on manufacturing companies. For more information about available accessories, refer to the Samsung website.

Galaxy Watch Active

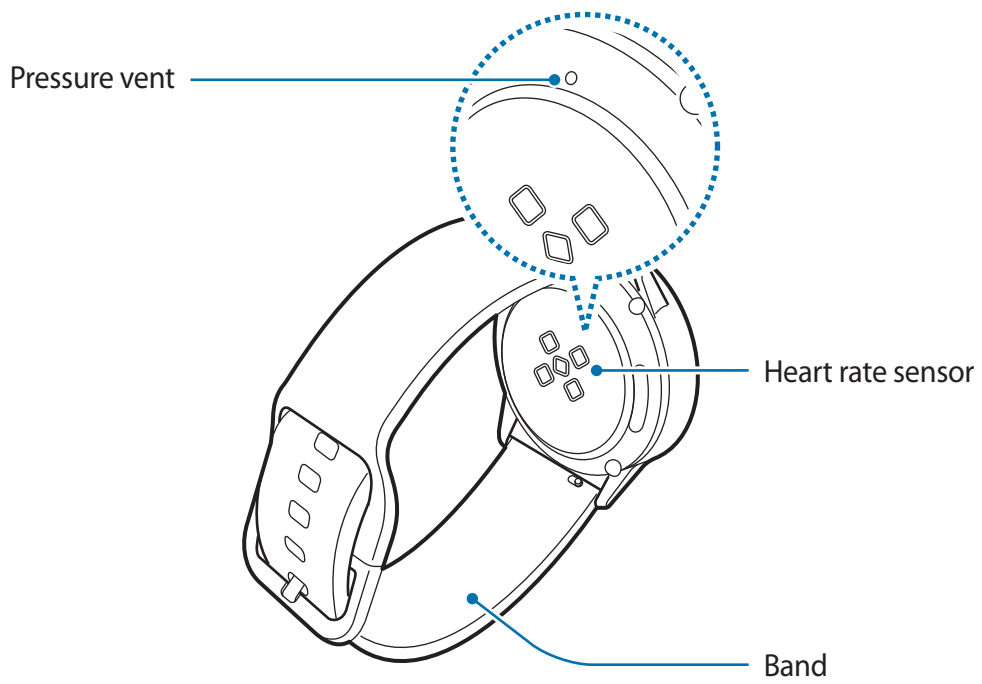
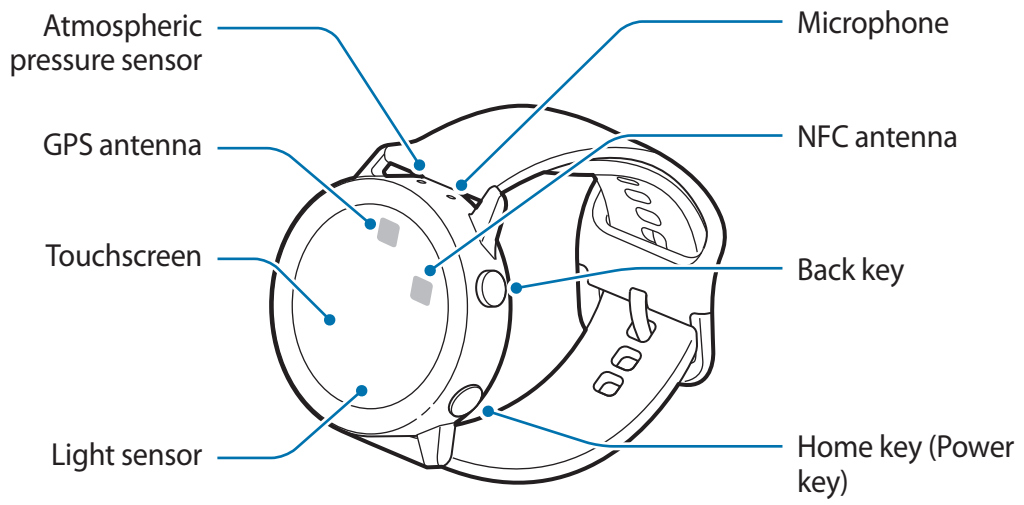



The device and some accessories (sold separately) contain magnets. The American Heart Association (US) and the Medicines and Healthcare Products Regulatory Agency (UK) both warn that magnets can affect the operation of implanted pacemakers, cardioverters, defibrillators, insulin pumps or other electro medical devices (collectively, "Medical Device") within the range of 15 cm (6 inches). If you are a user of any of these Medical Devices, **DO NOT USE THIS DEVICE AND SOME ACCESSORIES (SOLD SEPARATELY) UNLESS YOU HAVE CONSULTED WITH YOUR PHYSICIAN.**





- Do not store your device and some accessories (sold separately) near magnetic fields. Magnetic stripe cards, including credit cards, phone cards, passbooks, and boarding passes, may be damaged by magnetic fields.
- Ensure that the band is kept clean. Contact with contaminants, such as dust and dye, can cause stains on the band that may not be fully removed.
- Do not insert sharp objects into the atmospheric pressure sensor, the pressure vent, or the microphone. Inner components of the Galaxy Watch Active may be damaged along with the water-resistance feature.
- If you use the device with its glass or acrylic body broken, there may be a risk of injury. Use the device only after it has been repaired at a Samsung Service Centre.



- Make sure the Galaxy Watch Active's microphone is not obstructed when you are speaking into it.
- The pressure vent ensures that Galaxy Watch Active's inner parts and sensors work correctly when you use the Galaxy Watch Active in environment where the atmospheric pressure changes.

Keys

Key	Function
 Home/Power	<ul style="list-style-type: none"> • Press and hold to turn the Galaxy Watch Active on or off. • Press to turn on the screen. • Press and hold for more than 7 seconds to restart the Galaxy Watch Active. • Press to open the Apps screen when you are on the Watch screen. • Press to open the Watch screen when you are on any other screen.
 Back	<ul style="list-style-type: none"> • Press to return to the previous screen.

Wireless charger

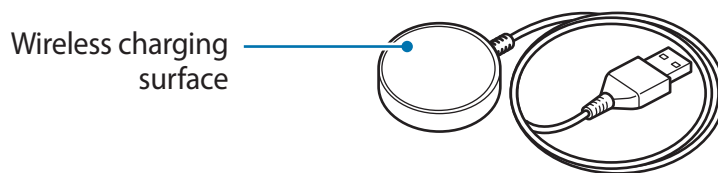

Do not expose the wireless charger to water because the wireless charger does not have same water-resistance certification as your Galaxy Watch Active.

Battery

Charging the battery

Charge the battery before using it for the first time or when it has been unused for extended periods.



Use only Samsung-approved chargers, batteries, and cables. Unapproved chargers or cables can cause the battery to explode or damage the Galaxy Watch Active.



- Use the supplied wireless charger and charger. The Galaxy Watch Active cannot be charged properly with a third-party charger.
- Connecting the charger improperly may cause serious damage to the device. Any damage caused by misuse is not covered by the warranty.



To save energy, unplug the charger when not in use. The charger does not have a power switch, so you must unplug the charger from the electric socket when not in use to avoid wasting power. The charger should remain close to the electric socket and be easily accessible while charging.

- 1 Connect the wireless charger to the charger and plug the charger into an electric socket.
- 2 Place the Galaxy Watch Active into the wireless charger aligning the centre of your Galaxy Watch Active's back side with the centre of the wireless charger.

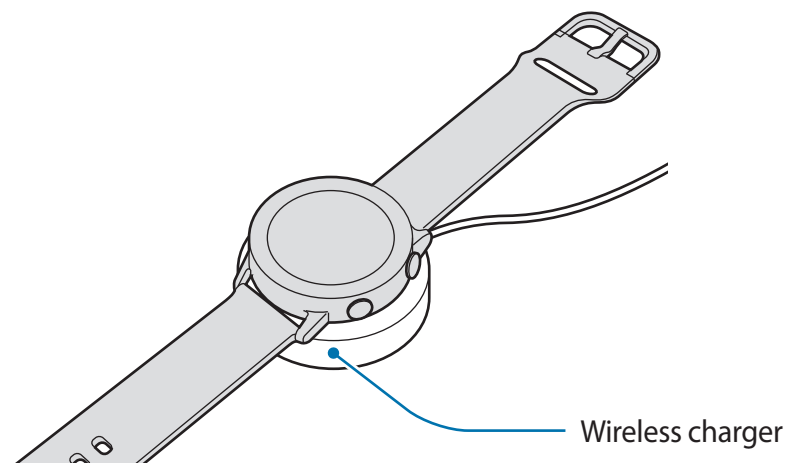

- 3 After fully charging, disconnect the Galaxy Watch Active from the wireless charger. First, disconnect the wireless charger from the charger and then unplug the charger from the electric socket.

Checking the charging status

Press any of the Galaxy Watch Active's keys to turn on the screen while it is on the wireless charger.

While charging the battery when the Galaxy Watch Active is turned off, press any key to check the charging status on the screen.

While charging the battery when the Galaxy Watch Active is turned on, tap the screen to check the charging status.

Battery charging tips and precautions

- If there are obstructions between the Galaxy Watch Active and the wireless charger, the Galaxy Watch Active may not charge properly. Prevent the Galaxy Watch Active and the wireless charger from coming into contact with sweat, liquids, or dust.
- When the battery power is low, the battery icon appears empty.
- If the battery is completely discharged, the Galaxy Watch Active cannot be turned on immediately when the charger is connected. Allow a depleted battery to charge for a few minutes before turning on the Galaxy Watch Active.
- If you use multiple apps at once, the battery will drain quickly. To avoid losing power during a data transfer, always use these apps after fully charging the battery.
- Using a power source other than the charger, such as a computer, may result in a slower charging speed due to a lower electric current.
- If the Galaxy Watch Active is being charged with other devices via a multi charger, charging may take longer.
- The Galaxy Watch Active can be used while it is charging, but it may take longer to fully charge the battery.

- If the Galaxy Watch Active receives an unstable power supply while charging, the touchscreen may not function. If this happens, disconnect the Galaxy Watch Active from the wireless charger.
- While charging, the Galaxy Watch Active may heat up. This is normal and should not affect the Galaxy Watch Active's lifespan or performance. If the battery gets hotter than usual, the charger may stop charging for your safety. If this happens, continue charging the Galaxy Watch Active after allowing it to cool down by removing it from the wireless charger.
- If the Galaxy Watch Active is not charging properly, take the Galaxy Watch Active to a Samsung Service Centre.
- Avoid using a bent or damaged USB cable. If the USB cable is damaged, stop using it.

Wireless charging

The Galaxy Watch Active has a built-in wireless charging coil. You can charge the battery by using a wireless charging pad or another device that functions as a wireless charging pad. The wireless charging pad and other devices that function as wireless charging pads are sold separately.

Charging the battery with a wireless charging pad

- 1 Place the centre of the Galaxy Watch Active's back on the centre of the wireless charging pad.

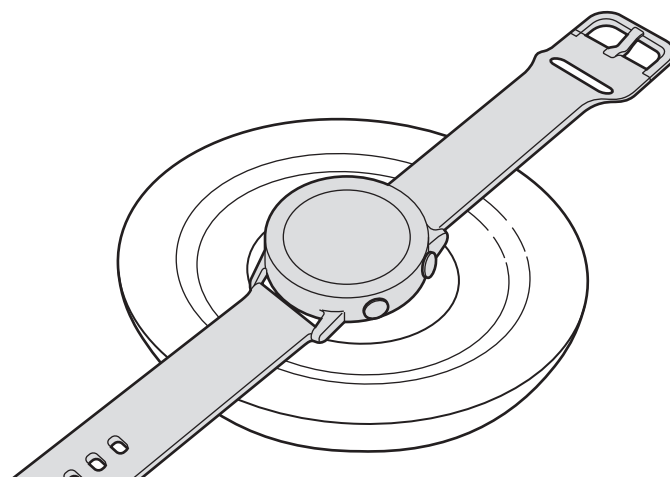

2 After fully charging, disconnect the Galaxy Watch Active from the wireless charging pad.



Precautions for wireless charging

Do not place the Galaxy Watch Active on the wireless charging pad when conductive materials, such as metal objects and magnets, are placed between the Galaxy Watch Active and the wireless charging pad.

The Galaxy Watch Active may not charge properly or may overheat, or the Galaxy Watch Active and the cards may be damaged.



- Use Samsung-approved wireless charging pad. If you use other wireless charging pads, the battery may not charge properly.
- For more information about available wireless charging pads, refer to the Samsung website.

Charging the battery using PowerShare

1 Place the centre of the Galaxy Watch Active's back on the device that functions as a wireless charging pad.



The location of the wireless charging coil may vary by device. Adjust the device and the Galaxy Watch Active to make a strong connection.

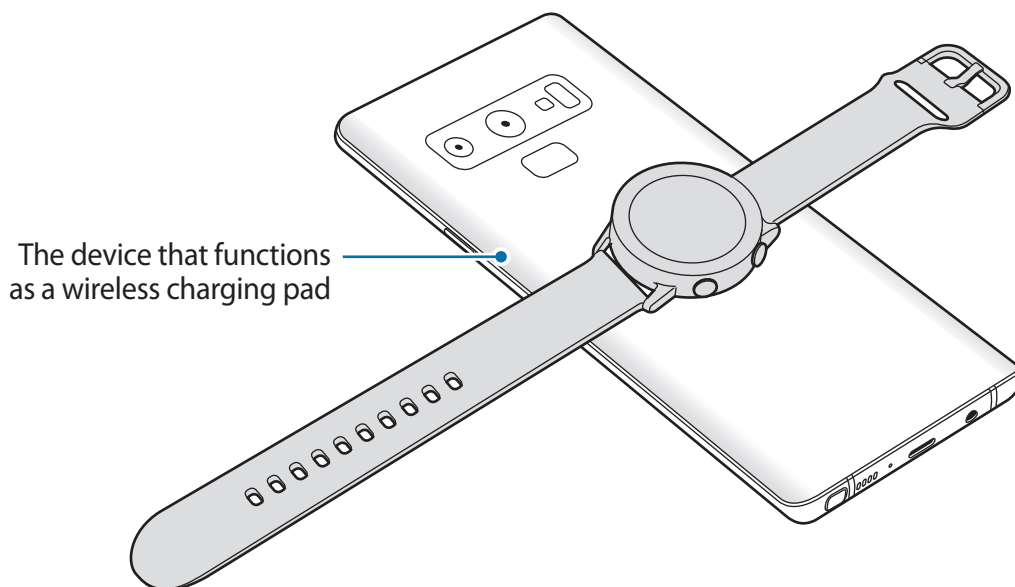

2 After fully charging, disconnect the Galaxy Watch Active from the device.









- To charge properly, do not move or use the device or Galaxy Watch Active while charging.
- If you charge the Galaxy Watch Active while charging the device that functions as a wireless charging pad, the charging speed may decrease or the Galaxy Watch Active may not charge properly, depending on the charger type.
- Charging speed or efficiency may vary depending on the device's condition or the surrounding environment.
- If the remaining battery power of the device that functions as a wireless charging pad drops below a certain level, power sharing will stop.
- For more information about available devices that functions as wireless charging pads, refer to the Samsung website.

Power saving mode

Activate power saving mode to extend the battery's usage time.

- Displays colours on the screen as grey tones.
- Deactivates the Wi-Fi network.
- Limits all functions except for call, message, and notification features.
- Notifications for apps that require a network connection are not received when your Galaxy Watch Active is not connected to the mobile device.
- Limits the performance of the Galaxy Watch Active's CPU.

On the Apps screen, tap  (**Settings**) → **Battery** → **Power saving** → . Alternatively, tap  →  on the quick panel to activate power saving mode. Refer to [Quick panel](#) for more information about how to open the quick panel.

To deactivate this mode, tap **Turn off** at the bottom of the power saving mode screen and tap . Alternatively, tap  on the quick panel to deactivate power saving mode.

Wearing the Galaxy Watch Active

Putting on the Galaxy Watch Active

Open the buckle and place the band around your wrist. Fit the band to your wrist, insert the pin into an adjustment hole, and then secure the buckle to close it.

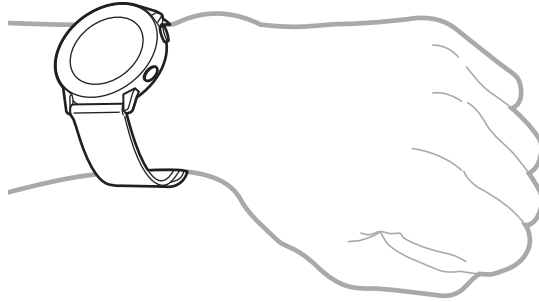

Do not bend the band excessively. Doing so may damage the Galaxy Watch Active.



- To measure your heart rate more accurately with the Galaxy Watch Active, wear the Galaxy Watch Active firmly around your lower arm just above the wrist. Refer to [Wearing the Galaxy Watch Active correctly](#) for more information.
- When certain materials come into contact with the back of the Galaxy Watch Active, your Galaxy Watch Active may recognise that you are wearing it on your wrist.
- If your Galaxy Watch Active does not register that a motion has occurred for more than 10 minutes, your Galaxy Watch Active may recognise that you are not wearing it on your wrist.

Band tips and precautions

- When you wear the Galaxy Watch Active for a long time or do a high-intensity exercise while wearing it, skin irritation may occur due to friction and pressure. If you wearing your Galaxy Watch Active for a long time, remove the Galaxy Watch Active from your wrist and do not wear your Galaxy Watch Active for several hours.
- Skin irritation may occur due to an allergy, environment factors, other factors, or when your skin is exposed to soap or sweat for long periods. In this case, stop using your Galaxy Watch Active and wait 2 or 3 days for the symptoms to ease. If the symptoms persist or worsen, immediately call your doctor.
- Make sure your skin is dry before wearing your Galaxy Watch Active. If you wear a wet Galaxy Watch Active for a long time, your skin may be affected.
- If you use your Galaxy Watch Active in the water, remove foreign materials from your skin and Galaxy Watch Active and dry them thoroughly to prevent the skin irritation.
- Do not use any accessories except the Galaxy Watch Active in the water.

Replacing the band

Detach the band from the Galaxy Watch Active to replace it with a new one.

- 1 Slide the band's spring bar inwards.

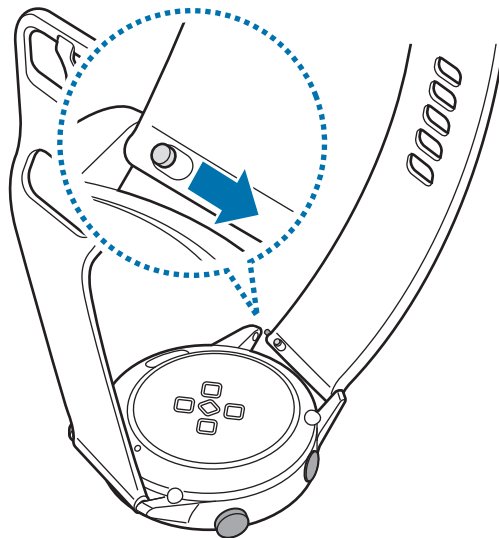

- 2 Pull the band away from the Galaxy Watch Active's body.

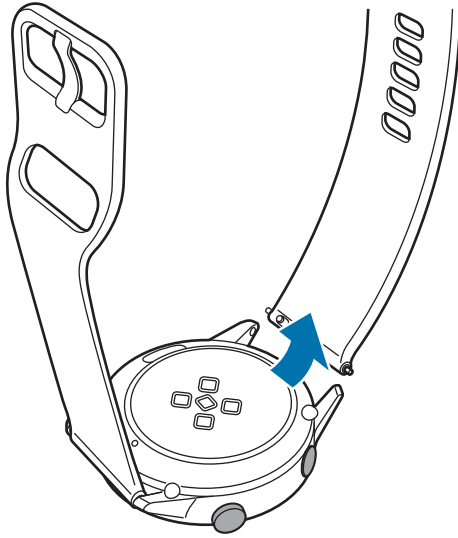

- 3 Insert one end of the spring bar's new band into the Galaxy Watch Active's lug.

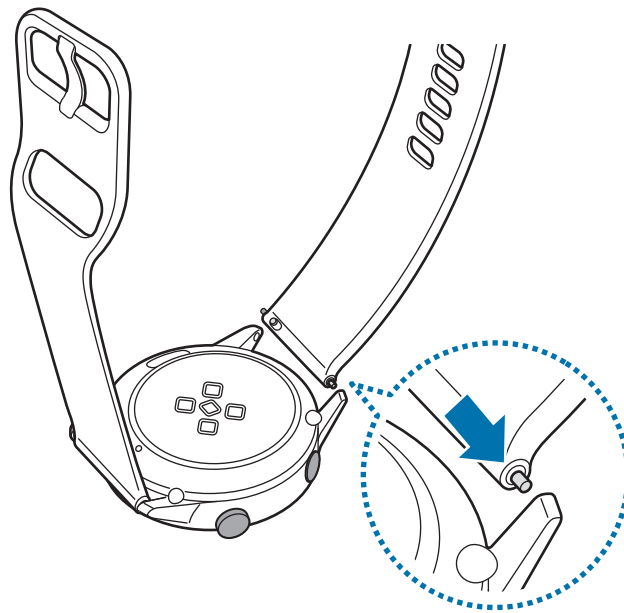

4 Slide the spring bar inwards and connect the new band.

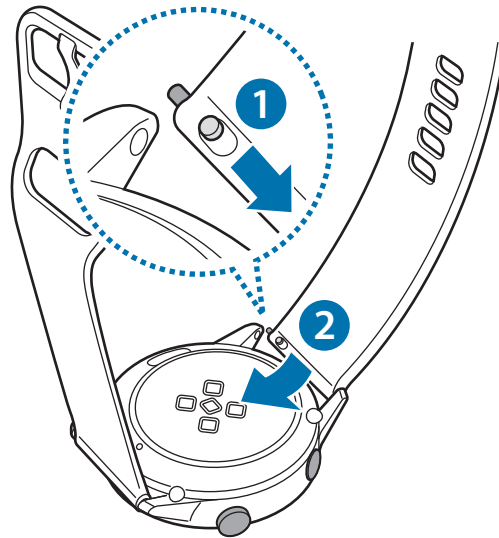

Turning the Galaxy Watch Active on and off

Press and hold the Home key (Power key) for a few seconds to turn on the Galaxy Watch Active.

When you turn on the Galaxy Watch Active for the first time or reset it, on-screen instructions will appear to download and install the Galaxy Wearable app on your mobile device. Refer to [Connecting the Galaxy Watch Active to a mobile device](#) for more information.

To turn off the Galaxy Watch Active, press and hold the Home key (Power key), and then tap **Power off**.

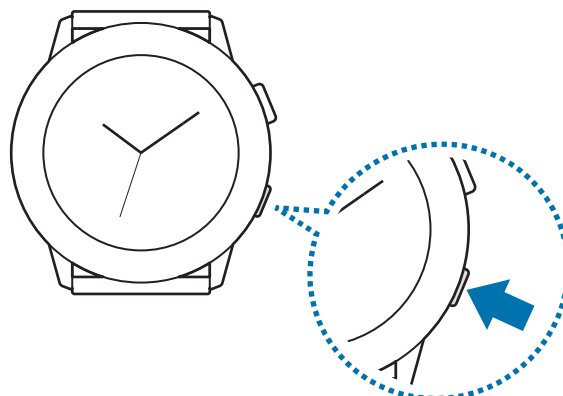

Follow all posted warnings and directions from authorised personnel in areas where the use of wireless devices is restricted, such as aeroplanes and hospitals.

Restarting the Galaxy Watch Active

If your Galaxy Watch Active is frozen and unresponsive, press and hold the Home key (Power key) for more than 7 seconds to restart it.

Connecting the Galaxy Watch Active to a mobile device

Installing the Galaxy Wearable app

You can use other various features after connecting your Galaxy Watch Active to a mobile device. To connect your Galaxy Watch Active to a mobile device, install the Galaxy Wearable app on the mobile device.

Depending on your mobile device, you can download the Galaxy Wearable app from the following places:

- Samsung Android devices: **Galaxy Store, Play Store**
- Other Android devices: **Play Store**



You cannot install the Galaxy Wearable app on the mobile devices that do not support Galaxy Watch Active syncing. Ensure that your mobile device is compatible with a Galaxy Watch Active.

Connecting the Galaxy Watch Active to a mobile device via Bluetooth

Galaxy Watch Active

1 Turn on the Galaxy Watch Active and swipe upwards from the bottom of the screen. A screen will appear about downloading and installing the Galaxy Wearable app.

2 Tap  to select a language to use and follow the on-screen instructions.



If you want to use your Galaxy Watch Active without connecting it to a mobile device, refer to [Using the Galaxy Watch Active without a mobile device](#).

Mobile device

3 Launch the **Galaxy Wearable** app.

If necessary, update the Galaxy Wearable app to the latest version.

4 Tap **Start the journey**.

5 Select your device on the screen.

If you cannot find your device, tap **Mine's not here**.

6 Tap **TURN ON** when the Bluetooth activation request window appears.

7 Follow the on-screen instructions to complete the connection.

When completing the connection, an on-screen tutorial will appear on both the Galaxy Watch Active's screen and the mobile device. Follow the on-screen instructions to learn the Galaxy Watch Active's basic controls.



- Connection methods and screen may vary depending on your mobile device and software version.
- When you connect your Galaxy Watch Active to a mobile device for the first time after resetting it, the Galaxy Watch Active's battery may drain more quickly while syncing data, such as contacts.
- Supported mobile devices and features may vary depending on your region, service provider, and device manufacturer.

Connecting the Galaxy Watch Active to a new mobile device

When you connect the Galaxy Watch Active to a new mobile device, the Galaxy Watch Active will be reset. When the prompt appears before connecting your Galaxy Watch Active to a new mobile device, tap **Back up data** > to securely back up the stored data. Refer to [Managing the data in the Galaxy Watch Active](#) for more information about backing up your Galaxy Watch Active.

- 1 On the Apps screen, tap  (**Settings**) → **Connect to new phone** → ✓.

The connection between your Galaxy Watch Active and your mobile device will end. After a light reset, it will automatically enter Bluetooth pairing mode.

- 2 On your new mobile device, launch the **Galaxy Wearable** app to connect to your Galaxy Watch Active.



If the mobile device you want to connect to is already connected to another device, launch the **Galaxy Wearable** app on your mobile device and tap  → **Add new device** to connect with a new device.

Remote connection

Your Galaxy Watch Active and mobile device are connected via Bluetooth. When a Bluetooth connection is not available, you can remotely connect the Galaxy Watch Active to your mobile device by using your Samsung account via the Wi-Fi network. This allows you to continue receiving notifications from your mobile device.



If this feature is not turned on, launch the **Galaxy Wearable** app on your mobile device, tap **Home** → **Account and backup**, and then tap the **Remote connection** switch.

Using the Galaxy Watch Active without a mobile device



You can use the Galaxy Watch Active without connecting it to a mobile device. Use your Galaxy Watch Active conveniently without connecting to a mobile device while doing outdoor activities such as climbing a mountain or exercise. You can set to use the Galaxy Watch Active without a mobile device when you turn on the Galaxy Watch Active for the first time or you reset it.



- Some features are not available when you using your Galaxy Watch Active without connecting to a mobile device.
- Visit www.samsung.com to view legal notices provided when setting Without phone connection mode for the first time.

- 1 Turn on the Galaxy Watch Active and swipe upwards from the bottom of the screen.
- 2 Tap  and select a language to use.
- 3 Tap , scroll down the screen, and tap **here**.
- 4 Check the notice and tap **Continue** >.
- 5 Read the compulsory terms and conditions and tap **Agree** >.
- 6 Read the additional terms and conditions, select the terms and conditions that you agree to, and then tap **Next** >.
- 7 Login with your Samsung account.
- 8 If you need to restore data, restore another Galaxy Watch Active's data stored in your Samsung account.
- 9 Set a time zone, date, and time.
- 10 Set a PIN for restoring or backing up data.



On the Apps screen, tap  (**Settings**) → **Connect to phone** →  and enter the PIN to connect the Galaxy Watch Active to a mobile device while using the Galaxy Watch Active without a mobile device.

Controlling the screen

Touchscreen



- Do not allow the touchscreen to come into contact with other electrical devices. Electrostatic discharges can cause the touchscreen to malfunction.
- To avoid damaging the touchscreen, do not tap it with anything sharp or apply excessive pressure to it with your fingertips.
- It is recommended not to use fixed graphics on part or all of the touchscreen for extended periods. Doing so may result in afterimages (screen burn-in) or ghosting.



- The Galaxy Watch Active may not recognise touch inputs close to the edges of the screen, which are outside of the touch input area.
- It is recommended to use fingers when you use the touchscreen.
- The touchscreen may not be available when water lock mode is activated.

Tapping

To open an app, to select a menu item, or to press an on-screen button, tap it with your finger.

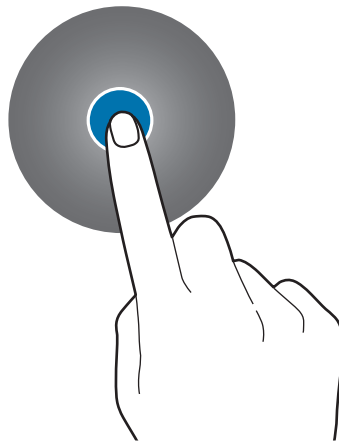

Tapping and holding

Tap and hold the screen for two or more seconds to access the edit mode or to view available options.

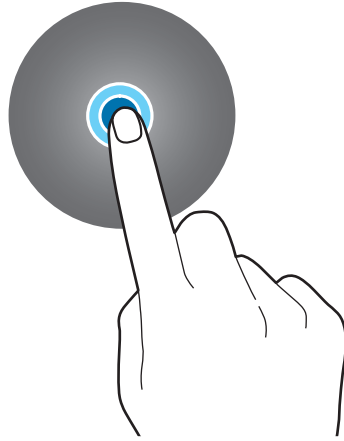

Dragging

To move an item, tap and hold it and drag it to the target position.



Double-tapping

Double-tap on an image to zoom in or out.

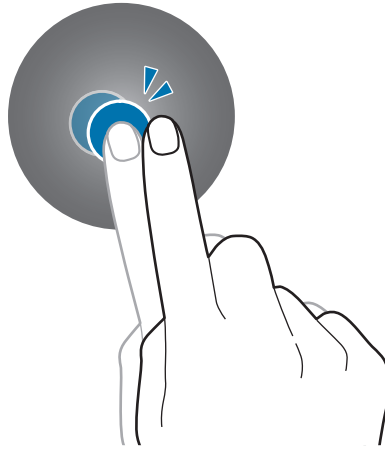

Spreading and pinching

Spread two fingers apart or pinch on an image to zoom in or out.

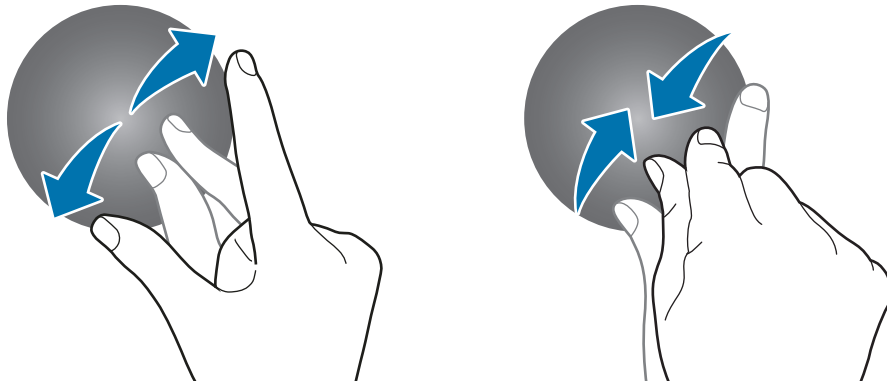

Swiping

Swipe to the left or right to view other panels.

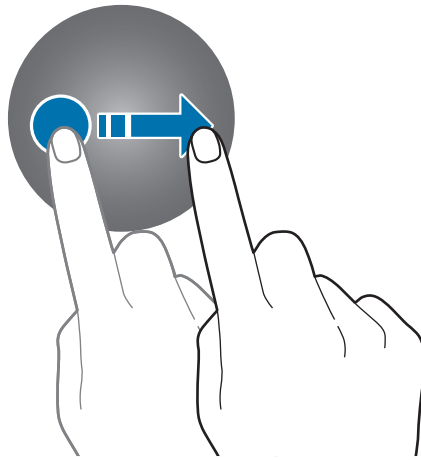

Screen composition

The Watch screen is the starting point for accessing all of the Galaxy Watch Active's many screens.

You can view other screens by pressing the key or swiping your finger on the screen.

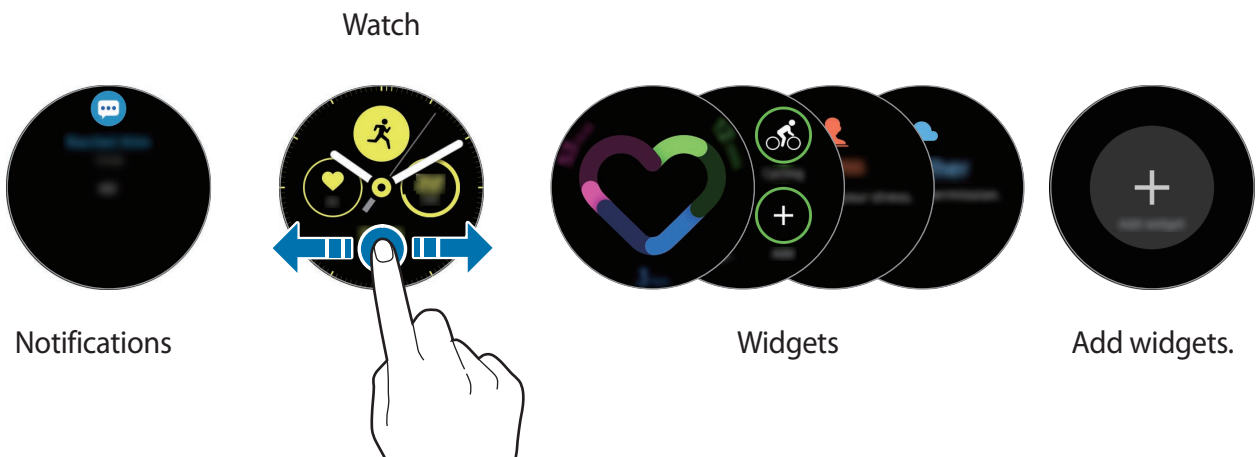

Available widgets, notifications, and their arrangement may vary depending on the software version.

Adding widgets

You can add more widgets on the Home screen.

Scroll left on the screen, tap , and select a widget. The selected widget will appear in a new panel.

Moving widgets

Tap and hold a widget and then drag it to the desired location.

Removing widgets

Tap and hold a widget and then tap .

Turning the screen on and off

To turn on the screen, press the Home key or the Back key.

If the screen does not turn on after you tap the screen, tap  (**Settings**) on the Apps screen, tap **Advanced** → **Touch wake-up**, and then tap the switch to activate the it.

To turn off the screen, cover it with your palm. Also, the screen will automatically turn off if the Galaxy Watch Active is not used for a specified period.

You can also turn on the screen using the wake-up gesture feature. On the Apps screen, tap  (**Settings**) → **Advanced** → **Wake-up gesture** and tap the switch to activate it.

Switching the screen

Switching between the Watch and Apps screen

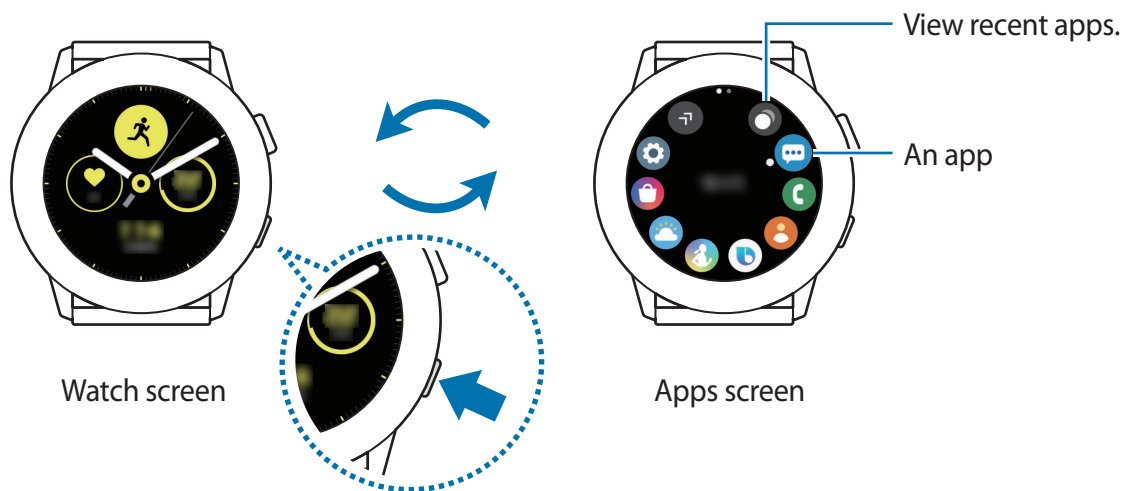

To open the Apps screen, press the Home key on the Watch screen.

To return to the Watch screen, press the Home key.



Apps screen

The Apps screen displays icons for all apps installed on the Galaxy Watch Active.

To move to the next or previous Apps screen, swipe the screen to the left or right or tap  or .



The available apps may vary depending on the software version.



Opening apps

On the Apps screen, tap an app icon to launch the app.



To launch an app from the list of recently used apps, tap  (**Recent apps**) on the Apps screen.

Alternatively, swipe the screen to the left on the Watch screen and select the recently launched app or frequently used app from the **App shortcuts** widget to launch the app.



To add an app you want to the **App shortcuts** widget, tap  and add the app. If there is no space to add the frequently used app, tap and hold the screen, tap **EDIT**, and then tap  on the previously added app to add another app.

Closing apps

- 1 On the Apps screen, tap  (**Recent apps**).
- 2 Swipe the screen to the left or right to move to the app to close.
- 3 Tap .

To close all running apps, tap **Close all**.

Returning to the previous screen

To return to the previous screen, press the Back key.

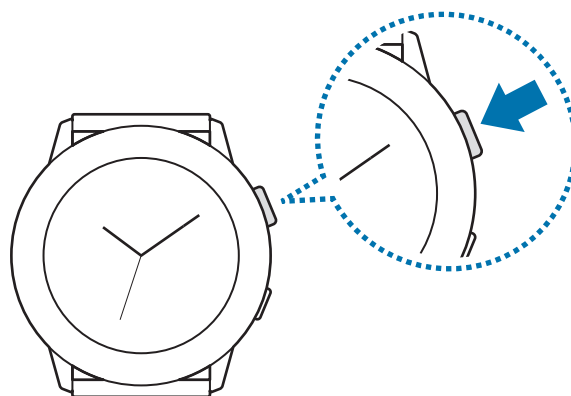

Lock screen

Use the screen lock feature to protect your personal information by preventing others from accessing your Galaxy Watch Active. After activating the screen lock feature, the Galaxy Watch Active will require an unlock code whenever unlocking it.

Setting the screen lock

On the Apps screen, tap  (Settings) → Security → Lock → Type and select the lock method.

- **Pattern:** Draw a pattern with four or more dots to unlock the screen.
- **PIN:** Enter a PIN with numbers to unlock the screen.

Watch

Watch screen

You can check the current time or view other information. When you are not on the Watch screen, press the Home key to return to the Watch screen.





Changing the watch face

Tap and hold the Watch screen and swipe the screen to the left or right, and then select a watch face.

You can also customise the watch by tapping **Customise**.

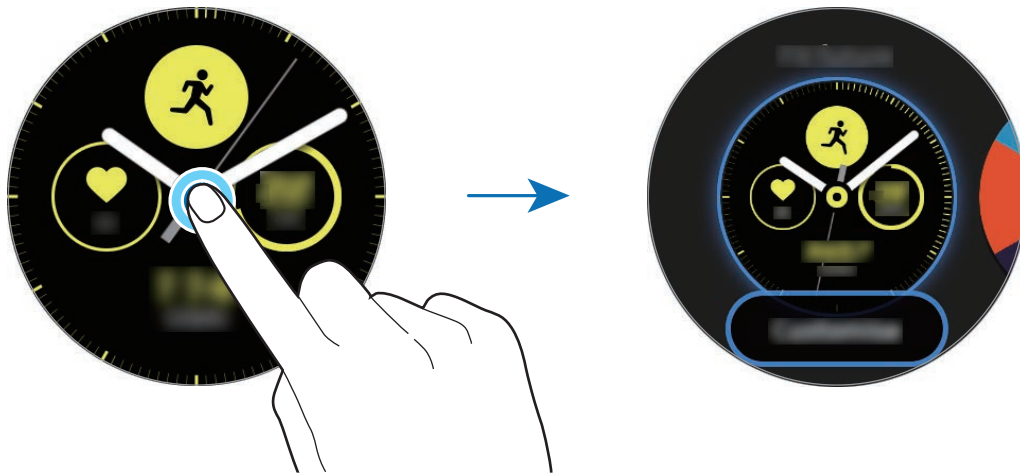
To download more watch faces from the **Galaxy Store** app, tap **Galaxy Store**.



You can also change the watch face. On the Apps screen, tap  (**Settings**) → **Watch faces** → **Watch faces**.

You can also change the Galaxy Watch Active's watch face from your mobile device. Launch the **Galaxy Wearable** app on your mobile device and tap **Watch faces** or **Discover**. To download more watch faces from the **Galaxy Store** app, tap **VIEW MORE** on **Featured watch faces**.

Customise a watch face with a photo

Apply a photo as your watch face after importing a photo from your mobile device. Refer to [Importing images from your mobile device](#) for more information about importing photos from a mobile device.

- 1 Tap and hold the Watch screen and swipe the screen to the left or right, and then tap **Customise** of the **My Photo+** watch face.
- 2 Tap the screen and tap **Add photo**.

3 Select a photo to apply as a watch face and tap **OK** → **OK**.

You can zoom in or out of the photo by double-tapping the image quickly, spreading two fingers apart, or pinching on an image. When the photo is zoomed in, swipe the screen to make a part of the photo appear on the screen.





To add extra photos, swipe the screen to the left and select **Add photo**. Up to twenty photos can be added as the watch face. The photos you add will rotate in a row.

4 Swipe the screen to change the colour or font and tap **OK**.



Activating the watch always on feature

You can set the screen to always display the time when the screen is turned off while you are wearing your Galaxy Watch Active.

On the quick panel, tap . Alternatively, on the Apps screen, tap  (**Settings**) → **Watch faces** → **Watch always on**, and then tap the switch to activate it.

Watch only mode

You can use your Galaxy Watch Active in watch only mode. In watch only mode, only the time will display and all other functions cannot be used.

On the quick panel, tap . Alternatively, on the Apps screen, tap  (**Settings**) and tap **Battery** to open the battery management menu. Then select **Watch only** and tap .

To deactivate watch only mode, press and hold the Home key for more than three seconds.

Notifications

Notification panel

Check a notification such as a new message or a missed call on the notification panel. On the Watch screen, swipe to the right to open the notification panel. When there are unchecked notifications, an orange dot will be visible on the Watch screen.

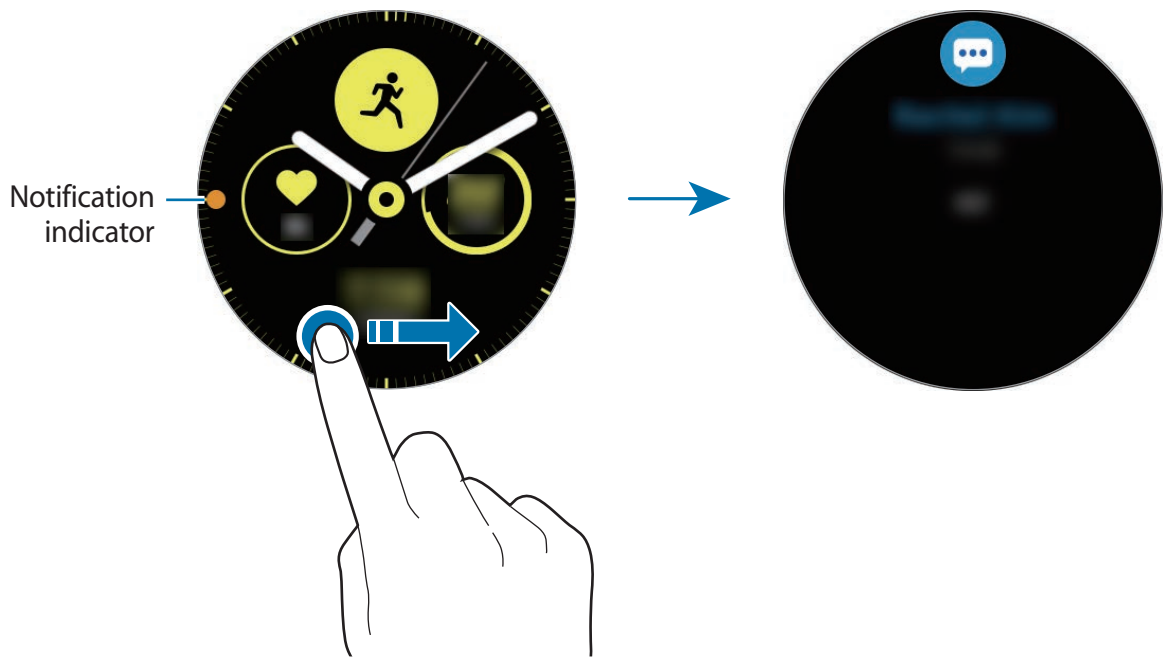

Viewing incoming notifications

When you receive a notification, information about the notification, such as its type or the time you received it, will appear on the screen. If more than two notifications are received, swipe the screen to the left or right to view more notifications.

Tap the notification to view details.

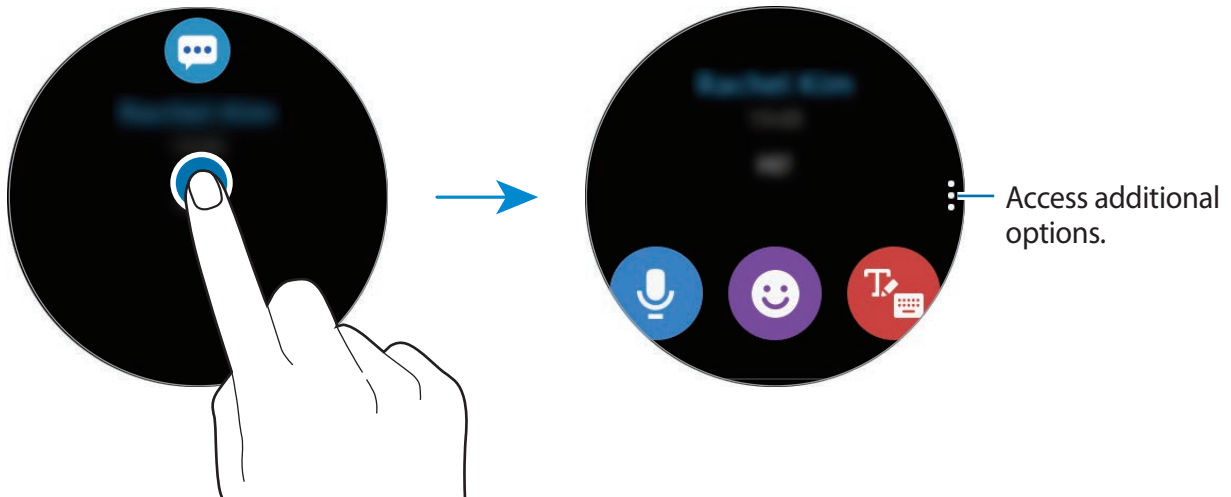

Deleting notifications

Delete a notification by swiping upwards on the screen while viewing a notification.



Selecting apps for receiving notifications

Select an app from your mobile device to receive notifications on your Galaxy Watch Active.

- 1 Launch the **Galaxy Wearable** app on your mobile device and tap **Home** → **Notifications**, and tap the switch.
- 2 Tap **Manage notifications** and tap the switch next to apps to receive notifications from them on your Galaxy Watch Active.

Quick panel

This panel allows you to view the Galaxy Watch Active's current status and configure settings. Swipe downwards from the top edge of the screen.

When there are more than nine quick setting icons, swipe the screen to the left or right to move to the next or previous quick panel.

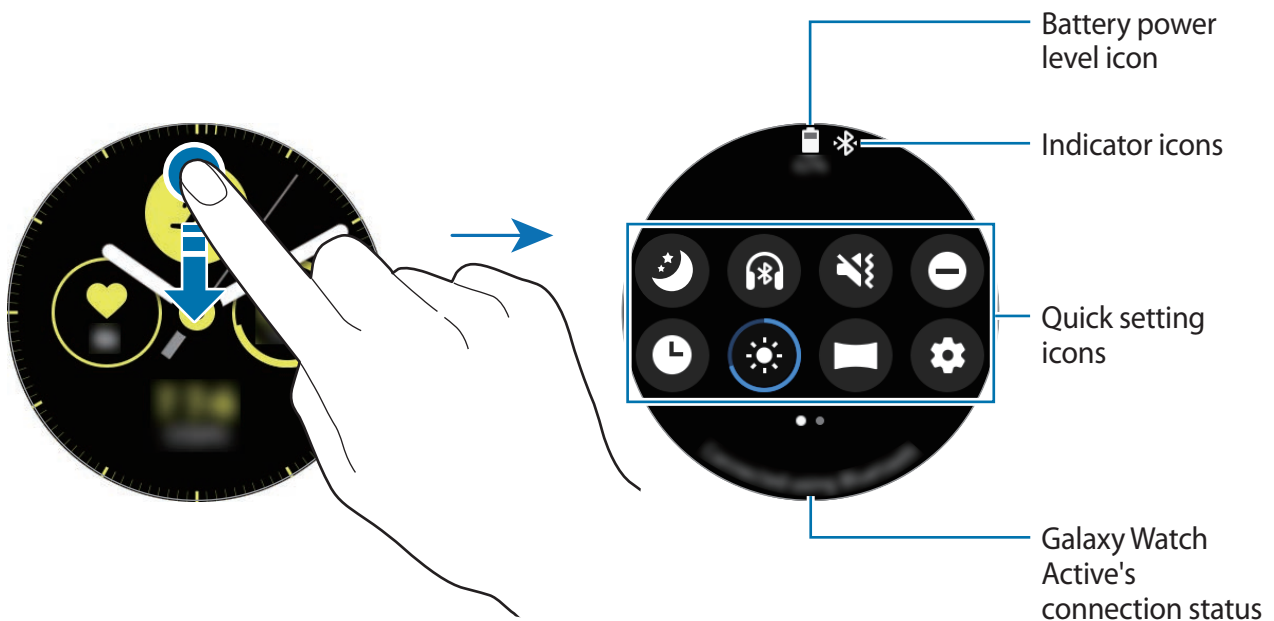





Checking the indicator icons

Indicator icons appear at the top of the quick panel and let you know the Galaxy Watch Active's current status. The icons listed in the table below are most common.











The indicator icons shown may vary depending on the region.











Icon	Meaning
	Bluetooth connected
	Bluetooth disconnected
	Bluetooth headset connected
	Wi-Fi connected
	Battery power level

Checking quick setting icons

Quick setting icons appear on the quick panel. Tap the icon to change the basic settings or launch the function conveniently.

Refer to [Editing the quick setting icons](#) for more information about adding the new icons on the quick panel.

Icon	Meaning
	Activate goodnight mode
	Connect the Bluetooth headset
	Activate vibrate or silent mode
	Activate do not disturb mode
	Activate the watch always on feature
	Adjust the brightness
	Activate theatre mode
	Launch the Settings app

Icon	Meaning
	Activate power saving mode
	Activate flight mode
	Activate water lock mode
	Connect the Wi-Fi network or connect the Wi-Fi network automatically
	Activate the location information feature
	Open the battery management menu
	Launch the Find My Phone app
	Activate the NFC feature
	Play or pause music
	Activate the touch sensitivity feature

Editing the quick setting icons

You can edit the icons on the quick panel.

Adding a quick setting icon

Tap and hold a quick setting icon on the quick panel and tap , then select a feature you want to add on the quick panel.

The icon for the feature you select will be added on the quick panel.

Removing a quick setting icon

Tap and hold a quick setting icon you want to delete on the quick panel and tap .

The quick setting icon will be removed.



You can also edit the quick panel. On the Apps screen, tap  (**Settings**) → **Advanced** → **Edit quick settings**.

Activating goodnight mode

Activate goodnight mode for sleeping.

On the quick panel, tap .

The  icon will appear at the top of the Watch screen. All notifications except for alarms are muted and the screen will not turn on when notifications are received while sleeping. Also, the wake-up gesture feature and watch always on feature will be deactivated automatically.

Connecting the Bluetooth headset

Connect the Bluetooth headset and you can listen music through it.

On the quick panel, tap .

The Bluetooth feature is activated and the available Bluetooth headsets list will be searched. If the previously used Bluetooth is available, it will be connected automatically.

Activating vibrate or silent mode

Activate vibrate or silent mode.

On the quick panel, tap  or .

Activating do not disturb mode

Set the Galaxy Watch Active to mute all notifications except for alarms and the screen will not turn on when notifications are received.

On the quick panel, tap  and select the do not disturb option you want.

The  icon will appear at the top of the Watch screen.

Activating the watch always on feature

Set the screen to always display the time when the screen is turned off while you are wearing your Galaxy Watch Active.

On the quick panel, tap .

If you activate this feature, the battery will drain more quickly than normal.

Adjusting the brightness

You can adjust the Galaxy Watch Active's brightness as desired.

On the quick panel, tap  and adjust the brightness by tapping **+** or **-**.

Activating theatre mode

Activate theatre mode for watching movies.

On the quick panel, tap .

The  icon will appear at the top of the Watch screen. All alarms and notifications are muted and the screen will not turn on when a notification is received or when there is an alarm. Also, the wake-up gesture feature and watch always on feature will be deactivated automatically.

Launching the Settings app

Launch the **Settings** app to configure the Galaxy Watch Active's various features.

On the quick panel, tap .

The **Settings** app will launch.

Activating power saving mode

Activate power saving mode to restrict some Galaxy Watch Active features and reduce the battery usage.

On the quick panel, tap .

Displays colours on the screen as grey tones.

Refer to [Power saving mode](#) for more information.

Activating the flight mode

Activate the flight mode when you board an aeroplane. Activating this feature will restrict apps that require an network connection, but allow you to use other features as normal.

On the quick panel, tap .

The  icon will appear at the top of the Watch screen.

Activating water lock mode

Activate water lock mode when you exercise in water.

On the quick panel, tap .

The touchscreen, the wake-up gesture feature, and the watch always on feature will be deactivated automatically.

Press and hold the Home key until the circle disappears to turn off water lock mode.

Connecting to a Wi-Fi network

Connect to a Wi-Fi network manually or set the Wi-Fi network to connect automatically.

On the quick panel, tap  or .

The Wi-Fi network will be connected or disconnected. The Wi-Fi network will be connected automatically when  appears.



 does not appear and the Wi-Fi network does not connect automatically when you use the Galaxy Watch Active without connecting to a mobile device.

Activating the location information feature

Activate the location information to use GPS data and location data with certain apps.

On the quick panel, tap .

Opening the battery management menu

Open the battery management menu to manage the battery consumption easily.

On the quick panel, tap .

The battery management menu will be appear.

Launching the Find My Phone app

Launch the **Find My Phone** app and find your mobile device when you misplace it.

On the quick panel, tap .

The mobile device will emit sound and turn on the screen. Refer to [Find My Watch](#) for more information.



This feature is not displayed when you use the Galaxy Watch Active without connecting to a mobile device.

Activating the NFC feature

Activate the NFC feature.

On the quick panel, tap .

The NFC feature can be used conveniently with the NFC antenna. Refer to [NFC](#) for more information.

Playing or pausing music

Play or pause music.

On the quick panel, tap  or .

Music is played or paused on the Galaxy Watch Active or the connected mobile device. You can also listen to music after connecting the Bluetooth headset.

Activating the touch sensitivity feature

Activate the touch sensitivity feature to use the touchscreen while wearing gloves.

On the quick panel, tap .



Depending on the type of gloves, the touchscreen might not recognise your touch and the feature may not activate.

Entering text

Introduction

A text input screen will appear when you are able to enter text, such as when sending a message.



- The text input screen may be different depending on the app you launch.
- When the Galaxy Watch Active is connected to a mobile device via Bluetooth, the language settings applied on the mobile device are applied to the Galaxy Watch Active.

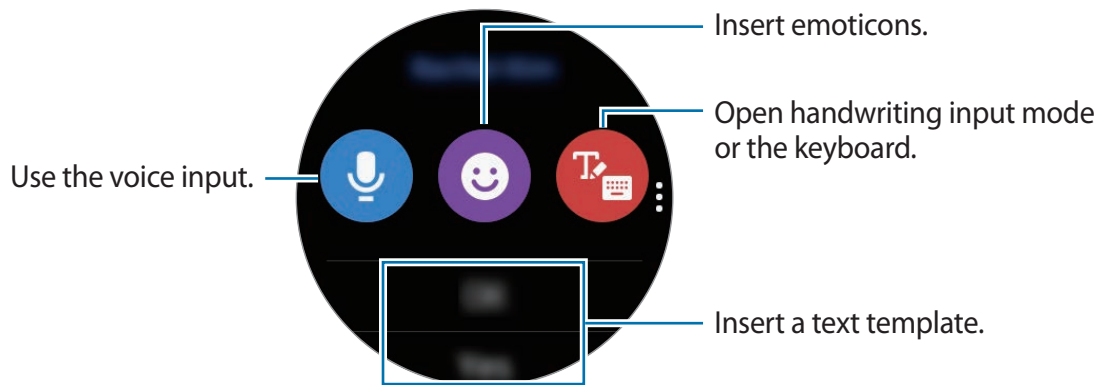

Using the voice input

Tap  and speak to enter your message.

To change the language recognised, tap  → **Input languages**.

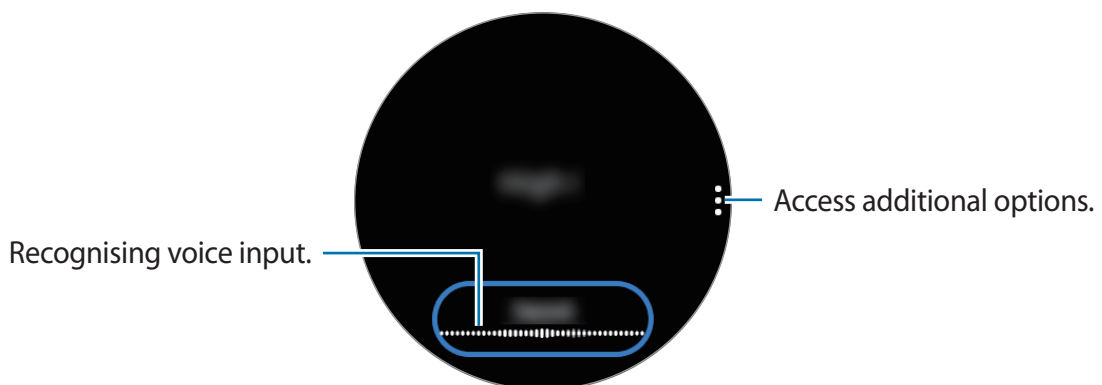



• This feature is not supported in some languages.

• **Tips for better voice recognition**

- Speak clearly.
- Speak in quiet places.
- Do not use offensive or slang words.
- Avoid speaking in dialectal accents.

The Galaxy Watch Active may not recognise your spoken message depending on your surroundings or how you speak.

Using emoticons

Tap 😊 and select the category. The emoticon list of the selected category will appear.

To draw a picture, tap **Doodle** at the top of the screen, and draw your message.

Tap ↶ to delete the input stroke by stroke. To recover a stroke, tap ↷.

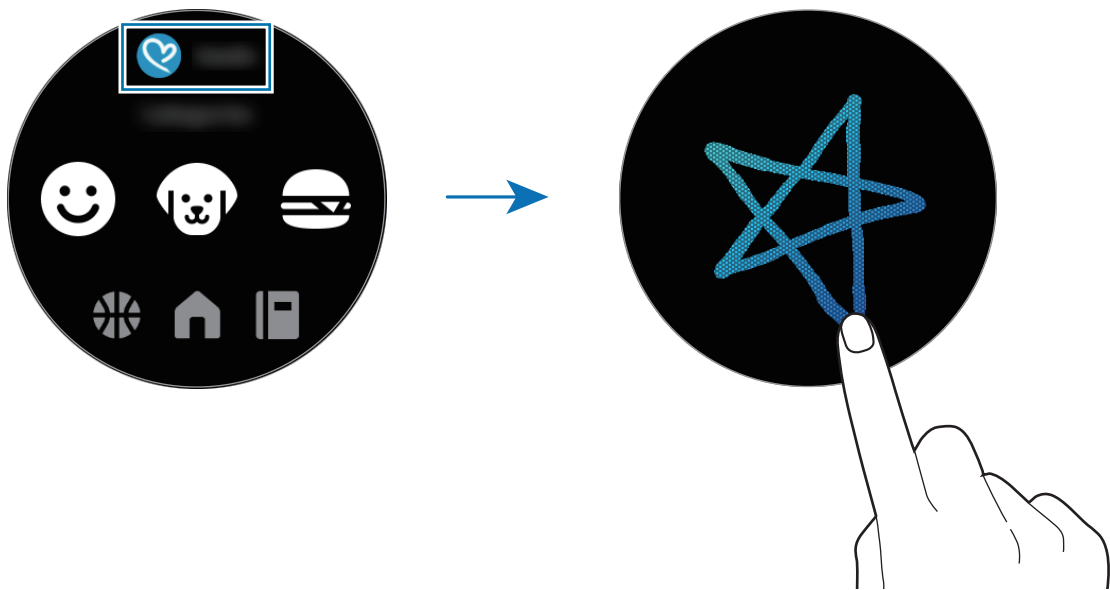

Using handwriting input mode or the keyboard

Tap  to open handwriting mode and write on the screen.

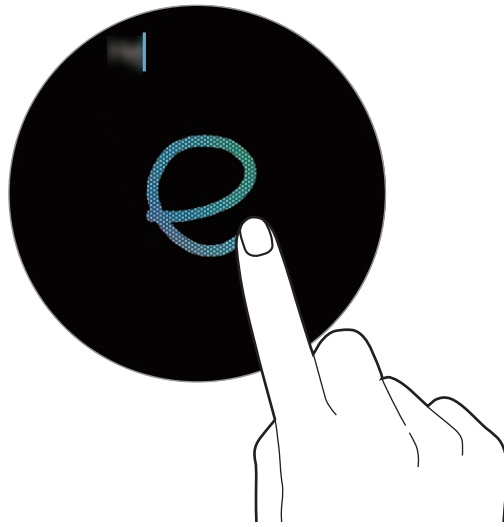

This feature may not be available depending on the region.

Changing the input mode

Swipe the screen to the right from the left edge of the text input screen and select an input mode you want. You can switch between text mode, emoticon mode, number mode, voice input mode, handwriting mode, and punctuation mode.



Handwriting input mode may not be available depending on the region.

Changing the input language

Drag the space key to the left or right while tapping and holding it to change the input language in text mode.

To add more languages, switch to number mode, punctuation mode, or emoticon mode. Then, tap  → **Select input languages** and select a language to add. You can use up to two languages.

Using the keyboard

Swipe the screen to the right from the left edge of the text input screen and select .

The keyboard will appear in text mode.



- Text entry is not supported in some languages. To enter text, you must change the input language to one of the supported languages.
- The keyboard layout may differ depending on the region.

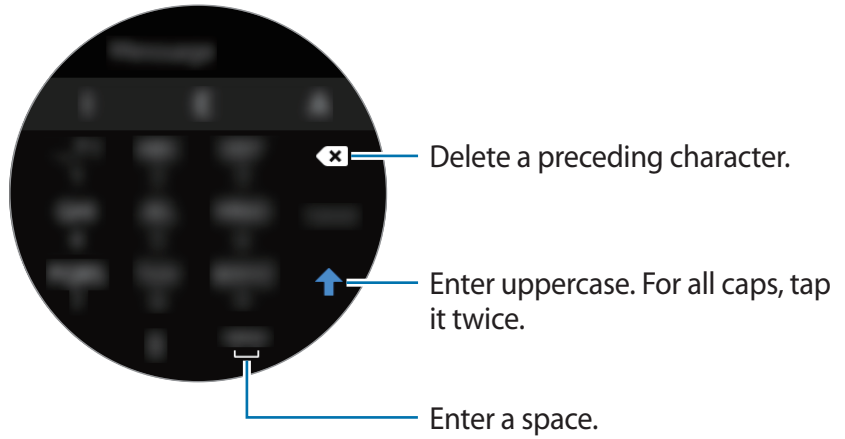

Apps and features

Messages

View messages and reply to using the Galaxy Watch Active.

Viewing messages



You may incur additional charges for receiving messages while you are roaming.

1 Tap  (**Messages**) on the Apps screen.

Or, swipe the screen to the right on the Watch screen to open the notification panel and view a new message.

2 Scroll through the message list, and then select a contact to view your conversations.

To view a message on your mobile device, tap , swipe upwards or downwards on the screen, and then tap **Show on phone**.

To reply a message, select an input mode and enter your message.

Sending messages



You may incur additional charges for sending messages while you are roaming.

- 1 Tap  (**Messages**) on the Apps screen.

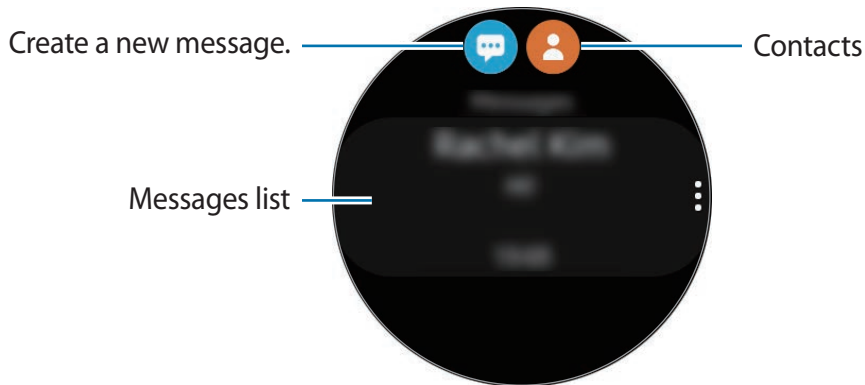

- 2 Tap .

Or, you can choose a message recipient by tapping  on the contacts list.

- 3 Add a recipient and tap **Next**.

- 4 Select an input mode, and enter your message, and then tap **Send**.



When you select a text template, tap .

When you select an emoticon, the message will automatically be sent to the recipients.

When you enter text by voice, you can select between text and audio for the message format. If the message format selection screen does not appear, on the Apps screen, tap

 (**Settings**) → **Apps** → **Messages**, and then tap the **Send as audio** switch to activate it.

Deleting messages

- 1 Tap  (Messages) on the Apps screen.
- 2 Scroll through the message list, and then select a contact to view your conversations.
- 3 Tap , swipe upwards or downwards on the screen, and then tap **Delete**.
The message will be deleted both from the Galaxy Watch Active and the connected mobile device.

Phone

Introduction

You can make or check incoming calls and answer them. However, you can have phone conversations only through the connected mobile device.

Receiving calls

Answering a call

When a call comes in, drag  outside the large circle.

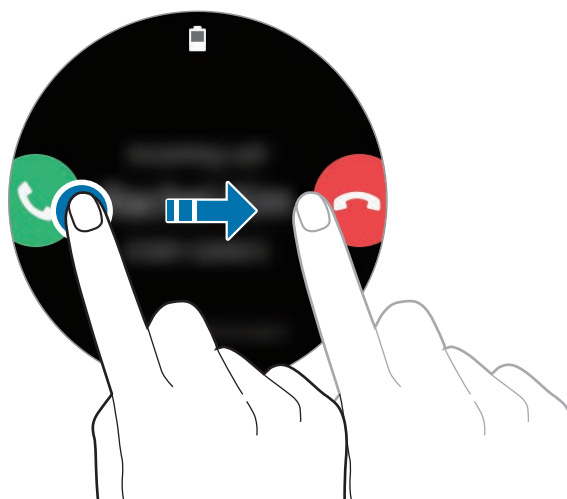

You can have phone conversation through the connected mobile device with your Galaxy Watch Active.

Rejecting a call

You can reject incoming calls and send a rejection message to the caller.

When a call comes in, drag  outside the large circle.

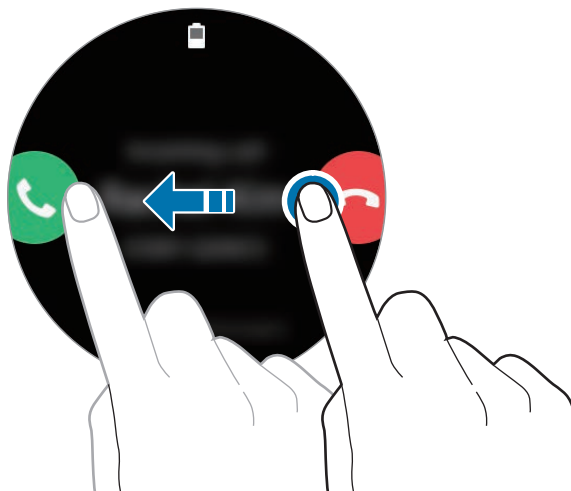

To send a message when rejecting an incoming call, swipe upwards from the bottom edge of the screen.

Missed calls



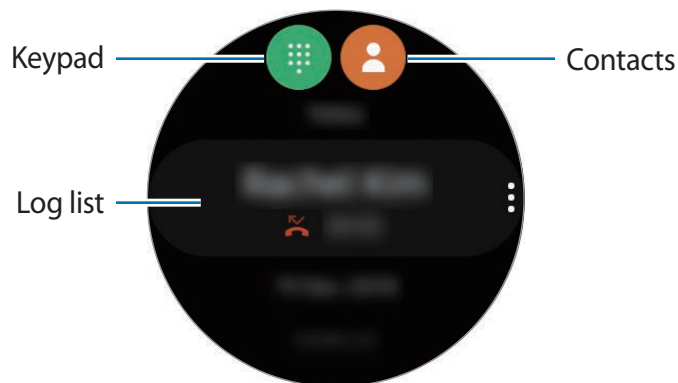

If a call is missed, a missed call notification is displayed on the notification panel. Swipe the screen to the right on the Watch screen to open the notification panel and view missed call notifications. Alternatively, tap  (Phone) on the Apps screen to view missed calls.

Making calls

Tap  (**Phone**) on the Apps screen.



Use one of the following methods:

- Tap , enter a number using the keypad, and then tap .
- Tap , scroll through the contact list, select a contact, and then tap .
- Scroll through the log list, select a log entry, and then tap .

Contacts

The contacts saved on your mobile device will be also saved to your Galaxy Watch Active after you connect them. You can make a call or send a message to a contact.

Tap  (**Contacts**) on the Apps screen.





The favourites list contacts on the mobile device will display on the top of the contacts list.



Use one of the following search methods:

- Tap  and enter the search criteria on the top of the contacts list.
- Scroll through the contacts list. When you swipe upwards or downwards on the screen quickly, the list scrolls by the alphabet of the first letter.

Once a contact is selected, take one of the following actions:

-  : Make a voice call.
-  : Compose a message.

Adding contacts

- 1 Tap  (**Contacts**) on the Apps screen.
- 2 Tap  on the top of the contacts list and enter the contact information.
- 3 Tap **SAVE**.

Selecting the frequently used contacts on the widget

Swipe the screen to the left on the Watch screen and add the frequently used contacts from the **Contacts** widget to contact them directly via a text message or phone call. Tap **Add**, select contact, and then tap **Done**.



- To use the **Contacts** widget, you must first add it. Refer to [Adding widgets](#) for more information.
- Up to four contacts can be added on the widget.

Adding medical information to my profile

Add medical information to my profile for the rescuer to quickly see it in an emergency situation.

On your mobile device, launch the **Contacts** app, select your profile, and then enter your medical information. To view your medical information on your Galaxy Watch Active, on the Apps screen tap  (**Contacts**) and select your profile, and then swipe upwards from the bottom edge of the screen.

In an emergency situation, press and hold the Galaxy Watch Active's Home key (Power key) and tap **Emergency medical info**.



- You may not use this feature depending on the mobile device that you connect to the Galaxy Watch Active.

Samsung Pay

Register frequently used cards to Samsung Pay, a mobile payment service, to make payments quickly and securely. Samsung Pay supports near field communication (NFC) to allow payment through standard credit card readers.

You can view more information, such as cards that support this feature at www.samsung.com/samsung-pay.



- This app's availability and supported features may vary depending on the region or service provider.
- The procedures for the initial setup and card registration may vary depending on the region or service provider.

Setting up Samsung Pay

- 1 On your mobile device, launch the **Galaxy Wearable** app.
- 2 Tap **OPEN SAMSUNG PAY** and follow the on-screen instruction to complete your card registration.

Making payments

- 1 To make a payment on your Galaxy Watch Active, press and hold the Back key.
- 2 Scroll through the cards list, select a card and tap **PAY**.

3 Place your Galaxy Watch Active close to the card reader.

When the card reader recognises the card information, the payment will be processed.



- Payments may not be processed depending on your network connection.
- The verification method for payments may vary depending on the card readers.

Samsung Health

Introduction

Samsung Health records and manages your 24-hour activity and sleep pattern to cultivate a healthy habit. When connecting your Galaxy Watch Active to your mobile devices, you can save and manage the health-related data on the Samsung Health app.

When the automatic exercise recognition feature is activated after you exercise for more than 10 minutes while wearing the Galaxy Watch Active, it will display an encouraging message. When the Galaxy Watch Active recognises inactivity for more than one hour, it will notify you and show you some stretching motions to follow. When your Galaxy Watch Active recognises you are driving, it may not display an encouraging message or stretches.

Tap  (**Samsung Health**) on the Apps screen.



- Samsung Health features are intended only for leisure, well-being, and fitness purposes. They are not intended for medical use. Before using these features, read the instructions carefully.
- Any information that is obtained from use of the Galaxy Watch Active or the Fit Software or any application preloaded within may not be suitable, accurate, complete or reliable.

Wearing the Galaxy Watch Active correctly

- When you activate the auto heart rate tracking feature, or when the Galaxy Watch Active recognises your exercise, the Galaxy Watch Active will automatically track your heart rate. When measuring your heart rate, wear the Galaxy Watch Active snugly on your arm above your wrist as shown in the figure below.
- If you fasten the Galaxy Watch Active too tightly, the skin irritation may occur and if you fasten it too loosely, friction may occur.

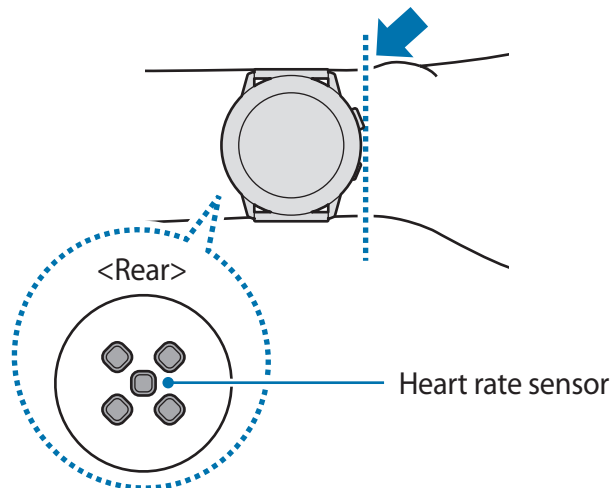

- The accuracy of the heart rate sensor may be diminished depending on measurement conditions and surroundings.
- Use the HR feature only for measuring your heart rate.
- Do not look directly at the heart rate sensor's lights. Doing so may impair your vision. Make sure children do not look directly at the lights.
- Cold ambient temperatures may affect your measurement; during winter or cold weather, keep yourself warm when checking your heart rate.



- Smoking or consuming alcohol before taking measurements may cause your heart rate to be different from your normal heart rate.
- Do not talk, yawn, or breathe deeply while taking heart rate measurements. Doing so may cause your heart rate to be recorded inaccurately.
- Because the heart rate sensor uses light to approximate heart rate, its accuracy may vary due to physical factors that affect light absorption and reflection, such as blood circulation/blood pressure, skin condition and location and concentration of blood vessels. In addition, if your heart rate is extremely high or low, measurements may be inaccurate.
- Users with thin wrists may receive inaccurate heart rate measurements when the device is loose, causing the light to be reflected unevenly. If heart rate measurement is not working properly, adjust the position of the device's heart rate sensor to the right, left, up, or down on your wrist, or wear the device on your inner arm so that the sensor is in contact with your skin.

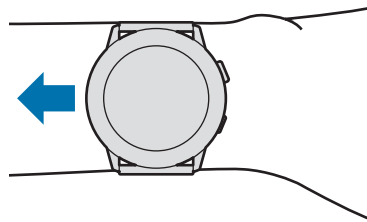

- If the heart rate sensor is dirty, wipe the sensor and try again. Obstructions between the device's band and your wrist, such as body hair, dirt, or other objects may prevent the light from reflecting evenly. Please make sure you remove such obstructions before use.
- If your device becomes hot to the touch, please remove it until it cools. Exposing skin to a hot surface of the device for a long time may cause skin burn.

Daily activity

Check your daily activity goal based on your target, such as the calories burned, exercise time, or activity time at a glance.

Checking the daily activity

Tap  (Samsung Health) on the Apps screen, swipe upwards or downwards on the screen, and then open the daily activity tracker screen. Alternatively, swipe the screen to the left on the Watch screen and select the **Daily activity** widget to launch it.

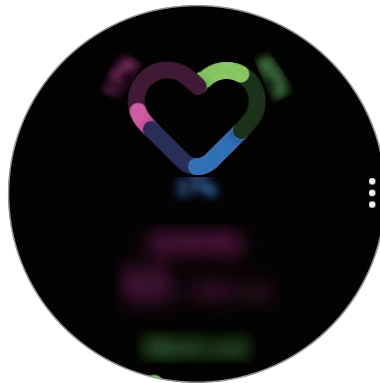

- **Activity:** Check your daily calories burned through activities you did throughout your day. As you approach your calorie goal, the graph will increase.
- **Workout:** Check your total workout times for activities you did throughout your day. Times for various exercises will be recognised automatically and the times for manually started exercises will be included. As you approach your workout goal, the graph will increase.
- **Move hourly:** Check how long you were active by hour throughout the day. As you approach your time goal by doing light activities, such as stretching and walking, the graph will increase.

To view weekly records with a graph, swipe upwards or downwards on the screen.

Setting the daily activity target

- 1 Swipe upwards or downwards on the daily activity tracker screen and tap **Settings**.
- 2 Tap **Set targets** and select an activity option.
- 3 Tap the target input field and swipe upwards or downwards on the screen to set the target.
- 4 Tap **DONE**.

Setting up notifications

To receive a notification when reaching a target you set, swipe upwards or downwards on the screen, tap **Settings**, and then tap the **Notifications** switch to activate it.

Steps

The Galaxy Watch Active counts the number of steps you have taken and measures the distance travelled.

Measuring your step count and distance you walk

Tap  (**Samsung Health**) on the Apps screen, swipe upwards or downwards on the screen, and then open the steps tracker screen.

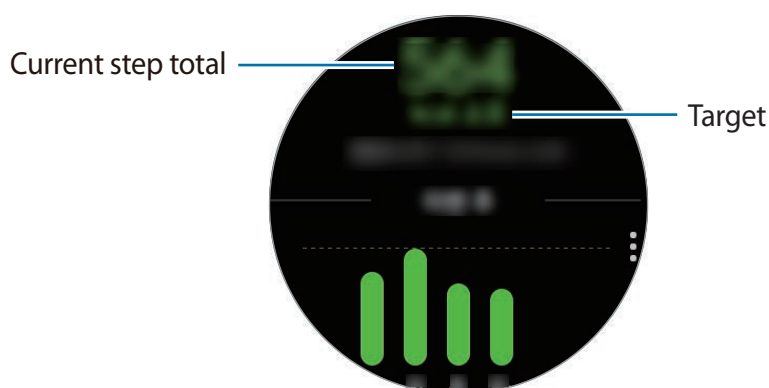

To view weekly records with a graph, swipe upwards or downwards on the screen.



- When you start to measure your step, the step tracker monitors your steps and displays your step account after a brief delay because your Galaxy Watch Active accurately recognises your movement after you walk for a while. Also, for an accurate step count, you may experience a brief delay before the pop-up window indicates that a certain goal has been reached.
- If you use the steps tracker while travelling by car or train, vibration may affect your step count.

Setting the step target

- 1 Swipe upwards or downwards on the step tracker screen and tap **Settings**.
- 2 Tap **Step target**.
- 3 Tap the target input field and swipe upwards or downwards on the screen to set the target.
- 4 Tap **DONE**.

Setting up notifications

To receive a notification when reaching a target you set, swipe upwards or downwards on the screen, tap **Settings**, and then tap the **Notifications** switch to activate it.

Floors

Record and track how many floors you climb.

Measuring the floors you climb

Tap  (Samsung Health) on the Apps screen, swipe upwards or downwards on the screen, and then open the floors tracker screen.

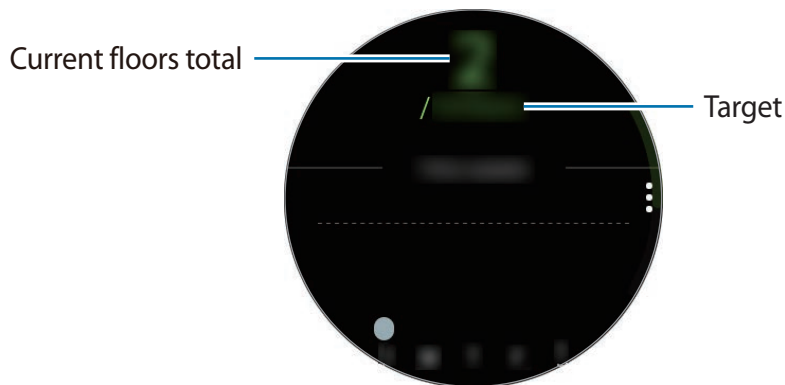

To view weekly records with a graph, swipe upwards or downwards on the screen.



- One floor is calculated as approximately 3 metres. The floors measured may not match the actual floors you climb.
- The floors measured may not be accurate depending on the environment, the user's movements, and the conditions of buildings.
- The floors measured may not be accurate if water (shower and water activity) or foreign materials enter the atmospheric pressure sensor. If there is any detergent, sweat, or raindrops on the Galaxy Watch Active, rinse it with clean water and dry the atmospheric pressure sensor thoroughly before use.

Setting the target for climbing floors

- 1 Swipe upwards or downwards on the floors tracker screen and tap **Settings**.
- 2 Tap **Floor target**.

3 Tap the target input field and swipe upwards or downwards on the screen to set the target.

4 Tap **DONE**.

Setting up notifications

To receive a notification when reaching a target you set, swipe upwards or downwards on the screen, tap **Settings**, and then tap the **Notifications** switch to activate it.

Calories

You can check your calories burned by day or week.

Tap  (**Samsung Health**) on the Apps screen, swipe upwards or downwards on the screen, and then open the calories screen.

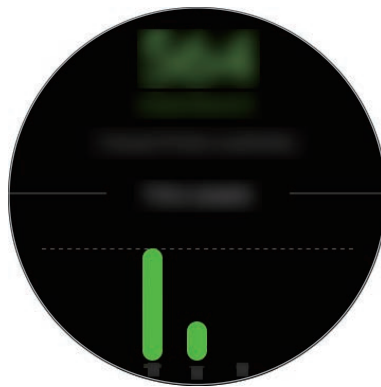

- The total calories you burn includes your basal metabolism calculated based on the profile you registered. When you launch the **Samsung Health** app for the first time, the basal metabolism you expend until the time you launch the app will be displayed as the calories you burn.
- The calories burned during the activity are the result of the exercise or other activities you do.

Exercise

Record your exercise information and check the results, such as burned calories, with the exercise feature.



- Before using this feature, pregnant women, the elderly, and young children, users suffering from conditions, such as chronic heart disease or high blood pressure, are recommended to seek the advice of a licensed medical professional.
- If you feel dizzy, experience pain, or have difficulty breathing during exercise, stop using this feature and seek the advice of a licensed medical professional.
- If you have just purchased or have reset the Galaxy Watch Active, create your profile.

Be aware of following conditions before exercising in cold weather conditions:

- Avoid using the device in cold weather. If possible, use the device indoors.
- If you use the device outside in cold weather, cover the Galaxy Watch Active with your sleeves before using it.

Starting the exercises

1 Tap  (Samsung Health) on the Apps screen.

2 Swipe upwards or downwards on the screen, open the exercise tracker screen, and then tap **Work out**.



Swipe the screen to the left on the Watch screen and start exercising directly from the **Multi-workouts** widget. Tap **Add** to add up to four different types of exercises.

3 Tap  on the exercise type you want from the exercise type list.

The screen where you can set the details of the exercise, such as the target, will appear.

When you want to start exercising, tap the exercise type.

When there is no exercise type you want, tap **More workouts** and select an exercise type you want.

4 Tap **Target**, select a target type, and then set the details of the target.



If you select **Basic workout** as the target, you can work out as much as you want without a limit on time or distance.

5 Tap **Workout screen** to customise the workout screen.



- Refer to [Customising the workout screen](#) for more information.
- The workout screen cannot be changed during work-out.

6 Set the various options for each exercise type.

- **Location:** Set the Galaxy Watch Active's GPS antenna to track your current location when you work out outside.
- **Auto pause:** Set the Galaxy Watch Active's exercise feature to pause automatically when you stop working out.
- **Guide frequency:** Set to receive the guide whenever you reach the distance or time you set.
- **Pool length:** Set the pool length.

7 Tap  to start exercising.



- Set whether to use your location information when you use your Galaxy Watch Active for the first time after purchasing or resetting it. Enabling the location information is set as the default.
- Your heart rate is measured in seconds when you start exercising. To measure your heart rate more accurately with the Galaxy Watch Active, wear the Galaxy Watch Active firmly around your lower arm just above your wrist.
- Do not move until your heart rate displays on the screen so it can be measured more accurately.
- Your heart rate may not be visible temporarily due to various conditions such as the environment, your physical state, or how the Galaxy Watch Active is worn.
- When you select **Swimming (pool)** or **Swimming (outdoor)**, water lock mode will be activated automatically.

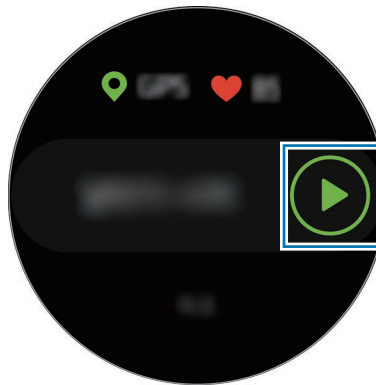

- 8 Swipe the screen to the left or right to view exercise information, such as your heart rate, distance, or time, on the workout screen.



When you are swimming, you can check additional exercise information.

To listen to music, swipe the screen to the right.



- When you select **Swimming (pool)** or **Swimming (outdoor)**, water lock mode will be automatically activated and the touchscreen will be disabled. The screen will change automatically and you can check your exercise information.
- When you select **Swimming (pool)** or **Swimming (outdoor)**, the recorded value may not be accurate in following cases:
 - If you stop swimming before reaching the completion point
 - If you change your swimming stroke midstream
 - If you stop moving your arms before reaching the completion point
 - If you kick with your legs on a kickboard or swim without moving your arms
 - If you do not pause or restart the exercise by pressing the Back key, but finish the exercise by pressing the Back key and tapping **Finish**

9 Press the Back key to pause the exercise.

To restart the exercise, tap the Back key again after pausing the exercise.

To finish exercising, tap **Finish** → ✓ after pausing the exercise.

To finish swimming, tap and hold the Home key to deactivate water lock mode first, shake your Galaxy Watch Active to remove water completely from it in order to ensure that the atmospheric pressure sensor will work properly, and then tap **OK** → **Finish** → ✓.



Music will continue to play even if you finish exercising. To stop playing music, stop music before finishing exercising or launch  (**Music**) to stop playing music.

10 Swipe upwards or downwards on the screen after finishing the exercise and view your exercise information.

Doing multiple exercises

You can log various exercises and go straight through an entire routine by starting another exercise right after finishing the current exercise.

1 Press the Back key to pause the current exercise.

2 Tap **Finish** → **New workout** >.

3 Select the exercise type and start the next exercise.

Starting repetitive exercises

You can perform repetitive exercises such as the squat or dead lift. Your Galaxy Watch Active will count how many times you repeat the motion with vibrations and beeps. However, you can only listen to the beep sound through the connected Bluetooth headset.

1 Tap  (**Samsung Health**) on the Apps screen.

2 Swipe upwards or downwards on the screen, open the exercise tracker screen, and then tap **Work out**.

3 Tap  on the repetitive exercise type you want from the exercise type list. The screen where you can set the details of the exercise, such as the target, will appear. When you want to start exercising, tap the exercise type. When there is no repetitive exercise type you want, tap **More workouts** and select an exercise type you want.

4 Tap **Target**, select a target type, and then set the details of the target.

 If you select **Basic workout** as the target, you can work out as much as you want without a limit on time or repetitions.

5 Tap **Workout screen** to customise the workout screen.

6 Set the various options for each exercise type.

- **Rep counter:** Count the number of repetitions with beeps. However, you can only listen to the beep sound through the connected Bluetooth headset.
- **Wrist worn on:** Select the wrist that you wear your Galaxy Watch Active to improve the counting accuracy.

7 Tap  to start exercising.

Tap **OK** after you get into the proper position to start it by following the pose on the screen.

 For some repetitive exercises, the exercise will begin right after you get into the proper position by imitating the pose on the screen.

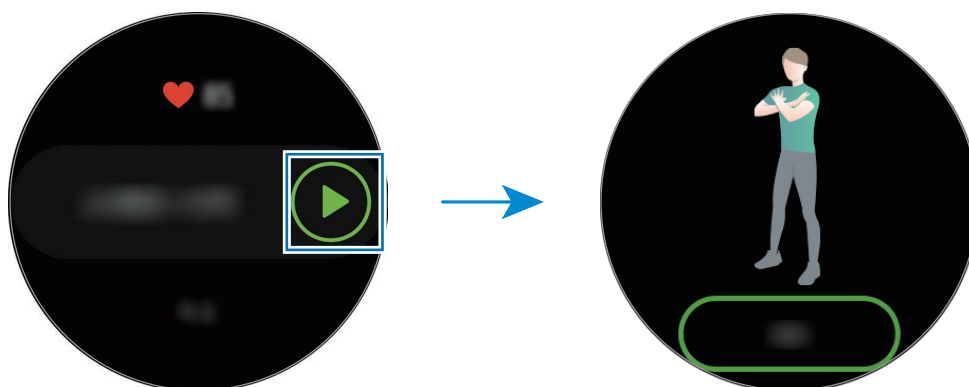



- 8 Counting will begin with vibrations and beeps.
Take a rest after completing a set. Or, tap **Skip** if you want to skip to the next set. The exercise will begin after you get into the proper position to start it by following the pose on the screen.
- 9 Press the Back key to pause the exercise.
To finish exercising, tap **Finish** → ✓ after pausing the exercise.
- 10 Swipe upwards or downwards on the screen after finishing the exercise and view your exercise information.

Customising the workout screen

Customise the workout screen that appears while exercising with the information that you want to preview.



The workout screen cannot be changed while working out.

- 1 Tap  (**Samsung Health**) on the Apps screen.
- 2 Swipe upwards or downwards on the screen, open the exercise tracker screen, and then tap **Work out**.
- 3 Tap  on the exercise type you want from the exercise type list.
The screen where you can set the details of the exercise, such as the target, will appear.
- 4 Tap **Workout screen**, select the type of workout screen, set whether to use it, and then select the information to display on the screen.

Automatic exercise recognition

Once you have engaged in an activity for more than ten minutes while wearing the Galaxy Watch Active, it automatically recognises that you are exercising and records exercise information such as the exercise type, duration and calories burned.

When you stop doing some exercises for more than one minute, the Galaxy Watch Active automatically recognises that you have stopped exercising and this feature is deactivated.



- You can check the list of exercises which are supported by the automatic exercise recognition feature. On the Apps screen, tap  (Samsung Health) and tap **Settings** → **Workout detection** → **Activities to detect**.
- The automatic exercise recognition feature measures the distance travelled and calories burnt using the acceleration sensor. The measurements may not be accurate depending on your manner of walking, exercise routines, and lifestyle.

Sleep

Analyse your sleep pattern and record it by measuring your heart rate while you are sleeping.



- The sleep pattern will have its four states (Awake, REM, Light, Deep) analysed by using your movement and changes in your heart rate. A graph will be provided with recommended ranges for each measured sleep state.
- If your heart rate is irregular, your Galaxy Watch Active cannot recognise your heart rate properly, or when you turn off the record REM sleep feature, the sleep pattern will be analysed into three states (Restless, Light, Motionless).
- Sleep patterns are analysed and recorded with your heart rate. To measure your sleep patterns with your body movements, swipe upwards or downwards on the sleep tracker screen, tap **Settings**, and then tap the **Record REM sleep** switch to deactivate it.
- To measure your heart rate more accurately with the Galaxy Watch Active, wear the Galaxy Watch Active firmly around your lower arm just above the wrist. Refer to [Wearing the Galaxy Watch Active correctly](#) for more information.

Measuring your sleep pattern

- 1 Sleep while wearing the Galaxy Watch Active.
The Galaxy Watch Active will start to measure your sleep pattern.
- 2 Tap  (Samsung Health) on the Apps screen after you wake up.
- 3 Swipe upwards or downwards on the screen and open the sleep tracker screen.
- 4 View your sleep pattern and information.

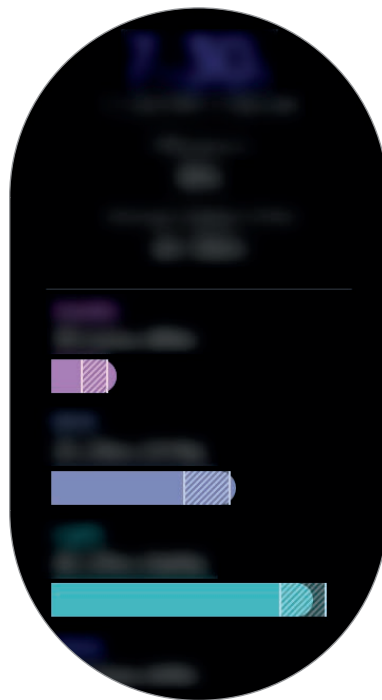

Heart rate

Measure and record your heart rate.





- The Galaxy Watch Active's heart rate tracker is intended for fitness and informational purposes only and is not intended for use in the diagnosis of disease or other conditions, or in the cure, mitigation, treatment, or prevention of disease.
- To measure your heart rate more accurately with the Galaxy Watch Active, wear the Galaxy Watch Active firmly around your lower arm just above the wrist. Refer to [Wearing the Galaxy Watch Active correctly](#) for more information.

Be aware of following conditions before measuring your heart rate:

- Rest for 5 minutes before taking measurements.
- If the measurement is very different from the expected heart rate, rest for 30 minutes and then measure it again.
- During winter or in cold weather, keep yourself warm when measuring your heart rate.
- Smoking or consuming alcohol before taking measurements may cause your heart rate to be different from your normal heart rate.
- Do not talk, yawn, or breathe deeply while taking heart rate measurements. Doing so may cause your heart rate to be recorded inaccurately.
- Heart rate measurements may vary depending on the measurement method and the environment they are taken in.
- If the heart rate sensor is not working, check the Galaxy Watch Active's position on your wrist and make sure nothing is obstructing the sensor. If the heart rate sensor continues to have the same problem, visit a Samsung Service Centre.

Measuring your heart rate

- 1 Tap  (Samsung Health) on the Apps screen.
 - 2 Swipe upwards or downwards on the screen and open the heart rate tracker screen.
Check your heart rate on the screen. You can also check the time information for each activity section.
-  Swipe the screen to the left on the Watch screen and check the measured heart rate directly from the **Heart rate** widget.

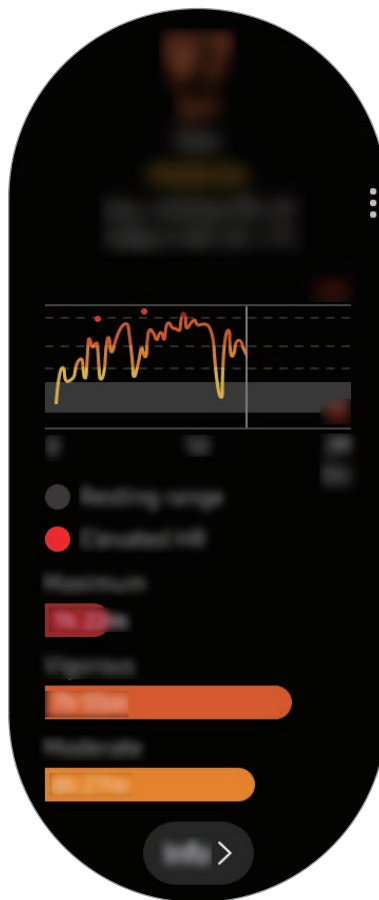

To view weekly records with a graph, swipe upwards or downwards on the screen.

Measuring your heart rate manually

You can measure your heart rate manually when you want.

- 1 Swipe upwards or downwards on the heart rate tracker screen, tap **Auto HR settings**, and then select **Never**.
- 2 Tap **Measure** on the heart rate tracker screen to start measuring your heart rate.
After a moment, your current heart rate will be displayed on the screen.



Your heart rate will be measured regardless of the Auto HR settings while working out.



Stress

Calculate and record your stress level by using changes in your heart rate and reduce your stress by following the breathing instructions that Galaxy Watch Active provides.



- You can get more accurate stress level results when your stress level data accumulates by measuring your stress levels automatically.
- Your measured stress level is not necessarily related to your emotional state.
- Your stress level may not be measured while you are sleeping, working out, moving a lot, or immediately after you finish a workout.
- To measure your heart rate more accurately with the Galaxy Watch Active, wear the Galaxy Watch Active firmly around your lower arm just above the wrist. Refer to [Wearing the Galaxy Watch Active correctly](#) for more information.
- This feature may not be available depending on the region.

Measuring your stress level

- 1 Tap  (Samsung Health) on the Apps screen.
 - 2 Swipe upwards or downwards on the screen and open the stress tracker screen.
Check your current stress level on the screen.
-  Swipe the screen to the left on the Watch screen and check the measured stress level directly from the **Stress** widget.

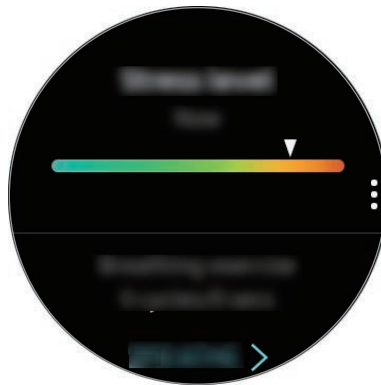

To view weekly records with a graph, swipe upwards or downwards on the screen.

Alleviating the stress

You can reduce stress with a deep and slow breathing by following the Galaxy Watch Active.

- 1 Tap **BREATHE** > on the stress tracker screen. Alternatively, swipe the screen to the left on the Watch and tap **BREATHE** > in the **Stress** widget.
- 2 Tap **Start** and start to breathe.
To stop to breathe, tap .

Measuring your stress level manually

You can measure your stress level manually when you want.

- 1 Swipe upwards or downwards on the stress tracker screen, tap **Auto stress settings**, and then tap the **Always** switch to deactivate the auto stress measurement feature.
- 2 Tap **Measure** on the stress tracker screen to start measuring your stress level.
After a moment, your current stress level will be displayed on the screen.

Food

Record the calories you eat in a day and compare with your target or the daily recommended calories to get help to manage your weight.



If you have just purchased or have reset the Galaxy Watch Active, create your profile. The Galaxy Watch Active will let you know your daily recommended calories based on the age, gender, and the physical conditions you entered in your profile.

Recording the calories

- 1 Tap  (**Samsung Health**) on the Apps screen.
- 2 Swipe upwards or downwards on the screen, open the food tracker screen, and then tap **Add**.

- 3 Tap the input field, swipe upwards or downwards on the screen to set the calories you have consumed, and then tap **DONE**.



To change the meal type, tap the meal type on the top of the screen and select an option.

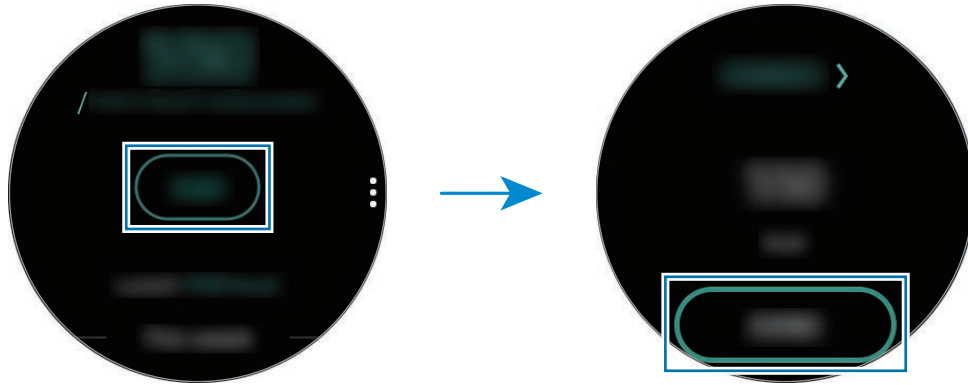

To view weekly records with a graph, swipe upwards or downwards on the screen.

Deleting logs

- 1 Tap **⋮** on the food tracker screen, swipe upwards or downwards on the screen, and then tap **Delete today's log**.
- 2 Select data to delete and tap **DELETE**.

Setting your target calories

- 1 Swipe upwards or downwards on the food tracker screen and tap **Set target**.
- 2 Tap the input field, swipe upwards or downwards on the screen to set the daily target calories, and then tap **DONE**.

Weight management

Check the calories you intake and the calories burned through exercise or other activities you do throughout your day and helps you to reach the goal weight you set. You can also check the weight you entered in the Samsung Health app on your connected mobile device.



- Set your goal weight in the Samsung Health app on your mobile device to check information on your Galaxy Watch Active.
- This feature is not available when you use the Galaxy Watch Active without connecting to a mobile device.

- 1 Tap  (Samsung Health) on the Apps screen.
- 2 Swipe upwards or downwards on the screen and open the weight management tracker screen.
- 3 View the information on the screen and adjust your exercise program and food intake accordingly.

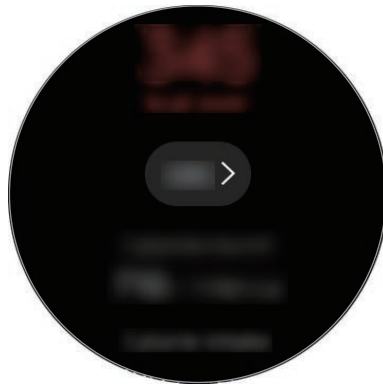



To view weekly records with a graph, swipe upwards or downwards on the screen.

Water

Record and track how many glasses of water you drink.

Recording water consumption

- 1 Tap  (Samsung Health) on the Apps screen.
- 2 Swipe upwards or downwards on the screen and open the water tracker screen.
- 3 Tap  when you drink a glass of water.
If you accidentally added an incorrect value, you can fix it by tapping .

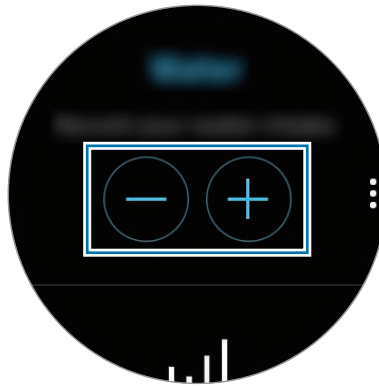

To view weekly records with a graph, swipe upwards or downwards on the screen.



Setting your target consumption

- 1 Swipe upwards or downwards on the water tracker screen and tap **Set target**.
- 2 Tap the **Daily target** switch to activate it.
- 3 Tap **Daily target**.
- 4 Tap the input field, swipe upwards or downwards on the screen to set the daily target, and then tap **DONE**.

Caffeine

Record and track how many cups of coffee you drink.

Recording your coffee consumption

- 1 Tap  (Samsung Health) on the Apps screen.
- 2 Swipe upwards or downwards on the screen and open the caffeine tracker screen.
- 3 Tap  when you drink a cup of coffee.
If you accidentally added an incorrect value, you can fix it by tapping .



To view weekly records with a graph, swipe upwards or downwards on the screen.

Setting your caffeine consumption limit

- 1 Swipe upwards or downwards on the caffeine tracker screen and tap **Set target**.
- 2 Tap the **Daily target** switch to activate it.
- 3 Tap **Daily target**.
- 4 Tap the input field, swipe upwards or downwards on the screen to set the daily target, and then tap **DONE**.

Together

Compare your step count records with other Samsung Health users. You can set a goal, compete with your friends, and view the challenge status on your Galaxy Watch Active.



- Activate the together feature in the Samsung Health app on your mobile device to check information on your Galaxy Watch Active.
- This feature is not available when you use the Galaxy Watch Active without connecting to a mobile device.

1 Tap  (Samsung Health) on the Apps screen.

2 Swipe upwards or downwards on the screen and open the together screen.

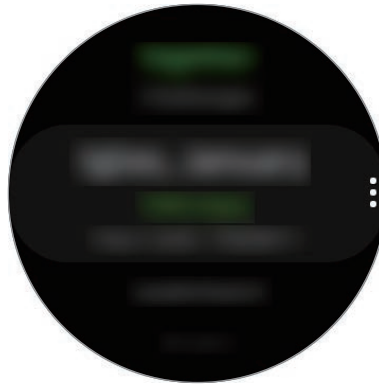

Tap the screen to view detailed information such as your or your friends' challenges status or your or your friends' weekly step count ranking.

Settings

You can set the various setting options related to the exercise.

Tap  (**Samsung Health**) on the Apps screen, swipe upwards or downwards on the screen, and then tap **Settings**.

- **Profile:** Enter your profile information, such as your gender, height, and weight.
- **Units:** Set the unit to use in the **Samsung Health** app of your Galaxy Watch Active.
- **Workout detection:** Set your Galaxy Watch Active to recognise your workout automatically.
- **Inactive time alerts:** Alerts you of your inactive time when you are not moving for a period of time while wearing your Galaxy Watch Active.
- **Data permissions:** Set the apps' permissions for accessing the data saved on the **Samsung Health** app of the Galaxy Watch Active.
- **Help:** View information about the **Samsung Health** app.

Additional information

- The purpose for such data collection is limited to providing the service that you have requested, including providing additional information to enhance your wellness, back up/sync data, data analysis and statistics or to develop and provide better services. (But if you sign in to your Samsung account from Samsung Health, your data may be saved on the server for data backup purposes.) Personal information may be stored until the completion of such purposes. To delete any data you have shared with social networks or transferred to storage devices, you must delete them separately.
- You assume full responsibility for the inappropriate use of data shared on social networks or transmitted to others. Use caution when sharing your personal data with others.
- If the Galaxy Watch Active is connected to a mobile device, verify the communication protocol to confirm proper operation. If you use a wireless connection, such as Bluetooth, the Galaxy Watch Active may be affected by electronic interference from other devices. Avoid using the Galaxy Watch Active near other devices that transmit radio waves.

- The content used in the Samsung Health app may vary depending on the software version of the app. The services provided with the app are subject to change or the cancellation of support without prior notice.
- Available Samsung Health functions and services may vary depending on the local laws and regulations in your region.
- Some functions of Samsung Health may not be provided depending on your region.
- Samsung Health functions are intended for fitness and informational purposes only and is not intended for use in the diagnosis of disease or other conditions, or in the cure, mitigation, treatment, or prevention of disease.



- Measured distance may differ from the actual distance due to uneven strides, walking in place, and pacing around.
- Only records from the past 28 days are saved. You can view previous data on the mobile device where the Samsung Health app is installed.

GPS

The Galaxy Watch Active has a GPS antenna so that you can check your real-time location information without connecting to a mobile device. When you are using your Galaxy Watch Active without connecting to a mobile device, the GPS antenna in your Galaxy Watch Active will be used.

On the Apps screen, tap  (**Settings**) → **Connections** → **Location** and tap the switch to activate it.

To select a method to use for locating, swipe upwards or downwards on the screen and select an option.

When your Galaxy Watch Active and mobile device are connected, this feature uses your mobile device's GPS. Activate the mobile device's location feature to use the GPS sensor.



- GPS signal strength may decrease in locations where the signal is obstructed, such as between buildings or in low-lying areas, or in poor weather conditions.

Music

Introduction

Listen to music saved in the Galaxy Watch Active and in the mobile device.

Playing music

Tap  (**Music**) on the Apps screen.

When listening to music saved in the Galaxy Watch Active, swipe upwards from the bottom edge of the screen to open the library screen. On the library screen, you can view the currently playing song and playlist, and arrange music by tracks, albums, and artists.

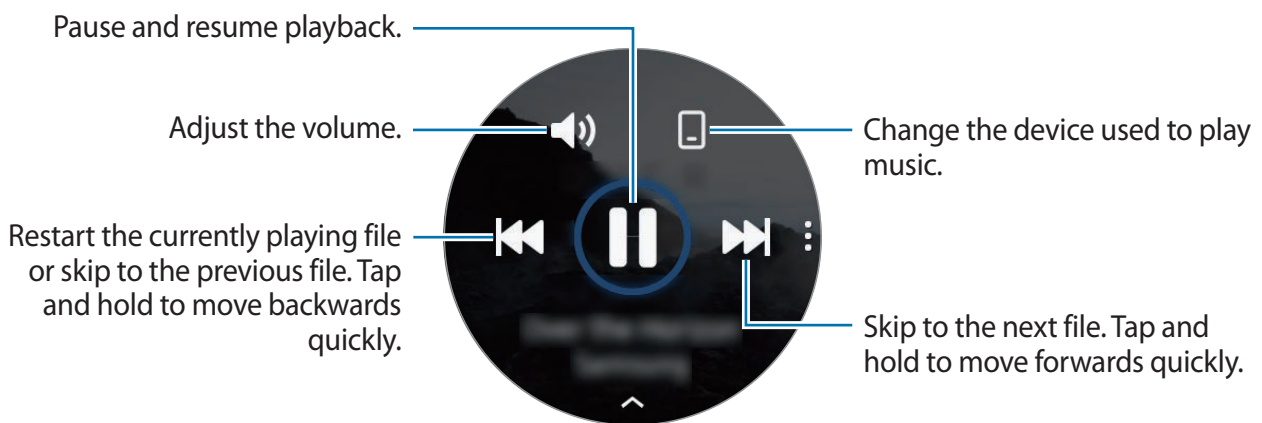

Importing music





Import music saved in your mobile device to your Galaxy Watch Active.

- 1 Launch the **Galaxy Wearable** app on your mobile device.
- 2 Tap **Home** → **Add content to your watch**.
- 3 Tap **Add tracks**.
- 4 Select files and tap **DONE**.

To sync music in your mobile device with your Galaxy Watch Active, tap the **Auto sync** switch under **Music**. The music in your mobile device will be synced automatically with your Galaxy Watch Active when it has more than 15 % of remaining battery power.

Playing music with your Galaxy Watch Active

Play music saved on your Galaxy Watch Active through a connected Bluetooth headset.

- 1 Tap  (**Music**).
- 2 Tap  to play the music saved in your Galaxy Watch Active.
The  icon appears.
- 3 Tap .





Playing music with your mobile device

Play music saved on your mobile device and control it with your Galaxy Watch Active.

Mobile device

- 1 Launch the music player app.

Galaxy Watch Active

- 2 Tap  (**Music**).
- 3 Tap  to play the music saved in your mobile device.
The  icon appears.
- 4 Tap .

To change the music player app used from your Galaxy Watch Active, tap  → **Music player** and select the app among the music player app installed on the mobile device.

Playing music without connecting to a mobile device

Listen to music or radio using the Galaxy Watch Active by itself. You must download music or a radio streaming app on the Galaxy Watch Active.

On the Apps screen, tap  (**Galaxy Store**). Browse and download music or a radio streaming app in **Galaxy Store** and launch the app.

Reminder

Add reminders for events such as buying tickets, going to the laundromat, or taking medicine, without using your calendar app. You can set up notifications to receive reminders at specified times.

Creating a reminder

- 1 On the Apps screen, tap  (**Reminder**) → **Add**.
If you have a saved reminder, tap **Create** on the top of the reminders list.
- 2 If your Galaxy Watch Active supports voice input, speak a schedule to create a reminder. When you are finished, tap **Done**.
Or, tap **Write memo** >, enter text, and then tap **Done**.
- 3 Tap **Set time** > to set a notification.
- 4 Tap the input field, swipe upwards or downwards on the screen to set the time, and tap **Next**.
- 5 Set other notification options, such as selecting the date on which the notification will repeat, and tap **Done**.
- 6 Tap **Save**.
The saved reminder is added to the reminders list.

Viewing the reminder alarm

When an alarm appears, check the reminder details. Or, swipe the screen to the right on the Watch screen to open the notification panel and view a reminder.



- All reminders on your Galaxy Watch Active will be synced with the connected mobile device automatically so that you can receive alarms and check them from the mobile device.
- Select a reminder and tap **Edit time** > to set a reminder again.

Completing or deleting the reminder

When you have finished your task, you can set the reminder as completed or delete it.

To complete the reminder, tap **Complete** after viewing the reminder's details.

To delete the reminder, tap , swipe upwards or downwards on the screen, and then tap **Delete**.

Calendar

You can check the schedules of events that you saved on your mobile device or Galaxy Watch Active on your Galaxy Watch Active.



All events scheduled on your Galaxy Watch Active will be synced with the connected mobile device automatically to check them, and receive alarms from the mobile device.

- 1 Tap  (**Calendar**) on the Apps screen. Alternatively, swipe the screen to the left on the Watch screen and select the **Calendar** widget to launch it.
- 2 Tap anywhere on the monthly calendar.
The current day's events list will be shown.
- 3 Tap **Add** to add the schedule.
If you have a saved schedule, tap **Create** on the top of the list.
- 4 Select an input mode you want, enter the schedule, and then tap **Save**.

Bixby

Introduction

Bixby is a voice service that helps you use the Galaxy Watch Active more conveniently. You can talk to Bixby to launch a function or provide you with information.



- This app may not be available depending on the region.
- Make sure the Galaxy Watch Active's microphone is not obstructed when you are speaking into it.
- To use Bixby, connect a Wi-Fi network or mobile network to your mobile device or connect a Wi-Fi network to your Galaxy Watch Active.



Launching Bixby

Launching with the Home key

When you quickly press the Home key twice, Bixby will launch.

Launching by voice

You can launch **Bixby** using your voice. You can only use this feature when your Galaxy Watch Active's screen is turned on.

- 1 Tap  (**Bixby**) on the Apps screen.
- 2 Tap , swipe upwards or downwards on the screen, and then tap **Voice wake-up**.
- 3 Tap the switch to activate it.

Using Bixby

- 1 Quickly press the Home key twice. Alternatively, say “Hi Bixby”. Alternatively, tap  (Bixby) on the Apps screen.

The Galaxy Watch Active begins voice recognition.

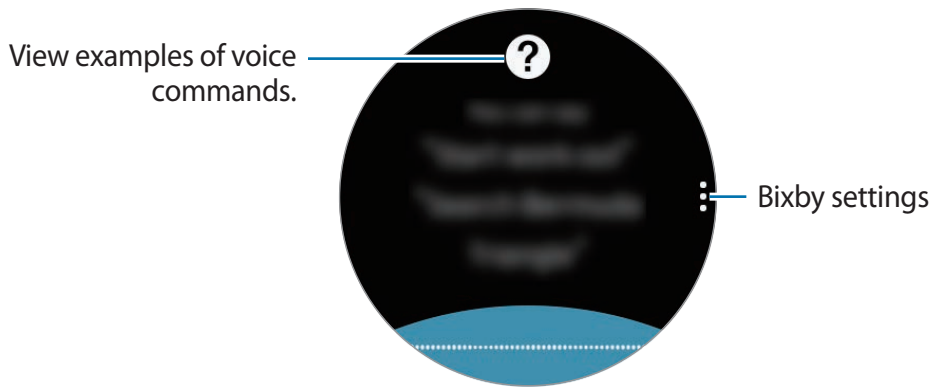

- 2 Say a voice command.

If the Galaxy Watch Active recognises the command, the Galaxy Watch Active will perform the corresponding action.



To repeat a voice command or say a different command, tap .

Tips for better voice recognition

- Speak clearly.
- Speak in quiet places.
- Do not use offensive or slang words.
- Avoid speaking in dialectal accents.

The Galaxy Watch Active may not recognise your commands or may perform unwanted commands depending on your surroundings or how you speak.

Setting the language

- 1 Tap  (**Bixby**) on the Apps screen.
- 2 Tap , and swipe upwards or downwards on the screen, and then tap **Language**.
- 3 Select a language you want.



- Bixby voice commands are not supported in some languages.
- The selected language is applied to **Bixby** only, not to the language displayed on the Galaxy Watch Active.

Weather

View weather information on the Galaxy Watch Active for locations set on the connected mobile device.

Tap  (**Weather**) on the Apps screen. Alternatively, swipe the screen to the left on the Watch screen and select the **Weather** widget to launch it.

To view the current day's weather information, tap the screen and swipe upwards or downwards on the screen.

To add another city's weather information, swipe the screen to the left, tap **Add**, and then add the city from the connected mobile device.



- You cannot add a city when you use the Galaxy Watch Active without connecting to a mobile device.

Alarm

Set alarms and manage them.

Setting alarms

- 1 Tap  (**Alarm**) on the Apps screen.
- 2 Tap **Add**.
If you have a saved alarm, tap **Add** on the top of the alarms list.
- 3 Tap the input field, swipe upwards or downwards on the screen to set the alarm time, and tap **Next**.
- 4 Select the days for the alarm to repeat and tap **Save**.
The saved alarm is added to the alarms list.

To activate or deactivate alarms, tap the switch next to the alarm in the alarms list.

Stopping alarms

Drag  outside the large circle to stop an alarm.

If you want to use the snooze function, drag  outside the large circle.

Deleting alarms

In the alarms list, tap and hold an alarm, and then tap **Delete**.

World clock

Creating world clocks

- 1 Tap  (**World clock**) on the Apps screen.
- 2 Tap **Add**.
If you have a saved world clock, tap **Add** on the clocks list.
- 3 Swipe the screen to the left or right and select a time zone on the map.
You can also tap **All cities** > and search for a city or select a city from the list.
- 4 Tap the city name representing the selected time zone.

Deleting world clocks

On the world clocks list, tap and hold a world clock, and then tap **Delete**.

Gallery

Importing and exporting images

Importing images from your mobile device

- 1 Launch the **Galaxy Wearable** app on your mobile device.
- 2 Tap **Home** → **Add content to your watch**.
- 3 Tap **Copy images**.

4 Select files and tap **Done**.

To sync images on your mobile device with your Galaxy Watch Active, tap the **Auto sync** switch under **Images**, tap **Albums to sync**, select albums to import to your Galaxy Watch Active, and then tap **DONE**. The selected albums will be automatically synced with your Galaxy Watch Active when it has more than 15 % of remaining battery power.

Exporting images to your mobile device

1 Tap  (**Gallery**) on the Apps screen.

2 Tap an image and then tap and hold the image again to export it.

3 Swipe the screen to the left or right and select any images to export more.

To select all images, tap  → **Select all**.

4 Tap  → **Send to phone**.

You can view the exported images in apps like Gallery on your mobile device.

Viewing images

View and manage the images saved on your Galaxy Watch Active.

1 Tap  (**Gallery**) on the Apps screen.



2 Swipe the screen to the left or right to scroll through the image list and select an image.

Zooming in or out

While viewing an image, double-tap the image quickly, spread your two fingers apart, or pinch on an image to zoom in or out.

When an image is magnified, you can view the rest of the image by scrolling around the screen.

Deleting images



- 1 Tap  (**Gallery**) on the Apps screen.
- 2 Tap an image and then tap and hold the image again to delete it.
- 3 Swipe the screen to the left or right and select any images to delete more.
To select all images, tap  → **Select all**.
- 4 Tap **Delete** → .

Find My Phone

If you misplace the mobile device, the Galaxy Watch Active can help you find it.



This feature is not available when you use the Galaxy Watch Active without connecting to a mobile device.

- 1 Tap  (**Find My Phone**) on the Apps screen.
 - 2 Tap .
- The mobile device emits sounds and turns on the screen. Tap **Dismiss** and drag it on the mobile device, or tap  on the Galaxy Watch Active.

Viewing the location of your mobile device

Tap  → **Locate phone**.

The Galaxy Watch Active will display your mobile device's location.

Find My Watch

If you misplace your Galaxy Watch Active, the Galaxy Wearable app on your mobile device can help you find it.



This feature is not available when you use the Galaxy Watch Active without connecting to a mobile device.

1 Launch the **Galaxy Wearable** app on your mobile device and tap **Home** → **Find My Watch**.

2 Tap .

The Galaxy Watch Active will vibrate and the screen will turn on.

To stop vibrating, drag  outside the large circle on the Galaxy Watch Active, or tap  on the mobile device.

Controlling the Galaxy Watch Active remotely

If you cannot find your Galaxy Watch Active, launch the **Galaxy Wearable** app on your mobile device and tap **Home** → **Find My Watch** → **Get location** to check the current location of the Galaxy Watch Active.

When your Galaxy Watch Active is lost or stolen, you can control it remotely. Launch the **Galaxy Wearable** app on your mobile device, tap **Home** → **Find My Watch** → **Set security**, and then select a feature.



This feature is available after registering the Samsung account on both your Galaxy Watch Active and mobile device.

SOS messages

In an emergency situation, you can send an SOS message to the previously registered emergency contact by quickly pressing the Galaxy Watch Active's Home key three times.

Setting up SOS messages

- 1 Launch the **Galaxy Wearable** app on your mobile device and tap **Home** → **Send SOS requests**, and tap the switch to activate it.
- 2 Follow the on-screen instructions to add emergency contacts if you have not already done so.

Adding emergency contacts

- 1 Launch the **Galaxy Wearable** app on your mobile device and tap **Home** → **Send SOS requests** → **Send SOS messages to** → .
- 2 Tap **Create contact** and enter the contact information or tap **Select from Contacts** to add an existing contact as an emergency contact.

Setting the SOS message delay

Set the Galaxy Watch Active to send an SOS messages after a while to cancel the request when you quickly press the Galaxy Watch Active's Home key three times.

Launch the **Galaxy Wearable** app on your mobile device, tap **Home** → **Send SOS requests**, and then tap the **Count down before sending** switch to activate it.

Sending SOS messages

In an emergency situation, quickly press the Galaxy Watch Active's Home key three times.

When sending an SOS message, the  icon will display on the Watch screen and you can view the result of your SOS request on the notification panel.





If the GPS feature is not activated on your Galaxy Watch Active or mobile device when sending an SOS message, the GPS feature will be activated automatically to send the location information.

Email

View emails received on the mobile device and reply to them.

Reading emails

- 1 Tap  (**Email**) on the Apps screen.
- 2 Select an email to open the email screen.

To view an email on the mobile device, tap , swipe upwards or downwards on the screen, and then select **Show on phone**.



To reply an email, select an input mode and enter your email.



You may not be able to reply to emails depending on the mobile device that you connect to the Galaxy Watch Active.

Galaxy Store

Download specialised apps and watch faces on your Galaxy Watch Active, not through the connected mobile device.

On the Apps screen, tap  (**Galaxy Store**). Swipe upwards or downwards on the screen to scroll through the list and select an app to download or watch face or tap  to search for apps by keyword.

Tap , swipe upwards or downwards on the screen, and then select **Show on phone**. The **Galaxy Store** app will be launched on your mobile device. Then, browse and select an app or watch face to download.



Register your Samsung account on the connected mobile device first to use this app.

Settings

Introduction

Customise settings for functions and apps. Set your Galaxy Watch Active depending on your usage pattern by configuring the various settings.

Tap  (**Settings**) on the Apps screen.

Watch faces

Customise the watch face.

On the Settings screen, tap **Watch faces**.

- **Watch faces:** Select a watch type. You can also select items to display on the watch face and download more watch faces from **Galaxy Store**.
- **Watch always on:** Set the Galaxy Watch Active to display a watch when the screen is turned off.



The **Watch always on** feature only works while you are wearing the Galaxy Watch Active.

- **Watch face order:** Select how to arrange the watch faces.
 - **Most recent first:** Set the recently used watch face to appear first.
 - **Custom:** Arrange the watch face to your preference.
- **Notification indicator:** Set the Galaxy Watch Active to display an orange dot on the Watch screen to alert you to notifications that you have not checked.
- **Status indicator:** Set the status indicators to display on the Watch screen.

Vibration

Change the Galaxy Watch Active's vibration settings.

On the Settings screen, tap **Vibration**.

- **Vibration intensity:** Adjust the intensity of the vibration notification.
- **Long vibration:** Set the Galaxy Watch Active to vibrate longer for incoming calls and notifications.
- **Ringtone vibration:** Select a vibration pattern for incoming calls.



This option is not displayed when you use the Galaxy Watch Active without connecting to a mobile device.

- **Notification vibration:** Select a vibration pattern for notifications.

Display

Change the Galaxy Watch Active's display settings and the Apps screen.

On the Settings screen, tap **Display**.

- **Brightness:** Adjust the brightness for the display.
- **Auto low brightness:** Set the Galaxy Watch Active to automatically adjust the brightness depending on the ambient light conditions.
- **Screen timeout:** Set the length of time the Galaxy Watch Active waits before turning off the display's backlight.
- **Show last app:** Select the length of time to display a recently used app when the screen is back on after it turned off.
- **Background style:** Change the wallpaper.
- **Font:** Change the font style and size.

Advanced

Activate the Galaxy Watch Active's advanced features and change the control settings.

On the Settings screen, tap **Advanced**.

- **Double press Home key:** Select an app or feature to launch when you press the Galaxy Watch Active's Home key twice.
- **Wake-up gesture:** Set the Galaxy Watch Active to turn on the screen when you raise your wrist that is wearing the Galaxy Watch Active.

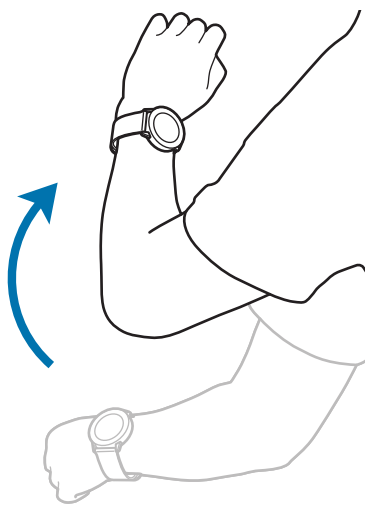

- **Touch wake-up:** Set the Galaxy Watch Active to turn on the screen when you tap the screen.
- **Water lock mode:** Activate water lock mode before entering the water. The touchscreen, the wake-up gesture feature, and the watch always on feature will be deactivated.
- **Touch sensitivity:** Set the Galaxy Watch Active to allow use of the touchscreen with gloves on.
- **Do not disturb:** Set the Galaxy Watch Active to mute all notifications except for alarms and the screen will not turn on when notifications are received.
- **Theatre mode:** Activate theatre mode for watching movies. All alarms and notifications are muted and the screen will not turn on when a notification is received or when there is an alarm. Also, the wake-up gesture feature and watch always on feature will be deactivated automatically.

- **Goodnight mode:** Activate goodnight mode for sleeping. All notifications except for alarms are muted and the screen will not turn on when notifications are received while sleeping. Also, the wake-up gesture feature and watch always on feature will be deactivated automatically.
- **Daily briefing:** Set the Galaxy Watch Active to send the daily information after you wake up and before you sleep, or twice when you want during the day.
- **Edit quick settings:** Edit the Galaxy Watch Active's quick panel.
- **Screen capture:** Swipe right on the screen while pressing the Home key to capture the screen.

Connections

Bluetooth

Connect to a mobile device via Bluetooth. You can also connect a Bluetooth headset to your Galaxy Watch Active and listen to music.



- Samsung is not responsible for the loss, interception, or misuse of data sent or received via Bluetooth.
- Always ensure that you share and receive data with devices that are trusted and properly secured. If there are obstacles between the devices, the operating distance may be reduced.
- Some devices, especially those that are not tested or approved by the Bluetooth SIG, may be incompatible with your device.
- Do not use the Bluetooth feature for illegal purposes (for example, pirating copies of files or illegally tapping communications for commercial purposes).
Samsung is not responsible for the repercussion of illegal use of the Bluetooth feature.

On the Settings screen, tap **Connections** → **Bluetooth**.

- **Bluetooth:** Turn the Bluetooth feature on or off.
- **BT headset:** Search for Bluetooth headsets and connect them to the Galaxy Watch Active.

Wi-Fi

Activate the Wi-Fi feature to connect to a Wi-Fi network.

This feature is available when the Galaxy Watch Active is not connected to the mobile device via Bluetooth.

1 On the Settings screen, tap **Connections** → **Wi-Fi**.

2 Tap **Wi-Fi** and select **Auto** or **Always on** to connect to a Wi-Fi network.

If you select **Auto**, the Wi-Fi network will be disconnected automatically when your Galaxy Watch Active is connected to your mobile device via Bluetooth. If you select **Always off**, you can use your Galaxy Watch Active after connecting it to your mobile device via Bluetooth instead of using a Wi-Fi network.



- When you select the **Always on** option, the battery will drain more quickly than normal.
- The **Auto** option is not displayed and you cannot connect to a Wi-Fi network automatically when you use the Galaxy Watch Active without connecting to a mobile device.

3 Tap **Wi-Fi networks** and select a network from the Wi-Fi networks list.

Networks that require a password appear with a lock icon.

4 Tap **Connect**.



- Once the Galaxy Watch Active connects to a Wi-Fi network, the Galaxy Watch Active will reconnect to that network each time it is available without requiring a password. To prevent the Galaxy Watch Active connecting to the network automatically, select it from the list of networks and tap **Forget**.
- If you cannot connect to a Wi-Fi network properly, restart your device's Wi-Fi feature or the wireless router.

NFC

You can use the NFC feature.

On the Settings screen, tap **Connections** → **NFC**.



The Galaxy Watch Active contains a built-in NFC antenna. Handle the Galaxy Watch Active carefully to avoid damaging the NFC antenna.

- **NFC:** Activate or deactivate the NFC feature.
- **Tap and pay:** Set the default app for using the NFC feature.



This feature may not be available depending on the region or service provider.

Using the NFC feature

Before using the NFC feature with your Galaxy Watch Active, you must register for the related service. To register or get more information about the service, contact your service provider.

- 1 On the Settings screen, tap **Connections** → **NFC** and tap the **NFC** switch to activate it.
- 2 Touch the NFC antenna area at the top of the Galaxy Watch Active's touchscreen to the NFC card reader.

To set the default app, open the Settings screen and tap **Connections** → **NFC** → **Tap and pay**, and then select an app.



The services list may not include all available apps.

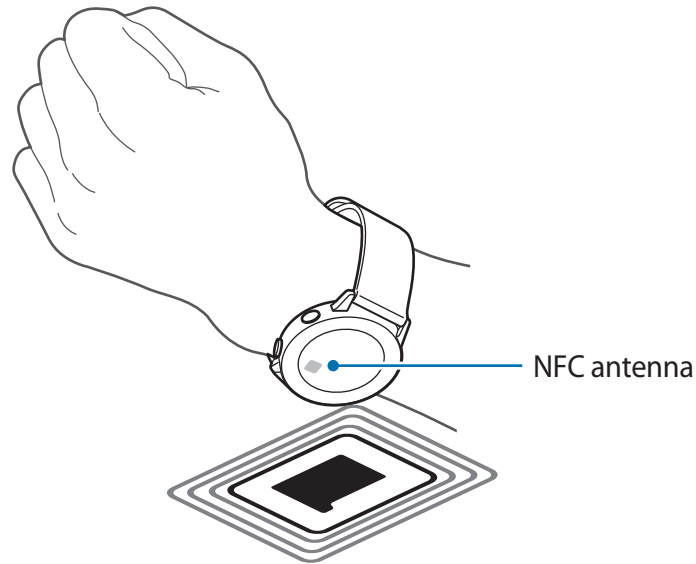

Alerts

Set the Galaxy Watch Active to vibrate when it is disconnected from your mobile device.

On the Settings screen, tap **Connections** and tap the **Alerts** switch to activate it.



The **Alerts** option is not displayed when you use the Galaxy Watch Active without connecting to a mobile device.

Flight mode

This disables all wireless functions on your device. You can use only non-network services.

On the Settings screen, tap **Connections** → **Flight mode** and tap the switch to activate it.



Follow the regulations provided by the airline and the instructions of aircraft personnel. In cases where it is allowed to use the device, always use it in flight mode.

Location

Set the Galaxy Watch Active to allow apps to use your current location information.

On the Settings screen, tap **Connections** → **Location**.

Tap the switch to activate it and select a method to collect your location data.

Apps

App order

Select how to arrange the apps on the Apps screen.

On the Settings screen, tap **Apps** → **App order**.

- **Most recent first:** Set the recently used apps to appear first.
- **Custom:** Arrange the apps to your preference.

Auto open apps

Set an app to launch automatically by bringing it into focus without tapping the app.

On the Settings screen, tap **Apps** → **Auto open apps** and tap the switch to activate it.

Permissions

For some apps to operate properly, they may need permission to access or use information on your Galaxy Watch Active. View your app permission settings for each app and change the settings.

On the Settings screen, tap **Apps** → **Permissions**.

Messages

Change the message feature settings.

On the Settings screen, tap **Apps** → **Messages**.

To send a voice message as an audio file, tap the **Send as audio** switch to activate it.

Security

Lock

Change the settings for securing the Galaxy Watch Active. When you use this feature, the Galaxy Watch Active may be locked automatically when it does not move for a period of time.

On the Settings screen, tap **Security** → **Lock**.

- **Type:** Select the Galaxy Watch Active lock method.
- **Use for:** Select when to use the lock feature.



This option is not displayed depending on your region or service provider.

- **Help:** View information about locking your Galaxy Watch Active.

Account

You can use various features of the Galaxy Watch Active after registering your Samsung account on your connected mobile device. Check the Samsung account registered on your connected mobile device and set the customisation service feature.

On the Settings screen, tap **Account**.

- **Samsung account:** Check the Samsung account registered on your connected mobile device. If you have not signed in yet, enter your Samsung account on your connected mobile device.
- **Customisation Service:** Set the Galaxy Watch Active to provide the proper feature depending on the location and situation after analysing your lifestyle pattern.



This feature is available after connecting the Galaxy Watch Active to a mobile device that supports the customisation service platform 2.2 or later. After making an agreement to use the customisation service, launch the **Settings** app on your mobile device, tap **Accounts and backup** → **Accounts** → **Samsung account** → **Privacy** → **Customisation Service**, and then tap the switch to activate it.

Accessibility

Configure various settings to improve accessibility to the Galaxy Watch Active.

On the Settings screen, tap **Accessibility**.

- **Visibility enhancements:** Customise the settings to improve accessibility for visually impaired users.
- **Advanced settings:** Set the Galaxy Watch Active to alert you at regular reminder intervals if there is an unchecked notification and select the interval time. You can also set it to open the accessibility menus quickly.

General

Input

Change the text input settings.

On the Settings screen, tap **General** → **Input**.

- **Default keyboard:** Check the default keyboard for entering the characters.
- **Keyboard settings:** Configure the Samsung keyboard's settings.

Text-to-speech

Change the settings for text-to-speech features, such as languages, speed, and more.

On the Settings screen, tap **General** → **Text-to-speech**.

- **Language:** Select a language to use.
- **Speech rate:** Set the reading speed.
- **Read notifications aloud:** Set the Galaxy Watch Active to read out the received notification on your Galaxy Watch Active. However, you can listen to the audio only through the connected Bluetooth headset.
- **Check for updates:** Update the supported audio languages.

Date and time

You can set the date and time manually.

On the Settings screen, tap **General** → **Date and time**.



The **Date and time** options are available only when you use the Galaxy Watch Active without connecting to a mobile device.

- **Set date:** Set the date manually.
- **Set time:** Set the time manually.
- **Select time zone:** Select the time zone manually.
- **Use 24-hour format:** Display time in 24-hour format.

Language

Select a language to use on your Galaxy Watch Active.

On the Settings screen, tap **General** → **Language**.



The **Language** option is displayed only when you use the Galaxy Watch Active without connecting to a mobile device.

Reset

Delete all data on your Galaxy Watch Active.

On the Settings screen, tap **General** → **Reset**.

Update watch software

Update Galaxy Watch Active to the latest software.

On the Settings screen, tap **General** → **Update watch software**.



The **Update watch software** option is displayed only when you use the Galaxy Watch Active without connecting to a mobile device.

Battery

Select the Galaxy Watch Active's battery mode. You can reduce the battery consumption with some battery modes.

On the Settings screen, tap **Battery**.

- **Default:** Select when using your Galaxy Watch Active normally. You can use all features of the Galaxy Watch Active.
- **Power saving:** Select when activating power saving mode. Displays colours on the screen as grey tones and some feature are restricted to reduce the battery consumption. Refer to [Power saving mode](#) for more information.
- **Watch only:** Only the watch displays on the screen and all other features will be deactivated to reduce the battery consumption. Press the Home key to view the watch. Press and hold the Home key for three seconds to deactivate Watch only mode.

Optimise battery

Close apps running in the background and change settings that have a large effect on battery consumption to extend the battery usage time.

On the Settings screen, tap **Battery** → **Optimise battery**.

About watch

View the Galaxy Watch Active's additional information.

On the Settings screen, tap **About watch**.

- **Model number:** Check your Galaxy Watch Active's model number.
- **Serial number:** Check the Galaxy Watch Active's serial number.
- **Storage:** Check the total space and used storage space.
- **Device:** Check the Galaxy Watch Active's information, such as the Wi-Fi MAC address, Bluetooth address, and serial number.
- **Software:** Check your Galaxy Watch Active's software version and security status.
- **Battery:** Check the Galaxy Watch Active's battery voltage and capacity.

- **Regulatory info:** Check the Galaxy Watch Active's information, such as the model name, manufacturer, and serial number.



This option is not displayed depending on your region or service provider.

- **Open source licences:** View the guide for checking the Galaxy Watch Active's open source licence.
- **Report diagnostic and usage info:** Set the Galaxy Watch Active to automatically send the device's diagnostic and usage information to Samsung.
- **Debugging:** Activate or deactivate debugging mode when developing apps for the Galaxy Watch Active.

Connect to new phone

Connect your Galaxy Watch Active to a new mobile device. The Galaxy Watch Active can connect to another mobile device after performing a light reset to delete data except media files and personal data.

On the Settings screen, tap **Connect to new phone**.



The **Connect to new phone** option is available only when the Galaxy Watch Active is connected to a mobile device.

Connect to phone

Connect to a mobile device while you are using the Galaxy Watch Active by itself. You can select whether to restore the Galaxy Watch Active's data that is saved on the mobile device.

On the Settings screen, tap **Connect to phone**.

- **✓** : Connect your Galaxy Watch Active to a mobile device and sync your health information, setting values, and contacts information saved in the Galaxy Watch Active.
- **✗** : Connect your Galaxy Watch Active to a mobile device after resetting all the data saved in the Galaxy Watch Active.



The **Connect to phone** option is displayed only when you use the Galaxy Watch Active without connecting to a mobile device.

Galaxy Wearable app

Introduction

To connect your Galaxy Watch Active to a mobile device, you must install the Galaxy Wearable app on your mobile device. You can check the Galaxy Watch Active's status and download recommended watch faces and apps. You can also customise your Galaxy Watch Active's various settings, such as your notification settings.

Launch the **Galaxy Wearable** app on your mobile device.

 Some features may not be available depending on the type of connected mobile device.

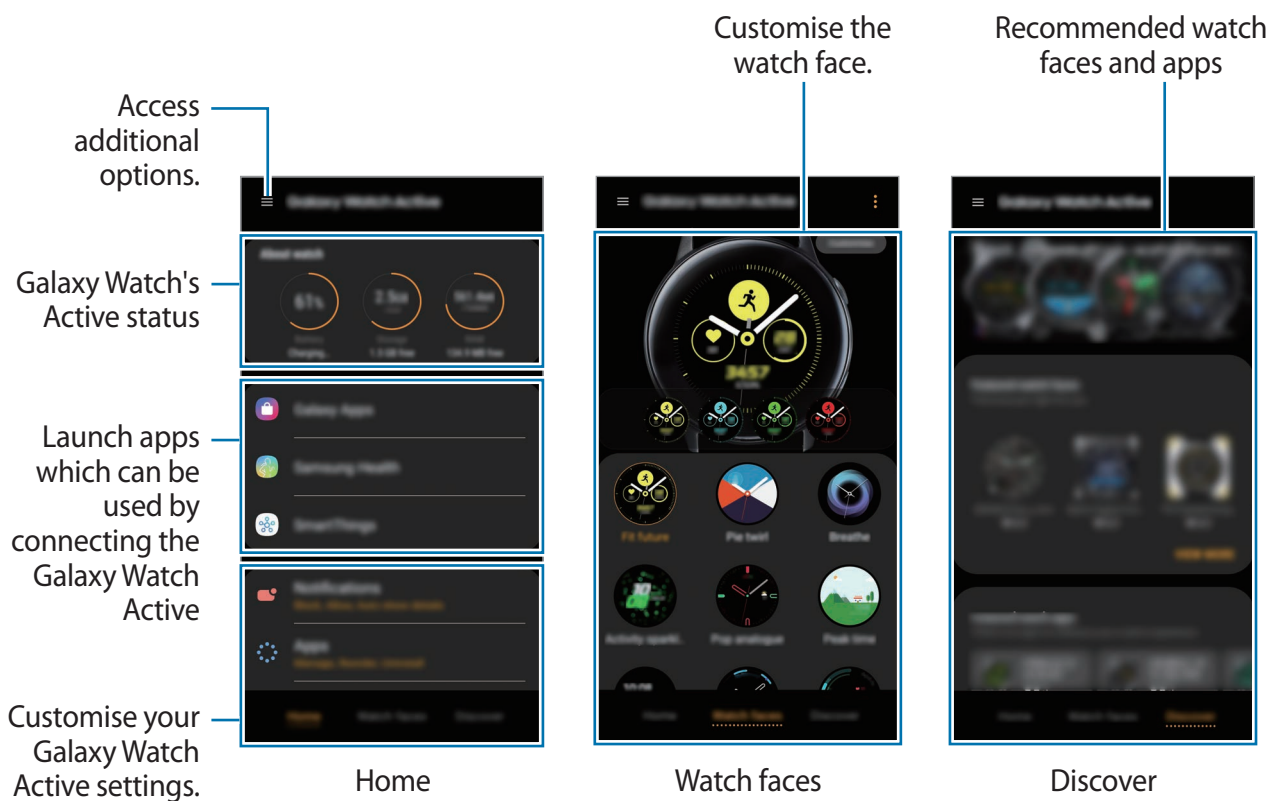

Tap  to use the following options:

- **Add new device:** Disconnect your device from the currently connected mobile device and connect a new device. Select your device on the screen or tap **Mine's not here** if you cannot find your device, and then follow the on-screen instructions to connect to the new device.
- **Disconnect:** Disconnect your Galaxy Watch Active from the currently connected mobile device.
- **App notifications:** Change the various Galaxy Wearable app notification settings on the mobile device.
- **Auto switch:** The Galaxy Watch Active will still automatically connect to your mobile device if you wear it on your wrist.



This option is displayed only when more than two devices that support the auto switch feature are paired to your mobile device.

- **User manual:** View the user manual to learn how to use your Galaxy Watch Active.
- **Contact us: Samsung Members** offers support services to customers, such as device problem diagnosis, and lets users submit questions and error reports. You can also share information with others in the Galaxy users' community or view the latest Galaxy news and tips. **Samsung Members** can help you solve any problems you might encounter while using your device.



This option may not be available depending on the region, service provider or model that does not support the **Samsung Members** app.

Home

View your Galaxy Watch Active's status and customise your Galaxy Watch Active settings. You can also launch usable apps by connecting the Galaxy Watch Active.

Launch the **Galaxy Wearable** app on your mobile device and tap **Home**.

About watch

Provide a status overview of your Galaxy Watch Active's battery, storage, and RAM.

Select an item to view its details.

Payment

You can conveniently make payments with the **Samsung Pay** app by using a mobile payment service.

Launch the **Galaxy Wearable** app on your mobile device and tap **Home** → **OPEN SAMSUNG PAY**.



This option may not be available depending on your region or service provider.

Galaxy Store

Purchase and download apps or watch faces that are specialised for the Galaxy Watch Active from the **Galaxy Store** app.

Launch the **Galaxy Wearable** app on your mobile device and tap **Home** → **Galaxy Store**.

Browse by category and select an app and watch face to download.

Samsung Health

View the data saved in the Samsung Health app.

Launch the **Galaxy Wearable** app on your mobile device and tap **Home** → **Samsung Health**.

Samsung Pay

Make payments conveniently and securely by using a mobile payment service.

Launch the **Galaxy Wearable** app on your mobile device and tap **Home** → **Samsung Pay**.



This option may not be available depending on your region or service provider.

SmartThings

Launch the **SmartThings** app on your mobile device to control and manage conveniently home appliances and Internet of Things (IoT) products.

Launch the **Galaxy Wearable** app on your mobile device and tap **Home** → **SmartThings**.

Notifications

Change settings for the notification feature. Stay up to date with a variety of events, such as new messages received on the mobile device.

Launch the **Galaxy Wearable** app on your mobile device, tap **Home** → **Notifications**, tap the switch to activate it, and then activate items.

- **Manage notifications:** Select apps on the mobile device to send notifications to the Galaxy Watch Active.
- **Show only while wearing watch:** Set the Galaxy Watch Active to show notifications only while you are wearing it.
- **Mute connected phone:** Alert the mobile device on mute when the connected Galaxy Watch Active receives a notification.
- **Auto show details:** Set the Galaxy Watch Active to show details for notifications when they are received.

- **Notification indicator:** Set the Galaxy Watch Active to display an orange dot on the Watch screen to alert you to notifications that you have not checked.
- **Turn on screen:** Set the Galaxy Watch Active to turn on the screen when the notification is received.
- **Show while using phone:** Set the Galaxy Watch Active to show notifications while using your mobile device.
- **Smart relay:** Set the mobile device to automatically launch the app that receives the notification from the Galaxy Watch Active when you pick up the mobile device.





- Some mobile devices do not support the **Smart relay** feature.
- The mobile device must be unlocked first to view details when the screen is locked.

Apps



Customise the Galaxy Watch Active's Apps screen. You can also rearrange apps.

Launch the **Galaxy Wearable** app on your mobile device and tap **Home** → **Apps**.

Uninstalling apps

Tap  → **Uninstall** and tap  next to the apps you want to remove from the Galaxy Watch Active.

Reordering apps

- 1 Tap  → **Reorder** and tap **Custom**.
- 2 Tap  next to an app and drag it to another position.
- 3 Tap **DONE**.

If you select **Most recent first**, the Apps screen of the Galaxy Watch Active will be arranged in the order of recently used apps.

Hiding apps

Hide an app to not have it displayed on the Galaxy Watch Active's Apps screen.

1 Tap  → **Hide**.

2 Select an app and tap **Apply**.

The app will appear under **Hidden Apps** and will not appear on the Galaxy Watch Active's Apps screen.

Unhiding apps

1 Tap  → **Hide**.

2 Deselect the hidden app and tap **Apply**.

The app will disappear under **Hidden Apps** and will appear on the Galaxy Watch Active's last Apps screen.

Customising apps

Tap  on the app to customise the basic settings related to the app.

Widgets

Customise the widgets on the Galaxy Watch Active. You can also rearrange widgets.

Launch the **Galaxy Wearable** app on your mobile device and tap **Home** → **Widgets**.

Adding or removing widgets

Tap  on the widget to remove it or tap  on the widget to add it and tap **Save**.

The widget will be added or removed from the Galaxy Watch Active.

Reordering widgets

Tap  next to a widget, drag it to another position, and then tap **Save**.

The widget's order will be changed on the Galaxy Watch Active.

Vibration

Change the Galaxy Watch Active's vibration settings.

Launch the **Galaxy Wearable** app on your mobile device and tap **Home** → **Vibration**.

- **Vibration intensity:** Adjust the intensity of the vibration notification.
- **Long vibration:** Set the Galaxy Watch Active to vibrate longer for incoming calls and notifications.
- **Ringtone vibration:** Select a vibration pattern for incoming calls.
- **Notification vibration:** Select a vibration pattern for notifications.

Display

Change the Galaxy Watch Active's display settings and the Apps screen.

Launch the **Galaxy Wearable** app on your mobile device and tap **Home** → **Display**.

- **Brightness:** Adjust the brightness for the display.
- **Auto low brightness:** Set the Galaxy Watch Active to automatically adjust the brightness depending on the ambient light conditions.
- **Screen timeout:** Set the length of time the Galaxy Watch Active waits before turning off the display's backlight.
- **Show last app:** Select the length of time to display a recently used app when the screen is back on after it turned off.
- **Background style:** Change the wallpaper.

Advanced

Activate the Galaxy Watch Active's advanced features and change the control settings.

Launch the **Galaxy Wearable** app on your mobile device and tap **Home** → **Advanced**.

- **Double press Home key:** Select an app or feature to launch when you press the Galaxy Watch Active's Home key twice.
- **Wake-up gesture:** Set the Galaxy Watch Active to turn on the screen when you raise your wrist that is wearing the Galaxy Watch Active.
- **Touch wake-up:** Set the Galaxy Watch Active to turn on the screen when you tap the screen.
- **Water lock mode:** Activate water lock mode before entering the water. The touchscreen, the wake-up gesture feature, and the watch always on feature will be deactivated.
- **Touch sensitivity:** Set the Galaxy Watch Active to allow use of the touchscreen with gloves on.
- **Do not disturb:** Set the Galaxy Watch Active to mute all notifications except for alarms and the screen will not turn on when notifications are received.
- **Theatre mode:** Activate theatre mode for watching movies. All alarms and notifications are muted and the screen will not turn on when a notification is received or when there is an alarm. Also, the wake-up gesture feature and watch always on feature will be deactivated automatically.
- **Good night mode:** Activate goodnight mode for sleeping. All notifications except for alarms are muted and the screen will not turn on when notifications are received while sleeping. Also, the wake-up gesture feature and watch always on feature will be deactivated automatically.
- **Edit quick settings:** Edit the Galaxy Watch Active's quick panel.
- **Screen capture:** Swipe right on the screen while pressing the Home key to capture the screen.

Add content to your watch

Transfer saved audio or image files from your mobile device to your Galaxy Watch Active manually or automatically.

Launch the **Galaxy Wearable** app on your mobile device and tap **Home** → **Add content to your watch**.

- **Music**

- **Add tracks:** Select audio files and manually send them from the mobile device to the Galaxy Watch Active.
- **Auto sync:** Set the device to sync recently added audio files with the Galaxy Watch Active when it has more than 15 % of remaining battery power.



If the music files saved on the Galaxy Watch Active take up more than 1 GB, it deletes files that you have not set as your favourites in order from the music files you first added.

- **Playlists to sync:** Select a playlist to sync with the Galaxy Watch Active.



Playlists to sync is available only when the Samsung Music app is installed on your mobile device and it is activated when you turn on the **Auto sync** feature.

- **Images**

- **Copy images:** Select images and manually send them from the mobile device to the Galaxy Watch Active.
- **Auto sync:** Set the device to sync images with the Galaxy Watch Active when it has more than 15 % of remaining battery power.
- **Image limit:** Select the number of images to send to your Galaxy Watch Active from a mobile device.
- **Albums to sync:** Select an image album to sync with the Galaxy Watch Active.

Send SOS requests

Set the Galaxy Watch Active to send an SOS message to the previously registered emergency contact by quickly pressing the Galaxy Watch Active's Home key three times.

Launch the **Galaxy Wearable** app on your mobile device, tap **Home** → **Send SOS requests**, and then tap the switch to activate it. Refer to [SOS messages](#) for more information.

Find My Watch

Remotely control your Galaxy Watch Active when it is lost or misplaced.

Launch the **Galaxy Wearable** app on your mobile device and tap **Home** → **Find My Watch**.



Register your Samsung account on the connected mobile device first to use this feature.

- **Get location:** Check where the Galaxy Watch Active is placed.
- **Set security:**
 - **Remote lock:** Remotely lock the Galaxy Watch Active to prevent unauthorised access. This feature can be used when your mobile device is connected to your Galaxy Watch Active via Bluetooth or a remote connection. When your Galaxy Watch Active is locked, connect your mobile device to the Galaxy Watch Active via Bluetooth. The lock will be deactivated automatically.
 - **Reset watch:** Remotely delete all personal information stored in the Galaxy Watch Active. After the Galaxy Watch Active is reset, you cannot restore the information or use the Find My Watch feature.
 - **Reactivation lock:** Set the Galaxy Watch Active to require your Samsung account information after the device has been reset. This prevents others from reactivating your device if it is lost or stolen.

Account and backup

Register your Samsung account and sign in to back up, or restore your Galaxy Watch Active's data using Samsung Cloud. You can also remotely connect to your Galaxy Watch Active with your Samsung account.

Launch the **Galaxy Wearable** app on your mobile device and tap **Home** → **Account and backup**.

- **Samsung account:** Add your Samsung account to use with your Galaxy Watch Active.
- **Back up and restore:** Keep your personal information, app data, and settings safe on your Galaxy Watch Active. You can back up your sensitive information and access it later. You must sign in to your Samsung account to back up or restore data. Refer to [Managing the data in the Galaxy Watch Active](#) for more information.
- **Remote connection:** Set the Galaxy Watch Active to remotely connect with the Wi-Fi network when a Bluetooth connection between devices is not available. To use this feature, sign in to your Samsung account.



Regularly back up your data to a safe location, such as Samsung Cloud or a computer, so that you can restore it if the data is corrupted or lost due to an unintended factory data reset.

Managing the data in the Galaxy Watch Active

Keep your personal information, app data, and settings safe on your Galaxy Watch Active. You can back up your sensitive information and access it later, as well as back up your Galaxy Watch Active's data automatically.



- Music and images saved on the Galaxy Watch Active will not be backed up.
- For the Samsung Health app, only records from the previous 28 days are saved in your Galaxy Watch Active. To view saved record older than 28 days, install the Samsung Health app on the connected mobile device and back up data automatically.

Backing up data

To back up data saved in your Galaxy Watch Active, launch the **Galaxy Wearable** app on your mobile device, tap **Home** → **Account and backup** → **Back up and restore** → **Backup settings**, select the item to back up, and then tap **Back up now**. The data will be saved in Samsung Cloud.

Restoring data

To restore data saved in your Galaxy Watch Active, launch the **Galaxy Wearable** app on your mobile device, tap **Home** → **Account and backup** → **Back up and restore** → **Restore**, select the item to restore, and then tap **Restore now**. The latest backup data will be restored.

Backing up data automatically

To automatically back up data saved in your Galaxy Watch Active with Samsung Cloud and access it from other devices whenever you want, launch the **Galaxy Wearable** app on your mobile device, tap **Home** → **Account and backup** → **Back up and restore** → **Backup settings**, and then tap the **Auto back up** switch to activate it.

Sync phone settings

Customise your Galaxy Watch Active's Wi-Fi network sync settings.

Launch the **Galaxy Wearable** app on your mobile device, tap **Home** → **Sync phone settings**, and then tap the **Sync Wi-Fi profiles** switch to activate it.

The mobile device is then set to sync with the list of saved Wi-Fi networks on your Galaxy Watch Active.

Accessibility

Configure various settings to improve accessibility to the Galaxy Watch Active.

Launch the **Galaxy Wearable** app on your mobile device and tap **Home** → **Accessibility**.

- **Visibility enhancements:** Customise the settings to improve accessibility for visually impaired users.
- **Advanced settings:** Set the Galaxy Watch Active to alert you at regular reminder intervals if there is an unchecked notification and select the interval time. You can also set it to open the accessibility menus quickly.

About watch

View your Galaxy Watch Active's status and other information. You can also update the Galaxy Watch Active's software.

Launch the **Galaxy Wearable** app on your mobile device and tap **Home** → **About watch**.

- **Battery:** Check the remaining battery and usage time, and also activate the power saving mode.



The usage time left shows the time remaining before the battery power runs out. Usage time left may vary depending on your device settings and operating conditions.

- **Storage:** Check the status of the used and available memory. To delete unnecessary files, tap **CLEAN NOW**.



The actual available capacity of the internal memory is less than the specified capacity because the operating system and default apps occupy part of the memory. The available capacity may change when you update the device.

- **RAM:** Check the status of the used and available RAM. To speed up your Galaxy Watch Active by reducing the amount of RAM you are using, tick apps from the apps list, and tap **CLEAN NOW**.
- **Update watch software:** Update the Galaxy Watch Active to the latest software.

- **Legal information:** View the legal information for the Galaxy Watch Active.
- **Install unknown apps:** Set the Galaxy Watch Active to allow the installation of apps from unknown sources.
- **Device name:** Change the Galaxy Watch Active's name.
- **Device information:** Check the Galaxy Watch Active's information, such as the Wi-Fi MAC address, Bluetooth address, and serial number.

Updating software via the Galaxy Wearable app

The Galaxy Watch Active can be directly updated to the latest software by the firmware over-the-air (FOTA) service.

- 1 Launch the **Galaxy Wearable** app on your mobile device.
- 2 Tap **Home** → **About watch** → **Update watch software** → **Update now**.
- 3 Tap **DOWNLOAD** and install the latest software version on your mobile device.
- 4 Read the on-screen information and tap **INSTALL NOW**.

The Galaxy Watch Active will copy the updated software from your mobile device and restart.



To automatically check for available updates and download them, tap the **Auto update** switch to activate it. Updates will be downloaded only when the device is connected to a Wi-Fi network.

About Galaxy Wearable

View version information of the Galaxy Wearable app.

Launch the **Galaxy Wearable** app on your mobile device and tap **Home** → **About Galaxy Wearable**.

Watch faces

You can change the type of watch to be displayed on the Watch screen.

Launch the **Galaxy Wearable** app on your mobile device, tap **Watch faces**, and then select a desired watch type. The watch face you selected will be applied on the Watch screen.

Tap **Customise** to change the background and set items to display on the watch face.

Discover

You can download recommended watch faces and apps from the **Galaxy Store** app.

Launch the **Galaxy Wearable** app on your mobile device and tap **Discover**.

Download the watch faces and apps you want. Tap **VIEW MORE** to view more watch faces and apps.

Using the Galaxy Watch Active

Introduction

Use the helpful features of the Galaxy Watch Active to add convenience to your daily life and manage your health. Also, the customisation service of the Galaxy Watch Active analyses your usage patterns and status to provide services and information according to your location and place.

Enjoy the many features of the Galaxy Watch Active.

Using as a personal coach for your health

Take care of your health with the Galaxy Watch Active. The heart rate sensor measures your heart rate and analyses your stress level and sleep pattern. You can also create a personal routine based on the profile data you entered.



You can use various other exercises and health managing features when you use the Galaxy Watch Active while connected to a mobile device.

Achieving your daily activity target

Check your daily activity goal based on your target, such as the calories burned, exercise time, or activity time, and also with the entered profile at a glance.

You can check your daily target at a glance with the daily activity graph from the **Daily activity** widget or **Samsung Health** app. You can use this information to track your health and do more activities to create a well-balanced daily routine and become healthier.

Refer to [Daily activity](#) for more information.

Managing stress and sleep quality

A more accurate heart rate sensor continuously measures your stress levels and sleep patterns.

Managing stress

When the stress level measurement is completed, you can relax by following the breathing directions that the Galaxy Watch Active provides. After you measure your stress level, tap **BREATHE >** to breathe and relieve stress.

Checking your sleeping patterns

Your sleeping pattern will be measured and divided into four states. After waking up in the morning, you can check your sleep pattern on the sleep tracker screen or through the **Sleep** widget. Find out your sleep pattern through constant observation.

Refer to [Sleep](#) for more information.



The sleep pattern will have its four states (Awake, REM, Light, Deep) analysed by using your movement and changes in your heart rate. A graph will be provided with recommended values for each measured sleep state based on results for people in your same age group.

Experiencing enhanced exercises

Using the various exercise features

The Galaxy Watch Active supports about 40 indoor and outdoor exercises and activities. Exercise efficiently with the Galaxy Watch Active at home, outside, or at a fitness centre. The Galaxy Watch Active helps you achieve your set target by carefully checking your workout time, distance, speed, heart rate, and calorie consumption during exercising.

Refer to [Exercise](#) for more information about starting various exercise.

Doing multiple exercises in one session

You can effectively continue through several exercises in one session. After finishing one exercise, start the next exercise immediately.

Refer to [Doing multiple exercises](#) for more information.

Using as an intelligent planner

Checking out today's information

Use the Galaxy Watch Active on an important day. You can view information such as schedules, reminders, and the alarm time on the Watch screen even if you do not run any applications.

Tap and hold the Watch screen and swipe the screen left or right to select the **My day** watch face. You can view your daily schedule and manage it on the **My day** watch face.

You can view the following information on the watch face:

- Today's schedule you have set on the calendar
- Items you have saved as reminders
- Alarm times

Refer to [Calendar](#), [Reminder](#), or [Alarm](#) for more information about registering a schedule or reminder, or setting up an alarm.



- You can only check schedule and alarm information that has been set within 10 hours of the current time.
- The alarm information added to the mobile device is not displayed on the Watch screen.

Managing my daily life

The Galaxy Watch Active helps you enjoy your life comfortably. The customisation service of the Galaxy Watch Active identifies your lifestyle and taste and provides appropriate features according to your location or situation. Start and end your day with the Galaxy Watch Active. The Galaxy Watch Active will provide you with what you need the most anytime, anywhere.



- This feature is available after connecting the Galaxy Watch Active to a mobile device that supports the customisation service platform 2.2 or later. After making an agreement to use the customisation service, launch the **Settings** app on your mobile device, tap **Accounts and backup** → **Accounts** → **Samsung account** → **Privacy** → **Customisation Service**, and then tap the switch to activate it.
- If the previously analysed lifestyle pattern changes, the Galaxy Watch Active will provide the service and feature based on the changed pattern.

Being briefed twice a day

You can be briefed after waking up and before going to bed on useful information you need for the day.

On the Apps screen, tap  (**Settings**) → **Advanced** → **Daily briefing** → **Get briefings automatically** and tap the switch to activate it.

After waking up, the Galaxy Watch Active notifies you of today's important events or weather. Before you go to bed, the Galaxy Watch Active notifies you of your exercise status, tomorrow's weather, and reminds you of any unfinished reminders items.

Refer to [Calendar](#) or [Reminder](#) for more information about registering a schedule or a reminder for a briefing.



- You can also be briefed twice a day when you want. On the Apps screen, tap  (**Settings**) → **Advanced** → **Daily briefing** → **Set briefing times**, tap the switch to activate it, and then tap **Briefing times** to set the time to be briefed. However, this feature is available only when you deactivate the **Get briefings automatically** features first.

Launching recommended apps by location and time

Launch your favourite apps conveniently with widgets. The Galaxy Watch Active analyses your usage patterns by time and place to automatically add your favourite apps that you have used at specific times or places to the **App shortcuts** widget.

For example, when you arrive at a bus stop during rush hour, your frequently used maps or transit-related apps and your music app are automatically added to the widget.

Swipe the screen to the left on the Watch screen and launch automatically added apps from the **App shortcuts** widget.

Activating goodnight mode to sleep more comfortably

Before bedtime, the Galaxy Watch Active notifies you to go to sleep. Activate goodnight mode optimised for sleep.

On the Apps screen, tap  (**Settings**) → **Advanced** → **Goodnight mode** and tap the switch to activate it. When you receive the notification for activating goodnight mode, follow the screen to activate it.

To activate goodnight mode automatically, tap the **Use while sleeping** switch to activate it. You will receive a notification 30 minutes before goodnight mode activates automatically.

The following features are disabled:

- All vibration notifications except for alarms
- Screen turn on when a notification is received
- The watch always on feature
- The wake-up gesture feature

Goodnight mode is automatically disabled after you wake up.

Using dual clock when you are abroad

If you are travelling abroad or travelling on a business trip, the Galaxy Watch Active automatically detects the changed time zone and suggests that you switch to the dual clock screen to see both the local time and your country's time. Use the dual clock feature by changing the watch face according to the notifications.



This feature is available after connecting the Galaxy Watch Active to a mobile device that supports the customisation service platform 2.2 or later. After making an agreement to use the customisation service, launch the **Settings** app on your mobile device, tap **Accounts and backup** → **Accounts** → **Samsung account** → **Privacy** → **Customisation Service**, and then tap the switch to activate it.

Using a convenient reminder

Register a reminder quickly with your voice and get briefed on today's reminders.

Registering reminders with your voice

You can easily save what you need to remember with your voice.

For example, say 'Call my mom at 3 o'clock' and make a reminder. At 3 o'clock, you will be notified that it is time to call mom.

Refer to [Creating a reminder](#) for more information about registering for reminders.

Appendix

Troubleshooting

Before contacting a Samsung Service Centre, please attempt the following solutions. Some situations may not apply to your Galaxy Watch Active.

Your Galaxy Watch Active does not turn on

When the battery is completely discharged, your Galaxy Watch Active will not turn on. Fully charge the battery before turning on the Galaxy Watch Active.

The touchscreen responds slowly or improperly

- If you attach a screen protector or optional accessories to the touchscreen, the touchscreen may not function properly.
- If you are wearing gloves, if your hands are not clean while touching the touchscreen, or if you tap the screen with sharp objects or your fingertips, the touchscreen may malfunction.
- The touchscreen may malfunction in humid conditions or when exposed to water.
- Restart your Galaxy Watch Active to clear any temporary software bugs.
- Ensure that your Galaxy Watch Active software is updated to the latest version.
- If the touchscreen is scratched or damaged, visit a Samsung Service Centre.

Your Galaxy Watch Active freezes or has errors

Try the following solutions. If the problem is still not resolved, contact a Samsung Service Centre.

Restarting the Galaxy Watch Active

If your Galaxy Watch Active freezes or hangs, you may need to close apps or turn off the Galaxy Watch Active and turn it on again.

Forcing restart

If your Galaxy Watch Active is frozen and unresponsive, press and hold the Home key (Power key) for more than 7 seconds to restart it.

Resetting the Galaxy Watch Active

If the methods above do not solve your problem, perform a factory data reset.

On the Apps screen, tap  (Settings) → **General** → **Reset**. Before performing the factory data reset, remember to make backup copies of all important data stored in the Galaxy Watch Active.

Another Bluetooth device cannot locate your Galaxy Watch Active

- Ensure that the Bluetooth wireless feature is activated on your Galaxy Watch Active.
- Reset your Galaxy Watch Active and try again.
- Ensure that your Galaxy Watch Active and the other Bluetooth device are within the Bluetooth connection range (10 m). The distance may vary depending on the environment the devices are used in.

If the tips above do not solve the problem, contact a Samsung Service Centre.

A Bluetooth connection is not established or your Galaxy Watch Active and the mobile device are disconnected

- Ensure that the Bluetooth feature on both devices is activated.
- Ensure there are no obstacles, such as walls or electrical equipment, between the devices.
- Ensure that the latest version of the Galaxy Wearable app is installed on the mobile device. If necessary, update the Galaxy Wearable app to the latest version.
- Ensure that your Galaxy Watch Active and the other Bluetooth device are within the Bluetooth connection range (10 m). The distance may vary depending on the environment the devices are used in.
- Restart both devices and launch the Galaxy Wearable app on the mobile device again.

Calls are not connected

- Ensure that your Galaxy Watch Active is connected to a mobile device via Bluetooth. If your Galaxy Watch Active is connected to your mobile device remotely, you cannot receive incoming calls.
- Ensure that you have not set call barring for the incoming phone number on the mobile device.
- Check if do not disturb mode, goodnight mode, or theatre mode is activated. If one of these modes has been activated, the touchscreen does not turn on during incoming calls. Press the Home key or Back key to turn on the screen and check the incoming call.

The battery icon is empty

Your battery is low. Charge the battery.

The battery does not charge properly (For Samsung-approved chargers)

- Ensure that you connect the Galaxy Watch Active to the wireless charger and connect the dock to the charger properly.
- Visit a Samsung Service Centre and have the battery replaced.

The battery depletes faster than when first purchased

- When you expose the Galaxy Watch Active or the battery to very cold or very hot temperatures, the useful charge may be reduced.
- Battery consumption increases when you use some apps.
- The battery is consumable and the useful charge will get shorter over time.

Your Galaxy Watch Active is hot to the touch

When you use apps that require more power or use apps on your Galaxy Watch Active for an extended period of time, your Galaxy Watch Active may feel hot to the touch. This is normal and should not affect your Galaxy Watch Active's lifespan or performance.

If the Galaxy Watch Active overheats or feels hot for a prolonged period, do not use it for a while. If the Galaxy Watch Active continues to overheat, contact a Samsung Service Centre.

Your Galaxy Watch Active cannot find your current location

The Galaxy Watch Active uses your mobile device's location information. GPS signals may be obstructed in some locations, such as indoors. Set the mobile device to use Wi-Fi network to find your current location.

Data stored in the Galaxy Watch Active has been lost

Always make backup copies of all important data stored in the Galaxy Watch Active. Otherwise, you cannot restore data if it is corrupted or lost. Samsung is not responsible for the loss of data stored in the Galaxy Watch Active.

A small gap appears around the outside of the Galaxy Watch Active case

- This gap is a necessary manufacturing feature and some minor rocking or vibration of parts may occur.
- Over time, friction between parts may cause this gap to expand slightly.

There is not enough space in the Galaxy Watch Active's storage

Delete unnecessary data, such as cache, using the Galaxy Wearable app or manually delete unused apps or files to free up storage space.

Removing the battery

- **To remove the battery, contact an authorised service centre. To obtain battery removal instructions, please visit www.samsung.com/global/ecodesign_energy.**
- For your safety, you **must not attempt to remove** the battery. If the battery is not properly removed, it may lead to damage to the battery and device, cause personal injury, and/or result in the device being unsafe.
- Samsung does not accept liability for any damage or loss (whether in contract or tort, including negligence) which may arise from failure to precisely follow these warnings and instructions, other than death or personal injury caused by Samsung's negligence.

Copyright

Copyright © 2019 Samsung Electronics

This manual is protected under international copyright laws.

No part of this manual may be reproduced, distributed, translated, or transmitted in any form or by any means, electronic or mechanical, including photocopying, recording, or storing in any information storage and retrieval system, without the prior written permission of Samsung Electronics.

Trademarks

- SAMSUNG and the SAMSUNG logo are registered trademarks of Samsung Electronics.
- Bluetooth® is a registered trademark of Bluetooth SIG, Inc. worldwide.
- Wi-Fi®, Wi-Fi Protected Setup™, Wi-Fi Direct™, Wi-Fi CERTIFIED™, and the Wi-Fi logo are registered trademarks of the Wi-Fi Alliance.
- All other trademarks and copyrights are the property of their respective owners.