

460/470/570/670

LED TV

Installation manual

Thank you for purchasing this Samsung product. To receive more complete service, please register your product at www.samsung.com/register

Model _____ Serial No. _____

SAMSUNG

Figures and illustrations in this User Manual are provided for reference only and may differ from actual product appearance. Product design and specifications may be changed without notice.

Instruction

This TV is provided with interactive functionality through a set-back box (SBB/STB) connected to the TV, and with other TVs in a computer controlled system for hotels and other hospitality businesses.

- **Interactive:** When the TV is powered-up initially, it sends a command to identify the SBB/STB. If identified, the TV switches to ONLINE mode and full control is through the SBB/STB. If the TV is in ONLINE mode, it stops receiving IR (Samsung remote) commands and acts according to the interface protocol.
- **Stand-Alone:** If SBB/STB is not identified, the TV should be switched to STAND-ALONE mode with restricted operations.

Operational Modes

When this TV (in Hotel mode) is operated with a SBB/STB, it is in one of two states:

- **ONLINE or STAND-ALONE.** In the STAND-ALONE state, the TV will act as a Hotel TV, but without active communication. This prevents guests from trying to cheat the system by disconnecting the SBB/STB.

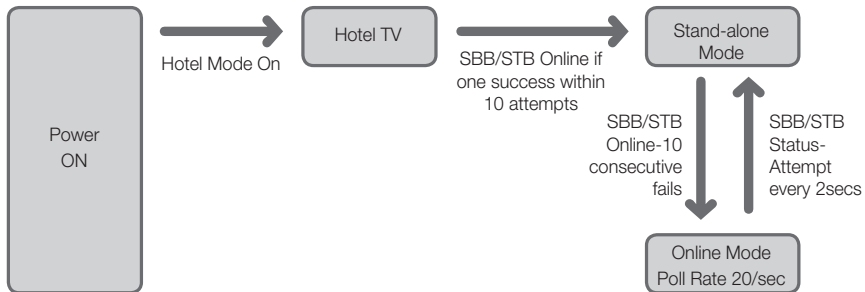

To set the details for Stand-alone or interactive mode, refer to pages 39-43 (Setting the hotel option data: Stand-alone mode and Interactive mode)

- Some operations may be restricted to prevent guests from "cheating" the TV system.
- No main menu (Interactive mode) or Channel Menu, Plug & Play in Main Menu (Stand-Alone mode)
- Limited Volume and Panel key lock or unlock

Still image warning

Avoid displaying still images (like jpeg picture files) or still image elements (like TV Programme such as TV Programme logos, the panorama or 4:3 image format, stock or news bars at the bottom of the screen etc.) on the screen. Constantly displaying still pictures can cause uneven wear of the screen phosphor, which will affect the image quality. To reduce risk of this effect, please follow the recommendations below:

- Avoid displaying the same TV channel for long periods.
- Always try to display any image over the full screen, use the TV set picture format menu for the best possible match.
- Reduce the brightness and contrast values to the minimum required values to achieve the desired picture quality. Exceeding these values may speed up the burnout process.
- Frequently use all TV features designed to reduce image retention and screen burnout, refer to the appropriate user manual section for more details.

Securing the Installation Space

Keep the required distances between the product and other objects (e.g. walls) to ensure proper ventilation.

Failing to do so may result in fire or a problem with the product due to an increase in the internal temperature of the product.

When using a stand or wall-mount, use parts provided by Samsung Electronics only.

- If you use parts provided by other manufacturers, it may result in a problem with the product or an injury due to the product falling.

The appearance may differ depending on the product.

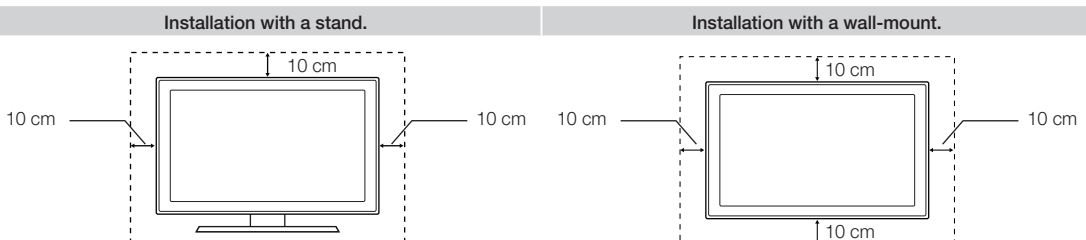

Contents

- Accessories 4
- Installing the LED TV Stand 4
- Assembling the swivel (Depending on the model) 14
- Viewing the Connection Panel 15
- Using the TV's Controller 27
- Viewing the Remote Control 28
- Connecting the TV with SBB 32
- Connecting the Bathroom Speakers 34
- Connecting the MediaHub HD 36
- Connecting the RJP (Remote Jack Pack) 37
- Setting the Hotel Option Data 39
- Installing the Wall Mount 65
- Securing the TV to the Wall 67
- Anti-theft Kensington Lock 67
- Specifications 68

Accessories

- 🔗 Please make sure the following items are included with your LED TV. If any items are missing, contact your dealer.
- 🔗 The items' colours and shapes may vary depending on the model.

- Remote Control & Batteries (AAA x 2)
- Power Cord
- Safety Guide (Depending on the model)
- Hotel Mount Kit (Depending on the model)
- Data Cable (Depending on the model)
- Wall Mount Adapter (Depending on the model)
- Quick Setup Guide
- Guide Stand
- Screws
- Stand
- Holder-Stand Cable (Depending on the model)

- 🔗 The stand and stand screws may not be included depending on the model.
- 🔗 The Data Cable may not be included depending on the SI Vendor.

Installing the LED TV Stand

The 32" and larger LED TVs have swivel stands. You can set these stands so that the TVs swivel 20 degrees left and right or 60 degrees and right or 90 degrees left and right. (Depending on the model)

Stand Components

When installing the stand, use the provided components and parts.

HG**EE470

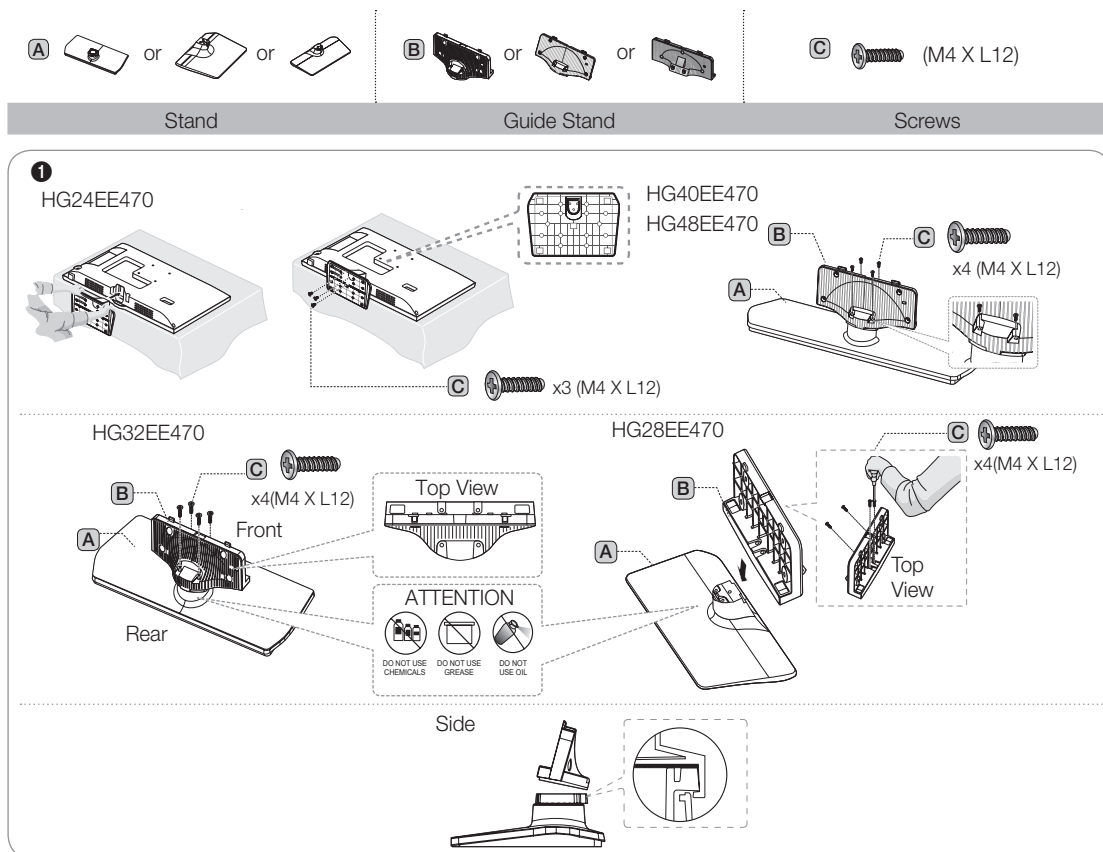

2

HG32EE470/HG40EE470/HG48EE470

HG28EE470

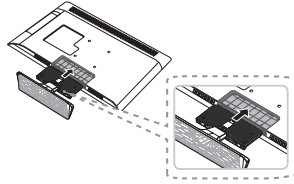
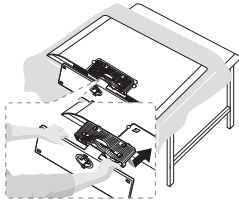

3

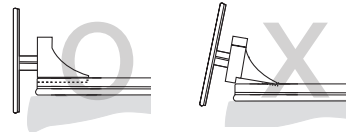

- Place a soft cloth over a table to protect the TV, and then place the TV on the cloth screen side down.
- Insert the Stand Guide into the slot on the bottom of the TV.

4

HG32EE470



HG40EE470/HG48EE470



HG28EE470



HG24EE460



Stand



Screws

1

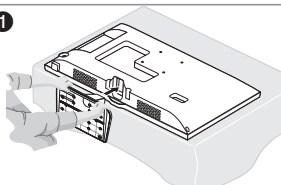

2

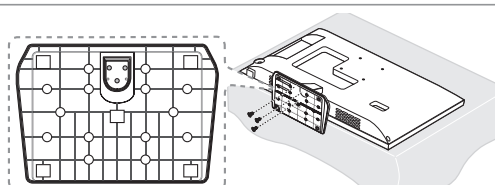

HG28EE460

A

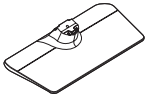

B



C  x7 (M4 X L12)

Stand

Guide Stand

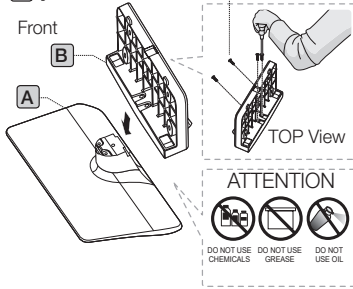

Screws

1 C  x4 (M4 X L12)

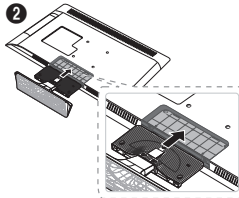

2



-  Place a soft cloth over the table to protect the TV, and then place the TV on the cloth screen-side down.
-  Insert the Stand Guide into the slot on the bottom of the TV.

3

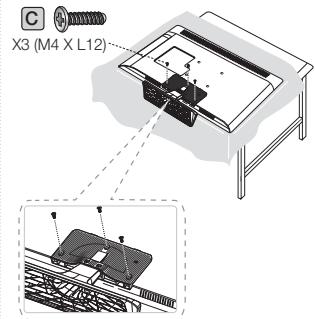

HG32EE460/HG32AE460

A

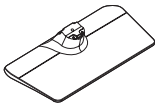

B



C  x8 (M4 X L12)

Stand

Guide Stand

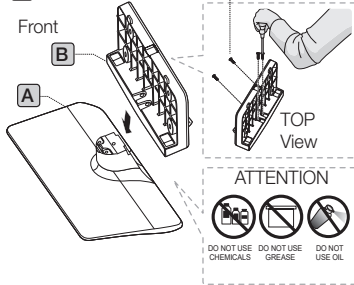

Screws

1 C  x4 (M4 X L12)

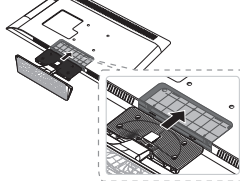

2



-  Place a soft cloth over the table to protect the TV, and then place the TV on the cloth screen-side down.
-  Insert the Stand Guide into the slot on the bottom of the TV.

3

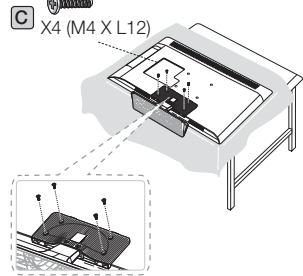

HG40EE460/HG40AE460/HG48AE460/HG43AE570/HG48AE570

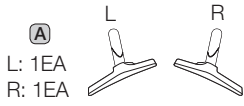

Stand

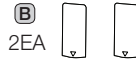

Guide Stand



Screws

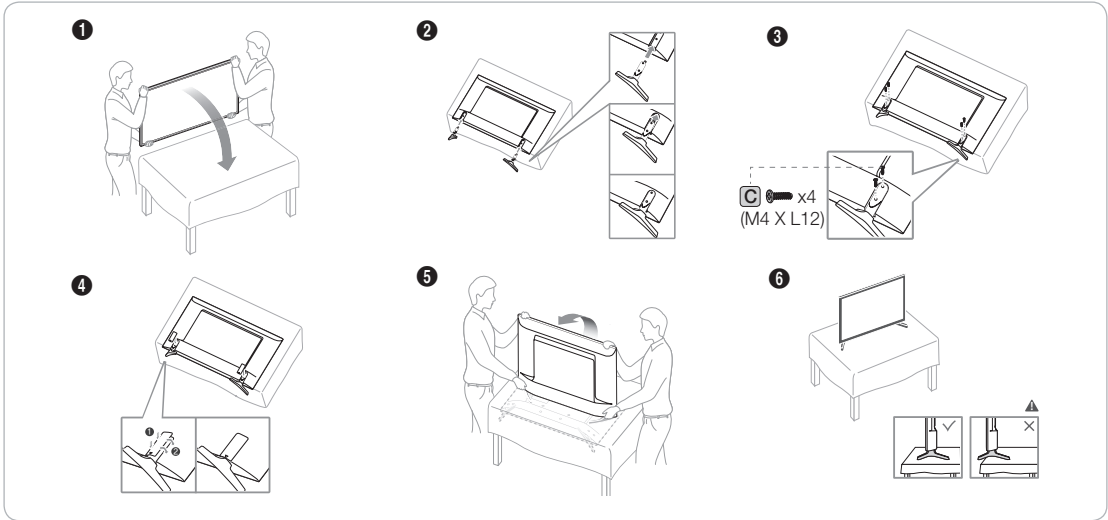

HG32AE570

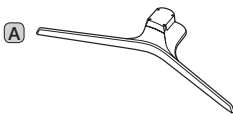

Stand

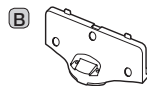

Guide Stand



Screws

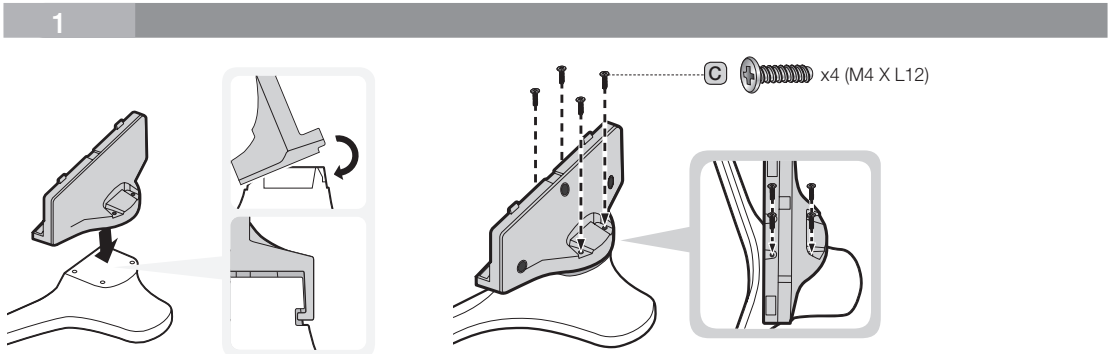

2

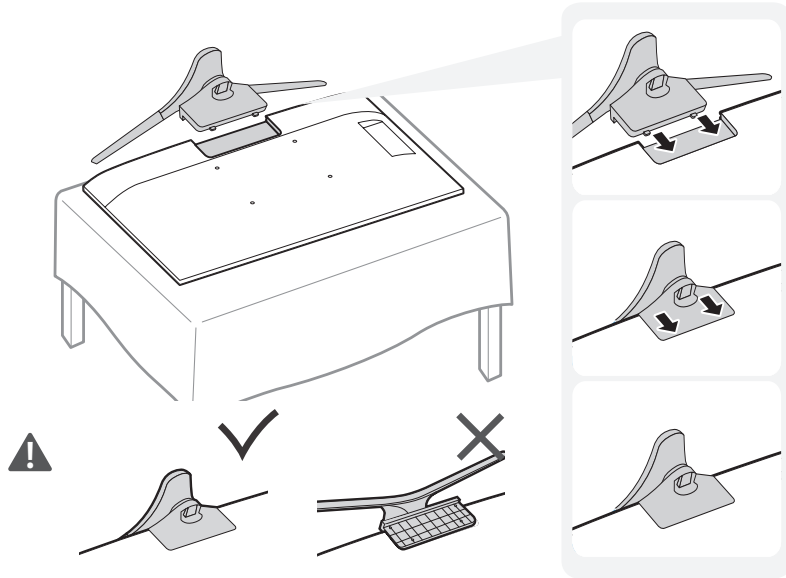

3

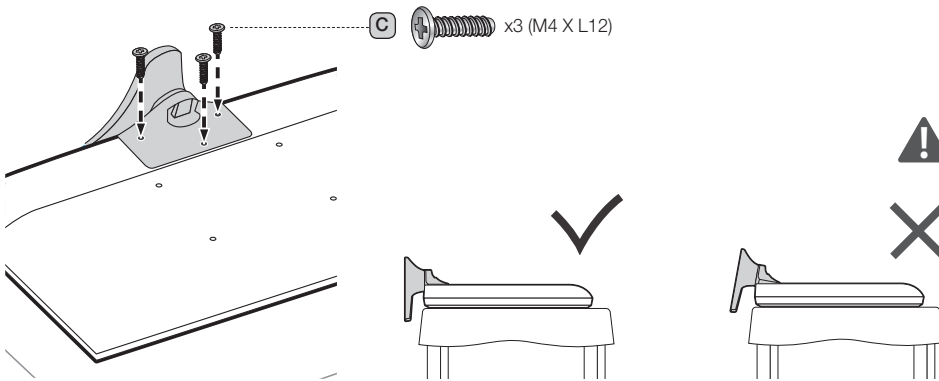

HG32AE570



Stand

Screws

1

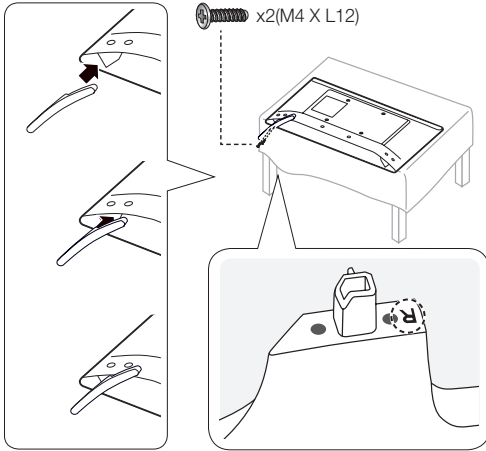

2

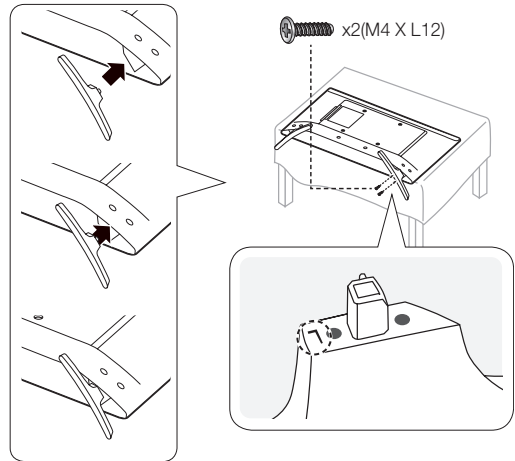

3

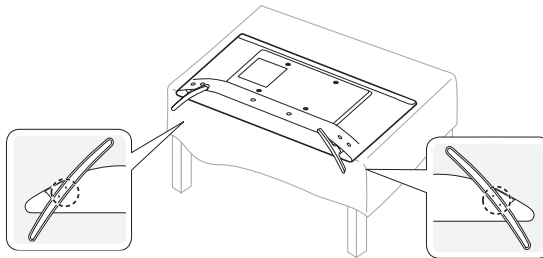

HG43AE570/HG48AE570

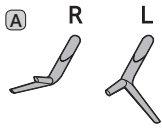

Stand

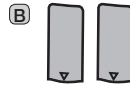

Guide Stand



Screws

1

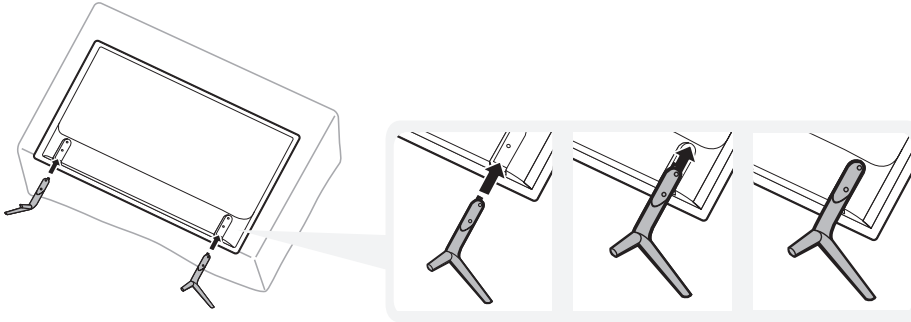

2

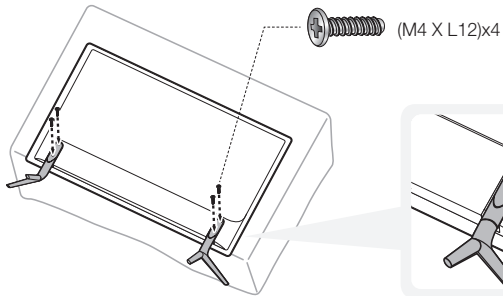

3

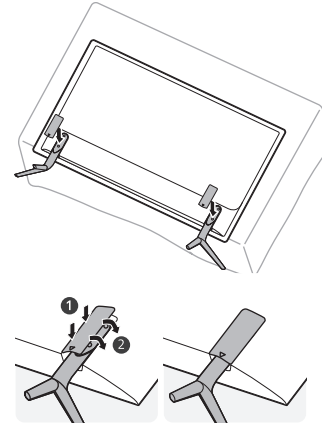

HG58AE570

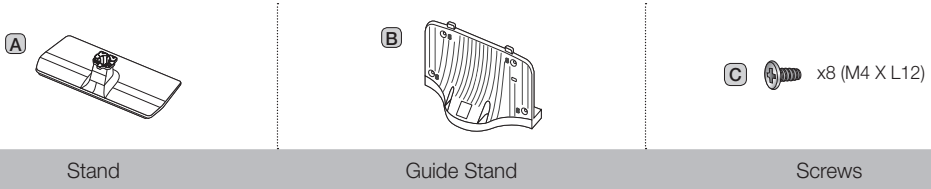

1

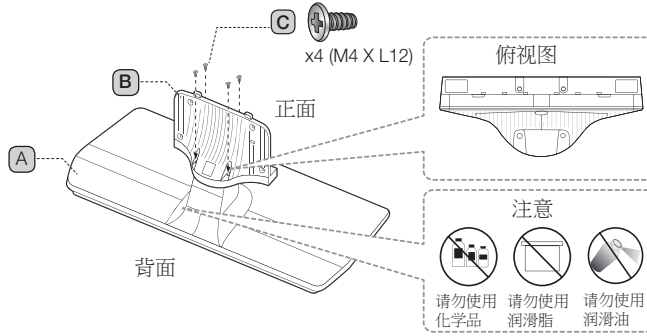

2

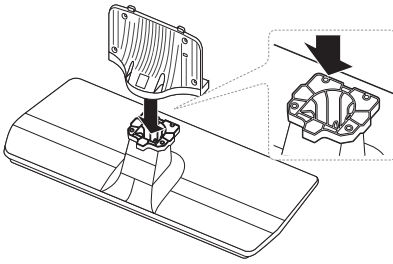

3

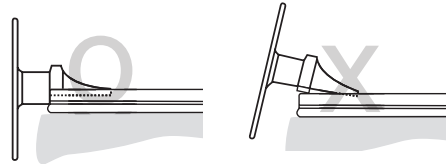

4

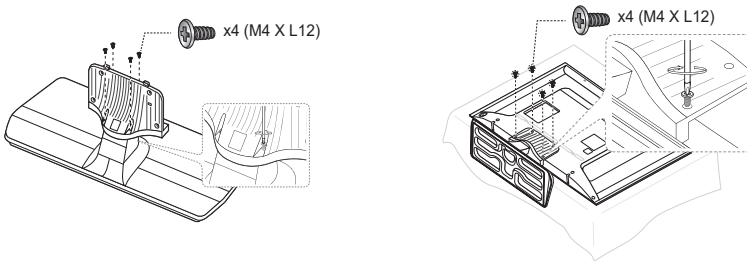

HG**AE570 (Except China and Hongkong)

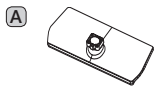

Stand



Guide Stand



Screws

1-1

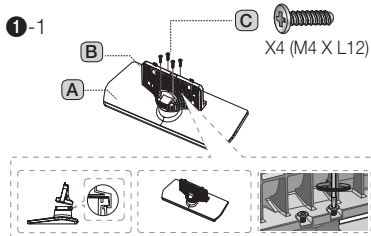

X4 (M4 X L12)



2-1

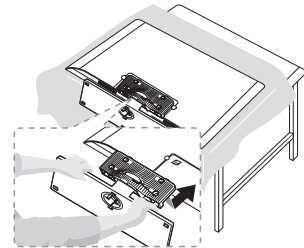

- Place a soft cloth over the table to protect the TV, and then place the TV on the cloth screen-side down.
- Insert the Stand Guide into the slot on the bottom of the TV.
- Slide and assemble it to the end line in the direction of arrow.

3-1

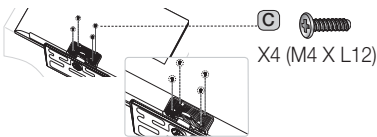

X4 (M4 X L12)

- Tight the bottom of the screw first, and stow the upper side of screw last.
- Progress the assembly of screw in the manual's order.

2

HG40AE570/HG48AE570/HG43AE570

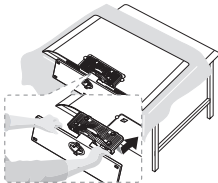

- Place a soft cloth over a table to protect the TV, and then place the TV on the cloth screen side down.
- Insert the Stand Guide into the slot on the bottom of the TV.

3

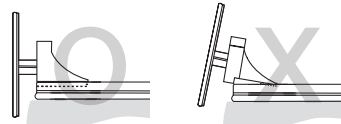

4

HG40AE570/HG48AE570/HG43AE570

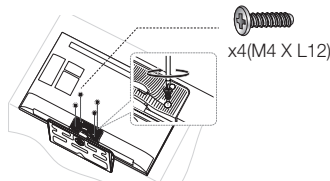

x4(M4 X L12)

HG**EE670

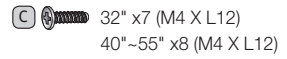
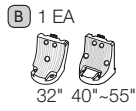
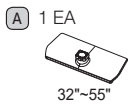

Stand	Guide Stand	Screws
-------	-------------	--------

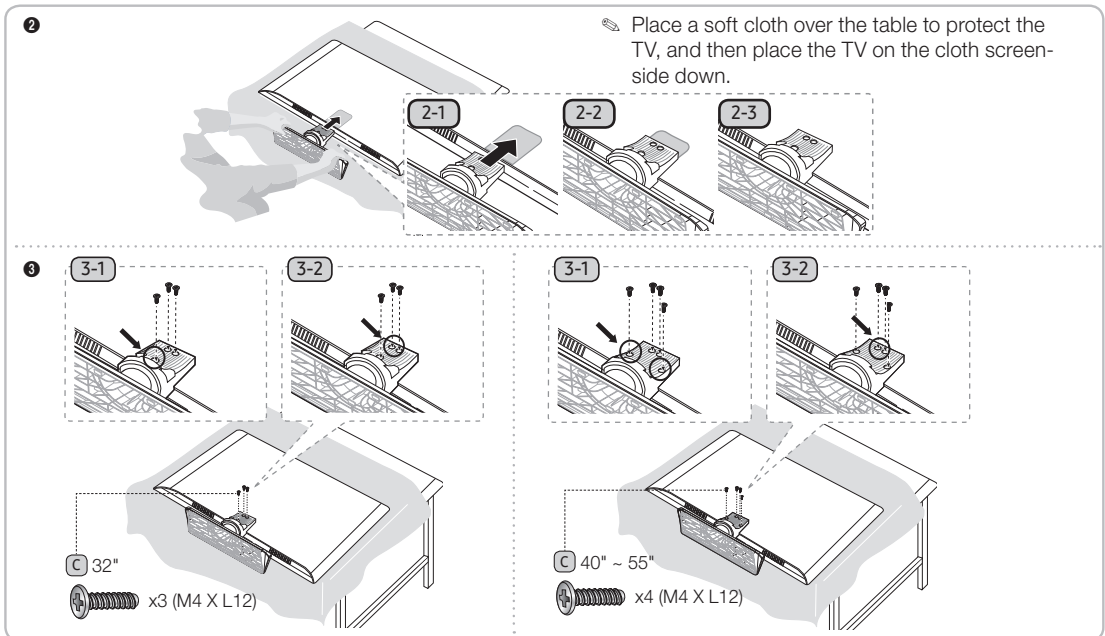
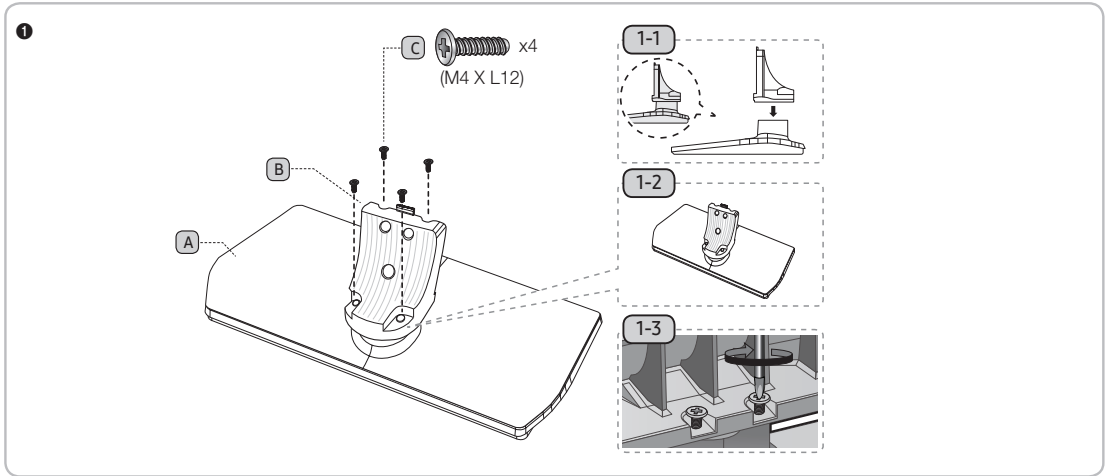

Assembling the swivel (Depending on the model)

Some model support the swivel function. The swivel angle support all of 20°, 60° and 90° and you can change the swivel angle by using BRACKET HOLDER SWIVEL.

20° ~ 60° swivel

If you assemble the wedge on the bottom of the stand to the hole of BRACKET HOLDER SWIVEL where 20° or 60° is marked, the swivel angle becomes each 20° ~ 60° in the left and right side.
(The shape of stand depend on the model.)

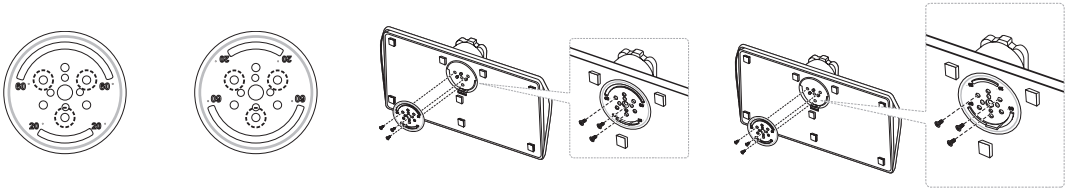

90° swivel

If you assemble only screws after you remove BRACKET HOLDER SWIVEL, the swivel angle becomes each 90° in the left and right side.

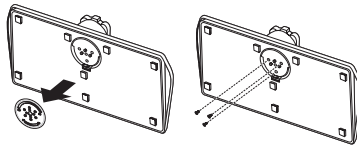

Hotel Mount Kit (Depending on the model)

				
Short Bolt (2EA)	Long Bolt (2EA)	Nut (2EA)	Washer (2EA)	Bolt + Nut

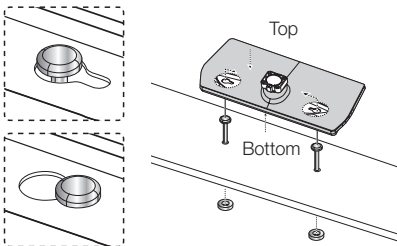

Affix the stand to a flat surface such as a dresser top, desk top, or entertainment center as shown.



WARNING: To prevent injury, this apparatus must be securely attached to the floor/ table in accordance with the installation instructions.

Viewing the Connection Panel

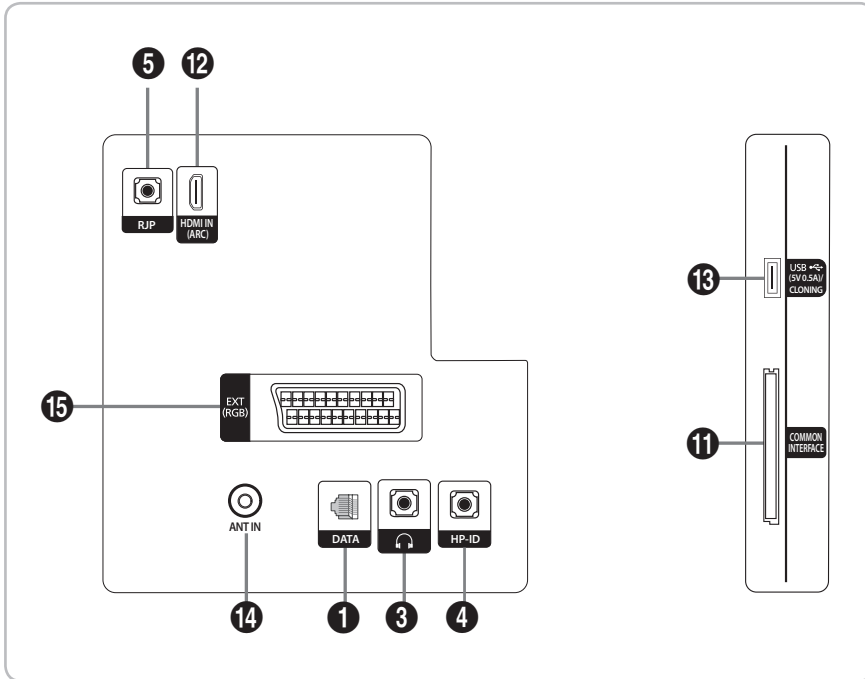

HG24EE470

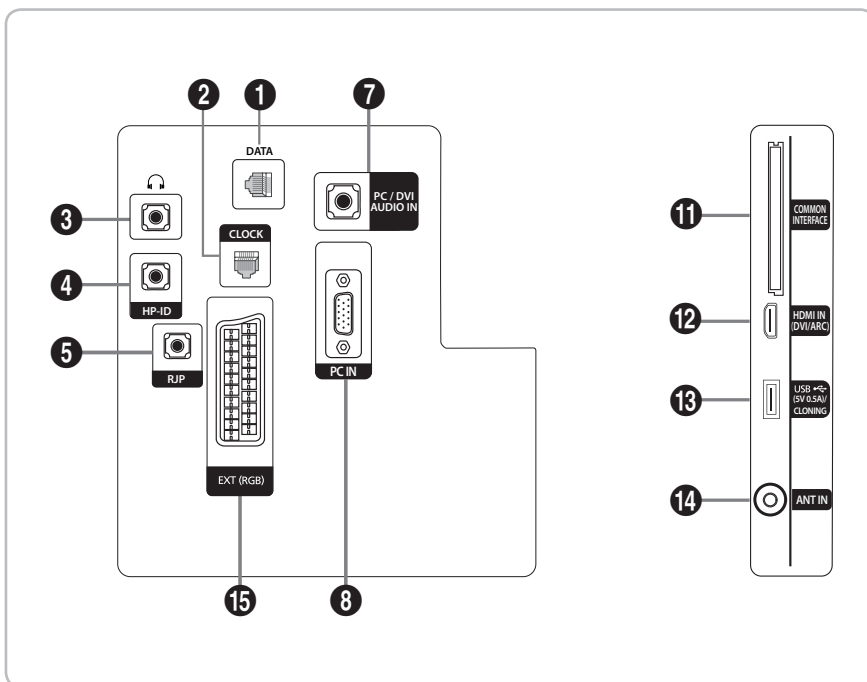

HG28EE470

HG32EE470

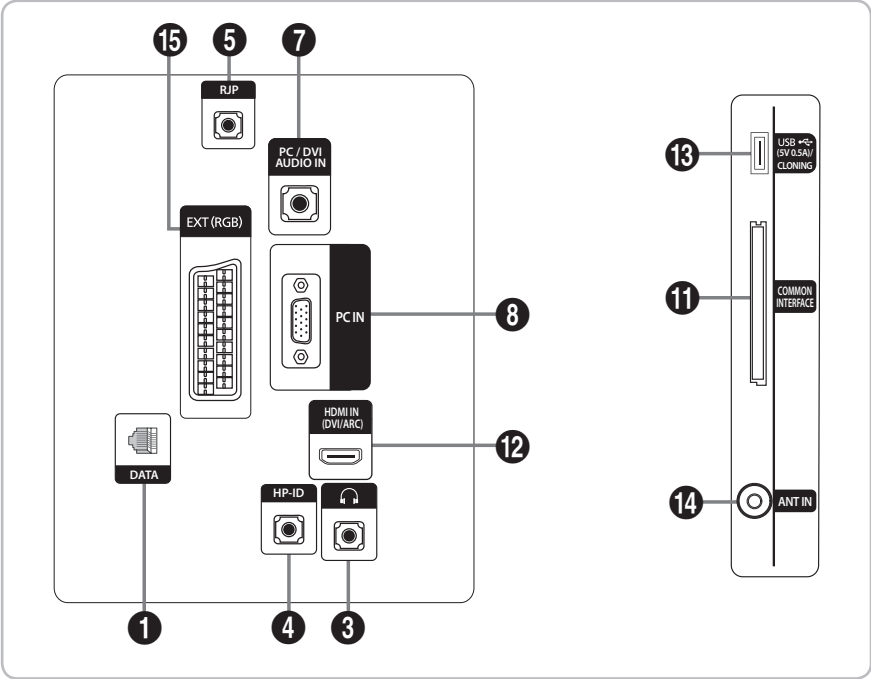

HG40EE470
HG48EE470

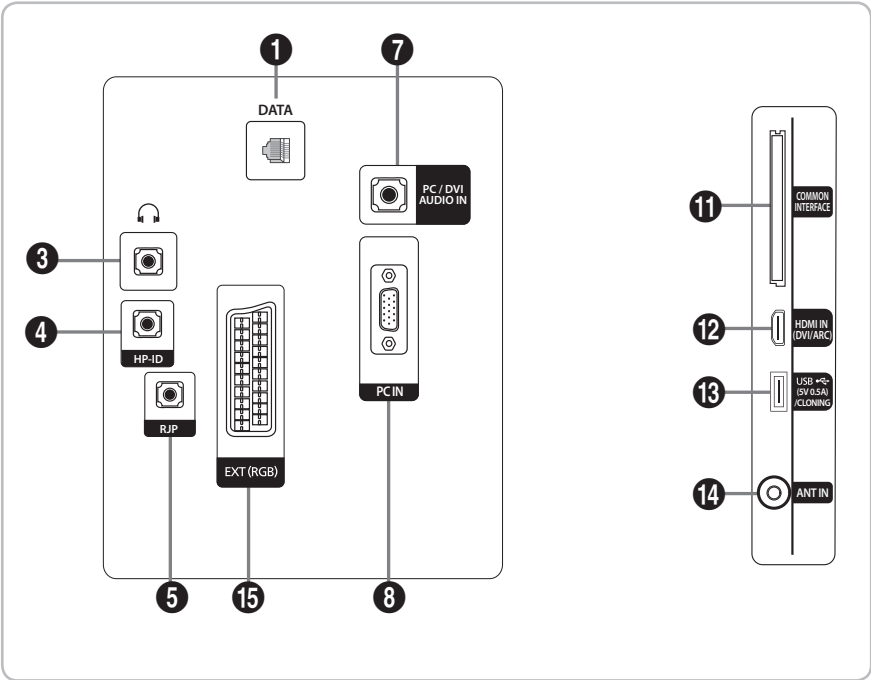

HG24EE460

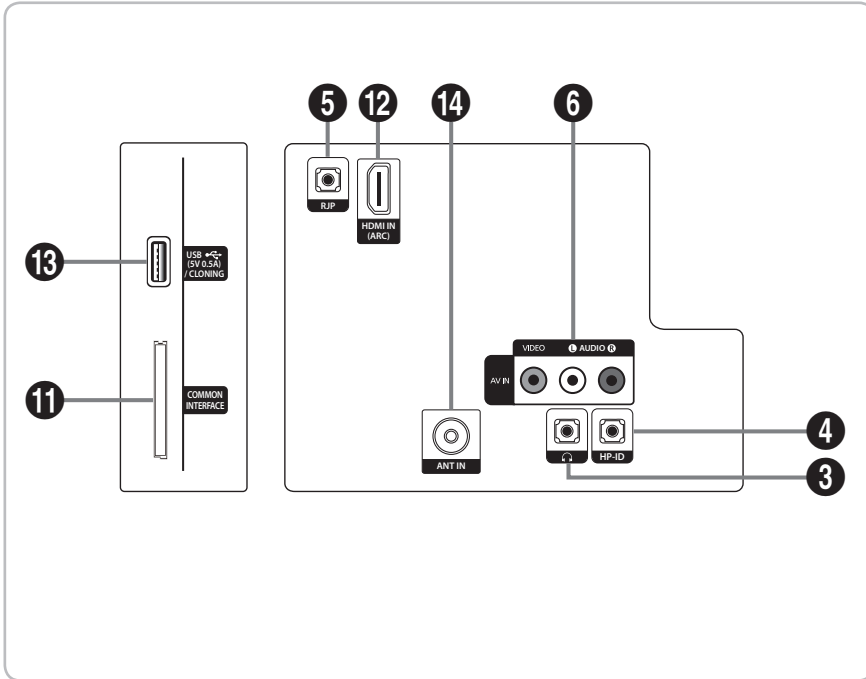

HG28EE460

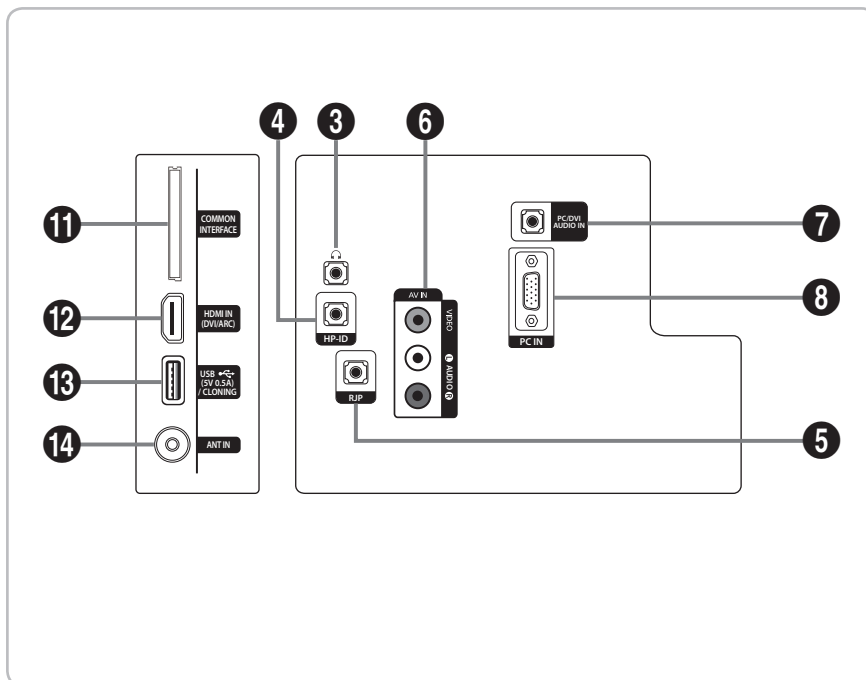

HG32EE460

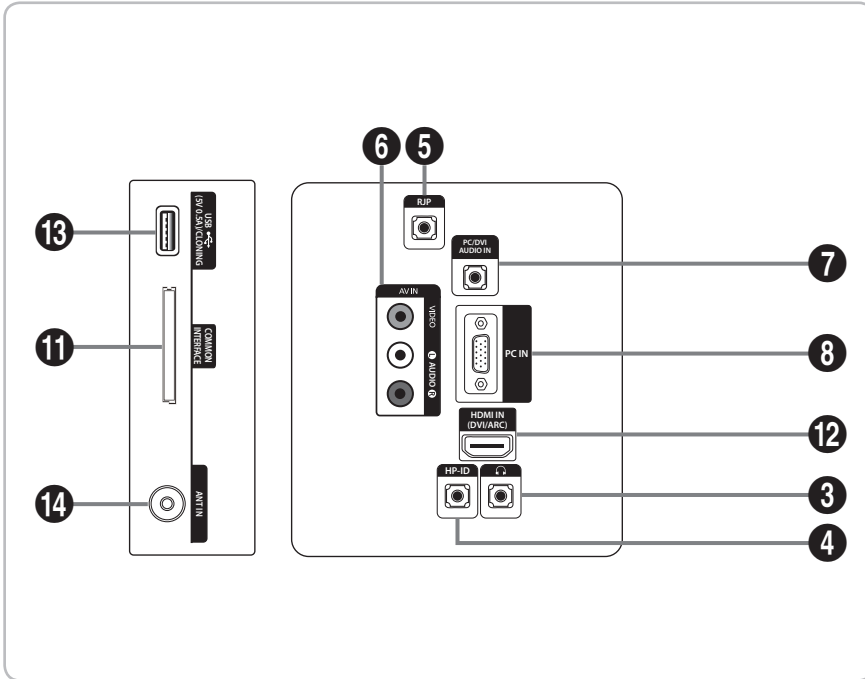

HG40EE460

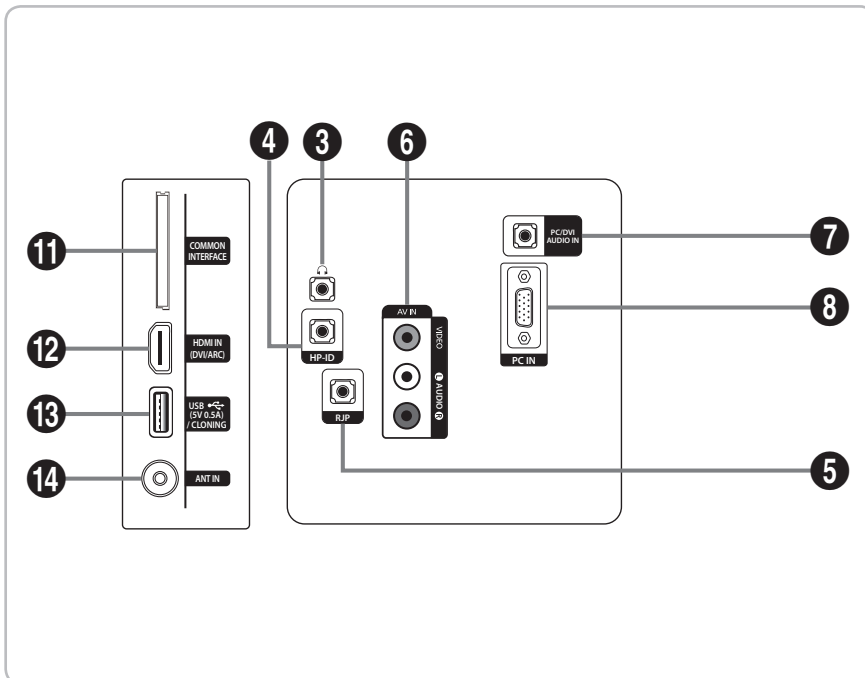

HG32EE670
HG40EE670
HG49EE670
HG55EE670

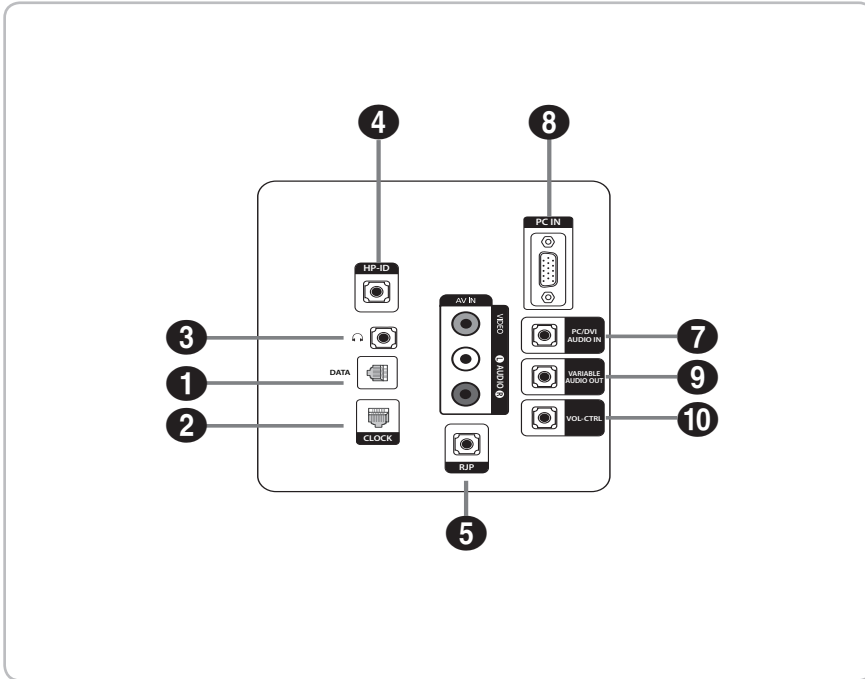

HG32AE460

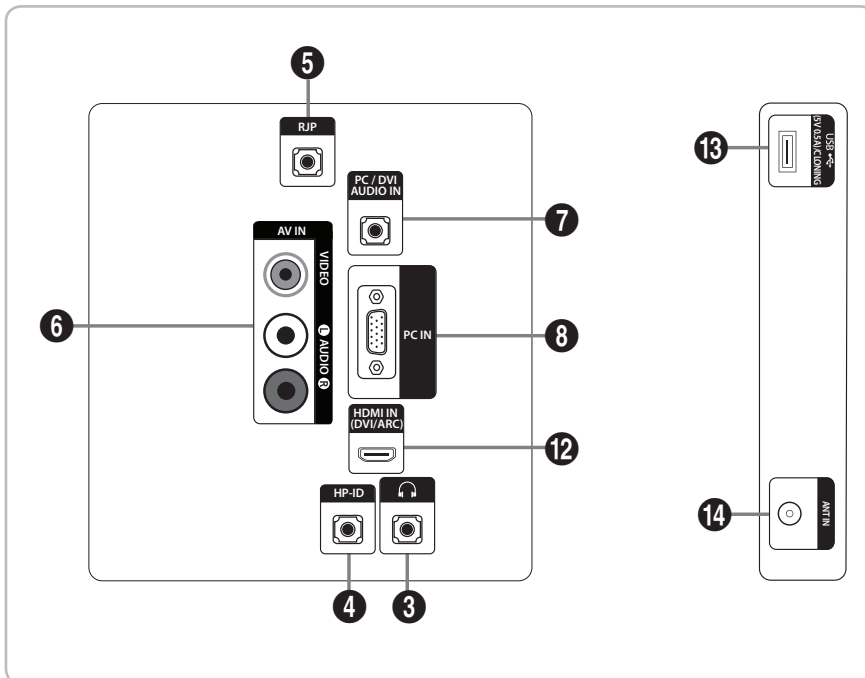

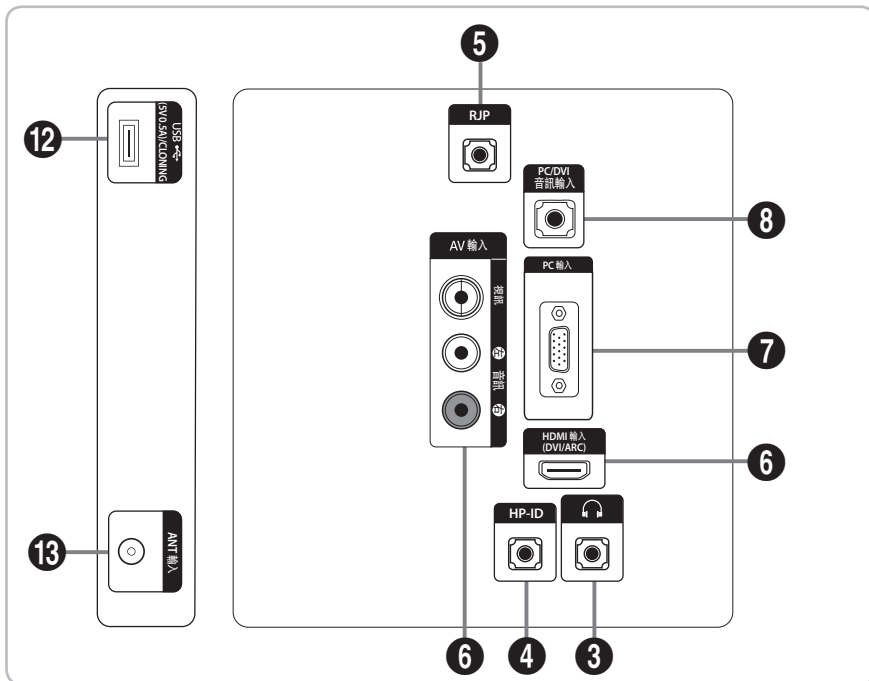

HG32AE460
(TAIWAN)

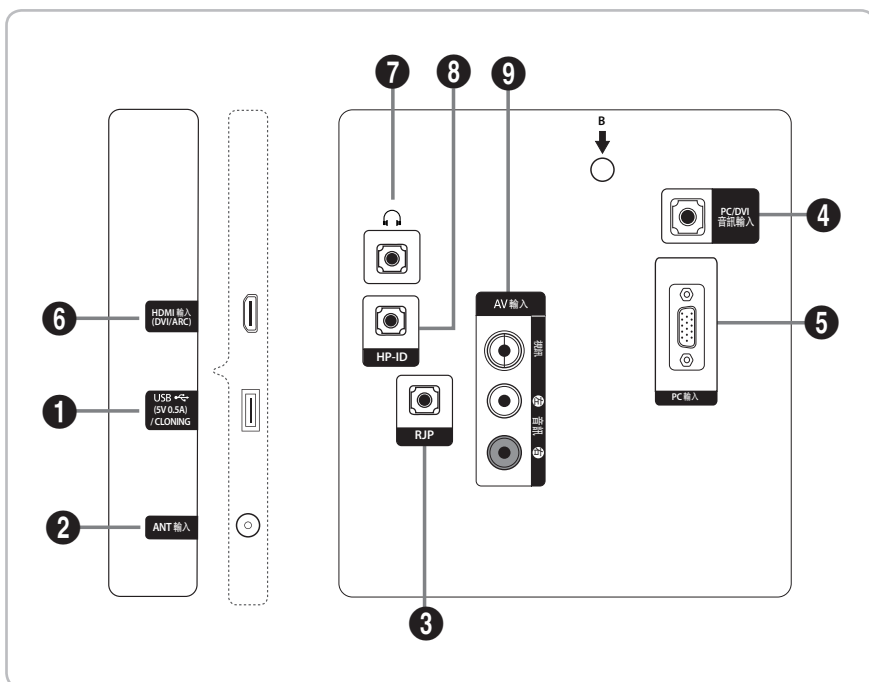

HG40AE460
(TAIWAN)

HG32AE570

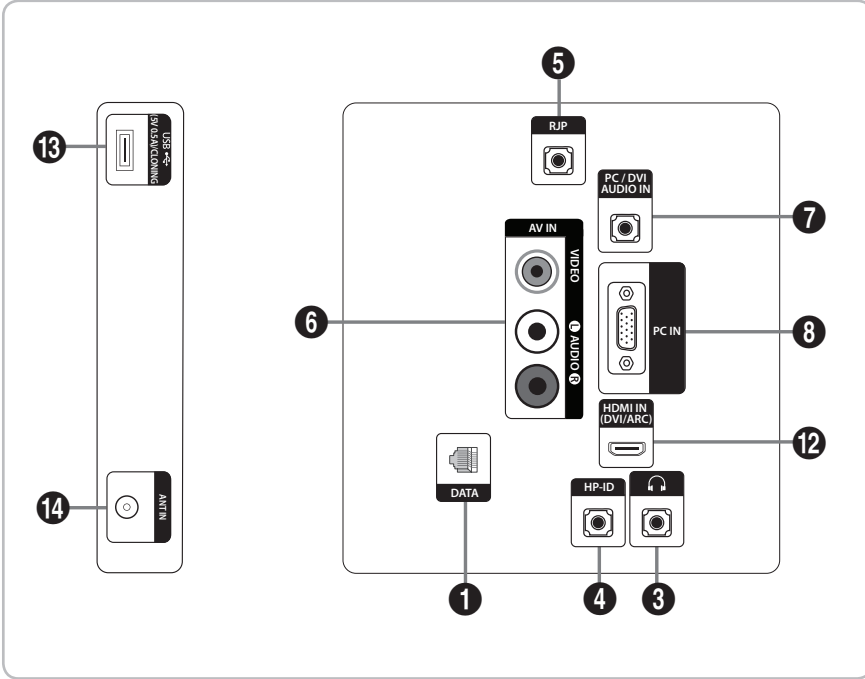

HG40AE570
HG43AE570
HG48AE570

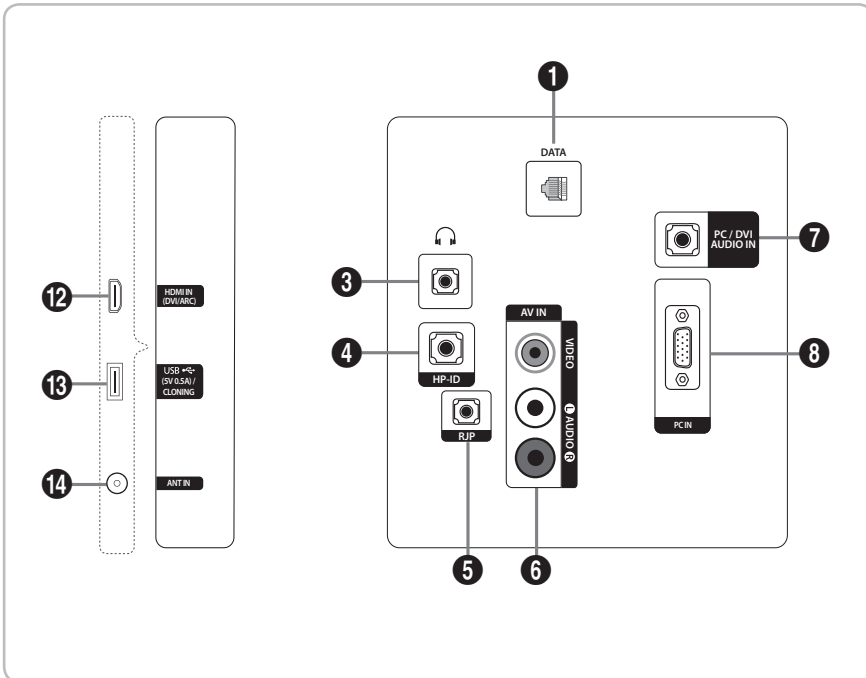

HG32AE570
 HG43AE570
 HG48AE570
 (HONGKONG)

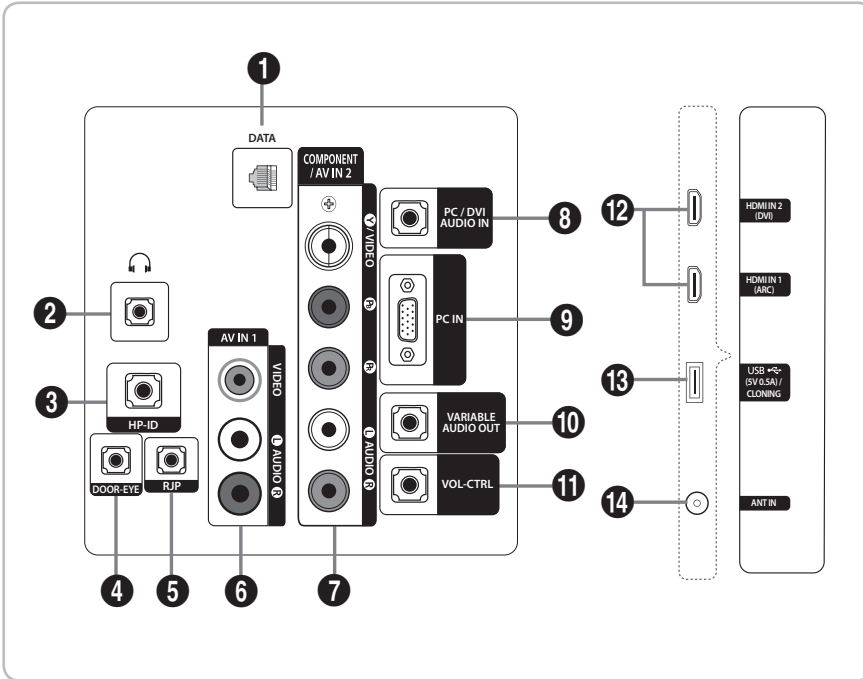

HG32AE570
 (CHINA)

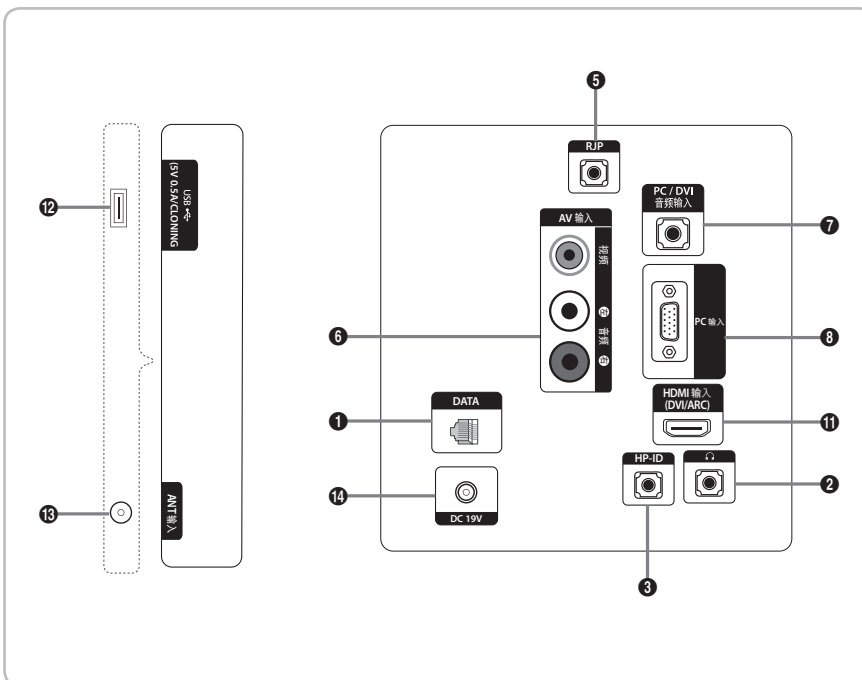

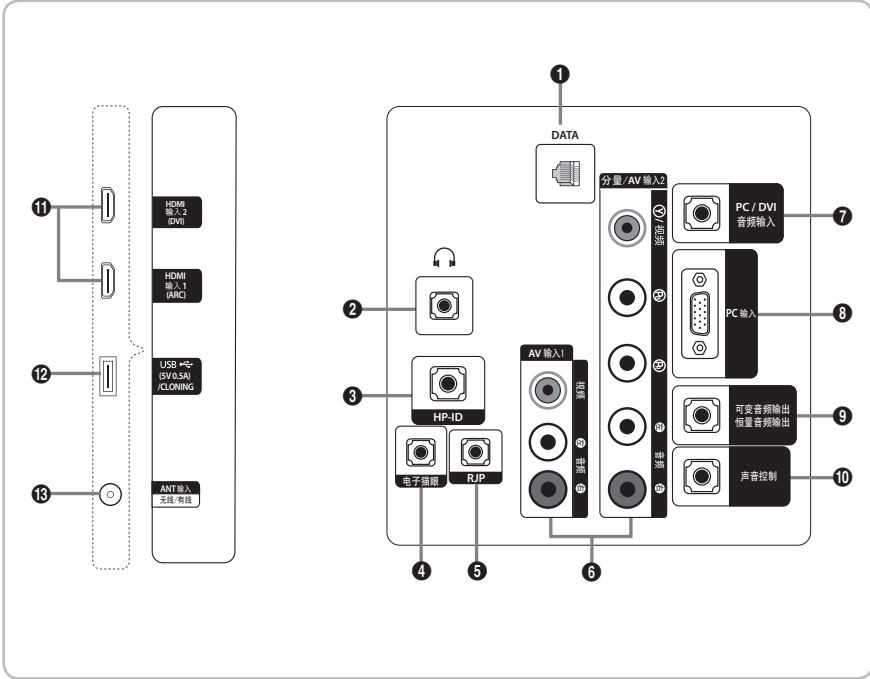

HG43AE570
 HG48AE570
 HG58AE570
 (CHINA)

🔧 Whenever you connect an external device to your TV, make sure that power on the unit is turned off.

🔧 When connecting an external device, match the colour of the connection terminal to the cable.

1 DATA

- Used to support data communication between the TV and the SBB.
- Connects using RJ-12 TV type plugs.

2 CLOCK

Set the time after connecting the cable of the External Clock to Clock jack. You can use the External Clock Display function.

3 HEADPHONE JACK

Headphones may be connected to the headphone jack on your TV. While the headphones are connected, the sound from the built-in speakers is disabled.

4 HP-ID

Connect the cable to HP-ID and Headphone Jack simultaneously and connect it to separated Headphone Box. See page 35. When connecting Headphone to Headphone Box, it works same as Headphone function.

5 RJP

This port is an RJP (Remote Jack Pack) communication port that enables connecting different devices to additional modules to improve device use and convenience.

6 AV IN / COMPONENT IN

- Connects the Component video / audio.
- Connect the component video cables (optional) to the component jacks ("PR", "PB", "Y") at the back of your TV and the other ends to the corresponding component video out jacks on the DVD.
- If you wish to connect both the Set-Top Box and the DVD player, you should connect the Set-Top Box to the DVD Player and connect the DVD Player to the component jacks ("PR", "PB", "Y") on your TV.
- The PR, PB and Y jacks on your component devices (DVD) are sometimes labeled Y, B-Y and R-Y or Y, Cb and Cr.
- Connect the RCA audio cables (optional) to [R - AUDIO - L] at the back of the TV set and the other ends to the corresponding audio out jacks on the DVD Player.

7 PC/DVI AUDIO IN

Connects to the audio input jacks on an Amplifier/Home Theater.

8 PC IN

Connect to the video output jack on your computer.

9 VARIABLE AUDIO OUT

Used for the audio output to the Bathroom speaker. Connect the Bathroom Wall Box and the Variable port (RCA).

10 VOL-CTRL

Used to control the volume of the Bathroom speaker. Connect the Bathroom Wall Box and the VOLCTRL port.

11 COMMON INTERFACE

12 HDMI IN (ARC), (DVI/ARC)

Connects to the HDMI jack of a device with an HDMI output.

- No sound connection is needed for an HDMI-HDMI connection. HDMI connections carry both audio and video.
- Use the HDMI IN (DVI) jack for a DVI connection to an external device. Use a DVI to HDMI cable or DVI-HDMI adapter (DVI to HDMI) for the video connection and the PC/DVI AUDIO IN jacks for audio.

13 USB (5V 0.5A) / CLONING

- Connector for software upgrades and Media Play, etc.
- Service connection.
- USB CLONING support 2.0 Standard only.

14 ANT IN (SATELLITE), (AIR/CABLE)

- To view television channels correctly, the TV must receive a signal from one of the following sources:
- An outdoor antenna / A cable television system

15 EXT (RGB)

- In **Ext.** mode, DTV Out supports MPEG SD Video and Audio only.

Display Modes

You can also select one of the standard resolutions listed in the Resolution column. The TV will automatically adjust to the resolution you choose.

After connecting a computer to the TV, set the screen resolution for the TV on the computer. The optimal resolution is 1920 x 1080 @ 60 Hz. If it is set to any other than in the table below, the TV may display nothing. Set the resolution properly, referring to the user guide of the computer or its graphic card.

The resolutions in the table are recommended.

 Optimal resolution is 1366 X 768 @ 60 Hz.

Mode	Resolution	Horizontal Frequency (KHz)	Vertical Frequency (Hz)	Pixel Clock Frequency (MHz)	Sync Polarity (H / V)
IBM	720 x 400	31.469	70.087	28.322	-/+
MAC	640 x 480	35.000	66.667	30.240	-/-
	832 x 624	49.726	74.551	57.284	-/-
	1152 x 870	68.681	75.062	100.000	-/-
VESA CVT/DMT	640 x 480	31.469	59.940	25.175	-/-
	640 x 480	37.861	72.809	31.500	-/-
	640 x 480	37.500	75.000	31.500	-/-
	800 x 600	37.879	60.317	40.000	+/+
	800 x 600	48.077	72.188	50.000	+/+
	800 x 600	46.875	75.000	49.500	+/+
	1024 x 768	48.363	60.004	65.000	-/-
	1024 x 768	56.476	70.069	75.000	-/-
	1024 x 768	60.023	75.029	78.750	+/+
	1152 x 864	67.500	75.000	108.000	+/+
	1280 x 720	45.000	60.000	74.250	+/+
	1280 x 800	49.702	59.810	83.500	-/+
	1280 x 1024	63.981	60.020	108.000	+/+
1280 x 1024	79.976	75.025	135.000	+/+	
1366 x 768	47.712	59.790	85.500	+/+	

🔗 Optimal resolution is 1920 X 1080 @ 60 Hz.

Mode	Resolution	Horizontal Frequency (KHz)	Vertical Frequency (Hz)	Pixel Clock Frequency (MHz)	Sync Polarity (H / V)
IBM	720 x 400	31.469	70.087	28.322	-/+
MAC	640 x 480	35.000	66.667	30.240	-/-
	832 x 624	49.726	74.551	57.284	-/-
	1152 x 870	68.681	75.062	100.000	-/-
VESA CVT	720 x 576	35.910	59.950	32.750	-/+
	1152 x 864	53.783	59.959	81.750	-/+
	1280 x 720	56.456	74.777	95.750	-/+
	1280 x 960	75.231	74.857	130.000	-/+
VESA DMT	640 x 480	31.469	59.940	25.175	-/-
	640 x 480	37.861	72.809	31.500	-/-
	640 x 480	37.500	75.000	31.500	-/-
	800 x 600	37.879	60.317	40.000	+/+
	800 x 600	48.077	72.188	50.000	+/+
	800 x 600	46.875	75.000	49.500	+/+
	1024 x 768	48.363	60.004	65.000	-/-
	1024 x 768	56.476	70.069	75.000	-/-
	1024 x 768	60.023	75.029	78.750	+/+
	1152 x 864	67.500	75.000	108.000	+/+
	1280 x 1024	63.981	60.020	108.000	+/+
	1280 x 1024	79.976	75.025	135.000	+/+
	1280 x 720	45.000	60.000	74.250	+/+
	1280 x 800	49.702	59.810	83.500	-/+
	1280 x 800	62.795	74.934	106.500	-/+
	1360 x 768	47.712	60.015	85.500	+/+
1440 x 900	55.935	59.887	106.500	-/+	
1440 x 900	70.635	74.984	136.750	-/+	
1680 x 1050	65.290	59.954	146.250	-/+	
VESA GTF	1280 x 720	52.500	70.000	89.040	-/+
	1280 x 1024	74.620	70.000	128.943	-/-
VESA DMT / DTV CEA	1920 x 1080p	67.500	60.000	148.500	+/+

🔗 When using an HDMI/DVI cable connection, you must use the HDMI IN (DVI) jack. (HG24EE470/460 is not support)

🔗 The interlace mode is not supported.

🔗 The set might operate abnormally if a non-standard video format is selected.

🔗 Separate and Composite modes are supported. SOG is not supported.

Using the TV's Controller

The TV Controller, which is a small joystick like button at the right back of the TV, lets you control the TV without the remote control.

There are two kinds of the TV Controller.

This is the first.

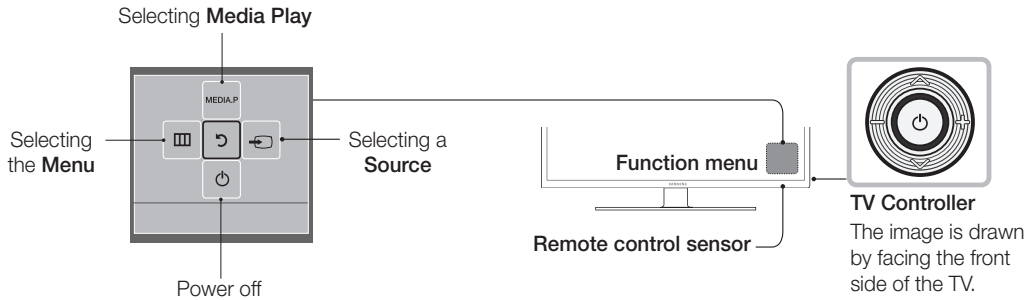

- 🔗 Some functions which require a PIN code may not be available.
- 🔗 The product colour and shape may vary depending on the model.
- 🔗 Exits the menu when pressing the controller for longer than 1 second.
- 🔗 When selecting the function by moving the controller in the up/down/left/right directions, be sure not to press the controller. If you press it first, you cannot move it in the up/down/left/right directions.

This is the second.

Turn on the TV using the  button on the remote control or TV panel.

- 🔗 The TV's Controller at the right bottom of the TV, lets you control the TV without the remote control.
- 🔗 If you press it first, the control menu appears. You can select the function by pressing and holding the TV's controller.
- 🔗 The product colour and shape may vary depending on the model.
- 🔗 With the TV's Controller, you cannot perform other operations except for turning the TV on or off, changing the channel, adjusting the volume, and switching the input source.

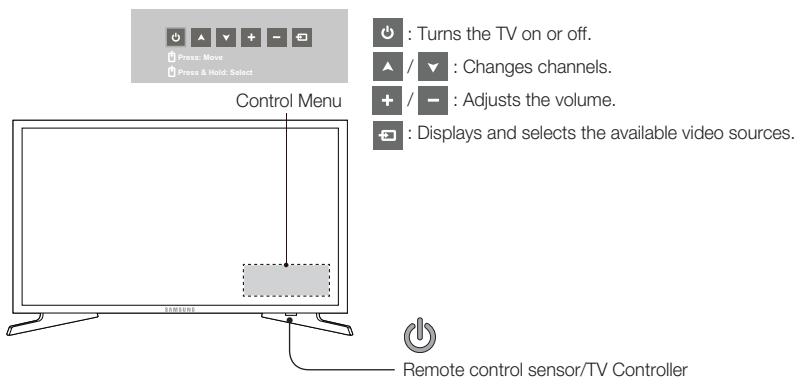

Standby mode

Your TV enters Standby mode when you turn it off and continues to consume a small amount of electric power. To be safe and to decrease power consumption, do not leave your TV in standby mode for long periods of time (when you are away on vacation, for example). It is best to unplug the power cord.

Viewing the Remote Control

- This remote control has Braille points on the **Power**, **Channel**, and **Volume** buttons and can be used by visually impaired persons.

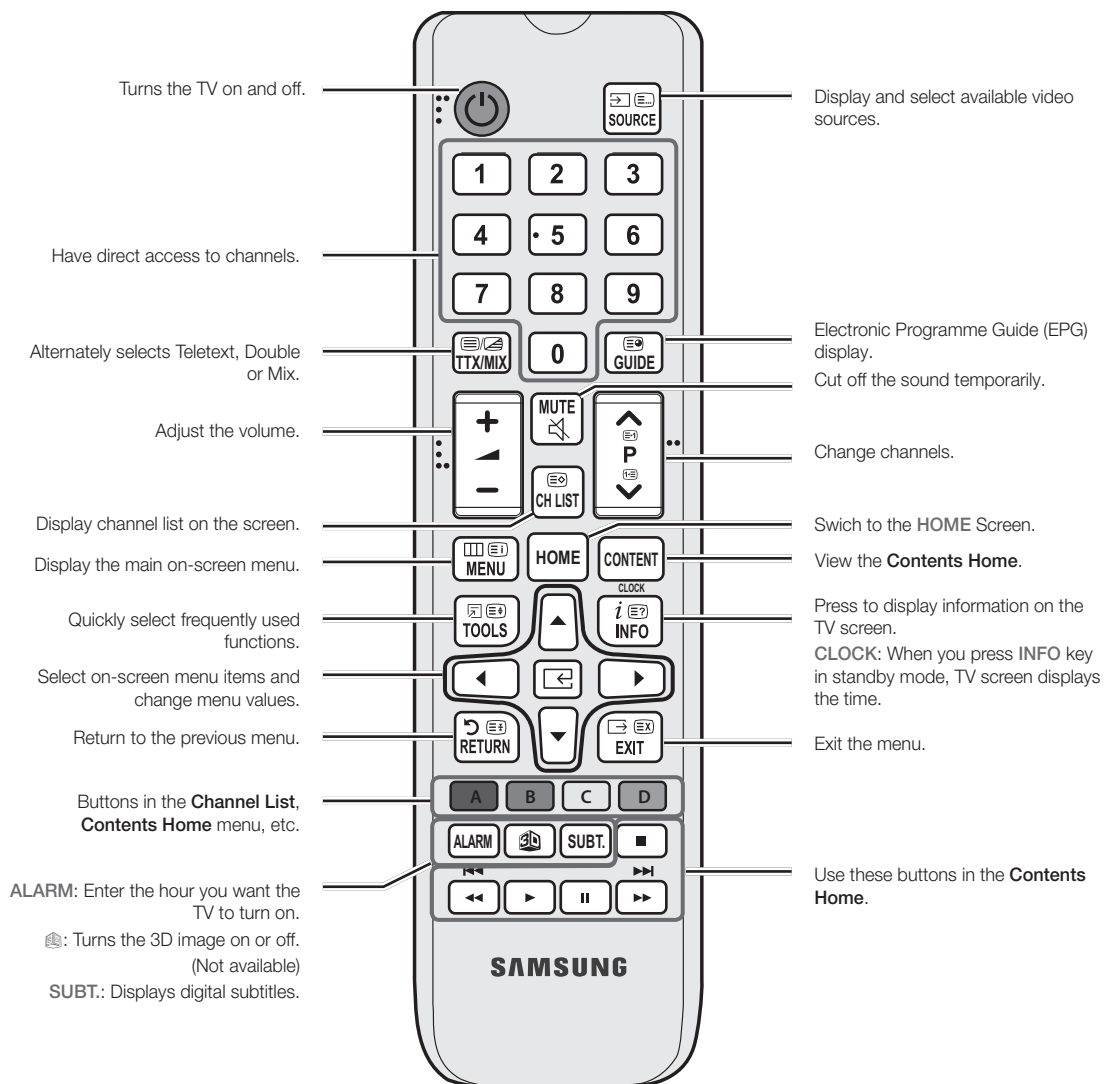

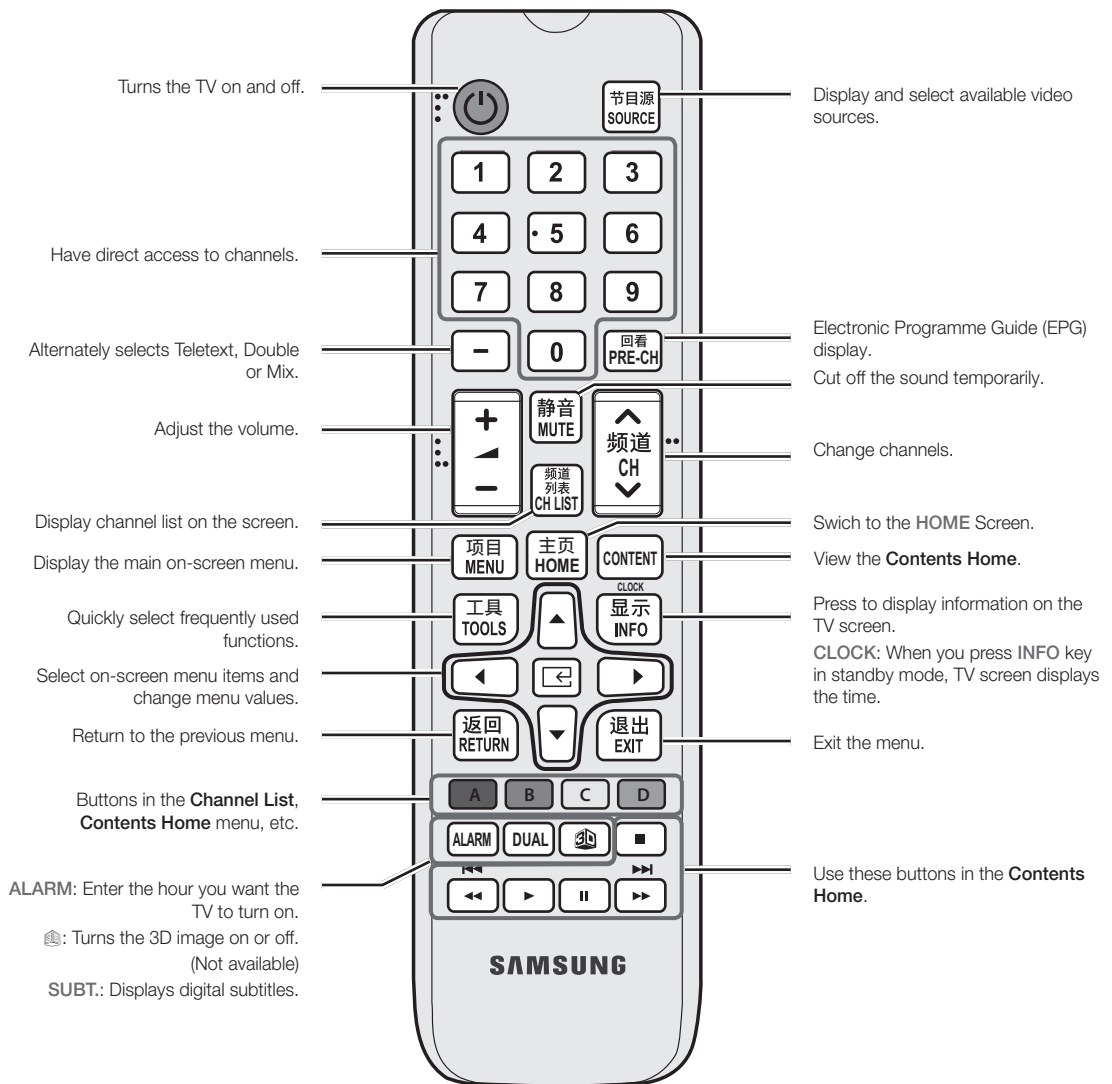

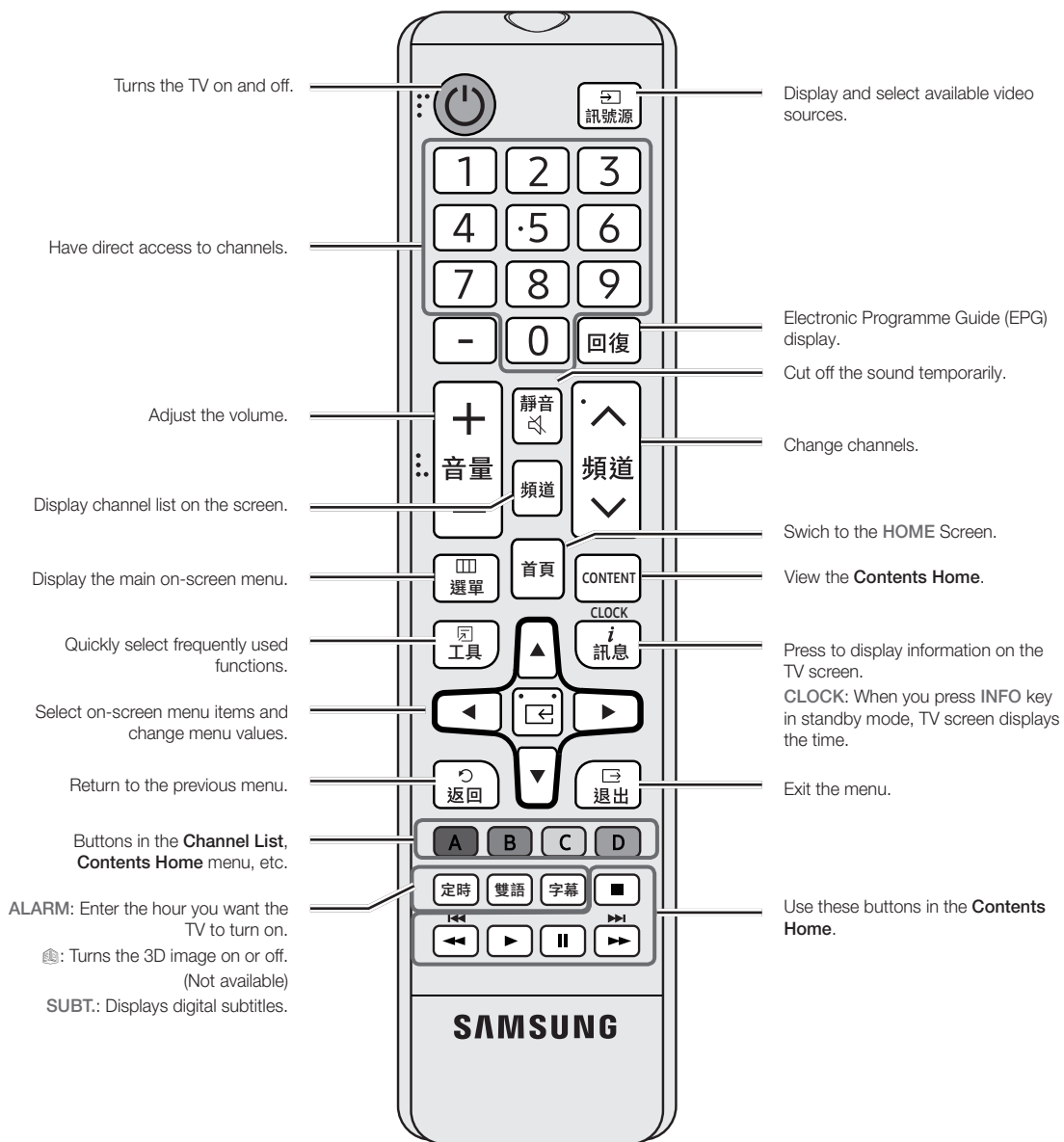

Installing batteries (Battery size: AAA)

Rear of the Remote

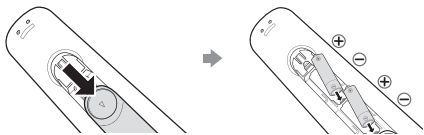



After you have installed the batteries, use a screwdriver to screw in the screw that holds the battery cover closed.

NOTE



- Use the remote control within 23 feet of the TV.
- Bright light may affect the performance of the remote control. Avoid using nearby special fluorescent light or neon signs.
- The colour and shape may vary depending on the model.
- Remote control button '3D' are not supported. When pressing these buttons, the TV unit does not respond.

Using the Sports Mode

Sports Mode

 MENU  → Applications → Sports Mode → ENTER 

This mode provides optimized condition for watching sports games.

- **A (Zoom)**: Pause playback and divide the picture into 9 parts. Select a part to zoom it in. Press this button again to resume.
 -  When the **Sports Mode** is **On**, the picture and sound modes are set to **Stadium** automatically.
 -  If you turn the TV off while watching **Sports Mode**, the **Sports Mode** will be disable.
 -  When the **Data Service** is running, the **Zoom** is not available.

Connecting the TV with SBB

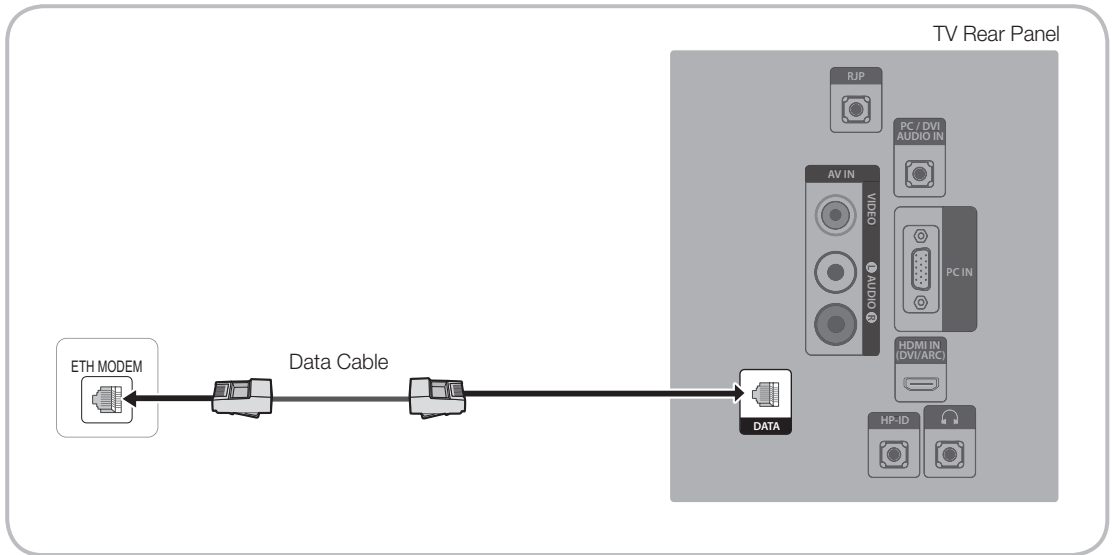

Availability depends on the specific model.

1. Connect the **DATA** jack of the TV to the [ETH MODEM] jack of the STB (SBB) with the Data cable.
 - Use data communication.

List of Vendors and Compatible Data Cables Supplied with the TV

- Confirm that you are using the correct data cable for your vendor. Refer to the code label on the data cables.

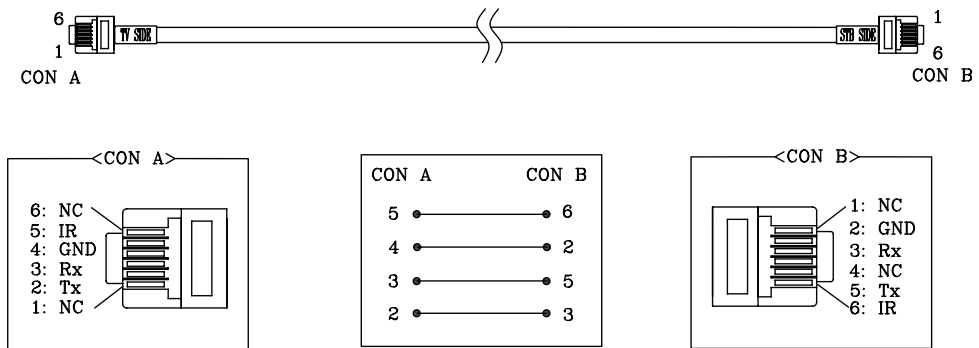

📎 Operation Specification of Data Cable(RJ12) : RS232

Connecting the Bathroom Speakers

You can connect the Bathroom Speakers using the following method. (Depending on the region)

Connecting through the Variable Output (available without an external amplifier)

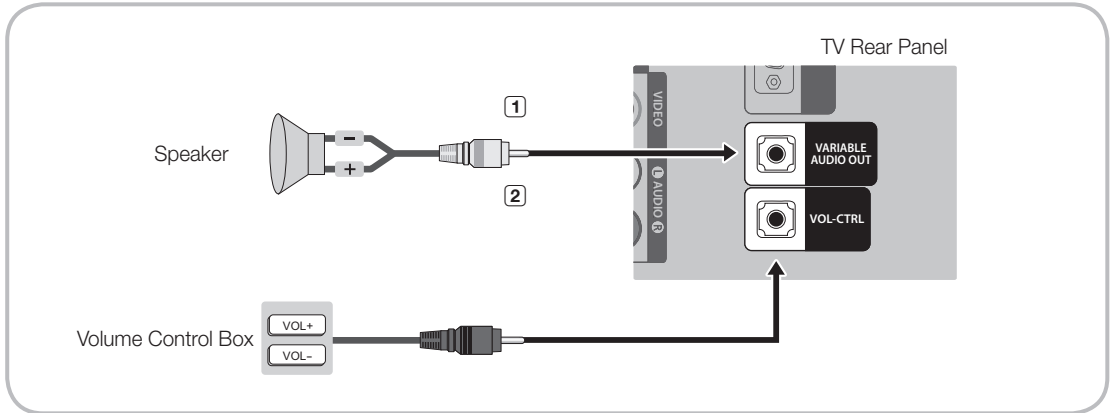

1. Connect the **VARIABLE AUDIO OUT** port of the TV to the Bathroom Wall Speakers of the hotel.

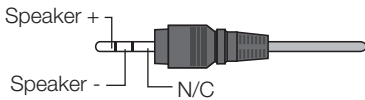

2. Connect the **VOL-CTRL** jack of the TV to the Volume Control Box Switch port on the Bathroom Wall of the hotel.

✎ The maximum speaker output is 4W, 8Ω.

✎ The **VARIABLE AUDIO OUT** port supports **MONO** sound out only.

- Installing the Volume Control

- If you configure the Volume Control Box as shown in the figure, you can control the volume of the bathroom speakers.

- The jack that is connected from the Volume Control Box to the TV is a 3.5mm normal Phone jack.

- The Volume Control Box switch consists of a Tact switch.

- ✎ Setting the Sub AMP Mode.

- **0**: Turns the Sub AMP function off (PWM off).

- **1**: Determines the Sub volume according to the main volume control. That is, the sub volume is determined according to the Power On Volume, the Min Volume, and the Max Volume values of Hotel Mode.

- **2**: Determines the volume according to the bathroom control panel setting.

- Variable Output Port Specifications

- **Speaker Wire**: Use a speaker cable no longer than 82 feet (25m).

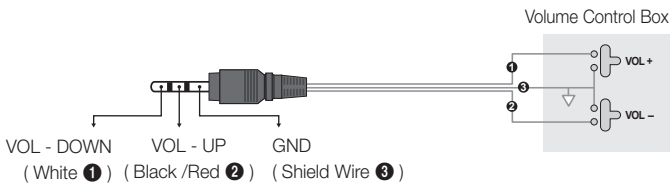

HP-ID

An additional Headphone Box can be installed on a bed or business desk for added convenience. The installation procedures are given below.

- Detailed Drawing of the Headphone Box.

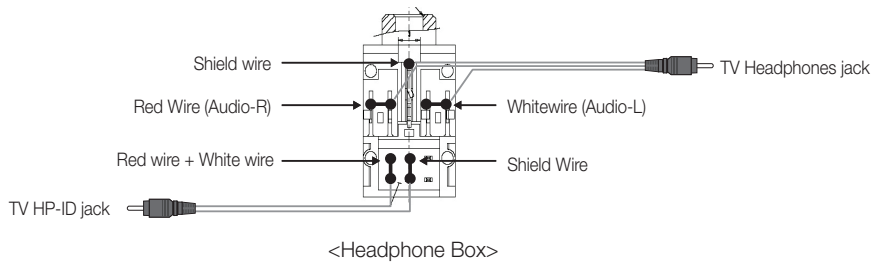
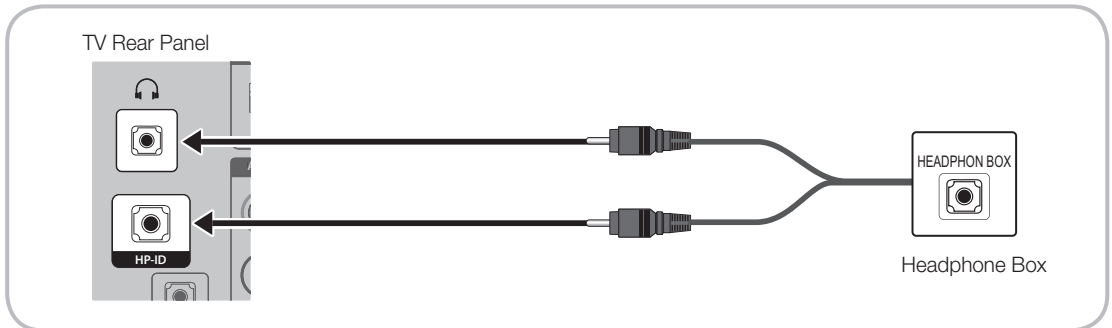

Connecting the MediaHub HD

Output to any external source connected to MediaHub HD on the hotel desk.

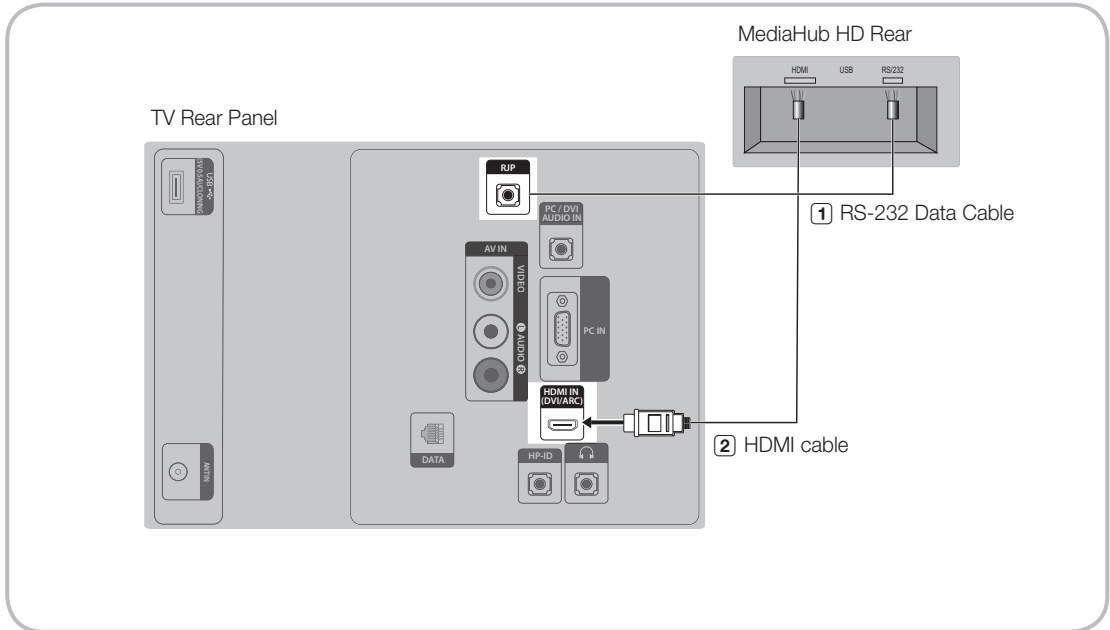

 Availability depends on the specific model.

1. Connect the RJP port of the TV and the RS/232 port of the MediaHub HD.
2. Connect the HDMI IN port of the TV and the HDMI port of the MediaHub HD.

- MediaHub HD

- The MediaHub HD is a hardware module that has different Audio Video inputs (A/V, Audio, PC, HDMI and USB) and corresponding outputs. The corresponding output sources connect from MediaHub to the TV. MediaHub communicates with the TV via RS232. Hot Plug & Play is a function that allows hotel guests to connect an external source to the MediaHub. MediaHub communicates with the TV by sending messages regarding Active/Inactive sources. The TV switches to the Active external source.
- You have to connect the HDMI of the MediaHub to the **HDMI IN** port of the TV.
- When the TV is on, connect the TV and the RJP within 10 seconds.

- Special features

- PIP
- Auto Detection

Connecting the RJP (Remote Jack Pack)

Output to any external source connected to RJP on the hotel desk.

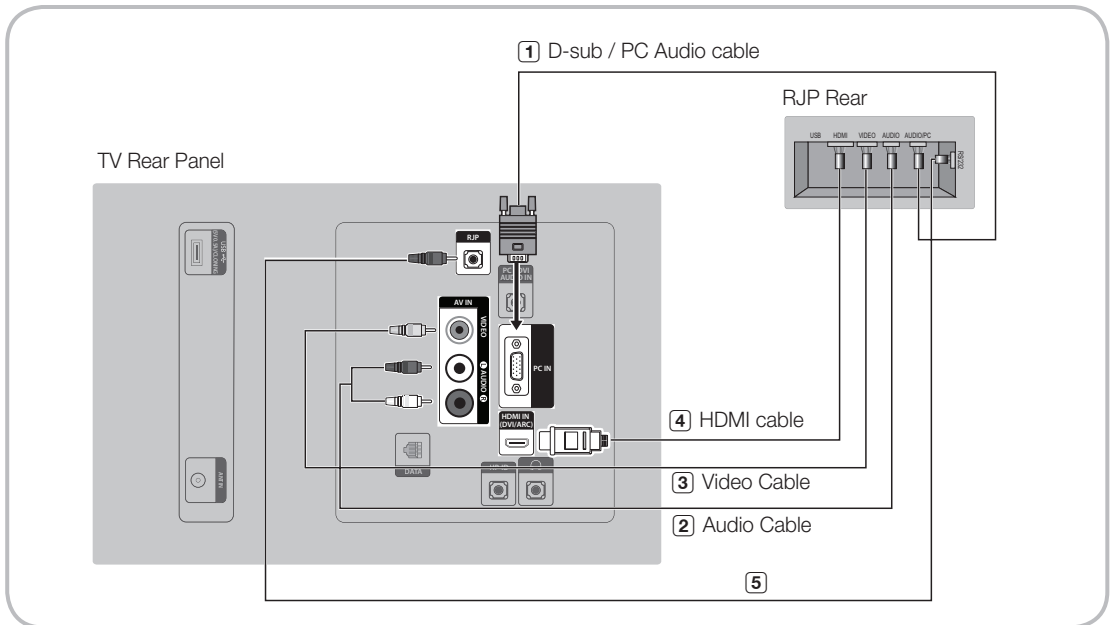

Availability depends on the specific model.

1. Connect the **PC IN / PC/DVI AUDIO IN** port of the TV to the **PC/AUDIO** port of the RJP.
2. Connect the **AV IN [VIDEO] / [L-AUDIO-R]** port of the TV to the **VIDEO** port of the RJP.
3. Connect the **AV IN [VIDEO]** port of the TV to the **VIDEO** port of the RJP.
4. Connect the **HDMI IN** port of the TV and the **HDMI** port of the RJP.
5. Connect the **RJP** port of the TV and the **RS/232** port of the RJP.

The RJP (Remote Jack Pack) compatible with this Samsung TV is TeleAdapt TA-7610.

- **RJP (Remote Jack Pack):** RJP stands for Remote Jack Pack. The RJP is a hardware module that has different Audio Video inputs (A/V, Audio, PC and HDMI) and corresponding outputs. The corresponding output sources are connected from the RJP to the TV. The RJP communicates with the TV via RS232. The Hot Plug & Play function allows hotel guests to connect an external source to the RJP. The RJP communicates with the TV by sending messages regarding Active/Inactive sources. The TV will switch to the Active external source according to the priority set by the User.

You can select **HDMI IN** and **AV IN** for connecting the RJP.

When the TV is on, connect the TV and the RJP within 10 seconds.

- The RJP can be returned to the factory default settings by pressing the AV and HDMI buttons simultaneously for 10 seconds. All LEDs blink 5 times to acknowledge that this has been finished.
- The RJP will automatically turn off any LEDs after 5 minutes to avoid unnecessary light pollution in the hotel room. The LEDs that were turned off will turn on again if the guest touches any of the buttons and the 5 minute timer will restart. If the guest then touches another source button, the TV will change to the selected source and the corresponding LED will be lit.
- After an RJP Reset or a TV Power OFF/ON, it takes approx. 10 seconds to establish communications between the TV and the RJP.
- The following table shows the approximate time in seconds to switch from the TV to the input source, based on the priority.

📎 Scenario 1: When no inputs are connected.

Source	To Connect
AV	2 Sec
PC	0.7 Sec
HDMI	3.9 Sec

📎 Scenario 2: When two or more inputs are connected and an Input source is disconnected and then reconnected.

Source	Disconnect	To Connect	Total
AV	4.5 Sec	2 Sec	6.5 Sec
PC	0.7 Sec	0.7 Sec	1.4 Sec
HDMI	3.9 Sec	3.9 Sec	7.8 Sec

📎 E.g. If the RJP has all its live sources AV, PC and HDMI connected, AV is viewed as the highest priority. If the RJP is in HDMI mode, and a guest removes and reconnects the AV, the minimum time required to switch to the AV is 6.5 seconds.

- To connect audio (Ipod or Mp3), Music mode should be ON and Jack Ident detect should be OFF.
- AV, PC and HDMI input sources are supported.

Setting the Hotel Option Data

To Enter: Press the MUTE → 1 → 1 → 9 → ENTER  buttons in order. (From the Hospitality mode, the Standalone mode is set.)

To Exit from this menu: power off and turn on again.

No	Hotel TV Function			Description
	Category	Item	Initial value	
1	Hospitality Mode	Hospitality Mode	Standalone	<ul style="list-style-type: none"> Select Hospitality Mode. Interactive mode: TV works with an SI STB or SBB. Standalone mode: TV works alone, without an SI STB or SBB.
2	SI Vendor	SI Vendor	OFF	<ul style="list-style-type: none"> Interactive mode: Samsung / 2M / Locatel / VDA / VDA-S / Acentic / Sustinere / Quadriga / ETV / Ibahn / Magilink / Otrum / Siemens / Amino / MDC / Enseco Standalone mode: OFF / Movielink / Swisscom / Smoovie / SSCP
3	Power On	Power On Channel	Last Saved	<p>Set the default values that will be applied when the TV is turned on.</p> <ul style="list-style-type: none"> User Defined: Lets you set Power On Channel and Channel Type manually. See Power On Channel Number and Channel Type below. Last Saved: If you select this item, when the TV is turned on, it displays the channel it was displaying when it was turned off.
		Power On Channel Num	...	When the TV is turned on, it switches automatically to this channel.
		Power On Channel Type	...	<ul style="list-style-type: none"> Select channel band: ATV (analog air band), DTV (digital air band), CATV(analog cable band), CDTV (digital cable band)
		Power On Volume	Last Saved	<ul style="list-style-type: none"> User Defined: Lets you set the Power On Volume manually. See Power On Volume Number below. Last Saved: When the TV is turned on, it returns to the volume that had been set when the power had been turned off.
		Power On Volume Num	...	The TV turns on with this Volume Level.
		Min Volume	0	The minimum Volume Level the user can set in Stand Alone Hospitality mode.
		Max Volume	100	The maximum Volume Level the user can set.
		Power On Source	TV	Select the input source the TV displays when turns on.
4	Channel	Channel Setup	...	Gives you direct, immediate access to some of the Channel menu functions on the user Channel menu such as Auto Tuning, Manual Tuning, Antenna setting, etc.
		Channel Editor	...	<p>The Channel Editor lets you edit the channels stored in the TV's memory. Using Channel Editor you can:</p> <ul style="list-style-type: none"> Change the channel numbers and names, and sort the channels in your desired channel number order. Apply the video mute to channels you select. The video mute blanks out the video from a channel and outputs only the sound while displaying a speaker icon on the screen. The Channel Editor also lets you view information about each channel easily, without your having to display each channel directly.
		Mixed Channel Map	ON	<p>This Feature enables showing/browsing all antenna type (Air/Cable or Satellite) channels at the same time.</p> <ul style="list-style-type: none"> ON: When ON, guests can access the complete Channel Map irrespective of the selected antenna type. The Channel list will also populate Air as well Cable type channels. OFF: When OFF, guest can access the Channel Map corresponding to the selected antenna type [Air/Cable or Satellite] only. The Channel list/Editor will only show the selected antenna type channels.
		Dynamic SI	OFF	<ul style="list-style-type: none"> ON: Check the DTV Programme channel number. (the DTV channel editor is inaccessible) OFF: Do not check the DTV Programme channel number. (the DTV channel editor is accessible, but additional channel Programme number update is not supported)

No	Hotel TV Function			Description
	Category	Item	Initial value	
4	Channel	Channel Rescan Message	ON	When there is a mismatch between the data in the channel map and the transmitted data , the TV autotunes the channels to restore the data/parameters in the channel map. <ul style="list-style-type: none"> ON: When Channel Rescan Message is ON, The OSD showing that the channels are being rescanned will be displayed to Hotel Guests. OFF: A Hotel Admin can turn the Channel Rescan Message OFF, if the rescan message OSD should not to be displayed to Hotel Guests.
		Pan Euro MHEG	OFF	<ul style="list-style-type: none"> OFF: If Pan Euro MHEG is set to Off, MHEG runs according to the existing product specifications. ON: If Pan Euro MHEG is set to On, MHEG is ON regardless of the product specifications or region.
		My Channel	OFF	Enable or disable the Mychannel feature.
		Genre Editor	...	Edit the genre for channels. (Available when Mychannel is On)
		Subtitle Auto On	OFF	This function turns the function On/Off that automatically turns on the subtitles in a specific country. This function is supported for Hotel TVs that are ready to receive DVB broadcasts that is heading to Europe. This function is related to France's subtitle specification. The rest of the countries' subtitles function according to the appropriate country specifications regardless of the Subtitle Auto On function. <ul style="list-style-type: none"> ON: When the Subtitle Auto On function is ON, it follows France's subtitle specifications. OFF: When the Subtitle Auto On function is OFF, it does not follow France's subtitle specifications.
		TTX Widescreen Mode	OFF	<ul style="list-style-type: none"> ON: TTX information widescreen display. OFF: TTX information normally display.
5	Menu OSD	Picture Menu Lock	OFF	Enable or disable the Picture Menu.
		Menu Display	ON	<ul style="list-style-type: none"> ON: The Main Menu is displayed. OFF: The Main Menu is not displayed.
		Tools Display	ON	<ul style="list-style-type: none"> ON: The Tools Menu is displayed. OFF: The Tools Menu is not displayed.
		Channel Menu Display	OFF	<ul style="list-style-type: none"> ON: The Channel Menu is displayed. OFF: The Channel Menu is not displayed.
		Panel Button Lock	Unlock	Turning the front panel (local key) operations on/off. <ul style="list-style-type: none"> Unlock: Unlocks all panel keys. Lock: Locks all panel keys. OnlyPower: Locks all panel keys except the Power panel key. Menu/Source: Locks the Menu and Source panel keys.
		Home Menu Display	ON	OFF: The Home Menu is not displayed. ON: The Home Menu is displayed.
		Home Menu Editor	...	Edit Home Menu.
		Home Menu Auto Start	...	ON: The Home Menu is Auto Start. OFF: The Home Menu is not Auto Start.
6	Clock	Clock Type	OFF	Select the clock type (OFF/SW Clock/Ext. Clock) <ul style="list-style-type: none"> OFF: No clock options of the Hotel options will work. SW Clock: Only the SW clock will work. Ext. Clock: LED Clock related item work as Dimming/Clock test/Time Format.
		Local Time	Manual	Select the way to update clock data. Use clock data from a DTV channel to set the clock automatically or set the clock manually when the TV is in stand-alone mode.
		Timer Type	Wakeup	<ul style="list-style-type: none"> Wakeup : you can set a specific time for the TV to turn on automatically. OnOff : Have you TV turn itself on/off automatically at a specified time. you can set three Times the most at the same time.
		Time Channel Type	...	Use clock data from which DTV channel to set the clock.
		Time Channel Num	...	DTV channel Number.

No	Hotel TV Function			Description
	Category	Item	Initial value	
7	Music Mode	Music Mode AV	OFF	To get music output from an mp3/audio player through an AV Input Source. When on, you can hear sound from the player through the TV even there is no video signal. The TV's backlight, however, remains on. And add a video signal, it works normally.
		Music Mode PC	OFF	To get music output from an mp3/audio player through a PC Input Source. When on, you can hear sound from the player through the TV even there is no video signal. The TV's backlight, however, remains on. And add a video signal, it works normally.
		Music Mode Backlight	OFF	Backlight On/Off option in Music mode to save energy.
8	Remote Jack Pack	Priority AV	1	If the jack priority is set, the corresponding source is automatically set when a jack is inserted according to the jack priority.
		Priority PC	2	If the jack priority is set, the corresponding source is automatically set when a jack is inserted according to the jack priority.
		Priority HDMI	3	If the jack priority is set, the corresponding source is automatically set when a jack is inserted according to the jack priority.
		AV Option	AV	Select RJP AV Source (Source selection depends on Model).
		HDMI Option	HDMI/DVI	Select which HDMI source of the TV is connected to the RJP jack. (HDMI1/HDMI2/HDMI3)
9	External Source	USB Pop-up Screen	Default	When a USB device is connected to the TV : <ul style="list-style-type: none"> • Default: A popup window appears. • Automatic: Opens the USB contents menu automatically. • Disable: Neither the popup window nor the menu appears.
		External Source Banner	ON	If set to On, the TV displays the External Source Banner (information) when you change the TV source to another external input, press the Info key, or turn the TV on. <ul style="list-style-type: none"> • ON: The External Source information is displayed on the TV screen. • OFF: The External Source information is not displayed on the TV screen.
		Auto Source	OFF	<ul style="list-style-type: none"> • ON: When an external input source is connected to the TV, the TV identifies the input source, and then automatically switches to that input source. • OFF: Auto Source function is Off.
		Anynet+Return Source	Power On Src	Select the return TV source after stopping an Anynet+(HDMI-CEC) connection. (This Function is especially useful for the Guestlink RJP)
10	HP Management	HP Mode	OFF	For the specific situation, pls see the table below.
		Default HP Volume	...	
		Main Speaker	ON	
11	Bathroom Speaker (Depending on the region)	Sub Amp Mode	2	Determines the Sub AMP operation mode. 0: Turns the Sub AMP function off (PWM off). 1: Determines the Sub volume according to the main volume control. That is, the sub volume is determined according to the Power On Volume, the Min Volume, and the Max Volume. 2: Determines the volume according to the bathroom control panel setting.
		Sub Amp Volume	6	Sub AMP Volume level at power on initial condition.
12	Eco Solution	Energy Saving	OFF	Adjusts the brightness of the TV to reduce power consumption. <ul style="list-style-type: none"> • OFF: Turns off the energy saving function. • Low: Sets the TV to low energy saving mode. • Medium: Sets the TV to medium energy saving mode. • High: Sets the TV to high energy saving mode.

No	Hotel TV Function			Description
	Category	Item	Initial value	
13	Logo/Message	Welcome Message	OFF	Displays a the Welcome Message for 5 seconds when the TV turns On.
		Edit Welcome Message		Edits the Welcome Message.
		Hospitality Logo	OFF	Turns the Hospitality logo feature On or Off, If On, when the TV is turned on, the Logo is displayed, before the signal from the initial source, for the amount of time set in "Logo Display Time".
		Hospitality Logo DL	...	Downloads the Hospitality logo. Hospitality logo file requirements: <ul style="list-style-type: none"> • BMP or AVI files only. • Max file size: BMP - 960 X 540. AVI - 30MB. • The file can only be named samsung.bmp or samsung.avi.
		Logo Display Time	...	Hospitality Logo Display Time (3/5/7 seconds). (Only in the condtion when "Home menu Dispalry" is OFF)
14	Cloning	Clone TV to USB	-	Clone the current TV options to a USB memory device.
		Clone USB to TV	-	Clone the saved TV options on a USB memory device to the TV.
		Setting Auto Intialize	OFF	When Setting Auto Initialize is set to On, and the power is turned off and on or the Master Power is turned off and on, the data is restored to the cloned values. If there is no cloned value, even when the Setting Auto Initialize is set to On, it will be ignored and the operation will be the same as that when Setting Auto Initialize is set to Off.
15	REACH Solution	REACH 4.0	OFF	<ul style="list-style-type: none"> • ON: Open the REACH 4.0 • OFF: Closed the REACH 4.0
		REACH Channel	...	Select SIRCH Update Channel.
		Group ID	...	Select the SIRCH Group ID.
		REACH Update Time	...	Select the SIRCH update Time. In the SIRCH update time , you have the option to perform an automatic upgrade at 12:00 AM/PM or at 2:00 AM/PM. You can perform hourly upgrades at an interval of either 1 hr or 2 hrs.
		REACH Update Immediate	...	<ul style="list-style-type: none"> • ON: Whenever the TV enters Standby mode, always performs the SIRCH Update. • OFF: Only performs the SIRCH Update at the selected SIRCH Update Time.
		Room Number	...	Edit the room number.
16	Security	REACH Server Version	0000	Display the version of the SIRCH Clone file currently updated on the TV.
		Factory Lock	OFF	Delete Device List in when power on or off. <ul style="list-style-type: none"> • ON: The password is needed before entering factory menu. • OFF: disable this feature.
		Password Popup	...	Enable/disable Password Popup. If this option is set to OFF, the TV will not display the password input popup window when entering the Factory menu. If set to ON, the password input popup window appears.
		Password Input	...	Input Password 00000000.
		Password Setting	...	Set new Password.
		Password Reset	...	Reset Password to 00000000.
		Security Mode	...	Security Mode ON or OFF.
		USB	...	USB Disable or Enable.
HDMI	...	HDMI Disable or Enable.		
TTX Security	...	TTX function Enable or disable.		

No	Hotel TV Function			Description
	Category	Item	Initial value	
17	System	Self Diagnosis for TV	...	Enter the Self Diagnosis Menu. <ul style="list-style-type: none"> Picture Test: Use this to check for picture problems. If the problem appears in the test picture, select Yes and follow the directions on the screen. Sound Test: Use the built-in melody sound to check for sound problems. If the problem occurs during the test, select Yes and follow the directions on the screen.
		Self Diagnosis for HTV	...	This lets you check the state of the Variable audio out and the communication with the SI STB or SBB. If you encounter any problems in the variable audio out feature or communication with the SI STB or SBB, please check this items.
		SW Update	...	SW USB Update function.
		Service Pattern	OFF	Display the Service pattern.
		Sound Bar Out	OFF	An external device such as a Samsung Sound Bar can be connected to the TV via an Anynet Connection and the TV Sound can be routed to the Sound Bar Device. If the feature is OFF in the Hotel Factory Menu, this functionality is disabled The main TV Speaker will be muted while the Sound Bar option is ON and the Speaker is connected through HDMI.
		Contact Samsung	...	Samsung Contact information
		Standby LED	ON	<ul style="list-style-type: none"> ON: The Function IR is On when Standby. OFF: The Function IR is Off when Standby.
		TV Reset	...	Factory reset.

- REACH (Remote Enhanced Active Control for Hospitality) is a professional and interactive remote controller that lets you deliver TV firmware updates, cloning data, channel mapping changes, S-LYNK REACH contents, and TICKER contents through RF DTV to several hundred hospitality TVs simultaneously. The REACH functions are only available in standalone mode. The REACH Server is sold separately. Refer to the REACH server manual enclosed in the REACH server product for more information on operating it.
- Depending on model and region, some menu items may be different.

HP Mode	Main Speaker	Mute ON/OFF	TV Action	Output	Remarks	
ON	ON	OFF	Power ON	Main Speaker Sound - YES (Last Saved/User defined vol. level applied) HP Sound - N/A		
ON	ON	OFF	Volume up/down	Main Speaker - volume level changes as per volume OSD HP Sound - N/A		
ON	ON	ON	Mute	Main Speaker - Mute HP Sound - Yes - Sound level applied from HP Volume level in Hotel Option Menu.		
ON	ON	ON	volume up/down	Main Speaker Sound - No (Mute) HP - volume level up/down as per current HP volume		
ON	ON	OFF	Unmute	Main Speaker Sound - Yes. HP Sound - N/A		
Greyed	OFF	OFF	Power ON	Main Speaker Sound - No (Mute) HP Sound - YES (HP vol. level from Factory applied)		It is similar to Normal working except that Headphone is connected forcefully even if Headphone is not connected physically.
Greyed	OFF	OFF	Volume up/down	Main Speaker - Mute HP - volume level up/down as per current HP volume		
Greyed	OFF	ON	Mute	Main Speaker - Mute (No Action) HP - Change to Mute		
Greyed	OFF	ON	volume up/down keeping Mute state	Main Speaker Sound - No (Mute) HP - volume level up/down as per current HP volume		
Greyed	OFF	OFF	Unmute	Main Speaker Sound - No (Mute) HP - Yes(volume level as per current HP volume)		
OFF	ON	OFF	Power ON	If HP Management is OFF, forcefully set Main Speaker as OFF. (If HP management OFF, working is same as Normal HTV working.)	Same as Headphone Connected/disconnected case with No HP Management feature.	
OFF	ON	OFF	Volume up/down			
OFF	ON	ON	Mute			
OFF	ON	ON	volume up/down keeping Mute state			
OFF	ON	OFF	Unmute			

Welcome Message

The Welcome message is a feature that allows you to display customized message on the TV every time the TV is turned on by a guest in a hotel room.

- The Welcome message settings are placed in the Hotel Option Menu.
- The Welcome message should be ON in order for the message to be displayed when the power is turned on.

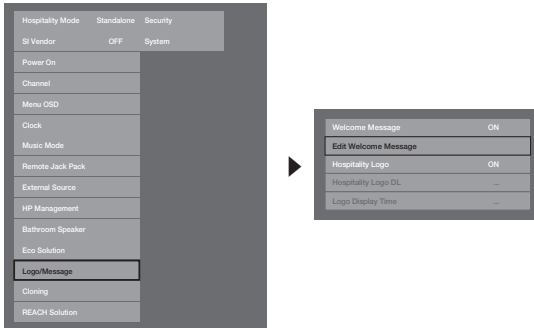

<Depending on model and region, some menu items may not exist>

- The Welcome message can be up to 25 characters and can be edited in the Hotel Service menu.
- The following is the list of characters supported for the Welcome message.
 - ✎ Only the capital letters A to Z are allowed.
- The Welcome message can be edited using the navigation, colour & enter keys of the remote control in the "Edit Welcome Message" OSD.



- The Welcome message and hotel logo cannot be active at the same time.

Hotel Logo

The Hospitality Logo function displays the Hotel's logo when the TV is powered on.

- The Hospitality Logo settings are in the Hospitality mode menus.
- The Logo Download and Logo Display Menu items are enabled when you turn the Hospitality Logo option on.
- If there is a logo image stored in the memory and the Hospitality Logo option is on, the Hospitality logo is displayed when the TV is turned on.
- The Hospitality logo is not displayed when the Hospitality Logo option is off, even if the logo image has been loaded onto the TV.

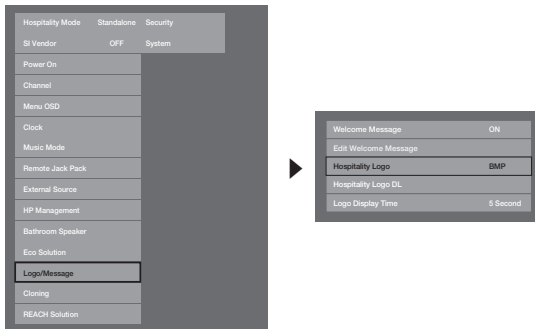

<Depending on model and region, some menu items may not exist>

• Hospitality Logo

- This option lets you choose whether the Hospitality Logo image is displayed or not.
- The Initial value is OFF.
- Can be set to OFF or ON.
- When set to ON, the Logo Download and Logo Time Display menu items become accessible.

• Hospitality Logo DL

- This option lets you download the logo image to the TV's memory from a USB device.
- The Wait message appears while the image is being copied to the TV.
- The Completed message appears when the copy operation has finished successfully.
- The Failed message appears when the copy operation was unsuccessful.
- The No USB device message appears if no USB device is connected.
- The No File message appears if there is no file to copy on the USB device or if the file is in the wrong format (must be a BMP file). If the No File message appears and there is a logo file on the USB device, check the file format.

• Logo File Format

- The TV only supports the BMP and AVI formats.
- The file name must be samsung.bmp or samsung.avi.
- The maximum resolution of the BMP format is 1280 x 720.
- The maximum file size of the AVI format is 30MB.
- The TV does not change the size or scale of the image.

Video Codec: H.264 /MPEG-4 /MPEG2

Bit Rate: below 10 Mbps

Frame Rate: 24~30

Resolution: 640*480 | 1920*1080

Cloning

USB Cloning is a function to download user configured settings (**Picture, Sound, Input, Channel, Setup, and Hotel Setup**) from one TV set and upload the same settings to other TV sets.

All user-defined settings from the TV (Master Set) can be copied to the USB device.

– USB Cloning support 2.0 Standard only.

- **Clone TV to USB:** This is an operation that copies the stored data from a specific area of the TV EEPROM to the USB device.

1. Insert a USB drive into the USB port on the back of the TV.
2. Enter the Hotel Options by pressing these buttons in the following order:
MUTE → 1 → 1 → 9 → ENTER
3. Press the **▲** or **▼** button to select “**Clone TV to USB**”, then press the **ENTER** button.
4. The message “**Clone TV to USB**” is displayed, then press the **ENTER** button.
5. You can check the status of the USB cloning operation.
 - **In Progress:** While copying data to the USB device.
 - **Completed:** The copy operation was finished successfully.
 - **Failed:** The copy operation was not finished successfully.
 - **No USB:** No USB device connected.

- **Clone USB to TV:** This is an operation that downloads the stored data to the USB device to the TV set.

1. Insert a USB drive into the USB port at the back of the TV.
 2. Enter the Hotel Options by pressing these buttons in the following order:
MUTE → 1 → 1 → 9 → ENTER
 3. Press the **▲** or **▼** button to select “**Clone USB to TV**”, then press the **ENTER** button.
 4. The message “**Clone USB to TV**” is displayed, then press the **ENTER** button.
 5. You can check the status of the USB cloning operation.
 - **In Progress:** While copying data to the USB device.
 - **Completed:** The copy operation was finished successfully.
 - **Failed:** The copy operation was not finished successfully.
 - **No USB:** No USB device connected.
 - **No File:** There is no file to copy on the USB device.
- 🔑 Activate copying from USB to TV by pressing **ENTER** key for 5 seconds.
- 🔑 The **CLONE** function only supports the same model series. (It does not work properly for different model series.)

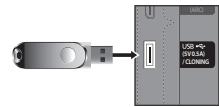

For fast, instant cloning during installation, insert a USB drive with master settings from the first TV and press the Enter key for 5 seconds.

Hospitality Plug & Play

Hotel Plug & Play is a function that automatically performs the Hotel mode selection, Local Set and Picture mode Setup once.

- Hotel Plug & Play is available only one time when power is first turned ON.
- This is available after first setting up the TV and transferring Clone TV data to a USB drive.
- To use Next TV, you only need to exit Hotel Plug & Play, connect the USB, then Clone the USB to TV.
- Depending on model and region, some menus may not exist.

- UI Scenario

If "Standalone(Home Menu)" or "Interactive(STB)" is selected.

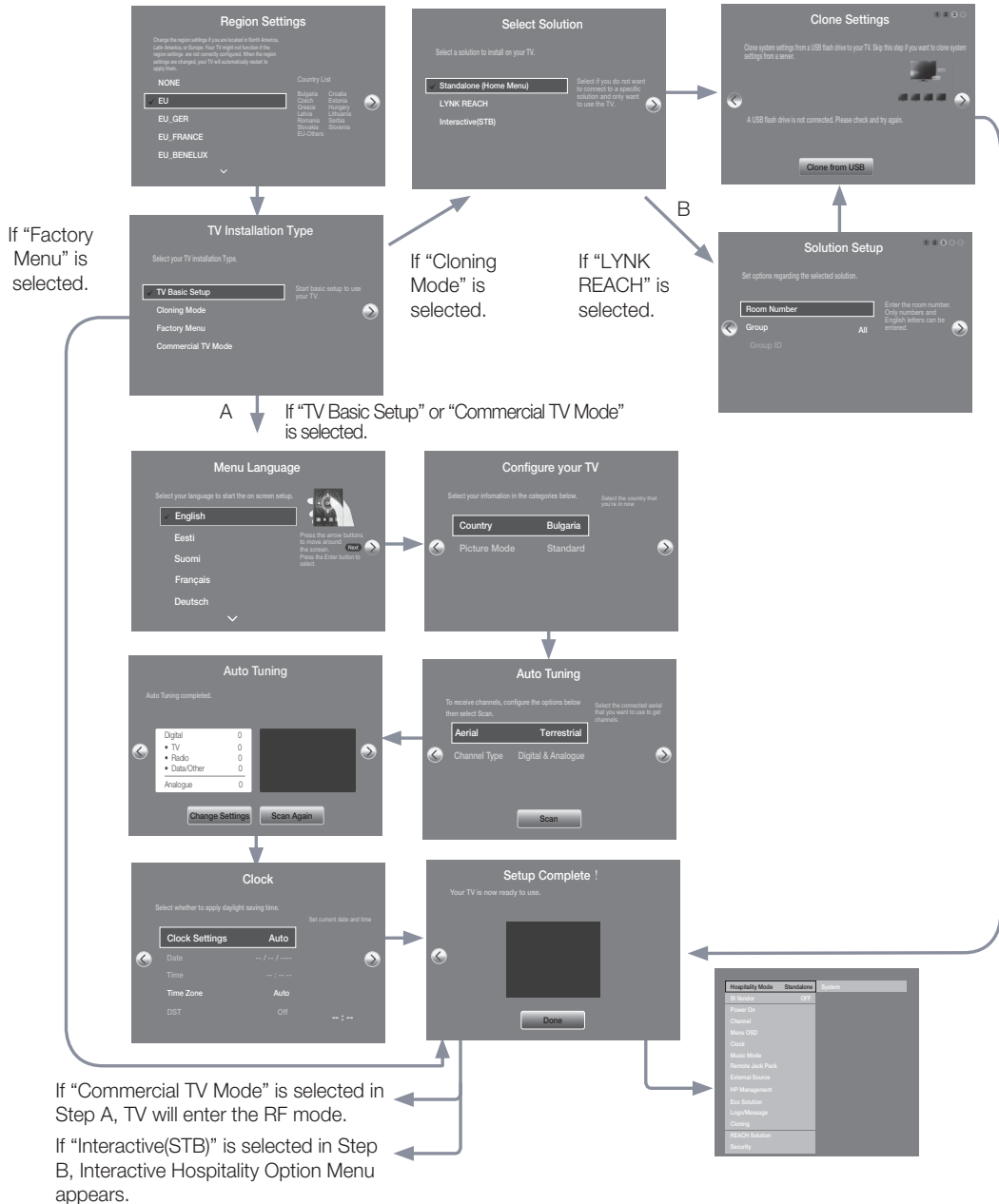

1. Region Settings

- Check the **Region settings**.
- If you want to change the setting, select and **ENTER**.
- If you don't want to change, go next step.

2. TV Installation Type

- If you select "Cloning Mode", "Select Solution" appears.
- Select "TV Basic Setup" or "Commercial TV Mode" to go next step.

3. Menu Language

- Select the OSD (On Screen Display) language.

4. Select the Country and Picture Mode

- Select the appropriate country and picture mode.
- Depending on model and region, some country may not exist.

5. Auto Tuning

- Select the antenna source and channel type. Configure the settings and select the **Scan**.
- The **Auto Tuning** operation starts searching for channels.
- When the **Auto Tuning** operation is completed, the channel information is displayed.

6. Clock

- Set the right time by setting the **DST** (Daylight Savings Time) and **Time Zone**.

7. TV Setup Complete

HD Plug & Play – Local Set (Only Europe)

- Local Set is very important software setting value such as Languages, Broadcast frequencies, etc.
- TV might not function, if Local Set is not correctly configured. Select correct Local Set with country list provided.

TV will reboot automatically to apply new Local Set.

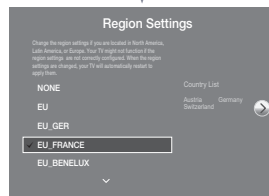
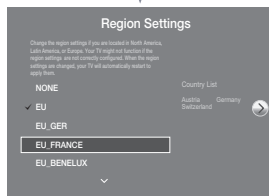
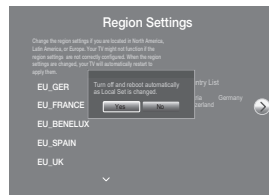
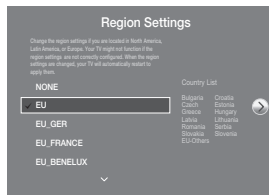

After reboot, updated Local Set is shown.

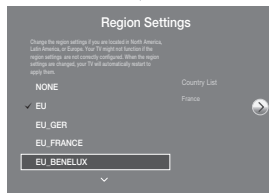

Press ENTER, general HD plug&play will be continued.

If you need to change Local Set after HD plug&play, click TV Reset function on Factory mode, you can progress HD plug&play including Local Set change.

SW Clock

The SW Clock shows the current time on the screen when a user presses the Info remote control key in standby mode.

- If a user presses the Info key when the TV is in standby mode, the TV is turned on and shows the current time on the screen for 10 seconds and then returns to standby mode.
- The time is displayed as a digital clock at the normal banner size. The 12 or 24 hour time format is determined according to the format of the Information.
- If a user presses the Info key when the TV is on, the original Info key function is executed.
- Detailed Descriptions
 - The SW clock works depending on the On/Off setting in the Factory install menu.
 - If the SW clock is turned on, the Fast logo option is automatically turned off. (In this case, even if you turn the Fast logo option on again, it is automatically turned off when the TV is turned on again.)
 - If the master power is turned off, the time setting is only maintained in models with a backup condenser and an RTC.
 - When a TV in standby mode shows the current time, the video mute and audio mute settings are maintained.
 - In this case, even if the Hotel logo is set to on, the Hotel Logo display is skipped.
 - This feature only works in StandAlone mode.
 - Other key function specifications when the SW clock is running
 - The Info key works like the power key.
 - Pressing the Power or Info key while the SW clock is running, puts the TV into Standby mode.
 - Pressing keys other than the Power and Info keys is ignored while the SW clock is running.
 - In this case, the on timer does not work.
 - The off timer and sleep timer work.
 - When clock mode in the Time menu is set to manual, the time of the sub micom is maintained by the RTC circuit.
 - Even if the current time is not configured, it is displayed in the same way as the menu. (--:--)



Multi Code Remocon

Multi Code Remote Control is a special transmitter which is designed to control multiple TVs with one remote. This function is useful when there is more than one TV in one location such as a hospital. The Set ID number will be displayed in the source OSD. It is possible to support up to 9 different remote key transmission for multi code. The initial ID code of each TV is "0".

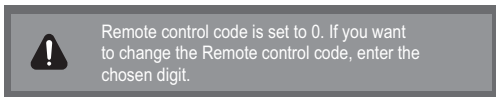

The ID code can be set and reset in Analog TV mode or PC mode. (not available in TTX or DTV channels)

- The ID code can be from 0 to 9.
- Press the **RETURN** + **MUTE** keys for longer than 7 seconds and the digit key you want to set.
- The Set ID OSD will be displayed in a central position.
- The following words will be displayed. "Remote control code is set to X. If you want to change the Remote control code, enter the chosen digit." (x is the digit number) This OSD will be displayed until the exit key is pressed.



- For example, the TV and Remote control will be set to ID code #1 if the user presses #1.
- The following words will be displayed. "Remote control code is changed to 1". The TV can then only be controlled by a remote control with the same ID code as the TV.
- If the ID code between the remote control and the TV does not match, the following words will be displayed. "TV ID x" (x is the TV's ID)
- To reset the ID code, press the **EXIT** + **MUTE** keys for longer than 7 seconds. The ID codes of both the TV and Remote control will be reset to "0". "Remote control code is set to 0." will be displayed.
- The way to set or reset the ID may differ depending on the remote control. See the table below.

Setting the Time

 MENU  System → Time → Clock → Clock Set

• The time is entered

- Press the remote control button to select **Clock** and set up the time.

• Setting the Interactive Mode Time

- If the Hotel System transmits the time information, the time is set automatically.
- If the Hotel System does not transmit the time information, the time cannot be displayed.

 If the time is set, the clock will be displayed on the front panel.

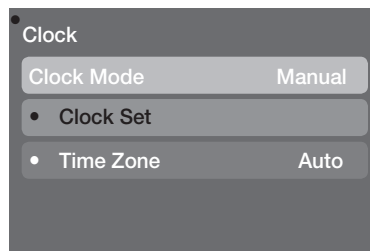
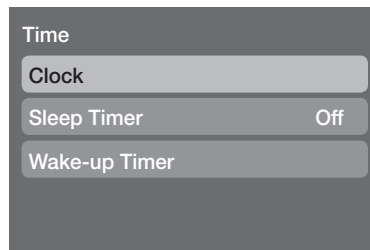

Channel Bank Editor (Smovie TV Only)

Channel Bank Editor is a function to edit channels with 3 different Bank Options. Depending on the Bank card, there are specific channels hotel customers can enjoy.

Setting the Channel Bank Editor in Stand-alone Mode

1. Enter the Hotel Standalone menu by pressing “MUTE + 1 + 1 + 9 + Enter”
2. Please select the SI vendor: “**Smovie**”
3. You will be able to see the new menu option “**Channel Bank Editor**”
4. Enter “**Channel Bank Editor**”

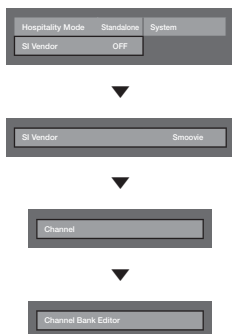

<Depending on the model and region, some menu items may not exist>

5. Edit the channel bank like in the example below.
 - a. **Bank1 (Free channel)**: Select the channel that will be used when the remote control has no card.
 - b. **Bank2 (Family Card - Green)**: Select the channel that will be used when a remote control has a GREEN CARD.
 - c. **Bank3 (Adult Card - Red)**: Select the channel that will be used when a remote has a RED CARD.

Channel Bank Edit			
	Bank1 (4)	Bank2 (6)	Bank3 (36)
All	<input type="checkbox"/>	<input type="checkbox"/>	<input checked="" type="checkbox"/>
1 1futech	<input checked="" type="checkbox"/>	<input checked="" type="checkbox"/>	<input checked="" type="checkbox"/>
1 BBC1	<input checked="" type="checkbox"/>	<input checked="" type="checkbox"/>	<input checked="" type="checkbox"/>
2 24ore.tv	<input type="checkbox"/>	<input checked="" type="checkbox"/>	<input checked="" type="checkbox"/>
2 C3	<input type="checkbox"/>	<input checked="" type="checkbox"/>	<input checked="" type="checkbox"/>
3 BBC World	<input type="checkbox"/>	<input checked="" type="checkbox"/>	<input checked="" type="checkbox"/>
3 C5	<input type="checkbox"/>	<input checked="" type="checkbox"/>	<input checked="" type="checkbox"/>
4 Coming Soom	<input type="checkbox"/>	<input type="checkbox"/>	<input checked="" type="checkbox"/>
4 S2	<input type="checkbox"/>	<input type="checkbox"/>	<input checked="" type="checkbox"/>

⏏ Move ⏏ Select/Deselect ⏏ Return

References of using SMOOVIE Remote Controller

1. If you select SMOOVIE as the SI Vendor, you should use a SMOOVIE Remote Controller.
2. Using the numeric keys of the remote controller, users can only select Bank1 channels.
With this in mind, if you want to change the channel using a Green or Red Card, please use the channel up/down keys.
3. In the Channel guide or Channel list, users can only see the Bank1 channel list.

Channel Editor

Channel Editor edits channel number and name.

- Use Channel Editor to sort the channels as user-desired channel numbers.



<Depending on model and region, some menu items may not exist>

Simple Steps for channel Editor under Stand-alone Mode

Step	Broad Outline
1	Operate 'Channel Auto Store' in the Hotel Option Menu
2	Enter 'Channel Editor' in the Hotel Option Menu
3	Compile a table related to the final channel lists you want
4	Rearrange channels with TOOLS button based on the table you compiled
5	Press the EXIT or RETURN Button to exit.

<For better comprehension, please refer to the following details>

My Channel

Determines the country and genre for the channels provided by the hotel, and if the user selects a country and genre, shows the corresponding channels.

- You must select the country first, or you cannot set a genre.
- If you select the genre that not added any channels, the Channel list displays all of the available channels.
- My Channel works in Standalone mode only.
- SI Vendor in Standalone mode: This does not work if Smoovie is selected.
- This is in the Hotel Options in the Hotel Menu -> Service Mode and can be turned on or off.
- This option only works when it is set to On.

Channel Composition [Genre Mode]

Standard	Category	Ch. Mode	Antenna Mode Activation	Description
			Air/Cable	
Hotel	Genre	All (Default)	<input type="radio"/>	Provide genre channel mode by each country that master has managed in factory mode.
		News	<input type="radio"/>	
		Radio	<input type="radio"/>	
		Entertainment	<input type="radio"/>	
		Sport	<input type="radio"/>	
		Hotel	<input type="radio"/>	

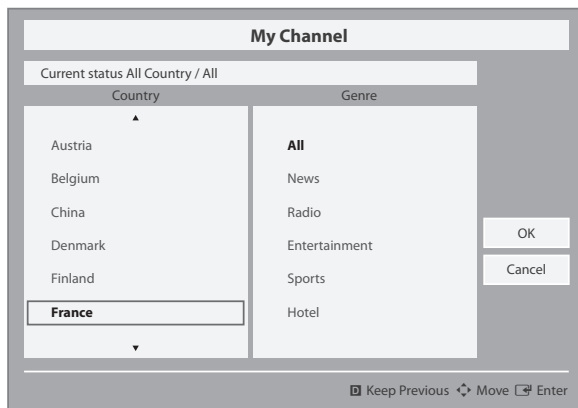

* For the number of items to be displayed in the list, refer to the design document.

Key Guide

Button	Action	Nav. Help
Enter	Selects an item.	Enter
Ch. Up/Down	Move the highlight by page.	(No Guide)
UP/DOWN	Navigates the each country, genre list. (in a circular manner.)	Move
RIGHT	Selects the highlighted item, and then move the highlight to Genre section.	
RETURN	Returns to the screen. (Genre setup: Last Country & Genre)	(No Guide)
EXIT	Returns to the screen. (Genre setup: Last Country & Genre)	(No Guide)

📌 Notes

- This section describes the layout of the Front UI that appears when the TV is turned on. (Factory Mode > Genre Mode: Enable)
- The genre is a sub-list for each country.
- The broadcast screen that was being displayed the last memorial channel.
- If user want to keep the previous country & genre channel map, press the 'BLUE', RETURN, and EXIT remote-control key to close the Front UI.

📌 Etc.

- Default Highlight: Last Memory items (Country, Genre)
- Timeout (60 sec)

Elements

No	Name	Description
1	Background Screen	Displays the last memorized channel that appears when TV is turned on.
2	Function Title	This is name of the function.
3	Current Status	Display current settings the Country/Genre.
4	Country Items	The item for the country list is displayed. Displays the last selected country.
5	Genre Items	The item for the genre list is displayed. Displays available genre items by each country that master managed in factory mode. (always provide 'All' item) Displays the last selected genre.
6	Highlight	If the item title is too long to be displayed within the area, Auto Text Sliding works.
7	Indicator	This is displayed when there is a previous or next page.
8	Nav. Help	The key guide is right-aligned.

Highlight Interaction [Country Items]

- This page is only to indicate possible interactions. It may not be exactly identical to actual screens.

Notes

- Users can navigate the items in each country & genre list by pressing the up or down remote control keys.
- Circular navigation is supported.

1

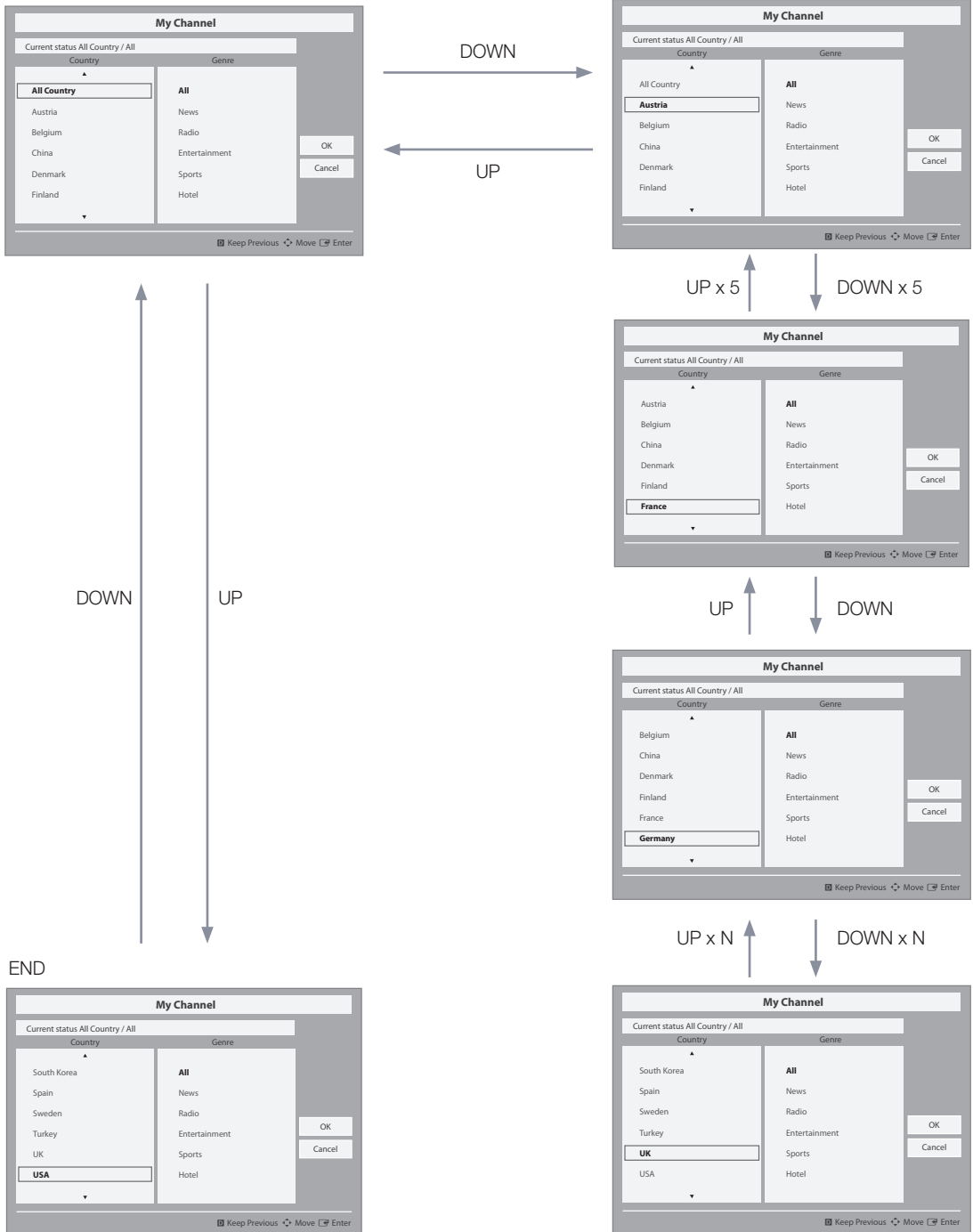

Highlight Interaction [Default Genre]

- This page is only to indicate possible interactions. It may not be exactly identical to actual screens.

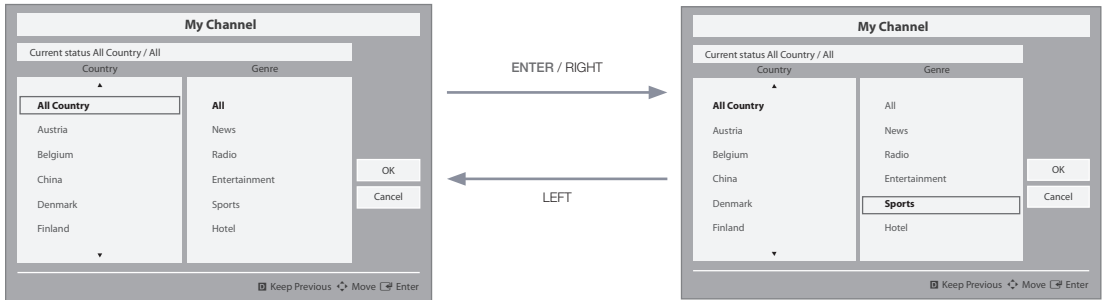

- The current selection of the country is high-lighted.

- Default High-light: The current selection of the genre.

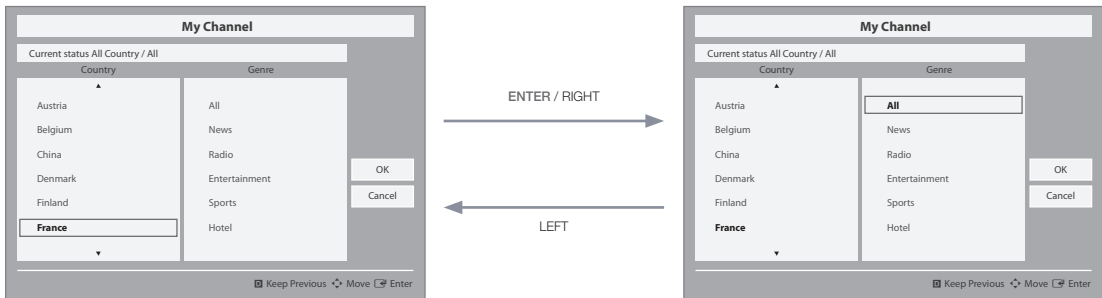

- Seems source error, it should be read as "The other item of the county is high-lighted.". Please verify. (ex. France)

- Default Highlight: All

Mode Change Interaction 1 (1/2)

- This page is only to indicate possible interactions. It may not be exactly identical to actual screens.

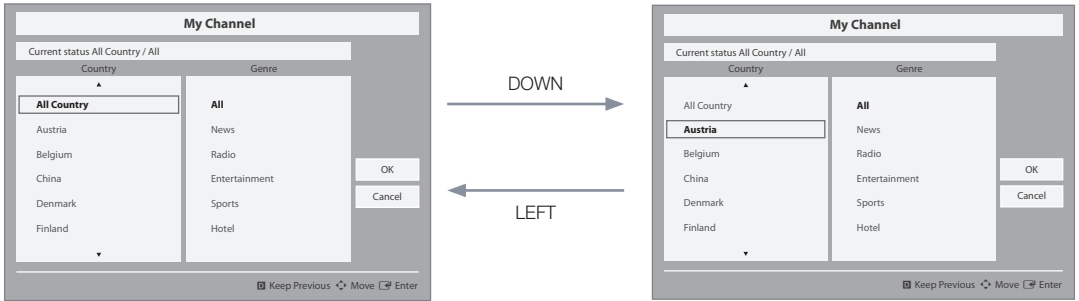

- Current Genre Mode: All Country / Sports

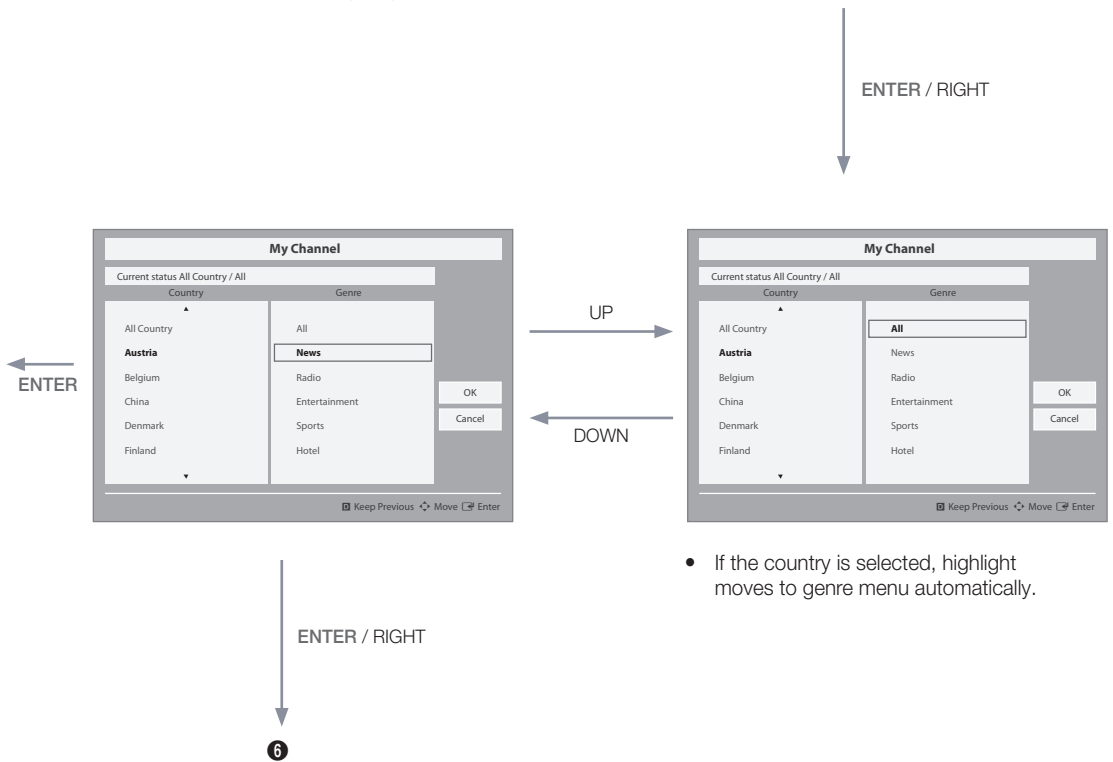

- If the country is selected, highlight moves to genre menu automatically.

Mode Change Interaction 1 (2/2)

- This page is only to indicate possible interactions. It may not be exactly identical to actual screens.

5

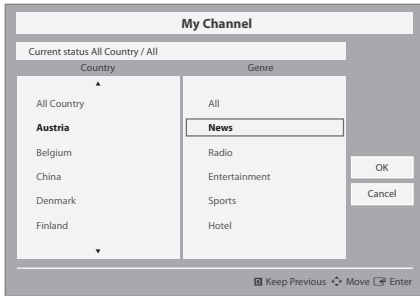

- The genre mode change complete message is displayed.
- Timeout(5 sec.)



ENTER / RETURN / Timeout

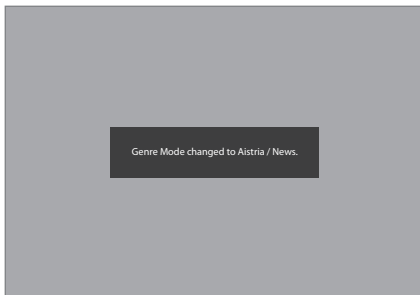

6

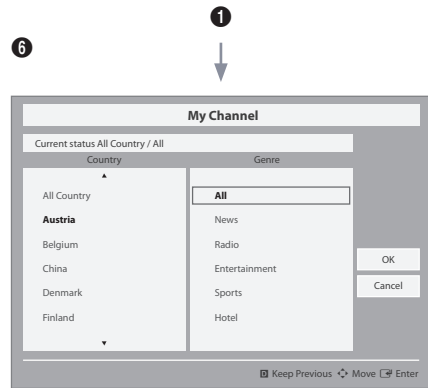

- Pressing the left key from the genre to country menu highlights an existing selected country item.

Mode Change Interaction 2 (1/2)

- This page is only to indicate possible interactions. It may not be exactly identical to actual screens.

1

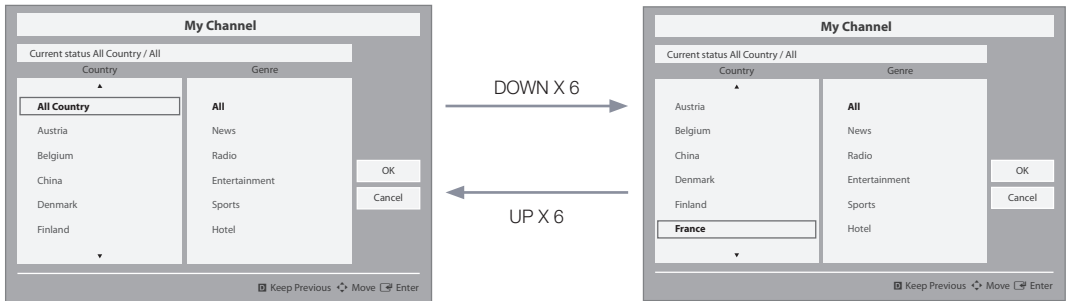

- Current Genre Mode: All Country / Sports

5



- Current Genre Mode: All Country / Sports

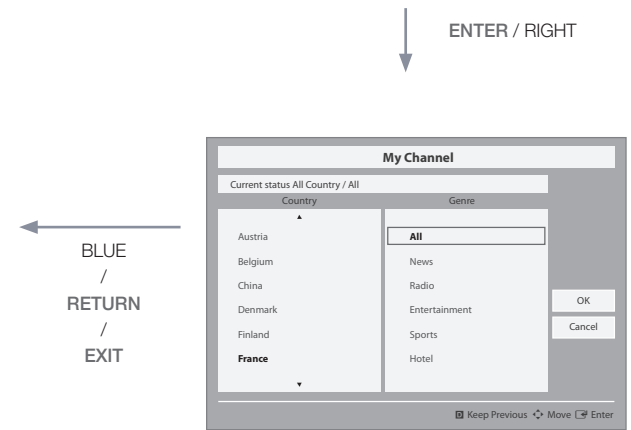

- If the country is selected, highlight moves to genre menu automatically.

Mode Change Interaction 1 (2/2)

- This page is only to indicate possible interactions. It may not be exactly identical to actual screens.

1

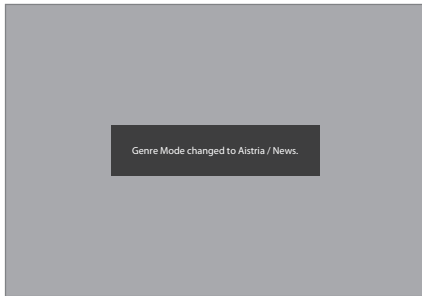

POWER →

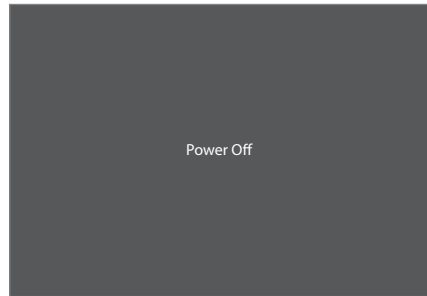

↓
POWER

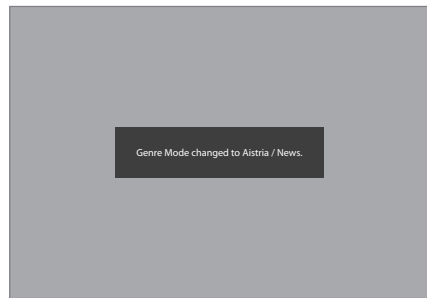

- Current Genre Mode: Austria / News

- Current Genre Mode: Austria / News

Genre Editor

- Country and Genre selection can be done in channel list Menu.
- Pressing Red Key enables country sub list, here viewer can scroll down and select country of choice.
- Genre selection can be done using Left/right key i.e scrolling horizontally in channel list menu.
- If viewer wants to change Genre or country in TV On state, it can be done using this feature.

Channel Genre Edit

Registered		News	Radio	Entertainment	Sports	Hotel
<input type="checkbox"/>	0 C67	<input type="checkbox"/>	<input type="checkbox"/>	<input type="checkbox"/>	<input type="checkbox"/>	<input type="checkbox"/>
<input type="checkbox"/>	1 C--	<input type="checkbox"/>	<input type="checkbox"/>	<input type="checkbox"/>	<input type="checkbox"/>	<input type="checkbox"/>
<input type="checkbox"/>	2 C78	<input type="checkbox"/>	<input type="checkbox"/>	<input type="checkbox"/>	<input type="checkbox"/>	<input type="checkbox"/>

Select All Items On Column Deselect All Items On Column Select

- An editor to set genre for each Hotel TV channel.
- Stored channels can be added to a particular genre in genre editor menu.
- A channel can belong to multiple genres.
- Genre Options available are: News, Radio, Entertainment, Sport, and Hotel.
- Genre selection can be done either on Mychannel FrontUI or in Channel List.
- This feature sorts out channels of particular genre in a list. Guest can select genre of his choice and select channel by scrolling down sorted list.

Mixed Channel Map

The Mixed Channel Map function mixes Air, Cable and Satellite channels.

- The Mixed Channel Map function should be ON in order to mix Air, Cable and Satellite channels.
- Use the Channel Editor to sort the channels after turning on the 'Mixed Channel Map' function in the Hotel Option Menu.

Sound Bar

• **Samsung Sound-Bar & Hospitality TV in 2015**

- Use Samsung Sound-Bar & hospitality TV support HDMI 1.4 to listen to TV sound on the Sound-Bar by using a single HDMI cable.
- Supporting model.
 - Sound-Bar: HW-F350/F450/F550

• **The "Hotel mode" operation from the Sound Bar**

- The following TV hotel options should be set in advance.
 - Hotel option → Power On → Power ON Volume = "Enable" / Power ON Vol / Max Vol
 - Hotel option → External Device → Sound Bar Out = "On"
- Connect an HDMI cable from the HDMI OUT port of the Sound-BAR to the HDMI1 port of the hospitality TV.
- After being connected to the 2015 hospitality TV via an HDMI Cable, the Sound-Bar automatically detects the TV while it turns on, and is converted to "hotel mode" by itself.
- The change of the power-on volume & max volume on the TV is applied to the connected sound-bar since the TV boots twice .

• **Features of "Hotel Mode" in Sound Bar**

- Synchronized power on/off with the TV.
- HDMI_CEC enabled.
- Accessible "HDMI OUT" port only. (Other inputs are disabled)
- Synchronized "power-on"&"max" volume with the TV. (The Sound-Bar's volume is set to half that of the TV)
- Adjustable "power-on"&"max" volume acquired from the TV's hotel option menu. (Sound-Bar volume=TV volume/2 Ex.) If the volume settings on the TV are "power-on volume=20 and max volume=90", the Sound bar will work as power-on volume=10, max volume=45.

*This function may differ depending on the model.

Installing the Wall Mount

The wall mount kit (sold separately) allows you to mount the TV on the wall. For detailed information on installing the wall mount, see the instructions provided with the wall mount. Contact a technician for assistance when installing the wall mount bracket. We do not advise you to do it yourself.

Samsung Electronics is not responsible for any damage to the product or injury to yourself or others if you select to install the TV on your own.

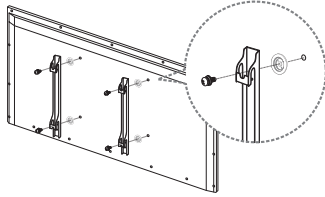

Wall mount Adapter
(Depending on the Model)

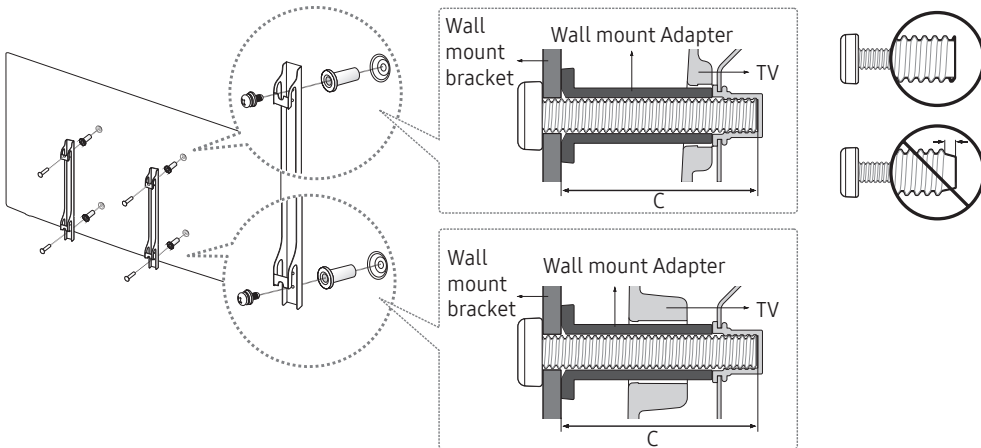

Before installing any other wall mounting kit, assemble the wall mount adapter provided separately with the TV.

Wall Mount Kit Specifications (VESA)

The Wall mount kit is not supplied but sold separately.

Install your wall mount on a solid wall, perpendicular to the floor. When attaching to other building materials, please contact your nearest dealer. If installing on a ceiling or slanted wall, it may fall and result in severe personal injury.

NOTE

- Standard dimensions for wall mount kits are shown in the table below.
- When purchasing our wall mount kit, a detailed installation manual and all parts necessary for assembly are provided.
- Do not use screws that do not comply with VESA standard screw specifications.
- Do not use screws longer than the standard dimensions, as they may cause damage to the inside of the TV set.
- For wall mounts that do not comply with the VESA standard screw specifications, the length of the screws may differ depending on their specifications.
- Do not fasten the screws too tightly. This may... damage the product or cause the product to fall, leading to personal injury. Samsung is not liable for these kinds of accidents.
- Samsung is not liable for product damage or personal injury when a non-VESA or non-specified wall mount is used or the consumer fails to follow the product installation instructions.
- Do not exceed a 15 degrees tilt when mounting this TV.

inches	VESA Spec. (A * B)	Standard Screw	Quantity
24	75 x 75	M4	4
28 (HG32EE670)	100 x 100		
32-49	200 X 200	M8	
55-58	400x400		

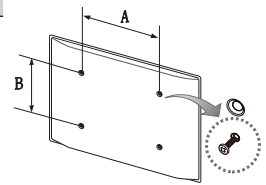

Do not install your Wall Mount Kit while your TV is turned on. It may result in personal injury due to electric shock.

Securing the TV to the Wall



Caution: Pulling, pushing, or climbing onto the TV may cause the TV to fall. In particular, ensure that your children do not hang over or destabilize the TV; doing so may cause the TV to tip over, resulting in serious injuries or death. Follow all safety precautions provided on the included Safety Flyer. For added stability, install the anti-fall device for safety purposes, as follows.



To avoid the TV from falling

1. Put the screws into the clamps and firmly fasten them onto the wall. Confirm that the screws have been firmly installed onto the wall.
 - 🔧 You may need additional material, such as an anchor, depending on the type of wall.
 - 🔧 Since the necessary clamps, screws, and string are not supplied, please purchase these additionally.
2. Remove the screws from the centre back of the TV, put the screws into the clamps, and then fasten the screws onto the TV again.
 - 🔧 Screws may not be supplied with the product. In this case, please purchase the screws of the following specifications.
3. Connect the clamps fixed onto the TV and the clamps fixed onto the wall with a strong string and then tie the string tightly.
 - 🔧 **NOTE**
 - Install the TV near to the wall so that it does not fall backwards.
 - It is safe to connect the string so that the clamps fixed on the wall are equal to or lower than the clamps fixed on the TV.
 - Untie the string before moving the TV.
4. Verify that all connections are properly secured. Periodically check connections for any sign of fatigue for failure. If you have any doubt about the security of your connections, contact a professional installer.

Anti-theft Kensington Lock

The Kensington Lock is not supplied by Samsung. It is a device used to physically fix the system when using it in a public place. The appearance and locking method may differ from the illustration, depending on the manufacturer. Refer to the manual provided with the Kensington Lock for additional information on proper use.

To lock the product, follow these steps:

Please find the “” icon on the rear of the TV. A Kensington slot is beside the “” icon.

1. Wrap the Kensington lock cable around a large, stationary object such as desk or chair.
 2. Slide the end of the cable with the lock attached through the looped end of the Kensington lock cable.
 3. Insert the locking device into the Kensington slot on the product (1).
 4. Lock the lock.
- 🔧 These are general instructions. For exact instructions, see the User manual supplied with the locking device.
 - 🔧 The locking device has to be purchased separately.
 - 🔧 The location of the Kensington Lock may be different depending on the model.

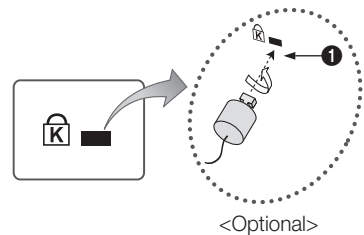

Specifications

Items		Specification	Comment
TV System		PAL, SECAM DVB-TC, DTMB (HongKong), DVB-T2C	
Audio out	Speaker out	24-32 inch: 5W X 2	The HG32AE570SJXXZ is 5W X 2, the other is 32 inch of 10W X 2
		40-58 inch: 10W X 2	
	Variable Audio	4W mono 8 ohm SPK'	Phone Jack output BTL Sound output
Input	PC	D-sub, Audio-L/R	
	A/V	Audio Video Jack	
	EXT(RGB)	Scart Jack	
	HDMI	Compatible with the HDMI Specifications	
	Antenna	75 ohm Unbalanced, Din Jack , F Jack	
DATA	DATA	RJ-12	
	RJP	RS232	
Operating temperature		10°C ~ 40°C (50°F ~ 104°F)	
Operating Humidity		10% ~ 80%	non-condensing
Storage Temperature		-20°C ~ 45°C (-4°F ~ 113°F)	
Storage Humidity		5% ~ 95%	non-condensing

- 🔗 Design and specifications are subject to change without prior notice.
- 🔗 For information about the power supply, and more information about the power consumption, refer to the label attached to the product.
- 🔗 The above specifications may differ depending on the model.
- 🔗 For information on Samsung's environmental commitments and product-specific regulatory obligations, e.g. REACH, WEEE, Batteries, visit http://www.samsung.com/uk/aboutsamsung/samsungelectronics/corporatecitizenship/data_corner.html

Supported Video Formats

File Extension	Container	Video Codec	Resolution	Frame rate(fps)	Bit rate(Mbps)	Audio Codec
*.avi / *.mkv *.asf / *.wmv *.mp4 / *.3gp *.vro / *.mpg *.mpeg / *.ts *.tp / *.trp *.mov / *.flv *.vob / *.svi *.divx	AVI	DivX 3.11/4.x/5.x/6.x	1920 x 1080	6~30	30	Dolby Digital LPCM ADPCM (IMA, MS) AAC HE-AAC WMA Dolby Digital Plus MPEG (MP3) DTS (Core) G.711(A-Law, μ-Law) Vorbis
	MKV	MPEG4 SP/ASP				
	ASF	H.264 BP/MP/HP				
	MP4	Motion JPEG	640 x 480		8	
	3GP	Window Media Video v9	1920 x 1080		30	
	MOV	MPEG2				
	FLV	MPEG1				
	VRO					
	VOB					
	PS TS					
*.webm	WebM	VP8		20		

Other Restrictions

- Video content will not play, or not play correctly, if there is an error in the content or the container.
- Sound or video may not work if the contents have a standard bit rate/frame rate above the compatible Frame/sec listed in the table.
- If the Index Table is in error, the Seek (Jump) function is not supported.
- Some USB/digital camera devices may not be compatible with the player.
- The menu can be displayed late if the video is over 10Mbps(bit rate).

Video decoder	Audio decoder
<ul style="list-style-type: none"> • Supports up to H.264, Level 4.1 (FMO/ASO/RS are not supported.) • frame rate : <ul style="list-style-type: none"> – Below 1280 x 720: 60 frame max – Above 1280 x 720: 30 frame max • VC1 AP L4 is not supported. • GMC is not supported. 	<ul style="list-style-type: none"> • WMA 10 Pro supports up to 5.1 channel and M2 profile. • WMA lossless audio is not supported. • Vorbis supports up to 2ch. • Dolby Digital Plus supports up to 5.1 channel.

Supported Subtitle Formats

External

Name	File extension
MPEG-4 timed text	.txt
SAMI	.smi
SubRip	.srt
SubViewer	.sub
Micro DVD	.sub or .txt
SubStation Alpha	.ssa
Advanced SubStation Alpha	.ass
Powerdivx	.psb

Internal

Name	Container	Format
Xsub	AVI	Picture Format
SubStation Alpha	MKV	Text Format
Advanced SubStation Alpha	MKV	Text Format
SubRip	MKV	Text Format
MPEG-4 timed text	MP4	Text Format

Supported Photo Formats

File Extension	Type	Resolution
*.jpg *.jpeg	JPEG	15360 X 8640
*.bmp	BMP	4096 X 4096
*.mpo	MPO	15360 X 8640

Supported Music Formats

File Extension	Type	Codec	Remark
*.mp3	MPEG	MPEG1 Audio Layer 3	
*.m4a *.mpa *.aac	MPEG4	AAC	
*.flac	FLAC	FLAC	Can support up to 2channel
*.ogg	OGG	Vorbis	Can support up to 2channel
*.wma	WMA	WMA	WMA 10 Pro supports up to 5.1 channel and M2 profile. (WMA lossless audio is not supported.)
*.wav	wav	wav	
*.mid *.midi	midi	midi	Can not support seeking

SAMSUNG

Contact SAMSUNG WORLD WIDE

If you have any questions or comments relating to Samsung products, please contact the SAMSUNG customer care centre.

Country	Customer Care Centre ☎	Web Site
AUSTRIA	0800-SAMSUNG (0800-7267864) [Only for Dealers] 0810-112233	www.samsung.com/at/support
BELGIUM	02-201-24-18	www.samsung.com/be/support (Dutch) www.samsung.com/be_fr/support (French)
BOSNIA	055 233 999	www.samsung.com/support
BULGARIA	*3000 Цена в мрежата 0800 111 31, Безплатна телефонна линия	www.samsung.com/bg/support
CROATIA	072 726 786	www.samsung.com/hr/support
CZECH	800 - SAMSUNG (800-726786) Samsung Electronics Czech and Slovak, s.r.o. V Parku 2323/14, 148 00 - Praha 4	www.samsung.com/cz/support
DENMARK	70 70 19 70	www.samsung.com/dk/support
FINLAND	030-6227 515	www.samsung.com/fi/support
FRANCE	01 48 63 00 00	www.samsung.com/fr/support
GERMANY	0180 6 SAMSUNG bzw. 0180 6 7267864* (*0,20 €/Anruf aus dem dt. Festnetz, aus dem Mobilfunk max. 0,60 €/Anruf)	www.samsung.com/de/support
CYPRUS	8009 4000 only from landline, toll free	www.samsung.com/gr/support
GREECE	80111-SAMSUNG (80111 726 7864) only from land line (+30) 210 6897691 from mobile and land line	
HUNGARY	0680SAMSUNG (0680-726-786) 0680PREMIUM (0680-773-648)	http://www.samsung.com/hu/support
ITALIA	800-SAMSUNG (800.7267864)	www.samsung.com/it/support
LUXEMBURG	261 03 710	www.samsung.com/be_fr/support
MONTENEGRO	020 405 888	www.samsung.com/support
SLOVENIA	080 697 267 (brezplačna številka)	www.samsung.com/si/support
NETHERLANDS	0900-SAMSUNG (0900-7267864) (€ 0,10/Min)	www.samsung.com/nl/support
NORWAY	815 56480	www.samsung.com/no/support
POLAND	801-172-678* lub +48 22 607-93-33* * (koszt połączenia według taryfy operatora)	www.samsung.com/pl/support
PORTUGAL	808 20 7267	www.samsung.com/pt/support
ROMANIA	*8000 (apel in retea) 08008-726-78-64 (08008-SAMSUNG) Apel GRATUIT	www.samsung.com/ro/support
SERBIA	011 321 6899	www.samsung.com/rs/support
SLOVAKIA	0800 - SAMSUNG (0800-726 786)	www.samsung.com/sk/support
SPAIN	34902172678	www.samsung.com/es/support
SWEDEN	0771 726 7864 (0771-SAMSUNG)	www.samsung.com/se/support
SWITZERLAND	0800 726 78 64 (0800-SAMSUNG)	www.samsung.com/ch/support (German) www.samsung.com/ch_fr/support (French)
UK	0330 SAMSUNG (7267864)	www.samsung.com/uk/support
EIRE	0818 717100	www.samsung.com/ie/support
LITHUANIA	8-800-77777	www.samsung.com/lt/support
LATVIA	8000-7267	www.samsung.com/lv/support
ESTONIA	800-7267	www.samsung.com/ee/support
TURKEY	444 77 11	www.samsung.com/tr/support