

SAMSUNG

FULL MANUAL

HW-Q930B / HW-Q800B / HW-Q700B

Imagine the possibilities

Thank you for purchasing this Samsung product.

To receive more complete service, please register your product at www.samsung.com/register









SAFETY INFORMATION

SAFETY WARNINGS

TO REDUCE THE RISK OF ELECTRIC SHOCK, DO NOT REMOVE THE COVER (OR BACK).

NO USER-SERVICEABLE PARTS ARE INSIDE. REFER SERVICING TO QUALIFIED SERVICE PERSONNEL.

Refer to the table below for an explanation of symbols which may be on your Samsung product.

	CAUTION RISK OF ELECTRIC SHOCK. DO NOT OPEN.	
	This symbol indicates that high voltage is present inside. It is dangerous to make any kind of contact with any internal part of this product.	
	This symbol indicates that this product has included important literature concerning operation and maintenance.	
	Class II product : This symbol indicates that a safety connection to electrical earth (ground) is not required. If this symbol is not present on a product with a power cord, the product MUST have a reliable connection to protective earth (ground).	
	AC voltage : Rated voltage marked with this symbol is AC voltage.	
	DC voltage : Rated voltage marked with this symbol is DC voltage.	
	Caution. Consult Instructions for use : This symbol instructs the user to consult the user manual for further safety related information.	

WARNING

- To reduce the risk of fire or electric shock, do not expose this appliance to rain or moisture.

CAUTION

- TO PREVENT ELECTRIC SHOCK, MATCH WIDE BLADE OF PLUG TO WIDE SLOT, FULLY INSERT.
- This apparatus shall always be connected to a AC outlet with a protective grounding connection.
- To disconnect the apparatus from the mains, the plug must be pulled out from the mains socket, therefore the mains plug shall be readily operable.
- Do not expose this apparatus to dripping or splashing. Do not put objects filled with liquids, such as vases, on the apparatus.
- To turn this apparatus off completely, you must pull the power plug out of the wall socket. Consequently, the power plug must be easily and readily accessible at all times.

PRECAUTIONS

1. Ensure that the AC power supply in your house complies with the power requirements listed on the identification sticker located on the bottom of your product. Install your product horizontally, on a suitable base (furniture), with enough space around it for ventilation (7~10 cm). Make sure the ventilation slots are not covered. Do not place the unit on amplifiers or other equipment which may become hot. This unit is designed for continuous use. To fully turn off the unit, disconnect the AC plug from the wall outlet. Unplug the unit if you intend to leave it unused for a long period of time.
2. During thunderstorms, disconnect the AC plug from the wall outlet. Voltage peaks due to lightning could damage the unit.
3. Do not expose the unit to direct sunlight or other heat sources. This could lead to overheating and cause the unit to malfunction.
4. Protect the product from moisture (i.e. vases), and excess heat (e.g. a fireplace) or equipment creating strong magnetic or electric fields. Unplug the power cable from the AC wall socket if the unit malfunctions. Your product is not intended for industrial use. It is for personal use only. Condensation may occur if your product has been stored in cold temperatures. If transporting the unit during the winter, wait approximately 2 hours until the unit has reached room temperature before using.
5. The battery used with this product contains chemicals that are harmful to the environment. Do not dispose of the battery in the general household trash. Do not expose the battery to excess heat, direct sunlight, or fire. Do not short circuit, disassemble, or overheat the battery.
CAUTION : Danger of explosion if the battery is replaced incorrectly. Replace only with the same or equivalent type.

CONTENTS

01	Checking the Components	6
02	Product Overview	7
	Top Panel of the Soundbar	7
	Bottom Panel of the Soundbar	8
03	Using the Soundbar Remote Control	9
	Inserting Batteries before using the Remote Control (AAA batteries X 2)	9
	How to Use the Remote Control	9
	Active Voice Amplifier (AVA)	11
	Using the Hidden Buttons (Buttons with more than one function)	11
	Output specifications for the different sound effect modes	11
	Adjusting the Soundbar volume with a TV remote control	13
04	Connecting the Soundbar	14
	Connecting the power and units	14
	– Recommended Speaker Layout	15
	– Surround speaker mode (HW-Q930B only)	15
	– Manually connecting the Subwoofer or Surround Speakers	16
	– LED Indicator Lights on the Rear of Subwoofer and Surround Speakers	17
05	Connecting to a TV	18
	Connecting the TV that supports HDMI ARC (Audio Return Channel)	18
	Connecting using an Optical Cable	19
	Connecting via Bluetooth	20
	Connecting via Wi-Fi	22
	Using the Q-Symphony Function	23
	Using the Spacefit sound	24
06	Connecting an External Device	25
	Method 1. Connecting using an HDMI Cable (Capable of Dolby Atmos / DTS:X decoding and playback)	25
	Method 2. Connecting using an Optical Cable	26
07	Connecting a Mobile Device	27
	Method 1. Connecting via Bluetooth	27
	Method 2. Connecting via Wi-Fi (Wireless Network)	29
	Using the Tap Sound	30
08	Connecting via Apple Airplay 2	31
09	Installing the Wall Mount	32
	Installation Precautions	32
	Wallmount Components	32
	Installing the Surround Speakers on a Wall (applicable models only)	33

10	Installing the Soundbar in front of TV	33
	Component	33
11	Software Update	34
	Auto Update.....	34
	USB Update	34
	Initialisation.....	35
12	Troubleshooting	35
13	Licence	37
14	Open Source Licence Notice	37
15	Important Notes About Service	37
16	Specifications and Guide	38
	Specifications	38

01 CHECKING THE COMPONENTS



Soundbar Main Unit



Soundbar Remote Control / Batteries



Subwoofer



Surround Speaker (optional)
(Left / Right)



Power Cord
(Subwoofer, Surround Speaker, Soundbar)
(optional)



HDMI Cable



Wall Mount Guide



Holder-Screw



x 2
(M4 x L10)

Screw



Bracket-Wall Mount



Rubber-Foot

- For more information about the power supply and power consumption, refer to the label attached to the product. (Label: Rear of the Soundbar Main Unit)
- To purchase additional components or optional cables, contact a Samsung Service Centre or Samsung Customer Care.
- For more information about the wallmount or rubber-foot, see pages 32~34.
- Design, specifications, and App screen are subject to change without prior notice.
- The appearance of the accessories may differ slightly from the illustrations above.

02 PRODUCT OVERVIEW

Top Panel of the Soundbar

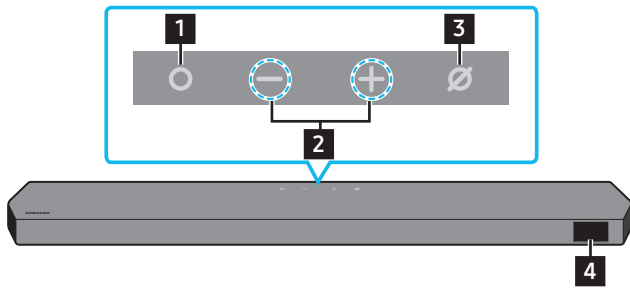

HW-Q930B / HW-Q800B

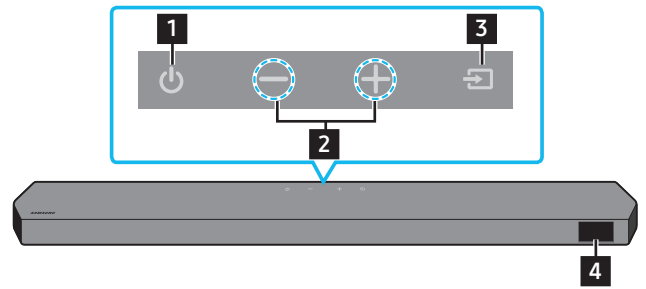

HW-Q700B

1	<p>○ (Multi Function) Button (Q930B / Q800B models)</p> <ul style="list-style-type: none"> In standby mode, press the ○ (Multi Function) button to turn on the Soundbar. Press the ○ (Multi Function) button to change the input source.
1	<p>⏻ (Power) Button (Q700B model)</p> <p>Turns the power on and off.</p>
2	<p>− + (Volume) Button</p> <p>Adjusts the volume.</p>
3	<p>⊘ (Mic On/Off) Button (Q930B / Q800B models)</p> <p>Press the button to turn the microphone on or off. When the microphone is off, the LED indicator will light red.</p>
3	<p>➡ (Source) Button (Q700B model)</p> <p>Press the ➡ (Source) button to change the input source.</p>
4	<p>Display</p> <p>Displays the product's status and current mode. D.IN → HDMI → Wi-Fi → BT</p>

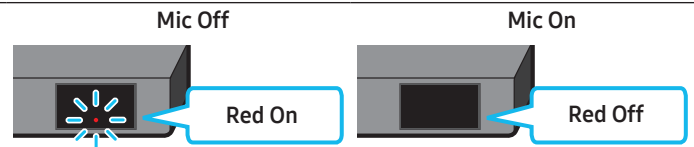

- When you plug in the AC cord, the power button will begin working in 4 to 6 seconds.
- When you turn on this unit, there will be a 4 to 5 second delay before it produces sound.
- If you hear sounds from both the TV and Soundbar, go to the **Settings** menu for the TV audio and change the TV speaker to **External Speaker**.

Bottom Panel of the Soundbar

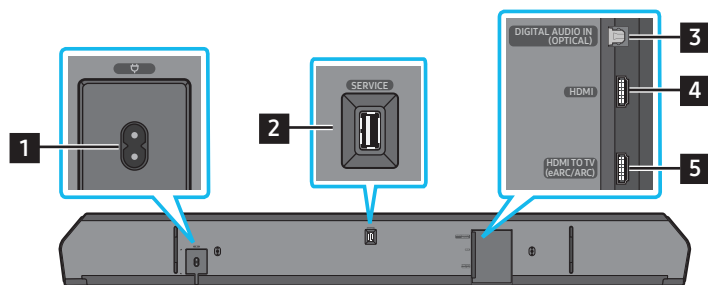

1	POWER Connect the Soundbar's AC power cable. (See page 14)
2	SERVICE Connect a USB storage device to upgrade the product's software.
3	DIGITAL AUDIO IN (OPTICAL) Connect to the digital (optical) output of an external device. (See page 26)
6	HDMI Inputs digital video and audio signals simultaneously using an HDMI cable. Connect to the HDMI output of an external device. (See page 25)
7	HDMI TO TV (eARC/ARC) Connect to the HDMI jack on a TV. (See page 18)

- When disconnecting the power cord from a wall outlet, pull the plug. Do not pull the cable.
- Do not connect this unit or other components to an AC outlet until all connections between components are complete.

03 USING THE SOUNDBAR REMOTE CONTROL





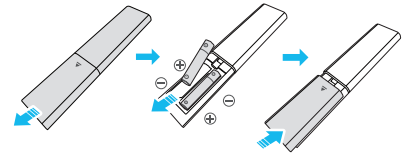

Inserting Batteries before using the Remote Control (AAA batteries X 2)

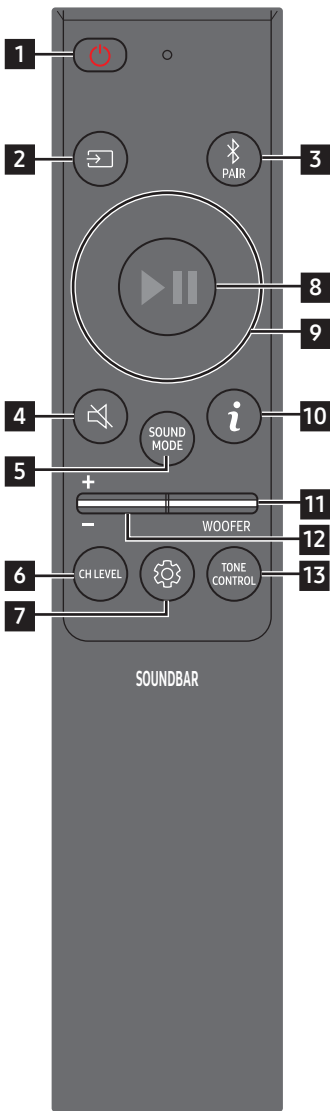









Slide the back cover in the direction of the arrow until it is completely removed. Insert 2 AAA batteries (1.5V) oriented so that their polarity is correct. Slide the battery cover back into position.

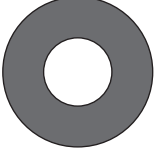

How to Use the Remote Control

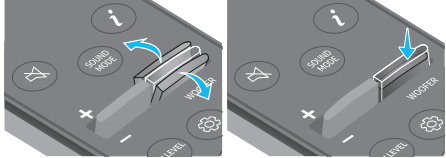

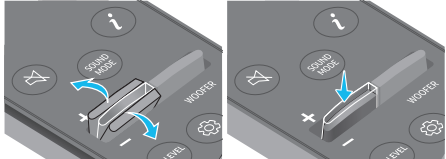
1	 Power	Turns the Soundbar on and off. <ul style="list-style-type: none"> • Auto Power Down Function The unit turns off automatically in the following situations: <ul style="list-style-type: none"> • In D.IN / HDMI / Wi-Fi / BT mode if there is no audio signal for 18 minutes.
2	 Source	Press to select a source connected to the Soundbar.
3	 Bluetooth PAIR	Switch the Soundbar to Bluetooth pairing mode. Press the button and wait for the “ BT PAIRING ” screen to connect to a new Bluetooth device.
4	 Mute	Press the  (Mute) button to mute the sound. Press it again to unmute the sound.
5	 SOUND MODE	By pressing the button, you can select the desired audio mode such as Surround, Game, Standard, Adaptive sound . <ul style="list-style-type: none"> • Standard Outputs the original sound. • Surround Provides a wider sound field than standard. • Game Provides stereoscopic sound to immerse you in the action while gaming. • Adaptive sound Analyzes the content in real time and automatically provides the optimal sound field based on the characteristics of the content.
6	 CH LEVEL	By pressing the button, you can adjust the volume of the each speaker such as Centre level, Side level, Wide level, Front Top level, Rear level, and Rear top level . <ul style="list-style-type: none"> • To control the volume of the each speaker select Centre level, Side level, Wide level, or Front Top level in Sound Settings, and then adjust the volume between -6~+6 by using the Up/Down buttons. • If Surround Speakers are connected, select Rear level or Rear top level and then use the Up/Down buttons to adjust the volume within a -6 to +6 range. • CH LEVEL specifications may differ with the respective model.

<p>7</p>	 <p>Sound Control</p>	<p>By pressing the button, you can set the audio function such as Spacefit sound, AVA, Voice enhance mode, Night mode, Sync, Surround speaker mode, Virtual. The desired item can be adjusted using the Up/Down buttons.</p> <ul style="list-style-type: none"> • The Spacefit sound and AVA functions are not supported by Q700B model. • Voice enhance mode enhances spoken dialog in movies and TV to make it easier to hear. • Night mode is optimized for night time viewing with the settings adjusted to bring the volume down but keep the dialog clear. • Press and hold the  (Sound Control) button for about 5 seconds to adjust the sound for each frequency band. 150Hz, 300Hz, 600Hz, 1.2kHz, 2.5kHz, 5kHz, and 10kHz are selectable using the Left/Right buttons and each can be adjusted to a setting between -6 to +6 using the Up/Down buttons. (Make sure the Sound mode is set to “Standard”.) • If the video on the TV and audio from the Soundbar are not synchronized, select Sync in Sound Control, and then set the audio delay between 0~300 milliseconds by using the Up/Down buttons. • Sync is only supported for some functions. • Available Surround speaker mode settings are supported only by Q930B model. • The Virtual Speaker function can be turned ON/OFF by using the Up/Down buttons.
<p>8</p>	 <p>Play / Pause</p>	<p>You can also play or pause music by pressing the button.</p>
<p>9</p>	 <p>Up/Down/Left/Right</p>	 <p>Press the indicated areas to select Up/Down/Left/Right.</p> <p>Press Up/Down/Left/Right on the button to select or set functions.</p> <ul style="list-style-type: none"> • Music Skip Press the Right button to select the next music file. Press the Left button to select the previous music file. • ID SET Use this option when the Subwoofer or Surround Speakers are not connected or need reconnection. While powered off, press and hold the Up button for 5 seconds to perform ID SET. (See page 16.)
<p>10</p>	 <p>Info</p>	<p>Press to display information about the active function or the codec available. In BT mode, it displays the connected device (when pairing is complete) or “BT ready” (when pairing is required).</p>
<p>11</p>	 <p>WOOFER LEVEL</p>	 <p>Push the button up or down to adjust the level of the woofer (bass).</p>
<p>12</p>	 <p>VOLUME</p>	 <p>Push the button up or down to adjust the volume.</p> <ul style="list-style-type: none"> • Mute Press the VOL button to mute the sound. Press it again to unmute the sound.
<p>13</p>	 <p>TONE CONTROL</p>	<p>By pressing the button, you can adjust the volume of the treble or bass sound. The defined item can be adjusted using the Up/Down buttons. This function is enabled in Sound mode excluding in Standard mode.</p> <ul style="list-style-type: none"> • To control the volume of the treble or bass sound, select TREBLE or BASS in Sound Settings, and then adjust the volume between -6~+6 by using the Up/Down buttons. • Once the bass level is changed, the woofer level will be also adjusted accordingly.

Active Voice Amplifier (AVA)

- Analyzes external noise in real time while soundbar is playing, so that voice audio can always be heard clearly.
- No data is saved during the analysis.
- This function is not supported by **Q700B** model.

Using the Hidden Buttons (Buttons with more than one function)

Hidden Button		Reference page
Remote Control Button	Function	
WOOFER (Up)	TV remote control On/Off (Standby)	page 13
Up	ID SET	page 16
 (Sound Control)	7 Band EQ	page 10

Output specifications for the different sound effect modes

<HW-Q930B>

Effect	Input	Output
		With Subwoofer & Surround Speaker
Standard	2.0 ch	2.1 ch
	5.1 ch	5.1 ch / 7.1 ch (DTS)
	7.1 ch	7.1 ch
	Dolby Atmos®, DTS:X	7.1.4 ch
Surround	2.0 ch	9.1.4 ch
	5.1 ch	9.1.4 ch
	7.1 ch	9.1.4 ch
	Dolby Atmos®, DTS:X	9.1.4 ch
Game	2.0 ch	9.1.4 ch
	5.1 ch	9.1.4 ch
	7.1 ch	9.1.4 ch
	Dolby Atmos®, DTS:X	9.1.4 ch
Adaptive sound	2.0 ch	9.1.4 ch
	5.1 ch	9.1.4 ch
	7.1 ch	9.1.4 ch
	Dolby Atmos®, DTS:X	9.1.4 ch

<HW-Q800B>

Effect	Input	Output	
		With Subwoofer Only	With Subwoofer & Surround Speaker
Standard	2.0 ch	2.1 ch	2.1 ch
	5.1 ch	5.1 ch	5.1 ch / 7.1 ch (DTS)
	7.1 ch	5.1 ch	7.1 ch
	Dolby Atmos®, DTS:X	5.1.2 ch	7.1.4 ch
Surround	2.0 ch	5.1.2 ch	7.1.4 ch
	5.1 ch	5.1.2 ch	7.1.4 ch
	7.1 ch	5.1.2 ch	7.1.4 ch
	Dolby Atmos®, DTS:X	5.1.2 ch	7.1.4 ch
Game	2.0 ch	5.1.2 ch	7.1.4 ch
	5.1 ch	5.1.2 ch	7.1.4 ch
	7.1 ch	5.1.2 ch	7.1.4 ch
	Dolby Atmos®, DTS:X	5.1.2 ch	7.1.4 ch
Adaptive sound	2.0 ch	5.1.2 ch	7.1.4 ch
	5.1 ch	5.1.2 ch	7.1.4 ch
	7.1 ch	5.1.2 ch	7.1.4 ch
	Dolby Atmos®, DTS:X	5.1.2 ch	7.1.4 ch

<HW-Q700B>

Effect	Input	Output	
		With Subwoofer Only	With Subwoofer & Surround Speaker
Standard	2.0 ch	2.1 ch	2.1 ch
	5.1 ch	3.1 ch	5.1 ch
	Dolby Atmos®, DTS:X	3.1.2 ch	5.1.4 ch
Surround	2.0 ch	3.1.2 ch	5.1.4 ch
	5.1 ch	3.1.2 ch	5.1.4 ch
	Dolby Atmos®, DTS:X	3.1.2 ch	5.1.4 ch
Game	2.0 ch	3.1.2 ch	5.1.4 ch
	5.1 ch	3.1.2 ch	5.1.4 ch
	Dolby Atmos®, DTS:X	3.1.2 ch	5.1.4 ch
Adaptive sound	2.0 ch	3.1.2 ch	5.1.4 ch
	5.1 ch	3.1.2 ch	5.1.4 ch
	Dolby Atmos®, DTS:X	3.1.2 ch	5.1.4 ch

The Surround Speakers will not produce sounds for 2 channel output while **Standard** mode is in use. To enable sound for the Surround Speakers, change the effect mode to **Surround**.

Adjusting the Soundbar volume with a TV remote control





Adjust the Soundbar volume using the TV's remote control.

- This function can be used with IR remote controls only. Bluetooth remote controls (remote controls that require pairing) are not supported.
- Set the TV speaker to **External Speaker** to use this function.
- Manufacturers supporting this function:
Samsung, VIZIO, LG, Sony, Sharp, PHILIPS, PANASONIC, TOSHIBA, Hisense, RCA

1. Turn Off the Soundbar.

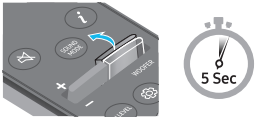
2. Push up and hold the **WOOFER** button for 5 seconds.

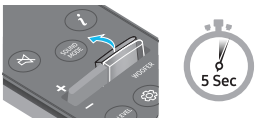
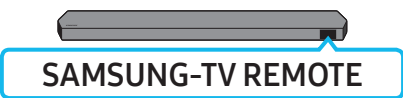
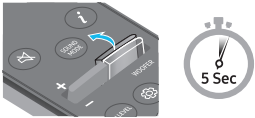
Each time you push the **WOOFER** button up and hold it for 5 seconds, the mode switches in the following order: "OFF-TV REMOTE" (Default mode), "SAMSUNG-TV REMOTE", "ALL-TV REMOTE".

Remote Control Button	Display	Status
	(Default mode) 	Disable the TV remote control.
		Enable a Samsung TV's IR remote control.
		Enable a third-party TV's IR remote control.

04 CONNECTING THE SOUNDBAR

Connecting the power and units

Use the Power cord to connect the Subwoofer, Surround Speakers, and Soundbar to an electrical outlet in the following order:

- For more information about the required electrical power and power consumption, refer to the label attached to the product. (Label: Rear of the Soundbar Main Unit)

1. Connect the Power cord to the Subwoofer.

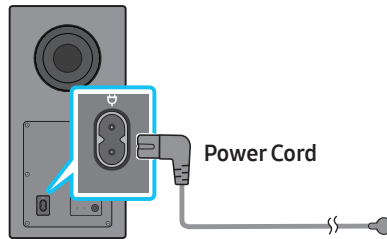

Rear of Subwoofer

2. Connect the power cord to the Left and Right Surround Speakers. (optional)

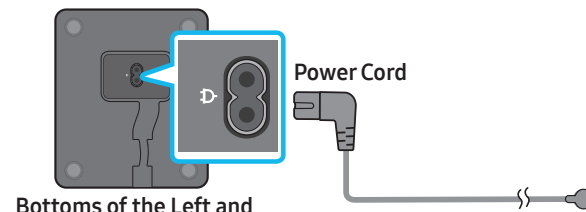

Bottoms of the Left and Right Surround Speakers (optional)

3. Connect the Power cord to the Soundbar.

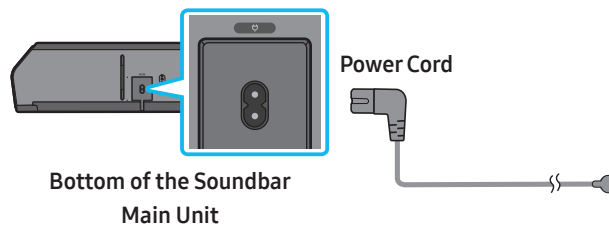

Bottom of the Soundbar Main Unit

4. Connect power to the Soundbar, Subwoofer and Surround Speakers. The Subwoofer and Surround Speakers are automatically connected when the Soundbar is turned on.

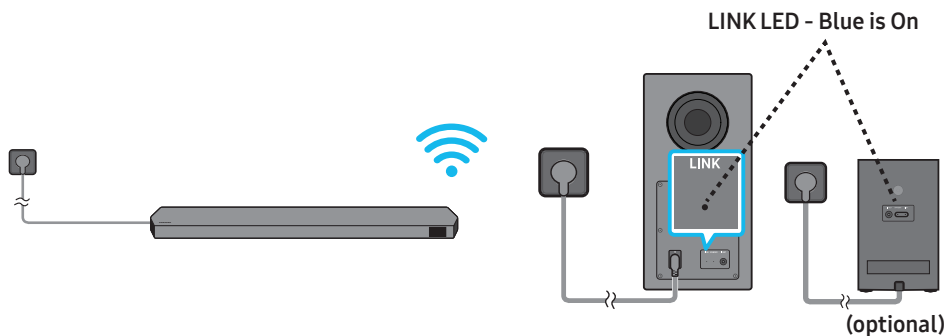

NOTE

- Connect the Subwoofer and Surround Speakers power before connecting to the Soundbar. The Subwoofer and Surround Speakers will be automatically connected when turning on the Soundbar.
- If you unplug and reconnect the power cord when the product is turned on, the Soundbar turns on automatically.
- The surround speaker system is supported by applicable models only.

Recommended Speaker Layout

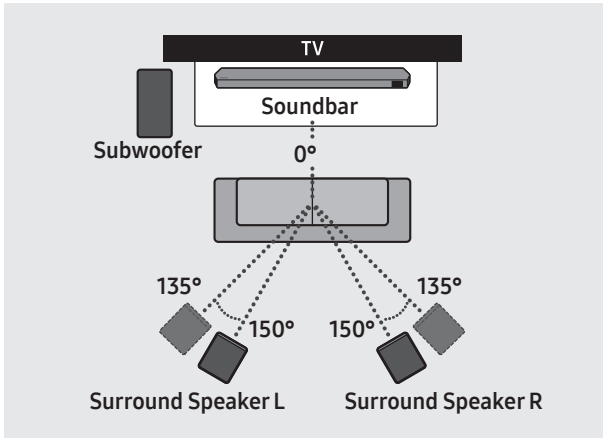

⚠ CAUTION

- Wireless receiving antennas are built into the wireless subwoofer and surround speakers. Keep the units away from water and moisture.
- For optimal listening performance, make sure that the areas around the wireless subwoofer and surround speakers locations are clear of any obstructions.

Surround speaker mode (HW-Q930B only)

An optimal surround sound may be delivered depending on the position of the rear speaker. See the illustration below for speaker positioning. To activate this mode, select the Surround Speaker mode using the remote control of the Soundbar.

(⚙ (Sound Control) → Surround speaker → ▲ (Up) / ▼ (Down) → Front / Rear)

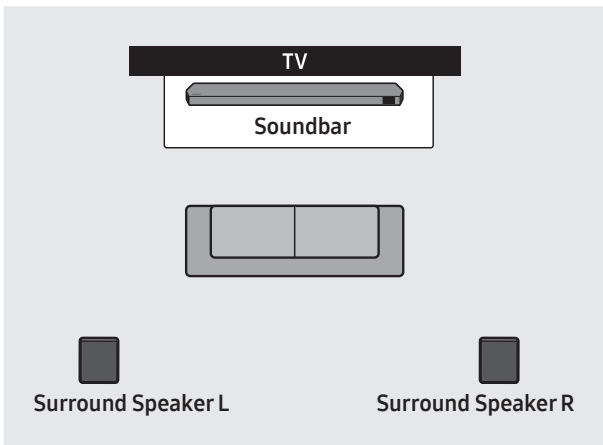

Rear positioning

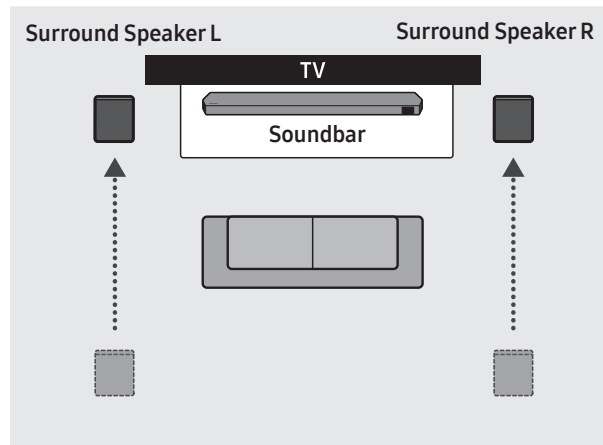

Front positioning

NOTE

- This mode is available only with Soundbar models including a specific surround speaker.
- In Front speaker mode, position the front speakers toward you.
- The Rear Speaker mode is enabled by default.

Manually connecting the Subwoofer or Surround Speakers

Before performing the manual connection procedure below:

- Check whether the power cables for the Soundbar and subwoofer or Surround Speakers are connected properly.
- Make sure that the Soundbar is turned off.

1. Turn off the Soundbar main.
2. Press and hold **ID SET** on the rear of the subwoofer and surround speakers for at least 5 seconds.
 - The red indicator at the rear of each speaker turns off and the blue indicator blinks.

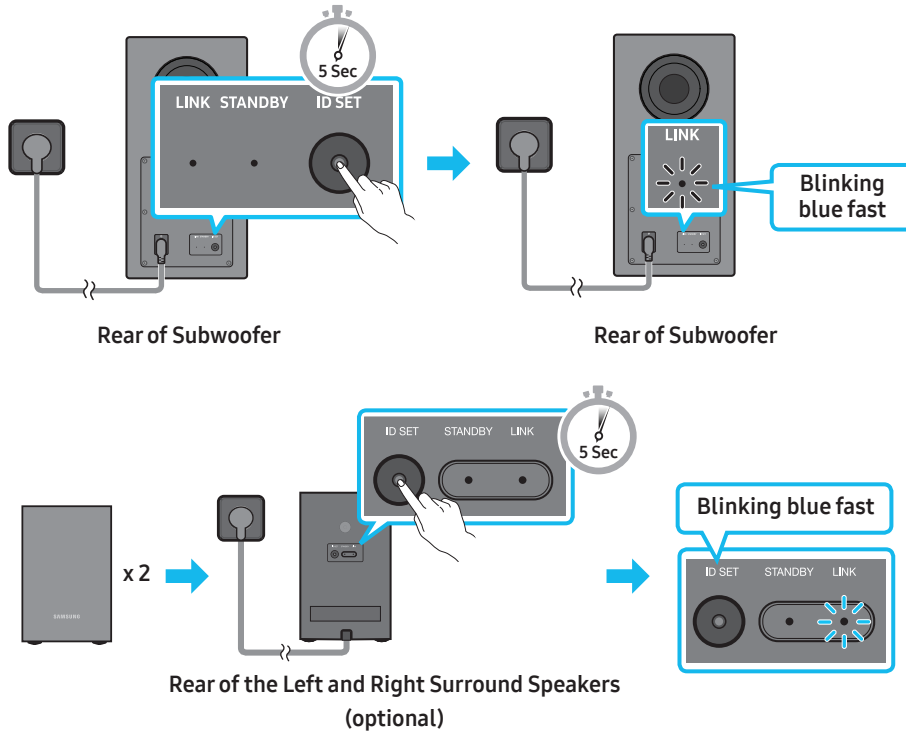

3. Press the **Up** button on the remote control for 5 seconds.
 - The **ID SET** message appears on the display of the Soundbar for a moment, and then it disappears.
 - The Soundbar will automatically power on when **ID SET** is complete.

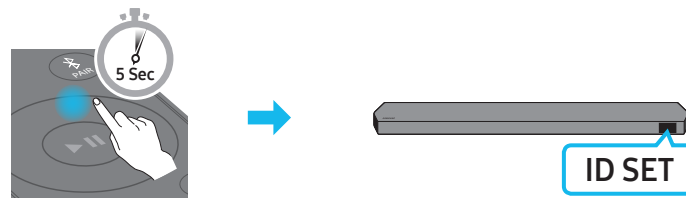

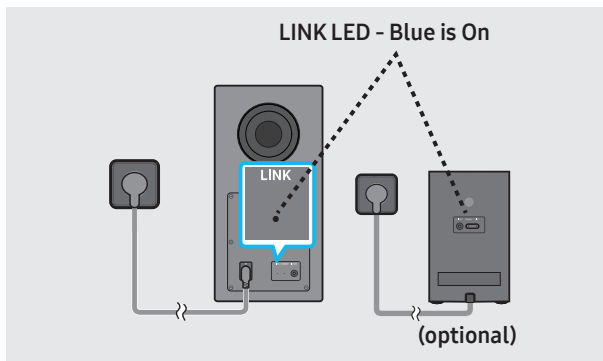

4. Check if the LINK LED is solid blue (connection complete).

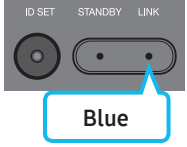
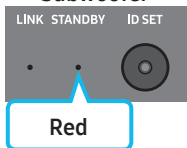
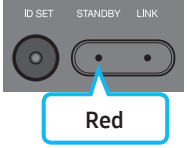
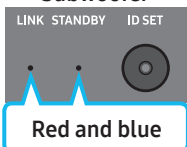
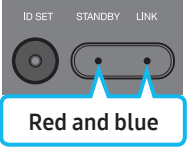
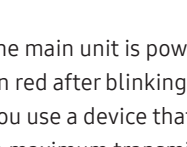
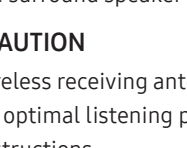

The LINK LED indicator stops blinking and glows a solid blue when a connection is established between the Soundbar and the Wireless Subwoofer, surround speakers.

LED Indicator Lights on the Rear of Subwoofer and Surround Speakers

LED	Status	Description	Resolution
<p>Subwoofer</p>  <p>Blue</p> <p>Surround Speakers (applicable models only)</p>  <p>Blue</p>	On	Successfully connected (normal operation)	-
<p>Subwoofer</p>  <p>Blue</p> <p>Surround Speakers (applicable models only)</p>  <p>Blue</p>	Blinking	Recovering the connection	Check if the power cable attached to the main Soundbar unit is connected properly or wait about 5 minutes. If blinking persists, try manually connecting the subwoofer and Surround Speakers. See page 16.
<p>Subwoofer</p>  <p>Red</p> <p>Surround Speakers (applicable models only)</p>  <p>Red</p>	On	Standby (with the Soundbar main unit turned off)	Check if the power cable attached to the main Soundbar unit is connected properly.
<p>Subwoofer</p>  <p>Red and blue</p> <p>Surround Speakers (applicable models only)</p>  <p>Red and blue</p>	On	Connection failed	Connect again. See the instructions for manual connection on page 16.
<p>Subwoofer</p>  <p>Red and blue</p> <p>Surround Speakers (applicable models only)</p> <p>Red and blue</p>	Blinking	Malfunction	See the contact information for the Samsung Service Centre in this manual.

NOTE

- If the main unit is powered off, the wireless subwoofer will go into stand-by mode and the STANDBY LED on the rear of the sub-woofer will turn red after blinking in blue several times.
- If you use a device that uses the same frequency as the Soundbar near the Soundbar, interference may cause some sound interruption.
- The maximum transmission distance of the main unit's wireless signal is about 10 m, but may vary depending on your operating environment. If a steel-concrete or metallic wall is between the main unit and the wireless subwoofer, the system may not operate at all because the wireless signal cannot penetrate metal.
- The surround speaker system is supported by applicable models only.

⚠ CAUTION

- Wireless receiving antennas are built into the wireless subwoofer and Surround Speakers. Keep the unit away from water and moisture.
- For optimal listening performance, make sure that the area around the wireless subwoofer and the Surround Speakers are clear of any obstructions.

05 CONNECTING TO A TV

Connecting the TV that supports HDMI ARC (Audio Return Channel)

⚠ CAUTION

- When both the HDMI cable and optical cable are connected, the HDMI signal is received first.
- To connect the HDMI cable between the TV and Soundbar, be sure to connect the terminals marked ARC. Otherwise, the TV sound may not be output.
- The recommended cable is **High Speed HDMI Cable with Ethernet**.

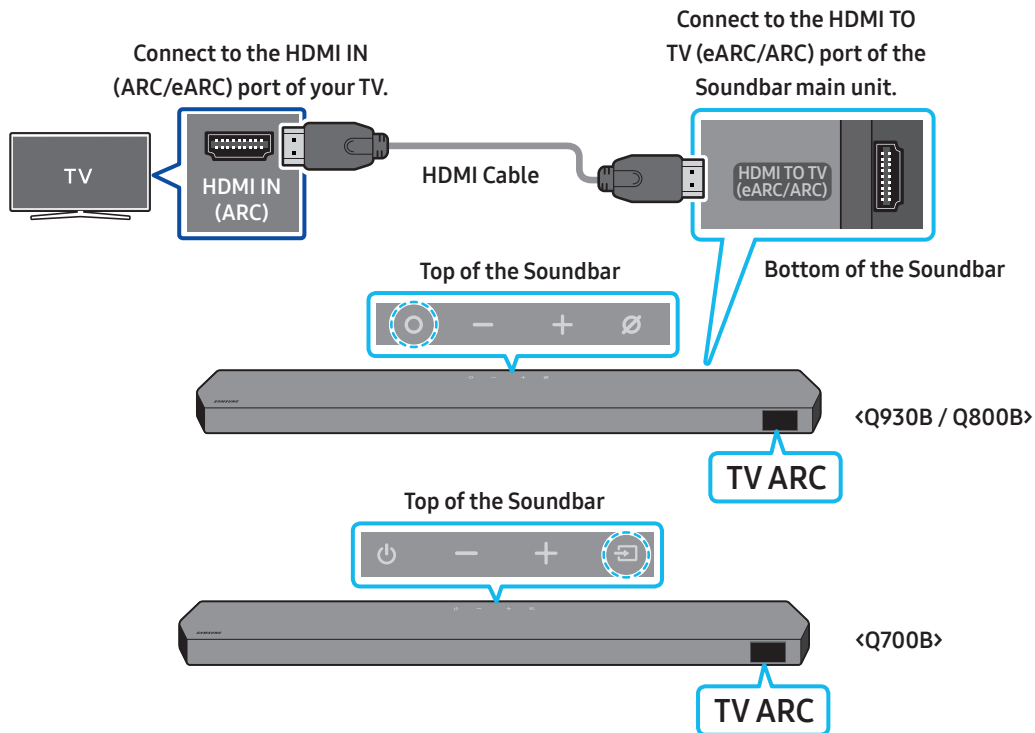

1. With the Soundbar and TV turned off, connect the HDMI cable as shown in the figure.
2. Turn on the Soundbar and TV.
3. "TV ARC" appears in the display window of the Soundbar main unit and the Soundbar plays TV sound.
 - When the TV sound is not output, press the **○ (Multi Function)** / **↔ (Source)** button at the top of the Soundbar or the **↔ (Source)** button on the remote control to select the "D.IN" mode. The screen displays "D.IN" and "TV ARC" in sequence, and TV sound is played.
 - When connecting a TV that supports the eARC function, "eARC" appears on the display and the sound is heard.
 - To connect with eARC, the eARC function in the TV menu should be set to On. Refer to the TV user manual for details on setting. (e.g. Samsung TV : Home (🏠) → Menu → Settings (⚙) → All Settings (⚙) → Sound → Expert Settings → HDMI-eARC Mode (Auto))
 - If "TV ARC" does not appear in the display window of the Soundbar main unit, confirm that the HDMI cable is connected to the correct port.
 - Use the volume buttons on the TV's remote control to change the volume on the Soundbar.

NOTE

- When you connect the TV that supports the HDMI ARC (Audio Return Channel) to the Soundbar with an HDMI cable, you can transmit the digital video and audio data without connecting a separate optical cable.
- We recommend you use a coreless HDMI cable if possible. If you use a cored HDMI cable, use one whose diameter is less than 14 mm.
- This function is not available if the HDMI cable does not support ARC.
- When the audio in a broadcast is encoded in Dolby Digital and the "Digital Output Audio Format" on your TV is set to PCM, we recommend that you change the setting to Dolby Digital. When the setting on the TV is changed, you will experience better sound quality. (The TV menu may use different words for Dolby Digital and PCM depending on the TV manufacturer.)
- The ARC/eARC protocols support Dolby Atmos.
- Make sure that the content supports Dolby Atmos®.

Connecting using an Optical Cable

Pre-connection Checklist

- When both the HDMI cable and optical cable are connected, the HDMI signal is received first.
- When you use an optical cable and the terminals have covers, be sure to remove the covers.

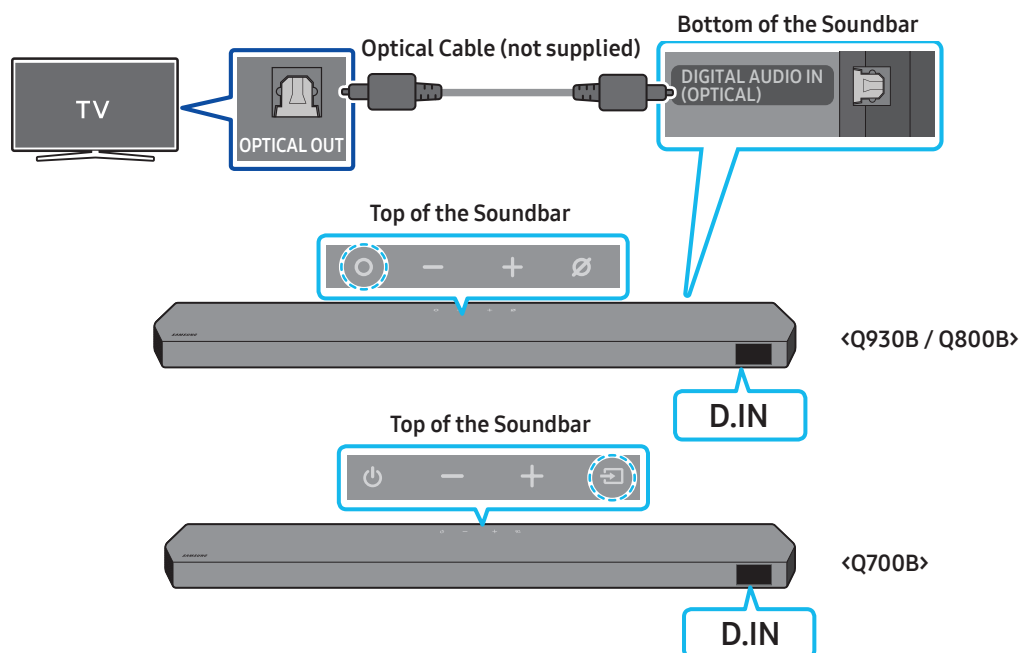

1. With the TV and Soundbar turned off, connect the **DIGITAL AUDIO IN (OPTICAL)** port on the Soundbar and the **OPTICAL** output port on the TV with the optical cable (not supplied), as shown in the figure.
2. Turn on the Soundbar and TV.
3. Press the **Multi Function** / **Source** button at the top of the Soundbar or the **Source** button on the remote control to select the "D.IN" mode.
4. The TV sound is output from the Soundbar.

Connecting via Bluetooth

When a Samsung TV is connected using Bluetooth, you can hear stereo sound without the hassle of cabling.

- Only one Samsung TV can be connected at a time.
- Samsung TV that supports Bluetooth can be connected. Check the specifications of your TV.

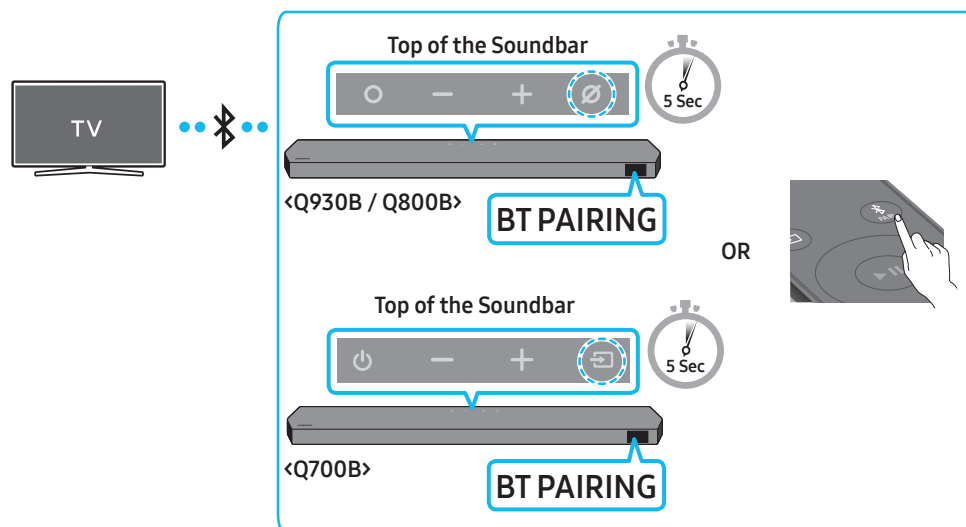

The initial connection

1. Press the **PAIR** button on the Soundbar remote control to enter the “**BT PAIRING**” mode.
(OR) a. Press the **Multi Function** / **Source** button on the top panel and then select “**BT**”.
“**BT**” changes to “**BT PAIRING**” in a few seconds automatically or changes to “**BT READY**” if there is a connect record.
b. When “**BT READY**” appears, press and hold the **Mic On/Off** / **Source** button on the top panel of the Soundbar for more than 5 seconds to display “**BT PAIRING**”.
2. Select Bluetooth mode on the Samsung TV.
(e.g. Home (🏠) → Menu → Settings (⚙️) → All Settings (⚙️) → Sound → Sound Output → Bluetooth Speaker List → Soundbar Q***B (Bluetooth))
3. Select “**Soundbar Q***B**” from the list on TV’s screen.
An available Soundbar is indicated with “**Need Pairing**” or “**Paired**” on the TV’s Bluetooth device list. To connect the Samsung TV to the Soundbar, select the message, and then establish a connection.
 - When the Samsung TV is connected, [TV Name] → “**BT**” appears on the Soundbar’s front display.
4. You can now hear Samsung TV sound from the Soundbar.
 - After you have connected the Soundbar to your Samsung TV the first time, use the “**BT READY**” mode to reconnect.

If the device fails to connect

- If you have an existing Soundbar (e.g., **Soundbar Q***B**) on the list of speakers on the Samsung TV, delete it.
- Then repeat steps 1 through 3.

Disconnecting the Soundbar from the Samsung TV

Press the **Multi Function** / **Source** button at the top of the Soundbar or the **Source** button on the remote control to select the mode other than “**BT**”.

- Disconnecting takes time because the Samsung TV must receive a response from the Soundbar.
(The time required may differ, depending on the Samsung TV model.)

What is the difference between BT READY and BT PAIRING?

- **BT READY** : In this mode, you can reconnect any Samsung TV or mobile device that was connected before.
- **BT PAIRING** : In this mode, you can connect a new device to the Soundbar.
(Press the **PAIR** button on the Soundbar remote control or press and hold the **⊘ (Mic On/Off)** / **↔ (Source)** button on the top of the Soundbar for more than 5 seconds while the Soundbar is in “BT” mode.)

Notes on Bluetooth connection

- Locate a new device within 1 m to connect via Bluetooth communication.
- If asked for a PIN code when connecting a Bluetooth device, enter <0000>.
- The Soundbar automatically turns off after 18 minutes in the Ready state.
- The Soundbar may not perform Bluetooth search or connection correctly under the following circumstances:
 - If there is a strong electrical field around the Soundbar.
 - If several Bluetooth devices are simultaneously paired with the Soundbar.
 - If the Bluetooth device is turned off, not in place, or malfunctions.
- Electronic devices may cause radio interference. Devices that generate electromagnetic waves must be kept away from the Soundbar main unit - e.g., microwaves, wireless LAN devices, etc.

Connecting via Wi-Fi

Pre-connection Checklist

- Wi-Fi connection is available only on Samsung TV.
- Check whether **the wireless router (Wi-Fi)** is turned on and **the TV is connected to the router**.
- The TV and Soundbar must be connected to the same wireless network (Wi-Fi).
- If your wireless router (Wi-Fi) uses a DFS channel, you will not be able to establish a Wi-Fi connection between the TV and Soundbar. Contact your Internet service provider for details.
- Because the menus may differ depending on the year of manufacture, refer to your TV manual.
- To connect the TV to the Soundbar via Wi-Fi, connect the Soundbar to the wireless router first. See page 29, for details on how to establish a Wi-Fi connection.

1. For more information about Wi-Fi connection to the Soundbar, see page 29, "**Method 2. Connecting via Wi-Fi (Wireless Network)**".
2. Change the input source of the TV by using the Audio menu to Soundbar.

- **Samsung TVs released in 2017 or later**

Home (🏠) → Menu → Settings (⚙️) → All Settings (⚙️) → Sound → Sound Output → Soundbar Q***B (Wi-Fi)

NOTE

The Wi-Fi Dolby Atmos connection is available in some Samsung TVs and some Soundbar models.

Using the Q-Symphony Function

For Q-Symphony, the Soundbar syncs with a Samsung TV to output sound through two devices for optimum surround effect. When the Soundbar is connected, the menu, "TV+Soundbar" appears under the **Sound Output** menu of the TV. Select the corresponding menu.

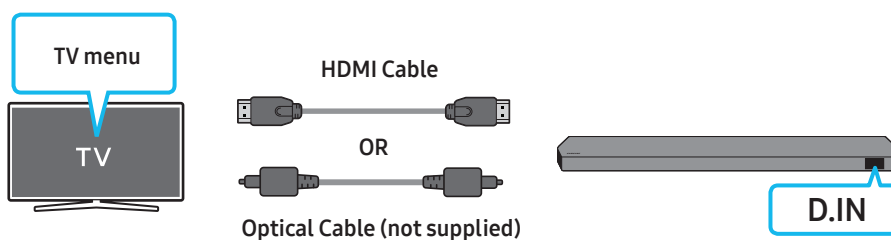

- TV menu example: **TV + [AV] Soundbar series name (HDMI)**

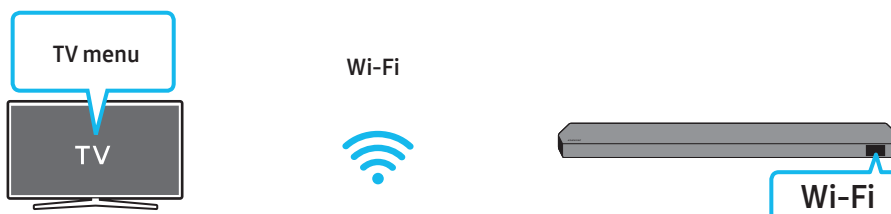

- TV menu example: **TV + [AV] Soundbar series name (Wi-Fi)**

NOTE

- It can operate according to the Codec supported by TV.
- This function is supported only when the HDMI Cable or Optical Cable (not supplied) or Wi-Fi is connected.
- The message displayed may differ with the TV model.
- Ensure that your TV and Soundbar are connected to the same wireless router/frequency.
- This function is available in some Samsung TVs and some Soundbar models.

Using the Spacefit sound

Provides optimized sound quality by analyzing the listening spaces.

Method 1. Connecting via Soundbar



To enable this function, turn on the Spacefit sound mode with the remote control of the Soundbar.

( (Sound Control) → "Spacefit sound Off" → ▲ (Up) → "Spacefit sound On")

- This is available in all Sound modes.

Method 2. Connecting via TV

To enable this function, turn on the Adaptive Sound+ mode on your Samsung TV menu.

(Home () → Menu → Settings () → All Settings () → General → Intelligent Mode Settings → Adaptive Sound+)

- The sound mode on your Soundbar will automatically change to **Adaptive Sound+** if you enable the **Adaptive Sound+** mode on your TV.

NOTE

- This function works when the Soundbar connects to some of the Samsung TVs.
- **Q700B** models support only the method of "Connecting via TV".

06 CONNECTING AN EXTERNAL DEVICE

Method 1. Connecting using an HDMI Cable (Capable of Dolby Atmos / DTS:X decoding and playback)

Pre-connection Checklist

- If the Audio Output options include Secondary Audio, make sure Secondary Audio is set to Off.
- Make sure that the content supports Dolby Atmos® / DTS:X.

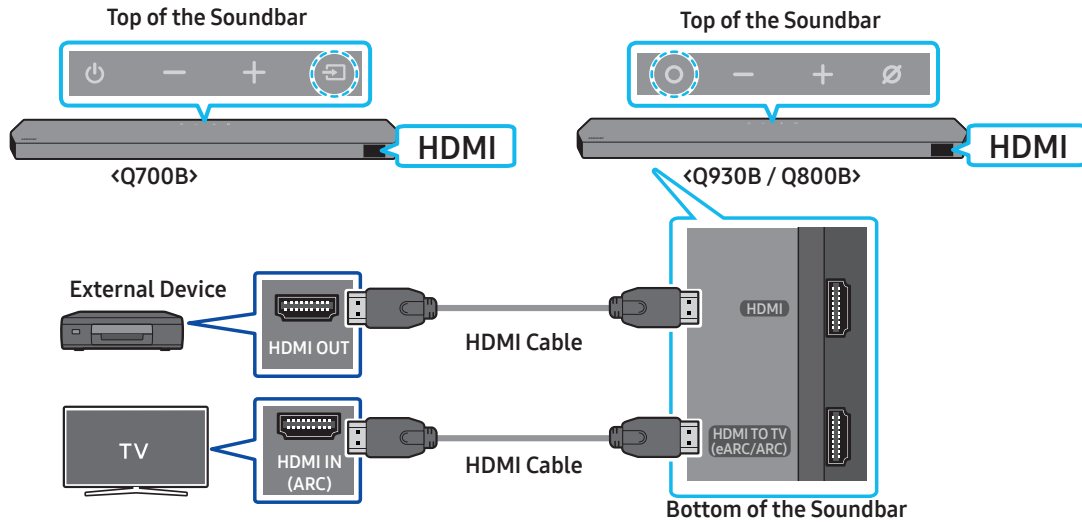

1. Use an HDMI cable to connect the HDMI OUT port on the external device and the HDMI port on the bottom of the Soundbar.
2. Use an HDMI cable to connect the HDMI IN port of the TV and the HDMI TO TV (eARC/ARC) port on the bottom of the Soundbar.
3. Turn on the Soundbar, TV, and the external device.
4. Press the **○ (Multi Function)** / **⏮ (Source)** button on the top of the Soundbar or the **⏮ (Source)** button on the remote control to select "HDMI" mode.
5. The Soundbar display indicates that "HDMI" mode is currently selected and the Soundbar will start playing sounds.

NOTE

- **When you use Dolby Atmos® / DTS:X:** If the input source is Dolby Atmos® / DTS:X, refer to "Output specifications for the different sound effect modes" on page 11.
- When Dolby Atmos® is activated, "DOLBY ATMOS" appears in the front display.
- When DTS:X is activated, "DTS:X" appear in the front display.
- **Configuring Dolby Atmos® / DTS:X on your BD player or other device**
Open the audio output options on the settings menu of your BD player or other device and make sure that "No Encoding" is selected for Bitstream. For example, on a Samsung BD Player, go to Home Menu → Sound → Digital Output and then select Bitstream (unprocessed).

Supported UHD Signals Specification (3840 x 2160p)

Frame rate (fps)	Colour depth	RGB 4:4:4	YCbCr 4:4:4	YCbCr 4:2:2	YCbCr 4:2:0
< 60	8 bit	0	0	0	0
	10 bit	-	-	0	0
	12 bit	-	-	0	0
120	8 bit	-	-	-	-
	10 bit	-	-	-	-

- Supported specification may vary depending on the connected external device or usage conditions.

Method 2. Connecting using an Optical Cable

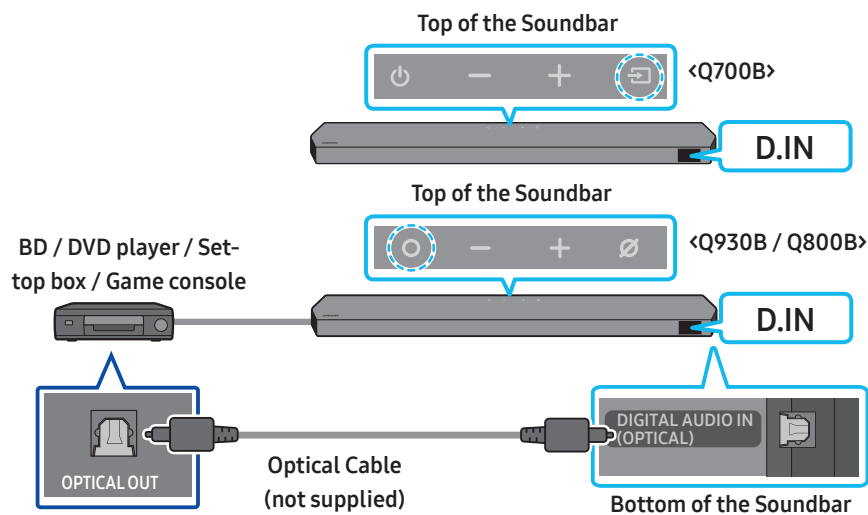

1. Use an optical cable (not supplied) to connect the **DIGITAL AUDIO IN (OPTICAL)** on the Soundbar main and the **OPTICAL OUT** port on the external device.
2. Turn on the Soundbar and external device.
3. To select "**D.IN**" mode, press the **○ (Multi Function) / ↗ (Source)** button on the top of the Soundbar or the **↗ (Source)** button on the remote control.
4. Your Soundbar will play sounds from the external device.

07 CONNECTING A MOBILE DEVICE

Method 1. Connecting via Bluetooth

When a mobile device is connected using Bluetooth, you can hear stereo sound without the hassle of cabling.

- When you connect a paired Bluetooth device with the Soundbar off, the Soundbar automatically turns on.

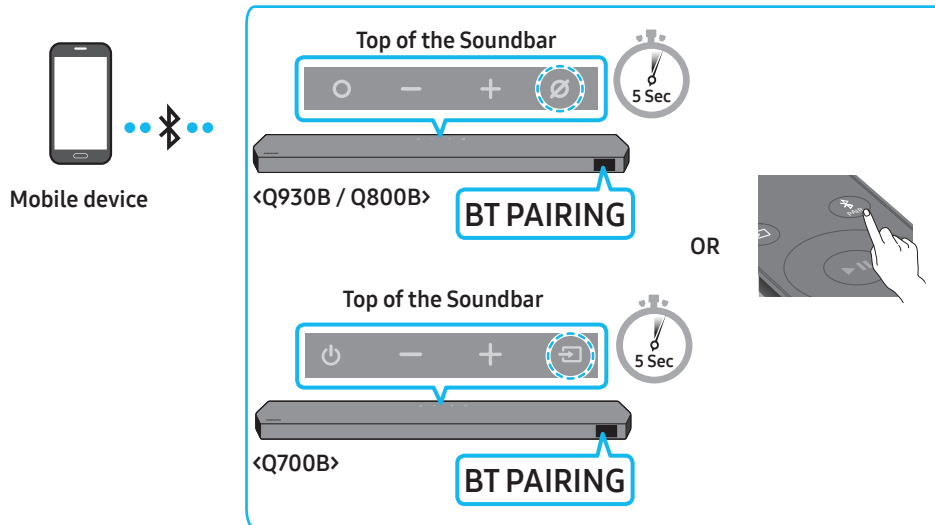

The initial connection

- When connecting to a new Bluetooth device, make sure the device is within 1 m distance.
1. Press the **PAIR** button on the Soundbar remote control to enter the “**BT PAIRING**” mode.
(OR) a. Press the **Multi Function** / **Source** button on the top panel and then select “**BT**”.
“**BT**” changes to “**BT PAIRING**” in a few seconds automatically or changes to “**BT READY**” if there is a connect record.
b. When “**BT READY**” appears, press and hold the **Mic On/Off** / **Source** button on the top panel of the Soundbar for more than 5 seconds to display “**BT PAIRING**”.
 2. On your device, select “**Soundbar Q***B**” from the list that appears.
 - When the Soundbar is connected to the Mobile device, [**Mobile Device Name**] → “**BT**” appears in the front display.
 3. Play music files from the device connected via Bluetooth through the Soundbar.
 - After you have connected the Soundbar to your mobile device the first time, use the “**BT READY**” mode to reconnect.

If the device fails to connect

- If you have an existing Soundbar (e.g., “**Soundbar Q***B**”) in the list of speakers on the Mobile device, delete it.
- Repeat steps 1 and 2.

What is the difference between BT READY and BT PAIRING?

- **BT READY** : In this mode, you can reconnect any Samsung TV or mobile device that was connected before.
- **BT PAIRING** : In this mode, you can connect a new device to the Soundbar.
(Press the **PAIR** button on the Soundbar remote control or press and hold the **Mic On/Off** / **Source** button on the top of the Soundbar for more than 5 seconds while the Soundbar is in “**BT**” mode.)

Notes on Bluetooth connection

- Locate a new device within 1 m to connect via Bluetooth communication.
- If asked for a PIN code when connecting a Bluetooth device, enter <0000>.
- The Soundbar automatically turns off after 18 minutes in the Ready state.
- The Soundbar may not perform Bluetooth search or connection correctly under the following circumstances:
 - If there is a strong electrical field around the Soundbar.
 - If several Bluetooth devices are simultaneously paired with the Soundbar.
 - If the Bluetooth device is turned off, not in place, or malfunctions.
- Electronic devices may cause radio interference. Devices that generate electromagnetic waves must be kept away from the Soundbar main unit - e.g., microwaves, wireless LAN devices, etc.
- The Soundbar supports SBC data (44.1kHz, 48kHz).
- Connect only to a Bluetooth device that supports the A2DP (AV) function.
- You cannot connect the Soundbar to a Bluetooth device that supports only the HF (Hands Free) function.
- When connecting the Soundbar to a Bluetooth device, place them as close to each other as possible.
- The farther the Soundbar and Bluetooth device are from each other, the lower the sound quality will become. The Bluetooth connection may break when the devices are out of the effective range.
- The Bluetooth connection may not function as intended in areas with poor reception.
- A Bluetooth device may experience noise or malfunction under in the following conditions:
 - When the body is in contact with the signal transceiver on the Bluetooth device or Soundbar
 - In corners or when there is an obstacle in proximity, such as a wall or partition, where electrical changes may occur.
 - When exposed to radio interferences by other products operating on the same frequency ranges, such as medical equipment, microwave ovens, and wireless LAN devices.
 - Obstacles such as doors and walls may still impact the sound quality even when the devices are within the effective range.
- Note that your Soundbar cannot be paired with other Bluetooth devices while using the Bluetooth option.
- This wireless device may cause electrical interference during operation.

Disconnecting the Bluetooth device from a Soundbar

You can disconnect a Bluetooth device from the Soundbar. For instructions, see the Bluetooth device's user manual.

- The Soundbar will be disconnected.
- When the Soundbar is disconnected from the Bluetooth device, the Soundbar will display **"BT DISCONNECTED"** on the front display.

Disconnecting the Soundbar from the Bluetooth device

Press the **○ (Multi Function) / ⇄ (Source)** button on the top of the Soundbar or the **⇄ (Source)** button on the remote control to switch the mode from **"BT"**.

- Disconnecting takes time because the Bluetooth device must receive a response from the Soundbar. (Disconnection time may differ, depending on the Bluetooth device)
- When the Soundbar is disconnected from the Bluetooth device, the Soundbar will display **"BT DISCONNECTED"** on the front display.

Method 2. Connecting via Wi-Fi (Wireless Network)

To connect a Soundbar to a mobile device via a wireless network (Wi-Fi), the **SmartThings** app is required.

The initial connection

1. Install and launch the **SmartThings** app from your mobile device (smartphone or tablet).
2. On the app, follow the screen instructions to add the Soundbar.
 - The automatic pop-up (the second screenshot below) may not show on some devices.
If the pop-up window does not appear, press “+” on the **Home** screen. The Soundbar is added to the app.
 - The illustration below may differ according to the app version.

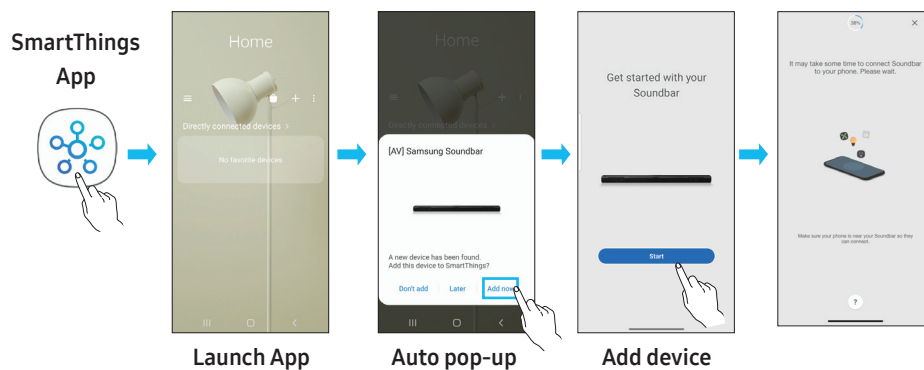

Using the Tap Sound

Tap the Soundbar with your mobile device to play the sound of content on the mobile device through the Soundbar.

- This function may not be supported, depending on the mobile device.
- This function is only compatible with Samsung mobile devices with Android 8.1 or later.

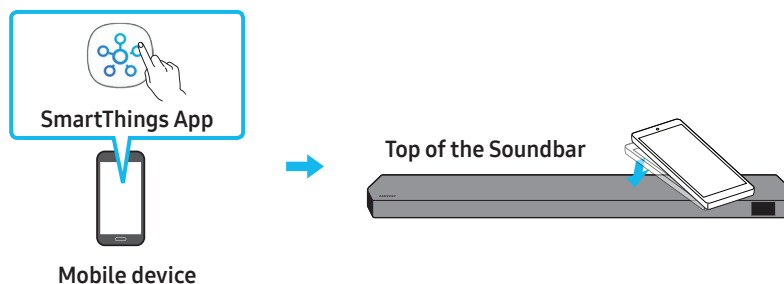

1. Turn on the **Tap Sound** function on your mobile device.
 - For details on how to turn on the function, refer to “**Setting the Tap Sound function**” below.
2. Tap the Soundbar with the mobile device. Select “**Start now**” in the displayed message window. A connection is established between the mobile device and Soundbar via Bluetooth.
3. Play the sound of content on the mobile device through the Soundbar.
 - This function connects a mobile device to the Soundbar via Bluetooth by detecting vibration that occurs when the device touches the Soundbar.
 - Make sure the mobile device does not tap a sharp corner of the Soundbar. The Soundbar or mobile device may become scratched or damaged.
 - It is recommended that the mobile device be covered with a case. Lightly tap the wide area in the upper portion of the Soundbar, without using excessive force.
 - To use this function, update the **SmartThings** app to the latest version. The function may not be supported, depending on the app version.

Setting the Tap Sound function

Use the **SmartThings** app to turn on the **Tap View, Tap Sound** function.

1. On the mobile device, run the **SmartThings** app.
2. Select (☰ → ⚙) in the **SmartThings** app screen displayed on the mobile device.
3. Set “**Tap View, Tap Sound**” to On to allow the function to work when a mobile device moves close to the Soundbar. The function is turned on.

NOTE

- When the mobile device is in power-saving mode, the **Tap Sound** function does not work.
- The **Tap Sound** function may not work if there are devices near the Soundbar that cause radio interference such as electric devices. Make sure devices that may cause radio interference are placed at a sufficient distance away from the Soundbar.

08 CONNECTING VIA APPLE AIRPLAY 2

- This feature may not be available in some countries.
- This Samsung Soundbar supports AirPlay 2 and requires iOS 11.4 or later.

With AirPlay 2, you can stream music, podcasts, and other audio from your Apple devices to the Samsung Soundbar.

- Make sure the Soundbar is powered on and connected to the same Wi-Fi network as your Apple device.
- Select  from an AirPlay-supported app or Control Centre on your iPhone, iPad, or Mac.
- Select the Soundbar from the list of available devices to play the current audio to.

09 INSTALLING THE WALL MOUNT

Installation Precautions

- Install on a vertical wall only.
- Do not install in a place with high temperature or humidity.
- Verify whether the wall is strong enough to support the product's weight. If not, reinforce the wall or choose another installation point.
- Purchase and use the fixing screws or anchors appropriate for the kind of wall you have (plaster board, iron board, wood, etc.). If possible, fix the support screws into wall studs.
- Purchase wall mounting screws according to the type and thickness of the wall you want to mount the Soundbar on.
 - Diameter: M5
 - Length: 35 mm or longer recommended.
- Connect cables from the unit to external devices before you install the Soundbar on the wall.
- Make sure the unit is turned off and unplugged before you install it. Otherwise, it may cause an electric shock.

Wallmount Components

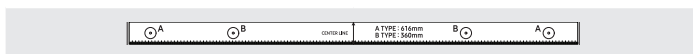

Wall Mount Guide

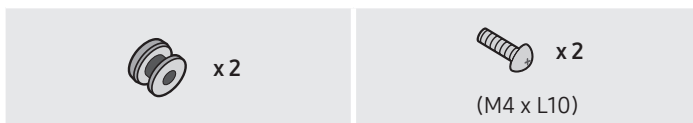

Holder-Screw

Screw



Bracket-Wall Mount

1. Place the **Wall Mount Guide** against the wall surface.
 - The **Wall Mount Guide** must be level.
 - If your TV is mounted on the wall, install the Soundbar at least 5 cm below the TV.

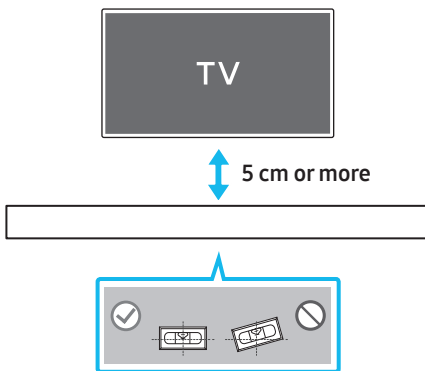

2. Align the **Wall Mount Guide's Centre Line** with the centre of your TV (if you are mounting the Soundbar below your TV), and then fix the **Wall Mount Guide** to the wall using tape.
 - If you are not mounting below a TV, place the **Centre Line** in the centre of the installation area.

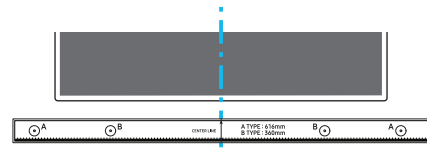

Centre Line

3. Push a pen tip or sharpened pencil tip through the centre of the **A-TYPE** images on each end of the Guide to mark the holes for the supporting screws, and then remove the **Wall Mount Guide**.

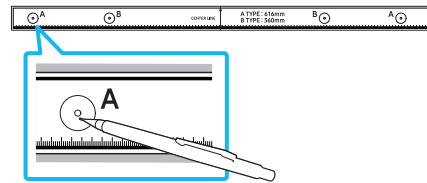

4. Using an appropriately sized drill bit, drill a hole in the wall at each marking.
 - If the markings do not correspond to the positions of studs, make sure you insert appropriate anchors or mollies into the holes before you insert the support screws. If you use anchors or mollies, make sure the holes you drill are large enough for the anchors or mollies you use.
5. Push a screw (not supplied) through each **Holder-Screw**, and then screw each screw firmly into a support screw hole.

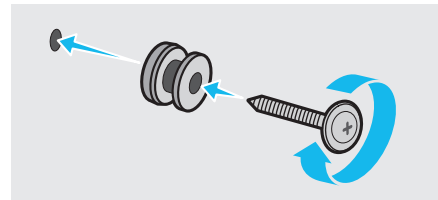

6. Install the **2 Bracket-Wall Mounts** in the correct orientation on the bottom of the Soundbar using **2 Screws**.

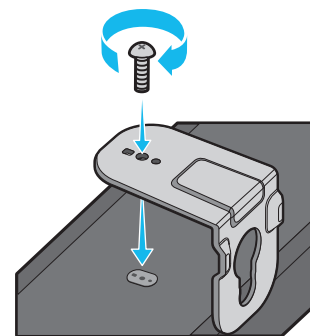

- When assembling, make sure the hanger part of the **Bracket-Wall Mounts** are located behind the rear of the Soundbar.

Rear of Soundbar



Right end of Soundbar

- Install the Soundbar with the attached **Bracket-Wall Mounts** by hanging the **Bracket-Wall Mounts** on the **Holder-Screws** on the wall.

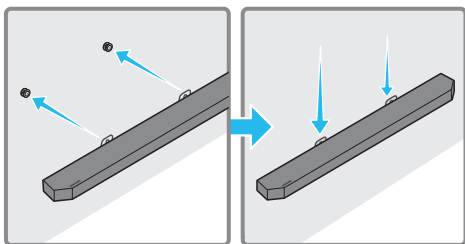

- Slide the Soundbar down as shown below so that the **Bracket-Wall Mounts** rest securely on the **Holder-Screws**.

- Insert the **Holder-Screws** into the wide (bottom) part of the **Bracket-Wall Mounts**, and then slide the **Bracket-Wall Mounts** down so that the **Bracket-Wall Mounts** rest securely on the **Holder-Screws**.

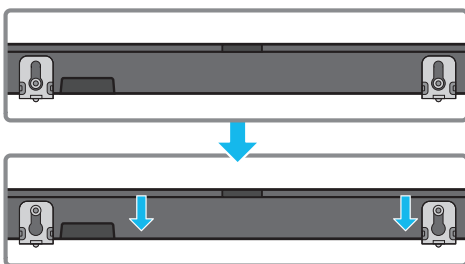

Installing the Surround Speakers on a Wall (applicable models only)

You can purchase wall mounts separately to install the surround speakers on a wall.

Wall mounts aren't sold by Samsung Electronics.

Notes for Wall Mounting the Surround Speakers

- Surround Speaker wall mounts must be able to support more than 8.0 kg.
- Hole size : 1/4 - 20 UNC threaded insert
 - Standard Screw : 6.35 mm \varnothing , 1.27mm Pitch
 - Length : 18 mm long
 - Quantity : Left 1 EA / Right 1 EA

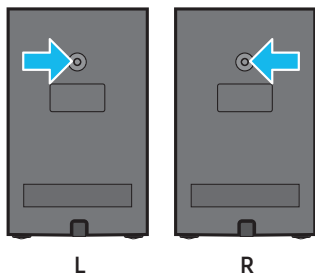

- Check the strength of the wall before you install the Wall Mount Brackets. If the strength is insufficient, make sure to reinforce the wall before installing the Wall Mount Brackets and the speakers on the wall.
- Samsung Electronics is not liable for any damage to the product due to the product being installed inappropriately.
- Take care not to install the speakers sideways or upside down.

10 INSTALLING THE SOUNDBAR IN FRONT OF TV

Component

 x 4

Rubber-Foot

To install, attach the **Rubber-Feet** to the bottom of the Soundbar before placing it in position above the TV stand. Make sure you attach the **Rubber-Feet** so they do not lie outside the edges of the TV stand. Refer to the figure below.

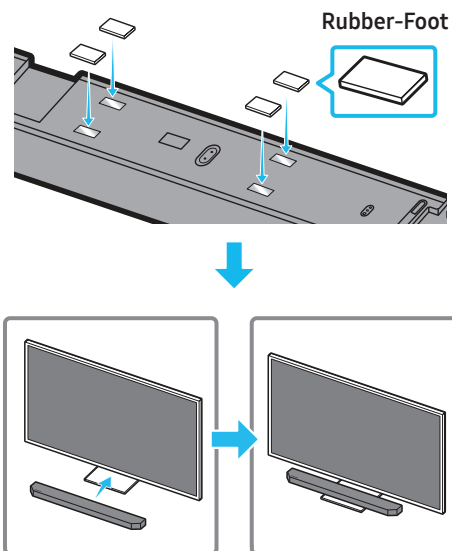

Place the Soundbar on a TV stand.

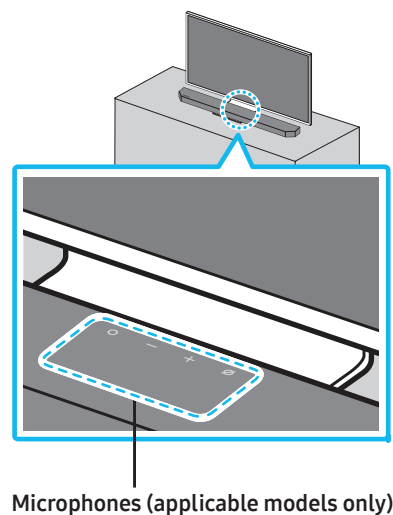

As illustrated in the image, align the centre of the Soundbar with the centre of the TV, carefully place the Soundbar onto the TV stand. At this time, place the microphones (applicable models only) at the front of the stand not to interfere with voice recognition.

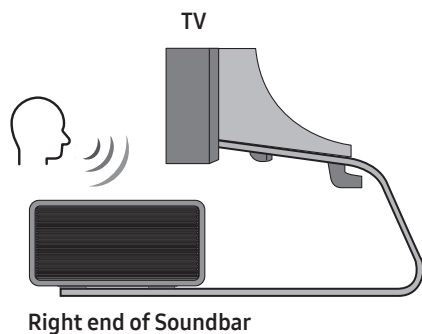

NOTE

- Make sure the Soundbar is placed on a flat and solid surface.
- Insufficient gap from the TV may cause voice recognition and acoustic problems.
- The illustration above differs with the respective model.
- This function is not supported by **Q700B** model.

11 SOFTWARE UPDATE

Auto Update

When the Soundbar is connected to the Internet, software updates automatically occur even when the Soundbar is turned off.

- To use the Auto Update function, the Soundbar must be connected to the Internet.

The Wi-Fi connection to the Soundbar will be terminated if the Soundbar's power cord is disconnected or the power is cut off. If the power is cut off, when the power comes back on or you reconnect the power cord, turn on the Soundbar, and then reconnect it to the Internet.

USB Update

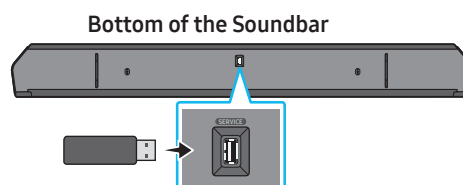

Samsung may offer updates for the Soundbar's system firmware in the future.

When an update is available, you can update the Soundbar by connecting the USB drive that contains the update firmware to the **SERVICE** port of the Soundbar.

1. Go to the Samsung website (www.samsung.com) → search for the model name from the customer support menu option.
 - For more information about update, refer to Upgrade Guide.
2. Download the upgrade file (USB type).
3. Unzip the file to create a folder with the file name.
4. Store the created folder in a USB and then connect it to the Soundbar.
5. Turn on the Soundbar. Then the product is updated within 3 minutes with displaying the message, "**UPDATE**".
 - During update, do not turn it off or remove the USB.
 - If "**UPDATE**" does not appear on the display window, remove the power cord from the Soundbar and then reconnect it.
 - When the latest version is installed, no update is performed.
 - Depending on the USB type, update may not be supported.

Initialisation

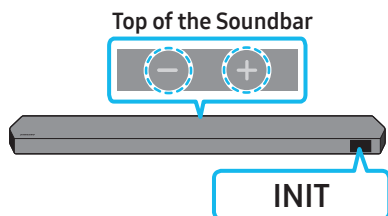

With the Soundbar on, press the **— + (Volume)** buttons on the body at the same time for at least 5 seconds. "INIT" appears on the display and then the Soundbar is initialised.

⚠ CAUTION

- All the settings of the Soundbar are initialised. Be sure to perform this only when initialisation is required.

12 TROUBLESHOOTING

Before seeking assistance, check the following.

Soundbar does not turn on.

- Check whether the power cord of the Soundbar is correctly inserted into the outlet.

Soundbar works erratically.

- After removing the power cord, insert it again.
- Power cycle the external device and try again.
- If there is no signal, the Soundbar automatically turns off after a certain period of time. Turn on the power. (See page 9.)

Remote control does not work

- Point the remote directly at the soundbar.
- Replace the batteries with new ones.

The Soundbar indicator turns solid red.

- The microphone is turned off.
Turn on the microphone. (See page 7.)

Sound is not output from the soundbar.

- The volume of the Soundbar is too low or muted. Adjust the volume.
- When any external device (STB, Bluetooth device, mobile device, etc.) is connected, adjust the volume of the external device.
- For sound output of the TV, select Soundbar. (Samsung TV: Home (🏠) → Menu → Settings (⚙) → All Settings (⚙) → Sound → Sound Output → Select Soundbar)
- The cable connection to the Soundbar may not be loose. Remove the cable and connect again.
- Remove the power cord completely, reconnect, and turn the power on.
- Initialise the product and try again. (See page 35.)

Sound is not output from the subwoofer or the rear speakers.

- Check whether the LED indicator on the rear of the Subwoofer and Surround Speakers are on in blue. Reconnect the Soundbar and Subwoofer and Surround Speakers if the indicator is blinking in blue or turned red. (See page 16.)
- You may experience an issue if there is an obstacle between the Soundbar and Subwoofer. Move devices to an area away from obstacles.
- Other devices sending radio frequency signals in proximity may interrupt the connection.
Keep your speaker away from such devices.
- Remove and reconnect the power plug.

In case there is sound jitter, delays, or noise from the Subwoofer and Surround Speaker

- If there are any objects between the Soundbar and Subwoofer speaker, this could cause a problem. Please reposition these to a place without such an object.
- There may be sound jitter or delays when the Subwoofer and Surround Speaker are far from the Soundbar. Please place them near the Soundbar.
- There may be sound jitter or delays when the Soundbar is near an instrument or electrical device that can cause radio interference. Place the Soundbar far from such devices that can cause radio interference. (E.g., wireless router)
- Change the TV network connection status from wireless to wired.

The Subwoofer volume is too low

- The original volume of the content you are playing may be low. Try adjusting the Subwoofer level. (See page 10.)
- Bring the Subwoofer speaker closer to you.

If the TV is not connected via HDMI TO TV (eARC/ARC)

- Check whether the HDMI cable is correctly connected to the ARC terminal. (See page 18.)
- Connection may not be possible due to the connected external device (set-top box, game machine, etc.). Directly connect the Soundbar.
- HDMI-CEC may not be activated on the TV. Turn on the CEC on the TV menu. (Samsung TV: Home (🏠) → Menu → Settings (⚙️) → All Settings (⚙️) → Connection → External Device Manager → Anynet+ (HDMI-CEC) ON)
- To connect with eARC, the eARC function in the TV menu should be set to On. (Samsung TV: Home (🏠) → Menu → Settings (⚙️) → All Settings (⚙️) → Sound → Expert Settings → HDMI-eARC Mode (Auto))

There is no sound in when connecting to the TV in HDMI TO TV (eARC/ARC) mode

- Your device is unable to play the input signal. Change the TV's audio output to PCM or Dolby Digital. (For a Samsung TV: Home (🏠) → Menu → Settings (⚙️) → All Settings (⚙️) → Sound → Expert Settings → Digital Output Audio Format)

Soundbar will not connect via Bluetooth.

- When connecting a new device, switch to "BT PAIRING" for connection. (Press the **PAIR** button on the remote control or press the **(Mic On/Off) / (Source)** button on the body for at least 5 seconds.)
- If the Soundbar is connected to another device, disconnect that device first to switch the device.
- Reconnect it after removing the Bluetooth speaker list on the device to connect. (Samsung TV: Home (🏠) → Menu → Settings (⚙️) → All Settings (⚙️) → Sound → Sound Output → Bluetooth Speaker List)
- The automatic TV connection may be disabled. While the Soundbar is in "BT READY", press and hold the **Left** button on the Soundbar remote control for 5 seconds to select **ON-TV CONNECT**. If you see **OFF-TV CONNECT**, press and hold **Left** button again for 5 seconds to switch the selection.
- Remove and reconnect the power plug, then try again.
- Initialise the product and try again. (See page 35.)

Sound drops out when connected via Bluetooth.

- Some devices can cause radio interference if they are located too close to the Soundbar. e. g. microwaves, wireless routers, etc.
- If your device that is connected via Bluetooth moves too far away from the soundbar, it may cause the sound to drop out. Move the device closer to the soundbar.
- If a part of your body is in contact with the Bluetooth transceiver or the product is installed on metal furniture, the sound may drop out. Check the installation environment and conditions for use.

Soundbar will not connect to Wi-Fi.

- Check whether your wireless router is on.
- Turn off the router, turn it back on, and then try again.
- The soundbar will not connect if the wireless signal is too weak. Try moving the router closer to the soundbar, or eliminating any obstacles that are between the soundbar and the router, if possible.
- If your wireless router is new, you will need to reconfigure the speaker's network settings.

The soundbar does not turn on automatically with the TV.

- When you turn off the Soundbar while watching TV, power synchronization with the TV is disabled. First turn off the TV.

The AVA function (applicable models only) is not available in the following cases.

- The AVA function (applicable models only) will not be available using Q-symphony function.
- The AVA function (applicable models only) will not be available when the microphone is turned off.

After connecting the TV to the Soundbar, I switched the Soundbar mode. Then no sound is output from the TV.

- If you connect your Soundbar to a mobile device while the Soundbar is connected to the TV, the Soundbar outputs sound from the mobile device while keeping the TV connection. So the TV sound will not be delivered anywhere.
- Disconnect the mobile device, and the TV sound will be output from the Soundbar again.

13 LICENCE



Dolby, Dolby Atmos, and the double-D symbol are registered trademarks of Dolby Laboratories Licensing Corporation. Manufactured under license from Dolby Laboratories. Confidential unpublished works. Copyright © 2012-2021 Dolby Laboratories. All rights reserved.



For DTS patents, see <http://patents.dts.com>. Manufactured under license from DTS, Inc. (for companies headquartered in the U.S./ Japan/Taiwan) or under license from DTS Licensing Limited (for all other companies). DTS, DTS:X, and the DTS:X logo are registered trademarks or trademarks of DTS, Inc. in the United States and other countries. © 2021 DTS, Inc. ALL RIGHTS RESERVED.



The terms HDMI and HDMI High-Definition Multimedia Interface, and the HDMI Logo are trademarks or registered trademarks of HDMI Licensing Administrator, Inc. in the United States and other countries.



- Use your phone, tablet or computer as a remote control for Spotify. Go to spotify.com/connect to learn how
- The Spotify Software is subject to third party licenses found here: <https://www.spotify.com/connect/third-party-licenses>.



- Apple, Airplay, iPhone, iPad, and Mac are trademarks of Apple Inc., registered in the U.S. and other countries.
- Use of the Works with Apple badge means that an accessory has been designed to work specifically with the technology identified in the badge and has been certified by the developer to meet Apple performance standards.

14 OPEN SOURCE LICENCE NOTICE

To send inquiries and requests for questions regarding open sources, contact Samsung Open Source (<http://opensource.samsung.com>)

15 IMPORTANT NOTES ABOUT SERVICE

Figures and illustrations in this User Manual are provided for reference only and may differ from actual product appearance.

16 SPECIFICATIONS AND GUIDE

Specifications

Soundbar Main Unit

Model Name	HW-Q930B
Weight	5.4 kg
Dimensions (W x H x D)	1110.7 x 60.4 x 120.0 mm
Operating Temperature Range	+5°C to +35°C
Operating Humidity Range	10 % ~ 75 %
AMPLIFIER Rated Output power	(30 W x 3) + (20 W x 6) + (10 W x 3)
Supported play formats	Dolby 5.1ch / Dolby Digital Plus / Dolby TRUE HD / Dolby ATMOS / DTS 5.1ch / DTS HD / DTS-HD Master Audio / DTS:X / LPCM 8Ch

Model Name	HW-Q800B
Weight	5.1 kg
Dimensions (W x H x D)	1110.7 x 60.4 x 120.0 mm
Operating Temperature Range	+5°C to +35°C
Operating Humidity Range	10 % ~ 75 %
AMPLIFIER Rated Output power	(30 W x 3) + (20 W x 4) + (10 W x 3)
Supported play formats	Dolby 5.1ch / Dolby Digital Plus / Dolby TRUE HD / Dolby ATMOS / DTS 5.1ch / DTS HD / DTS-HD Master Audio / DTS:X / LPCM 8Ch

Model Name	HW-Q700B
Weight	4.8 kg
Dimensions (W x H x D)	1110.7 x 60.4 x 120.0 mm
Operating Temperature Range	+5°C to +35°C
Operating Humidity Range	10 % ~ 75 %
AMPLIFIER Rated Output power	(30 W x 3) + (20 W x 2) + (10 W x 3)
Supported play formats	Dolby 5.1ch / Dolby Digital Plus / Dolby TRUE HD / Dolby ATMOS / DTS 5.1ch / DTS HD / DTS-HD Master Audio / DTS:X / LPCM 8Ch

Subwoofer

Subwoofer Name	PS-WB96B
Weight	9.8 kg
Dimensions (W x H x D)	210.0 x 403.0 x 403.0 mm
AMPLIFIER Rated Output power	160 W

Subwoofer Name	PS-WB75B
Weight	5.9 kg
Dimensions (W x H x D)	205.0 x 353.0 x 302.0 mm
AMPLIFIER Rated Output power	160 W

Surround Speaker (applicable models only)

Wireless Surround Speaker SET Name	PS-RB96B (LEFT/RIGHT)
Weight	3.1 kg
Dimensions (W x H x D)	129.5 x 201.3 x 140.4 mm
AMPLIFIER Rated Output power	140 W

NOTE

- Samsung Electronics Co., Ltd reserves the right to change the specifications without notice.
- Weight and dimensions are approximate.

Precaution : The Soundbar will restart automatically if you turn on/turn off Wi-Fi.

Wi-Fi Port deactivation method	Press the CH LEVEL button on the remote control of the Soundbar for 30 seconds to turn Wi-Fi On / Off.
Bluetooth Port deactivation method	Press the TONE CONTROL button on the remote control of the Soundbar for 30 seconds to turn Bluetooth On / Off.

安全資料

安全警告

為減少觸電的危險，切勿移除機蓋 (或後蓋)。

內部沒有使用者可自行維修的零件。請聯絡合資格的服務人員進行維修。

參閱下表，以取得三星產品上標誌的詮釋。

	注意 有電擊危險。切勿打開。	
	此符號表示內部存在高電壓。以任何形式接觸本產品的任何內部零件都會產生危險。	
	此符號表示此產品已隨附與操作和維護有關的重要文獻。	
	II 類產品：此符號表示無需連接安全接地線 (地線)。如此標誌沒有在帶有電源線的產品上出現，則產品必須正確連接保護地線。	
	AC 交流電壓：標有此符號的額定電壓是 AC 交流電壓。	
	DC 直流電壓：標有此符號的額定電壓是 DC 直流電壓。	
	注意：請參閱使用說明：此符號指示使用者應參閱使用者手冊，以進一步了解與安全相關的資訊。	

警告

- 為減少觸電的危險，切勿將本產品暴露於雨水或水份之中。

注意

- 為免觸電，應將插頭的寬葉片完全插進寬插槽。
- 此設備應一律透過具保護效能的接地線連接至 AC 交流電源插座。
- 如要中斷設備與電源的連接，必須從電源插座中拔出插頭，因此電源插頭能正常運作易於使用。
- 切勿將本設備暴露於有滴水或濺水的地方。切勿將花瓶等裝滿液體的物品放在此設備上。
- 如要完全關閉本設備，必須從入牆插座中拔出電源插頭。因此，電源插頭必須一律放在易於接觸的位置。

注意事項

1. 確定您屋內的交流電源供應符合產品底部識別標籤上列出的電源要求。在合適的底座 (傢俱) 上水平安裝產品，並且週圍留有足夠的通風空間 (7~10 厘米)。確定通風槽不被覆蓋。請勿將裝置放在擴音器或其他可能會變熱的設備上。本裝置是專為連續使用而設計。若要完全關閉電源，請從牆上插座拔出交流插頭。如果您打算長時間不使用本裝置，請拔下電源插頭。
2. 在雷暴期間，請從入牆插座拔出 AC 交流插頭。雷電引起的電壓峰值可能會損壞裝置。
3. 請勿將裝置直接曝曬於陽光下或其他熱源中。這可能會引起過熱並導致裝置故障。
4. 防止產品受潮 (例如花瓶)、過熱 (例如壁爐) 或遠離會產生較強磁場或電場的設備。如果裝置發生故障，從牆上交流插座拔出電源纜線。您的產品不適合工業使用。它是僅供個人使用。如果存儲在寒冷的氣溫下，產品可能會出現冷凝。如果在冬季運輸裝置，等待大約 2 小時，直到裝置達到室溫後才使用。
5. 本產品使用的電池中含有對環境有害的化學物質。切勿將電池丟入一般家庭垃圾之中。切勿讓電池過熱、直射陽光或接近火種。切勿令電池短路、解體或過熱。
注意：如果以不正確的方式更換電池，可能有爆炸的危險。只可替換相同或等效類型的電池。

內容

01	檢查元件	6
02	產品概覽	7
	Soundbar 的頂部面板	7
	Soundbar 的底部面板	8
03	使用 Soundbar 遙控器控制	9
	使用遙控器前安裝電池 (2 粒 AAA 電池)	9
	如何使用遙控器	9
	Active Voice Amplifier (AVA)	11
	使用隱藏按鈕 (備有多種功能的按鈕)	11
	不同音效模式的輸出規格	11
	使用電視遙控器調校 Soundbar 音量。	13
04	連接 Soundbar	14
	連接電源和裝置	14
	- 建議的揚聲器擺位	15
	- 環繞聲揚聲器模式 (只限 HW-Q930B)	15
	- 手動連接有源重低音音箱或環繞聲揚聲器	16
	- 有源重低音音箱和環繞聲揚聲器背面的 LED 指示燈	17
05	連接至電視	18
	連接支援 HDMI ARC (音訊回傳通道) 的電視	18
	使用光纖纜線連接	19
	透過 Bluetooth 連接	20
	透過 Wi-Fi 連接	22
	使用 Q-Symphony 功能	23
	使用 Spacefit 音訊	24
06	連接外部裝置	25
	方法 1。使用 HDMI 纜線連接 (支援 Dolby Atmos / DTS:X 解碼和播放)	25
	方法 2。使用光纖纜線連接	26
07	連接流動裝置	27
	方法 1。透過藍牙連接	27
	方法 2。透過 Wi-Fi (無線網絡) 連接	29
	Tap Sound 用法	30
08	透過 Apple AirPlay 2 連接	31
09	安裝支掛牆支架	32
	安裝注意事項	32
	掛牆元件	32
	在牆上安裝環繞聲揚聲器 (僅限適用型號)	33

10	將 Soundbar 安裝於電視前方	33
	組件.....	33
11	軟件更新	34
	自動更新.....	34
	USB 更新.....	34
	初始化.....	35
12	故障排除	35
13	許可	37
14	開源許可聲明	37
15	關於服務的重要說明	37
16	規格和指南	38
	規格.....	38

01 檢查元件

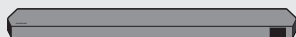

Soundbar 主設備



Soundbar 遙控器/電池



低音炮



環繞聲揚聲器 (非必要)
(左/右)



電源線
(有源重低音音箱、環繞聲揚聲器和 Soundbar)
(非必要)



HDMI 纜線



牆壁安裝指南



支架螺絲



x 2
(M4 x L10)

螺絲



牆壁安裝支架



橡膠腳

- 如需更多有關電源供應及耗電的資料，請見產品上附有的標籤。(標籤：Soundbar 主機背面)
- 如欲購買其他元件或連纜線，請聯絡三星服務中心或三星客戶服務中心。
- 如需更多有關掛牆或橡膠腳的資料，請參閱第 32~34 頁。
- 設計、規格和應用程式畫面如有變更，恕不另行通知。
- 附件外觀可能與上方圖片稍微不同。

02 產品概覽

Soundbar 的頂部面板

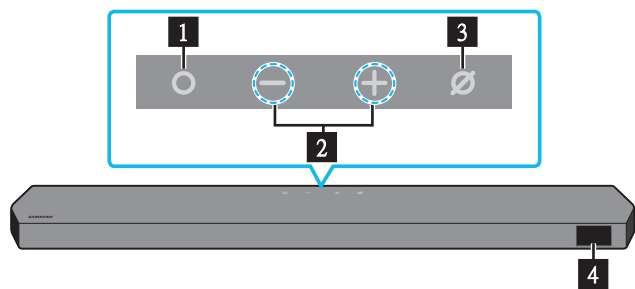

HW-Q930B / HW-Q800B

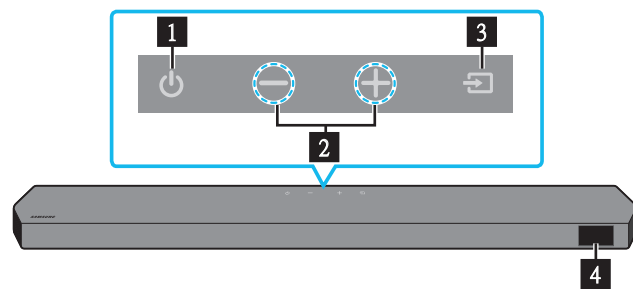

HW-Q700B

1	○ (多功能) 按鈕 (Q930B / Q800B 型號) <ul style="list-style-type: none">在待機模式下，按下 ○ (多功能) 按鈕，以開啟 Soundbar。按下 ○ (多功能) 按鈕，以變更輸入訊號源。
1	⏻ (電源) 按鈕 (Q700B 型號) 打開和關閉電源。
2	— + (音量) 按鈕 調整音量。
3	⊘ (麥克風開/關) 按鈕 (Q930B / Q800B 型號) 按下按鈕來開啟或關閉麥克風。 麥克風關閉時，LED 指示燈便會亮起紅色。 
3	⇒ (來源) 按鈕 (Q700B 型號) 按下 ⇒ (來源) 按鈕來更改輸入訊號源。
4	顯示 顯示產品的狀態和目前模式。 D.IN → HDMI → Wi-Fi → BT

- 當您插入交流電源線時，電源按鈕會在 4 至 6 秒內開啟。
- 當您開啟此設備時，設備會延遲 4 至 5 秒才發出聲音。
- 如果電視和 Soundbar 一起發出聲音，可前往電視音效的**設定**選單，並將電視揚聲器變更為**外部揚聲器**。

Soundbar 的底部面板

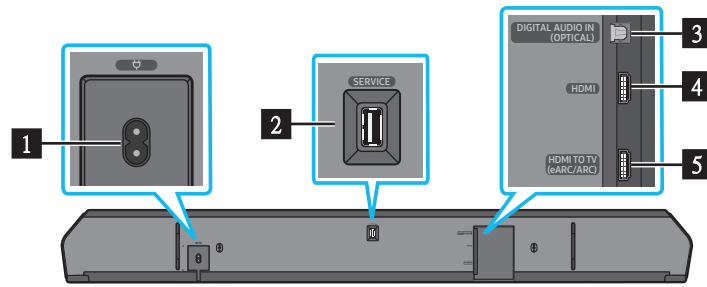

1	POWER 連接 Soundbar 的 AC 電源線。(請參閱第 14 頁)
2	SERVICE 連接 USB 儲存裝置以升級產品軟件。
3	DIGITAL AUDIO IN (OPTICAL) 連接至外置裝置的數位 (光纖) 輸出。(請參閱第 26 頁)
4	HDMI 使用 HDMI 纜線同時輸入數位視訊及音訊訊號。 連接至外置裝置的 HDMI 輸出。(請參閱第 25 頁)
5	HDMI TO TV (eARC/ARC) 連接至電視機的 HDMI 插孔。(請參閱第 18 頁)

- 從入牆插座拔出電源線時，請拿著插頭，不要拉扯電源線。
- 完成組件之間的所有連接前，不要將此設備或其他組件連接至交流電插座。

03 使用 SOUNDBAR 遙控器控制





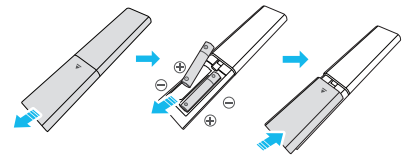

使用遙控器前安裝電池 (2 粒 AAA 電池)

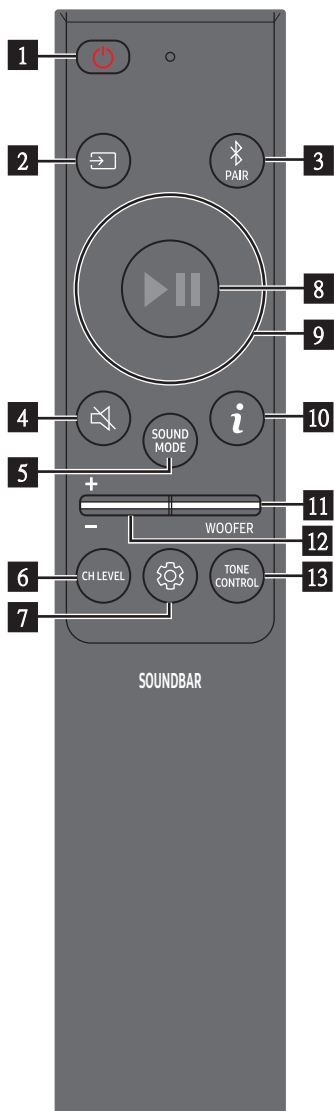









朝箭咀方向滑動底蓋，直至完全脫離。按正確方向放入 2 粒 3A 電池 (1.5V)，以確保電池的極性沒有放錯。把電池蓋滑回去原來的位置。

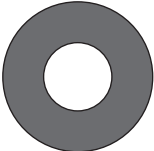

如何使用遙控器

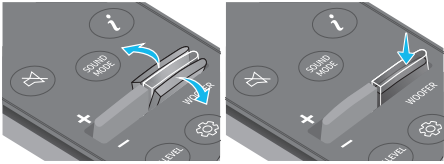

1	 電源	打開和關閉 Soundbar。 • Auto Power Down 功能 設備會於下列情況自動關機： • 處於 D.IN / HDMI / Wi-Fi / BT 模式並且已經 18 分鐘沒有音訊訊號時。
2	 來源	按下以選擇一個連接至 Soundbar 的來源。
3	 Bluetooth PAIR	切換 Soundbar 至藍牙配對模式。按下按鈕直至出現「BT PAIRING」畫面，以連接新的藍牙裝置。
4	 靜音	按下  (靜音) 按鈕即可設為靜音。 再次按下按鈕即可取消靜音。
5	 SOUND MODE	按下按鈕，您便可以選擇 Surround、Game、Standard 或 Adaptive sound 等所需音訊模式。 • Standard 輸出原本的聲音。 • Surround 提供比標準音域更闊的聲場。 • Game 提供立體聲音效，讓您沉醉於遊戲之中。 • Adaptive sound 即時分析內容，並根據內容的特徵自動選擇最佳的聲場。
6	 CH LEVEL	按下按鈕，即可調節每個揚聲器的音量，例如 Centre Level、Side Level、Wide Level、Front Top Level、Rear Level 和 Rear Top Level。 • 如要控制各揚聲器的音量，請在音效設定中選擇 Centre Level、Side Level、Wide Level 或 Front Top Level，然後使用上/下按鈕在 -6 到 +6 之間調整音量。 • 如要已連接環繞聲揚聲器，選擇 Rear Level 或 Rear Top Level，然後使用上/下按鈕將音量設定為 -6 至 +6。 • CH LEVEL 規格可能因相應型號而有所不同。

<p>7</p>	 音訊控制	<p>按下按鈕，您便可以設定 Spacefit Sound、AVA、Voice enhance mode、Night mode、Sync、Surround speaker mode 和 Virtual 等音訊功能。可使用上/下按鈕設整所需的項目。</p> <ul style="list-style-type: none"> • Q700B 型號不支援 Spacefit Sound 和 AVA 功能。 • Voice enhance mode 可增強電影和電視播放的語音對話，讓您可更輕鬆地聽到。 • Night mode 為夜間觀看的最佳選擇，可調整設定將音量調低但仍保持對話清晰。 • 按住  (音訊控制) 按鈕 5 秒，為各頻段調整音效。可使用左/右按鈕選擇 150Hz、300Hz、600Hz、1.2kHz、2.5kHz、5kHz 和 10kHz，而各頻率可使用上/下按鈕在 -6 至 +6 之間進行設定。(確定音訊模式已設為「Standard」。) • 若電視影片與 Soundbar 音訊未能同步，在音訊控制中選擇 Sync，然後使用上/下按鈕設定 0 到 300 毫秒的音訊延遲。 • Sync 僅支援部分功能。 • 只有 Q930B 型號支援可用的 Surround speaker mode 設定。 • Virtual 揚聲器功能可透過上/下按鈕來開啟/關閉。
<p>8</p>	 播放/暫停	<p>按下按鈕即可播放或暫停播放音樂。</p>
<p>9</p>	 上/下/左/右	 按特定位置來選擇上/下/左/右。 <p>按上/下/左/右按鈕可以選擇或設定功能。</p> <ul style="list-style-type: none"> • 跳過音樂 按下右按鈕可選擇下一個音樂檔案。按下左按鈕可選擇前一個音樂檔案。 • ID SET 當低音炮或環繞聲揚聲器未連接或需要重新連接時，使用此選項。 關閉電源後，按住上按鈕 5 秒以執行 ID SET。(請參閱第 16 頁。)
<p>10</p>	 資料	<p>按下即可顯示可用功能或可用 Codec 的資訊。 在 BT 模式中，裝置會顯示已連接的裝置 (完成配對後) 或「BT Ready」(需要配對時)。</p>
<p>11</p>	 WOOFER LEVEL	 <p>將按鈕向上或向下推，以調整有源重低音音箱 (低音)。</p>
<p>12</p>	 音量	 <p>將按鈕向上或向下推，以調整音量。</p> <ul style="list-style-type: none"> • 靜音 按下音量按鈕即可設為靜音。再次按下按鈕即可取消靜音。
<p>13</p>	 TONE CONTROL	<p>按下按鈕，即可調較高音或低音的音量。可使用「上/下」按鈕設整所需的項目。此功能在聲音模式啟用，除了 Standard 模式。</p> <ul style="list-style-type: none"> • 在音效設定中，選擇 TREBLE 或 BASS，再用上/下按鈕從 -6 到 +6 間調節音量。 • 變更低音音量後，低音炮音量亦會相對調整。

Active Voice Amplifier (AVA)

- 在 Soundbar 播放內容時即時分析四周的噪音，讓語音由始至終都能清晰聽到。
- 分析期間不會儲存任何資料。
- Q700B 型號不支援此功能。

使用隱藏按鈕 (備有多種功能的按鈕)

隱藏按鈕		參考頁面
遙控器按鈕	功能	
低音炮 (上)	電視遙控器開啟/關閉 (待機)	頁 13
上	ID SET	頁 16
 (音訊控制)	7 頻段 EQ	頁 10

不同音效模式的輸出規格

<HW-Q930B>

效果	輸入	輸出
		連有源重低音音箱及環繞聲揚聲器
Standard	2.0 聲道	2.1 聲道
	5.1 聲道	5.1 聲道 / 7.1 聲道 (DTS)
	7.1 聲道	7.1 聲道
	Dolby Atmos®、DTS:X	7.1.4 聲道
Surround	2.0 聲道	9.1.4 聲道
	5.1 聲道	9.1.4 聲道
	7.1 聲道	9.1.4 聲道
	Dolby Atmos®、DTS:X	9.1.4 聲道
Game	2.0 聲道	9.1.4 聲道
	5.1 聲道	9.1.4 聲道
	7.1 聲道	9.1.4 聲道
	Dolby Atmos®、DTS:X	9.1.4 聲道
Adaptive sound	2.0 聲道	9.1.4 聲道
	5.1 聲道	9.1.4 聲道
	7.1 聲道	9.1.4 聲道
	Dolby Atmos®、DTS:X	9.1.4 聲道

<HW-Q800B>

效果	輸入	輸出	
		只包含低音炮	連有源重低音音箱及環繞聲揚聲器
Standard	2.0 聲道	2.1 聲道	2.1 聲道
	5.1 聲道	5.1 聲道	5.1 聲道 / 7.1 聲道 (DTS)
	7.1 聲道	5.1 聲道	7.1 聲道
	Dolby Atmos®、DTS:X	5.1.2 聲道	7.1.4 聲道
Surround	2.0 聲道	5.1.2 聲道	7.1.4 聲道
	5.1 聲道	5.1.2 聲道	7.1.4 聲道
	7.1 聲道	5.1.2 聲道	7.1.4 聲道
	Dolby Atmos®、DTS:X	5.1.2 聲道	7.1.4 聲道
Game	2.0 聲道	5.1.2 聲道	7.1.4 聲道
	5.1 聲道	5.1.2 聲道	7.1.4 聲道
	7.1 聲道	5.1.2 聲道	7.1.4 聲道
	Dolby Atmos®、DTS:X	5.1.2 聲道	7.1.4 聲道
Adaptive sound	2.0 聲道	5.1.2 聲道	7.1.4 聲道
	5.1 聲道	5.1.2 聲道	7.1.4 聲道
	7.1 聲道	5.1.2 聲道	7.1.4 聲道
	Dolby Atmos®、DTS:X	5.1.2 聲道	7.1.4 聲道

<HW-Q700B>

效果	輸入	輸出	
		只包含低音炮	連有源重低音音箱及環繞聲揚聲器
Standard	2.0 聲道	2.1 聲道	2.1 聲道
	5.1 聲道	3.1 聲道	5.1 聲道
	Dolby Atmos®、DTS:X	3.1.2 聲道	5.1.4 聲道
Surround	2.0 聲道	3.1.2 聲道	5.1.4 聲道
	5.1 聲道	3.1.2 聲道	5.1.4 聲道
	Dolby Atmos®、DTS:X	3.1.2 聲道	5.1.4 聲道
Game	2.0 聲道	3.1.2 聲道	5.1.4 聲道
	5.1 聲道	3.1.2 聲道	5.1.4 聲道
	Dolby Atmos®、DTS:X	3.1.2 聲道	5.1.4 聲道
Adaptive sound	2.0 聲道	3.1.2 聲道	5.1.4 聲道
	5.1 聲道	3.1.2 聲道	5.1.4 聲道
	Dolby Atmos®、DTS:X	3.1.2 聲道	5.1.4 聲道

使用 **Standard** 模式時，環繞聲揚聲器不會為 2 聲道輸出製造音效。如果啟用環繞聲揚聲器的音效，可將效果模式變更為 **Surround**。

使用電視遙控器調校 Soundbar 音量。







使用電視遙控器調校 Soundbar 音量。

- 此功能只可以與 IR 遙控器一併使用。藍牙遙控器 (需要進行配對的遙控器) 不受支援。
- 將電視揚聲器設定為**外部揚聲器**以使用此功能。
- 支援該功能的製造商：
Samsung, VIZIO, LG, Sony, Sharp, PHILIPS, PANASONIC, TOSHIBA, Hisense, RCA

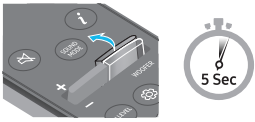
1. 關閉 Soundbar。

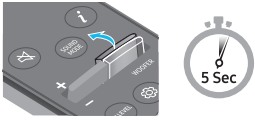
2. 向上按住**低音炮**按鈕 5 秒。

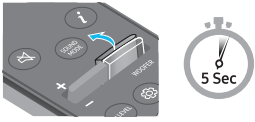
每次向上推動**低音炮**按鈕 5 秒時，模式會按以下次序切換：「OFF-TV REMOTE」(預設模式)、「SAMSUNG-TV REMOTE」、「ALL-TV REMOTE」。

遙控器按鈕	顯示	狀態
	(預設模式) 	停用電視遙控器。
		啟用三星電視的 IR 遙控器。
		啟用第三方電視的 IR 遙控器。

04 連接 SOUNDBAR

連接電源和裝置

使用電源線按以下順序將有源重低音音箱、環繞聲揚聲器和 Soundbar 連接至電源插座：

- 如需更多有關所需電源及耗電的資料，請見產品上附有的標籤。(標籤：Soundbar 主機背面)

1. 將電源線連接至低音炮

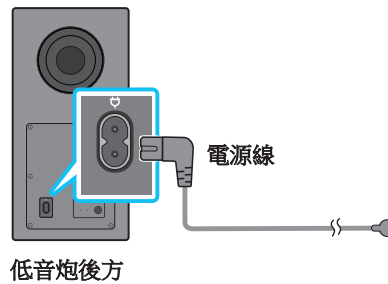

2. 將電源線連接至左右環繞聲揚聲器。(非必要)

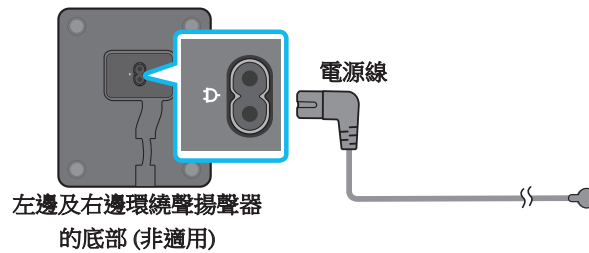

3. 將電源線連接至 Soundbar。

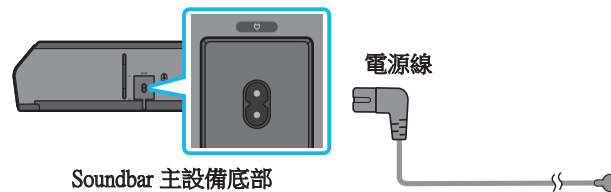

4. 將 Soundbar、有源重低音音箱和環繞聲揚聲器連接至電源。有源重低音音箱和環繞聲揚聲器將會自動連接至已開啟的 Soundbar。

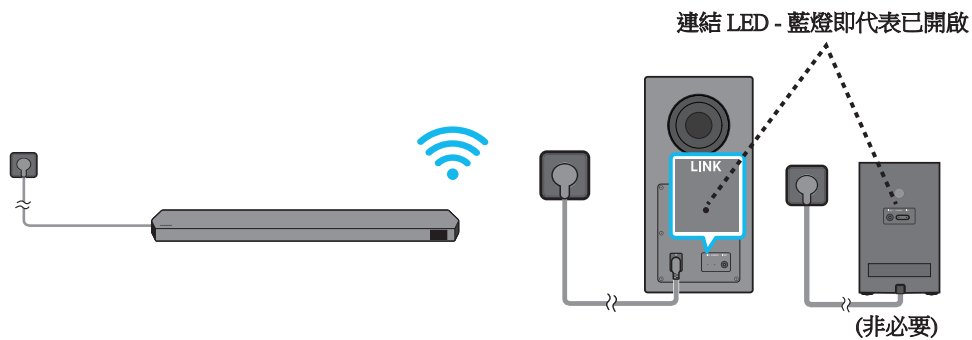

注意

- 有源重低音音箱和環繞聲揚聲器連接至 Soundbar 前應先連接電源。開啟 Soundbar 時，有源重低音音箱和環繞聲揚聲器將會自動連接。
- 如果您在產品開啟期間拔除電源並再次連接電源線，Soundbar 會自動開啟。
- 只有適用的型號支援環繞聲揚聲器系統。

建議的揚聲器擺位

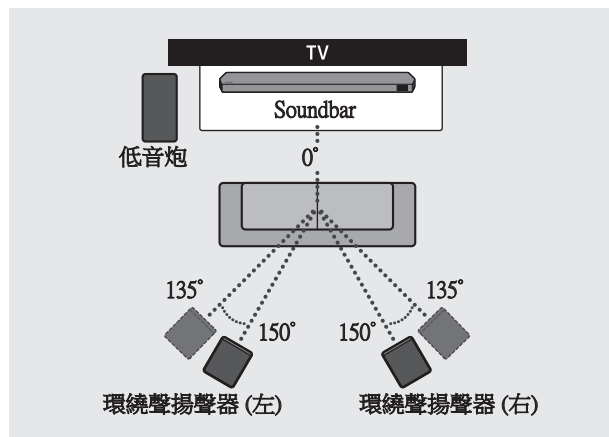

⚠ 注意

- 無線有源重低音音箱和環繞聲揚聲器內置無線接收天線。裝置應遠離水份和濕氣。
- 為了獲得最佳聆聽效果，請確保無線有源重低音音箱和環繞聲揚聲器周圍沒有障礙物。

環繞聲揚聲器模式 (只限 HW-Q930B)

視乎後置揚聲器的擺放位置，可能可提供最佳環繞聲。請參閱下圖，了解揚聲器的擺位。

如要啟用此模式，請使用 Soundbar 的遙控器選擇環繞聲揚聲器模式。

(音訊控制) → 環繞聲揚聲器 → ▲ (上) / ▼ (下) → Front / Rear

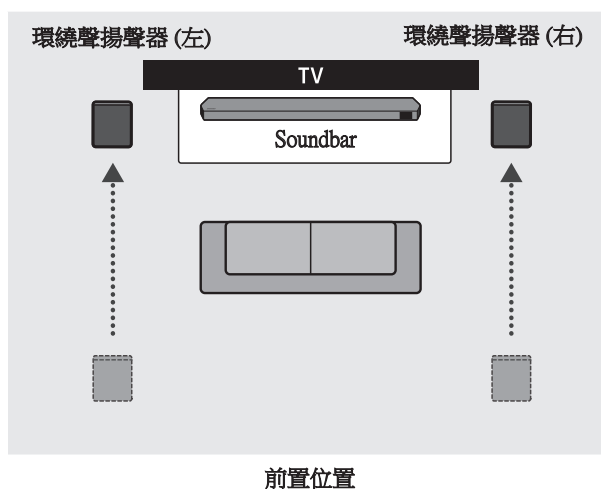
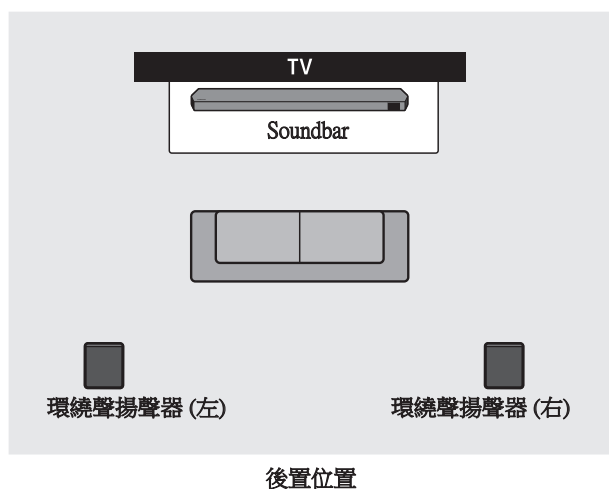

注意

- 此模式僅適用於備有特定環繞聲揚聲器的 Soundbar 型號。
- 在前置揚聲器模式下，將前置揚聲器朝向自己。
- 後置揚聲器模式會預設啟用。

手動連接有源重低音音箱或環繞聲揚聲器

執行下方手動連接程序前：

- 確認 Soundbar、有源重低音音箱和環繞聲揚聲器的電源線是否已正確連接。
- 確保 Soundbar 已關閉。

1. 關閉 Soundbar 主設備。
2. 按住有源重低音音箱和環繞聲揚聲器背面的 **ID SET** 至少 5 秒。
 - 揚聲器後方的紅色指示燈熄滅，藍色指示燈閃爍。

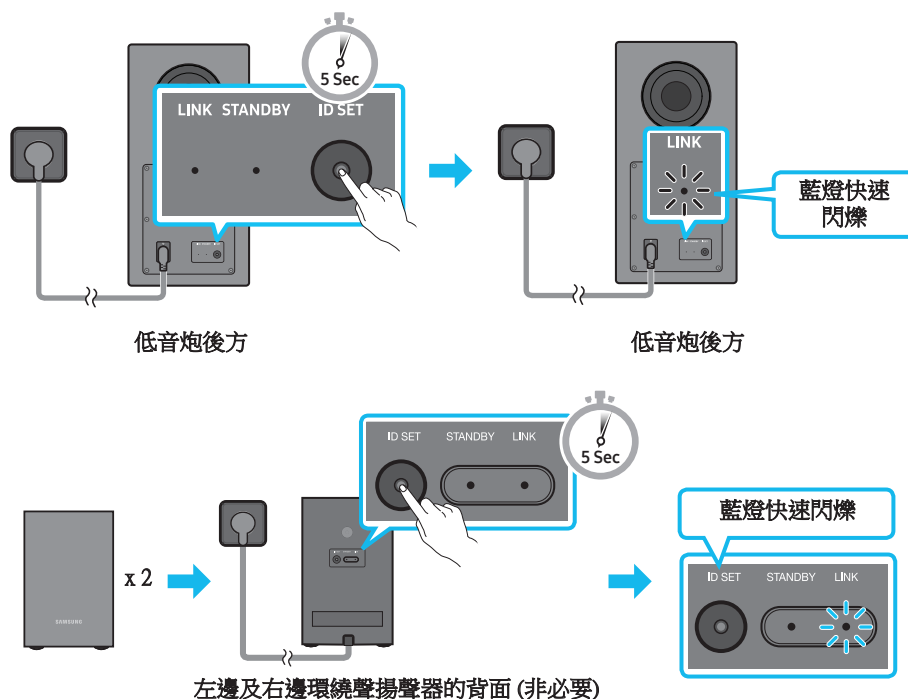

3. 按住遙控器上的上按鈕 5 秒。
 - Soundbar 顯示螢幕上將顯示 **ID SET** 訊息，然後在短時間內消失。
 - **ID SET** 完成後，Soundbar 會自動開啟。

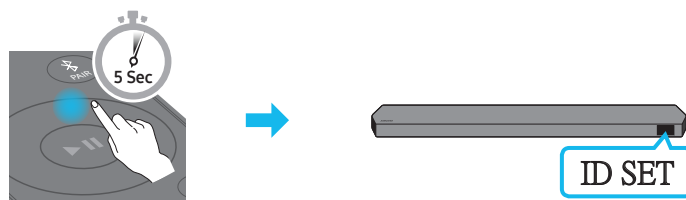

4. 檢查 **LINK LED** 亮起藍色 (連接完成)。

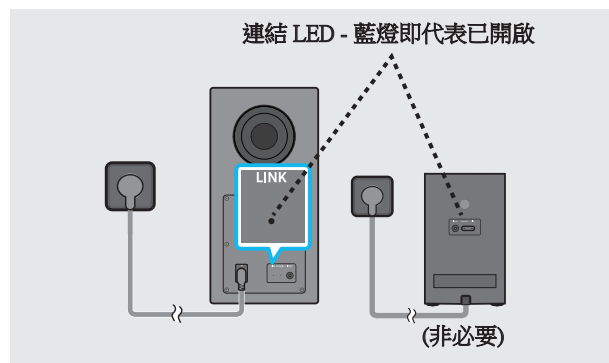

Soundbar、無線有源重低音音箱、環繞聲揚聲器之間成功建立連線時，「連結 LED」指示燈將會停止閃爍，並長亮藍燈。

有源重低音音箱和環繞聲揚聲器背面的 LED 指示燈

LED	狀態	描述	解決方法
<p>低音炮</p>  <p>藍色</p> <p>環繞聲揚聲器 (僅限適用型號)</p>  <p>藍色</p>	開	成功連接 (正常操作)	-
<p>低音炮</p>  <p>紅色</p> <p>環繞聲揚聲器 (僅限適用型號)</p>  <p>紅色</p>	閃爍	正在恢復連接	檢查電源線是否已正確連接 Soundbar 主設備，或等待約 5 分鐘。如果指示燈仍然持續閃爍，請嘗試手動連接有源重低音音箱和環繞聲揚聲器。請參閱第 16 頁。
<p>低音炮</p>  <p>紅色</p> <p>環繞聲揚聲器 (僅限適用型號)</p>  <p>紅色</p>	開	待機 (Soundbar 主設備已關閉) 連接失敗	檢查電源線是否已正確連接 Soundbar 主設備。 重新連接。參閱第 16 頁的手動連接指示。
<p>低音炮</p>  <p>紅色和藍色</p> <p>環繞聲揚聲器 (僅限適用型號)</p>  <p>紅色和藍色</p>	閃爍	故障	參閱本手冊的三星服務中心聯絡資料。

注意

- 如果主裝置的電源關閉，無線有源重低音音箱將處於待機模式，並且背後的 STANDBY LED 將會閃爍藍色數次，然後轉為紅色。
- 如 Soundbar 附近與 Soundbar 使用相同頻率的裝置，便可能會對音訊造成干擾。
- 主機無線訊號的最大傳輸距離約為 10 米，但可能會因為操作環境不同而有分別。如果主機與無線有源重低音音箱之間有鋼筋混凝土牆或金屬牆，系統可能會完全無法運作，因為無線訊號無法穿透金屬。
- 只有適用的型號支援環繞聲揚聲器系統。

⚠ 注意

- 無線有源重低音音箱和環繞聲揚聲器內置無線接收天線。裝置應遠離水份和濕氣。
- 為了獲得最佳聆聽效果，請確保無線有源重低音音箱和環繞聲揚聲器周圍沒有障礙物。

05 連接至電視

連接支援 HDMI ARC (音訊回傳通道) 的電視

⚠ 注意

- 同時連接 HDMI 纜線和光纖電纜時，會首先接收 HDMI 訊號。
- 如要連接電視和 Soundbar 之間的 HDMI 纜線，請確保連接標示為 ARC 的端子。否則可能不會輸出電視聲音。
- 建議使用 **High Speed HDMI Cable with Ethernet**。

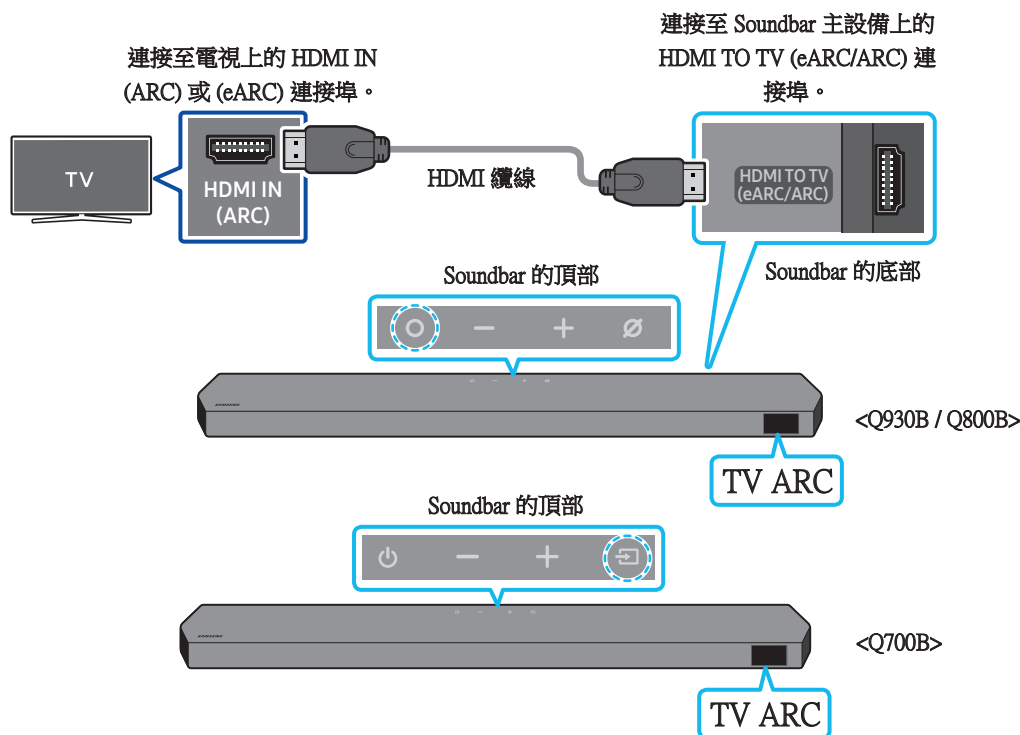

1. 關閉 Soundbar 和電視，按照圖解連接 HDMI 纜線。
2. 開啟 Soundbar 和電視。
3. 「TV ARC」在 Soundbar 主設備的顯示螢幕上出現，而電視聲音亦會播放。
 - 若電視聲音沒有輸出，按下 Soundbar 頂部的 **○ (多功能) / ⏮ (來源)** 按鈕，或遙控器上的 **⏮ (來源)** 按鈕，並選擇 **D.IN** 模式。螢幕顯示順序「D.IN」和「TV ARC」，並播放電視聲音。
 - 連接支援 eARC 功能的電視時，「eARC」會在顯示屏上出現，並且會發出聲音。
 - 如要使用 eARC 進行連接，電視功能表的 eARC 功能應設為開啟。有關設定的詳細資訊，請參閱電視使用者手冊。(例如 Samsung TV：首頁 (🏠) → 功能表 → 設定 (⚙) → 所有設定 (⚙) → 音效 → 專業設定 → HDMI-eARC 模式 (自動))
 - 如果「TV ARC」沒有出現在 Soundbar 主設備的顯示螢幕上，請確定 HDMI 線已插入正確的連接埠。
 - 使用電視遙控器上的音量按鈕來更改 Soundbar 的音量。

注意

- 當您以 HDMI 纜線把支援 HDMI ARC (音訊回傳通道) 的電視連接至 Soundbar，無須連接另一條光纖電纜即可傳輸數位視訊和音訊數據。
- 我們建議採用無芯 HDMI 纜線。如果使用有芯 HDMI 纜線，其直徑須在 14mm 以下。
- 如果 HDMI 纜線不支援 ARC，就不能使用此功能。
- 若廣播的音訊以 Dolby Digital 編碼，且電視上的「數位輸出音訊格式」設定為 PCM，我們建議您將設定變更為 Dolby Digital。電視設定變更後，您可享受較佳的音質。(電視功能表可能使用不同文字顯示 Dolby Digital 和 PCM，視乎電視製造商而定。)
- ARC/eARC 協議支援 Dolby Atmos。
- 確定內容支援 Dolby Atmos®。

使用光纖纜線連接

連接前的檢查列表

- 同時連接 HDMI 纜線和光纖電纜時，會首先接收 HDMI 訊號。
- 如果所採用的光纖電纜端子有蓋，請僅記移除端子口。

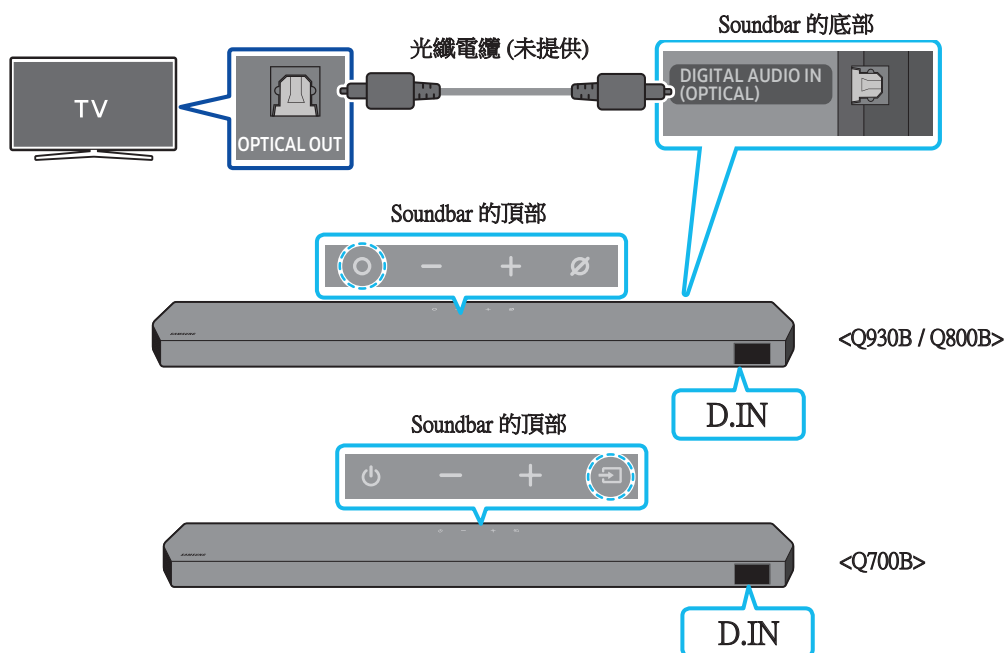

1. 電視和 Soundbar 關閉後，按照圖解以光纖電纜 (未提供) 連接 Soundbar 上的 **DIGITAL AUDIO IN (OPTICAL)** 連接埠和電視上的光纖輸出插口。
2. 開啟 Soundbar 和電視。
3. 按下 Soundbar 頂部的 **○ (多功能)** / **☐ (來源)** 按鈕或遙控器上的 **☐ (來源)** 按鈕，並選擇 **D.IN** 模式。
4. 電視聲音透過 Soundbar 輸出。

透過 Bluetooth 連接

以藍牙連接 Samsung 電視，可以在享受立體聲音效的同時免卻插電線的煩惱。

- 同時只可連接一部 Samsung 電視。
- 可以連接支援藍牙的 Samsung 電視。請檢查電視的規格。

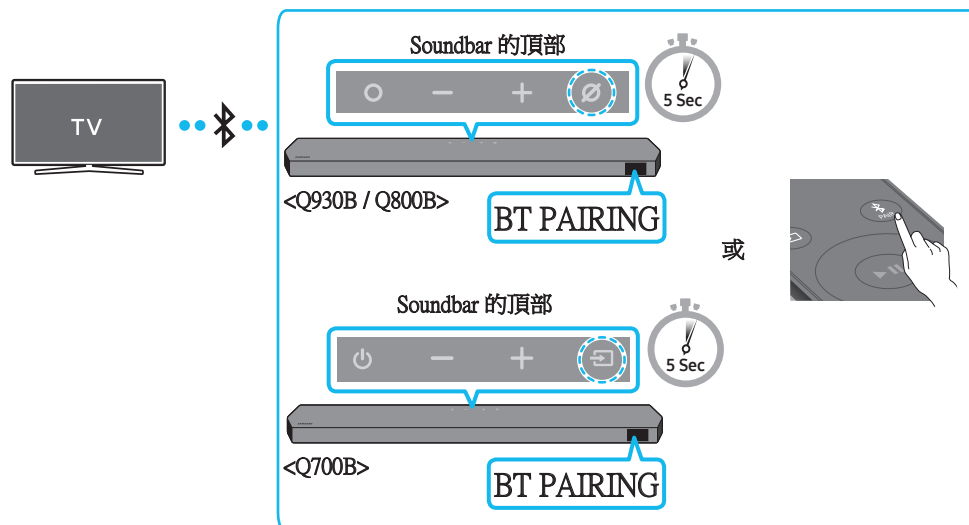

首次連接

1. 按下 Soundbar 遙控器上的 **PAIR** 按鈕，以進入「**BT PAIRING**」模式。

(或) a. 按下頂部面板的 **○ (多功能) / [] (來源)** 按鈕，然後選擇 **BT**。

如果有連接紀錄，「**BT**」會於幾秒內自動變更為「**BT PAIRING**」或「**BT READY**」。

b. 看到 **BT READY** 時，按住 Soundbar 頂部面板上的 **⊗ (麥克風開/關) / [] (來源)** 按鈕超過 5 秒，以顯示 **BT PAIRING**。

2. 在 Samsung 電視選擇藍牙模式。

(例如，首頁 **[]** → 功能表 → 設定 **[]** → 所有設定 **[]** → 音效 → 音效輸出 → 藍牙揚聲器列表 → Soundbar Q***B (Bluetooth))

3. 從電視畫面的清單選擇「**Soundbar Q***B**」。

可用的 Soundbar 會在電視的藍牙裝置清單上標示為「**需要配對**」或「**已配對**」。要連接 Samsung 電視至 Soundbar，請選擇訊息，然後建立連接。

- 連結了 Samsung 電視後，**[電視名稱]** → 「**藍牙**」會顯示在 Soundbar 的前方顯示屏上。

4. 然後便可以聽到 Soundbar 播放 Samsung 電視的聲音。

- 首次將 Soundbar 連接至 Samsung 電視後，可使用「**BT READY**」模式重新連接。

如果裝置連接失敗

- 如 Samsung TV 的揚聲器清單中已存在有 Soundbar (例如 **Soundbar Q***B**)，請將其刪除。
- 然後重複第 1 至 3 步。

從 Samsung 電視解除 Soundbar 的連接

按下 Soundbar 頂部的 **○ (多功能) / [] 來源** 按鈕或遙控器上的 **[] (來源)** 按鈕，並選擇 **BT** 模式。

- 由於 Samsung 電視必須接收 Soundbar 的回應，因此解除連接需要時間。
(所需時間可能視乎 Samsung 電視型號而有異。)

BT READY 和 BT PAIRING 有什麼不同？

- **BT READY**：在這個模式下，您可以重新連接任何以前連接過的 Samsung 電視或流動裝置。
- **BT PAIRING**：在這個模式，您可以將新裝置連接至 Soundbar。
(在 Soundbar 處於 **BT** 模式時，按下 Soundbar 遙控器上的 **PAIR** 按鈕，或按住 Soundbar 頂端的  (麥克風開/關) /  (來源) 按鈕超過 5 秒。)

藍牙連接注意事項

- 把新裝置放置在 1 米內的地方，以透過連接藍牙通訊連接。
- 重新連接藍牙裝置時如需輸入 PIN 碼，請輸入 <0000>。
- Soundbar 會在處於就緒狀態 18 分鐘後自動關閉。
- 在下列情況下，Soundbar 可能無法正確執行藍牙搜尋或連接：
 - 如果 Soundbar 周圍具有強電場。
 - 如果同時有兩個或更多的藍牙裝置與 Soundbar 配對。
 - 如果藍牙裝置已關閉、沒有就位或發生故障。
- 電子裝置可能會導致無線電干擾。發放電磁波的裝置必須與 Soundbar 主設備保持遠距離，當中包括微波爐、無線 LAN 裝置等。

透過 Wi-Fi 連接

連接前的檢查列表

- Wi-Fi 連接只適用於 Samsung TV。
- 檢查**無線路由器 (Wi-Fi)** 是否已開啟，同時**電視是否已連接至路由器**。
- 電視和 Soundbar 必須連接到相同的無線網絡 (Wi-Fi)。
- 如果您的無線路由器 (Wi-Fi) 使用 DFS 頻道，則將無法在電視和 Soundbar 之間建立 Wi-Fi 連接。請與您的互聯網服務供應商聯絡以了解詳情。
- 不同製造年份的功能表有所不同，請參閱您的電視手冊。
- 要將電視透過 Wi-Fi 連接至 Soundbar，請先將 Soundbar 連接至無線路由器。有關如何建立 Wi-Fi 連接的詳細資訊，請參閱第 29 頁。

1. 如需更多有關以 Wi-Fi 連接至 Soundbar 的資訊，請參閱第 29 頁，「**方法 2。透過 Wi-Fi (無線網絡) 連接**」。

2. 使用音訊功能表，將電視的輸入(來源)改為 Soundbar。

- **2017 年或之後發佈的 Samsung TV**

首頁 (🏠) → 功能表 → 設定 (⚙️) → 所有設定 (⚙️) → 音效 → 音效輸出 → Soundbar Q***B (Wi-Fi)

注意

只有部分 Samsung 電視和部分 Soundbar 型號才有提供 Wi-Fi Dolby Atmos 連接。

使用 Q-Symphony 功能

使用 Q-Symphony 時，Soundbar 會與 Samsung 電視同步，透過兩部裝置以最佳環迴音效播放聲音。Soundbar 連接好後，功能表「TV+Soundbar」會在電視的**音效輸出**功能表中出現。選擇相應的功能表。

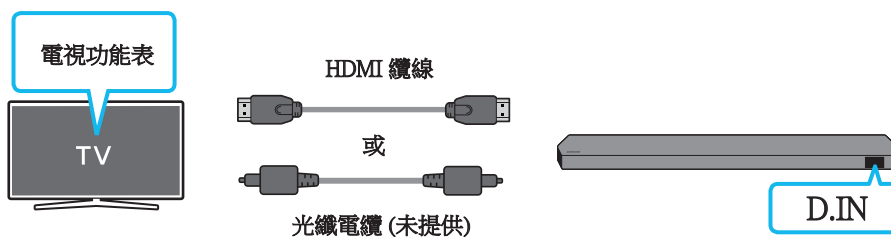

- 電視功能表例子：電視 + [AV] Soundbar 系列名稱 (HDMI)



- 電視功能表例子：TV + [AV] Soundbar 系列名稱 (Wi-Fi)

注意

- 可根據電視所支援的 Codec 運作。
- 僅於連接了 HDMI 纜線、光纖電纜 (無提供) 或 Wi-Fi 的情況下才支援此功能。
- 顯示的訊息可能因電視型號而有所不同。
- 確定您的電視和 Soundbar 已連接至相同的無線路由器/頻率。
- 只有部分 Samsung 電視和部分 Soundbar 型號才有提供此功能。

使用 Spacefit 音訊

透過分析聆聽空間來提供最佳音質。

方法 1。透過 Soundbar 連接

如要啟用此功能，請使用 Soundbar 的遙控器開啟 SpaceFit Sound 模式。

() (聲音控制) → 「Spacefit sound Off」 → ▲ (向上) → 「Spacefit sound On」)

- 所有音訊模式皆有提供此功能。

方法 2。透過電視連接

如要啟用此功能，請在 Samsung TV 的功能表中開啟調適音效+ 模式。

(首頁 ) → 功能表 → 設定 () → 所有設定 () → General → 智能模式設定 → 調適音效+)

- 如果已啟用電視的調適音效+ 模式，Soundbar 的音訊模式便會自動變更為調適音效+。

注意

- Soundbar 連接至部分 Samsung 電視時才能使用此功能。
- Q700B 型號僅支援「透過電視連接」方式。

06 連接外部裝置

方法 1。使用 HDMI 纜線連接 (支援 Dolby Atmos / DTS:X 解碼和播放)

連接前的檢查列表

- 如果音訊輸出選項包含第二音訊，須確定第二音訊設定為關閉。
- 確定內容支援 Dolby Atmos® / DTS:X。

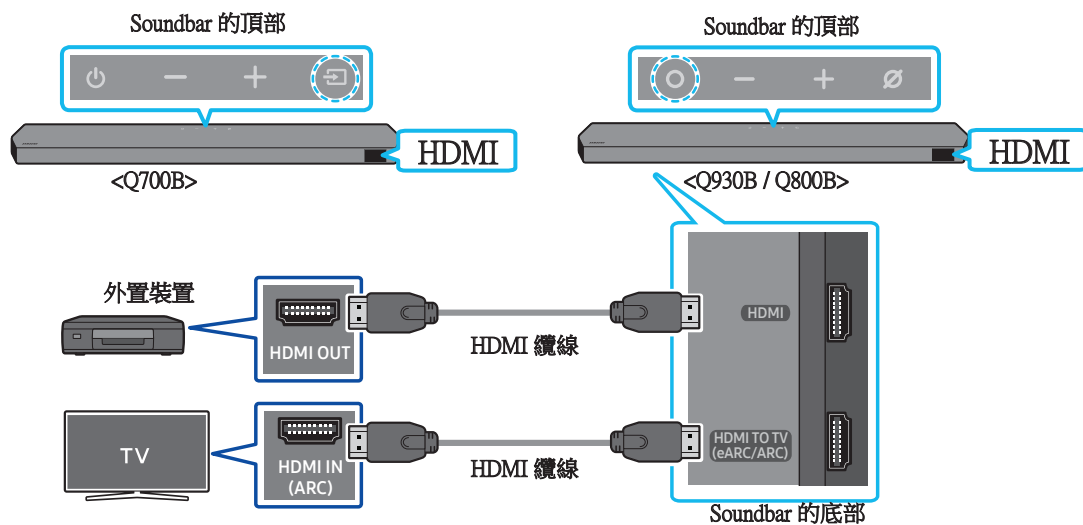

1. 使用 HDMI 纜線連接外置裝置的 HDMI OUT 連接埠，以及 Soundbar 底部的 HDMI 連接埠。
2. 使用 HDMI 纜線連接電視的 HDMI IN 連接埠，以及 Soundbar 底部的 HDMI TO TV (eARC/ARC) 連接埠。
3. 開啟 Soundbar、電視和外置裝置。
4. 按下 Soundbar 上方的 **○** (多功能) / **⇨** (來源) 按鈕或遙控器上的 **⇨** (來源) 按鈕，以選擇 HDMI 模式。
5. Soundbar 顯示目前已選擇「HDMI」模式，Soundbar 將會開始播放音效。

注意

- 使用 Dolby Atmos® / DTS:X 時：如果輸入訊號源為 Dolby Atmos® / DTS:X，請參閱第 11 頁的「不同音效模式的輸出規格」。
- Dolby Atmos® 啟動後，「DOLBY ATMOS」會在前方顯示屏上顯示。
- 啟用 DTS:X 後，「DTS:X」將顯示於正面螢幕。
- 在 BD 播放機或其他裝置上配置 Dolby Atmos® / DTS:X
在 BD 播放機或其他裝置的設定功能表上開啟音訊輸出選項，並確定已為 Bitstream 選擇「沒有編碼」。例如，在三星 BD 播放機上，前往首項功能表 → 音效 → 數碼輸出，然後選擇 Bitstream (未處理)。

支援的 UHD 訊號規格 (3840 x 2160p)

畫面播放速率 (fps)	色彩深度	RGB 4:4:4	YCbCr 4:4:4	YCbCr 4:2:2	YCbCr 4:2:0
< 60	8 位元	○	○	○	○
	10 位元	-	-	○	○
	12 位元	-	-	○	○
120	8 位元	-	-	-	-
	10 位元	-	-	-	-

- 支援的規格可能會因所連接的外置裝置或使用狀況而有所不同。

方法 2。使用光纖纜線連接

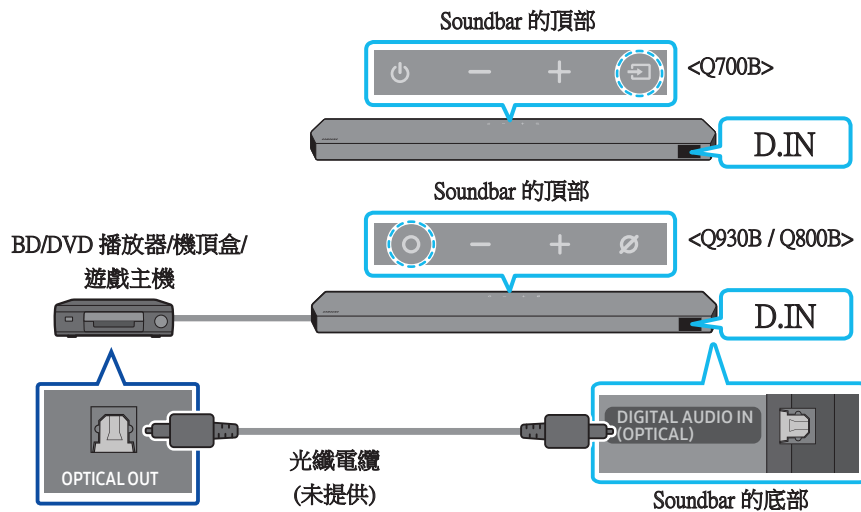

1. 使用光纖電纜 (非隨附附件) 連接至 Soundbar 主機的 **DIGITAL AUDIO IN (OPTICAL)** 和外置裝置的 **OPTICAL OUT** 連接埠。
2. 開啟 Soundbar 和外置裝置。
3. 如要選擇 **D.IN** 模式，請按下 Soundbar 上方的 **○ (多功能) /  (來源)** 按鈕，或遙控器上的 ** (來源)** 按鈕。
4. Soundbar 會從外部裝置播放聲音。

07 連接流動裝置

方法 1。透過藍牙連接

以藍牙連接流動裝置，可以在享受立體聲音效的同時免卻插電線的煩惱。

- 在 Soundbar 已關閉的情況下連接已配對的藍牙裝置，會令 Soundbar 自動開啟。

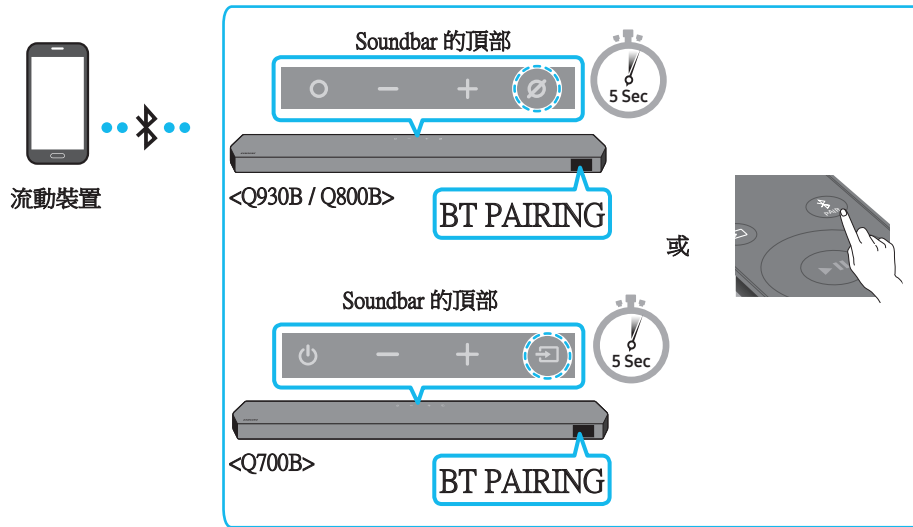

首次連接

- 連接新藍牙裝置時，確保該裝置位於 1 米之內。
- 按下 Soundbar 遙控器上的 **PAIR** 按鈕，以進入「BT PAIRING」模式。
 - (或) a. 按下頂部面板的 **○ (多功能) / ↵ (來源)** 按鈕，然後選擇 BT。
 - 如果有連接紀錄，「BT」會於幾秒內自動變更為「BT PAIRING」或「BT READY」。
 - b. 看到 BT READY 時，按住 Soundbar 頂部面板上的 **⊘ (麥克風開/關) / ↵ (來源)** 按鈕超過 5 秒，以顯示 BT PAIRING。
 - 在裝置上，從顯示的清單中選擇「Soundbar Q***B」。
 - Soundbar 連接至流動裝置後，[流動裝置名稱] → 「BT」會在前方螢幕上顯示。
 - 透過 Soundbar 播放藍牙連接裝置上的音樂檔案。
 - 首次將 Soundbar 連接至流動裝置後，可使用「BT READY」模式重新連接。

如果裝置連接失敗

- 如果流動裝置的揚聲器清單中已存在 Soundbar (例如「Soundbar Q***B」)，請將其刪除。
- 然後重複第 1 至 2 步。

BT READY 和 BT PAIRING 有什麼不同？

- BT READY**：在這個模式下，您可以重新連接任何以前連接過的 Samsung 電視或流動裝置。
- BT PAIRING**：在這個模式，您可以將新裝置連接至 Soundbar。
(在 Soundbar 處於 BT 模式時，按下 Soundbar 遙控器上的 **PAIR** 按鈕，或按住 Soundbar 頂端的 **⊘ (麥克風開/關) / ↵ (來源)** 按鈕超過 5 秒。)

藍牙連接注意事項



- 把新裝置放置在 1 米內的地方，以透過連接藍牙通訊連接。
- 重新連接藍牙裝置時如需輸入 PIN 碼，請輸入 <0000>。
- Soundbar 會在處於就緒狀態 18 分鐘後自動關閉。
- 在下列情況下，Soundbar 可能無法正確執行藍牙搜尋或連接：
 - 如果 Soundbar 周圍具有強電場。
 - 如果同時有兩個或更多的藍牙裝置與 Soundbar 配對。
 - 如果藍牙裝置已關閉、沒有就位或發生故障。
- 電子裝置可能會導致無線電干擾。發放電磁波的裝置必須與 Soundbar 主設備保持遠距離，當中包括微波爐、無線 LAN 裝置等。
- Soundbar 支援 SBC 數據 (44.1kHz、48kHz)。
- 只連接至支援 A2DP (AV) 功能的 Bluetooth 裝置。
- 您不可以將 Soundbar 連接至只支援 HF (免提) 功能的 Bluetooth 裝置。
- 將 Soundbar 連接至 Bluetooth 裝置時，將兩者盡量靠近。
- Soundbar 和 Bluetooth 裝置相距愈遠，音質愈低。
若裝置超出有效範圍，藍牙連接可能會中斷。
- 若接收情況欠佳，Bluetooth 連接可能無法如預期運作。
- 在以下情況下，Bluetooth 裝置可能會發出嘈音或無法正常運作：
 - 身體接觸到 Bluetooth 裝置或 Soundbar 上的訊號收發器時
 - 位於角落或附近有障礙物 (例如：牆壁或隔板) 的地方，電磁場都可能會產生變化。
 - 受相同頻段下運作的產品的無線電干擾，例如醫療設備、微波爐和無線 LAN 裝置。
 - 即使裝置處於有效範圍，門和牆壁等障礙物仍可能會影響音質。
- 請注意，使用 Bluetooth 選項時，您的 Soundbar 不可與其他 Bluetooth 裝置配對。
- 該無線裝置在運行時可能產生電子干擾。

從 Bluetooth 裝置解除連接 Soundbar

您可以從 Bluetooth 裝置解除連接 Soundbar。如需相關指引，可參閱 Bluetooth 裝置的使用者手冊。

- Soundbar 將會中斷連接。
- Soundbar 從 Bluetooth 裝置解除連接後，Soundbar 的前置顯示器會顯示「BT DISCONNECTED」。

從藍牙裝置解除連接 Soundbar

按下 Soundbar 上方的 **○ (多功能) /  (來源)** 按鈕或遙控器上的 ** (來源)** 按鈕，以從 BT 模式切換至其他模式。

- 由於 Bluetooth 裝置必須接收 Soundbar 的回應，因此解除連接需要時間。(解除連接的時間可能有異，視乎藍牙裝置而定)
- Soundbar 從 Bluetooth 裝置解除連接後，Soundbar 的前置顯示器會顯示「BT DISCONNECTED」。

方法 2。透過 Wi-Fi (無線網絡) 連接

以無線網絡 (Wi-Fi) 連接 Soundbar 至流動裝置需要使用 **SmartThings** 應用程式。

首次連接

1. 在流動裝置 (智能電話、平板電腦等) 上安裝並啟動 **SmartThings** 應用程式。
2. 在應用程式上，按鈕螢幕上的指示加入 Soundbar。
 - 在部分流動裝置上，自動彈出視窗 (下方第二個螢幕截圖) 可能無法使用。如視窗沒有彈出，請按下首頁畫面上的「+」。
 - 下圖可能會根據應用程式版本而有所不同。



Tap Sound 用法

透過流動裝置輕點一下 Soundbar，可透過 Soundbar 播放流動裝置內容的聲音。

- 此功能可能視乎流動裝置型號而無法使用。
- 此功能只與 Android 8.1 或更高版本的 Samsung 流動裝置兼容。

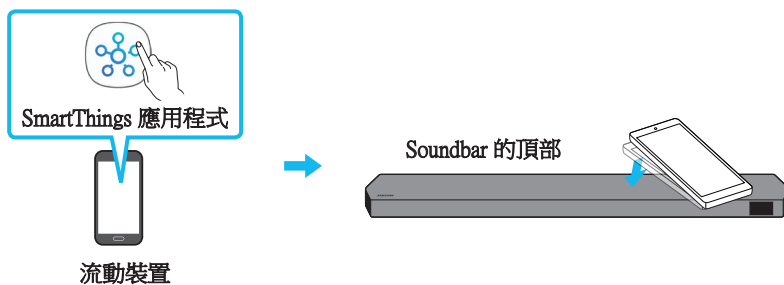

1. 開啟流動裝置上的 **Tap Sound** 功能。
 - 有關該功能的開啟方法，請參閱以下的「**設定 Tap Sound 功能**」。
2. 以流動裝置輕點一下 Soundbar。在出現的訊息視窗中選擇「**Start now**」。
流動裝置會透過藍牙與 Soundbar 連接。
3. 透過 Soundbar 播放流動裝置內容的聲音。
 - 此功能透過偵測流動裝置碰觸 Soundbar 時產生的震動，從而以 Bluetooth 連接流動裝置至 Soundbar。
 - 請確保流動裝置沒有輕點 Soundbar 的尖角。否則 Soundbar 或流動裝置有可能刮花或受損。
 - 建議用保護殼包裹流動裝置。輕力點一下 Soundbar 頂部的寬廣部分，避免用力過度。
 - 為使用此功能，請將 **SmartThings** 應用程式更新為最新版本。
此功能可能視乎應用程式版本而無法使用。

設定 Tap Sound 功能

使用 **SmartThings** 應用程式開啟 **Tap View, Tap Sound** 功能。

1. 在流動裝置執行 **SmartThings** 應用程式。
2. 在顯示於流動裝置的 **SmartThings** 應用程式畫面選擇 (☰→⚙️)。
3. 把「**Tap View, Tap Sound**」設定為開啟，以允許該功能於流動裝置靠近 Soundbar 時運作。功能已經開啟。

注意

- 流動裝置處於省電模式時，**Tap Sound** 功能不會運作。
- 如 Soundbar 附近有可以造成電磁干擾的裝置，例如電子裝置，則 **Tap Sound** 功能有可能失靈。請確保讓有可能造成電磁干擾的裝置和 Soundbar 保持充足距離。

08 透過 APPLE AIRPLAY 2 連接

- 此功能在部分國家/地區可能無法使用。
- • 此 Samsung Soundbar 支援 AirPlay 2，必須運行 iOS 11.4 或更新的版本。

只要有了 AirPlay 2，您就可以透過 Apple 裝置將音樂、Podcast 以及其他音訊串流至 Samsung Soundbar。

- 確認 Soundbar 是否已經開啟電源並連接至與 Apple 裝置相同的 Wi-Fi 網絡。
- 在支援 AirPlay 的應用程式或 iPhone、iPad、Mac 上選取 。
- 從可用裝置的清單選取 Soundbar，以播放目前的音訊內容。

09 安裝支掛牆支架

安裝注意事項

- 僅可安裝於垂直的牆面上。
- 不要在高溫或潮濕的地方安裝。
- 檢查牆壁強度是否足以支撐產品的重量。如果強度不足，應該強化牆壁或選擇其他位置安裝。
- 購買並使用適用於您的牆壁類型 (石膏板、鐵板、木板等等) 的固定螺釘或螺絲。如果可以，請將固定螺釘轉進牆柱。
- 根據需要掛裝 Soundbar 的牆壁類型和厚度，購買牆壁安裝支架所需的螺釘。
 - 直徑：M5
 - 長度：建議 35 毫米或更長。
- 把 Soundbar 安裝到牆上前，先用纜線把設備和外置裝置連接起來。
- 確保設備已經關閉而且電源已經拔除，然後才著手安裝。否則可能會造成觸電。

掛牆元件

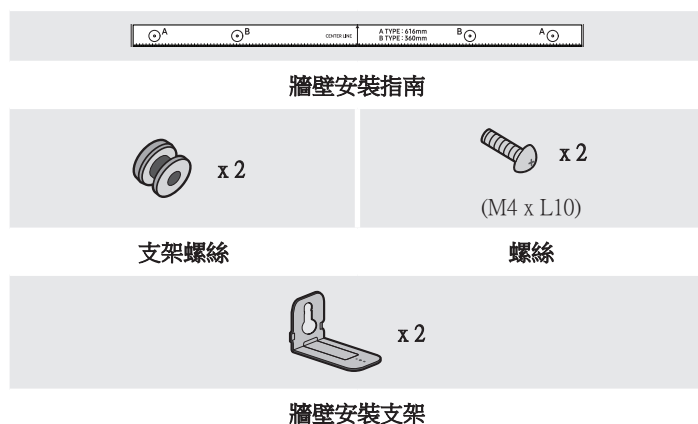

1. 將**牆壁安裝指引圖**貼在牆面。

- **牆壁安裝指南**必須保持水平。
- 如果將電視安裝到牆上，將 Soundbar 安裝在電視下方最少 5 厘米位置。

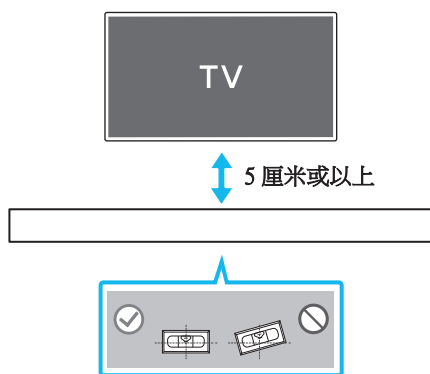

2. 將**牆壁安裝指南**的**中央線**對齊電視的中心位置 (若將 Soundbar 安裝在電視的下方)，再用膠紙將**牆壁安裝指南**固定在牆上。
- 若非安裝於電視下方，請將**中央線**對準安裝位置的中心。

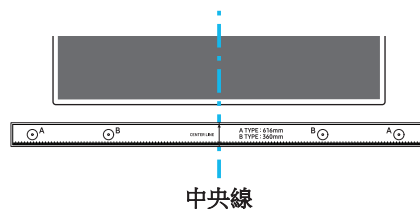

3. 用筆尖或削尖的鉛筆尖戳破安裝指引圖兩端的**A 型**圖像，以標記固定螺釘孔的位置，然後拿開**牆壁安裝指引圖**。

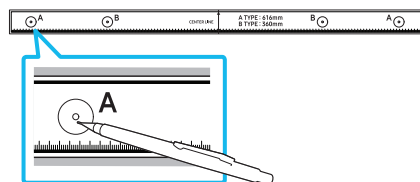

4. 用尺寸合適的鑽頭在各標記處鑽孔。

- 若標記與牆體上位置不符，在插入固定螺釘前，請確定您是否在孔中插入正確的螺釘或螺絲。若使用螺釘或螺絲，請確保孔足夠大可以插入螺釘或螺絲。

5. 在每個**支架螺釘**中插入一個螺釘 (未提供)，再將**支架螺釘**中的螺釘擰緊。

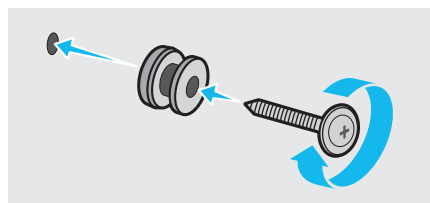

6. 使用 2 顆**螺釘**將 2 個**牆壁安裝支架**以正確的方向安裝在 Soundbar 底部。

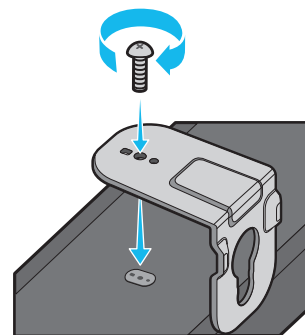

- 組裝時，確保**牆壁安裝支架**的掛架放置於 Soundbar 後方。

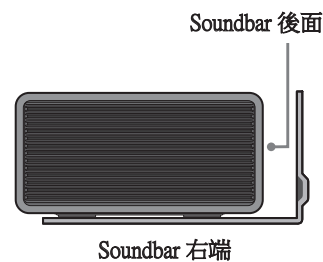

7. 將**牆壁安裝支架**安裝到 Soundbar，然後將**牆壁安裝支架**懸掛在牆上的**支架螺釘**上。

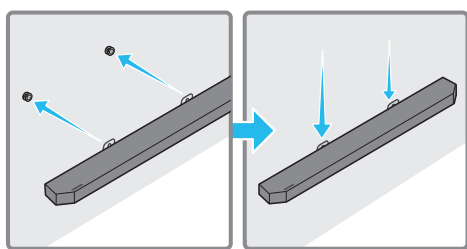

8. 向下滑動 Soundbar (如下圖)，令**牆壁安裝支架**穩妥安放在**支架螺釘**上。

- 將**支架螺釘**插入**牆壁安裝支架**的寬闊 (底部) 部分，然後將**牆壁安裝支架**向下滑動，令**牆壁安裝支架**穩妥安放在**支架螺釘**上。

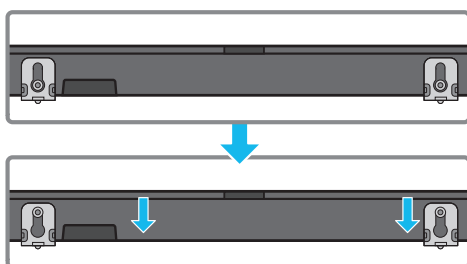

在牆上安裝環繞聲揚聲器 (僅限適用型號)

您可以單獨購買掛牆支架，以將環繞聲揚聲器安裝在牆上。
Samsung Electronics 並沒有出售掛牆支架。

將環繞聲揚聲器安裝在牆上的注意事項

- 環繞聲揚聲器掛牆支架必須能夠承受超過 8.0 公斤的重量。
- 鑽孔大小：1/4 - 20 UNC 螺紋嵌件
 - 標準螺釘：6.35 毫米
1.27 mm 螺絲距離
 - 長度：18 毫米長
 - 數量：左邊 1 粒/右邊 1 粒

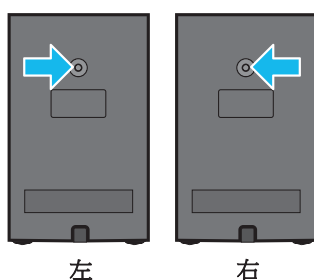

- 安裝掛牆支架之前，請先檢查牆壁的強度。如果強度不足，請在安裝掛牆支架和揚聲器前，先對牆壁進行加固。
- 由於產品安裝不當而導致產品損壞，Samsung Electronics 概不負責。
- 請注意，切勿將揚聲器打側或反轉安裝。

10 將 SOUNDBAR 安裝於電視前方

組件

x 4

橡膠腳

如要安裝，將**橡膠腳**安裝至 Soundbar 底部，然後才放置在電視架上。確保您已安裝**橡膠腳**，同時橡膠腳不會超出電視架的邊緣。參閱下圖。

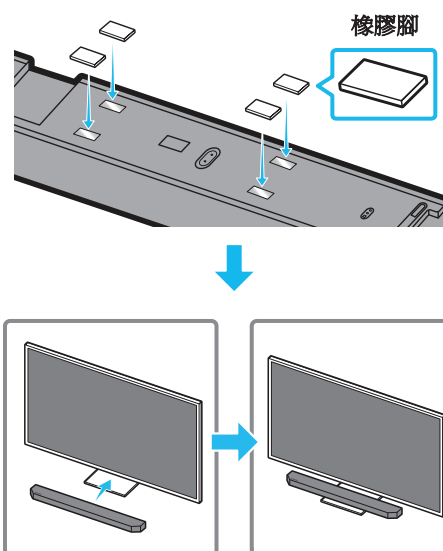

請將 Soundbar 放置在電視架上。

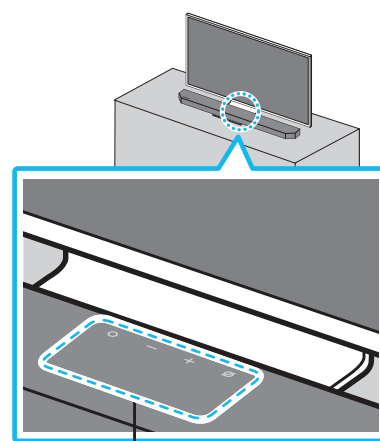

麥克風 (僅限適用型號)

參考圖片所示，把 Soundbar 中心對準電視的中心，然後小心地將有源音箱放置到電視架上。

此時請將麥克風 (只限適用型號) 放置於電視架的前方，以免聲音識別受到干擾。

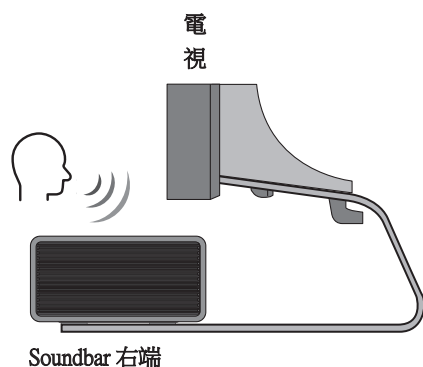

注意

- 確保將 Soundbar 放置於平坦而穩固的平面上。
- 如果與電視距離過近，可能會對聲音識別和音質造成問題。
- 以上圖片會因各個型號而有所不同。
- Q700B 型號不支援此功能。

11 軟件更新

自動更新

Soundbar 連接至互聯網時，即使沒有啟動 Soundbar，軟件亦會自動更新。

- 如需使用自動更新功能，Soundbar 必須連接至互聯網。
如果 Soundbar 的電源線已拔除，或沒有電源，Soundbar 的 Wi-Fi 連接會中斷。如果沒有電源，電源重新開啟時，或您重新連接電源線時，開啟 Soundbar，然後重新連線至互聯網。

USB 更新

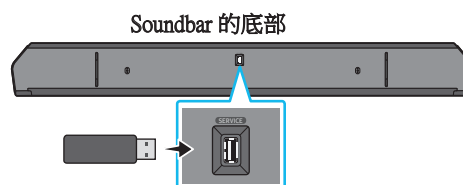

三星可能會日後為 Soundbar 系統固件提供更新。

當有可用的更新，您只需把放有更新韌體的 USB 手指插入至 Soundbar 的 **SERVICE** 連接埠，便可以更新 Soundbar。

1. 前往 Samsung 網站 (www.samsung.com) → 在客戶支援選單選項中搜尋型號。
 - 如需進一步瞭解有關更新事宜，請參閱「升級指南」。
2. 下載升級檔案 (USB 類型)。
3. 解除壓縮檔案，使用其檔案名稱建立資料夾。
4. 將建立的資料夾儲存到 USB，然後將 USB 連接至 Soundbar。
5. 開啟 Soundbar。產品會在 3 分鐘內更新，並會顯示訊息「**UPDATE**」。
 - 更新期間，不要關閉產品或移除 USB。
 - 若視窗沒有顯示「**UPDATE**」，請從 Soundbar 移除電源線，並重新連接。
 - 安裝最新版本後，便無需更新。
 - 更新可能不受支援，視乎 USB 類型而定。

初始化

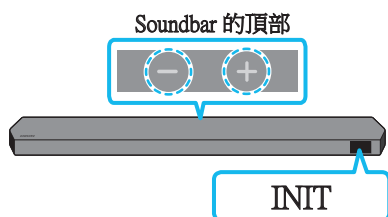

Soundbar 啟動後，同時按下機身的 **- + 音量** 按鈕最少 5 秒。

「INIT」會在顯示屏上出現，而 Soundbar 會初始化。

⚠ 注意

- Soundbar 所有設定均已初始化。請確保只於需要初始化時才執行此程序。

12 故障排除

在尋求幫助前，請檢查以下事項。

Soundbar 無法開啟。

- 檢查 Soundbar 的電源線有否正確插入插座。

Soundbar 運作異常。

- 拔下電源插頭，然後重新連接。
- 重啟外部裝置，然後再試一次。
- 如果沒有訊號，Soundbar 會在一定時間後自動關閉。關閉電源。(請參閱第 9 頁。)

遙控器無法運作

- 直接將遙控器指向 Soundbar。
- 更換新電池。

Soundbar 指示燈保持亮起紅色。

- 麥克風已關閉。
開啟麥克風。(請參閱第 7 頁。)

聲音沒有透過 Soundbar 輸出。

- Soundbar 音量可能太低或開啟了靜音功能。調整音量。
- 如果連接了任何外置裝置 (STB、藍牙裝置、流動裝置等等)，請調整該外置裝置的音量。
- 關於電視的聲音輸出，請選擇 Soundbar。(Samsung 電視：首頁 (🏠) → 功能表 → 設定 (⚙) → 所有設定 (⚙) → 音效 → 音效輸出 → 選擇 Soundbar)
- 連接至 Soundbar 的連接線不得鬆脫。移除連接線並重新連接。
- 完全移除電源線、重新連接，並開啟電源。
- 初始化產品並重試。(請參閱第 35 頁。)

聲音沒有從有源重低音音箱或後置揚聲器輸出。

- 檢查有源重低音音箱和環繞聲揚聲器背面的 LED 指示燈是否已亮起藍燈。如果指示燈閃爍藍燈，或變為亮起紅燈，請重新連接 Soundbar、有源重低音音箱和環繞聲揚聲器。(請參閱第 16 頁。)
- 如果 Soundbar 和低音炮放置了障礙物，可能會發生問題。將裝置移離障礙物。
- 若附近設有傳送無線電頻訊號的裝置，可能會影響連接。請將揚聲器遠離這些裝置。
- 移除和重新連接電源插座。

如果有源重低音音箱和環繞聲揚聲器聲音不穩、延遲或有噪音

- 如果 Soundbar 和有源重低音音箱之間有任何物件，可能會引起這個問題。請將它們重新放置到沒有此類物件的位置。
- 如果有源重低音音箱與環繞聲揚聲器相距 Soundbar 較遠距離，亦可能會出現聲音不穩、延遲或有噪音的情況。請將它們放近 Soundbar。
- 當 Soundbar 靠近樂器或電子裝置時，可能會出現射頻干擾，令聲音不穩或延遲。讓 Soundbar 遠離此類可能會引起射頻干擾的裝置。(例如：無線路由器)
- 將電視網絡的連接狀態由無線改為有線。

低音炮音量過低。

- 您播放內容的原來音量可能過低。嘗試調校低音炮的音量。(請參閱第 10 頁。)
- 將低音炮揚聲器靠近您。

如果電視並非以 HDMI TO TV (eARC/ARC) 連接

- 檢查 HDMI 纜線有否正確連接至 ARC 端子。(請參閱第 18 頁。)
- 可能會因已連接的外置裝置 (機頂盒、遊戲主機等等) 而無法進行連接。直接連接 Soundbar。
- 電視的 HDMI-CEC 可能未啟用。打開電視功能表的 CEC。(Samsung 電視：首頁 (🏠) → 功能表 → 設定 (⚙️) → 所有設定 (⚙️) → 連線 → 外置裝置管理員 → Anynet+ (HDMI-CEC) 開啟)
- 如要使用 eARC 進行連接，電視功能表的 eARC 功能應設為開啟。(Samsung 電視：首頁 (🏠) → 功能表 → 設定 (⚙️) → 所有設定 (⚙️) → 音效 → 專業設定 → HDMI-eARC 模式 (自動))

連接至電視輸入 HDMI TO TV(eARC/ARC) 模式時，裝置不會發出聲音

- 您的裝置無法播放輸入訊號。將電視的音訊輸出變更為 PCM 或 Dolby Digital。(若使用三星電視：首頁 (🏠) → 功能表 → 設定 (⚙️) → 所有設定 (⚙️) → 音效 → 專業設定 → 數位輸出音訊格式)

Soundbar 不會透過 Bluetooth 進行連接。

- 連接新裝置時，切換至「BT PAIRING」，以進行連接。(按下遙控器上的 **PAIR** 按鈕，或按下機身上的 **麥克風開啟/關閉** / **來源** 按鈕至少 5 秒。)
- 如果 Soundbar 連接至其他裝置，請先解除連接裝置，以切換至裝置。
- 從可連接裝置清單移除藍牙揚聲器清單後重新連接。(Samsung 電視：首頁 (🏠) → 功能表 → 設定 (⚙️) → 所有設定 (⚙️) → 音效 → 音效輸出 → 藍牙揚聲器列表)
- 自動電視連接可能已停用。Soundbar 處於「BT READY」時，按住 Soundbar 遙控器上的**左**按鈕 5 秒，以選擇 **ON-TV CONNECT**。如果您看到 **OFF-TV CONNECT**，再次按住**左**按鈕 5 秒以切換選擇。
- 移除和重新連接電源插座，然後重試。
- 初始化產品並重試。(請參閱第 35 頁。)

透過 Bluetooth 連接時沒有聲音。

- 微波爐、無線路由器等裝置距離 Soundbar 過近可能會造成電波干擾。
- 如果透過 Bluetooth 連接的裝置距離 Soundbar 太遠，便可能會沒有聲音。把裝置移近 Soundbar。
- 如果您身體的某部位接觸到 Bluetooth 收發器，或者產品安裝於金屬傢俱上，便可能會沒有聲音。請檢查安裝環境和使用條件。

Soundbar 不會連接至 Wi-Fi。

- 檢查您的無線路由器是否已開啟。
- 關閉並重新開啟路由器，然後重試。
- 如果無線訊號過弱，Soundbar 便有可能無法連接。嘗試將路由器移近 Soundbar，或者盡可能清除 Soundbar 與路由器之間的障礙物。
- 如果您使用全新的無線路由器，便需要重新設定揚聲器的網絡設定。

Soundbar 無法隨著電視自動開啟。

- 看電視時關閉 Soundbar，與電視之間的電源同步便會停止。請先把電視關掉。

以下狀況不可使用 AVA 功能 (只限適用型號)。

- 使用 Q-symphony 功能時將無法使用 AVA 功能 (只限適用型號)。
- 麥克風關閉時，會無法使用 AVA 功能 (只限適用型號)。

在電視連接至 Soundbar 之後，我已切換了 Soundbar 模式。之後就沒有聲音從電視輸出。

- 如果在 Soundbar 連接至電視時將 Soundbar 連接至流動裝置，則 Soundbar 會在保持電視連線時從流動裝置輸出聲音。這樣的話，電視聲音便不會傳送到任何地方。
- 中斷流動裝置的連線，之後電視聲音便會再次從 Soundbar 輸出。

13 許可



Dolby, Dolby Atmos, and the double-D symbol are registered trademarks of Dolby Laboratories Licensing Corporation. Manufactured under license from Dolby Laboratories. Confidential unpublished works. Copyright © 2012-2021 Dolby Laboratories. All rights reserved.



For DTS patents, see <http://patents.dts.com>. Manufactured under license from DTS, Inc. (for companies headquartered in the U.S./Japan/Taiwan) or under license from DTS Licensing Limited (for all other companies). DTS, DTS:X, and the DTS:X logo are registered trademarks or trademarks of DTS, Inc. in the United States and other countries. © 2021 DTS, Inc. ALL RIGHTS RESERVED.



The terms HDMI and HDMI High-Definition Multimedia Interface, and the HDMI Logo are trademarks or registered trademarks of HDMI Licensing Administrator, Inc. in the United States and other countries.



- 使用你的手機、平板電腦或電腦作為 Spotify 遙控器。瀏覽 [spotify.com/connect](https://www.spotify.com/connect) 以了解具體方法
 - Spotify 軟體必須遵守此處提供的第三方授權規定：
<https://www.spotify.com/connect/third-party-licenses>。
-



- Apple, Airplay, iPhone, iPad, and Mac are trademarks of Apple Inc., registered in the U.S. and other countries.
 - Use of the Works with Apple badge means that an accessory has been designed to work specifically with the technology identified in the badge and has been certified by the developer to meet Apple performance standards.
-

14 開源許可聲明

如要提出有關開放源問題的查詢和要求，請聯絡 Samsung Open Source (<http://opensource.samsung.com>)

15 關於服務的重要說明

此使用者手冊的圖像和插圖僅供參考，可能與實際產品外觀有所不同。

16 規格和指南

規格

Soundbar 主設備

型號名稱	HW-Q930B
重量	5.4 kg
尺寸 (寬 x 高 x 深)	1110.7 x 60.4 x 120.0 毫米
工作溫度範圍	+5°C 至 +35°C
工作濕度範圍	10 % ~ 75 %
擴音器 額定輸出功率	(30 W x 3) + (20 W x 6) + (10 W x 3)
支援的播放格式	Dolby 5.1ch / Dolby Digital Plus / Dolby TRUE HD / Dolby ATMOS / DTS 5.1ch / DTS HD / DTS-HD Master Audio / DTS:X / LPCM 8Ch

型號名稱	HW-Q800B
重量	5.1 kg
尺寸 (寬 x 高 x 深)	1110.7 x 60.4 x 120.0 毫米
工作溫度範圍	+5°C 至 +35°C
工作濕度範圍	10 % ~ 75 %
擴音器 額定輸出功率	(30 W x 3) + (20 W x 4) + (10 W x 3)
支援的播放格式	Dolby 5.1ch / Dolby Digital Plus / Dolby TRUE HD / Dolby ATMOS / DTS 5.1ch / DTS HD / DTS-HD Master Audio / DTS:X / LPCM 8Ch

型號名稱	HW-Q700B
重量	4.8 kg
尺寸 (寬 x 高 x 深)	1110.7 x 60.4 x 120.0 毫米
工作溫度範圍	+5°C 至 +35°C
工作濕度範圍	10 % ~ 75 %
擴音器 額定輸出功率	(30 W x 3) + (20 W x 2) + (10 W x 3)
支援的播放格式	Dolby 5.1ch / Dolby Digital Plus / Dolby TRUE HD / Dolby ATMOS / DTS 5.1ch / DTS HD / DTS-HD Master Audio / DTS:X / LPCM 8Ch

低音炮

低音炮名稱	PS-WB96B
重量	9.8 kg
尺寸 (寬 x 高 x 深)	210.0 x 403.0 x 403.0 毫米
擴音器 額定輸出功率	160 W

低音炮名稱	PS-WB75B
重量	5.9 kg
尺寸 (寬 x 高 x 深)	205.0 x 353.0 x 302.0 毫米
擴音器 額定輸出功率	160 W

環繞聲揚聲器 (僅限適用型號)

無線環繞聲揚聲器 SET 名稱	PS-RB96B (左/右)
重量	3.1 kg
尺寸 (寬 x 高 x 深)	129.5 x 201.3 x 140.4 毫米
擴音器 額定輸出功率	140 W

注意

- Samsung Electronics Co., Ltd 保留更改規格的權利，恕不另行通知。
- 重量和尺寸均為約數。

注意事項：如果您開啟/關閉 Wi-Fi，Soundbar 會自動重新啟動。

Wi-Fi 連接埠停用方式	按下 Soundbar 遙控器上的 CH LEVEL 按鈕 30 秒，以開啟/關閉 Wi-Fi。
Bluetooth 連接埠停用方式	按下 Soundbar 遙控器上的 TONE CONTROL 按鈕 30 秒，以開啟/關閉藍牙。

© 2022 Samsung Electronics Co., Ltd. All rights reserved.

Contact SAMSUNG WORLD WIDE

If you have any questions or comments relating to Samsung products, please contact the SAMSUNG customer care Centre.

Country/Area	Samsung Service Centre ☎	Web Site
CHINA	400-810-5858	www.samsung.com/cn/support
TAIWAN	0800-32-9999 (All Product) 0809-05-5237 (Only for HHP) 0809-00-5237 (B2B / Dealer) 0809-02-6868 (Samsung pay)	www.samsung.com/tw/support
HONG KONG	3698 4698 (All Product) 3698 4688 (B2B) 3698 4633 (eStore) 2121 9088 (Samsung pay)	www.samsung.com/hk/support (Chinese) www.samsung.com/hk_en/support (English)
MACAU	0800 333	
SINGAPORE	1800 7267864 1800-SAMSUNG (Other) 1800 4252997 1800-GALAXYS (HHP)	www.samsung.com/sg/support
AUSTRALIA	1300 362 603 (Other) 1300 425 299 (HHP)	www.samsung.com/au/support
NEW ZEALAND	0800 726 786 (All Product) 0800 6 726 786 (Support for Smart Mobile Devices)	www.samsung.com/nz/support
VIETNAM	1800 588 889 (All Product) 1800-588-855 (HHP)	www.samsung.com/vn/support
THAILAND	Hotline no : 1282 1800-29-3232 (Toll free for all product)	www.samsung.com/th/support
MYANMAR	+95-1-2399-888 VIP HHP +95-1-2399-990	www.samsung.com/mm/support
CAMBODIA	1800-20-3232 (Toll free)	www.samsung.com/th/support
LAOS	+856-214-17333	
MALAYSIA	1800-22-8899 (HHP) 1800-88-9999 (OTH) +603-7713 7420 (Overseas contact)	www.samsung.com/my/support
INDONESIA	021-5699-7777 0800-112-8888 (All Product, Toll Free) 0800-112-7777 (All Product, Toll Free)	www.samsung.com/id/support
PHILIPPINES	Dedicated Hotline for Mobile Phones: #GALAXY (just dial #425299) All Products : 1-800-10-7267864 [PLDT - Toll Free] 1-800-8-7267864 [Globe - Toll Free] 84222111 [Landline]	www.samsung.com/ph/support
INDIA	1800 5 SAMSUNG (1800 5 7267864) (Toll-Free) 1800 40 SAMSUNG (1800 40 7267864) (Toll-Free)	www.samsung.com/in/support
NEPAL	16600172667 (Toll Free for NTC Only) 9801572667 (Toll Free for Ncell users)	
SRI LANKA	011 SAMSUNG (011 7267864)	
BANGLADESH	08000-300-300 (Toll free) 09612-300-300	www.samsung.com/bd/support